

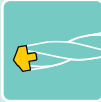





2024-2025
ROTATING
METALCUTTING TOOLS

Contents

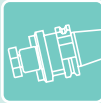
Thread Making		Contents Thread Milling Tapping	C2 C11 C57	C	Thread Making
Holemaking		Contents Drilling Tools Reaming Tools	D2 D17 D111	D	Holemaking
Milling		Contents Cutters Inserts	E2 E43 E246	E	Milling
Solid End Mills		Contents MAXI-RUSH Line Solid End Mill Line	F2 F16 F57	F	Solid End Mills
Tooling System		Contents Tool Adapter Collet and Accessories	G2 G8 G140	G	Tooling System
MPT		Contents Shanks and Heads Spare Parts	H2 H6 H58	H	MPT
Materials & Grades		Grade Comparison Table Hardness Conversion Table Material Conversion Table	I2 I6 I8	I	Materials & Grades
Index					Index

How to use the catalogue page



« Main Contents

Select an application line from the main Table of Contents. Each line is color coded in alphabetical order.



Tool Selection Guide »

Choose the required machining solutions and tools from tool selection guide.



Products Page »

Obtain detailed information of products such as dimensions, grades and related parts etc. Holder and insert pages are organized separately.

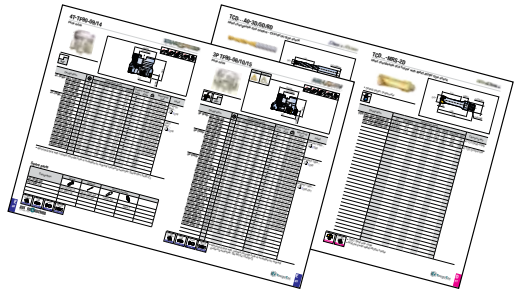

Alphabetical Index »

All tools are listed in the alphabetical index at the end of the catalogue.



Should you require more information and data from TaeguTec, please contact the nearest TaeguTec Global Service Center or visit our website. www.taegutec.com

THREAD MAKING



THREAD MAKING



contents

Tool Selection Guide

TS-THREAD (Thread Milling)	C4
T-TAP (Tapping)	C8
Grades	C10
TS-THREAD (Thread Milling)	
Solid Carbide End Mill Designation System	C12
Solid Carbide End Mills	C13
Tool Designation System	C32
Indexable Tools	C33
Insert Designation System	C40
Inserts	C41
Recommended Cutting Conditions	C53

Guide to Icons



➤ TS-THREAD
Holder Page



➤ Insert Page



➤ Cutting Condition Page



T-TAP (Tapping)

T-TAP Designation System	C58
Straight Flute with Spiral Point	C59
Right Hand Spiral Flute (40°)	C62
Recommended Cutting Conditions	C65

Tool Selection Guide

Solid carbide threading end mills

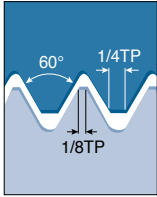
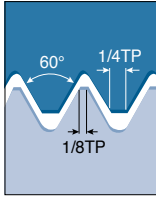
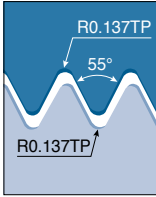
Thread	TS-THREAD		
	Metric ISO	American UN	Whitworth
			
Application	General usage for all industries	General usage for all industries	General industries. Pipe fittings and couplings
MTEC General type	● C15	● C23	● C27
MTECB Internal coolant hole	● C13	● C22	● C27
MTECZ Internal coolant in the flutes	● C14	● C24	● C27
MTECS Short head	● C18-C19	● C25	
MTECSH Short head for hard materials	● C21	● C26	
MTECD Short head with internal coolant hole	● C20		
MTECQ Reduced neck diameter for deep threading	● C16		
MTECI Partial profile	● C31	● C31	
MTEC E External threading	● C17	● C24	

► For correct tool choice and CNC programming, use the 'TS-thread guide' software (Available at www.taegutec.com)

Tool Selection Guide

Solid carbide threading end mills

TS-THREAD

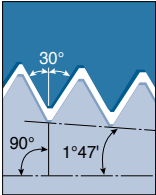
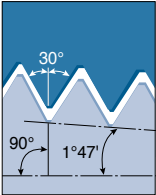
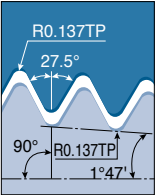
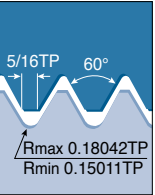
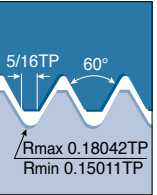
NPT	NPTF	BSPT	UNJ	MJ
				
Steam, gas and water pipes	Steam, gas and water pipes. Dry seal	55° form for steam, gas and water pipes	Aviation and aerospace industry	Aviation and aerospace industry
● C28	● C28	● C29		
● C28		● C29		
	● C28	● C29		
			● C30	● C30

Tool Selection Guide

Indexable insert type

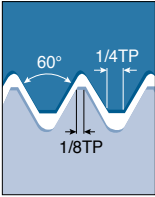
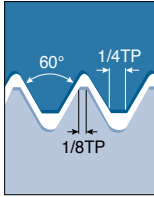
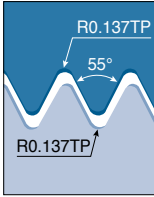
Thread	TS-THREAD		
	Metric ISO	American UN	Whitworth
			
Insert page	C41, C49	C42, C43, C50	C44, C51
Application	General usage for all industries	General usage for all industries	General industries. Pipe fittings and couplings
MTE D C33 Single insert	•	•	•
MTE D-C C34 Solid carbide shank	•	•	•
MTE D-W C35 Twin insert	•	•	•
TMTSRH C36 Helical end mill	•	•	•
MTF D C37 Large diameter thread	•	•	•
MTFLE D C38 Multi tooth-external threading	•	•	•
TMTSRH C39 Helical shell mill	•	•	•

► For correct tool choice and CNC programming, use the 'TS-thread guide' software (Available at www.taegutec.com)

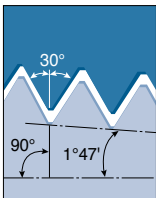
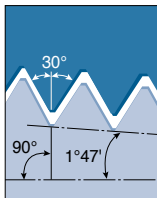
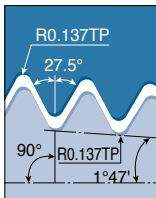
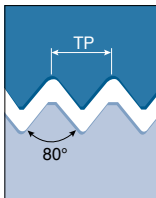

Tool Selection Guide

Indexable insert type

TS-THREAD			
NPT	NPTF	BSPT	PG
			
C45, C51	C46	C47, C52	C48
Steam, gas and water pipes	Steam, gas and water pipes. Dry seal	55° form for steam, gas and water pipes	Electrical connector
•	•	•	•
•	•	•	•
•	•	•	•
•	•	•	•
•	•	•	•
•	•	•	•
•	•	•	•
•	•	•	•

Tool Selection Guide

Straight flute with spiral point tap

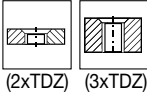
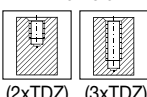
		T-TAP		
		Straight flute with spiral point tap		
Series		TPH...52B	TPH...52B05	TPH...52B10
				
Pages		C59	C60	C61
Coating type		Uncoated	Steam tempered	TiN coated
Chamfer form		Form B 4-5 threads chamfer	Form B 4-5 threads chamfer	Form B 4-5 threads chamfer
Range (ISO metric)	Coarse threads	M2 - M20	M2 - M20	M2 - M20
	Fine threads	M8 - M16	M8 - M16	M8 - M16
Tolerance		ISO 2-6H	ISO 2-6H	ISO 2-6H
Material	P	○	●	●
	M		●	●
	K	○	○	○
	N	●	○	○
	S			○
Application	Through hole  (2xTDZ) (3xTDZ)	●	●	●
	Blind hole  (2xTDZ) (3xTDZ)			

● Recommended, ○ Suitable

Tool Selection Guide

40° right hand spiral flute tap

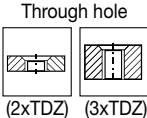
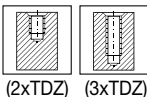
Series		T-TAP		
		40° right hand spiral flute tap		
		TPH...54C	TPH...54C05	TPH...54C10
Pages		C62	C63	C64
Coating type		Uncoated	Steam tempered	TiN coated
Chamfer form		Form C 2-3 threads chamfer	Form C 2-3 threads chamfer	Form C 2-3 threads chamfer
Range (ISO metric)	Coarse threads	M2 - M20	M2 - M20	M2 - M20
	Fine threads	M8 - M16	M8 - M16	M8 - M16
Tolerance		ISO 2-6H	ISO 2-6H	ISO 2-6H
Material	P	○	●	●
	M		●	●
	K	○	○	○
	N	●	○	○
	S			○
Application	Through hole  (2xTDZ) (3xTDZ)			
	Blind hole  (2xTDZ) (3xTDZ)	●	●	●

● Recommended, ○ Suitable

Grades

Thread making grades

Grades	ISO	Characteristics & applications									
TT9030 PVD coated	<table border="1"><tr><td>P20</td><td>—</td><td>P40</td></tr><tr><td>M20</td><td>—</td><td>M40</td></tr><tr><td>S20</td><td>—</td><td>S40</td></tr></table>	P20	—	P40	M20	—	M40	S20	—	S40	<ul style="list-style-type: none">• General machining of steel• General machining of stainless steel• General machining of heat-resistant alloy
P20	—	P40									
M20	—	M40									
S20	—	S40									

TS-THREAD

Thread Milling



MTEC  **06** **04** **C** **14** **1.0** **ISO** **TT9030**

1 **2** **3** **4** **5** **6** **7** **8** **9**

1 TaeguTec mill thread

MT - Mill thread
E - End mill
C - Carbide

2 End mill type

B - Axial coolant bore
Z - Coolant hole in the flutes
S - Short head
SH - Short head for threading hard materials
Q - Reduced diameter neck
I - Partial profile

3 Shank diameter

06 6.0 mm
10 10.0 mm

4 Cutting diameter

031 3.1 mm
04 4.0 mm

5 No. of flutes

C - 3 flutes
D - 4 flutes
E - 5 flutes
F - 6 flutes

6 Length of thread (APMX)

10 10.0 mm

7 Thread pitch

0.25-4.0 mm (Thread pitch)
72-7 TPI (Threads per inch)

8 Thread standard

ISO
UN
W
NPT
NPTF
BSPT
UNJ
MJ

9 Grades

Coated
TT9030
TT1040

MTECB-ISO

Solid carbide threading end mills with internal coolant hole

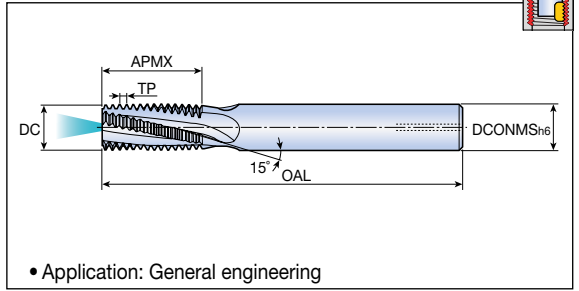
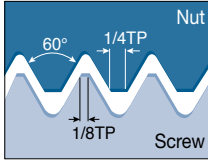

Designation	TP (mm)	M coarse	M fine	Dimension (mm)				NOF	Grade TT9030
				DCONMS	DC	APMX	OAL		
MTECB 06038C10 0.5 ISO	0.5	-	$\varnothing \geq 5$	6	3.8	10.3	58	3	●
06031C7 0.7 ISO	0.7	M4	$\varnothing \geq 5$	6	3.1	7.4	58	3	●
06045C10 0.75 ISO	0.75	-	$\varnothing \geq 6$	6	4.5	10.1	58	3	●
06038C9 0.8 ISO	0.8	M5	$\varnothing \geq 6$	6	3.8	9.2	58	3	●
06046C10 1.0 ISO	1.0	M6	$\varnothing \geq 7$	6	4.6	10.5	58	3	●
06046C14 1.0 ISO	1.0	M6	$\varnothing \geq 7$	6	4.6	14.5	58	3	●
0606C12 1.0 ISO	1.0	-	$\varnothing \geq 9$	6	6.0	12.5	58	3	●
0808D16 1.0 ISO	1.0	-	$\varnothing \geq 10$	8	8.0	16.5	64	4	●
1010D24 1.0 ISO	1.0	-	$\varnothing \geq 12$	10	10.0	24.5	73	4	●
0606C14 1.25 ISO	1.25	M8	$\varnothing \geq 10$	6	6.0	14.4	58	3	●
0606C19 1.25 ISO	1.25	M8	$\varnothing \geq 10$	6	6.0	19.4	58	3	●
08078C17 1.5 ISO	1.5	M10	$\varnothing \geq 12$	8	7.8	17.0	64	3	●
08078C24 1.5 ISO	1.5	M10	$\varnothing \geq 12$	8	7.8	24.8	64	3	●
1010D21 1.5 ISO	1.5	-	$\varnothing \geq 14$	10	10.0	21.8	73	4	●
1212D26 1.5 ISO	1.5	-	$\varnothing \geq 16$	12	12.0	26.3	84	4	●
1616F33 1.5 ISO	1.5	-	$\varnothing \geq 20$	16	16.0	33.8	105	6	●
1009C20 1.75 ISO	1.75	M12	$\varnothing \geq 12$	10	9.0	20.1	73	3	●
1009C28 1.75 ISO	1.75	M12	$\varnothing \geq 12$	10	9.0	28.9	73	3	●
1010C27 2.0 ISO	2.0	M14	$\varnothing \geq 15$	10	10.0	27.0	73	3	●
12118D27 2.0 ISO	2.0	M16	$\varnothing \geq 17$	12	11.8	27.0	84	4	●
12118D39 2.0 ISO	2.0	M16	$\varnothing \geq 17$	12	11.8	39.0	105	4	●
1615E33 2.5 ISO	2.5	M20	$\varnothing \geq 22$	16	15.0	33.8	105	5	●
1615E48 2.5 ISO	2.5	M20	$\varnothing \geq 22$	16	15.0	48.8	105	5	●
2018D58 3.0 ISO	3.0	M24	$\varnothing \geq 25$	20	18.0	58.5	120	4	●



► NOF: Number of flutes

●: Standard items

MTECZ-ISO



Solid carbide with internal coolant in the flutes, for internal threading

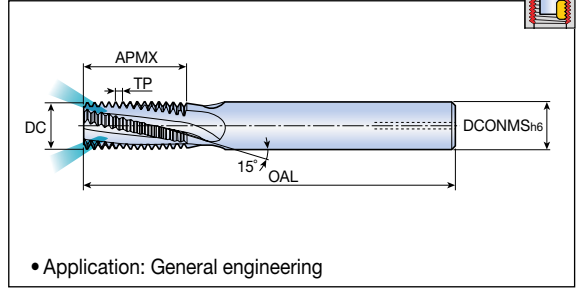
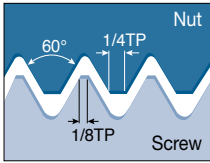

Designation	TP (mm)	M coarse	M fine	Dimension (mm)				NOF	Grade TT9030
				DCONMS	DC	APMX	OAL		
MTECZ 0606C14 1.25 ISO	1.25	M8	$\varnothing \geq 10$	6	6.0	14.4	58	3	●
0606C19 1.25 ISO	1.25	M8	$\varnothing \geq 10$	6	6.0	19.4	58	3	●
0807C17 1.5 ISO	1.5	M10	$\varnothing \geq 12$	8	7.8	17.0	64	3	●
1010D21 1.5 ISO	1.5	-	$\varnothing \geq 14$	10	10.0	21.8	73	4	●
1212D26 1.5 ISO	1.5	-	$\varnothing \geq 16$	12	12.0	26.3	84	4	●
1616E33 1.5 ISO	1.5	-	$\varnothing \geq 20$	16	16.0	33.8	101	5	●
1009C28 1.75 ISO	1.75	M12	$\varnothing \geq 12$	10	9.0	28.9	73	3	●
1010C27 2.0 ISO	2.0	M14	$\varnothing \geq 15$	10	10.0	27.0	73	3	●
12118D27 2.0 ISO	2.0	M16	$\varnothing \geq 17$	12	11.8	27.0	84	4	●



▶ NOF: Number of flutes ●: Standard items

Solid carbide threading end mills for internal threading

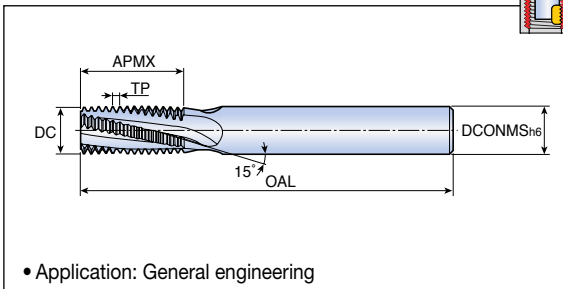
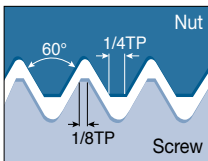

Designation	TP (mm)	M coarse	M fine	Dimension (mm)				NOF	Grade TT9030
				DCONMS	DC	APMX	OAL		
MTEC 06022C5 0.5 ISO	0.5	M3	Ø ≥ 4	6	2.2	5.3	58	3	●
06038C10 0.5 ISO	0.5	-	Ø ≥ 5	6	3.8	10.4	58	3	●
06031C7 0.7 ISO	0.7	M4	Ø ≥ 5	6	3.1	7.4	58	3	●
06045C10 0.75 ISO	0.75	-	Ø ≥ 6	6	4.5	10.1	58	3	●
06036C9 0.8 ISO	0.8	M5	Ø ≥ 6	6	3.6	9.2	58	3	●
0604C10 1.0 ISO	1.0	M6	Ø ≥ 7	6	4.0	10.5	58	3	●
0604C14 1.0 ISO	1.0	M6	Ø ≥ 7	6	4.0	14.5	58	3	●
0606C12 1.0 ISO	1.0	-	Ø ≥ 9	6	6.0	12.5	58	3	●
0808D16 1.0 ISO	1.0	-	Ø ≥ 10	8	8.0	16.5	64	4	●
0605C14 1.25 ISO	1.25	M8	Ø ≥ 10	6	5.0	14.4	58	3	●
0605C19 1.25 ISO	1.25	M8	Ø ≥ 10	6	5.0	19.4	58	3	●
0807C17 1.5 ISO	1.5	M10	Ø ≥ 12	8	7.0	17.3	64	3	●
0807C24 1.5 ISO	1.5	M10	Ø ≥ 12	8	7.0	24.8	76	3	●
1010D21 1.5 ISO	1.5	-	Ø ≥ 14	10	10.0	21.8	73	4	●
1616F33 1.5 ISO	1.5	-	Ø ≥ 20	16	16.0	33.8	105	6	●
0808C20 1.75 ISO	1.75	M12	Ø ≥ 14	8	8.0	20.1	64	3	●
0808C28 1.75 ISO	1.75	M12	Ø ≥ 14	8	8.0	28.9	76	3	●
1010C27 2.0 ISO	2.0	M16	Ø ≥ 17	10	10.0	27.0	73	3	●
1010C39 2.0 ISO	2.0	M16	Ø ≥ 17	10	10.0	39.0	105	3	●
1212D27 2.0 ISO	2.0	-	Ø ≥ 18	12	12.0	27.0	84	4	●
2020F41 2.0 ISO	2.0	-	Ø ≥ 26	20	20.0	41.0	105	6	●
1414D33 2.5 ISO	2.5	M20	Ø ≥ 22	14	14.0	33.8	84	4	●
1414D48 2.5 ISO	2.5	M20	Ø ≥ 22	14	14.0	48.8	105	4	●
1616C40 3.0 ISO	3.0	M24	Ø ≥ 25	16	16.0	40.5	105	3	●
1616C58 3.0 ISO	3.0	M24	Ø ≥ 25	16	16.0	58.5	120	3	●



► NOF: Number of flutes

●: Standard items

MTECQ-ISO



Solid carbide thread end mills with internal coolant holes and a reduced diameter neck for deep internal threading

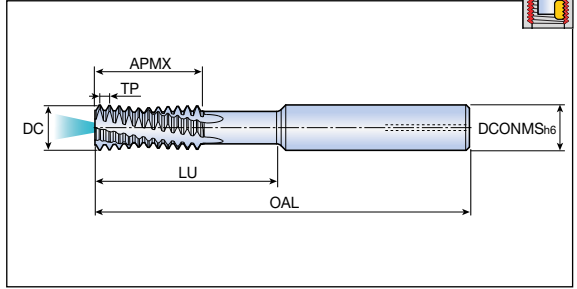
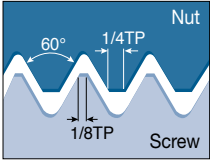

Designation	TP (mm)	TDZ	Dimension (mm)					NOF	Grade TT9030
			DCONMS	DC	APMX	LU	OAL		
MTECQ 1010D32 1.0 ISO	1.0	$\varnothing \geq 12$	10	10.0	18.0	32.0	73	4	●
1212D38 1.0 ISO	1.0	$\varnothing \geq 14$	12	12.0	21.0	38.0	84	4	●
1010D30 1.5 ISO	1.5	$\varnothing \geq 13$	10	10.0	18.0	30.0	73	4	●
2020F56 2.0 ISO	2.0	$\varnothing \geq 24$	20	20.0	34.0	56.0	105	6	●

▶ TDZ: Thread diameter size
 ▶ NOF: Number of flutes

●: Standard items



MTEC E-ISO



Solid carbide end mills for external threading

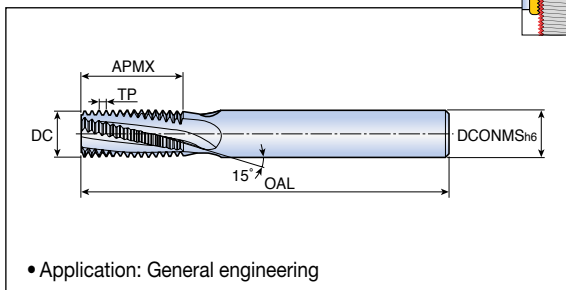
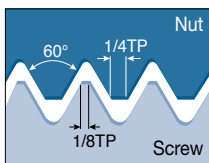

Designation	TP (mm)	Dimension (mm)				NOF	Grade TT9030
		DCONMS	DC	APMX	OAL		
MTEC E 1010D16 1.0 ISO	1.0	10	10.0	16.5	73	4	●
1010D16 1.25 ISO	1.25	10	10.0	16.9	73	4	●
1010D15 1.5 ISO	1.5	10	10.0	15.8	73	4	●
1212D20 1.5 ISO	1.5	12	12.0	20.3	84	4	●
1212D21 2.0 ISO	2.0	12	12.0	21.0	84	4	●



► NOF: Number of flutes

●: Standard items

Short solid carbide end mills for internal threading

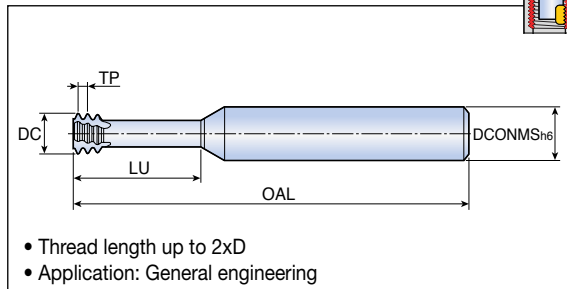
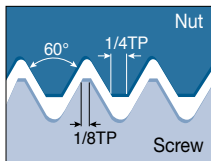

Designation	TP (mm)	TDZ	Dimension (mm)				NOF	Grade TT9030
			DCONMS	DC	LU	OAL		
MTECS 06016C4 0.4 ISO	0.40	M2	6	1.55	4.5	58	3	●
06017C5 0.45 ISO	0.45	M2.2	6	1.65	5.0	58	3	●
0602C5 0.45 ISO	0.45	M2.5	6	1.95	5.5	58	3	●
06024C6 0.5 ISO	0.50	M3	6	2.35	6.5	58	3	●
06028C7 0.6 ISO	0.60	M3.5	6	2.75	7.5	58	3	●
06031C9 0.7 ISO	0.70	M4	6	3.10	9.0	58	3	●
06038C12 0.8 ISO	0.80	M5	6	3.80	12.5	58	3	●
06047C14 1.0 ISO	1.00	M6	6	4.65	14.0	58	3	●
0606C18 1.25 ISO	1.25	M8	6	5.95	18.0	58	3	●
0808D25 0.75 ISO	0.75	M10	8	8.00	25.0	64	4	●
08078C23 1.5 ISO	1.50	M10	8	7.80	23.0	64	3	●
1009C26 1.75 ISO	1.75	M12	10	9.00	26.0	73	3	●
12118D35 2.0 ISO	2.00	M16	12	11.80	35.0	84	4	●
1615E43 2.5 ISO	2.50	M20	16	15.00	43.0	105	5	●

● Standard items

Cutting Condition
 C96
 ▶ TDZ: Thread diameter size
 ▶ NOF: Number of flutes

Short solid carbide end mills for internal threading

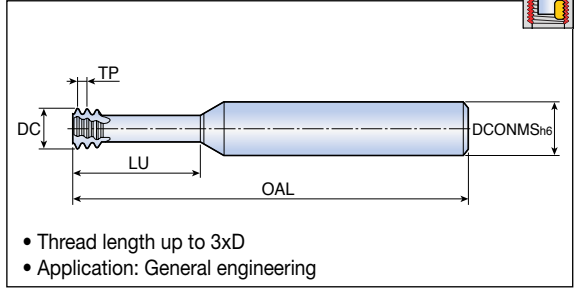
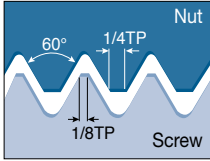

Designation	TP (mm)	TDZ	Dimension (mm)				NOF	Grade TT9030
			DCONMS	DC	LU	OAL		
MTECS 03007C2 0.25 ISO	0.25	M1.0	3	0.72	2.5	39	3	●
03009C3 0.25 ISO	0.25	M1.2	3	0.90	3.0	39	3	●
03011C4 0.3 ISO⁽¹⁾	0.30	M1.4	3	1.05	4.0	39	3	●
03012C5 0.35 ISO⁽¹⁾	0.35	M1.6	3	1.20	5.0	39	3	●
03016C6 0.4 ISO⁽¹⁾	0.40	M2	3	1.55	6.0	39	3	●
0602C7 0.45 ISO	0.45	M2.5	6	1.95	7.5	58	3	●
06024C9 0.5 ISO	0.50	M3	6	2.35	9.5	58	3	●
06028C10 0.6 ISO	0.60	M3.5	6	2.75	10.5	58	3	●
06031C12 0.7 ISO	0.70	M4	6	3.10	12.5	58	3	●
06038C16 0.8 ISO	0.80	M5	6	3.80	16.0	58	3	●
06047C20 1.0 ISO	1.00	M6	6	4.65	20.0	58	3	●
0606C24 1.25 ISO	1.25	M8	6	5.95	24.0	58	3	●



- ▶ TDZ: Thread diameter size
- ▶ NOF: Number of flutes
- ▶ ⁽¹⁾ Specially designed for the production of dental implants

●: Standard items

Short solid carbide end mills for internal drilling, threading and chamfering

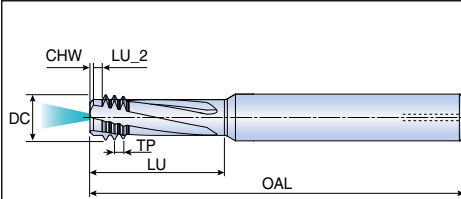
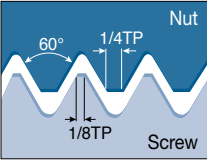

- Left-hand tools (CNC code M04)
- Application: General engineering
- Coolant holes only in 1.0-2.0 pitch tools

Designation	TP (mm)	TDZ	Dimension (mm)								NOF	Grade
			DCONMS	DC	LU	OAL	CHW	LU_2	TT9030			
MTECD 06032C11 0.7 ISO	0.70	M4	6	3.15	11.6	58	0.2	0.7	3	●		
0604C14 0.8 ISO	0.80	M5	6	4.00	14.4	58	0.3	0.8	3	●		
08047C14 1.0 ISO	1.00	M6-M9	8	4.70	14.0	64	0.4	1.0	3	●		
08061D18 1.25 ISO	1.25	M8-M12	8	6.10	18.0	64	0.5	1.3	3	●		
08078D23 1.5 ISO	1.50	M10-M15	8	7.80	23.0	64	0.6	1.5	3	●		
1009D26 1.75 ISO	1.75	M12	10	9.00	26.0	73	0.6	1.8	3	●		
12118D35 2.0 ISO	2.00	M16-M23	12	11.80	35.0	84	0.6	2.0	3	●		



- ▶ Thread hole, thread and chamfer by circular interpolation
- ▶ TDZ: Thread diameter size
- ▶ NOF: Number of flutes

●: Standard items

Short solid carbide end mills for internal threading of hardened steel

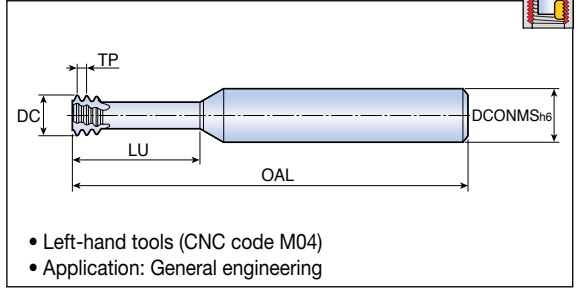
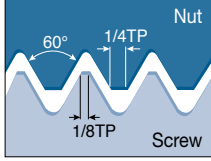

Designation	TP (mm)	TDZ	Dimension (mm)				NOF	Grade TT1040
			DCONMS	DC	LU	OAL		
MTECSH 03011C4 0.3 ISO	0.30	M1.4	3	1.05	4.0	39	3	●
03012C5 0.35 ISO	0.35	M1.6	3	1.20	4.8	39	3	●
03016C6 0.4 ISO	0.40	M2	3	1.55	6.0	58	3	●
06016C4 0.4 ISO	0.40	M2	6	1.55	4.5	58	3	●
06017C5 0.45 ISO	0.45	M2.2	6	1.65	5.0	58	3	●
0602C5 0.45 ISO	0.45	M2.5	6	1.95	5.5	58	3	●
0602C7 0.45 ISO	0.45	M2.5	6	1.95	7.5	58	3	●
06024C6 0.5 ISO	0.50	M3	6	2.35	6.5	58	3	●
06024C9 0.5 ISO	0.50	M3	6	2.35	9.5	58	3	●
06028C7 0.6 ISO	0.60	M3.5	6	2.75	7.5	58	3	●
06031C9 0.7 ISO	0.70	M4	6	3.10	9.0	58	3	●
06031C12 0.7 ISO	0.70	M4	6	3.10	12.5	58	3	●
06038C12 0.8 ISO	0.80	M5	6	3.80	12.5	58	3	●
06038C16 0.8 ISO	0.80	M5	6	3.80	16.0	58	3	●
06047C14 1.0 ISO	1.00	M6	6	4.65	14.0	58	3	●
06047C20 1.0 ISO	1.00	M6	6	4.65	20.0	58	3	●
0606C18 1.25 ISO	1.25	M8	6	5.95	18.0	58	3	●
0606C24 1.25 ISO	1.25	M8	6	5.95	24.0	58	3	●
08078C23 1.5 ISO	1.50	M10	8	7.80	23.0	64	3	●
1009C26 1.75 ISO	1.75	M12	10	9.00	26.0	73	3	●
12118D35 2.0 ISO	2.00	M16	12	11.80	35.0	84	4	●



▶ TDZ: Thread diameter size
▶ NOF: Number of flutes

●: Standard items

Solid carbide end mills for internal threading with internal coolant hole

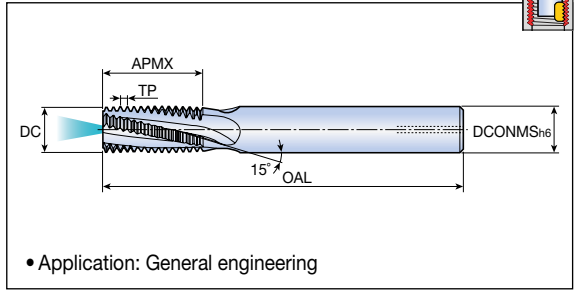
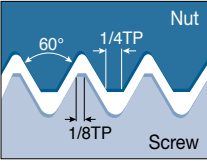

Designation	TPI	UNC	UNF	UNEF	Dimension (mm)				NOF	Grade TT9030
					DCONMS	DC	APMX	OAL		
MTECB 06032C6 32 UN	32	8	10	12	6	3.2	6.8	58	3	●
0605C11 28 UN	28	-	1/4	-	6	5.0	11.3	58	3	●
08066C14 24 UN	24	-	5/16	-	8	6.6	14.3	64	3	●
0808D21 24 UN	24	-	3/8	9/16-5/8	8	8.0	20.6	64	4	●
0808C21 20 UN	20	-	7/16	-	8	8.0	21.0	64	3	●
1010D22 20 UN	20	-	1/2	-	10	10.0	22.3	73	4	●
06056C14 18 UN	18	5/16	-	-	6	5.6	14.8	58	3	●
12113D26 18 UN	18	-	9/16-5/8	11/8-15/8	12	11.3	26.1	84	4	●
08067C16 16 UN	16	3/8	-	-	8	6.7	16.7	64	3	●
10092C22 13 UN	13	1/2	-	-	10	9.2	22.5	73	3	●
12114C28 11 UN	11	5/8	-	-	12	11.4	28.9	84	3	●
16144D34 10 UN	10	3/4	-	-	16	14.4	34.3	105	4	●
20195D42 8 UN	8	1	-	-	20	19.5	42.9	105	4	●



▶ NOF: Number of flutes

●: Standard items

MTEC-UN

Solid carbide threading end mills with internal threading

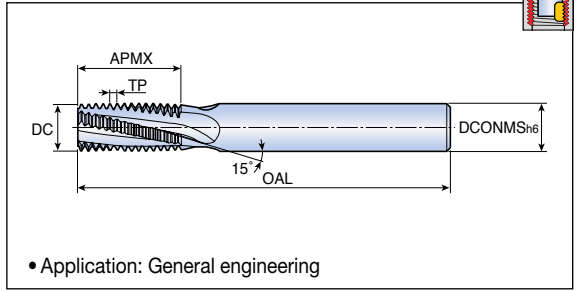

• Application: General engineering

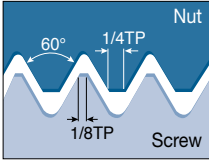

Designation	TPI	UNC	UNF	UNEF	Dimension (mm)				NOF	Grade TT9030
					DCONMS	DC	APMX	OAL		
MTEC 06032C6 32 UN	32	8	10	12	6	3.2	6.8	58	3	●
0604C11 28 UN	28	-	1/4	-	6	4.0	11.3	58	3	●
0605C14 24 UN	24	-	5/16	-	6	5.0	14.8	58	3	●
0807C21 24 UN	24	-	3/8	9/16-5/8	8	7.0	20.0	64	3	●
06045C12 20 UN	20	1/4	-	-	6	4.5	12.1	58	3	●
0807C21 20 UN	20	-	7/16-1/2	-	8	7.0	20.0	64	3	●
1212E27 20 UN	20	-	-	3/4-1	12	12.0	27.3	84	5	●
0605C14 18 UN	18	5/16	-	-	6	5.0	14.8	58	3	●
1010D26 18 UN	18	-	9/16-5/8	11/8-15/8	10	10.0	26.1	73	4	●
0606C16 16 UN	16	3/8	-	-	6	6.0	16.7	58	3	●
1212D31 16 UN	16	-	3/4	-	12	12.0	30.0	84	4	●
1615E37 14 UN	14	-	7/8	-	16	15.0	37.2	105	5	●
0808C22 13 UN	13	1/2	-	-	8	8.0	22.5	64	3	●
1010C26 12 UN	12	9/16	-	-	10	10.0	26.5	73	3	●
1616E41 12 UN	12	-	1-1 1/2	-	16	16.0	41.3	105	5	●
1010C28 11 UN	11	5/8	-	-	10	10.0	28.9	73	3	●
1212C34 10 UN	10	3/4	-	-	12	12.0	34.3	84	3	●
1616C42 8 UN	8	1	-	-	16	16.0	42.9	105	3	●



▶ NOF: Number of flutes

●: Standard items

MTECZ-UN



Solid carbide with internal coolant in the flutes for internal threading

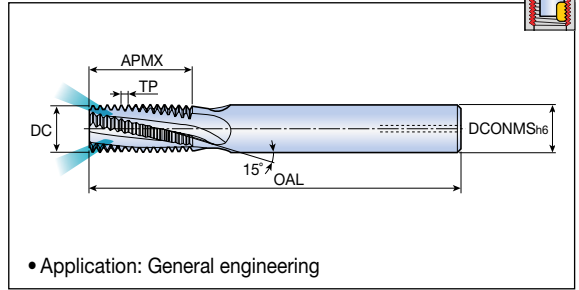
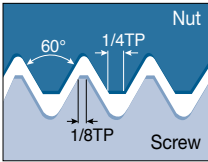

Designation	TPI	UNC	UNF	UNEF	Dimension (mm)				NOF	Grade TT9030
					DCONMS	DC	APMX	OAL		
MTECZ 1010D22 20 UN	20	-	1/2	-	10	10.0	22.3	73	4	●
12113D26 18 UN	18	-	9/16-5/8	11/8-15/8	12	11.3	26.1	84	4	●
08067C16 16 UN	16	3/8	-	-	8	6.7	16.7	64	3	●
10092C22 13 UN	13	1/2	-	-	10	9.2	22.5	73	3	●



▶ NOF: Number of flutes

● Standard items

MTEC E-UN



Solid carbide end mills for external threading

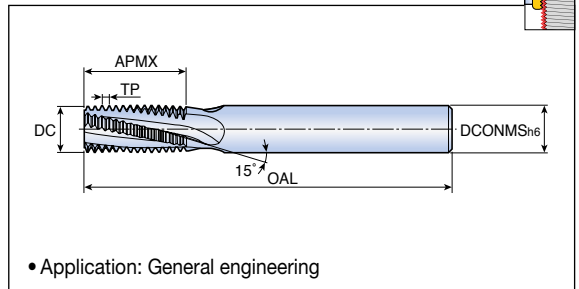
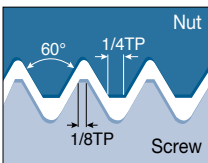

Designation	TPI	Dimension (mm)				NOF	Grade TT9030
		DCONMS	DC	APMX	OAL		
MTEC E 1010D16 24 UN	24	10	10.0	16.4	73	4	●



▶ NOF: Number of flutes

● Standard items

Short solid carbide end mills for internal threading

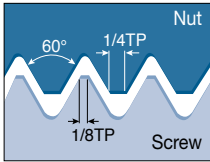
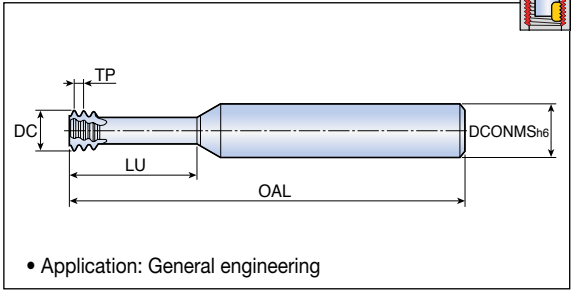

Designation	TPI	UNC	UNF	Dimension (mm)				NOF	Grade TT9030
				DCONMS	DC	LU	OAL		
MTECS 06019C5 48 UN	48	3	4	6	1.90	5.2	58	3	●
06021C6 40 UN	40	4	-	6	2.10	6.3	58	3	●
06033C9 36 UN	36	-	8	6	3.30	9.0	58	3	●
06025C7 32 UN	32	6	-	6	2.55	7.1	58	3	●
06032C9 32 UN	32	8	-	6	3.20	9.5	58	3	●
06037C10 32 UN	32	-	10	6	3.70	10.5	58	3	●
0605C14 28 UN	28	-	1/4	6	5.00	14.5	58	3	●
08066C17 24 UN	24	-	5/16, 3/8	8	6.60	17.0	58	3	●
06047C14 20 UN	20	1/4	-	6	4.75	14.0	58	3	●
0606C17 18 UN	18	5/16	-	6	6.00	17.0	58	3	●
1212D35 18 UN	18	-	5/8	12	12.00	35.0	84	4	●
08067C22 16 UN	16	3/8	-	8	6.70	22.0	64	3	●
10092C27 13 UN	13	1/2	-	10	9.20	27.5	73	3	●
12114C34 11 UN	11	5/8	-	12	11.40	34.5	84	3	●
06032C12 32 UN	32	8	-	6	3.20	12.5	58	3	●
06025C10 32 UN	32	6	-	6	2.55	10.5	58	3	●
0605C19 28 UN	28	-	1/4	6	5.00	19.0	58	3	●
06047C19 20 UN	20	1/4	-	6	4.75	19.0	58	3	●
0606C23 18 UN	18	5/16	-	6	6.00	23.0	58	3	●



► NOF: Number of flutes

●: Standard items

Short solid carbide end mills for internal threading of hardened steel

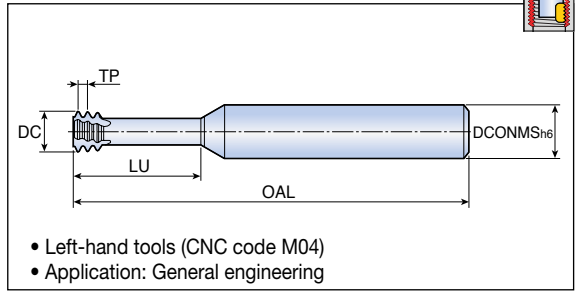
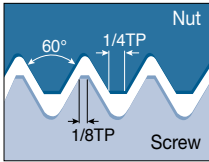

Designation	TPI	UNC	UNF	Dimension (mm)				NOF	Grade
				DCONMS	DC	LU	OAL		TT1040
MTECSH 06019C5 48 UN	48	3	4	6	1.90	5.2	58	3	●
06021C6 40 UN	40	4	-	6	2.10	6.3	58	3	●
06037C10 32 UN	32	-	10	6	3.70	10.5	58	3	●
0605C14 28 UN	28	-	1/4	6	5.00	14.5	58	3	●
06035C10 24 UN	24	10,12	-	6	3.50	10.6	58	3	●
08066C17 24 UN	24	-	5/16	8	6.60	17.0	64	3	●
0808C25 20 UN	20	-	7/16	8	8.00	25.0	64	3	●
08067C22 16 UN	16	3/8	-	8	6.70	22.0	64	3	●
10092C27 13 UN	13	1/2	-	10	9.20	27.5	73	3	●
06037C15 32 UN	32	-	10	6	3.70	15.0	58	3	●
0605C19 28 UN	28	-	1/4	6	5.00	19.0	58	3	●
08066C24 24 UN	24	-	5/16	8	6.60	24.0	64	3	●
06047C19 20 UN	20	1/4	-	6	4.75	19.0	58	3	●
0606C23 18 UN	18	5/16	-	6	6.00	23.0	58	3	●



▶ NOF: Number of flutes

●: Standard items

MTECB-W / MTECZ-W / MTEC-W



Solid carbide threading end mills with internal coolant hole

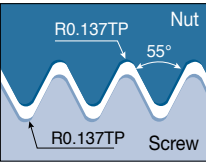
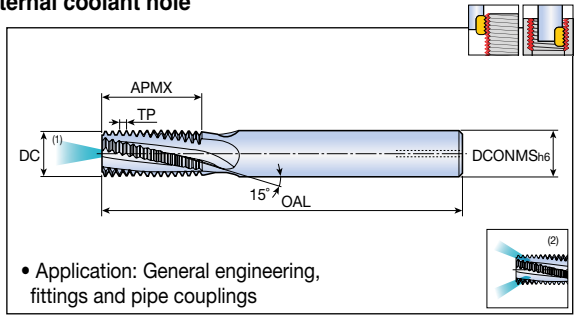

Designation	TPI	TDZ	Dimension (mm)				NOF	Grade	
			DCONMS	DC	APMX	OAL			
MTECB	08078C14 28 W	28	G1/8	8	7.8	14.1	64	3	●
	1010D16 19 W	19	G1/4-3/8	10	10.0	16.7	73	4	●
	1616E26 14 W	14	G1/2-7/8	16	16.0	26.3	105	5	●
	1616D38 11 W	11	G ≥ 1	16	16.0	38.1	105	4	●
	2020E47 11 W	11	G ≥ 1	20	20.0	47.3	105	5	●
MTECZ	08078C14 28 W	28	G1/8	8	7.8	14.1	64	3	●
	1010D16 19 W	19	G1/4-3/8	10	10.0	16.7	73	4	●
	10086D24 12 W	12	-	10	8.6	24.4	73	4	●
	12109D28 11 W	11	-	12	10.9	28.9	84	4	●
	1616D38 11 W	11	G	16	16.0	38.1	101	4	●
	1616E26 14 W	14	G1/2-7/8	16	16.0	26.3	101	5	●
MTEC	0606C9 28 W	28	G1/8	6	6.0	9.5	58	3	●
	0808C14 19 W	19	G1/4-3/8	8	8.0	14.0	64	3	●
	1212D19 14 W	14	G1/2-7/8	12	12.0	19.0	84	4	●
	1212D26 14 W	14	G1/2-7/8	12	12.0	26.3	84	4	●
	1212C24 11 W	11	G1-1 1/2	12	12.0	24.2	84	3	●
	1616D38 11 W	11	G1-3	16	16.0	38.1	105	4	●



- ▶ TDZ: Thread diameter size
- ▶ NOF: Number of flutes
- ▶ ⁽¹⁾ B type ⁽²⁾ Z type

●: Standard items

MTECB-NPT / MTEC-NPT



Solid carbide end mills for internal or external threading

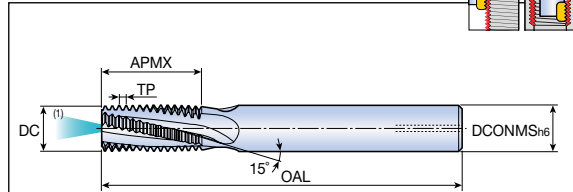
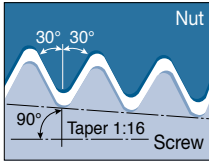

• Application: Steam, gas and water pipes

Designation	TPI	TDZ	Dimension (mm)				NOF	Grade TT9030
			DCONMS	DC	APMX	OAL		
MTECB 08076C10 27 NPT	27	1/8	8	7.6	10.8	64	3	●
1010D16 18 NPT	18	1/4-3/8	10	10.0	16.2	73	4	●
16155D22 14 NPT	14	1/2-3/4	16	15.5	22.7	105	4	●
MTEC 0606C9 27 NPT	27	1/8	6	6.0	9.9	58	3	●
0808C14 18 NPT	18	1/4-3/8	8	8.0	14.8	64	3	●
1212D20 14 NPT	14	1/2-3/4	12	12.0	20.9	84	4	●
1616D27 11.5 NPT	11.5	1-2	16	16.0	27.6	105	4	●



- ▶ TDZ: Thread diameter size
- ▶ NOF: Number of flutes
- ▶ ⁽¹⁾ B type

●: Standard items

MTECZ-NPTF / MTEC-NPTF



Solid carbide end mills for internal or external threading

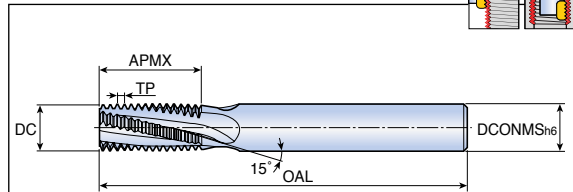
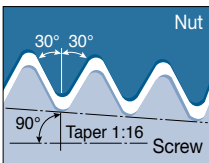

• Application: General engineering, fittings and pipe couplings

Designation	TPI	TDZ	Dimension (mm)				NOF	Grade TT9030
			DCONMS	DC	APMX	OAL		
MTECZ 1010D16 18 NPTF	18	1/4-3/8	10	10.0	16.2	73	4	●
MTEC 0606C9 27 NPTF	27	1/8	6	6.0	9.9	58	3	●
0808C14 18 NPTF	18	1/4-3/8	8	8.0	14.8	64	3	●
1212D20 14 NPTF	14	1/2-3/4	12	12.0	20.9	84	4	●



- ▶ TDZ: Thread diameter size
- ▶ NOF: Number of flutes
- ▶ ⁽¹⁾ Z type

●: Standard items

MTECB-BSPT / MTECZ-BSPT / MTEC-BSPT



Solid carbide end mills for internal or external threading

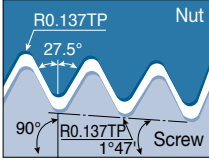
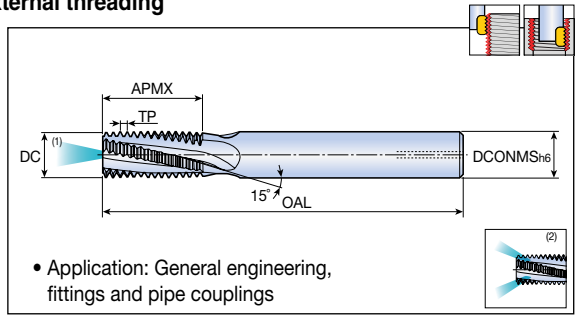

Designation	TPI	TDZ	Dimension (mm)				NOF	Grade TT9030
			DCONMS	DC	APMX	OAL		
MTECB 1010D16 19 BSPT	19	RC1/4-3/8	10	10.0	16.7	73	4	•
1616E26 14 BSPT	14	RC1/2-7/8	16	16.0	26.3	105	4	•
MTECZ 1010D16 19 BSPT	19	RC1/4-3/8	10	10.0	16.7	73	4	•
MTEC 0606C9 28 BSPT	28	RC1/8	6	6.0	9.5	58	3	•
0808C14 19 BSPT	19	RC1/4-3/8	8	8.0	14.0	64	3	•
1212D19 14 BSPT	14	RC1/2-7/8	12	12.0	19.1	84	4	•
1616D28 11 BSPT	11	RC1-2	16	16.0	28.9	105	4	•

Cutting Condition C54-C55

- ▶ TDZ: Thread diameter size
- ▶ NOF: Number of flutes
- ▶ ⁽¹⁾ B type ⁽²⁾ Z type

• Standard items

MTECS-MJ / MTECS-UNJ

Thread mills for internal MJ and UNJ threads with coolant holes directed to the cutting edges

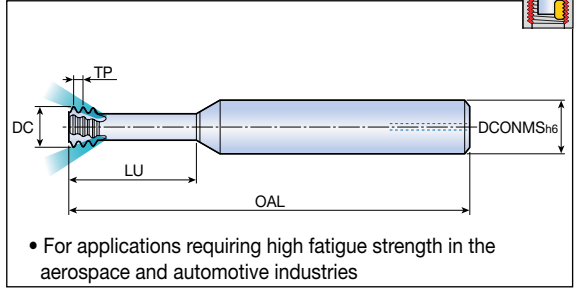
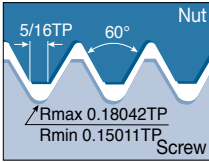

Designation	TP (mm)	TPI	MJ size	UNJC	UNJF	Dimension (mm)				NOF	Grade	
						DCONMS	DC	LU	OAL			
MTECS 06039C12 0.8 MJ⁽¹⁾	0.8	-	MJ5	-	-	6	3.9	12.5	58	3	●	
	06048C15 1.0 MJ⁽¹⁾	1.0	-	MJ6	-	-	6	4.8	15.0	58	3	●
	08061C20 1.25 MJ	1.25	-	MJ8	-	-	8	6.1	20.0	64	3	●
	0808C25 1.5 MJ	1.5	-	MJ10	-	-	8	8.0	25.0	64	3	●
1010C35 2.0 MJ	2.0	-	MJ14, MJ16	-	-	10	10.0	35.0	73	3	●	
MTECS 06033C10 32 UNJ⁽¹⁾	-	32	-	8	10	6	3.3	10.5	58	3	●	
	08051C16 28 UNJ	-	28	-	-	1/4	8	5.1	16.0	64	3	●
	08069C24 16 UNJ	-	16	-	3/8	-	8	6.9	24.0	64	3	●



▶ NOF: Number of flutes
 ▶ ⁽¹⁾ Without coolant holes

●: Standard items

MTECI-60

TS-THREAD

Partial profile solid carbide thread mills with coolant holes directed to the cutting edges for internal and external threads

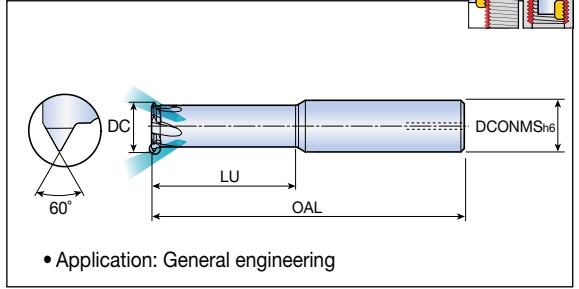
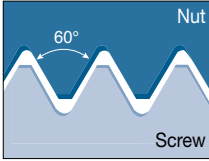
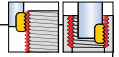

Designation	TP (mm)	TPI	TDZ	Dimension (mm)				NOF	Grade TT9030	
				DCONMS	DC	LU	OAL			
MTECI 0605D20 A60	Int. 0.5-0.8	56-28	$\emptyset \geq 6$	6	5.0	20	58	4	●	
	Ext. 0.4-0.8	64-32								
	0808D30 A60	Int. 1.0-1.75	28-14	$\emptyset \geq 10$	8	8.0	30	64	4	●
			32-16	$\emptyset \geq 12$	10	10.0	35	73	4	●
				$\emptyset \geq 14$	12	12.0	39	84	5	●
	1212E39 A60	Int. 2.3-3.0	23-8	$\emptyset \geq 16$	12	12.0	40	84	5	●
				$\emptyset \geq 18$	16	16.0	45	101	5	●
$\emptyset \geq 20$				16	16.0	50	101	5	●	
1614E45 A60	Ext. 1.75-2.5	15-10								
1616E50 A60										



▶ TDZ: Thread diameter size
▶ NOF: Number of flutes

●: Standard items

End mills

MT E D25 - 1 - W 20 (C) - 21

1 2 3 4 5 6 7 8

1 Mill thread

M - Mill
T - Thread

2 Tool type

E - End mills type

3 Cutting diameter

D25 - 25.0mm

4 Number of insert

1 1 insert
2 2 inserts

5 Shank type

W - Weldon shank
C - Cylindrical type

6 Shank diameter

20 - 20.0mm

7 Shank material

C Carbide shank

8 Insert size (APMX)

12 12.0 mm
14 14.0 mm
21 21.0 mm
30 30.0 mm
40 40.0 mm

Cutters

MT F D063 - 5 - 22 - 21

1 2 3 4 5 6

1 Mill thread

M - Mill
T - Thread

2 Tool type

F - Facemill type

3 Cutting diameter

D063 - 63.0mm

4 Number of insert

4 4 inserts
5 5 inserts

5 Bore diameter

22 22.0 mm
27 27.0 mm
32 32.0 mm

6 Insert size (APMX)

21 21.0 mm
30 30.0 mm
40 40.0 mm

Indexable threading end mills - Weldon shank

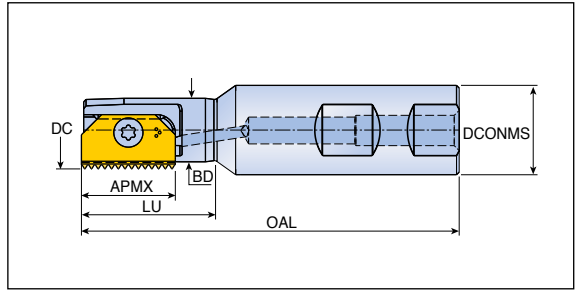

Designation		Dimension (mm)						Shank	Coolant hole	Kg	Insert
		APMX	DC	DCONMS	BD	LU	OAL				
MTE D09.5-1-W20-12 ⁽¹⁾	1	12	9.5	20	7.5	15.5	85	W	●	0.16	TTMT12
D09.9-1-W20-12	1	12	9.9	20	7.5	16.0	85	W	●	0.16	TTMT12
D12.2-1-W20-14	1	14	12.2	20	8.8	20.0	75	W	●	0.15	TTMT14
D14.5-1-W20-14	1	14	14.5	20	10.8	27.1	85	W	●	0.16	TTMT14
D17.0-1-W20-14	1	14	17.0	20	12.8	30.0	85	W	●	0.23	TTMT14
D18-1-W20-21 ⁽²⁾	1	21	18.5	20	14.2	30.0	85	W	●	0.20	TTMT21
D21-1-W20-21	1	21	21.0	20	15.9	40.0	94	W	●	0.23	TTMT21
D25-1-W20-21	1	21	25.0	20	20.0	61.0	115	W	●	0.24	TTMT21
D29-1-W25-30	1	30	29.0	25	22.2	50.0	110	W	●	0.32	TTMT30
D31-1-W25-30	1	30	31.0	25	25.0	90.0	150	W	●	0.60	TTMT30
D38-1-W32-30	1	30	38.0	32	32.0	86.0	150	W	●	0.90	TTMT30
D48-1-W40-40	1	40	48.0	40	35.0	78.0	153	W	●	1.30	TTMT40
D48-1-W40-40-B	1	40	48.0	40	36.5	138.0	210	W	●	1.50	TTMT40

- ▶ Minimum bore should be one-third larger than DC (diameter)
- ▶ All end mills are equipped with a bore for internal coolant
- ▶ ⁽¹⁾ Not suitable for inserts: TTMT12 18 NPT, TTMT12 18 NPTF, TTMT12 19 BSPT
- ▶ ⁽²⁾ Not suitable for inserts: TTMT21 I 3.50 ISO, TTMT21 I 7 UN, TTMT21 11.5 NPT, TTMT21 11.5 NPTF

Spare parts

Designation	Screw	Wrench	Wrench handle	
MTE D...12	SR M2.5-T8-MT	BLD T08/M7	SW4-SD	-
MTE D...14	S11	BLD T08/M7	SW4-SD	-
MTE D...21	SR M4-IP15-MT	BLD IP15/S7	SW6-SD	-
MTE D...30/40(-B)	SR M5-IP25-MT	BLD IP25/S7	-	SW6-T

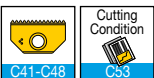

Indexable threading end mills - Cylindrical carbide shank

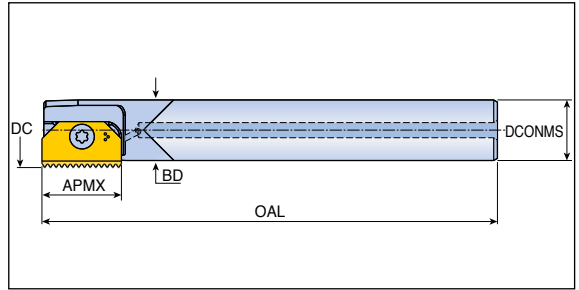

Designation		Dimension (mm)					Shank	Coolant hole		Insert
		APMX	DC	DCONMS	BD	OAL				
MTE D09.9-1-C08C-12	1	12	9.9	8	8	127.0	C	●	0.10	TTMT12
D13.7-1-C10C-14	1	14	13.7	10	10	110.0	C	●	0.12	TTMT14
D13.7-1-C10C-14-B	1	14	13.7	10	10	153.5	C	●	0.17	TTMT14
D15.2-1-C12C-14	1	14	15.2	12	12	182.3	C	●	0.30	TTMT14
D21-1-C16C-21	1	21	21.0	16	16	130.0	C	●	0.35	TTMT21
D21-1-C16C-21-B	1	21	21.0	16	16	206.3	C	●	0.50	TTMT21
D27-1-C20C-30	1	30	27.0	20	20	263.0	C	●	1.20	TTMT30

► For holders with long overhang, reduce the cutting speed and feed rate, between 20 to 40% (depending on workpiece, material, pitch and overhang)

Spare parts

Designation	Screw	Wrench	Wrench handle	
MTE D...C...12	SR M2.5-T8-MT	BLD T08/M7	SW4-SD	-
MTE D...C...14(-B)	S11	BLD T08/M7	SW4-SD	-
MTE D...C...21(-B)	SR M4-IP15-MT	BLD IP15/S7	SW6-SD	-
MTE D...C...30	SR M5-IP25-MT-S	BLD IP25/S7	-	SW6-T

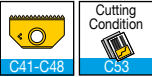

MTE D-2

Double insert thread milling end mills - Weldon shank

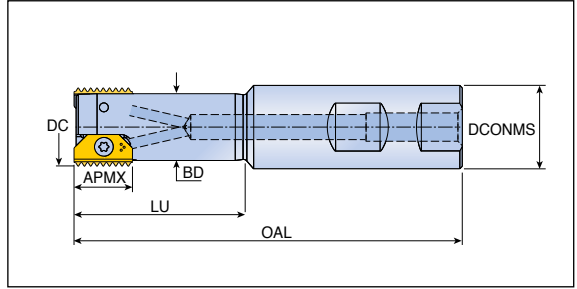

Designation		Dimension (mm)						Shank	Coolant hole		Insert
		APMX	DC	DCONMS	BD	LU	OAL				
MTE D20.0-2-W20-14	2	14	20	20	16	41	93	W	●	0.20	TTMT14
D30-2-W25-21	2	21	30	25	24	52	108	W	●	0.40	TTMT21
D40-2-W32-30	2	30	40	32	30	70	130	W	●	0.70	TTMT30
D50-2-W40-40	2	40	50	40	38	78	153	W	●	0.80	TTMT40

- ▶ Minimum bore should be one-third larger than DC (diameter)
- ▶ All end mills are equipped with a bore for internal coolant

Spare parts

Designation	Screw	Wrench	Wrench handle	
MTE D...W...14	S11	BLD T08/M7	SW4-SD	-
MTE D...W...21	SR M4-IP15-MT	BLD IP15/S7	SW6-SD	-
MTE D...W...30/40	SR M5-IP25-MT	BLD IP25/S7	-	SW6-T

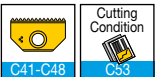

End mills with coolant holes for helical threading inserts - Weldon shank

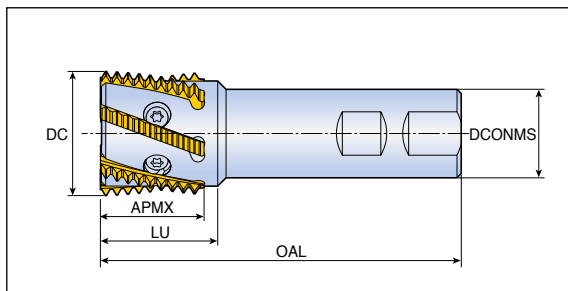

Designation		Dimension (mm)					Shank	Coolant hole	Kg	Insert
		APMX	DC	DCONMS	LU	OAL				
TMTSRH 23-2-N		27	23	25	50	110	W	●	0.30	TMTH 23
32-5-N		32	32	32	60	130	W	●	0.65	TMTH 32
45-6-N		37	45	32	41	130	W	●	0.88	TMTH 45

▶ All end mills are equipped with a bore for internal coolant

Spare parts

Designation	Screw	Wrench		
TMTSRH 23	TS23	TK21		
TMTSRH 32	TS32	TK22		
TMTSRH 45	TS45	TK40		

	Cutting Condition
C49-C52	

MTF D

Multi-insert shell mills for large diameter threading

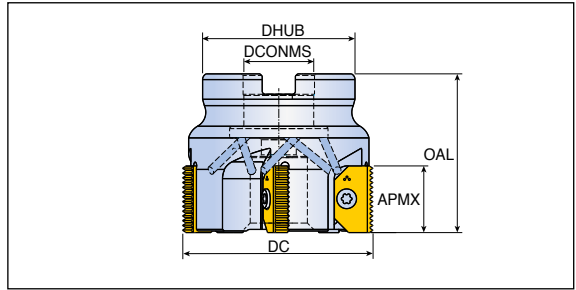

Designation		Dimension (mm)					Coolant hole	Arbor style		Mounting bolt	Insert
		APMX	DC	DHUB	DCONMS	OAL					
MTF D063-5-22-21	5	21	63	40	22	50	●	A	0.70	SR M10X25 DIN912	TTMT21
D063-4-22-30	4	30	63	48	22	50	●	A	0.60	SR M10X25 DIN912	TTMT30
D080-4-27-30	4	30	80	60	27	50	●	A	1.22	SR M12X25	TTMT30
D080-4-27-40	4	40	80	60	27	65	●	A	1.22	SR M12X25	TTMT30
D100-4-32-30	4	30	100	78	32	50	●	A	1.29	SR M16X30 DIN912	TTMT40
D100-4-32-40	4	40	100	78	32	65	●	A	1.22	SR M16X30 DIN912	TTMT40

► All shell mills are equipped with a bore for internal coolant

Spare parts

Designation	Screw	Wrench	Wrench handle	
MTF D063...21	SR M4-IP15-MT	BLD IP15/S7	SW6-SD	-
MTF D063...30	SR M5-IP25-MT	BLD IP25/S7	-	SW6-T
MTF D080...30/40	SR M5-IP25-MT	BLD IP25/S7	-	SW6-T
MTF D100...30/40	SR M5-IP25-MT	BLD IP25/S7	-	SW6-T

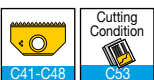

External multi-tooth threading shell mills

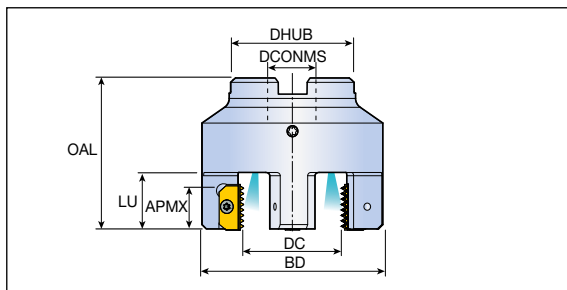

Designation		Dimension (mm)							Coolant hole	Arbor style		Mounting bolt	Insert
		APMX	DC	BD	DHUB	DCONMS	LU	OAL					
MTFLE D20-3-22-21	3	21	20	58.2	48	22	27	63	●	A	0.70	SR M10X25 DIN912	TTMT21 E
D30-3-22-21	3	21	30	68.2	48	22	27	63	●	A	0.90	SR M10X25 DIN912	TTMT21 E
D45-4-27-21	4	21	45	83.2	60	27	27	67	●	A	1.40	SR M12X25 DIN 912	TTMT21 E

► All shell mills are equipped with a bore for internal coolant

Spare parts

Designation	Screw	Wrench	Wrench handle	
MTFLE D...21	SR M4-IP15-MT	BLD IP15/S7	SW6-SD	

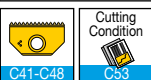

TMTSRH

Helical shell mill for large thread diameters

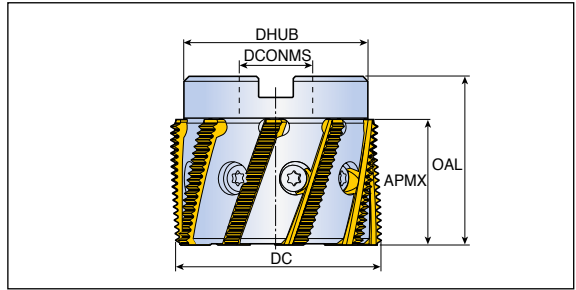

Designation		Dimension (mm)					Coolant hole	Arbor style		Insert
		APMX	DC	DHUB	DCONMS	OAL				
TMTSRH 32-5M-N	5	32	32	26.0	16	52	●	A	0.12	TMTH 32
45-6M-N	6	37	45	38.0	22	60	●	A	0.43	TMTH 45
63-9-N	9	38	63	51.7	22	50	●	A	0.71	TMTH 63

► All shell mills are equipped with a bore for internal coolant

Spare parts

Designation	Screw	Wrench		
TMTSRH 32	TS32S	TK22		
TMTSRH 45	SR M5X0.8-MTH45	TK40		
TMTSRH 63	SR M5X0.8-MTH63	TK40		

C49-C52 Cutting Condition C53

TTMT(H) 30 E 1.5 ISO TT9030

1

2

3

4

5

6

1 TaeguTec mill thread

TT - TaeguTec
M - Mill
T - Thread
H - Helical insert

2 Insert size (INSL)

12 12.0 mm
14 14.0 mm
21 21.0 mm
30 30.0 mm
40 40.0 mm



3 Application

E - External
I - Internal
□ - External + internal

4 Thread pitch

0.5 - 6.0 mm (Thread pitch)
32 - 4 TPI (Threads per inch)

5 Thread standard

ISO
UN
WHIT
NPT
NPTF
BSPT

6 Grades

Coated
TT9030

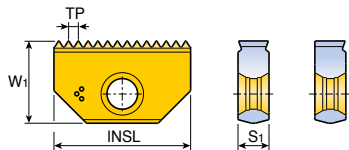

TTMT12 I ⁽¹⁾

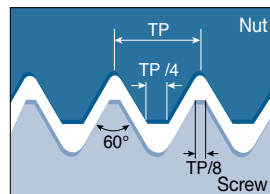

Insert	Designation	TP (mm)	Dimension (mm)			Grade
			INSL	W1	S1	
	TTMT12 I 0.5 ISO⁽¹⁾	0.50	12	6.5	2.9	●
	TTMT12 I 0.75 ISO⁽¹⁾	0.75	12	6.5	2.9	●
	TTMT12 I 1.0 ISO⁽¹⁾	1.00	12	6.5	2.9	●
	TTMT12 I 1.25 ISO⁽¹⁾	1.25	12	6.5	2.9	●
	TTMT12 I 1.5 ISO⁽¹⁾	1.50	12	6.5	2.9	●
	TTMT14 I 0.5 ISO	0.50	14	7.9	3.2	●
	TTMT14 E/I 0.75 ISO	0.75	14	7.9	3.2	●
	TTMT14 E/I 1.0 ISO	1.00	14	7.9	3.2	●
	TTMT14 E/I 1.25 ISO	1.25	14	7.9	3.2	●
	TTMT14 E/I 1.5 ISO	1.50	14	7.9	3.2	●
	TTMT14 E/I 1.75 ISO	1.75	14	7.9	3.2	●
	TTMT14 E/I 2.0 ISO	2.00	14	7.9	3.2	●
	TTMT14 E/I 2.5 ISO	2.50	14	7.9	3.2	●
	TTMT21 E/I 1.0 ISO	1.00	21	12.6	4.8	●
	TTMT21 E/I 1.5 ISO	1.50	21	12.6	4.8	●
	TTMT21 I 1.75 ISO	1.75	21	12.6	4.8	●
	TTMT21 E/I 2.0 ISO	2.00	21	12.6	4.8	●
	TTMT21 E/I 2.5 ISO	2.50	21	12.6	4.8	●
	TTMT21 E/I 3.0 ISO	3.00	21	12.6	4.8	●
	TTMT21 I 3.5 ISO	3.50	21	12.6	4.8	●
	TTMT30 E/I 1.5 ISO	1.50	30	16.7	5.6	●
	TTMT30 E/I 2.0 ISO	2.00	30	16.7	5.6	●
	TTMT30 E/I 3.0 ISO	3.00	30	16.7	5.6	●
	TTMT30 E/I 3.5 ISO	3.50	30	16.7	5.6	●
	TTMT30 E/I 4.0 ISO	4.00	30	16.7	5.6	●
	TTMT30 I 4.5 ISO	4.50	30	16.7	5.6	●
	TTMT30 I 5.0 ISO	5.00	30	16.7	5.6	●
	TTMT40 E/I 1.5 ISO	1.50	40	20.8	6.4	●
TTMT40 E/I 2.0 ISO	2.00	40	20.8	6.4	●	
TTMT40 E/I 3.0 ISO	3.00	40	20.8	6.4	●	
TTMT40 I 3.5 ISO	3.50	40	20.8	6.4	●	
TTMT40 E/I 4.0 ISO	4.00	40	20.8	6.4	●	
TTMT40 I 4.5 ISO	4.50	40	20.8	6.4	●	
TTMT40 E/I 5.0 ISO	5.00	40	20.8	6.4	●	
TTMT40 I 5.5 ISO	5.50	40	20.8	6.4	●	
TTMT40 E/I 6.0 ISO	6.00	40	20.8	6.4	●	



⁽¹⁾ TTMT12 insert is only available with a single cutting edge

●: Standard items

UN, UNC, UNF, UNEF, UNS

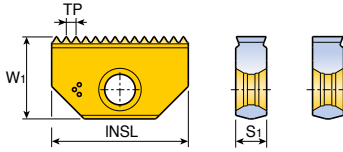

TTMT12 I ⁽¹⁾

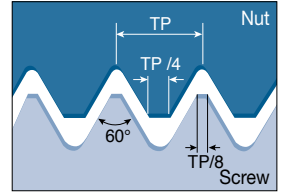

Insert	Designation	TPI	Dimension (mm)			Grade
			INSL	W1	S1	
	TTMT12 I 32 UN ⁽¹⁾	32	12	6.5	2.9	●
	TTMT12 I 28 UN ⁽¹⁾	28	12	6.5	2.9	●
	TTMT12 I 24 UN ⁽¹⁾	24	12	6.5	2.9	●
	TTMT12 I 20 UN ⁽¹⁾	20	12	6.5	2.9	●
	TTMT12 I 18 UN ⁽¹⁾	18	12	6.5	2.9	●
	TTMT12 I 16 UN ⁽¹⁾	16	12	6.5	2.9	●
	TTMT14 E/I 32 UN	32	14	7.9	3.2	●
	TTMT14 E/I 28 UN	28	14	7.9	3.2	●
	TTMT14 I 27 UN	27	14	7.9	3.2	●
	TTMT14 E/I 24 UN	24	14	7.9	3.2	●
	TTMT14 E/I 20 UN	20	14	7.9	3.2	●
	TTMT14 E/I 18 UN	18	14	7.9	3.2	●
	TTMT14 E/I 16 UN	16	14	7.9	3.2	●
	TTMT14 E/I 14 UN	14	14	7.9	3.2	●
	TTMT14 E/I 12 UN	12	14	7.9	3.2	●
	TTMT14 I 11 UN	11	14	7.9	3.2	●
	TTMT14 I 10 UN	10	14	7.9	3.2	●
	TTMT21 E/I 24 UN	24	21	12.6	4.8	●
	TTMT21 E/I 20 UN	20	21	12.6	4.8	●
	TTMT21 E/I 18 UN	18	21	12.6	4.8	●
	TTMT21 E/I 16 UN	16	21	12.6	4.8	●
	TTMT21 E/I 14 UN	14	21	12.6	4.8	●
	TTMT21 E/I 12 UN	12	21	12.6	4.8	●
	TTMT21 E/I 10 UN	10	21	12.6	4.8	●
	TTMT21 I 8 UN	8	21	12.6	4.8	●
	TTMT21 I 7 UN	7	21	12.6	4.8	●
	TTMT30 E/I 20 UN	20	30	16.7	5.6	●
	TTMT30 E/I 18 UN	18	30	16.7	5.6	●
	TTMT30 E/I 16 UN	16	30	16.7	5.6	●
	TTMT30 E/I 14 UN	14	30	16.7	5.6	●
	TTMT30 E/I 12 UN	12	30	16.7	5.6	●
	TTMT30 E/I 10 UN	10	30	16.7	5.6	●
	TTMT30 E/I 8 UN	8	30	16.7	5.6	●
TTMT30 E/I 6 UN	6	30	16.7	5.6	●	
TTMT30 I 5 UN	5	30	16.7	5.6	●	



⁽¹⁾ TTMT12 insert is only available with a single cutting edge

● Standard items

TTMT-UN

UN, UNC, UNF, UNEF, UNS

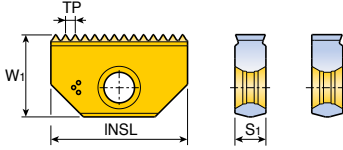

TTMT12 I ⁽¹⁾

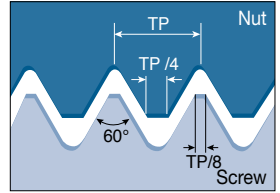

Insert	Designation	TPI	Dimension (mm)			Grade
			INSL	W1	S1	
	TTMT40 E/I 16 UN	16	40	20.8	6.4	●
	TTMT40 E/I 14 UN	14	40	20.8	6.4	●
	TTMT40 E/I 12 UN	12	40	20.8	6.4	●
	TTMT40 E/I 10 UN	10	40	20.8	6.4	●
	TTMT40 E/I 8 UN	8	40	20.8	6.4	●
	TTMT40 E/I 6 UN	6	40	20.8	6.4	●
	TTMT40 I 4.5 UN	4.5	40	20.8	6.4	●
	TTMT40 I 4 UN	4	40	20.8	6.4	●

MTE/F ▶ ⁽¹⁾ TTMT12 insert is only available with a single cutting edge

●: Standard items

Whitworth (BSW, BSF, BSP)

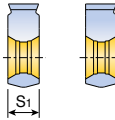
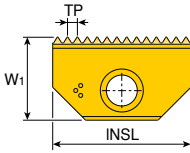

TTMT12 ⁽¹⁾

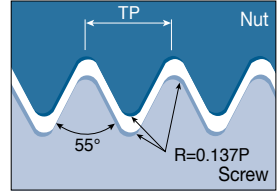



Insert	Designation	TPI	Dimension (mm)			Grade
			INSL	W1	S1	TT9030
	TTMT12 19 W ⁽¹⁾	19	12	6.5	2.9	●
	TTMT14 24 W	24	14	7.9	3.2	●
	TTMT14 20 W	20	14	7.9	3.2	●
	TTMT14 19 W	19	14	7.9	3.2	●
	TTMT14 16 W	16	14	7.9	3.2	●
	TTMT14 14 W	14	14	7.9	3.2	●
	TTMT21 20 W	20	21	12.6	4.8	●
	TTMT21 19 W	19	21	12.6	4.8	●
	TTMT21 16 W	16	21	12.6	4.8	●
	TTMT21 14 W	14	21	12.6	4.8	●
	TTMT21 11 W	11	21	12.6	4.8	●
	TTMT30 16 W	16	30	16.7	5.6	●
	TTMT30 14 W	14	30	16.7	5.6	●
	TTMT30 11 W	11	30	16.7	5.6	●
	TTMT40 11 W	11	40	20.8	6.4	●
TTMT40 8 W	8	40	20.8	6.4	●	

MTE/F ▶ The same insert for external and internal threading ●: Standard items
⁽¹⁾ TTMT12 insert is only available with a single cutting edge

TTMT-NPT

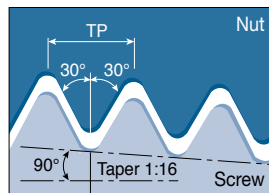
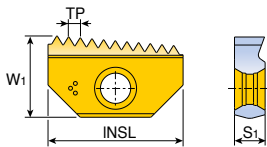
NPT - National pipe taper thread



Insert	Designation	TPI	Dimension (mm)			Grade
			INSL	W1	S1	
	TTMT12 18 NPT	18	12	6.5	2.9	●
	TTMT14 18 NPT	18	14	7.9	3.2	●
	TTMT14 14 NPT	14	14	7.9	3.2	●
	TTMT21 14 NPT	14	21	12.6	4.8	●
	TTMT21 11.5 NPT	11.5	21	12.6	4.8	●
	TTMT30 11.5 NPT	11.5	30	16.7	5.6	●
	TTMT30 8 NPT	8	30	16.7	5.6	●
	TTMT40 11.5 NPT	11.5	40	20.8	6.4	●
	TTMT40 8 NPT	8	40	20.8	6.4	●

MTE/F  C33-C38

- ▶ The same insert for external and internal threading
- ▶ Conical pipe thread inserts are single-sided

●: Standard items

TTMT-NPTF



NPTF - National pipe thread tapered (Dryseal)

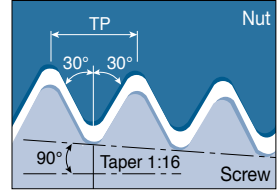
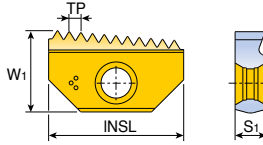

Insert	Designation	TPI	Dimension (mm)			Grade
			INSL	W1	S1	
	TTMT12 18 NPTF	18	12	6.5	2.9	●
	TTMT14 18 NPTF	18	14	7.9	3.2	●
	TTMT14 14 NPTF	14	14	7.9	3.2	●
	TTMT21 14 NPTF	14	21	12.6	4.8	●
	TTMT21 11.5 NPTF	11.5	21	12.6	4.8	●
	TTMT30 11.5 NPTF	11.5	30	16.7	5.6	●
	TTMT30 8 NPTF	8	30	16.7	5.6	●
	TTMT40 11.5 NPTF	11.5	40	20.8	6.4	●
	TTMT40 8 NPTF	8	40	20.8	6.4	●

MTE/F ▶ The same insert for external and internal threading
 ▶ Conical pipe thread Inserts are single-sided

●: Standard items

C33-C38

TTMT-BSPT



BSPT - British standard pipe tapered

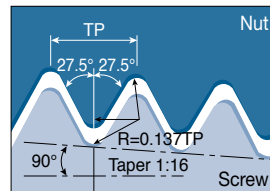
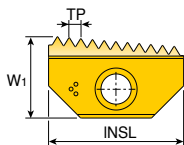

Insert	Designation	TPI	Dimension (mm)			Grade
			INSL	W ₁	S ₁	
	TTMT12 19 BSPT	19	12	6.5	2.9	●
	TTMT14 19 BSPT	19	14	7.9	3.2	●
	TTMT14 14 BSPT	14	14	7.9	3.2	●
	TTMT21 14 BSPT	14	21	12.6	4.8	●
	TTMT21 11 BSPT	11	21	12.6	4.8	●
	TTMT30 11 BSPT	11	30	16.7	5.6	●
	TTMT40 11 BSPT	11	40	20.8	6.4	●

MTE/F 
 ▶ The same insert for external and internal threading
 ▶ Conical pipe thread inserts are single-sided

●: Standard items

Helical inserts for ISO metric threads (Internal)

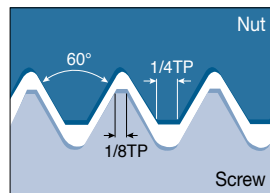
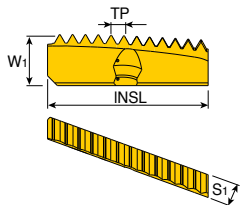

Insert	Designation	TP (mm)	THID	Dimension (mm)			Tool	Grade TT9030
				INSL	W1	S1		
	TMTH 23 I 1.0 ISO	1.0	≥M26	27	8.0	3.5	TMTSRH 23-2	●
	TMTH 23 I 1.5 ISO	1.5	≥M27	27	8.0	3.5	TMTSRH 23-2	●
	TMTH 23 I 2.0 ISO	2.0	≥M28	27	8.0	3.5	TMTSRH 23-2	●
	TMTH 23 I 3.0 ISO	3.0	≥M30	27	8.0	3.5	TMTSRH 23-2	●
	TMTH 32 I 1.0 ISO	1.0	≥M34	32	9.0	4.0	TMTSRH 32-5	●
	TMTH 32 I 1.5 ISO	1.5	≥M35	32	9.0	4.0	TMTSRH 32-5	●
	TMTH 32 I 2.0 ISO	2.0	≥M36	32	9.0	4.0	TMTSRH 32-5	●
	TMTH 32 I 3.0 ISO	3.0	≥M38	32	9.0	4.0	TMTSRH 32-5	●
	TMTH 32 I 4.0 ISO	4.0	≥M40	32	9.0	4.0	TMTSRH 32-5	●
	TMTH 45 I 1.5 ISO	1.5	≥M50	37	11.9	5.0	TMTSRH 45-6	●
	TMTH 45 I 2.0 ISO	2.0	≥M50	37	11.9	5.0	TMTSRH 45-6	●
	TMTH 45 I 3.0 ISO	3.0	≥M56	37	11.9	5.0	TMTSRH 45-6	●
	TMTH 45 I 4.0 ISO	4.0	≥M56	37	11.9	5.0	TMTSRH 45-6	●
	TMTH 63 I 1.5 ISO	1.5	≥M70	38	11.9	5.0	TMTSRH 63-9	●
	TMTH 63 I 2.0 ISO	2.0	≥M70	38	11.9	5.0	TMTSRH 63-9	●
	TMTH 63 I 3.0 ISO	3.0	≥M75	38	11.9	5.0	TMTSRH 63-9	●
TMTH 63 I 4.0 ISO	4.0	≥M75	38	11.9	5.0	TMTSRH 63-9	●	
TMTH 63 I 6.0 ISO	6.0	≥M78	38	11.9	5.0	TMTSRH 63-9	●	



TMTSRH ▶ THID: Thread designation inside ●: Standard items

Helical inserts for UN, UNC, UNF, UNEF, UNS threads (Internal)

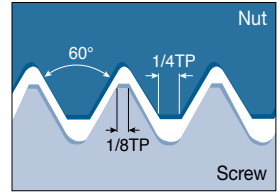
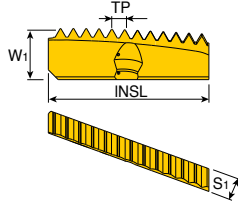

Insert	Designation	TPI	THID	Dimension (mm)			Tool	Grade
				INSL	W1	S1		
	TMTH 23 I 24 UN	24	≥1"	27	8.0	3.5	TMTSRH 23-2	●
	TMTH 23 I 20 UN	20	≥1"	27	8.0	3.5	TMTSRH 23-2	●
	TMTH 23 I 18 UN	18	≥1 1/16"	27	8.0	3.5	TMTSRH 23-2	●
	TMTH 23 I 16 UN	16	≥1 1/16"	27	8.0	3.5	TMTSRH 23-2	●
	TMTH 23 I 14 UN	14	≥1 1/8"	27	8.0	3.5	TMTSRH 23-2	●
	TMTH 23 I 12 UN	12	≥1 1/8"	27	8.0	3.5	TMTSRH 23-2	●
	TMTH 23 I 8 UN	8	≥1 3/16"	27	8.0	3.5	TMTSRH 23-2	●
	TMTH 23 I 7 UN	7	≥1 1/4"	27	8.0	3.5	TMTSRH 23-2	●
	TMTH 32 I 20 UN	20	≥1 3/8"	32	9.0	4.0	TMTSRH 32-5	●
	TMTH 32 I 18 UN	18	≥1 3/8"	32	9.0	4.0	TMTSRH 32-5	●
	TMTH 32 I 16 UN	16	≥1 3/8"	32	9.0	4.0	TMTSRH 32-5	●
	TMTH 32 I 12 UN	12	≥1 7/16"	32	9.0	4.0	TMTSRH 32-5	●
	TMTH 32 I 8 UN	8	≥1 1/2"	32	9.0	4.0	TMTSRH 32-5	●
	TMTH 32 I 6 UN	6	≥1 9/16"	32	9.0	4.0	TMTSRH 32-5	●
	TMTH 45 I 16 UN	16	≥2"	37	11.9	5.0	TMTSRH 45-6	●
	TMTH 45 I 12 UN	12	≥2"	37	11.9	5.0	TMTSRH 45-6	●
	TMTH 45 I 8 UN	8	≥2 1/4"	37	11.9	5.0	TMTSRH 45-6	●
	TMTH 45 I 6 UN	6	≥2 1/4"	37	11.9	5.0	TMTSRH 45-6	●
	TMTH 63 I 16 UN	16	≥2 3/4"	38	11.9	5.0	TMTSRH 63-9	●
TMTH 63 I 12 UN	12	≥2 3/4"	38	11.9	5.0	TMTSRH 63-9	●	
TMTH 63 I 8 UN	8	≥3"	38	11.9	5.0	TMTSRH 63-9	●	
TMTH 63 I 6 UN	6	≥3"	38	11.9	5.0	TMTSRH 63-9	●	

TMTSRH ▶ THID: Thread designation inside

●: Standard items



TMTH-W



Helical inserts for whitworth threads, BSW, BSF, BSP (Internal and external)

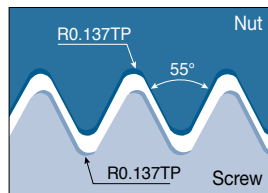
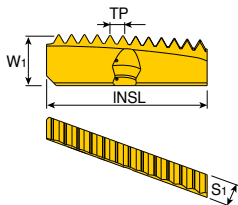

Insert	Designation	TPI	THID	THOD	Dimension (mm)			Tool	Grade TT9030
					INSL	W1	S1		
	TMTH 23 11 W	11	≥G 1"	≥G 1"	27	8.0	3.5	TMTSRH 23-2	●
	TMTH 32 11 W	11	≥G 1 1/8"	≥G 1"	32	9.0	4.0	TMTSRH 32-5	●
	TMTH 45 11 W	11	≥G 1 3/4"	≥G 1"	37	11.9	5.0	TMTSRH 45-6	●
	TMTH 63 11 W	11	≥G 2 1/2"	≥G 1"	38	11.9	5.0	TMTSRH 63-9	●

▶ THID: Thread designation inside
 ▶ THOD: Thread designation outside

●: Standard item

C36, C39

TMTH-NPT



Helical inserts for NPT threads (Internal and external)

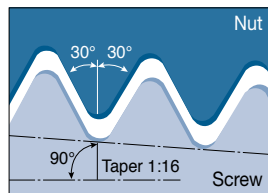
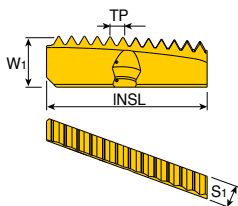

Insert	Designation	TPI	THID	THOD	Dimension (mm)			Tool	Grade TT9030
					INSL	W1	S1		
	TMTH 23 11.5 NPT	11.5	1"-2" NPT	1"-2" NPT	27	8.0	3.5	TMTSRH 23-2	●
	TMTH 32 11.5 NPT	11.5	1 1/4"-2" NPT	1"-2" NPT	32	9.0	4.0	TMTSRH 32-5	●
	TMTH 45 11.5 NPT	11.5	2" NPT	1"-2" NPT	37	11.9	5.0	TMTSRH 45-6	●
	TMTH 63 11.5 NPT	11.5	-	≥1" NPT	38	11.9	5.0	TMTSRH 63-9	●

▶ THID: Thread designation inside
 ▶ THOD: Thread designation outside

●: Standard items

C36, C39

TMTH-BSPT



Helical inserts for BSPT threads (Internal and external)

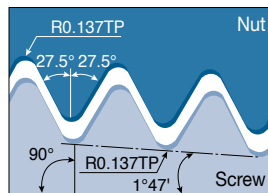
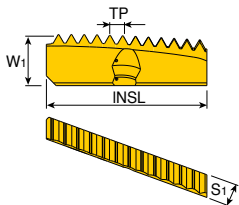

Insert	Designation	TPI	THID	THOD	Dimension (mm)			Tool	Grade TT9030
					INSL	W1	S1		
	TMTH 23 11 BSPT	11	≥1" BSPT	≥1" BSPT	27	8.0	3.5	TMTSRH 23-2	●
	TMTH 32 11 BSPT	11	≥1 1/8" BSPT	≥1" BSPT	32	9.0	4.0	TMTSRH 32-5	●
	TMTH 45 11 BSPT	11	≥1 3/4" BSPT	≥1" BSPT	37	11.9	5.0	TMTSRH 45-6	●
	TMTH 63 11 BSPT	11	≥2 1/2" BSPT	≥1" BSPT	38	11.9	5.0	TMTSRH 63-9	●



▶ THID: Thread designation inside
▶ THOD: Thread designation outside

●: Standard Item

TMTH-F



Helical long edge finishing inserts

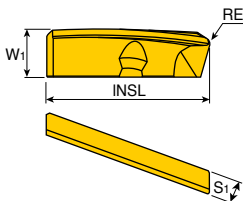

Insert	Designation	Dimension (mm)				Tool	Grade TT9030
		INSL	W1	S1	RE		
	TMTH 23F R0.2	27	8.0	3.5	0.2	TMTSRH 23-2	●
	TMTH 23F R0.5	27	8.0	3.5	0.5	TMTSRH 23-2	●
	TMTH 23F R1.0	27	8.0	3.5	1.0	TMTSRH 23-2	●
	TMTH 32F R0.2	32	9.0	4.0	0.2	TMTSRH 32-5	●
	TMTH 32F R0.5	32	9.0	4.0	0.5	TMTSRH 32-5	●
	TMTH 32F R1.0	32	9.0	4.0	1.0	TMTSRH 32-5	●
	TMTH 45F R0.2	37	11.9	5.0	0.2	TMTSRH 45-6	●



●: Standard items

Recommended Cutting Conditions

Machining data for indexable insert of threading cutters

ISO	Material	Condition	Tensile strength (N/mm ²)	Hardness HB	Material No.	Cutting speed Vc(m/min)		
						TT9030		
P	Non-alloy steel, cast steel, free cutting steel	<0.25%C	Annealed	420	125	1	100-200	
		>=0.25%C	Annealed	650	190	2	95-190	
		<0.55%C	Quenched and tempered	850	250	3	90-180	
		>=0.55%C	Annealed	750	220	4	90-170	
			Quenched and tempered	1000	300	5	80-150	
	Low alloy steel and cast steel (Less than 5% of alloying elements)		Annealed		600	200	6	120-170
				Quenched and tempered	930	275	7	115-160
			Quenched and tempered		1000	300	8	105-150
					1200	350	9	140
	High alloy steel, cast steel and tool steel		Annealed	680	200	10	90-170	
Quenched and tempered			1100	325	11	75-145		
M	Stainless steel and cast steel	Ferritic / martensitic	680	200	12	110-170		
		Martensitic	820	240	13	100-160		
		Austenitic	600	180	14	90-145		
K	Gray cast iron (GG)	Ferritic		160	15	65-135		
		Pearlitic		250	16	65-110		
	Cast iron nodular (GGG)	Ferritic		180	17	65-135		
		Pearlitic		260	18	60-100		
	Malleable cast iron	Ferritic		130	19	65-135		
	Pearlitic		230	20	60-120			
N	Aluminum - Wrought alloy	Not cureable		60	21	110-260		
		Cured		100	22	110-200		
	Aluminum-cast, alloyed	<=12% Si	Not cureable		75	23	145-350	
			Cured		90	24	145-275	
	>12% Si	High temp.		130	25	95-225		
		Free cutting		110	26	145-350		
	Copper alloys	Brass		90	27	145-350		
		Electrolitic copper		100	28	145-350		
	Non-metallic		Duroplastics, fiber plastics			29	90-370	
			Hard rubber			30	80-330	
S	High temp. alloys	Fe based	Annealed		200	31	20-60	
			Cured		280	32	20-50	
		Ni or Co based	Annealed		250	33	20-30	
			Cured		350	34	10-20	
			Cast		320	35	15-25	
	Titanium, Ti alloys	Pure	Rm 400	190	36	30-90		
Alpha+beta alloys cured		Rm 1050	310	37	20-70			
H	Hardened steel	Hardened		55HRC	38	25-60		
		Hardened		60HRC	39	20-40		
	Chilled cast iron	Cast		400	40	25-60		
	Cast iron nodular	Hardened		55HRC	41	20-50		

► For more information of material groups, see the materials & grades "material conversion table"

■ Steel
 ■ Stainless steel
 ■ Cast iron
 ■ Nonferrous
 ■ High temp. alloys
 ■ Hardened steel

► Feed rate: 0.05 - 0.15 mm/tooth

Recommended Cutting Conditions



Machining data for solid carbide threading end mills

ISO	Material	Condition	Tensile strength (N/mm ²)	Hardness HB	Material No.	Cutting speed Vc(m/min)		
						TT9030		
P	Non-alloy steel, cast steel, free cutting steel	<0.25%C	Annealed	420	125	1	100-250	
		>=0.25%C	Annealed	650	190	2	80-210	
		<0.55%C	Quenched and tempered	850	250	3	65-170	
		>=0.55%C	Annealed	750	220	4	110-180	
			Quenched and tempered	1000	300	5	95-160	
	Low alloy steel and cast steel (Less than 5% of alloying elements)		Annealed		600	200	6	90-160
					930	275	7	65-200
			Quenched and tempered		1000	300	8	70-210
					1200	350	9	95-160
	High alloy steel, cast steel and tool steel		Annealed	680	200	10	130-170	
			Quenched and tempered	1100	325	11	75-100	
M	Stainless steel and cast steel	Ferritic / martensitic	680	200	12	110-170		
		Martensitic	820	240	13	70-155		
		Austenitic	600	180	14	85-100		
K	Gray cast iron (GG)	Ferritic		160	15	70-150		
		Pearlitic		250	16	110-140		
	Cast iron nodular (GGG)	Ferritic		180	17	120-160		
		Pearlitic		260	18	75-160		
	Malleable cast iron	Ferritic		130	19	120-160		
	Pearlitic		230	20	110-140			
N	Aluminum - Wrought alloy	Not cureable		60	21	160-300		
		Cured		100	22			
	Aluminum-cast, alloyed	<=12% Si	Not cureable		75	23		
			Cured		90	24		
		>12% Si	High temp.		130	25		
	Copper alloys	>1% Pb	Free cutting		110	26		
			Brass		90	27		
			Electrolitic copper		100	28		
Non-metallic		Duroplastics, fiber plastics			29	100-400		
		Hard rubber			30			
S	High temp. alloys	Fe based	Annealed		200	31		
			Cured		280	32		
		Ni or Co based	Annealed		250	33	20-80	
			Cured		350	34		
	Titanium, Ti alloys		Cast		320	35		
			Pure	Rm 400	190	36		
H	Hardened steel	Hardened		55HRC	38	55-65		
				60HRC	39	45-55		
	Chilled cast iron	Cast		400	40	90-105		
	Cast iron nodular	Hardened		55HRC	41	55-65		

► For more information of material groups, see the materials & grades "material conversion table"

■ Steel
 ■ Stainless steel
 ■ Cast iron
 ■ Nonferrous
 ■ High temp. alloys
 ■ Hardened steel

Recommended Cutting Conditions



Machining data for solid carbide threading end mills

Feed (mm/tooth) for diameter (mm)											
Ø2	Ø3	Ø4	Ø6	Ø8	Ø10	Ø12	Ø14	Ø16	Ø20	Ø25	Ø30
0.03	0.04	0.04	0.06	0.07	0.08	0.09	0.11	0.12	0.15	0.18	0.21
0.03	0.04	0.04	0.06	0.07	0.08	0.09	0.11	0.12	0.15	0.18	0.21
0.02	0.03	0.03	0.05	0.06	0.07	0.08	0.09	0.1	0.12	0.15	0.18
0.02	0.03	0.03	0.05	0.06	0.07	0.08	0.09	0.1	0.12	0.15	0.18
0.02	0.02	0.02	0.03	0.04	0.05	0.05	0.06	0.07	0.08	0.1	0.11
0.02	0.02	0.02	0.03	0.04	0.05	0.05	0.06	0.07	0.08	0.1	0.11
0.02	0.02	0.02	0.03	0.04	0.05	0.05	0.06	0.07	0.08	0.1	0.11
0.02	0.02	0.02	0.03	0.04	0.05	0.05	0.06	0.07	0.08	0.1	0.11
0.02	0.02	0.02	0.03	0.04	0.05	0.05	0.06	0.07	0.08	0.1	0.11
0.02	0.02	0.02	0.03	0.04	0.05	0.05	0.06	0.07	0.08	0.1	0.11
0.02	0.02	0.02	0.03	0.04	0.05	0.05	0.06	0.07	0.08	0.1	0.11
0.02	0.02	0.02	0.03	0.04	0.05	0.05	0.06	0.07	0.08	0.1	0.11
0.02	0.02	0.02	0.03	0.04	0.05	0.05	0.06	0.07	0.08	0.1	0.11
0.02	0.02	0.02	0.03	0.04	0.05	0.05	0.06	0.07	0.08	0.1	0.11
0.03	0.04	0.04	0.06	0.07	0.08	0.09	0.11	0.12	0.15	0.18	0.21
0.03	0.04	0.04	0.06	0.07	0.08	0.09	0.11	0.12	0.15	0.18	0.21
0.03	0.04	0.04	0.06	0.07	0.08	0.09	0.11	0.12	0.15	0.18	0.21
0.03	0.04	0.04	0.06	0.07	0.08	0.09	0.11	0.12	0.15	0.18	0.21
0.03	0.04	0.04	0.06	0.07	0.08	0.09	0.11	0.12	0.15	0.18	0.21
0.03	0.04	0.04	0.06	0.07	0.08	0.09	0.11	0.12	0.15	0.18	0.21
0.03	0.04	0.04	0.06	0.07	0.08	0.09	0.11	0.12	0.15	0.18	0.21
0.05	0.06	0.07	0.09	0.1	0.11	0.12	0.13	0.15	0.18	0.22	0.25
0.02	0.02	0.02	0.03	0.03	0.03	0.03	0.04	0.04	0.04	0.05	0.05
0.02	0.02	0.02	0.03	0.03	0.03	0.03	0.04	0.04	0.04	0.05	0.05

► For cutters with long cutting flute, reduce feed rate by 40%

Recommended Cutting Conditions



Machining data for short solid carbide thread mills

ISO	Material	Hardness (HRC)	Cutting speed Vc (m/min)	Feed (mm/tooth) for diameter (mm)												
				Ø1.5	Ø2	Ø3	Ø4	Ø5	Ø6	Ø7	Ø8	Ø9	Ø10	Ø12	Ø14	Ø15
P	Low & medium carbon steels		60-120	0.05	0.05	0.07	0.09	0.11	0.13	0.14	0.15	0.16	0.16	0.17	0.18	0.18
	High carbon steels		60-90	0.04	0.05	0.06	0.08	0.09	0.10	0.12	0.13	0.14	0.14	0.16	0.17	0.18
	Alloy steels, treated steels		50-80	0.04	0.04	0.05	0.05	0.06	0.07	0.07	0.08	0.09	0.1	0.12	0.13	0.14
	Cast steels		70-90	0.04	0.04	0.05	0.05	0.06	0.07	0.07	0.08	0.09	0.1	0.12	0.13	0.14
M	Stainless steels		60-90	0.03	0.03	0.04	0.05	0.06	0.06	0.07	0.08	0.09	0.1	0.11	0.12	0.13
K	Cast Iron		40-80	0.05	0.05	0.07	0.09	0.11	0.13	0.14	0.15	0.16	0.16	0.17	0.18	0.18
N	Aluminum		80-150	0.05	0.05	0.07	0.09	0.11	0.13	0.14	0.15	0.16	0.16	0.17	0.18	0.18
	Synthetics, duroplastics, thermoplastics		50-200	0.10	0.11	0.12	0.14	0.16	0.18	0.19	0.19	0.19	0.19	0.19	0.20	0.20
S	Nickel alloys, titanium alloys.		20-40	0.03	0.03	0.04	0.04	0.05	0.06	0.06	0.06	0.07	0.07	0.07	0.08	0.08
H	Hardened steel	45-50	60-70	0.04	0.04	0.05	0.05	0.06	0.06	0.07	0.07	0.08				
		51-55	50-60	0.03	0.03	0.04	0.04	0.05	0.05	0.06	0.06	0.07				
		56-62	40-50	0.02	0.02	0.03	0.03	0.04	0.04	0.05	0.05	0.06				

► For more information of material groups, see the materials & grades "material conversion table"

■ Steel
 ■ Stainless steel
 ■ Cast iron
 ■ Nonferrous
 ■ High temp. alloys
 ■ Hardened steel

T-TAP

Tapping





1 TaeguTec T-Tap

T	TaeguTec
P	PM
H	HSSE

2 Standard

4	DIN371
5	DIN374
6	DIN376

3 ISO grade

5	Multi
----------	-------

4 Flute

2	Straight flute-spiral point
4	Right hand spiral 40°

5 Chamfer

B	4-5 threads
C	2-3 threads

6 Coating

None	Uncoated
05	S.T.
10	TiN

7 Tap X Pitch

M2 X 0.4	M2 size 0.4 pitch
-----------------	----------------------

Straight flute with spiral point - Uncoated

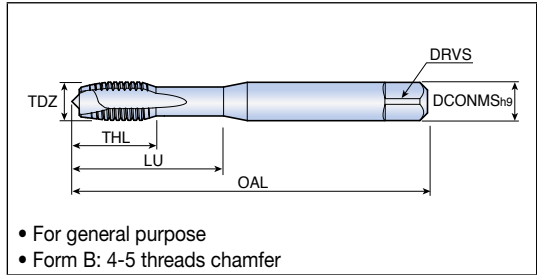

- For general purpose
- Form B: 4-5 threads chamfer

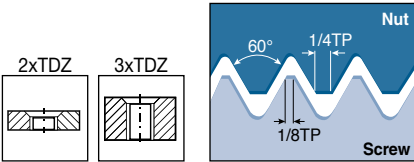

Metric ISO standard thread DIN 13 standard

Designation	TDZ	TP (mm)	Standard (DIN)	Tolerance	Dimension (mm)							
					OAL	THL	LU	DCONMS	DRVS	Core hole		
TPH452B M2x0.4	M2	0.4	DIN371	ISO 2-6H	45	8	-	2.8	2.1	1.6		
TPH452B M2.5x0.45	M2.5	0.45			50	9	-	2.8	2.1	2.05		
TPH452B M3x0.5	M3	0.5			56	10	18	3.5	2.7	2.5		
TPH452B M4x0.7	M4	0.7			63	12	21	4.5	3.4	3.3		
TPH452B M5x0.8	M5	0.8			70	14	25	6	4.9	4.2		
TPH452B M6x1.0	M6	1			80	16	30	6	4.9	5		
TPH452B M8x1.25	M8	1.25			90	18	35	8	6.2	6.8		
TPH452B M10x1.5	M10	1.5			100	20	39	10	8	8.5		
TPH652B M12x1.75	M12	1.75			DIN376	ISO 2-6H	110	22	-	9	7	10.2
TPH652B M14x2.0	M14	2					110	24	-	11	9	12
TPH652B M16x2.0	M16	2	110	26			-	12	9	14		
TPH652B M20x2.5	M20	2.5	140	30			-	16	12	17.5		

Metric ISO fine thread DIN 13 standard

Designation	TDZ	TP (mm)	Standard (DIN)	Tolerance	Dimension (mm)					
					OAL	THL	LU	DCONMS	DRVS	Core hole
TPH552B MF8x1.0	M8	1	DIN374	ISO 2-6H	90	15	-	6	4.9	7
TPH552B MF10x1.25	M10	1.25			100	18	-	7	5.5	8.8
TPH552B MF12x1.5	M12	1.5			100	18	-	9	7	10.5
TPH552B MF14x1.5	M14	1.5			100	18	-	11	9	12.5
TPH552B MF16x1.5	M16	1.5			100	18	-	12	9	14.5



TPH...52B05



Straight flute with spiral point - Steam tempered

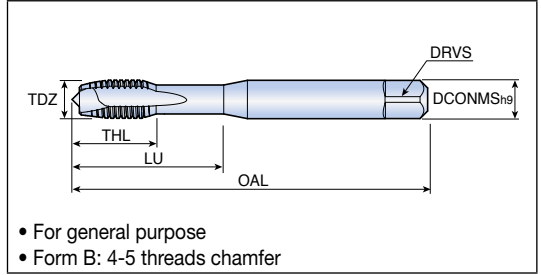
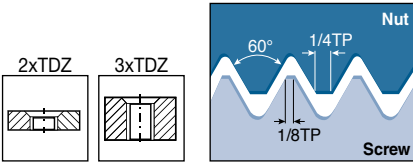

Metric ISO standard thread DIN 13 standard

Designation	TDZ	TP (mm)	Standard (DIN)	Tolerance	Dimension (mm)							
					OAL	THL	LU	DCONMS	DRVS	Core hole		
TPH452B05 M2x0.4	M2	0.4	DIN371	ISO 2-6H	45	8	-	2.8	2.1	1.6		
TPH452B05 M2.5x0.45	M2.5	0.45			50	9	-	2.8	2.1	2.05		
TPH452B05 M3x0.5	M3	0.5			56	10	18	3.5	2.7	2.5		
TPH452B05 M4x0.7	M4	0.7			63	12	21	4.5	3.4	3.3		
TPH452B05 M5x0.8	M5	0.8			70	14	25	6	4.9	4.2		
TPH452B05 M6x1.0	M6	1			80	16	30	6	4.9	5		
TPH452B05 M8x1.25	M8	1.25			90	18	35	8	6.2	6.8		
TPH452B05 M10x1.5	M10	1.5			100	20	39	10	8	8.5		
TPH652B05 M12x1.75	M12	1.75			DIN376	ISO 2-6H	110	22	-	9	7	10.2
TPH652B05 M14x2.0	M14	2					110	24	-	11	9	12
TPH652B05 M16x2.0	M16	2	110	26			-	12	9	14		
TPH652B05 M20x2.5	M20	2.5	140	30			-	16	12	17.5		

Metric ISO fine thread DIN 13 standard

Designation	TDZ	TP (mm)	Standard (DIN)	Tolerance	Dimension (mm)					
					OAL	THL	LU	DCONMS	DRVS	Core hole
TPH552B05 MF8x1.0	M8	1	DIN374	ISO 2-6H	90	15	-	6	4.9	7
TPH552B05 MF10x1.25	M10	1.25			100	18	-	7	5.5	8.8
TPH552B05 MF12x1.5	M12	1.5			100	18	-	9	7	10.5
TPH552B05 MF14x1.5	M14	1.5			100	18	-	11	9	12.5
TPH552B05 MF16x1.5	M16	1.5			100	18	-	12	9	14.5



TPH...52B10



Straight flute with spiral point - TiN coated

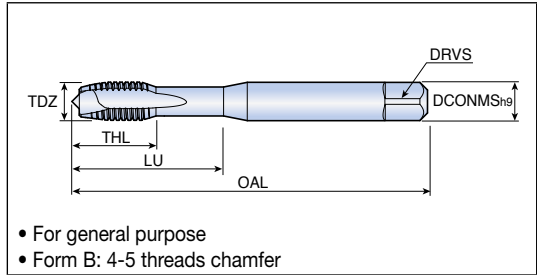
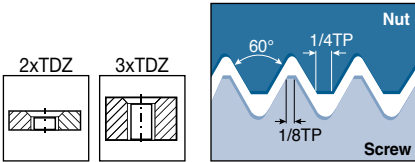

Metric ISO standard thread DIN 13 standard

Designation	TDZ	TP (mm)	Standard (DIN)	Tolerance	Dimension (mm)							
					OAL	THL	LU	DCONMS	DRVS	Core hole		
TPH452B10 M2x0.4	M2	0.4	DIN371	ISO 2-6H	45	8	-	2.8	2.1	1.6		
TPH452B10 M2.5x0.45	M2.5	0.45			50	9	-	2.8	2.1	2.05		
TPH452B10 M3x0.5	M3	0.5			56	10	18	3.5	2.7	2.5		
TPH452B10 M4x0.7	M4	0.7			63	12	21	4.5	3.4	3.3		
TPH452B10 M5x0.8	M5	0.8			70	14	25	6	4.9	4.2		
TPH452B10 M6x1.0	M6	1			80	16	30	6	4.9	5		
TPH452B10 M8x1.25	M8	1.25			90	18	35	8	6.2	6.8		
TPH452B10 M10x1.5	M10	1.5			100	20	39	10	8	8.5		
TPH652B10 M12x1.75	M12	1.75			DIN376	ISO 2-6H	110	22	-	9	7	10.2
TPH652B10 M14x2.0	M14	2					110	24	-	11	9	12
TPH652B10 M16x2.0	M16	2	110	26			-	12	9	14		
TPH652B10 M20x2.5	M20	2.5	140	30			-	16	12	17.5		

Metric ISO fine thread DIN 13 standard

Designation	TDZ	TP (mm)	Standard (DIN)	Tolerance	Dimension (mm)					
					OAL	THL	LU	DCONMS	DRVS	Core hole
TPH552B10 MF8x1.0	M8	1	DIN374	ISO 2-6H	90	15	-	6	4.9	7
TPH552B10 MF10x1.25	M10	1.25			100	18	-	7	5.5	8.8
TPH552B10 MF12x1.5	M12	1.5			100	18	-	9	7	10.5
TPH552B10 MF14x1.5	M14	1.5			100	18	-	11	9	12.5
TPH552B10 MF16x1.5	M16	1.5			100	18	-	12	9	14.5



TPH...54C



Right hand spiral flute (40°) - Uncoated

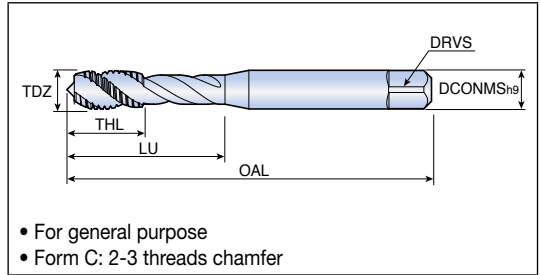
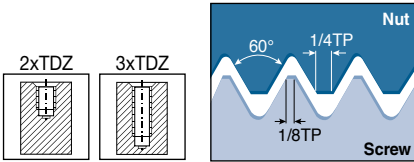

Metric ISO standard thread DIN 13 standard

Designation	TDZ	TP (mm)	Standard (DIN)	Tolerance	Dimension (mm)					
					OAL	THL	LU	DCONMS	DRVS	Core hole
TPH454C M2x0.4	M2	0.4	DIN371	ISO 2-6H	45	6	10	2.8	2.1	1.6
TPH454C M2.5x0.45	M2.5	0.45			50	6	12	2.8	2.1	2.05
TPH454C M3x0.5	M3	0.5			56	7	18	3.5	2.7	2.5
TPH454C M4x0.7	M4	0.7			63	8	21	4.5	3.4	3.3
TPH454C M5x0.8	M5	0.8			70	10	25	6	4.9	4.2
TPH454C M6x1.0	M6	1			80	12	30	6	4.9	5
TPH454C M8x1.25	M8	1.25			90	15	35	8	6.2	6.8
TPH454C M10x1.5	M10	1.5			100	18	39	10	8	8.5
TPH654C M12x1.75	M12	1.75	DIN376	ISO 2-6H	110	18	-	9	7	10.2
TPH654C M14x2.0	M14	2			110	20	-	11	9	12
TPH654C M16x2.0	M16	2			110	20	-	12	9	14
TPH654C M20x2.5	M20	2.5			140	25	-	16	12	17.5

Metric ISO fine thread DIN 13 standard

Designation	TDZ	TP (mm)	Standard (DIN)	Tolerance	Dimension (mm)					
					OAL	THL	LU	DCONMS	DRVS	Core hole
TPH554C MF8x1.0	M8	1	DIN374	ISO 2-6H	90	15	-	6	4.9	7
TPH554C MF10x1.25	M10	1.25			100	18	-	7	5.5	8.8
TPH554C MF12x1.5	M12	1.5			100	18	-	9	7	10.5
TPH554C MF14x1.5	M14	1.5			100	18	-	11	9	12.5
TPH554C MF16x1.5	M16	1.5			100	18	-	12	9	14.5



TPH...54C05



Right hand spiral flute (40°) - Steam tempered

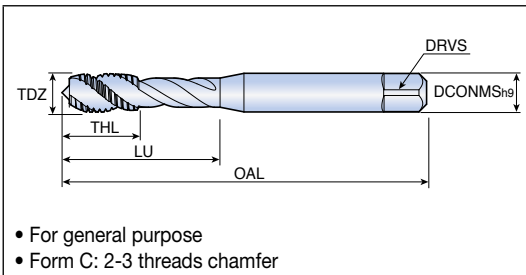
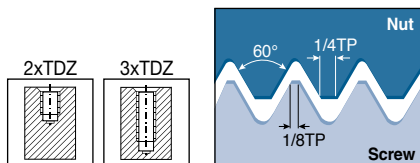

Metric ISO standard thread DIN 13 standard

Designation	TDZ	TP (mm)	Standard (DIN)	Tolerance	Dimension (mm)							
					OAL	THL	LU	DCONMS	DRVS	Core hole		
TPH454C05 M2x0.4	M2	0.4	DIN371	ISO 2-6H	45	6	10	2.8	2.1	1.6		
TPH454C05 M2.5x0.45	M2.5	0.45			50	6	12	2.8	2.1	2.05		
TPH454C05 M3x0.5	M3	0.5			56	7	18	3.5	2.7	2.5		
TPH454C05 M4x0.7	M4	0.7			63	8	21	4.5	3.4	3.3		
TPH454C05 M5x0.8	M5	0.8			70	10	25	6	4.9	4.2		
TPH454C05 M6x1.0	M6	1			80	12	30	6	4.9	5		
TPH454C05 M8x1.25	M8	1.25			90	15	35	8	6.2	6.8		
TPH454C05 M10x1.5	M10	1.5			100	18	39	10	8	8.5		
TPH654C05 M12x1.75	M12	1.75			DIN376	ISO 2-6H	110	18	-	9	7	10.2
TPH654C05 M14x2.0	M14	2					110	20	-	11	9	12
TPH654C05 M16x2.0	M16	2	110	20			-	12	9	14		
TPH654C05 M20x2.5	M20	2.5	140	25			-	16	12	17.5		

Metric ISO fine thread DIN 13 standard

Designation	TDZ	TP (mm)	Standard (DIN)	Tolerance	Dimension (mm)					
					OAL	THL	LU	DCONMS	DRVS	Core hole
TPH554C05 MF8x1.0	M8	1	DIN374	ISO 2-6H	90	15	-	6	4.9	7
TPH554C05 MF10x1.25	M10	1.25			100	18	-	7	5.5	8.8
TPH554C05 MF12x1.5	M12	1.5			100	18	-	9	7	10.5
TPH554C05 MF14x1.5	M14	1.5			100	18	-	11	9	12.5
TPH554C05 MF16x1.5	M16	1.5			100	18	-	12	9	14.5



TPH...54C10



Right hand spiral flute (40°) - TiN coated

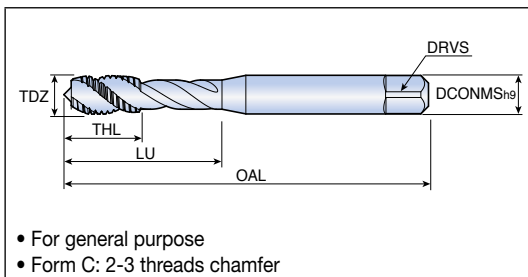
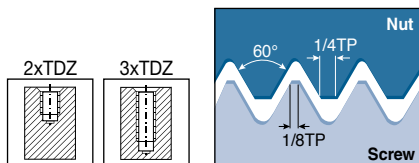

Metric ISO standard thread DIN 13 standard

Designation	TDZ	TP (mm)	Standard (DIN)	Tolerance	Dimension (mm)							
					OAL	THL	LU	DCONMS	DRVS	Core hole		
TPH454C10 M2x0.4	M2	0.4	DIN371	ISO 2-6H	45	6	10	2.8	2.1	1.6		
TPH454C10 M2.5x0.45	M2.5	0.45			50	6	12	2.8	2.1	2.05		
TPH454C10 M3x0.5	M3	0.5			56	7	18	3.5	2.7	2.5		
TPH454C10 M4x0.7	M4	0.7			63	8	21	4.5	3.4	3.3		
TPH454C10 M5x0.8	M5	0.8			70	10	25	6	4.9	4.2		
TPH454C10 M6x1.0	M6	1			80	12	30	6	4.9	5		
TPH454C10 M8x1.25	M8	1.25			90	15	35	8	6.2	6.8		
TPH454C10 M10x1.5	M10	1.5			100	18	39	10	8	8.5		
TPH654C10 M12x1.75	M12	1.75			DIN376	ISO 2-6H	110	18	-	9	7	10.2
TPH654C10 M14x2.0	M14	2					110	20	-	11	9	12
TPH654C10 M16x2.0	M16	2	110	20			-	12	9	14		
TPH654C10 M20x2.5	M20	2.5	140	25			-	16	12	17.5		

Metric ISO fine thread DIN 13 standard

Designation	TDZ	TP (mm)	Standard (DIN)	Tolerance	Dimension (mm)					
					OAL	THL	LU	DCONMS	DRVS	Core hole
TPH554C10 MF8x1.0	M8	1	DIN374	ISO 2-6H	90	15	-	6	4.9	7
TPH554C10 MF10x1.25	M10	1.25			100	18	-	7	5.5	8.8
TPH554C10 MF12x1.5	M12	1.5			100	18	-	9	7	10.5
TPH554C10 MF14x1.5	M14	1.5			100	18	-	11	9	12.5
TPH554C10 MF16x1.5	M16	1.5			100	18	-	12	9	14.5



Recommended Cutting Conditions



Machining data for straight flute with spiral point tap

Cutting speed Vc(m/min)

ISO	Material	Condition	Straight flute with spiral point tap			Lubrication	
			Uncoated	Steam tempered	TiN coated		
P	Non-alloy steel, cast steel, free cutting steel	<0.25%C	Annealed	5-25	5-25 *	15-45 *	E/O
		>=0.25%C	Annealed	5-20	5-20 *	10-40 *	E/O
		<0.55%C	Quenched and tempered	-	2-15 *	5-25 *	E/O
		>=0.55%C	Annealed	5-20	5-20 *	10-40 *	E/O
	Low alloy steel and cast steel (Less than 5% of alloying elements)	Quenched and tempered	-	2-15 *	5-25 *	E/O	
		Annealed	5-25	5-25 *	15-45 *	E/O	
		Quenched and tempered	-	2-15 *	5-20 *	E/O	
		Quenched and tempered	-	-	5-20	O/S	
M	Stainless steel and cast steel	Ferritic / martensitic	-	2-10 *	5-20 *	E/O	
		Martensitic	-	2-10 *	5-20 *	E/O	
		Austenitic	-	2-10 *	5-20 *	E/O	
K	Gray cast iron (GG)	Ferritic	10-15	10-25	15-45	E/D	
		Pearlitic	10-15	10-25	10-40	E/D	
	Cast iron nodular (GGG)	Ferritic	8-12	5-20	10-30	E/D	
		Pearlitic	8-12	5-15	10-25	E/D	
Malleable cast iron	Ferritic	10-15	10-25	15-45	E/D		
	Pearlitic	10-15	10-20	10-40	E/D		
N	Aluminum - wrought alloy	Not cureable	15-25 *	15-25	15-25	E/O	
		Cured	15-25 *	15-25	15-25	E/O	
	Aluminum-cast, alloyed	<=12% Si	Not cureable	15-20 *	10-20	15-40 *	E/O
		Cured	15-20 *	10-20	15-40 *	E/O	
		>12% Si	High temp.	15-20 *	15-20	10-30	E/O
	Copper alloys	>1% Pb	Free cutting	15-25 *	15-25	10-30	E/O
		Brass	10-40	10-40	20-60	E/O	
Electrolytic copper	10-15 *	2-10	5-25	E/O			
Non-metallic	Duroplastics, fiber plastics	-	10-20	10-20	D		
	Hard rubber	-	10-20	10-20	D		
S	High temp. alloys	Fe based	Annealed	-	-	3-5	S
			Cured	-	-	3-5	S
		Ni or Co based	Annealed	-	-	2-4	S
			Cured	-	-	2-4	S
	Titanium, Ti alloys	Cast	-	-	2-4	S	
		Pure	-	-	4-6	S	
Alpha+beta alloys cured	-	-	4-6	S			

* : Recommended

► For more information of material groups, see the materials & grades "material conversion table"

■ Steel
 ■ Stainless steel
 ■ Cast iron
 ■ Nonferrous
 ■ High temp. alloys
 ■ Hardened steel

► **Lubrication** **E:** Emulsion **O:** Cutting oil **S:** Special cutting oil **D:** Dry/air

Recommended Cutting Conditions



Machining data for 40° right hand spiral flute tap

Cutting speed Vc(m/min)

ISO	Material	Condition	40° right hand spiral flute tap			Lubrication	
			Uncoated	Steam tempered	TiN coated		
P	Non-alloy steel, cast steel, free cutting steel	<0.25%C	Annealed	5-25	5-25*	15-45*	E/O
		>=0.25%C	Annealed	5-20	5-20*	10-40*	E/O
		<0.55%C	Quenched and tempered	-	2-15*	5-25*	E/O
		>=0.55%C	Annealed	5-20	5-20*	10-40*	E/O
			Quenched and tempered	-	2-15*	5-25*	E/O
	Low alloy steel and cast steel (Less than 5% of alloying elements)	Annealed	5-25	5-25*	15-45*	E/O	
		Quenched and tempered	-	2-15*	5-20*	E/O	
	High alloy steel, cast steel and tool steel	Annealed	5-20	5-20	10-40*	E/O	
Quenched and tempered		-	-	5-20	O/S		
M	Stainless steel and cast steel	Ferritic / martensitic	-	2-10*	5-20*	E/O	
		Martensitic	-	2-10*	5-20*	E/O	
		Austenitic	-	2-10*	5-20*	E/O	
K	Gray cast iron (GG)	Ferritic	10-15	10-25	15-45	E/D	
		Pearlitic	10-15	10-20	10-40	E/D	
	Cast iron nodular (GGG)	Ferritic	8-12	5-20	10-30	E/D	
		Pearlitic	8-12	5-15	10-25	E/D	
Malleable cast iron	Ferritic	10-15	10-25	15-45	E/D		
	Pearlitic	10-15	10-20	10-40	E/D		
N	Aluminum - wrought alloy	Not cureable	15-25*	15-25	15-25	E/O	
		Cured	15-25*	15-25	15-25	E/O	
	Aluminum-cast, alloyed	<=12% Si	Not cureable	15-20*	10-20	15-40*	E/O
			Cured	15-20*	10-20	15-40*	E/O
		>12% Si	High temp.	15-20*	15-20	10-30	E/O
	Copper alloys	>1% Pb	Free cutting	15-25*	15-25	10-30	E/O
			Brass	10-40	10-40	50-60	E/O
			Electrolitic copper	10-15*	2-10	5-25	E/O
Non-metallic	Duroplastics, fiber plastics	-	10-20	10-20	D		
	Hard rubber	-	10-20	10-20	D		
S	High temp. alloys	Fe based	Annealed	-	-	3-5	S
			Cured	-	-	3-5	S
		Ni or Co based	Annealed	-	-	2-4	S
			Cured	-	-	2-4	S
	Titanium, Ti alloys	Cast	-	-	2-4	S	
		Pure	-	-	4-6	S	
	Alpha+beta alloys cured	-	-	4-6	S		

* : Recommended

► For more information of material groups, see the materials & grades "material conversion table"

■ Steel
 ■ Stainless steel
 ■ Cast iron
 ■ Nonferrous
 ■ High temp. alloys
 ■ Hardened steel

► **Lubrication** E: Emulsion O: Cutting oil S: Special cutting oil D: Dry/air

HOLEMAKING



HOLEMAKING



contents

Tool Selection Guide	D4
Grades	D16
Indexable Drills	
TOP-DRILL (Ø12-Ø80)	D18
T-DRILL (Ø12.5-Ø80)	D34
Head Changeable Drills	
DRILL-SFEED (Ø12-Ø25.9)	D55
WIN-DRILL (Small dia. Ø4-Ø5.9)	D58
DRILL-RUSH (Ø6-Ø25.9)	D59
WIN-DRILL (Modular type Ø6-Ø20.9)	D71
MODU-R-DRILL (Ø26-Ø50)	D75
SPADE-RUSH (Ø20-Ø41)	D80
Solid Drills	
SOLID-3-DRILL (Ø4-Ø12)	D83
H-DRILL (Ø3-Ø12)	D89
T-CHAMFER (Ø7-Ø20)	D107
Multifunctional Tools	
TOP-CAP (Ø8-Ø32)	D51

Guide to Icons



➤ External Coolant



➤ Internal Coolant



➤ Through Hole



➤ Blind Hole



➤ Tube Page

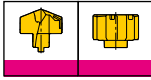

➤ Head Page



➤ Pad Page



➤ Cartridge Page

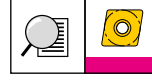

➤ Insert Page

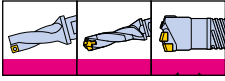

➤ Drill Body & Deep Drill Head Page



➤ Assembly Page



➤ Technical Data Page



➤ Cutting Condition Page



Reaming Tools

XM-REAM (Ø8-Ø12)

D112

TM-REAM (Ø11.5-Ø32)

D115

TB-REAM (Ø8-Ø32)

D118

TS-REAM (Ø3-Ø12)

D122

Deep Drilling Tools

WIN-GUN (Ø10-Ø25)

D125

T-DEEP

D127

Drilling Heads & Inserts

D180

Recommended Cutting Conditions

D226

Technical Data











D272

Tailor-made Order Form

D282

Tool Selection Guide

Drilling tools

Series			Indexable drill				
			<i>TOPDRILL</i>		<i>TDRILL</i>		<i>TOPCAP</i>
			TOP 2/3/4/5	TOP-CA	TDR 2/3/4/5	TDR-CA	TCAP
							
Pages			D18-D29	D30-D33	D34-D46	D47-D49	D51-D53
DC(mm)			Ø12.0-Ø50.0	Ø51.0-Ø80.0	Ø12.5-Ø50.0	Ø51.0-Ø80.0	Ø8.0-Ø32.0
Drilling depth(L/D)			2, 3, 4, 5 x Dc	2, 3, 4 x Dc	2, 3, 4, 5 x Dc	2.5, 3.5 x Dc	2.25, 3 x Dc
Hole tolerance			IT 11-13	IT 12-13	IT 12-13	IT 12-13	IT 10-12
Application	General drilling		●	●	●	●	●
	Cross hole drilling		●	●	●	●	
	Irregular surface drilling		○	○	○	○	●
	Interrupted drilling		○	○	○	○	
	Chamfering						
Coolant supply			Internal	Internal	Internal	Internal	Internal

Tool Selection Guide







Drilling tools

Head changeable drill					
<i>DRILLSPEED</i>	<i>WINDRILL</i>	<i>DRILLRUSH</i>			<i>WINDRILL</i>
3ED	TCD...AO	TCD	TCD-M	TCD...AO 3/5/8D	TCD-MRS/TCDM
					
D55-D57	D58	D59-D67	D68	D70	D71-D74
Ø12.0-Ø25.9	Ø4.0-Ø5.9	Ø6.0-Ø25.9	M8-M24 (ISO)	Ø6.0-Ø9.9	Ø6.0-Ø20.9
3, 5, 8 x Dc	3, 5 x Dc	1, 5, 3, 5, 8, 12 x Dc		3, 5, 8 x Dc	2, 3, 4 x Dc
IT 9-10	IT 9-10	IT 9-10	IT 9-10	IT 9-10	IT 9-10
●	●	●	●	●	●
○	●	●		●	●
			●		
Internal	Internal	Internal	Internal	Internal	Internal

● Recommended, ○ Suitable

Tool Selection Guide

Drilling tools

Series		Head changeable drill			Solid carbide drill
		<i>WINGUN</i>	<i>MODURDRILL</i>	<i>SPADERUSH</i>	<i>SOLID3DRILL</i>
		TCDGN	TNDH-TP/ MDB	LCD	3HD
					
Pages		D125-D126	D75-D79	D80-D82	D83-D88
DC(mm)		Ø10.0-Ø25.9	Ø26.0-Ø50.0	Ø20.0-Ø41.0	Ø4.0-Ø12.0
Drilling depth(L/D)		16, 20 x Dc	3, 5 x Dc	3, 5, 8 x Dc	3, 5, 8, 12 x Dc
Hole tolerance		IT 9-10	IT 10-12	IT 9-10	IT 8-10
Application	General drilling		•	•	•
	Cross hole drilling		•	•	•
	Irregular surface drilling				
	Interrupted drilling				
	Chamfering				
Coolant supply		Internal	Internal	Internal	Internal

Tool Selection Guide













Drilling tools

Solid carbide drill				
HDRILL				
NHD-PE/PI	NHD-KI	SHO 10/15/20	SHO-M	CDF
				
D89-D100	D101-D102	D104	D105	D106
Ø3.0-Ø12.0	Ø3.0-Ø12.0	Ø4.0-Ø10.0	M4-M10 (ISO)	Ø3.0-Ø12.7
3, 5 x Dc	3, 5 x Dc	10, 15, 20 x Dc		
IT 8-10	IT 8-10	IT 8-10	IT 8-10	IT 8-10
●	●	●	●	●
●	●	○		
			●	
External / Internal	Internal	Internal	Internal	External

● Recommended, ○ Suitable

Tool Selection Guide





Reaming tools

Series			Indexable reamer		Solid reamer		
			<i>XM-REAM</i>	<i>TM-REAM</i>	<i>TB-REAM</i>	<i>TS-REAM</i>	
			XR-S0	TM	TB	TS	
							
Pages			D112-D113	D115	D118-D119	D122-D123	
DC(mm)			Ø8.000-Ø12.999	Ø11.501-Ø32.000	Ø8.000-Ø32.000	Ø3.000-Ø12.000	
Reaming depth(L/D)			3, 5 x Dc	3, 5, 8 x Dc	5-9 x Dc	7.5-10 x Dc	
Hole tolerance			IT 7 ★	IT 7 ★	IT 6 ★★	IT 7	
Application		Through	Blind				
	General reaming			•	•	•	•
	Cross hole reaming					•	•
	Irregular surface reaming					•	•
	Interrupted reaming			•	•	•	•
Coolant supply			Internal	Internal	Internal	Internal	

★ Up to IT 6 tolerance ★★ Up to IT 5 tolerance

Tool Selection Guide

Deep drilling tools

Series		Indexable deep drill head				
						
		TRGD/TRGD3 /TRGDL	TBTA3	TBTA5	TBTA7	TBTA9
						
Pages		D127-D133	D134-D139	D140-D143	D144-D146	D147-D149
DC(mm)		Ø10.0-Ø36.0	Ø38.00-Ø106.99	Ø107.00-Ø168.99	Ø169.00-Ø232.99	Ø233.00-Ø293.99
Drilling depth(L/D)		10-25 x Dc	100 x Dc	100 x Dc	100 x Dc	100 x Dc
Hole tolerance		IT 10-11	IT 10	IT 10	IT 10	IT 10
Surface finish			3µm	3µm	3µm	3µm
Single tube	Outer four thread		●	●	●	●
	Inner single thread		●	●	●★	●
Double tube	Outer four thread		●	●		

★ In case of inner single thread connection TBTA7 series can cover up to dia. 245.99mm









Series		Indexable deep drill & boring head			Brazed deep drill head	
						
		TBTA-FB	TBTA-TR	TBTA-R	BTA-SE/DE	BTS-SE
						
Pages		D150-D155	D162-D165	D156-D161	D166-D168	D169
DC(mm)		Ø25.00-Ø89.00	Ø16.00-Ø40.00	Ø25.00-Ø110.99	Ø12.60-Ø65.00	Ø8.00-Ø20.00
Drilling depth(L/D)		100 x Dc	100 x Dc	100 x Dc	100 x Dc	100 x Dc
Hole tolerance		IT 10	IT 10	IT 7 - IT 9	IT 9	IT 9
Surface finish		3µm	3µm	1-2µm	2µm	2µm
Single tube	Outer four thread	●	●	●	●	●★
	Inner single thread	●	●	●		
Double tube	Outer four thread	●	●		●	

★ Two start thread: Diameter 12.60 to 15.59mm

● Recommended

Tool Selection Guide

Drill inserts

		TOP DRILL		TD DRILL		DRILL SPEED			
		SOMT		SPMG / SPGG		3ED-P+		3ED-F	
Series									
Pages		D180-D181		D182-D183		D184-D186		D187	
Size		04/05/06/07/08 09/11/13/15		05/06/07/09 11/12/14		Ø12.0-Ø25.9		Ø12.0-Ø25.9	
Chip former		DP, DK, DL, DA		DG, DK, DA		P+		F	
Grades		TT9080, TT9300 TT8020, TT6080, K10		TT9030, TT8020 TT7400, TT6030, K10		TT5130		TT5130	
Application	General drilling		•	•	•	•	•	•	
	Cross hole drilling		•	•	•	•	•		
	Irregular surface drilling		○	○	○	○	○		
	Interrupted drilling		○	○					
	Chamfering								

Tool Selection Guide









Drill inserts

WINDRILL		DRILLRUSH			
TCD-P	TCD-P/M/K/N	TCD-P+	TCD-F	AOMT	CRNG
					
D188	D189-D195	D196-D200	D201-D202	D203	D203
Ø4.0-Ø5.9	Ø6.0-Ø25.9	Ø6.0-Ø25.9	Ø6.0-Ø25.9	03,04,06-C30/C45	08-45CD
P	P/M/K/N	P+	F	-	-
TT9080	TT9080 UF10	TT9080	TT9080	TT9080	TT9080
●	●	●	●		
●	●	●	●		
○	○	○	○		
				●	●

● Recommended, ○ Suitable

Tool Selection Guide

Drill inserts

			MODURDRILL		SPADEFUSH	
			TCD-P-CO+	SPGX...DW	LCD-P	LCD-P+
Series						
Pages			D204	D204	D205-D206	D207
Size			Ø15.9-Ø25.9	06/07/09/11/14	Ø20.0-Ø41.0	Ø20.0-Ø34.5
Chip former			P-CO+	DW	P	P+
Grades			TT9080	TT9080	TT9080	TT9080
Application	General drilling		•	•	•	•
	Cross hole drilling		•	•	•	•
	Irregular surface drilling		○	○	○	○
	Interrupted drilling					
	Chamfering					

Tool Selection Guide









Drill inserts

<i>SPADE RUSH</i>	<i>T CHAMFER</i>	<i>TOP CAP</i>	<i>T DEEP</i>	
LCD-F	XCGT-C	XCGT-TA XCMT	NPHT NPMT	NPMX TPMX
				
D208-D209	D210	D211-D212	D213 -D215	D216
Ø20.0-Ø41.0	06/09	04/05/06/07/08 10/13/17	06/07/08/09 /11/13	08/14/17/24/28
F	C30/C45/C60	TA/GV/TC	R(L)-G... /R(L)-HF..	R-B/R-G
TT9080	TT9080	TT9080, TT8020, TT9030, K10	TT9030, TT9130, TT8125, TT6130, TT5030	TT9030, TT9130, TT8125, TT7200, TT6130, TT6020, TT5100, TT5030
●		●	●	●
●			○	○
○				
	●			

● Recommended, ○ Suitable











Tool Selection Guide

Drill inserts

		T_{DEEP}			
		TOGT	ZSGT	LOGT	TPMX XPMT
Series					
Pages		D218	D217	D217	D219
Size		07/08/09/10/11 /12/13/14	06	06	14/16/17/24
Chip former		RS/GF	RS	RS	LG/-45
Grades		TT9030	TT9130	TT9130, TT8125	TT9030, TT9130, TT6020, TT5100
Application	General drilling		●	●	●
	Cross hole drilling				○
	Irregular surface drilling				
	Interrupted drilling				
	Chamfering				

Tool Selection Guide

Reamer heads & blades

			<i>XM-REAM</i>	<i>TM-REAM</i>	<i>TBREAM</i>	
			XR	TM	TB	
Series						
Pages			D114	D116 - D117	D121	
Size			Ø8.000-Ø12.000	Ø11.50-Ø32.000	1/2/3/4	
Chip former			AS/BL	AS/BL	A06/B06/B12	
Grades			TT9030	TT9030	TT5030, TT5050	
Application		Through	Blind			
	General reaming			●	●	●
	Cross hole reaming					
	Irregular surface reaming					
	Interrupted reaming					

● Recommended, ○ Suitable

Grades

Holemaking grades

Grades	ISO	Characteristics & applications
TT6080 PVD carbide	K05 – K25 H05 – H25	<ul style="list-style-type: none"> • General machining for gray and ductile cast iron • Finish and medium machining of hardened steel
TT9300 CVD carbide	P10 – P25	<ul style="list-style-type: none"> • High speed drilling of carbon & alloy steel
TT5130 PVD carbide	P20 – P40 K20 – K40	<ul style="list-style-type: none"> • High speed drilling of carbon & alloy steel
TT9080 PVD carbide	P20 – P40 M20 – M40 S20 – S40	<ul style="list-style-type: none"> • General machining of steel • General machining of stainless steel • General machining of heat-resistant alloy
TT9030 PVD carbide	P20 – P40 M20 – M40 S20 – S40	<ul style="list-style-type: none"> • General machining of steel • General machining of stainless steel • General machining of heat-resistant alloy
TT8020 PVD carbide	P30 – P50 M30 – M50 S30 – S50	<ul style="list-style-type: none"> • Interrupted and rough machining of steel • Interrupted and rough machining of stainless steel • Low speed and interrupted machining of heat-resistant alloy
K10 Uncoated	K05 – K15 N05 – N15 S05 – S15	<ul style="list-style-type: none"> • General machining of cast iron • General machining of aluminum alloys and non-ferrous materials • General machining of heat-resistant alloy
UF1A/UF10 Uncoated	N10 – N25 S10 – S30	<ul style="list-style-type: none"> • General machining of aluminum alloys and non-ferrous materials • General machining of heat-resistant alloy

Selection guide for holemaking grades

For steel

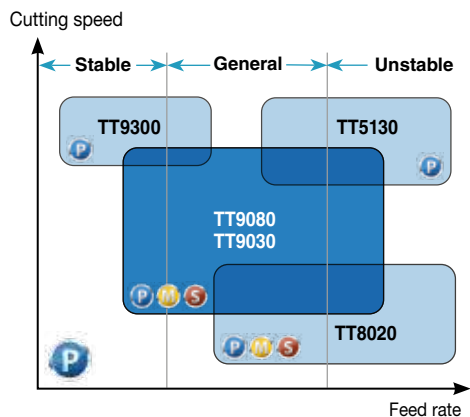

For cast iron

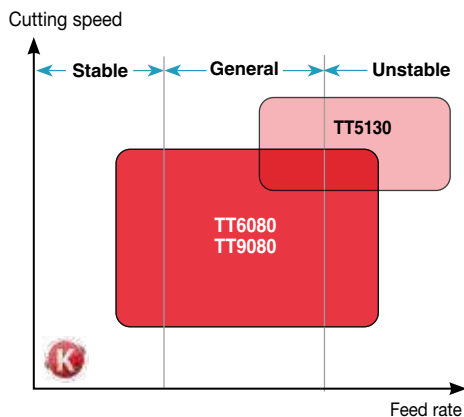

Drilling Tools



TOP 2...-T2



Indexable drill holders



- Drilling depth: 2x diameter

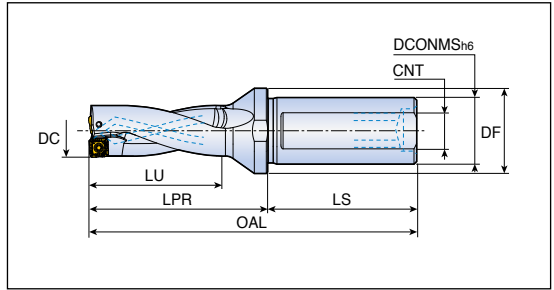

Designation	Dimension (mm)							Insert
	DC	DCONMS	DF	LU	LPR	LS	CNT	
TOP 2120-20T2-04	12.0	20	25	24	44	50	M13X1.0	SOMT 04...DP
2125-20T2-04	12.5	20	25	26	46	50	M13X1.0	D180
2130-20T2-04	13.0	20	25	26	46	50	M13X1.0	
2135-20T2-04	13.5	20	25	28	46	50	M13X1.0	SOMT 05...DP/DL/DK/DA
2140-20T2-05	14.0	20	25	28	46	50	M13X1.0	
2145-20T2-05	14.5	20	25	30	49	50	M13X1.0	D180-D181
2150-20T2-05	15.0	20	25	30	49	50	M13X1.0	
2155-20T2-05	15.5	20	25	32	52	50	M13X1.0	SOMT 06...DP/DL/DK/DA
2160-20T2-05	16.0	20	25	32	52	50	M13X1.0	
2165-25T2-06	16.5	25	32	34	54	56	M16X1.5	D180-D181
2170-25T2-06	17.0	25	32	34	54	56	M16X1.5	
2175-25T2-06	17.5	25	32	36	57	56	M16X1.5	SOMT 07...DP/DL/DK/DA
2180-25T2-06	18.0	25	32	36	57	56	M16X1.5	
2185-25T2-06	18.5	25	32	38	59	56	M16X1.5	D180-D181
2190-25T2-06	19.0	25	32	38	59	56	M16X1.5	
2195-25T2-07	19.5	25	32	40	63	56	M16X1.5	SOMT 08...DP/DL/DK/DA
2200-25T2-07	20.0	25	32	40	63	56	M16X1.5	
2205-25T2-07	20.5	25	32	42	65	56	M16X1.5	D180-D181
2210-25T2-07	21.0	25	32	42	65	56	M16X1.5	
2215-25T2-07	21.5	25	32	44	67	56	M16X1.5	SOMT 08...DP/DL/DK/DA
2220-25T2-07	22.0	25	32	44	67	56	M16X1.5	
2225-25T2-08	22.5	25	32	46	68	56	M16X1.5	D180-D181
2230-25T2-08	23.0	25	32	46	68	56	M16X1.5	
2230-32T2-08	23.0	32	40	46	68	60	M22X2.0	D180-D181
2235-25T2-08	23.5	25	32	48	70	56	M16X1.5	
2235-32T2-08	23.5	32	40	48	70	60	M22X2.0	SOMT 08...DP/DL/DK/DA
2240-25T2-08	24.0	25	32	48	70	56	M16X1.5	
2240-32T2-08	24.0	32	40	48	70	60	M22X2.0	D180-D181
2245-25T2-08	24.5	25	32	50	72	56	M16X1.5	
2245-32T2-08	24.5	32	40	50	72	60	M22X2.0	SOMT 08...DP/DL/DK/DA
2250-25T2-08	25.0	25	32	50	72	56	M16X1.5	
2250-32T2-08	25.0	32	40	50	72	60	M22X2.0	D180-D181
2255-25T2-08	25.5	25	32	52	73	56	M16X1.5	
2255-32T2-08	25.5	32	40	52	73	60	M22X2.0	SOMT 08...DP/DL/DK/DA
2260-25T2-08	26.0	25	32	52	73	56	M16X1.5	
2260-32T2-08	26.0	32	40	52	73	60	M22X2.0	



► OAL: LPR+LS

Indexable drill holders



- Drilling depth: 2xdiameter

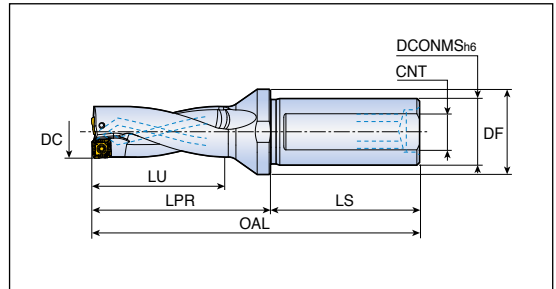

Designation	Dimension (mm)							Insert
	DC	DCONMS	DF	LU	LPR	LS	CNT	
TOP 2265-32T2-09	26.5	32	40	54	77	60	M22X2.0	SOMT 09...DP/DL/DK/DA D180-D181
2270-25T2-09	27.0	25	40	54	77	56	M16X1.5	
2270-32T2-09	27.0	32	40	54	77	60	M22X2.0	
2275-32T2-09	27.5	32	40	56	79	60	M22X2.0	
2280-25T2-09	28.0	25	40	56	79	56	M16X1.5	
2280-32T2-09	28.0	32	40	56	79	60	M22X2.0	
2285-32T2-09	28.5	32	40	58	81	60	M22X2.0	
2290-25T2-09	29.0	25	40	58	81	56	M16X1.5	
2290-32T2-09	29.0	32	40	58	81	60	M22X2.0	
2295-32T2-09	29.5	32	40	60	83	60	M22X2.0	
2300-32T2-09	30.0	32	40	60	83	60	M22X2.0	
2305-32T2-09	30.5	32	40	62	85	60	M22X2.0	
2310-32T2-09	31.0	32	40	62	85	60	M22X2.0	
2320-32T2-11	32.0	32	40	64	87	60	M22X2.0	
2320-40T2-11	32.0	40	50	64	87	70	M30X2.0	
2330-32T2-11	33.0	32	40	66	89	60	M22X2.0	
2330-40T2-11	33.0	40	50	66	89	70	M30X2.0	
2340-32T2-11	34.0	32	40	68	91	60	M22X2.0	
2340-40T2-11	34.0	40	50	68	91	70	M30X2.0	
2350-32T2-11	35.0	32	40	70	93	60	M22X2.0	
2350-40T2-11	35.0	40	50	70	93	70	M30X2.0	
2360-32T2-11	36.0	32	40	72	95	60	M22X2.0	
2360-40T2-11	36.0	40	50	72	95	70	M30X2.0	
2370-32T2-13	37.0	32	50	74	102	60	M22X2.0	SOMT 13...DP/DL/DK/DA D180-D181
2370-40T2-13	37.0	40	50	74	102	70	M30X2.0	
2380-32T2-13	38.0	32	50	76	104	60	M22X2.0	
2380-40T2-13	38.0	40	50	76	104	70	M30X2.0	
2390-32T2-13	39.0	32	50	78	106	60	M22X2.0	
2390-40T2-13	39.0	40	50	78	106	70	M30X2.0	
2400-32T2-13	40.0	32	50	80	108	60	M22X2.0	
2400-40T2-13	40.0	40	50	80	108	70	M30X2.0	
2410-40T2-13	41.0	40	50	82	110	70	M30X2.0	
2420-40T2-13	42.0	40	50	84	112	70	M30X2.0	
2430-40T2-13	43.0	40	50	86	114	70	M30X2.0	



► OAL: LPR+LS

TOP 2...-T2



Indexable drill holders



- Drilling depth: 2x diameter

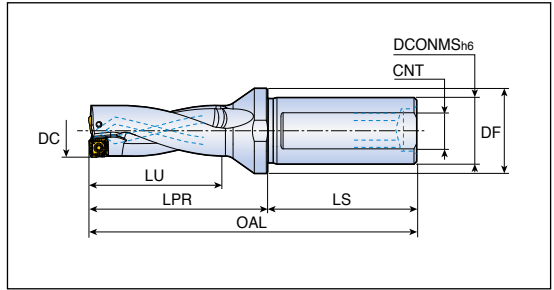

Designation	Dimension (mm)							Insert
	DC	DCONMS	DF	LU	LPR	LS	CNT	
TOP 2440-40T2-15	44.0	40	60	88	123	70	M30X2.0	SOMT 15...DP/DL/DK/DA D180-D181
2450-40T2-15	45.0	40	60	90	125	70	M30X2.0	
2460-40T2-15	46.0	40	60	92	127	70	M30X2.0	
2470-40T2-15	47.0	40	60	94	129	70	M30X2.0	
2480-40T2-15	48.0	40	60	96	131	70	M30X2.0	
2490-40T2-15	49.0	40	60	98	133	70	M30X2.0	
2500-40T2-15	50.0	40	60	100	135	70	M30X2.0	

► OAL: LPR+LS

Spare parts

Designation	Screw	Wrench	Plug*	
TOP 2120 - 2135	TS 18041/HG	TD 6P	SL 20M	
TOP 2140 - 2160	TS 20043/HG-P	TD 6P	SL 20M	
TOP 2165 - 2220	TS 22052/HG-P	TD 7P	SL 25M	
TOP 2225 - 2260	SO 25065I	TD 7	SL 25M / SL 32M	
TOP 2265 - 2360	TS 35088I	TD 10	SL 25M / SL 32M / SL 40M	
TOP 2370 - 2430	TS 40093I	TD 15	SL 32M / SL 40M	
TOP 2440 - 2550	TS 50115I	TD 20	SL 40M	



► * Notice: Cooling hole plug for lathe should be ordered separately
Order example) Plug for shank diameter 25.0mm: SL 25M

TOP 3...-T2



Indexable drill holders



- Drilling depth: 3x diameter

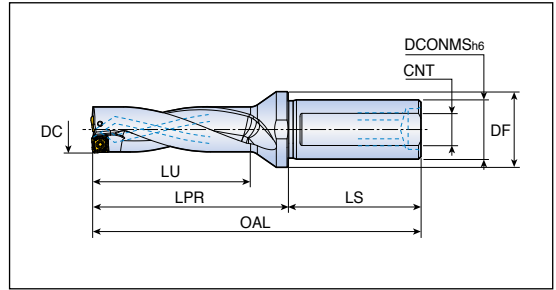

Designation	Dimension (mm)							Insert
	DC	DCONMS	DF	LU	LPR	LS	CNT	
TOP 3120-20T2-04	12.0	20	25	36	56	50	M13X1.0	SOMT 04...DP
3125-20T2-04	12.5	20	25	39	59	50	M13X1.0	D180
3130-20T2-04	13.0	20	25	39	59	50	M13X1.0	
3135-20T2-04	13.5	20	25	42	60	50	M13X1.0	
3140-20T2-05	14.0	20	25	42	60	50	M13X1.0	SOMT 05...DP/DL/DK/DA
3145-20T2-05	14.5	20	25	45	64	50	M13X1.0	D180-D181
3150-20T2-05	15.0	20	25	45	64	50	M13X1.0	
3155-20T2-05	15.5	20	25	48	68	50	M13X1.0	
3160-20T2-05	16.0	20	25	48	68	50	M13X1.0	
3165-25T2-06	16.5	25	32	51	71	56	M16X1.5	SOMT 06...DP/DL/DK/DA
3167-25T2-06 *	16.7	25	32	51	71	56	M16X1.5	D180-D181
3170-25T2-06	17.0	25	32	51	71	56	M16X1.5	
3175-25T2-06	17.5	25	32	54	75	56	M16X1.5	
3180-25T2-06	18.0	25	32	54	75	56	M16X1.5	
3185-25T2-06	18.5	25	32	57	78	56	M16X1.5	
3190-25T2-06	19.0	25	32	57	78	56	M16X1.5	
3195-25T2-07	19.5	25	32	60	83	56	M16X1.5	SOMT 07...DP/DL/DK/DA
3200-25T2-07	20.0	25	32	60	83	56	M16X1.5	D180-D181
3205-25T2-07	20.5	25	32	63	86	56	M16X1.5	
3210-25T2-07	21.0	25	32	63	86	56	M16X1.5	
3215-25T2-07	21.5	25	32	66	89	56	M16X1.5	
3220-25T2-07	22.0	25	32	66	89	56	M16X1.5	
3222-25T2-07 *	22.2	25	32	66	89	56	M16X1.5	
3225-25T2-08	22.5	25	32	69	91	56	M16X1.5	SOMT 08...DP/DL/DK/DA
3230-25T2-08	23.0	25	32	69	91	56	M16X1.5	D180-D181
3230-32T2-08	23.0	32	40	69	91	60	M22X2.0	
3235-25T2-08	23.5	25	32	72	94	56	M16X1.5	
3235-32T2-08	23.5	32	40	72	94	60	M22X2.0	
3240-25T2-08	24.0	25	32	72	94	56	M16X1.5	
3240-32T2-08	24.0	32	40	72	94	60	M22X2.0	
3245-25T2-08	24.5	25	32	75	97	56	M16X1.5	
3245-32T2-08	24.5	32	40	75	97	60	M22X2.0	
3250-25T2-08	25.0	25	32	75	97	56	M16X1.5	
3250-32T2-08	25.0	32	40	75	97	60	M22X2.0	
3254-25T2-08 *	25.4	25	32	75	97	56	M16X1.5	



- ▶ *: Inch sized hole
- ▶ OAL: LPR+LS

Indexable drill holders



- Drilling depth: 3x diameter

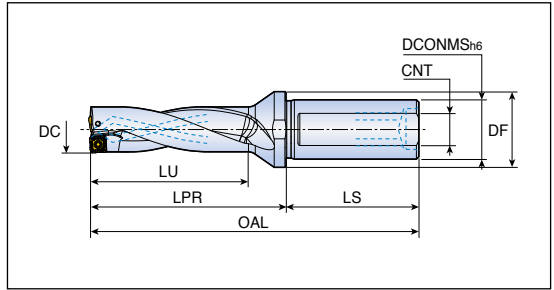

Designation	Dimension (mm)							Insert
	DC	DCONMS	DF	LU	LPR	LS	CNT	
TOP 3255-25T2-08	25.5	25	32	78	99	56	M16X1.5	SOMT 08...DP/DL/DK/DA D180-D181
3255-32T2-08	25.5	32	40	78	99	60	M22X2.0	
3260-25T2-08	26.0	25	32	78	99	56	M16X1.5	SOMT 09...DP/DL/DK/DA D180-D181
3260-32T2-08	26.0	32	32	78	99	60	M22X2.0	
3265-25T2-09	26.5	25	40	81	104	56	M16X1.5	SOMT 09...DP/DL/DK/DA D180-D181
3265-32T2-09	26.5	32	40	81	104	60	M22X2.0	
3270-25T2-09	27.0	25	40	81	104	56	M16X1.5	SOMT 11...DP/DL/DK/DA D180-D181
3270-32T2-09	27.0	32	40	81	104	60	M22X2.0	
3275-25T2-09	27.5	25	40	84	107	56	M16X1.5	SOMT 11...DP/DL/DK/DA D180-D181
3275-32T2-09	27.5	32	40	84	107	60	M22X2.0	
3280-25T2-09	28.0	25	40	84	107	56	M16X1.5	SOMT 13...DP/DL/DK/DA D180-D181
3280-32T2-09	28.0	32	40	84	107	60	M22X2.0	
3285-25T2-09	28.5	25	40	87	110	56	M16X1.5	SOMT 13...DP/DL/DK/DA D180-D181
3285-32T2-09	28.5	32	40	87	110	60	M22X2.0	
3290-25T2-09	29.0	25	40	87	110	56	M16X1.5	SOMT 13...DP/DL/DK/DA D180-D181
3290-32T2-09	29.0	32	40	87	110	60	M22X2.0	
3295-32T2-09	29.5	32	40	90	113	60	M22X2.0	SOMT 13...DP/DL/DK/DA D180-D181
3300-32T2-09	30.0	32	40	90	113	60	M22X2.0	
3305-32T2-09	30.5	32	40	93	116	60	M22X2.0	SOMT 13...DP/DL/DK/DA D180-D181
3310-32T2-09	31.0	32	40	93	116	60	M22X2.0	
3320-32T2-11	32.0	32	40	96	119	60	M22X2.0	SOMT 13...DP/DL/DK/DA D180-D181
3320-40T2-11	32.0	40	50	96	119	70	M30X2.0	
3330-32T2-11	33.0	32	40	99	122	60	M22X2.0	SOMT 13...DP/DL/DK/DA D180-D181
3330-40T2-11	33.0	40	50	99	122	70	M30X2.0	
3340-32T2-11	34.0	32	40	102	125	60	M22X2.0	SOMT 13...DP/DL/DK/DA D180-D181
3340-40T2-11	34.0	40	50	102	125	70	M30X2.0	
3350-32T2-11	35.0	32	40	105	128	60	M22X2.0	SOMT 13...DP/DL/DK/DA D180-D181
3350-40T2-11	35.0	40	50	105	128	70	M30X2.0	
3360-32T2-11	36.0	32	40	108	131	60	M22X2.0	SOMT 13...DP/DL/DK/DA D180-D181
3360-40T2-11	36.0	40	50	108	131	70	M30X2.0	
3370-32T2-13	37.0	32	50	111	139	60	M22X2.0	SOMT 13...DP/DL/DK/DA D180-D181
3370-40T2-13	37.0	40	50	111	139	70	M30X2.0	
3380-32T2-13	38.0	32	50	114	142	60	M22X2.0	SOMT 13...DP/DL/DK/DA D180-D181
3380-40T2-13	38.0	40	50	114	142	70	M30X2.0	
3390-32T2-13	39.0	32	50	117	145	60	M22X2.0	



► OAL: LPR+LS

Indexable drill holders



- Drilling depth: 3x diameter

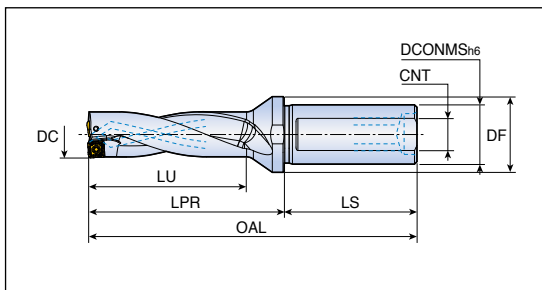

Designation	Dimension (mm)							Insert
	DC	DCONMS	DF	LU	LPR	LS	CNT	
TOP 3390-40T2-13	39.0	40	50	117	145	70	M30X2.0	SOMT 13...DP/DL/DK/DA D180-D181
3400-32T2-13	40.0	32	50	120	148	60	M22X2.0	
3400-40T2-13	40.0	40	50	120	148	70	M30X2.0	
3410-40T2-13	41.0	40	50	123	151	70	M30X2.0	
3420-40T2-13	42.0	40	50	126	154	70	M30X2.0	
3430-40T2-13	43.0	40	50	129	157	70	M30X2.0	
3440-40T2-15	44.0	40	60	132	167	70	M30X2.0	SOMT 15...DP/DL/DK/DA D180-D181
3450-40T2-15	45.0	40	60	135	170	70	M30X2.0	
3460-40T2-15	46.0	40	60	138	173	70	M30X2.0	
3470-40T2-15	47.0	40	60	141	176	70	M30X2.0	
3480-40T2-15	48.0	40	60	144	179	70	M30X2.0	
3490-40T2-15	49.0	40	60	147	182	70	M30X2.0	
3500-40T2-15	50.0	40	60	150	185	70	M30X2.0	

► OAL: LPR+LS

Spare parts

Designation	Screw	Wrench	Plug*	
TOP 3120 - 3135	TS 18041/HG	TD 6P	SL 20M	
TOP 3140 - 3160	TS 200431/HG-P	TD 6P	SL 20M	
TOP 3165 - 3220	TS 220521/HG-P	TD 7P	SL 25M	
TOP 3225 - 3260	SO 250651	TD 7	SL 25M / SL 32M	
TOP 3265 - 3360	TS 350881	TD 10	SL 25M / SL 32M / SL 40M	
TOP 3370 - 3430	TS 400931	TD 15	SL 32M / SL 40M	
TOP 3440 - 3500	TS 501151	TD 20	SL 40M	

► * Notice: Cooling hole plug for lathe should be ordered separately
 Order example) Plug for shank diameter 25.0mm: SL 25M



Indexable drill holders



- Drilling depth: 4x diameter

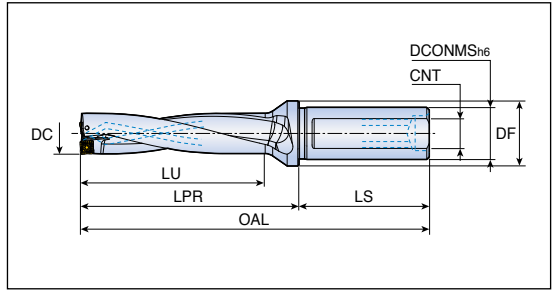

Designation	Dimension (mm)							Insert
	DC	DCONMS	DF	LU	LPR	LS	CNT	
TOP 4120-20T2-04	12.0	20	25	48	68	50	M13X1.0	SOMT 04...DP
4125-20T2-04	12.5	20	25	52	72	50	M13X1.0	D180
4130-20T2-04	13.0	20	25	52	72	50	M13X1.0	
4135-20T2-04	13.5	20	25	56	74	50	M13X1.0	
4140-20T2-05	14.0	20	25	56	74	50	M13X1.0	SOMT 05...DP/DL/DK/DA
4145-20T2-05	14.5	20	25	60	79	50	M13X1.0	D180-D181
4150-20T2-05	15.0	20	25	60	79	50	M13X1.0	
4155-20T2-05	15.5	20	25	64	84	50	M13X1.0	
4160-20T2-05	16.0	20	25	64	84	50	M13X1.0	
4165-25T2-06	16.5	25	32	68	88	56	M16X1.5	SOMT 06...DP/DL/DK/DA
4170-25T2-06	17.0	25	32	68	88	56	M16X1.5	D180-D181
4175-25T2-06	17.5	25	32	72	93	56	M16X1.5	
4180-25T2-06	18.0	25	32	72	93	56	M16X1.5	
4185-25T2-06	18.5	25	32	76	97	56	M16X1.5	
4190-25T2-06	19.0	25	32	76	97	56	M16X1.5	
4195-25T2-07	19.5	25	32	80	103	56	M16X1.5	SOMT 07...DP/DL/DK/DA
4200-25T2-07	20.0	25	32	80	103	56	M16X1.5	D180-D181
4205-25T2-07	20.5	25	32	84	107	56	M16X1.5	
4210-25T2-07	21.0	25	32	84	107	56	M16X1.5	
4215-25T2-07	21.5	25	32	88	111	56	M16X1.5	
4220-25T2-07	22.0	25	32	88	111	56	M16X1.5	
4225-25T2-08	22.5	25	32	92	114	56	M16X1.5	SOMT 08...DP/DL/DK/DA
4230-25T2-08	23.0	25	32	92	114	56	M16X1.5	D180-D181
4230-32T2-08	23.0	32	40	92	114	60	M22X2.0	
4235-25T2-08	23.5	25	32	96	118	56	M16X1.5	
4235-32T2-08	23.5	32	40	96	118	60	M22X2.0	
4240-25T2-08	24.0	25	32	96	118	56	M16X1.5	
4240-32T2-08	24.0	32	40	96	118	60	M22X2.0	
4245-25T2-08	24.5	25	32	100	122	56	M16X1.5	
4245-32T2-08	24.5	32	40	100	122	60	M22X2.0	
4250-25T2-08	25.0	25	32	100	122	56	M16X1.5	
4250-32T2-08	25.0	32	40	100	122	60	M22X2.0	
4254-25T2-08 *	25.4	25	32	100	122	56	M16X1.5	
4255-25T2-08	25.5	25	32	104	125	56	M16X1.5	
4255-32T2-08	25.5	32	40	104	125	60	M22X2.0	



- ▶ *: Inch sized hole
- ▶ OAL: LPR+LS

TOP 4...-T2



Indexable drill holders



- Drilling depth: 4x diameter

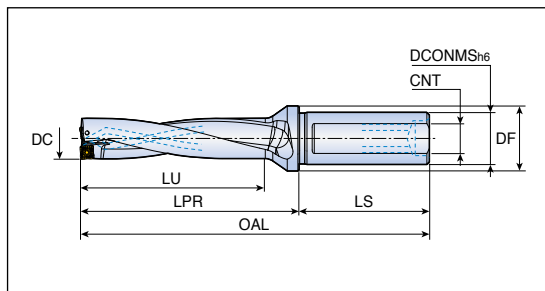

Designation	Dimension (mm)							Insert
	DC	DCONMS	DF	LU	LPR	LS	CNT	
TOP 4260-25T2-08	26.0	25	32	104	125	56	M16X1.5	SOMT 08...DP/DL/DK/DA D180-D181
4260-32T2-08	26.0	32	40	104	125	60	M22X2.0	
4265-25T2-09	26.5	25	40	108	131	56	M16X1.5	
4265-32T2-09	26.5	32	40	108	131	60	M22X2.0	
4270-25T2-09	27.0	25	40	108	131	56	M16X1.5	
4270-32T2-09	27.0	32	40	108	131	60	M22X2.0	
4275-25T2-09	27.5	25	40	112	135	56	M16X1.5	
4275-32T2-09	27.5	32	40	112	135	60	M22X2.0	
4280-25T2-09	28.0	25	40	112	135	56	M16X1.5	
4280-32T2-09	28.0	32	40	112	135	60	M22X2.0	
4285-25T2-09	28.5	25	40	116	139	56	M16X1.5	
4285-32T2-09	28.5	32	40	116	139	60	M22X2.0	
4286-32T2-09 *	28.6	32	40	116	139	60	M22X2.0	
4290-25T2-09	29.0	25	40	116	139	56	M16X1.5	
4290-32T2-09	29.0	32	40	116	139	60	M22X2.0	
4295-32T2-09	29.5	32	40	120	143	60	M22X2.0	
4300-32T2-09	30.0	32	40	120	143	60	M22X2.0	
4305-32T2-09	30.5	32	40	124	147	60	M22X2.0	
4310-32T2-09	31.0	32	40	124	147	60	M22X2.0	
4318-32T2-11 *	31.8	32	40	128	151	60	M22X2.0	SOMT 11...DP/DL/DK/DA D180-D181
4320-32T2-11	32.0	32	40	128	151	60	M22X2.0	
4320-40T2-11	32.0	40	50	128	151	70	M30X2.0	
4330-32T2-11	33.0	32	40	132	155	60	M22X2.0	
4330-40T2-11	33.0	40	50	132	155	70	M30X2.0	
4340-32T2-11	34.0	32	40	136	159	60	M22X2.0	
4340-40T2-11	34.0	40	50	136	159	70	M30X2.0	
4349-40T2-11 *	34.9	40	50	140	163	70	M30X2.0	
4350-32T2-11	35.0	32	40	140	163	60	M22X2.0	
4350-40T2-11	35.0	40	50	140	163	70	M30X2.0	
4360-32T2-11	36.0	32	40	144	167	60	M22X2.0	
4360-40T2-11	36.0	40	50	144	167	70	M30X2.0	
4370-32T2-13	37.0	32	50	148	176	60	M22X2.0	SOMT 13...DP/DL/DK/DA D180-D181
4370-40T2-13	37.0	40	50	148	176	70	M30X2.0	
4371-40T2-13 *	37.1	40	50	148	176	70	M30X2.0	



- ▶ *: Inch sized hole
- ▶ OAL: LPR+LS

Indexable drill holders



- Drilling depth: 4x diameter

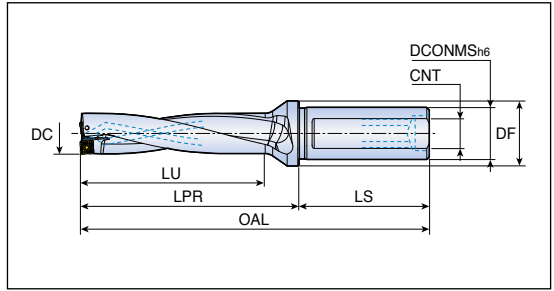

Designation	Dimension (mm)							Insert
	DC	DCONMS	DF	LU	LPR	LS	CNT	
TOP 4380-32T2-13	38.0	32	50	152	180	60	M22X2.0	SOMT 13...DP/DL/DK/DA D180-D181
4380-40T2-13	38.0	40	50	152	180	70	M30X2.0	
4381-40T2-13 *	38.1	40	50	152	180	70	M30X2.0	
4390-32T2-13	39.0	32	50	156	184	60	M22X2.0	
4390-40T2-13	39.0	40	50	156	184	70	M30X2.0	
4400-32T2-13	40.0	32	50	160	188	60	M22X2.0	
4400-40T2-13	40.0	40	50	160	188	70	M30X2.0	
4410-40T2-13	41.0	40	50	164	192	70	M30X2.0	
4413-40T2-13 *	41.3	40	50	164	192	70	M30X2.0	
4420-40T2-13	42.0	40	50	168	196	70	M30X2.0	
4429-40T2-13 *	42.9	40	50	172	200	70	M30X2.0	
4430-40T2-13	43.0	40	50	172	200	70	M30X2.0	
4440-40T2-15	44.0	40	60	176	211	70	M30X2.0	
4445-40T2-15 *	44.5	40	60	180	215	70	M30X2.0	
4450-40T2-15	45.0	40	60	180	215	70	M30X2.0	
4460-40T2-15	46.0	40	60	184	219	70	M30X2.0	
4470-40T2-15	47.0	40	60	188	223	70	M30X2.0	
4476-40T2-15 *	47.6	40	60	192	227	70	M30X2.0	
4480-40T2-15	48.0	40	60	192	227	70	M30X2.0	
4490-40T2-15	49.0	40	60	196	231	70	M30X2.0	
4500-40T2-15	50.0	40	60	200	235	70	M30X2.0	
4508-40T2-15 *	50.8	40	60	204	239	70	M30X2.0	

▶ * Marked items are for inch sized hole

▶ OAL = LPR+LS

Spare parts

Designation	Screw 	Wrench 	Plug* 	
TOP 4120 - 4135	TS 18041/HG	TD 6P	SL 20M	
TOP 4140 - 4160	TS 20043I/HG-P	TD 6P	SL 20M	
TOP 4165 - 4220	TS 22052I/HG-P	TD 7P	SL 25M	
TOP 4225 - 4260	SO 25065I	TD 7	SL 25M / SL 32M	
TOP 4265 - 4360	TS 35088I	TD 10	SL 25M / SL 32M / SL 40M	
TOP 4370 - 4430	TS 40093I	TD 15	SL 32M / SL 40M	
TOP 4440 - 4508	TS 50115I	TD 20	SL 40M	



▶ * Notice: Cooling hole plug for lathe should be ordered separately
Order example) Plug for shank diameter 25.0mm: SL 25M

Indexable drill holders

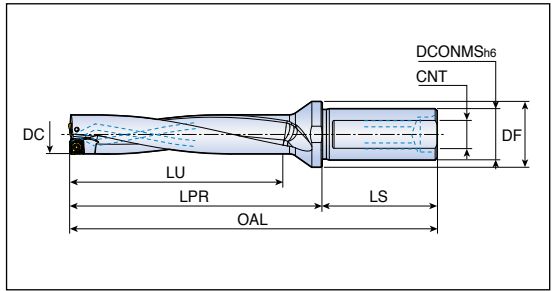

- Drilling depth: 5x diameter



Designation	Dimension (mm)							Insert
	DC	DCONMS	DF	LU	LPR	LS	CNT	
TOP 5120-20T2-04	12.0	20	25	60	80	50	M13X1.0	SOMT 04...DP
5125-20T2-04	12.5	20	25	65	85	50	M13X1.0	D180
5130-20T2-04	13.0	20	25	65	85	50	M13X1.0	
5135-20T2-04	13.5	20	25	70	88	50	M13X1.0	
5140-20T2-05	14.0	20	25	70	88	50	M13X1.0	SOMT 05...DP/DL/DK/DA
5145-20T2-05	14.5	20	25	75	94	50	M13X1.0	D180-D181
5150-20T2-05	15.0	20	25	75	94	50	M13X1.0	
5155-20T2-05	15.5	20	25	80	100	50	M13X1.0	
5160-20T2-05	16.0	20	25	80	100	50	M13X1.0	
5165-25T2-06	16.5	25	32	85	105	56	M16X1.5	SOMT 06...DP/DL/DK/DA
5170-25T2-06	17.0	25	32	85	105	56	M16X1.5	D180-D181
5175-25T2-06	17.5	25	32	90	111	56	M16X1.5	
5180-25T2-06	18.0	25	32	90	111	56	M16X1.5	
5185-25T2-06	18.5	25	32	95	116	56	M16X1.5	
5190-25T2-06	19.0	25	32	95	116	56	M16X1.5	
5195-25T2-07	19.5	25	32	100	123	56	M16X1.5	SOMT 07...DP/DL/DK/DA
5200-25T2-07	20.0	25	32	100	123	56	M16X1.5	D180-D181
5205-25T2-07	20.5	25	32	105	128	56	M16X1.5	
5210-25T2-07	21.0	25	32	105	128	56	M16X1.5	
5215-25T2-07	21.5	25	32	110	133	56	M16X1.5	
5220-25T2-07	22.0	25	32	110	133	56	M16X1.5	
5222-25T2-07 *	22.2	25	32	110	133	56	M16X1.5	
5225-25T2-08	22.5	25	32	115	137	56	M16X1.5	SOMT 08...DP/DL/DK/DA
5230-25T2-08	23.0	25	32	115	137	56	M16X1.5	D180-D181
5230-32T2-08	23.0	32	40	115	137	60	M22X2.0	
5235-25T2-08	23.5	25	32	120	142	56	M16X1.5	
5235-32T2-08	23.5	32	40	120	142	60	M22X2.0	
5240-25T2-08	24.0	25	32	120	142	56	M16X1.5	
5240-32T2-08	24.0	32	40	120	142	60	M22X2.0	
5245-25T2-08	24.5	25	32	125	147	56	M16X1.5	
5245-32T2-08	24.5	32	40	125	147	60	M22X2.0	
5250-25T2-08	25.0	25	32	125	147	56	M16X1.5	
5250-32T2-08	25.0	32	40	125	147	60	M22X2.0	
5255-25T2-08	25.5	25	32	130	151	56	M16X1.5	
5255-32T2-08	25.5	32	40	130	151	60	M22X2.0	



- ▶ *: Inch sized hole
- ▶ OAL: LPR+LS

Indexable drill holders



- Drilling depth: 5x diameter

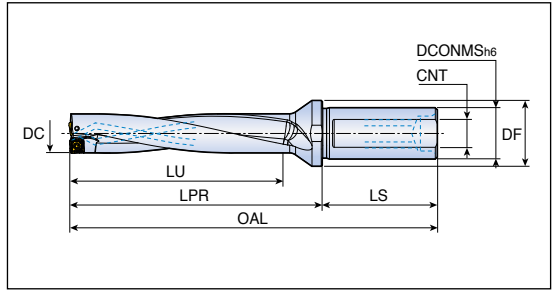

Designation	Dimension (mm)							Insert
	DC	DCONMS	DF	LU	LPR	LS	CNT	
TOP 5260-25T2-08	26.0	25	32	130	151	56	M16X1.5	SOMT 08...DP/DL/DK/DA
5260-32T2-08	26.0	32	40	130	151	60	M22X2.0	D180-D181
5265-32T2-09	26.5	32	40	135	158	60	M22X2.0	SOMT 09...DP/DL/DK/DA
5270-25T2-09	27.0	25	40	135	158	56	M16X1.5	D180-D181
5270-32T2-09	27.0	32	40	135	158	60	M22X2.0	
5275-32T2-09	27.5	32	40	140	163	60	M22X2.0	
5280-25T2-09	28.0	25	40	140	163	56	M16X1.5	
5280-32T2-09	28.0	32	40	140	163	60	M22X2.0	
5282-32T2-09 *	28.2	32	40	140	163	60	M22X2.0	
5285-32T2-09	28.5	32	40	145	168	60	M22X2.0	
5290-25T2-09	29.0	25	40	145	168	56	M16X1.5	
5290-32T2-09	29.0	32	40	145	168	60	M22X2.0	
5295-32T2-09	29.5	32	40	150	173	60	M22X2.0	
5300-32T2-09	30.0	32	40	150	173	60	M22X2.0	
5305-32T2-09	30.5	32	40	155	178	60	M22X2.0	
5310-32T2-09	31.0	32	40	155	178	60	M22X2.0	
5320-32T2-11	32.0	32	40	160	183	60	M22X2.0	SOMT 11...DP/DL/DK/DA
5320-40T2-11	32.0	40	50	160	183	70	M30X2.0	D180-D181
5330-32T2-11	33.0	32	40	165	188	60	M22X2.0	
5330-40T2-11	33.0	40	50	165	188	70	M30X2.0	
5340-32T2-11	34.0	32	40	170	193	60	M22X2.0	
5340-40T2-11	34.0	40	50	170	193	70	M30X2.0	
5350-32T2-11	35.0	32	40	175	198	60	M22X2.0	
5350-40T2-11	35.0	40	50	175	198	70	M30X2.0	
5360-32T2-11	36.0	32	40	180	203	60	M22X2.0	
5360-40T2-11	36.0	40	50	180	203	70	M30X2.0	
5370-32T2-13	37.0	32	50	185	213	60	M22X2.0	SOMT 13...DP/DL/DK/DA
5370-40T2-13	37.0	40	50	185	213	70	M30X2.0	D180-D181
5380-32T2-13	38.0	32	50	190	218	60	M22X2.0	
5380-40T2-13	38.0	40	50	190	218	70	M30X2.0	
5390-32T2-13	39.0	32	50	195	223	60	M22X2.0	
5390-40T2-13	39.0	40	50	195	223	70	M30X2.0	
5400-32T2-13	40.0	32	50	200	228	60	M22X2.0	
5400-40T2-13	40.0	40	50	200	228	70	M30X2.0	



- ▶ *: Inch sized hole
- ▶ OAL: LPR+LS

Indexable drill holders



- Drilling depth: 5x diameter

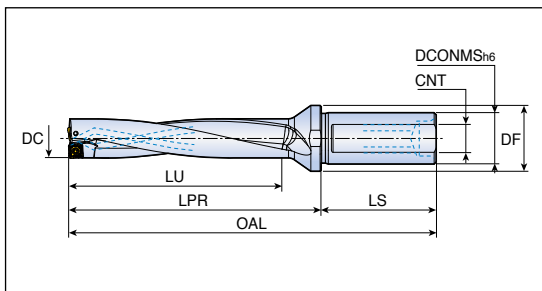

Designation	Dimension (mm)							Insert
	DC	DCONMS	DF	LU	LPR	LS	CNT	
TOP 5410-40T2-13	41.0	40	50	205	233	70	M30X2.0	SOMT 13...DP/DL/DK/DA
5420-40T2-13	42.0	40	50	210	238	70	M30X2.0	D180-D181
5430-40T2-13	43.0	40	50	215	243	70	M30X2.0	
5440-40T2-15	44.0	40	60	220	255	70	M30X2.0	SOMT 15...DP/DL/DK/DA
5450-40T2-15	45.0	40	60	225	260	70	M30X2.0	D180-D181
5460-40T2-15	46.0	40	60	230	265	70	M30X2.0	
5470-40T2-15	47.0	40	60	235	270	70	M30X2.0	
5480-40T2-15	48.0	40	60	240	275	70	M30X2.0	
5490-40T2-15	49.0	40	60	245	280	70	M30X2.0	
5500-40T2-15	50.0	40	60	250	285	70	M30X2.0	

► OAL: LPR+LS

Spare parts

Designation	Screw	Wrench	Plug*	
TOP 5120 - 5135	TS 18041/HG	TD 6P	SL 20M	
TOP 5140 - 5160	TS 200431/HG-P	TD 6P	SL 20M	
TOP 5165 - 5220	TS 220521/HG-P	TD 7P	SL 25M	
TOP 5225 - 5260	SO 25065I	TD 7	SL 25M / SL 32M	
TOP 5265 - 5360	TS 35088I	TD 10	SL 25M / SL 32M / SL 40M	
TOP 5370 - 5430	TS 40093I	TD 15	SL 32M / SL 40M	
TOP 5440 - 5500	TS 50115I	TD 20	SL 40M	



► * Notice: Cooling hole plug for lathe should be ordered separately
 Order example) Plug for shank diameter 25.0mm: SL 25M

TOP 20...CA



Indexable drill holders for cartridge



- Drilling depth: 2x diameter

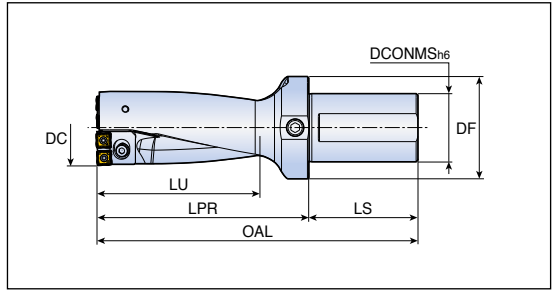

Designation	Dimension (mm)							Setting Plate	Insert
	DC	DCONMS	DF	OAL	LU	LPR	LS		
TOP 2051-55-50T2-09CA	51	50	64	223	110	143	80	-	SOMT 09...
	52	50	64	223	110	143	80	TOP-0901	DP/DL/DK/DA
	53	50	64	223	110	143	80	TOP-0902	D180-D181
	54	50	64	223	110	143	80	TOP-0903	
	55	50	64	223	110	143	80	TOP-0904	
TOP 2056-60-50T2-11CA	56	50	64	236	120	156	80	-	SOMT 11...
	57	50	64	236	120	156	80	TOP-0901	DP/DL/DK/DA
	58	50	64	236	120	156	80	TOP-0902	D180-D181
	59	50	64	236	120	156	80	TOP-0903	
	60	50	64	236	120	156	80	TOP-0904	
TOP 2061-65-50T2-11CA	61	50	69	249	130	169	80	-	SOMT 11...
	62	50	69	249	130	169	80	TOP-0901	DP/DL/DK/DA
	63	50	69	249	130	169	80	TOP-0902	D180-D181
	64	50	69	249	130	169	80	TOP-0903	
	65	50	69	249	130	169	80	TOP-0904	
TOP 2066-70-50T2-11CA	66	50	69	262	140	182	80	-	SOMT 11...
	67	50	69	262	140	182	80	TOP-0901	DP/DL/DK/DA
	68	50	69	262	140	182	80	TOP-0902	D180-D181
	69	50	69	262	140	182	80	TOP-0903	
	70	50	69	262	140	182	80	TOP-0904	
TOP 2071-75-50T2-13CA	71	50	74	275	150	195	80	-	SOMT 13...
	72	50	74	275	150	195	80	TOP-0901	DP/DL/DK/DA
	73	50	74	275	150	195	80	TOP-0902	D180-D181
	74	50	74	275	150	195	80	TOP-0903	
	75	50	74	275	150	195	80	TOP-0904	
TOP 2076-80-50T2-13CA	76	50	74	288	160	208	80	-	SOMT 13...
	77	50	74	288	160	208	80	TOP-0901	DP/DL/DK/DA
	78	50	74	288	160	208	80	TOP-0902	D180-D181
	79	50	74	288	160	208	80	TOP-0903	
	80	50	74	288	160	208	80	TOP-0904	



► OAL: LPR+LS

TOP 30...CA



Indexable drill holders for cartridge



- Drilling depth: 3xdiameter

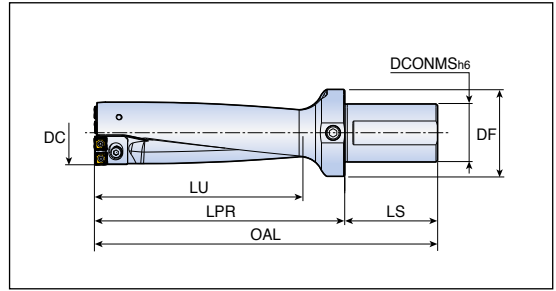

Designation	Dimension (mm)							Setting Plate	Insert
	DC	DCONMS	DF	OAL	LU	LPR	LS		
TOP 3051-55-50T2-09CA	51	50	64	278	165	198	80	-	SOMT 09...
	52	50	64	278	165	198	80	TOP-0901	DP/DL/DK/DA
	53	50	64	278	165	198	80	TOP-0902	D180-D181
	54	50	64	278	165	198	80	TOP-0903	
	55	50	64	278	165	198	80	TOP-0904	
TOP 3056-60-50T2-11CA	56	50	64	296	180	216	80	-	SOMT 11...
	57	50	64	296	180	216	80	TOP-0901	DP/DL/DK/DA
	58	50	64	296	180	216	80	TOP-0902	D180-D181
	59	50	64	296	180	216	80	TOP-0903	
	60	50	64	296	180	216	80	TOP-0904	
TOP 3061-65-50T2-11CA	61	50	69	314	195	234	80	-	SOMT 11...
	62	50	69	314	195	234	80	TOP-0901	DP/DL/DK/DA
	63	50	69	314	195	234	80	TOP-0902	D180-D181
	64	50	69	314	195	234	80	TOP-0903	
	65	50	69	314	195	234	80	TOP-0904	
TOP 3066-70-50T2-11CA	66	50	69	332	210	252	80	-	SOMT 11...
	67	50	69	332	210	252	80	TOP-0901	DP/DL/DK/DA
	68	50	69	332	210	252	80	TOP-0902	D180-D181
	69	50	69	332	210	252	80	TOP-0903	
	70	50	69	332	210	252	80	TOP-0904	
TOP 3071-75-50T2-13CA	71	50	74	350	225	270	80	-	SOMT 13...
	72	50	74	350	225	270	80	TOP-0901	DP/DL/DK/DA
	73	50	74	350	225	270	80	TOP-0902	D180-D181
	74	50	74	350	225	270	80	TOP-0903	
	75	50	74	350	225	270	80	TOP-0904	
TOP 3076-80-50T2-13CA	76	50	74	368	240	288	80	-	SOMT 13...
	77	50	74	368	240	288	80	TOP-0901	DP/DL/DK/DA
	78	50	74	368	240	288	80	TOP-0902	D180-D181
	79	50	74	368	240	288	80	TOP-0903	
	80	50	74	368	240	288	80	TOP-0904	

Cutting Condition ▶ OAL: LPR+LS

D230

TOP 40...CA



Indexable drill holders for cartridge



• Drilling depth: 4x diameter

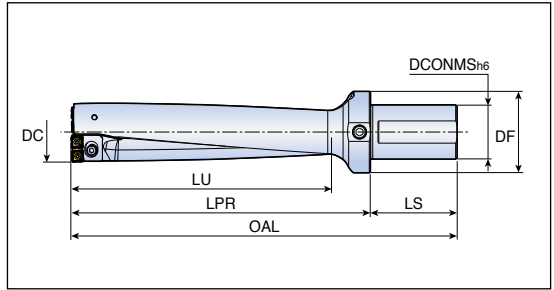



Designation	Dimension (mm)							Setting Plate	Insert
	DC	DCONMS	DF	OAL	LU	LPR	LS		
TOP 4051-55-50T2-09CA	51	50	64	333	220	253	80	-	SOMT 09...
	52	50	64	333	220	253	80	TOP-0901	DP/DL/DK/DA
	53	50	64	333	220	253	80	TOP-0902	D180-D181
	54	50	64	333	220	253	80	TOP-0903	
	55	50	64	333	220	253	80	TOP-0904	
TOP 4056-60-50T2-11CA	56	50	64	356	240	276	80	-	SOMT 11...
	57	50	64	356	240	276	80	TOP-0901	DP/DL/DK/DA
	58	50	64	356	240	276	80	TOP-0902	D180-D181
	59	50	64	356	240	276	80	TOP-0903	
	60	50	64	356	240	276	80	TOP-0904	
TOP 4061-65-50T2-11CA	61	50	69	379	260	299	80	-	SOMT 11...
	62	50	69	379	260	299	80	TOP-0901	DP/DL/DK/DA
	63	50	69	379	260	299	80	TOP-0902	D180-D181
	64	50	69	379	260	299	80	TOP-0903	
	65	50	69	379	260	299	80	TOP-0904	
TOP 4066-70-50T2-11CA	66	50	69	402	280	322	80	-	SOMT 11...
	67	50	69	402	280	322	80	TOP-0901	DP/DL/DK/DA
	68	50	69	402	280	322	80	TOP-0902	D180-D181
	69	50	69	402	280	322	80	TOP-0903	
	70	50	69	402	280	322	80	TOP-0904	
TOP 4071-75-50T2-13CA	71	50	74	425	300	345	80	-	SOMT 13...
	72	50	74	425	300	345	80	TOP-0901	DP/DL/DK/DA
	73	50	74	425	300	345	80	TOP-0902	D180-D181
	74	50	74	425	300	345	80	TOP-0903	
	75	50	74	425	300	345	80	TOP-0904	
TOP 4076-80-50T2-13CA	76	50	74	448	320	368	80	-	SOMT 13...
	77	50	74	448	320	368	80	TOP-0901	DP/DL/DK/DA
	78	50	74	448	320	368	80	TOP-0902	D180-D181
	79	50	74	448	320	368	80	TOP-0903	
	80	50	74	448	320	368	80	TOP-0904	



► OAL: LPR+LS

Indexable drill holders for cartridge

Spare parts

Designation	Screw	Cartridge for peripheral	Cartridge for center
			
TOP ..51-55-50T2-09CA	TS 35088I	TOP 09CA-P1	TOP 09CA-C1
TOP ..56-60-50T2-11CA	TS 35088I	TOP 11CA-P1	TOP 11CA-C1
TOP ..61-65-50T2-11CA	TS 35088I	TOP 11CA-P2	TOP 11CA-C2
TOP ..66-70-50T2-11CA	TS 35088I	TOP 11CA-P3	TOP 11CA-C3
TOP ..71-75-50T2-13CA	TS 40093I	TOP 13CA-P1	TOP 13CA-C1
TOP ..76-80-50T2-13CA	TS 40093I	TOP 13CA-P2	TOP 13CA-C2

Spare parts for cartridge

Designation	Cartridge clamping screw	Washer	Setting plate screw
TOP 09CA-P1	SH M4x0.7x16	MW 4.3x8	TS 20043I/HG-P
TOP 09CA-C1	SH M4x0.7x16	MW 4.3x8	-
TOP 11CA-P1	SH M5x0.8x16	MW 5.5x10	TS 20043I/HG-P
TOP 11CA-C1	SH M5x0.8x16	MW 5.5x10	-
TOP 11CA-P2	SH M5x0.8x16	MW 5.5x10	TS 20043I/HG-P
TOP 11CA-C2	SH M5x0.8x16	MW 5.5x10	-
TOP 11CA-P3	SH M5x0.8x16	MW 5.5x10	TS 20043I/HG-P
TOP 11CA-C3	SH M5x0.8x16	MW 5.5x10	-
TOP 13CA-P1	SH M6x1.0x20	MW 6.4x12	TS 20043I/HG-P
TOP 13CA-C1	SH M6x1.0x20	MW 6.4x12	-
TOP 13CA-P2	SH M6x1.0x20	MW 6.4x12	TS 20043I/HG-P
TOP 13CA-C2	SH M6x1.0x20	MW 6.4x12	-

TDR 2...-T2



Indexable drill holders



- Drilling depth: 2x diameter

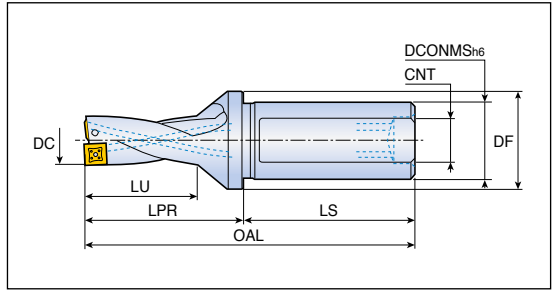

Designation	Dimension (mm)							Insert
	DC	DCONMS	DF	LU	LPR	LS	CNT	
TDR 2125-20T2-05	12.5	20	25	26	44	50	M13X1.0	SPMG 05...
2130-20T2-05	13.0	20	25	26	44	50	M13X1.0	DG/DK
2135-20T2-05	13.5	20	25	28	46	50	M13X1.0	SPGG 05..DA
2140-20T2-05	14.0	20	25	28	46	50	M13X1.0	D182-D183
2145-20T2-05	14.5	20	25	30	49	50	M13X1.0	
2150-20T2-05	15.0	20	25	30	49	50	M13X1.0	
2155-25T2-06	15.5	25	32	32	52	56	M16X1.5	SPMG 06...
2160-25T2-06	16.0	25	32	32	52	56	M16X1.5	DG/DK
2165-25T2-06	16.5	25	32	34	54	56	M16X1.5	SPGG 06..DA
2170-25T2-06	17.0	25	32	34	54	56	M16X1.5	D182-D183
2175-25T2-06	17.5	25	32	36	57	56	M16X1.5	
2180-25T2-06	18.0	25	32	36	57	56	M16X1.5	
2185-25T2-06	18.5	25	32	38	59	56	M16X1.5	
2190-25T2-06	19.0	25	32	38	59	56	M16X1.5	
2195-25T2-06	19.5	25	32	40	63	56	M16X1.5	
2200-25T2-06	20.0	25	32	40	63	56	M16X1.5	
2205-25T2-06	20.5	25	32	42	65	56	M16X1.5	
2210-25T2-06	21.0	25	32	42	65	56	M16X1.5	
2215-25T2-06	21.5	25	32	44	67	56	M16X1.5	
2220-25T2-07	22.0	25	32	44	67	56	M16X1.5	SPMG 07...
2225-25T2-07	22.5	25	32	46	71	56	M16X1.5	DG/DK
2225-32T2-07	22.5	32	40	46	71	60	M22X2.0	SPGG 07..DA
2230-25T2-07	23.0	25	32	46	71	56	M16X1.5	D182-D183
2230-32T2-07	23.0	32	40	46	71	60	M22X2.0	
2235-25T2-07	23.5	25	32	48	74	56	M16X1.5	
2235-32T2-07	23.5	32	40	48	74	60	M22X2.0	
2240-25T2-07	24.0	25	32	48	74	56	M16X1.5	
2240-32T2-07	24.0	32	40	48	74	60	M22X2.0	
2245-25T2-07	24.5	25	32	50	77	56	M16X1.5	
2245-32T2-07	24.5	32	40	50	77	60	M22X2.0	
2250-25T2-07	25.0	25	32	50	77	56	M16X1.5	
2250-32T2-07	25.0	32	40	50	77	60	M22X2.0	
2255-25T2-07	25.5	25	32	52	79	56	M16X1.5	
2255-32T2-07	25.5	32	40	52	79	60	M22X2.0	
2260-25T2-07	26.0	25	32	52	79	56	M16X1.5	



► OAL: LPR+LS

TDR 2...-T2



Indexable drill holders



- Drilling depth: 2x diameter

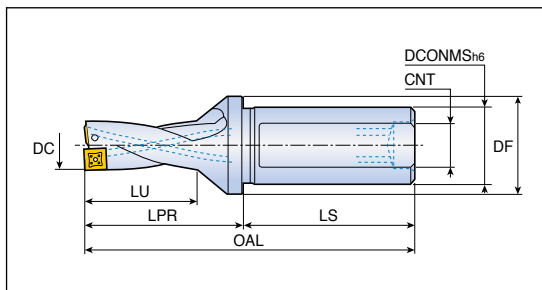

Designation	Dimension (mm)							Insert
	DC	DCONMS	DF	LU	LPR	LS	CNT	
TDR 2260-32T2-07	26.0	32	40	52	79	60	M22X2.0	SPMG 07... DG/DK SPGG 07..DA D182-D183
2265-25T2-07	26.5	25	32	54	81	56	M16X1.5	
2265-32T2-07	26.5	32	40	54	81	60	M22X2.0	
2270-25T2-07	27.0	25	32	54	81	56	M16X1.5	
2270-32T2-07	27.0	32	40	54	81	60	M22X2.0	
2275-25T2-07	27.5	25	32	56	84	56	Rc 1/8	
2275-32T2-07	27.5	32	40	56	84	60	Rc 1/4	SPMG 09... DG/DK SPGG 09..DA D182-D183
2280-25T2-09	28.0	25	40	56	84	56	Rc 1/8	
2280-32T2-09	28.0	32	40	56	84	60	Rc 1/4	
2285-25T2-09	28.5	25	40	58	86	56	Rc 1/8	
2285-32T2-09	28.5	32	40	58	86	60	Rc 1/4	
2290-25T2-09	29.0	25	40	58	86	56	Rc 1/8	
2290-32T2-09	29.0	32	40	58	86	60	Rc 1/4	
2295-32T2-09	29.5	32	40	60	91	60	Rc 1/4	
2295-40T2-09	29.5	40	50	60	91	70	Rc 1/4	
2300-32T2-09	30.0	32	40	60	91	60	Rc 1/4	
2300-40T2-09	30.0	40	50	60	91	70	Rc 1/4	
2305-32T2-09	30.5	32	40	62	94	60	Rc 1/4	
2305-40T2-09	30.5	40	50	62	94	70	Rc 1/4	
2310-32T2-09	31.0	32	40	62	94	60	Rc 1/4	
2310-40T2-09	31.0	40	50	62	94	70	Rc 1/4	
2315-32T2-09	31.5	32	40	64	96	60	Rc 1/4	
2315-40T2-09	31.5	40	50	64	96	70	Rc 1/4	
2320-32T2-09	32.0	32	40	64	96	60	Rc 1/4	
2320-40T2-09	32.0	40	50	64	96	70	Rc 1/4	
2325-32T2-09	32.5	32	40	66	99	60	Rc 1/4	
2325-40T2-09	32.5	40	50	66	99	70	Rc 1/4	
2330-32T2-09	33.0	32	40	66	99	60	Rc 1/4	
2330-40T2-09	33.0	40	50	66	99	70	Rc 1/4	
2340-32T2-11	34.0	32	50	68	101	60	Rc 1/4	SPMG 11... DG/DK SPGG 11..DA D182-D183
2340-40T2-11	34.0	40	55	68	101	70	Rc 1/4	
2350-32T2-11	35.0	32	50	70	104	60	Rc 1/4	
2350-40T2-11	35.0	40	55	70	104	70	Rc 1/4	
2360-32T2-11	36.0	32	50	72	107	60	Rc 1/4	
2360-40T2-11	36.0	40	55	72	107	70	Rc 1/4	

► OAL: LPR+LS



TDR 2...-T2



Indexable drill holders



- Drilling depth: 2x diameter

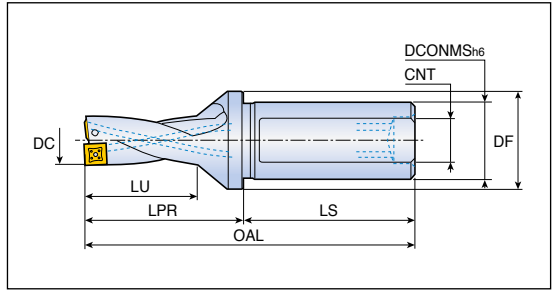

Designation	Dimension (mm)							Insert
	DC	DCONMS	DF	LU	LPR	LS	CNT	
TDR 2370-32T2-11	37.0	32	50	74	110	60	Rc 1/4	SPMG 11... DG/DK SPGG 11..DA D182-D183
2370-40T2-11	37.0	40	55	74	110	70	Rc 1/4	
2380-32T2-11	38.0	32	50	76	113	60	Rc 1/4	
2380-40T2-11	38.0	40	55	76	113	70	Rc 1/4	
2390-32T2-11	39.0	32	50	78	115	60	Rc 1/4	
2390-40T2-11	39.0	40	55	78	115	70	Rc 1/4	
2400-32T2-11	40.0	32	50	80	118	60	Rc 1/4	
2400-40T2-11	40.0	40	55	80	118	70	Rc 1/4	
2410-40T2-11	41.0	40	55	82	121	70	Rc 1/4	
2420-40T2-14	42.0	40	60	84	123	70	Rc 1/4	
2430-40T2-14	43.0	40	60	86	126	70	Rc 1/4	
2440-40T2-14	44.0	40	60	88	128	70	Rc 1/4	
2450-40T2-14	45.0	40	60	90	132	70	Rc 1/4	
2460-40T2-14	46.0	40	60	92	135	70	Rc 1/4	
2470-40T2-14	47.0	40	60	94	137	70	Rc 1/4	
2480-40T2-14	48.0	40	60	96	140	70	Rc 1/4	
2490-40T2-14	49.0	40	60	98	142	70	Rc 1/4	
2500-40T2-14	50.0	40	60	100	145	70	Rc 1/4	

► OAL: LPR+LS

Spare parts

Designation	Screw	Wrench	Plug*	
TDR 2125 - 2150	TS 20043I/HG-P	TD 6P	SL 20 M	
TDR 2155 - 2215	TS 22052I/HG	TD 7	SL 25 M	
TDR 2220 - 2270	TS 25064I	TD 8	SL 25 M / SL 32 M	
TDR 2275	TS 25064I	TD 8	-	
TDR 2280 - 2330	TS 35088I	TD 10	-	
TDR 2340 - 2390	TS 40093I	TD 15	-	
TDR 2400 - 2410	TS 40093I	TD 15	-	
TDR 2420 - 2500	SO 50090I	TD 20	-	



- * Notice: Cooling hole plug for lathe should be ordered separately
Order example) Plug for shank diameter 25.0mm: SL 25M

TDR 3...-T2



Indexable drill holders



- Drilling depth: 3x diameter

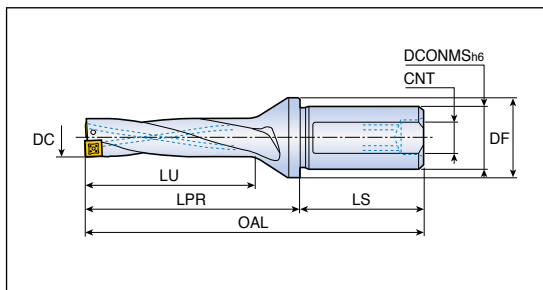

Designation	Dimension (mm)							Insert
	DC	DCONMS	DF	LU	LPR	LS	CNT	
TDR 3125-20T2-05	12.5	20	25	39	57	50	M13X1.0	SPMG 05...
3130-20T2-05	13.0	20	25	39	57	50	M13X1.0	DG/DK
3135-20T2-05	13.5	20	25	42	60	50	M13X1.0	SPGG 05..DA
3140-20T2-05	14.0	20	25	42	60	50	M13X1.0	D182-D183
3145-20T2-05	14.5	20	25	45	64	50	M13X1.0	
3150-20T2-05	15.0	20	25	45	64	50	M13X1.0	
3155-25T2-06	15.5	25	32	48	68	56	M16X1.5	SPMG 06...
3160-25T2-06	16.0	25	32	48	68	56	M16X1.5	DG/DK
3165-25T2-06	16.5	25	32	51	71	56	M16X1.5	SPGG 06..DA
3170-25T2-06	17.0	25	32	51	71	56	M16X1.5	D182-D183
3175-25T2-06	17.5	25	32	54	75	56	M16X1.5	
3180-25T2-06	18.0	25	32	54	75	56	M16X1.5	
3185-25T2-06	18.5	25	32	57	78	56	M16X1.5	
3190-25T2-06	19.0	25	32	57	78	56	M16X1.5	
3195-25T2-06	19.5	25	32	60	83	56	M16X1.5	
3200-25T2-06 *	20.0	25	32	60	83	56	M16X1.5	
3205-25T2-06	20.5	25	32	63	86	56	M16X1.5	
3209-25T2-06 *	20.9	25	32	63	86	56	M16X1.5	
3210-25T2-06	21.0	25	32	63	86	56	M16X1.5	
3215-25T2-06	21.5	25	32	66	89	56	M16X1.5	
3220-25T2-07	22.0	25	32	66	89	56	M16X1.5	SPMG 07...
3225-25T2-07	22.5	25	32	69	94	56	M16X1.5	DG/DK
3225-32T2-07	22.5	32	40	69	94	60	M22X2.0	SPGG 07..DA
3230-25T2-07	23.0	25	32	69	94	56	M16X1.5	D182-D183
3230-32T2-07	23.0	32	40	69	94	60	M22X2.0	
3235-25T2-07	23.5	25	32	72	98	56	M16X1.5	
3235-32T2-07	23.5	32	40	72	98	60	M22X2.0	
3239-25T2-07 *	23.9	25	32	72	98	56	M16X1.5	
3239-32T2-07 *	23.9	32	45	72	98	60	M22X2.0	
3240-25T2-07	24.0	25	32	72	98	56	M16X1.5	
3240-32T2-07	24.0	32	40	72	98	60	M22X2.0	
3245-25T2-07	24.5	25	32	75	102	56	M16X1.5	
3245-32T2-07	24.5	32	40	75	102	60	M22X2.0	
3250-25T2-07	25.0	25	32	75	102	56	M16X1.5	
3250-32T2-07	25.0	32	40	75	102	60	M22X2.0	



- ▶ *: Pre-thread hole making
- ▶ OAL: LPR+LS

TDR 3...-T2



Indexable drill holders



- Drilling depth: 3xdiameter

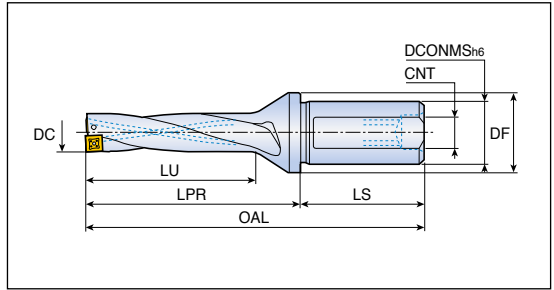

Designation	Dimension (mm)							Insert
	DC	DCONMS	DF	LU	LPR	LS	CNT	
TDR 3255-25T2-07	25.5	25	32	78	105	56	M16X1.5	SPMG 07... DG/DK SPGG 07..DA D182-D183
3255-32T2-07	25.5	32	40	78	105	60	M22X2.0	
3260-25T2-07	26.0	25	32	78	105	56	M16X1.5	
3260-32T2-07	26.0	32	40	78	105	60	M22X2.0	
3264-25T2-07 *	26.4	25	45	81	108	56	M16X1.5	
3264-32T2-07 *	26.4	32	45	81	108	60	M22X2.0	
3265-25T2-07	26.5	25	32	81	108	56	M16X1.5	
3265-32T2-07	26.5	32	40	81	108	60	M22X2.0	
3270-25T2-07	27.0	25	32	81	108	56	M16X1.5	
3270-32T2-07	27.0	32	40	81	108	60	M22X2.0	
3275-25T2-07	27.5	25	32	84	112	56	Rc 1/8	
3275-32T2-07	27.5	32	40	84	112	60	Rc 1/4	
3280-25T2-09	28.0	25	40	84	112	56	Rc 1/8	SPMG 09... DG/DK SPGG 09..DA D182-D183
3280-32T2-09	28.0	32	40	84	112	60	Rc 1/4	
3285-25T2-09	28.5	25	40	87	115	56	Rc 1/8	
3285-32T2-09	28.5	32	40	87	115	56	Rc 1/4	
3290-25T2-09	29.0	25	40	87	115	56	Rc 1/8	
3290-32T2-09	29.0	32	40	87	115	60	Rc 1/4	
3294-32T2-09 *	29.4	32	55	90	121	60	Rc 1/4	
3294-40T2-09 *	29.4	40	55	90	121	70	Rc 1/4	
3295-32T2-09	29.5	32	40	90	121	60	Rc 1/4	
3295-40T2-09	29.5	40	50	90	121	70	Rc 1/4	
3300-32T2-09	30.0	32	40	90	121	60	Rc 1/4	
3300-40T2-09	30.0	40	50	90	121	70	Rc 1/4	
3305-32T2-09	30.5	32	40	93	125	60	Rc 1/4	
3305-40T2-09	30.5	40	50	93	125	70	Rc 1/4	
3310-32T2-09	31.0	32	40	93	125	60	Rc 1/4	
3310-40T2-09	31.0	40	50	93	125	70	Rc 1/4	
3315-32T2-09	31.5	32	40	96	128	60	Rc 1/4	
3315-40T2-09	31.5	40	50	96	128	70	Rc 1/4	
3320-32T2-09	32.0	32	40	96	128	60	Rc 1/4	
3320-40T2-09	32.0	40	50	96	128	70	Rc 1/4	



- ▶ *: Pre-thread hole making
- ▶ OAL: LPR+LS

TDR 3...-T2

Indexable drill holders

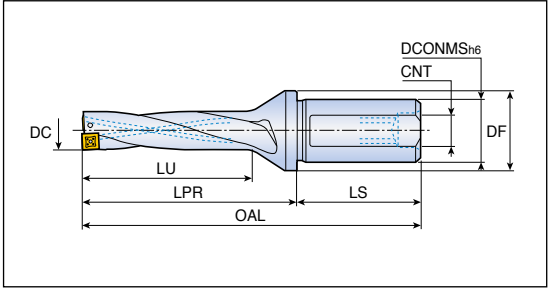

• Drilling depth: 3xdiameter



Designation	Dimension (mm)							Insert
	DC	DCONMS	DF	LU	LPR	LS	CNT	
TDR 3325-32T2-09	32.5	32	40	99	132	60	Rc 1/4	SPMG 09...
3325-40T2-09	32.5	40	50	99	132	70	Rc 1/4	DG/DK
3330-32T2-09	33.0	32	40	99	132	60	Rc 1/4	SPGG 09..DA
3330-40T2-09	33.0	40	50	99	132	70	Rc 1/4	D182-D183
3340-32T2-11	34.0	32	50	102	135	60	Rc 1/4	SPMG 11...
3340-40T2-11	34.0	40	55	102	135	70	Rc 1/4	DG/DK
3350-32T2-11	35.0	32	50	105	139	60	Rc 1/4	SPGG 09..DA
3350-40T2-11	35.0	40	55	105	139	70	Rc 1/4	D182-D183
3360-32T2-11	36.0	32	50	108	143	60	Rc 1/4	
3360-40T2-11	36.0	40	55	108	143	70	Rc 1/4	
3370-32T2-11	37.0	32	50	111	147	60	Rc 1/4	
3370-40T2-11	37.0	40	55	111	147	70	Rc 1/4	
3375-32T2-11 *	37.5	32	55	114	151	60	Rc 1/4	
3375-40T2-11 *	37.5	40	55	114	151	70	Rc 1/4	
3380-32T2-11	38.0	32	50	114	151	60	Rc 1/4	
3380-40T2-11	38.0	40	55	114	151	70	Rc 1/4	
3390-32T2-11	39.0	32	50	117	154	60	Rc 1/4	
3390-40T2-11	39.0	40	55	117	154	70	Rc 1/4	
3400-32T2-11	40.0	32	50	120	158	60	Rc 1/4	
3400-40T2-11	40.0	40	55	120	158	70	Rc 1/4	
3405-40T2-11 *	40.5	40	60	123	162	70	Rc 1/4	
3410-40T2-11	41.0	40	55	123	162	70	Rc 1/4	



► *: Pre-thread hole making
 ► OAL: LPR+LS

TDR 3...-T2



Indexable drill holders



- Drilling depth: 3xdiameter

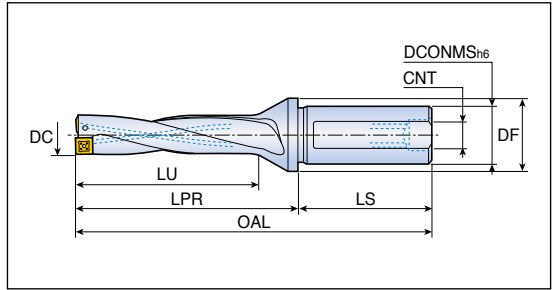

Designation	Dimension (mm)							Insert
	DC	DCONMS	DF	LU	LPR	LS	CNT	
TDR 3420-40T2-14	42.0	40	60	126	165	70	Rc 1/4	SPMG 14...
3430-40T2-14	43.0	40	60	129	169	70	Rc 1/4	DG/DK
3440-40T2-14	44.0	40	60	132	172	70	Rc 1/4	SPGG 14..DA
3450-40T2-14	45.0	40	60	135	177	70	Rc 1/4	D182-D183
3460-40T2-14	46.0	40	60	138	181	70	Rc 1/4	
3470-40T2-14	47.0	40	60	141	184	70	Rc 1/4	
3480-40T2-14	48.0	40	60	144	188	70	Rc 1/4	
3490-40T2-14	49.0	40	60	147	191	70	Rc 1/4	
3500-40T2-14	50.0	40	60	150	195	70	Rc 1/4	

► OAL: LPR+LS

Spare parts

Designation	Screw	Wrench	Plug*	
TDR 3125 - 3150	TS 20043I/HG-P	TD 6P	SL 20 M	
TDR 3155 - 3215	TS 22052I/HG	TD 7	SL 25 M	
TDR 3220 - 3270	TS 25064I	TD 8	SL 25 M / SL 32 M	
TDR 3275	TS 25064I	TD 8	-	
TDR 3280 - 3330	TS 35088I	TD 10	-	
TDR 3340 - 3390	TS 40093I	TD 15	-	
TDR 3400 - 3410	TS 40093I	TD 15	-	
TDR 3420 - 3500	SO 50090I	TD 20	-	



► * Notice: Cooling hole plug for lathe should be ordered separately
 Order example) Plug for shank diameter 25.0mm : SL 25M

Indexable drill holders



- Drilling depth: 4xdiameter

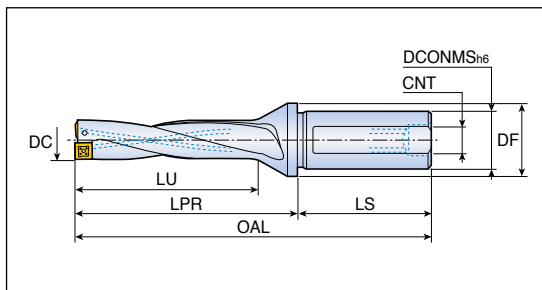

Designation	Dimension (mm)							Insert
	DC	DCONMS	DF	LU	LPR	LS	CNT	
TDR 4125-20T2-05	12.5	20	25	52	70	50	M13X1.0	SPMG 05...
4130-20T2-05	13.0	20	25	52	70	50	M13X1.0	DG/DK
4135-20T2-05	13.5	20	25	56	74	50	M13X1.0	SPGG 05..DA
4140-20T2-05	14.0	20	25	56	74	50	M13X1.0	D182-D183
4145-20T2-05	14.5	20	25	60	79	50	M13X1.0	
4150-20T2-05	15.0	20	25	60	79	50	M13X1.0	
4155-25T2-06	15.5	25	32	64	84	56	M16X1.5	SPMG 06...
4160-25T2-06	16.0	25	32	64	84	56	M16X1.5	DG/DK
4165-25T2-06	16.5	25	32	68	88	56	M16X1.5	SPGG 06..DA
4170-25T2-06	17.0	25	32	68	88	56	M16X1.5	D182-D183
4175-25T2-06	17.5	25	32	72	93	56	M16X1.5	
4180-25T2-06	18.0	25	32	72	93	56	M16X1.5	
4185-25T2-06	18.5	25	32	76	97	56	M16X1.5	
4190-25T2-06	19.0	25	32	76	97	56	M16X1.5	
4195-25T2-06	19.5	25	32	80	103	56	M16X1.5	
4200-25T2-06	20.0	25	32	80	103	56	M16X1.5	
4205-25T2-06	20.5	25	32	84	107	56	M16X1.5	
4210-25T2-06	21.0	25	32	84	107	56	M16X1.5	
4215-25T2-06	21.5	25	32	88	111	56	M16X1.5	
4220-25T2-07	22.0	25	32	88	111	56	M16X1.5	SPMG 07...
4225-25T2-07	22.5	25	32	92	117	56	M16X1.5	DG/DK
4225-32T2-07	22.5	32	40	92	117	60	M22X2.0	SPGG 07..DA
4230-25T2-07	23.0	25	32	92	117	56	M16X1.5	D182-D183
4230-32T2-07	23.0	32	40	92	117	60	M22X2.0	
4235-25T2-07	23.5	25	32	96	122	56	M16X1.5	
4235-32T2-07	23.5	32	40	96	122	60	M22X2.0	
4240-25T2-07	24.0	25	32	96	122	56	M16X1.5	
4240-32T2-07	24.0	32	40	96	122	60	M22X2.0	
4245-25T2-07	24.5	25	32	100	127	56	M16X1.5	
4245-32T2-07	24.5	32	40	100	127	60	M22X2.0	
4250-25T2-07	25.0	25	32	100	127	56	M16X1.5	
4250-32T2-07	25.0	32	40	100	127	60	M22X2.0	
4255-25T2-07	25.5	25	32	104	131	56	M16X1.5	
4255-32T2-07	25.5	32	40	104	131	60	M22X2.0	
4260-25T2-07	26.0	25	32	104	131	56	M16X1.5	



► OAL: LPR+LS

TDR 4...-T2



Indexable drill holders



- Drilling depth: 4x diameter

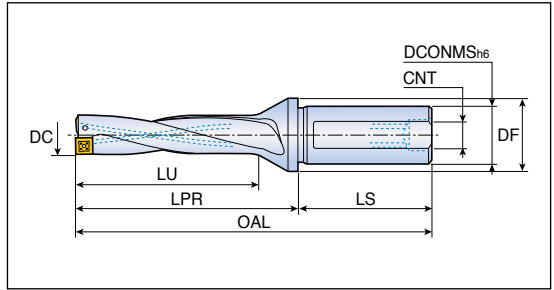

Designation	Dimension (mm)							Insert
	DC	DCONMS	DF	LU	LPR	LS	CNT	
TDR 4260-32T2-07	26.0	32	40	104	131	60	M22X2.0	SPMG 07...
4265-25T2-07	26.5	25	32	108	135	56	M16X1.5	DG/DK
4265-32T2-07	26.5	32	40	108	135	60	M22X2.0	SPGG 07..DA
4270-25T2-07	27.0	25	32	108	135	56	M16X1.5	D182-D183
4270-32T2-07	27.0	32	40	108	135	60	M22X2.0	
4275-25T2-07	27.5	25	32	112	140	56	Rc 1/8	
4275-32T2-07	27.5	32	40	112	140	60	Rc 1/4	
4280-25T2-09	28.0	25	40	112	140	56	Rc 1/8	SPMG 09...
4280-32T2-09	28.0	32	40	112	140	60	Rc 1/4	DG/DK
4285-25T2-09	28.5	25	40	116	144	56	Rc 1/8	SPGG 09..DA
4285-32T2-09	28.5	32	40	116	144	60	Rc 1/4	D182-D183
4290-25T2-09	29.0	25	40	116	144	56	Rc 1/8	
4290-32T2-09	29.0	32	40	116	144	60	Rc 1/4	
4295-32T2-09	29.5	32	40	120	151	60	Rc 1/4	
4295-40T2-09	29.5	40	50	120	151	70	Rc 1/4	
4300-32T2-09	30.0	32	40	120	151	60	Rc 1/4	
4300-40T2-09	30.0	40	50	120	151	70	Rc 1/4	
4305-32T2-09	30.5	32	40	124	156	60	Rc 1/4	
4305-40T2-09	30.5	40	50	124	156	70	Rc 1/4	
4310-32T2-09	31.0	32	40	124	156	60	Rc 1/4	
4310-40T2-09	31.0	40	50	124	156	70	Rc 1/4	
4315-32T2-09	31.5	32	40	128	160	60	Rc 1/4	
4315-40T2-09	31.5	40	50	128	160	70	Rc 1/4	
4320-32T2-09	32.0	32	40	128	160	60	Rc 1/4	
4320-40T2-09	32.0	40	50	128	160	70	Rc 1/4	
4325-32T2-09	32.5	32	40	132	165	60	Rc 1/4	
4325-40T2-09	32.5	40	50	132	165	70	Rc 1/4	
4330-32T2-09	33.0	32	40	132	165	60	Rc 1/4	
4330-40T2-09	33.0	40	50	132	165	70	Rc 1/4	
4340-32T2-11	34.0	32	50	136	169	60	Rc 1/4	SPMG 11...
4340-40T2-11	34.0	40	55	136	169	70	Rc 1/4	DG/DK
4350-32T2-11	35.0	32	50	140	174	60	Rc 1/4	SPGG 11..DA
4350-40T2-11	35.0	40	55	140	174	70	Rc 1/4	D182-D183
4360-32T2-11	36.0	32	50	144	179	60	Rc 1/4	
4360-40T2-11	36.0	40	55	144	179	70	Rc 1/4	

Cutting Condition
 D232
 ▶ OAL: LPR + LS

TDR 4...-T2



Indexable drill holders



- Drilling depth: 4xdiameter

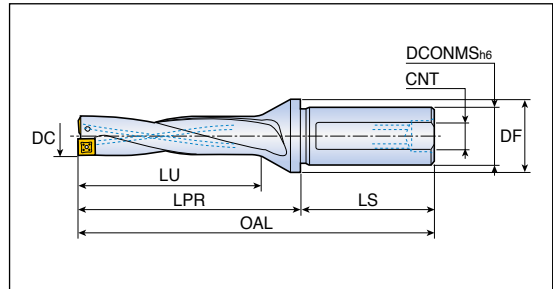

Designation	Dimension (mm)							Insert
	DC	DCONMS	DF	LU	LPR	LS	CNT	
TDR 4370-32T2-11	37.0	32	50	148	184	60	Rc 1/4	SPMG 11...
4370-40T2-11	37.0	40	55	148	184	70	Rc 1/4	DG/DK
4380-32T2-11	38.0	32	50	152	189	60	Rc 1/4	SPGG 11..DA
4380-40T2-11	38.0	40	55	152	189	70	Rc 1/4	D182-D183
4390-32T2-11	39.0	32	50	156	193	60	Rc 1/4	
4390-40T2-11	39.0	40	55	156	193	70	Rc 1/4	
4400-32T2-11	40.0	32	50	160	198	60	Rc 1/4	
4400-40T2-11	40.0	40	55	160	198	70	Rc 1/4	
4410-40T2-11	41.0	40	55	164	203	70	Rc 1/4	
4420-40T2-14	42.0	40	60	168	207	70	Rc 1/4	SPMG 14...
4430-40T2-14	43.0	40	60	172	212	70	Rc 1/4	DG/DK
4440-40T2-14	44.0	40	60	176	216	70	Rc 1/4	SPGG 14..DA
4450-40T2-14	45.0	40	60	180	222	70	Rc 1/4	D182-D183
4460-40T2-14	46.0	40	60	184	227	70	Rc 1/4	
4470-40T2-14	47.0	40	60	188	231	70	Rc 1/4	
4480-40T2-14	48.0	40	60	192	236	70	Rc 1/4	
4490-40T2-14	49.0	40	60	196	240	70	Rc 1/4	
4500-40T2-14	50.0	40	60	200	245	70	Rc 1/4	

► OAL = LPR+LS

Spare parts

Designation	Screw 	Wrench 	Plug* 	
TDR 4125 - 4150	TS 20043I/HG-P	TD 6P	SL 20 M	
TDR 4155 - 4215	TS 22052I/HG	TD 7	SL 25 M	
TDR 4220 - 4270	TS 25064I	TD 8	SL 25 M / SL 32 M	
TDR 4275	TS 25064I	TD 8	-	
TDR 4280 - 4330	TS 35088I	TD 10	-	
TDR 4340 - 4390	TS 40093I	TD 15	-	
TDR 4400 - 4410	TS 40093I	TD 15	-	
TDR 4420 - 4500	SO 50090I	TD 20	-	



► * Notice: Cooling hole plug for lathe should be ordered separately
Order example) Plug for shank diameter 25.0mm: SL 25M

TDR 5...-T2



Indexable drill holders



- Drilling depth: 5x diameter

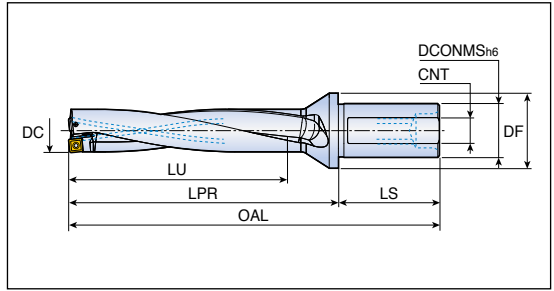

Designation	Dimension (mm)							Insert
	DC	DCONMS	DF	LU	LPR	LS	CNT	
TDR 5125-20T2-05	12.5	20	25	65	83	50	M13X1.0	SPMG 05...
5130-20T2-05	13.0	20	25	65	83	50	M13X1.0	DG/DK
5135-20T2-05	13.5	20	25	70	88	50	M13X1.0	SPGG 05..DA
5140-20T2-05	14.0	20	25	70	88	50	M13X1.0	D182-D183
5145-20T2-05	14.5	20	25	75	94	50	M13X1.0	
5150-20T2-05	15.0	20	25	75	94	50	M13X1.0	
5155-25T2-06	15.5	25	32	80	100	56	M16X1.5	SPMG 06...
5160-25T2-06	16.0	25	32	80	100	56	M16X1.5	DG/DK
5165-25T2-06	16.5	25	32	85	105	56	M16X1.5	SPGG 06..DA
5170-25T2-06	17.0	25	32	85	105	56	M16X1.5	D182-D183
5175-25T2-06	17.5	25	32	90	111	56	M16X1.5	
5180-25T2-06	18.0	25	32	90	111	56	M16X1.5	
5185-25T2-06	18.5	25	32	95	116	56	M16X1.5	
5190-25T2-06	19.0	25	32	95	116	56	M16X1.5	
5195-25T2-06	19.5	25	32	100	123	56	M16X1.5	
5200-25T2-06	20.0	25	32	100	123	56	M16X1.5	
5205-25T2-06	20.5	25	32	105	128	56	M16X1.5	
5210-25T2-06	21.0	25	32	105	128	56	M16X1.5	
5215-25T2-06	21.5	25	32	110	133	56	M16X1.5	
5220-25T2-07	22.0	25	32	110	133	56	M22X2.0	SPMG 07...
5225-32T2-07	22.5	32	40	115	140	60	M22X2.0	DG/DK
5230-32T2-07	23.0	32	40	115	140	60	M22X2.0	SPGG 07..DA
5235-32T2-07	23.5	32	40	120	146	60	M22X2.0	D182-D183
5240-32T2-07	24.0	32	40	120	146	60	M22X2.0	
5245-32T2-07	24.5	32	40	125	152	60	M22X2.0	
5250-32T2-07	25.0	32	40	125	152	60	M22X2.0	
5255-32T2-07	25.5	32	40	130	157	60	M22X2.0	
5260-32T2-07	26.0	32	40	130	157	60	M22X2.0	
5265-32T2-07	26.5	32	40	135	162	60	M22X2.0	
5270-32T2-07	27.0	32	40	135	162	60	M22X2.0	
5275-32T2-07	27.5	32	40	140	168	60	Rc 1/4	



► OAL: LPR + LS

TDR 5...-T2



Indexable drill holders



- Drilling depth: 5x diameter

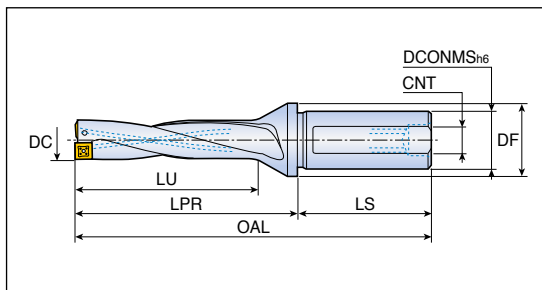

Designation	Dimension (mm)							Insert	
	DC	DCONMS	DF	LU	LPR	LS	CNT		
TDR 5280-32T2-09	28.0	32	40	140	168	60	Rc 1/4	SPMG 09... DG/DK SPGG 09..DA D182-D183	
5285-32T2-09	28.5	32	40	145	173	60	Rc 1/4		
5290-32T2-09	29.0	32	40	145	173	60	Rc 1/4		
5295-32T2-09	29.5	32	40	150	181	60	Rc 1/4		
5300-32T2-09	30.0	32	40	150	181	60	Rc 1/4		
5300-40T2-09	30.0	40	50	150	181	70	Rc 1/4		
5310-32T2-09	31.0	32	40	155	187	60	Rc 1/4		
5310-40T2-09	31.0	40	50	155	187	70	Rc 1/4		
5320-32T2-09	32.0	32	40	160	192	60	Rc 1/4		
5320-40T2-09	32.0	40	50	160	192	70	Rc 1/4		
5330-32T2-09	33.0	32	40	165	198	60	Rc 1/4		
5330-40T2-09	33.0	40	50	165	198	70	Rc 1/4		
5340-32T2-11	34.0	32	50	170	203	60	Rc 1/4		SPMG 11... DG/DK SPGG 11..DA D182-D183
5340-40T2-11	34.0	40	55	170	203	70	Rc 1/4		
5350-32T2-11	35.0	32	50	175	209	60	Rc 1/4		
5350-40T2-11	35.0	40	55	175	209	70	Rc 1/4		
5360-32T2-11	36.0	32	50	180	215	60	Rc 1/4		
5360-40T2-11	36.0	40	55	180	215	70	Rc 1/4		
5370-32T2-11	37.0	32	50	185	221	60	Rc 1/4		
5370-40T2-11	37.0	40	55	185	221	70	Rc 1/4		
5380-32T2-11	38.0	32	50	190	227	60	Rc 1/4		
5380-40T2-11	38.0	40	55	190	227	70	Rc 1/4		
5390-32T2-11	39.0	32	50	195	232	60	Rc 1/4		
5390-40T2-11	39.0	40	55	195	232	70	Rc 1/4		
5400-32T2-11	40.0	32	50	200	238	60	Rc 1/4		
5400-40T2-11	40.0	40	55	200	238	70	Rc 1/4		
5410-40T2-11	41.0	40	55	205	244	70	Rc 1/4		

▶ OAL: LPR+LS

TDR 5...-T2



Indexable drill holders



- Drilling depth: 5x diameter

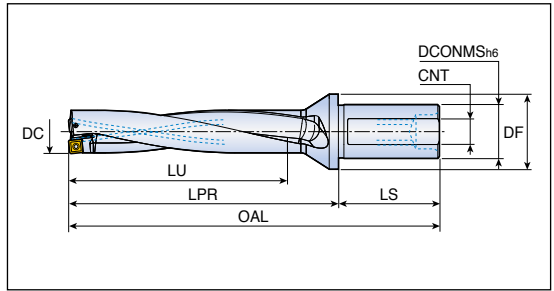

Designation	Dimension (mm)							Insert
	DC	DCONMS	DF	LU	LPR	LS	CNT	
TDR 5420-40T2-14	42.0	40	60	210	249	70	Rc 1/4	SPMG 14...
5430-40T2-14	43.0	40	60	215	255	70	Rc 1/4	DG/DK
5440-40T2-14	44.0	40	60	220	260	70	Rc 1/4	SPGG 14..DA
5450-40T2-14	45.0	40	60	225	267	70	Rc 1/4	D182-D183
5460-40T2-14	46.0	40	60	230	273	70	Rc 1/4	
5470-40T2-14	47.0	40	60	235	278	70	Rc 1/4	
5480-40T2-14	48.0	40	60	240	284	70	Rc 1/4	
5490-40T2-14	49.0	40	60	245	289	70	Rc 1/4	
5500-40T2-14	50.0	40	60	250	295	70	Rc 1/4	

► OAL: LPR+LS

Spare parts

Designation	Screw	Wrench	Plug*	
TDR 5125 - 5150	TS 20043I/HG-P	TD 6P	SL 20 M	
TDR 5155 - 5215	TS 22052I/HG	TD 7	SL 25 M	
TDR 5220 - 5270	TS 25064I	TD 8	SL 25 M / SL 32 M	
TDR 5275	TS 25064I	TD 8	-	
TDR 5280 - 5330	TS 35088I	TD 10	-	
TDR 5340 - 5390	TS 40093I	TD 15	-	
TDR 5400 - 5410	TS 40093I	TD 15	-	
TDR 5420 - 5500	SO 50090I	TD 20	-	



► * Notice: Cooling hole plug for lathe should be ordered separately
 Order example) Plug for shank diameter 25.0mm: SL 25M

TDR 25...CA-T



Indexable cartridge drill holders



- Drilling depth: 2.5x diameter

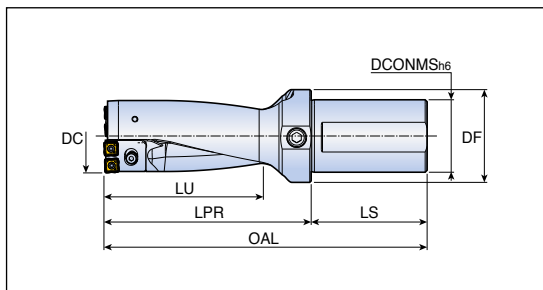

Designation	Dimension (mm)						Setting plate	Insert
	DC	DCONMS	DF	LU	LPR	LS		
TDR 2551-53-50T2-07CA-T	51	50	64	133	170	80	-	SPMG 07...
	52	50	64	133	170	80	TDP-0701	DG/DK SPGG 07..DA
	53	50	64	133	170	80	TDP-0702	SPGG 07..DA D182-D183
2554-56-50T2-07CA-T	54	50	64	140	180	80	-	SPMG 07...
	55	50	64	140	180	80	TDP-0701	DG/DK SPGG 07..DA
	56	50	64	140	180	80	TDP-0702	SPGG 07..DA D182-D183
2557-62-50T2-09CA-T	57	50	64	155	201	80	-	SPMG 09...
	58	50	64	155	201	80	TDP-0901	DG/DK SPGG 09..DA
	59	50	64	155	201	80	TDP-0902	SPGG 09..DA
	60	50	64	155	201	80	TDP-0903	D182-D183
	61	50	64	155	201	80	TDP-0904	
	62	50	64	155	201	80	TDP-0905	
2563-66-50T2-09CA-T	63	50	69	165	215	80	-	SPMG 09...
	64	50	69	165	215	80	TDP-0901	DG/DK SPGG 09..DA
	65	50	69	165	215	80	TDP-0902	SPGG 09..DA
	66	50	69	165	215	80	TDP-0903	D182-D183
2567-73-50T2-11CA-T	67	50	69	183	240	80	-	SPMG 11...
	68	50	69	183	240	80	TDP-1101	DG/DK SPGG 11..DA
	69	50	69	183	240	80	TDP-1102	SPGG 11..DA
	70	50	69	183	240	80	TDP-1103	D182-D183
	71	50	69	183	240	80	TDP-1104	
	72	50	69	183	240	80	TDP-1105	
	73	50	69	183	240	80	TDP-1106	
2574-80-50T2-12CA-T	74	50	74	200	250	80	-	SPMG 12...DG
	75	50	74	200	250	80	TDP-1101	D182
	76	50	74	200	250	80	TDP-1102	
	77	50	74	200	250	80	TDP-1103	
	78	50	74	200	250	80	TDP-1104	
	79	50	74	200	250	80	TDP-1105	
	80	50	74	200	250	80	TDP-1106	



► OAL: LPR+LS

TDR 35...CA-T



Indexable cartridge drill holders



- Drilling depth: 3.5xdiameter

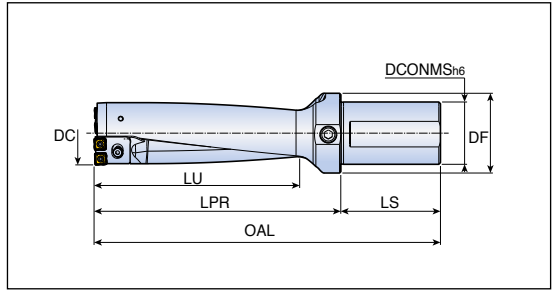

Designation	Dimension (mm)						Setting plate	Insert
	DC	DCONMS	DF	LU	LPR	LS		
TDR 3551-53-50T2-07CA-T	51	50	64	186	223	80	-	SPMG 07...
	52	50	75	186	223	80	TDP-0701	DG/DK SPGG 07..DA
	53	50	75	186	223	80	TDP-0702	SPGG 07..DA D182-D183
3554-56-50T2-07CA-T	54	50	75	196	236	80	-	SPMG 07...
	55	50	75	196	236	80	TDP-0701	DG/DK SPGG 07..DA
	56	50	75	196	236	80	TDP-0702	SPGG 07..DA D182-D183
3557-62-50T2-09CA-T	57	50	75	217	263	80	-	SPMG 09...
	58	50	75	217	263	80	TDP-0901	DG/DK
	59	50	75	217	263	80	TDP-0902	SPGG 09..DA
	60	50	75	217	263	80	TDP-0903	D182-D183
	61	50	75	217	263	80	TDP-0904	
	62	50	75	217	263	80	TDP-0905	
3563-66-50T2-09CA-T	63	50	75	231	281	80	-	SPMG 09...
	64	50	75	231	281	80	TDP-0901	DG/DK
	65	50	75	231	281	80	TDP-0902	SPGG 09..DA
	66	50	75	231	281	80	TDP-0903	D182-D183
3567-73-50T2-11CA-T	67	50	75	256	313	80	-	SPMG 11...
	68	50	75	256	313	80	TDP-1101	DG/DK
	69	50	75	256	313	80	TDP-1102	SPGG 11..DA
	70	50	75	256	313	80	TDP-1103	D182-D183
	71	50	75	256	313	80	TDP-1104	
	72	50	75	256	313	80	TDP-1105	
	73	50	75	256	313	80	TDP-1106	



► OAL: LPR+LS

TDR 35...CA-T



Indexable cartridge drill holders



- Drilling depth: 3.5x diameter

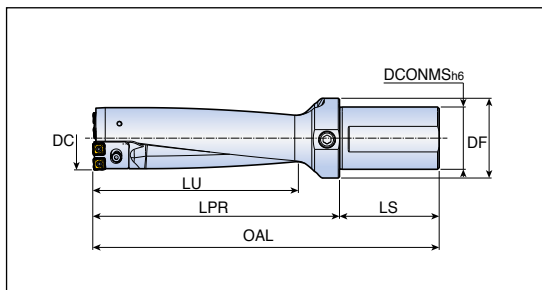

Designation	Dimension (mm)						Setting plate	Insert
	DC	DCONMS	DF	LU	LPR	LS		
TDR 3574-80-50T2-12CA-T	74	50	75	280	330	80	-	SPMG 12...DG D182
	75	50	75	280	330	80	TDP-1101	
	76	50	75	280	330	80	TDP-1102	
	77	50	75	280	330	80	TDP-1103	
	78	50	75	280	330	80	TDP-1104	
	79	50	75	280	330	80	TDP-1105	
80	50	75	280	330	80	TDP-1106		

▶ OAL: LPR+LS

Spare parts

Designation	Screw	Cartridge for peripheral	Cartridge for center
TDR.. 51-53...	TS 250641	TDR 07CA-P1-T	TDR 07CA-C1-T
TDR.. 54-56...	TS 250641	TDR 07CA-P2-T	TDR 07CA-C2-T
TDR.. 57-62...	TS 350881	TDR 09CA-P1-T	TDR 09CA-C1-T
TDR.. 63-66...	TS 350881	TDR 09CA-P2-T	TDR 09CA-C2-T
TDR.. 67-73...	TS 400931	TDR 11CA-P1-T	TDR 11CA-C1-T
TDR.. 74-80...	TS 400931	TDR 12CA-P2-T	TDR 12CA-C2-T

Spare parts for cartridges

Designation	Cartridge clamping screw	Washer	Setting plate screw
TDR 07CA-P1-T	SH M4x0.7x16	MW 4.3x8	TS 20043I/HG-P
TDR 07CA-C1-T	SH M4x0.7x16	MW 4.3x8	-
TDR 07CA-P2-T	SH M4x0.7x16	MW 4.3x8	TS 20043I/HG-P
TDR 07CA-C2-T	SH M4x0.7x16	MW 4.3x8	-
TDR 09CA-P1-T	SH M5x0.8x16	MW 5.5x10	SO 30055I
TDR 09CA-C1-T	SH M5x0.8x16	MW 5.5x10	-
TDR 09CA-P2-T	SH M5x0.8x16	MW 5.5x10	SO 30055I
TDR 09CA-C2-T	SH M5x0.8x16	MW 5.5x10	-
TDR 11CA-P1-T	SH M6x1.0x20	MW 6.4x12	SO 30055I
TDR 11CA-C1-T	SH M6x1.0x20	MW 6.4x12	-
TDR 12CA-P2-T	SH M6x1.0x20	MW 6.4x12	SO 30055I
TDR 12CA-C2-T	SH M6x1.0x20	MW 6.4x12	-



ECCENTER SLEEVE

Drill center adjustment sleeves / eccentric sleeve

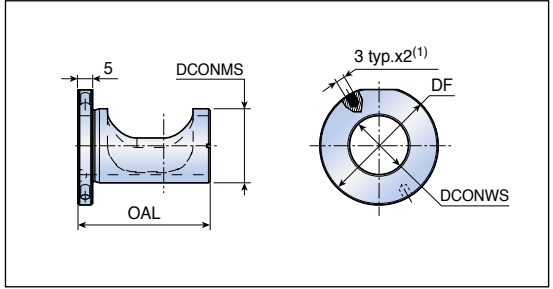

Designation	Dimension (mm)			
	DCONWS	DCONMS	DF	OAL
ECCENTER SLEEVE 20x25	20	25	40	44
25x32	25	32	50	46
32x40	32	40	65	55
40x50	40	50	75	62

► ⁽¹⁾ Holes for inserting a pin are used to facilitate radial adjustment of the sleeve (Pin is not supplied)

TCAP...-2.25DN



Multi-function toolholders - 2.25xD



• Internal coolant

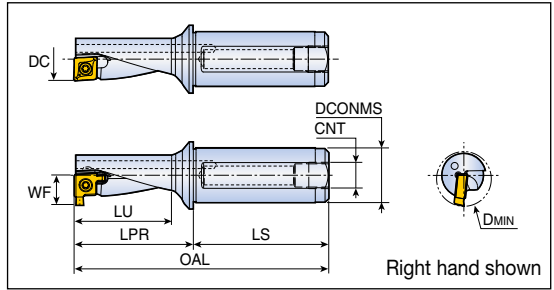
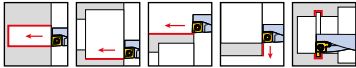

Designation	Dimension (mm)								Insert	
	DC	DCONMS	WF	LU	LPR	LS	DMIN	CNT	For drilling, boring, turning	For grooving
TCAP 08R/L-2.25DN	8	12	-	18.0	22.5	42	-	G 1/16	XCM(G)T 04...TC/TA	-
10R/L-2.25DN-GV	10	12	7.1	22.5	27.5	42	12.0	G 1/16	XCM(G)T 05...TC/TA	XCMT 05R...GV
12R/L-2.25DN-GV	12	16	8.5	27.0	33.0	45	14.5	G 1/8	XCM(G)T 06...TC/TA	XCMT 06R...GV
14R/L-2.25DN-GV	14	16	9.5	31.5	38.5	45	16.5	G 1/8	XCM(G)T 07...TC/TA	XCMT 07R...GV
16R/L-2.25DN-GV	16	20	11.1	36.0	44.0	50	19.0	G 1/8	XCM(G)T 08...TC/TA	XCMT 08R...GV
20R/L-2.25DN-GV	20	25	13.2	45.0	55.0	56	23.5	G 1/8	XCM(G)T 10...TC/TA	XCMT 10R...GV
25R/L-2.25DN-GV	25	32	16.5	56.2	69.0	61	29.0	G 1/8	XCM(G)T 13...TC/TA	XCMT 13R...GV
32R/L-2.25DN-GV	32	40	20.5	72.0	86.0	74	36.5	G 1/8	XCM(G)T 17...TC/TA	XCMT 17R...GV
									D211-D212	D211

- ▶ OAL: LPR+LS
- ▶ Grooving insert is available for right handed type

Spare parts

Designation	Screw	Wrench	
TCAP 08	TS 18034I/HG-P	T 6P	-
TCAP 10	TS 20038I/HG-P	T 6P	-
TCAP 12	TS 22052I/HG-P	T 7P	-
TCAP 14	TS 25064I/HG-P	T 8P	-
TCAP 16	TS 30100I/HG-P	-	TD 9P
TCAP 20	TS 35088I/HG-P	-	TD10P
TCAP 25	TS 45A100I/HG	-	TD 20
TCAP 32	TS 45A100I/HG	-	TD 20



TCAP...-3.0DN



Multi-function toolholders - 3.0xD



• Internal coolant

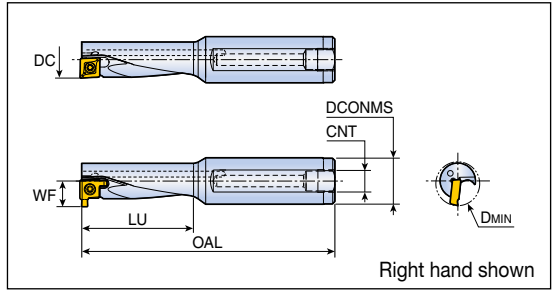
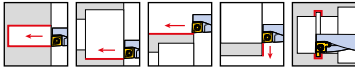

Designation	Dimension (mm)							Insert	
	DC	DCONMS	WF	LU	OAL	DMIN	CNT	For drilling, boring, turning	For grooving
TCAP 08R/L-3.0DN12	8	12	-	24	80	-	G 1/16	XCM(G)T 04...TC/TA	-
10R/L-3.0DN-GV	10	12	7.1	30	85	12.0	G 1/16	XCM(G)T 05...TC/TA	XCMT 05R...GV
12R/L-3.0DN-GV	12	16	8.5	36	95	14.5	G 1/8	XCM(G)T 06...TC/TA	XCMT 06R...GV
14R/L-3.0DN-GV	14	16	9.5	42	100	16.5	G 1/8	XCM(G)T 07...TC/TA	XCMT 07R...GV
16R/L-3.0DN-GV	16	20	11.1	48	110	19.0	G 1/8	XCM(G)T 08...TC/TA	XCMT 08R...GV
20R/L-3.0DN-GV	20	25	13.2	60	130	23.5	G 1/8	XCM(G)T 10...TC/TA	XCMT 10R...GV
25R/L-3.0DN-GV	25	32	16.5	75	150	29.0	G 1/8	XCM(G)T 13...TC/TA	XCMT 13R...GV
32R/L-3.0DN-GV	32	40	20.5	96	185	36.5	G 1/8	XCM(G)T 17...TC/TA	XCMT 17R...GV
								D211-D212	D211

- ▶ OA: LPR+LS
- ▶ Grooving insert is available for right handed type

Spare parts

Designation	Screw	Wrench	
TCAP 08	TS 18034I/HG-P	T 6P	-
TCAP 10	TS 20038I/HG-P	T 6P	-
TCAP 12	TS 22052I/HG-P	T 7P	-
TCAP 14	TS 25064I/HG-P	T 8P	-
TCAP 16	TS 30100I/HG-P	-	TD 9P
TCAP 20	TS 35088I/HG-P	-	TD10P
TCAP 25	TS 45A100I/HG	-	TD 20
TCAP 32	TS 45A100I/HG	-	TD 20



Boring bars with TOP-CAP inserts



- For boring
- External coolant

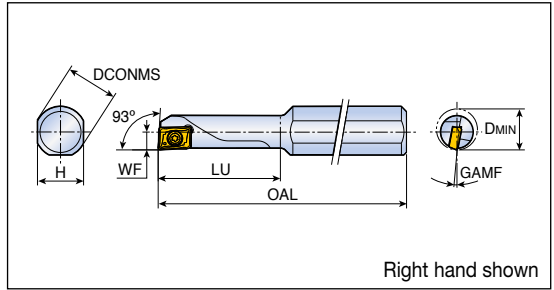
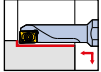

Designation	Dimension (mm)							Insert
	DCONMS	H	OAL	LU	WF	DMIN	GAMF	
S10H SXUCR/L 04-06 ⁽¹⁾	10	9	100	21	3.0	6	9°	XCMT 04...R/L TC
S10J SXUCR/L 04-07 ⁽¹⁾	10	9	110	24.5	3.5	7	5°	D212
S10J SXUCR/L 04-08 ⁽¹⁾	10	9	110	28	4.0	8	2°	
S10K SXUCR/L 05-10	10	9	125	35	5.0	10	2°	XCMT 05..TC D212

▶ ⁽¹⁾ Right hand Insert should be used in right hand boring bar

Spare parts

Designation	Screw	Wrench		
S10H SXUCR/L 04-06	TS 18034I/HG-P	T 6P		
S10J SXUCR/L 04-07	TS 18034I/HG-P	T 6P		
S10J SXUCR/L 04-08	TS 18034I/HG-P	T 6P		
S10K SXUCR/L 05-10	TS 20038I/HG-P	T 6P		



Sleeves for clamping unit

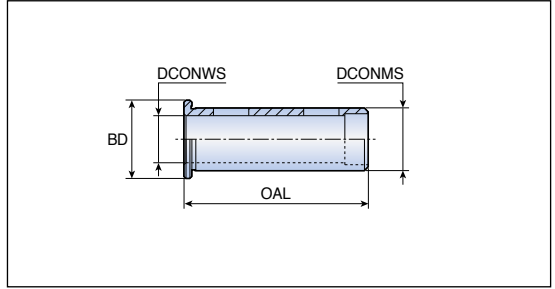

Designation	Dimension (mm)				Toolholders
	DCONMS	DCONWS	BD	OAL	
TSL 16-12	16	12	20	47	TCAP 10R/L...
25-20	25	20	32	55	TCAP 16R/L...

TBSL

Sleeves for boring bar

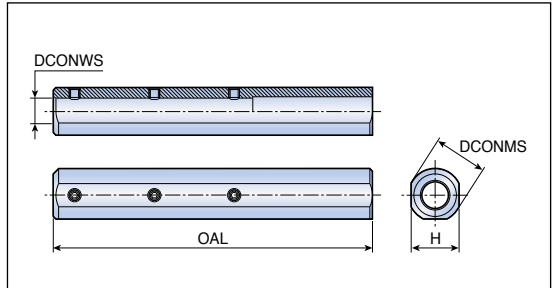

Designation	Dimension (mm)			
	DCONMS	DCONWS	OAL	H
TBSL 20-10-120	20	10	120	18

Spare parts

Designation	Screw	Wrench		
TBSL 20-10-120	SS M4x0.7x4	L-W 2		

3ED...T...-3D

Head changeable 3 flute drill holder



- Drilling depth: 3x diameter

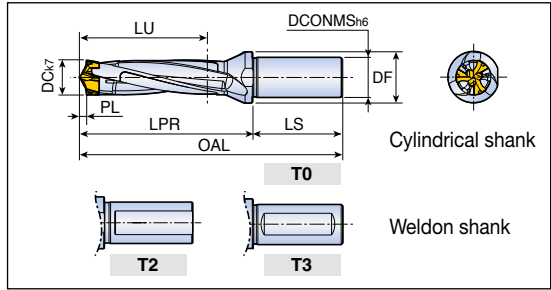

Designation	Dimension (mm)								Clamping key
	DC	DCONMS	DF	LU	LPR	LS	PL	SSC	
3ED 120-124-16T3/T0-3D	12.0-12.4	16	20	40.0	60.7	48	2.74	12	K 3ED D12-D13
125-129-16T3/T0-3D	12.5-12.9	16	20	41.5	62.5	48	2.76	12	
130-134-16T3/T0-3D	13.0-13.4	16	20	43.0	64.8	48	2.91	13	
135-139-16T3/T0-3D	13.5-13.9	16	20	44.5	66.6	48	2.93	13	
140-144-16T3/T0-3D	14.0-14.4	16	20	46.0	68.9	48	3.17	14	K 3ED D14-D15
145-149-16T3/T0-3D	14.5-14.9	16	20	47.5	70.7	48	3.19	14	
150-159-20T3/T0-3D	15.0-15.9	20	25	49.0	73.9	50	3.31	15	
160-169-20T3/T0-3D	16.0-16.9	20	25	52.0	79.0	50	3.70	16	K 3ED D16-D17
170-179-20T3/T0-3D	17.0-17.9	20	25	55.0	84.0	50	3.88	17	
180-189-25T2/T0-3D	18.0-18.9	25	32	58.0	90.1	56	4.07	18	K 3ED D18-D19
190-199-25T2/T0-3D	19.0-19.9	25	32	61.0	94.7	56	4.26	19	
200-209-25T2/T0-3D	20.0-20.9	25	32	64.0	99.3	56	4.44	20	K 3ED D20-D21
210-219-25T2/T0-3D	21.0-21.9	25	32	67.0	103.8	56	4.62	21	
220-229-25T2/T0-3D	22.0-22.9	25	32	70.0	108.4	56	4.78	22	K 3ED D22-D23
230-239-32T2/T0-3D	23.0-23.9	32	42	73.0	112.8	60	5.02	23	
240-249-32T2/T0-3D	24.0-24.9	32	42	76.0	117.4	60	5.18	24	K 3ED D24-D25
250-259-32T2/T0-3D	25.0-25.9	32	42	79.0	122.0	60	5.29	25	



- ▶ OAL: LPR+LS
- ▶ SSC: Seat size code

3ED...T...-5D



Head changeable 3 flute drill holder



• Drilling depth: 5xdiameter

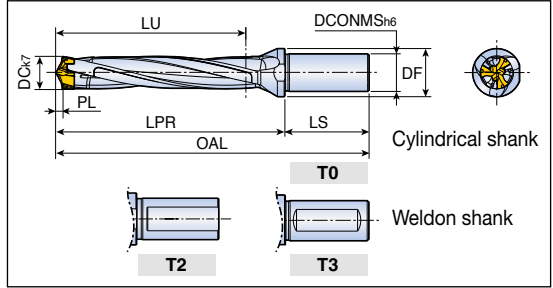

Designation	Dimension (mm)								Clamping key
	DC	DCONMS	DF	LU	LPR	LS	PL	SSC	
3ED 120-124-16T3/T0-5D	12.0-12.4	16	20	64.0	84.7	48	2.74	12	K 3ED D12-D13
125-129-16T3/T0-5D	12.5-12.9	16	20	66.5	87.5	48	2.76	12	
130-134-16T3/T0-5D	13.0-13.4	16	20	69.0	90.8	48	2.91	13	
135-139-16T3/T0-5D	13.5-13.9	16	20	71.5	93.6	48	2.93	13	
140-144-16T3/T0-5D	14.0-14.4	16	20	74.0	96.9	48	3.17	14	K 3ED D14-D15
145-149-16T3/T0-5D	14.5-14.9	16	20	76.5	99.7	48	3.19	14	
150-159-20T3/T0-5D	15.0-15.9	20	25	79.0	103.9	50	3.31	15	K 3ED D16-D17
160-169-20T3/T0-5D	16.0-16.9	20	25	84.0	111.0	50	3.70	16	
170-179-20T3/T0-5D	17.0-17.9	20	25	89.0	118.0	50	3.88	17	K 3ED D18-D19
180-189-25T2/T0-5D	18.0-18.9	25	32	94.0	126.1	56	4.07	18	
190-199-25T2/T0-5D	19.0-19.9	25	32	99.0	132.7	56	4.26	19	K 3ED D20-D21
200-209-25T2/T0-5D	20.0-20.9	25	32	104.0	139.3	56	4.44	20	
210-219-25T2/T0-5D	21.0-21.9	25	32	109.0	145.8	56	4.62	21	K 3ED D22-D23
220-229-25T2/T0-5D	22.0-22.9	25	32	114.0	152.4	56	4.78	22	
230-239-32T2/T0-5D	23.0-23.9	32	42	119.0	158.8	60	5.02	23	K 3ED D24-D25
240-249-32T2/T0-5D	24.0-24.9	32	42	124.0	165.4	60	5.18	24	
250-259-32T2/T0-5D	25.0-25.9	32	42	129.0	172.0	60	5.29	25	

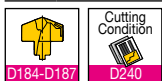

▶ OAL: LPR+LS
▶ SSC: Seat size code

3ED...T...-8D



Head changeable 3 flute drill holder



- Drilling depth: 8x diameter

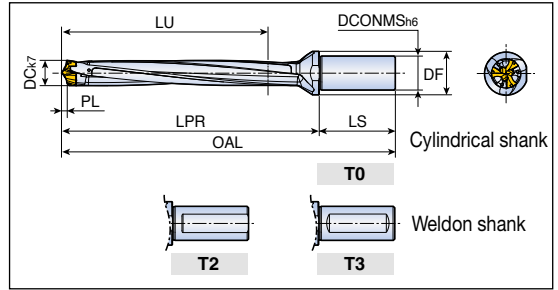

Designation	Dimension (mm)								Clamping key
	DC	DCONMS	DF	LU	LPR	LS	PL	SSC	
3ED 120-124-16T3/T0-8D	12.0-12.4	16	20	100	120.7	48	2.74	12	K 3ED D12-D13
125-129-16T3/T0-8D	12.5-12.9	16	20	104	125.0	48	2.76	12	
130-134-16T3/T0-8D	13.0-13.4	16	20	108	129.8	48	2.91	13	
135-139-16T3/T0-8D	13.5-13.9	16	20	112	134.1	48	2.93	13	K 3ED D14-D15
140-144-16T3/T0-8D	14.0-14.4	16	20	116	138.9	48	3.17	14	
145-149-16T3/T0-8D	14.5-14.9	16	20	120	143.2	48	3.19	14	
150-159-20T3/T0-8D	15.0-15.9	20	25	124	148.9	50	3.31	15	K 3ED D16-D17
160-169-20T3/T0-8D	16.0-16.9	20	25	132	159.0	50	3.70	16	
170-179-20T3/T0-8D	17.0-17.9	20	25	140	169.0	50	3.88	17	
180-189-25T2/T0-8D	18.0-18.9	25	32	148	180.1	56	4.07	18	K 3ED D18-D19
190-199-25T2/T0-8D	19.0-19.9	25	32	156	189.7	56	4.26	19	
200-209-25T2/T0-8D	20.0-20.9	25	32	164	199.3	56	4.44	20	
210-219-25T2/T0-8D	21.0-21.9	25	32	172	208.8	56	4.62	21	K 3ED D20-D21
220-229-25T2/T0-8D	22.0-22.9	25	32	180	218.4	56	4.78	22	
230-239-32T2/T0-8D	23.0-23.9	32	42	188	227.8	60	5.02	23	
240-249-32T2/T0-8D	24.0-24.9	32	42	196	237.4	60	5.18	24	K 3ED D22-D23
250-259-32T2/T0-8D	25.0-25.9	32	42	204	247.0	60	5.29	25	
									K 3ED D24-D25



- ▶ OAL: LPR+LS
- ▶ SSC: Seat size code

TCD...-3D



Head changeable drill holders - Cylindrical type shank



- Drilling depth: 3xdiameter

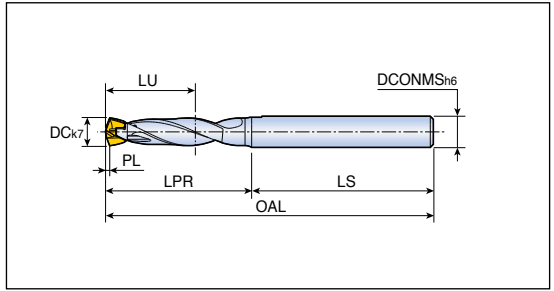

Designation	Dimension (mm)							Clamping key
	DC	DCONMS	LU	LPR	LS	PL	SSC	
TCD 040-044-06A0-3D	4.0-4.4	6	13	22.7	35	0.62	4	K TCD D040-D049
045-049-06A0-3D	4.5-4.9	6	14	24.7	35	0.66	4.5	
050-054-06A0-3D	5.0-5.4	6	16	26.3	35	0.73	5	K TCD D050-D059
055-059-06A0-3D	5.5-5.9	6	17	28.2	35	0.81	5.5	



- ▶ OAL: LPR+LS
- ▶ SSC: Seat size code

TCD...-5D



Head changeable drill holders - Cylindrical type shank



- Drilling depth: 5xdiameter

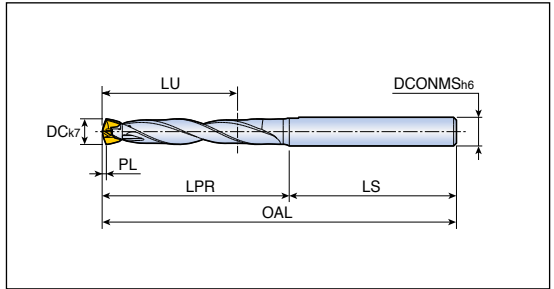

Designation	Dimension (mm)							Clamping key
	DC	DCONMS	LU	LPR	LS	PL	SSC	
TCD 040-044-06A0-5D	4.0-4.4	6	21	30.7	35	0.62	4	K TCD D040-D049
045-049-06A0-5D	4.5-4.9	6	23	33.7	35	0.66	4.5	
050-054-06A0-5D	5.0-5.4	6	26	36.3	35	0.73	5	K TCD D050-D059
055-059-06A0-5D	5.5-5.9	6	28	39.2	35	0.81	5.5	



- ▶ OAL: LPR+LS
- ▶ SSC: Seat size code

TCD...T...-1.5D



Head changeable drill holders - Weldon type shank



- Drilling depth: 1.5x diameter

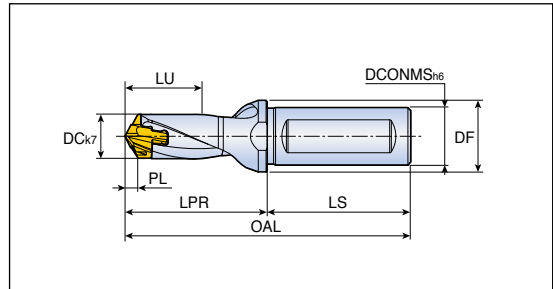

Designation	Dimension (mm)								Clamping key	
	DC	DCONMS	DF	LU	LPR	LS	PL	SSC		
TCD 060-064-12T3-1.5D	6.0-6.4	12	16	10	23.0	45	0.96	6	K TCD D060-D099	
065-069-12T3-1.5D	6.5-6.9	12	16	11	24.1	45	1.18	6.5		
070-074-12T3-1.5D	7.0-7.4	12	16	12	25.1	45	1.01	7		
075-079-12T3-1.5D	7.5-7.9	12	16	12	25.9	45	1.10	7		
080-089-12T3-1.5D	8.0-8.9	12	16	13	27.4	45	1.20	8		
090-099-12T3-1.5D	9.0-9.9	12	16	15	29.3	45	1.35	9		
100-109-16T3-1.5D	10.0-10.9	16	20	17	31.2	48	1.50	10		K TCD D100-D199
110-119-16T3-1.5D	11.0-11.9	16	20	19	33.1	48	1.67	11		
120-129-16T3-1.5D	12.0-12.9	16	20	20	35.0	48	1.82	12		
130-139-16T3-1.5D	13.0-13.9	16	20	22	37.1	48	1.96	13		
140-149-16T3-1.5D	14.0-14.9	16	20	23	41.1	48	2.12	14		
150-159-20T3-1.5D	15.0-15.9	20	25	25	46.2	50	2.27	15		
160-169-20T3-1.5D	16.0-16.9	20	25	26	49.3	50	2.42	16		
170-179-20T3-1.5D	17.0-17.9	20	25	29	52.4	50	2.59	17		
180-189-25T2-1.5D	18.0-18.9	25	32	30	55.5	56	2.73	18		
190-199-25T2-1.5D	19.0-19.9	25	32	32	58.5	56	2.88	19	K TCD D200-D269	
200-209-25T2-1.5D	20.0-20.9	25	32	33	61.6	56	3.02	20		
210-219-25T2-1.5D	21.0-21.9	25	32	35	64.7	56	3.18	21		
220-229-25T2-1.5D	22.0-22.9	25	32	36	67.8	56	3.24	22		
230-239-32T2-1.5D	23.0-23.9	32	42	38	70.8	60	3.46	23		
240-249-32T2-1.5D	24.0-24.9	32	42	40	73.9	60	3.62	24		
250-259-32T2-1.5D	25.0-25.9	32	42	42	77.0	60	3.80	25		

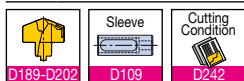

- ▶ OAL: LPR+LS
- ▶ SSC: Seat size code

TCD...S0-1.5D

Head changeable drill holders - Cylindrical type shank



• Drilling depth: 1.5x diameter

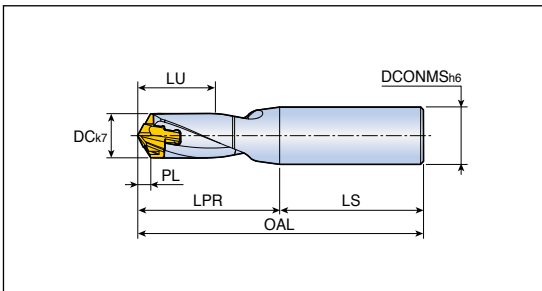

Designation	Dimension (mm)							Clamping key	
	DC	DCONMS	LU	LPR	LS	PL	SSC		
TCD 060-064-12S0-1.5D	6.0-6.4	12	10	23.0	45	0.96	6	K TCD D060-D099	
065-069-12S0-1.5D	6.5-6.9	12	11	24.1	45	1.18	6.5		
070-074-12S0-1.5D	7.0-7.4	12	12	25.1	45	1.01	7		
075-079-12S0-1.5D	7.5-7.9	12	12	25.9	45	1.10	7		
080-089-12S0-1.5D	8.0-8.9	12	13	27.4	45	1.20	8		
090-099-12S0-1.5D	9.0-9.9	12	15	29.3	45	1.35	9		
100-109-16S0-1.5D	10.0-10.9	16	17	31.2	48	1.50	10		K TCD D100-D199
110-119-16S0-1.5D	11.0-11.9	16	19	33.1	48	1.67	11		
120-129-16S0-1.5D	12.0-12.9	16	20	35.0	48	1.82	12		
130-139-16S0-1.5D	13.0-13.9	16	22	37.1	48	1.96	13		
140-149-16S0-1.5D	14.0-14.9	16	23	41.1	48	2.12	14		
150-159-20S0-1.5D	15.0-15.9	20	25	46.2	50	2.27	15		
160-169-20S0-1.5D	16.0-16.9	20	26	49.3	50	2.42	16		
170-179-20S0-1.5D	17.0-17.9	20	29	52.4	50	2.59	17	K TCD D200-D269	
180-189-25S0-1.5D	18.0-18.9	25	30	55.5	56	2.73	18		
190-199-25S0-1.5D	19.0-19.9	25	32	58.5	56	2.88	19		
200-209-25S0-1.5D	20.0-20.9	25	33	61.6	56	3.02	20		
210-219-25S0-1.5D	21.0-21.9	25	35	64.7	56	3.18	21		
220-229-25S0-1.5D	22.0-22.9	25	36	67.8	56	3.24	22		
230-239-32S0-1.5D	23.0-23.9	32	38	70.8	60	3.46	23		
240-249-32S0-1.5D	24.0-24.9	32	40	73.9	60	3.62	24	K TCD D200-D269	
250-259-32S0-1.5D	25.0-25.9	32	42	77.0	60	3.80	25		



▶ OAL: LPR+LS
▶ SSC: Seat size code

Head changeable drill holders - Weldon type shank



- Drilling depth: 3xdiameter

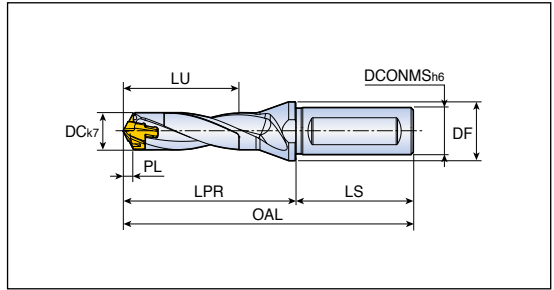

Designation	Dimension (mm)								Clamping key	
	DC	DCONMS	DF	LU	LPR	LS	PL	SSC		
TCD 060-064-12T3-3D	6.0-6.4	12	16	19	32.0	45	0.96	6	K TCD D060-D099	
065-069-12T3-3D	6.5-6.9	12	16	21	33.8	45	1.18	6.5		
070-074-12T3-3D	7.0-7.4	12	16	22	35.6	45	1.01	7		
075-079-12T3-3D	7.5-7.9	12	16	24	37.1	45	1.10	7		
080-084-12T3-3D	8.0-8.4	12	16	25	39.4	45	1.20	8		
085-089-12T3-3D	8.5-8.9	12	16	27	40.9	45	1.29	8		
090-094-12T3-3D	9.0-9.4	12	16	28	42.8	45	1.35	9		
095-099-12T3-3D	9.5-9.9	12	16	30	44.3	45	1.44	9		
100-104-16T3-3D	10.0-10.4	16	20	32	46.2	48	1.50	10		K TCD D100-D199
105-109-16T3-3D	10.5-10.9	16	20	34	47.7	48	1.59	10		
110-114-16T3-3D	11.0-11.4	16	20	35	49.6	48	1.67	11		
115-119-16T3-3D	11.5-11.9	16	20	37	51.1	48	1.76	11		
120-124-16T3-3D	12.0-12.4	16	20	38	53.0	48	1.82	12		
125-129-16T3-3D	12.5-12.9	16	20	39	54.5	48	1.91	12		
130-134-16T3-3D	13.0-13.4	16	20	41	56.6	48	1.96	13		
135-139-16T3-3D	13.5-13.9	16	20	43	58.1	48	2.05	13		
140-144-16T3-3D	14.0-14.4	16	20	44	62.2	48	2.12	14		
145-149-16T3-3D	14.5-14.9	16	20	46	63.7	48	2.21	14		
150-159-20T3-3D	15.0-15.9	20	25	47	68.7	50	2.27	15	K TCD D200-D269	
160-169-20T3-3D	16.0-16.9	20	25	50	73.3	50	2.42	16		
170-179-20T3-3D	17.0-17.9	20	25	54	77.9	50	2.59	17		
180-189-25T2-3D	18.0-18.9	25	32	57	82.5	56	2.73	18		
190-199-25T2-3D	19.0-19.9	25	32	60	87.0	56	2.88	19		
200-209-25T2-3D	20.0-20.9	25	32	63	91.6	56	3.02	20		
210-219-25T2-3D	21.0-21.9	25	32	66	96.2	56	3.18	21		
220-229-25T2-3D	22.0-22.9	25	32	69	100.8	56	3.24	22		
230-239-32T2-3D	23.0-23.9	32	42	72	105.3	60	3.46	23		
240-249-32T2-3D	24.0-24.9	32	42	76	109.9	60	3.62	24		
250-259-32T2-3D	25.0-25.9	32	42	79	114.5	60	3.80	25		

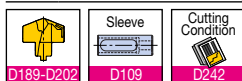

- ▶ OAL: LPR+LS
- ▶ SSC: Seat size code

TCD...S0-3D



Head changeable drill holders - Cylindrical type shank



- Drilling depth: 3x diameter

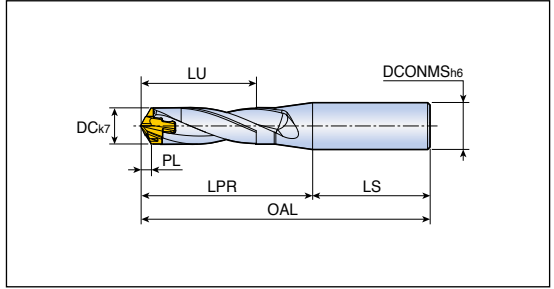

Designation	Dimension (mm)							Clamping key	
	DC	DCONMS	LU	LPR	LS	PL	SSC		
TCD 060-064-12S0-3D	6.0-6.4	12	19	32.0	45	0.96	6	K TCD D060-D099	
065-069-12S0-3D	6.5-6.9	12	21	33.8	45	1.18	6.5		
070-074-12S0-3D	7.0-7.4	12	22	35.6	45	1.01	7		
075-079-12S0-3D	7.5-7.9	12	24	37.1	45	1.10	7		
080-084-12S0-3D	8.0-8.4	12	25	39.4	45	1.20	8		
085-089-12S0-3D	8.5-8.9	12	27	40.9	45	1.29	8		
090-094-12S0-3D	9.0-9.4	12	28	42.8	45	1.35	9		
095-099-12S0-3D	9.5-9.9	12	30	44.3	45	1.44	9		
100-104-16S0-3D	10.0-10.4	16	32	46.2	48	1.50	10		K TCD D100-D199
105-109-16S0-3D	10.5-10.9	16	34	47.7	48	1.59	10		
110-114-16S0-3D	11.0-11.4	16	35	49.6	48	1.67	11		
115-119-16S0-3D	11.5-11.9	16	37	51.1	48	1.76	11		
120-124-16S0-3D	12.0-12.4	16	38	53.0	48	1.82	12		
125-129-16S0-3D	12.5-12.9	16	39	54.5	48	1.91	12		
130-134-16S0-3D	13.0-13.4	16	41	56.6	48	1.96	13		
135-139-16S0-3D	13.5-13.9	16	43	58.1	48	2.05	13		
140-144-16S0-3D	14.0-14.4	16	44	62.1	48	2.12	14		
145-149-16S0-3D	14.5-14.9	16	46	63.7	48	2.21	14		
150-159-20S0-3D	15.0-15.9	20	47	68.7	50	2.27	15	K TCD D200-D269	
160-169-20S0-3D	16.0-16.9	20	50	73.3	50	2.42	16		
170-179-20S0-3D	17.0-17.9	20	54	77.9	50	2.59	17		
180-189-25S0-3D	18.0-18.9	25	57	82.5	56	2.73	18		
190-199-25S0-3D	19.0-19.9	25	60	87.0	56	2.88	19		
200-209-25S0-3D	20.0-20.9	25	63	91.6	56	3.02	20		
210-219-25S0-3D	21.0-21.9	25	66	96.2	56	3.18	21		
220-229-25S0-3D	22.0-22.9	25	69	100.8	56	3.24	22		
230-239-32S0-3D	23.0-23.9	32	72	105.3	60	3.46	23		
240-249-32S0-3D	24.0-24.9	32	76	109.9	60	3.62	24		
250-259-32S0-3D	25.0-25.9	32	79	114.5	60	3.80	25		

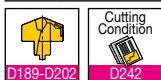

- ▶ OAL: LPR+LS
- ▶ SSC: Seat size code

Head changeable drill holders - Weldon type shank



- Drilling depth: 5xdiameter

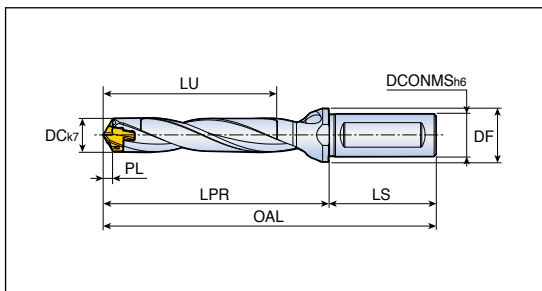

Designation	Dimension (mm)								Clamping key	
	DC	DCONMS	DF	LU	LPR	LS	PL	SSC		
TCD 060-064-12T3-5D	6.0-6.4	12	16	31	44.0	45	0.96	6	K TCD D060-D099	
065-069-12T3-5D	6.5-6.9	12	16	34	46.8	45	1.18	6.5		
070-074-12T3-5D	7.0-7.4	12	16	36	49.6	45	1.01	7		
075-079-12T3-5D	7.5-7.9	12	16	39	52.1	45	1.10	7		
080-084-12T3-5D	8.0-8.4	12	16	41	55.4	45	1.20	8		
085-089-12T3-5D	8.5-8.9	12	16	44	57.9	45	1.29	8		
090-094-12T3-5D	9.0-9.4	12	16	46	60.8	45	1.35	9		
095-099-12T3-5D	9.5-9.9	12	16	49	63.3	45	1.44	9		
100-104-16T3-5D	10.0-10.4	16	20	52	66.2	48	1.50	10		K TCD D100-D199
105-109-16T3-5D	10.5-10.9	16	20	55	68.7	48	1.59	10		
110-114-16T3-5D	11.0-11.4	16	20	57	71.6	48	1.67	11		
115-119-16T3-5D	11.5-11.9	16	20	60	74.1	48	1.76	11		
120-124-16T3-5D	12.0-12.4	16	20	62	77.0	48	1.82	12		
125-129-16T3-5D	12.5-12.9	16	20	64	79.5	48	1.91	12		
130-134-16T3-5D	13.0-13.4	16	20	67	82.6	48	1.96	13		
135-139-16T3-5D	13.5-13.9	16	20	70	85.1	48	2.05	13		
140-144-16T3-5D	14.0-14.4	16	20	72	90.2	48	2.12	14		
145-149-16T3-5D	14.5-14.9	16	20	75	92.7	48	2.21	14		
150-159-20T3-5D	15.0-15.9	20	25	77	98.7	50	2.27	15	K TCD D200-D269	
160-169-20T3-5D	16.0-16.9	20	25	82	105.3	50	2.42	16		
170-179-20T3-5D	17.0-17.9	20	25	88	111.9	50	2.59	17		
180-189-25T2-5D	18.0-18.9	25	32	93	118.5	56	2.73	18		
190-199-25T2-5D	19.0-19.9	25	32	98	125.0	56	2.88	19		
200-209-25T2-5D	20.0-20.9	25	32	103	131.6	56	3.02	20		
210-219-25T2-5D	21.0-21.9	25	32	108	138.2	56	3.18	21		
220-229-25T2-5D	22.0-22.9	25	32	113	144.8	56	3.24	22		
230-239-32T2-5D	23.0-23.9	32	42	118	151.3	60	3.46	23		
240-249-32T2-5D	24.0-24.9	32	42	124	157.9	60	3.62	24		
250-259-32T2-5D	25.0-25.9	32	42	129	164.5	60	3.80	25		

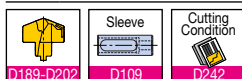

- ▶ OAL: LPR+LS
- ▶ SSC: Seat size code

TCD...S0-5D



Head changeable drill holders - Cylindrical type shank



- Drilling depth: 5x diameter

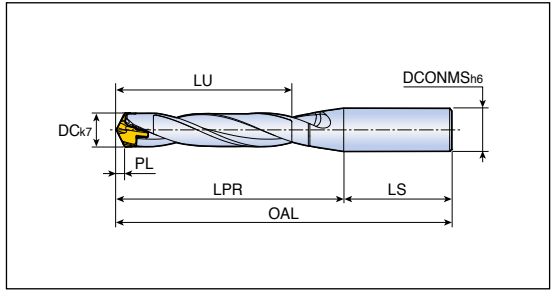

Designation	Dimension (mm)							Clamping key	
	DC	DCONMS	LU	LPR	LS	PL	SSC		
TCD 060-064-12S0-5D	6.0-6.4	12	31	44.0	45	0.96	6	K TCD D060-D099	
065-069-12S0-5D	6.5-6.9	12	34	46.8	45	1.18	6.5		
070-074-12S0-5D	7.0-7.4	12	36	49.6	45	1.01	7		
075-079-12S0-5D	7.5-7.9	12	39	52.1	45	1.10	7		
080-084-12S0-5D	8.0-8.4	12	41	55.4	45	1.20	8		
085-089-12S0-5D	8.5-8.9	12	44	57.9	45	1.29	8		
090-094-12S0-5D	9.0-9.4	12	46	60.8	45	1.35	9		
095-099-12S0-5D	9.5-9.9	12	49	63.3	45	1.44	9		
100-104-16S0-5D	10.0-10.4	16	52	66.2	48	1.50	10		K TCD D100-D199
105-109-16S0-5D	10.5-10.9	16	55	68.7	48	1.59	10		
110-114-16S0-5D	11.0-11.4	16	57	71.6	48	1.67	11		
115-119-16S0-5D	11.5-11.9	16	60	74.1	48	1.76	11		
120-124-16S0-5D	12.0-12.4	16	62	77.0	48	1.82	12		
125-129-16S0-5D	12.5-12.9	16	64	79.5	48	1.91	12		
130-134-16S0-5D	13.0-13.4	16	67	82.6	48	1.96	13		
135-139-16S0-5D	13.5-13.9	16	70	85.1	48	2.05	13		
140-144-16S0-5D	14.0-14.4	16	72	90.2	48	2.12	14		
145-149-16S0-5D	14.5-14.9	16	75	92.7	48	2.21	14		
150-159-20S0-5D	15.0-15.9	20	77	98.7	50	2.27	15	K TCD D200-D269	
160-169-20S0-5D	16.0-16.9	20	82	105.3	50	2.42	16		
170-179-20S0-5D	17.0-17.9	20	88	111.9	50	2.59	17		
180-189-25S0-5D	18.0-18.9	25	93	118.5	56	2.73	18		
190-199-25S0-5D	19.0-19.9	25	98	125.0	56	2.88	19		
200-209-25S0-5D	20.0-20.9	25	103	131.6	56	3.02	20		
210-219-25S0-5D	21.0-21.9	25	108	138.2	56	3.18	21		
220-229-25S0-5D	22.0-22.9	25	113	144.8	56	3.24	22		
230-239-32S0-5D	23.0-23.9	32	118	151.3	60	3.46	23		
240-249-32S0-5D	24.0-24.9	32	124	157.9	60	3.62	24		
250-259-32S0-5D	25.0-25.9	32	129	164.5	60	3.80	25		

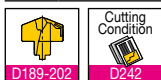

- ▶ OAL: LPR+LS
- ▶ SSC: Seat size code

TCD...T...-8D



Head changeable drill holders - Weldon type shank



- Drilling depth: 8xdiameter

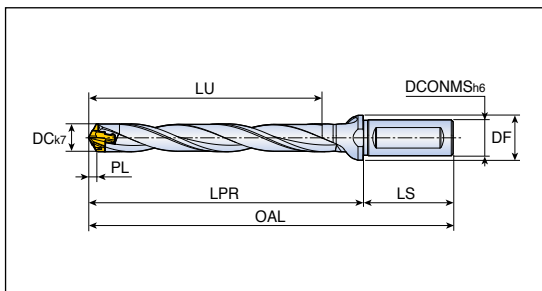

Designation	Dimension (mm)								Clamping key
	DC	DCONMS	DF	LU	LPR	LS	PL	SSC	
TCD 070-074-12T3-8D	7.0-7.4	12	16	57	70.6	45	1.01	7	K TCD D060-D099
075-079-12T3-8D	7.5-7.9	12	16	61	74.6	45	1.10	7	
080-084-12T3-8D	8.0-8.4	12	16	65	79.4	45	1.20	8	
085-089-12T3-8D	8.5-8.9	12	16	69	83.4	45	1.29	8	
090-094-12T3-8D	9.0-9.4	12	16	73	87.8	45	1.35	9	
095-099-12T3-8D	9.5-9.9	12	16	77	91.8	45	1.44	9	
100-104-16T3-8D	10.0-10.4	16	20	82	96.2	48	1.50	10	K TCD D100-D199
105-109-16T3-8D	10.5-10.9	16	20	86	100.2	48	1.59	10	
110-114-16T3-8D	11.0-11.4	16	20	90	104.6	48	1.67	11	
115-119-16T3-8D	11.5-11.9	16	20	94	108.6	48	1.76	11	
120-124-16T3-8D	12.0-12.4	16	20	98	113.0	48	1.82	12	
125-129-16T3-8D	12.5-12.9	16	20	102	117.0	48	1.91	12	
130-134-16T3-8D	13.0-13.4	16	20	106	121.6	48	1.96	13	
135-139-16T3-8D	13.5-13.9	16	20	110	125.6	48	2.05	13	
140-144-16T3-8D	14.0-14.4	16	20	114	132.2	48	2.12	14	
145-149-16T3-8D	14.5-14.9	16	20	118	136.2	48	2.21	14	
150-159-20T3-8D	15.0-15.9	20	25	122	143.7	50	2.27	15	K TCD D200-D269
160-169-20T3-8D	16.0-16.9	20	25	130	153.3	50	2.42	16	
170-179-20T3-8D	17.0-17.9	20	25	139	162.9	50	2.59	17	
180-189-25T2-8D	18.0-18.9	25	32	147	172.5	56	2.73	18	
190-199-25T2-8D	19.0-19.9	25	32	155	182.0	56	2.88	19	
200-209-25T2-8D	20.0-20.9	25	32	163	191.6	56	3.02	20	
210-219-25T2-8D	21.0-21.9	25	32	171	201.2	56	3.18	21	
220-229-25T2-8D	22.0-22.9	25	32	179	210.8	56	3.24	22	
230-239-32T2-8D	23.0-23.9	32	42	187	220.3	60	3.46	23	
240-249-32T2-8D	24.0-24.9	32	42	196	229.9	60	3.62	24	
250-259-32T2-8D	25.0-25.9	32	42	204	239.5	60	3.80	25	



- ▶ It is recommended to make the pilot hole with a 1.5D holder
- ▶ OAL: LPR+LS
- ▶ SSC: Seat size code

TCD...S0-8D

Head changeable drill holders - Cylindrical type shank



- Drilling depth: 8x diameter

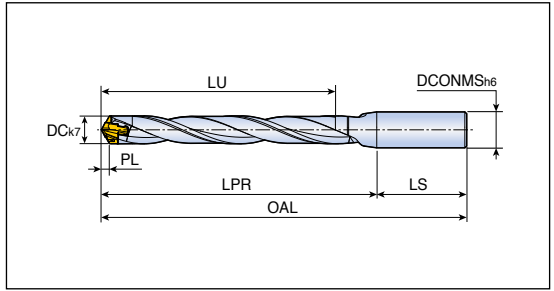

Designation	Dimension (mm)							Clamping key	
	DC	DCONMS	LU	LPR	LS	PL	SSC		
TCD 060-064-12S0-8D	6.0-6.4	12	49	62.0	45	0.96	6	K TCD D060-D099	
065-069-12S0-8D	6.5-6.9	12	53	66.3	45	1.18	6.5		
070-074-12S0-8D	7.0-7.4	12	57	70.6	45	1.01	7		
075-079-12S0-8D	7.5-7.9	12	61	74.6	45	1.10	7		
080-084-12S0-8D	8.0-8.4	12	65	79.4	45	1.20	8		
085-089-12S0-8D	8.5-8.9	12	69	83.4	45	1.29	8		
090-094-12S0-8D	9.0-9.4	12	73	87.8	45	1.35	9		
095-099-12S0-8D	9.5-9.9	12	77	91.8	45	1.44	9		
100-104-16S0-8D	10.0-10.4	16	82	96.2	48	1.50	10		K TCD D100-D199
105-109-16S0-8D	10.5-10.9	16	86	100.2	48	1.59	10		
110-114-16S0-8D	11.0-11.4	16	90	104.6	48	1.67	11		
115-119-16S0-8D	11.5-11.9	16	94	108.6	48	1.76	11		
120-124-16S0-8D	12.0-12.4	16	98	113.0	48	1.82	12		
125-129-16S0-8D	12.5-12.9	16	102	117.0	48	1.91	12		
130-134-16S0-8D	13.0-13.4	16	106	121.6	48	1.96	13		
135-139-16S0-8D	13.5-13.9	16	110	125.6	48	2.05	13		
140-144-16S0-8D	14.0-14.4	16	114	132.2	48	2.12	14		
145-149-16S0-8D	14.5-14.9	16	118	136.2	48	2.21	14		
150-159-20S0-8D	15.0-15.9	20	122	143.7	50	2.27	15	K TCD D200-D269	
160-169-20S0-8D	16.0-16.9	20	130	153.3	50	2.42	16		
170-179-20S0-8D	17.0-17.9	20	139	162.9	50	2.59	17		
180-189-25S0-8D	18.0-18.9	25	147	172.5	56	2.73	18		
190-199-25S0-8D	19.0-19.9	25	155	182.0	56	2.88	19		
200-209-25S0-8D	20.0-20.9	25	163	191.6	56	3.02	20		
210-219-25S0-8D	21.0-21.9	25	171	201.2	56	3.18	21		
220-229-25S0-8D	22.0-22.9	25	179	210.8	56	3.24	22		
230-239-32S0-8D	23.0-23.9	32	187	220.3	60	3.46	23		
240-249-32S0-8D	24.0-24.9	32	196	229.9	60	3.62	24		
250-259-32S0-8D	25.0-25.9	32	204	239.5	60	3.80	25		



- ▶ It is recommended to make the pilot hole with a 1.5D holder
- ▶ OAL: LPR+LS
- ▶ SSC: Seat size code

TCD...S0-12D



Head changeable drill holders - Cylindrical type shank

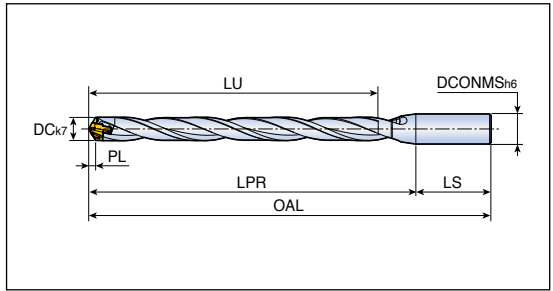

• Drilling depth: 12xdiameter



Designation	Dimension (mm)							Clamping key
	DC	DCONMS	LU	LPR	LS	PL	SSC	
TCD 080-084-12S0-12D	8.0-8.4	12	97	111.4	45	1.20	8	K TCD D060-D099
085-089-12S0-12D	8.5-8.9	12	103	117.4	45	1.29	8	
090-094-12S0-12D	9.0-9.4	12	109	123.8	45	1.35	9	
095-099-12S0-12D	9.5-9.9	12	115	129.8	45	1.44	9	
100-104-16S0-12D	10.0-10.4	16	122	136.2	48	1.50	10	K TCD D100-D199
105-109-16S0-12D	10.5-10.9	16	128	142.2	48	1.59	10	
110-114-16S0-12D	11.0-11.4	16	134	148.6	48	1.67	11	
115-119-16S0-12D	11.5-11.9	16	140	154.6	48	1.76	11	
120-124-16S0-12D	12.0-12.4	16	146	161.0	48	1.82	12	
125-129-16S0-12D	12.5-12.9	16	152	167.0	48	1.91	12	
130-134-16S0-12D	13.0-13.4	16	158	173.6	48	1.96	13	
135-139-16S0-12D	13.5-13.9	16	164	179.6	48	2.05	13	
140-144-16S0-12D	14.0-14.4	16	170	188.2	48	2.12	14	
145-149-16S0-12D	14.5-14.9	16	176	194.2	48	2.21	14	
150-159-20S0-12D	15.0-15.9	20	182	203.7	50	2.27	15	K TCD D200-D269
160-169-20S0-12D	16.0-16.9	20	194	217.3	50	2.42	16	
170-179-20S0-12D	17.0-17.9	20	207	230.9	50	2.59	17	
180-189-25S0-12D	18.0-18.9	25	219	244.5	56	2.73	18	
190-199-25S0-12D	19.0-19.9	25	221	258.0	56	2.88	19	
200-209-25S0-12D	20.0-20.9	25	243	271.6	56	3.02	20	
210-219-25S0-12D	21.0-21.9	25	255	285.2	56	3.18	21	
220-229-25S0-12D	22.0-22.9	25	267	298.8	56	3.24	22	
230-239-32S0-12D	23.0-23.9	32	289	312.3	60	3.46	23	
240-249-32S0-12D	24.0-24.9	32	292	325.9	60	3.62	24	
250-259-32S0-12D	25.0-25.9	32	304	339.5	60	3.80	25	



► It is recommended to make the pilot hole with a 1.5D holder
 ► OAL: LPR+LS
 ► SSC: Seat size code

Head changeable drill holders for pre-thread hole

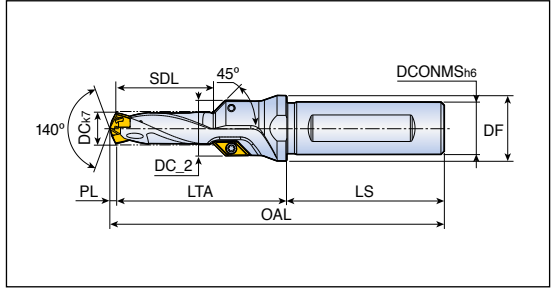

Designation	ISO thread	DC	Dimension (mm)							Drill dia. range	Insert
			SDL	LTA	LS	DC_2	DCONMS	DF	PL		
TCD 068x21x12T3-M8	M8	6.8	21	43.77	45	13.5	12	16	1.23	6.5-6.9	AOMT 06...-C45 D203
085x26x12T3-M10	M10	8.5	26	48.71	45	15.5	12	16	1.29	8.5-8.9	
102x30x16T3-M12	M12	10.2	30	52.46	48	17.0	16	20	1.54	10.0-10.4	
120x35x16T3-M14	M14	12.0	35	59.18	48	19.0	16	20	1.82	12.0-12.4	
140x39x20T3-M16	M16	14.0	39	66.88	50	21.0	20	25	2.12	14.0-14.4	
175x42x20T3-M20	M20	17.5	42	69.32	50	24.5	20	27	2.68	17.0-17.9	
210x48x25T2-M24	M24	21.0	48	76.82	56	28.0	25	32	3.18	21.0-21.9	

▶ OAL: LTA+LS+PL

Spare parts

Designation	Screw 	Wrench 	Clamping key 	
TCD 068	TS 22046I	TD 7	K TCD D060-D099	
TCD 085	TS 22046I	TD 7	K TCD D060-D099	
TCD 102 - 175	TS 22046I	TD 7	K TCD D100-D199	
TCD 210	TS 22046I	TD 7	K TCD D200-D269	



Plug for coolant supply in a stationary machines

TaeguTec supplies special plugs with an internal thread for coolant connections used on lathes that can be pressed into the cavity on the back end of the shank.

Description	Shank diameter	Internal thread
PL-TCD-12	12	G 1/16
PL-TCD-16	16	G 1/16
PL-TCD-20	20	G 1/8
PL-TCD-25	25	G 1/8
PL-TCD-32	32	G 1/8



Chamfering ring tools

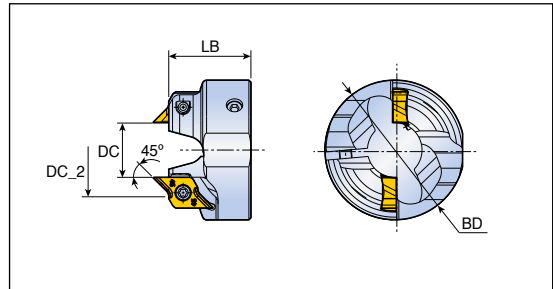

Designation	Dimension (mm)				Chamfer size	Chamfer insert
	DC	DC_2	BD	LB		
CFR D100-A45	9.8	16.56	34	20	2.5	CRNG 08...-45CD D203
D105-A45	10.3	17.06	34	20	2.5	
D110-A45	10.8	17.56	34	20	2.5	
D115-A45	11.3	18.06	34	20	2.5	
D120-A45	11.8	18.56	34	20	2.5	
D125-A45	12.3	19.06	34	20	2.5	
D130-A45	12.8	19.56	34	20	2.5	
D135-A45	13.3	20.06	34	20	2.5	
D140-A45	13.8	20.56	38	22	2.5	
D145-A45	14.3	21.06	38	22	2.5	
D150-A45	14.6	21.36	38	22	2.5	
D160-A45	15.6	22.36	42	23	2.5	
D170-A45	16.6	23.36	42	23	2.5	
D180-A45	17.6	24.36	42	23	2.5	
D190-A45	18.6	25.36	42	24	2.5	
D200-A45	19.6	26.36	42	24	2.5	
D210-A45	20.6	27.36	47	24	2.5	
D220-A45	21.6	28.36	47	24	2.5	
D230-A45	22.6	29.36	47	24	2.5	
D240-A45	23.6	30.36	47	24	2.5	
D250-A45	24.6	31.36	47	24	2.5	

Spare parts

Designation	Insert screw 	Wrench 	Clamping screw 	L-wrench
CFR D100 - D135	SO 25065I	TD 7	SH M3x0.5x10 ⁽¹⁾	L-W2.5
CFR D140 - D150	SO 25065I	TD 7	SH M4x0.7x12 ⁽²⁾	L-W3
CFR D160 - D250	SO 25065I	TD 7	SH M5x0.8x16 ⁽³⁾	L-W4



► ⁽¹⁾ Clamping torque: 2-3 [N•m] ⁽²⁾ Clamping torque: 3.5-4.5 [N•m] ⁽³⁾ Clamping torque: 5-6 [N•m]

TCD...A0-3D/5D/8D



Head changeable drill holders - Cylindrical type shank



• Drilling depth: 3/5/8xdiameter

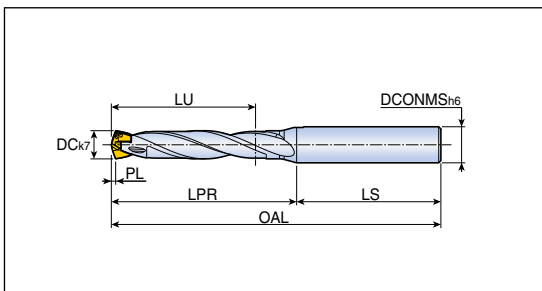

Designation	Dimension (mm)							Clamping key
	DC	DCONMS	LU	LPR	LS	PL	SSC	
TCD 060-064-08A0-3D	6.0-6.4	8	19	28.0	36	0.96	6	K TCD D060-D099
065-069-08A0-3D	6.5-6.9	8	21	29.8	36	1.18	6.5	
070-074-08A0-3D	7.0-7.4	8	22	31.6	36	1.01	7	
075-079-08A0-3D	7.5-7.9	8	24	33.1	36	1.10	7.5	
080-084-10A0-3D	8.0-8.4	10	25	35.4	40	1.20	8	
085-089-10A0-3D	8.5-8.9	10	27	36.9	40	1.29	8.5	
090-094-10A0-3D	9.0-9.4	10	28	38.8	40	1.35	9	
095-099-10A0-3D	9.5-9.9	10	30	40.3	40	1.44	9.5	
TCD 060-064-08A0-5D	6.0-6.4	8	31	40.0	36	0.96	6	
065-069-08A0-5D	6.5-6.9	8	34	42.8	36	1.18	6.5	
070-074-08A0-5D	7.0-7.4	8	36	45.6	36	1.01	7	
075-079-08A0-5D	7.5-7.9	8	39	48.1	36	1.10	7.5	
080-084-10A0-5D	8.0-8.4	10	41	51.4	40	1.20	8	
085-089-10A0-5D	8.5-8.9	10	44	53.9	40	1.29	8.5	
090-094-10A0-5D	9.0-9.4	10	46	56.8	40	1.35	9	
095-099-10A0-5D	9.5-9.9	10	49	59.3	40	1.44	9.5	
TCD 060-064-08A0-8D	6.0-6.4	8	49	58.0	36	0.96	6	K TCD D060-D099
065-069-08A0-8D	6.5-6.9	8	53	62.3	36	1.18	6.5	
070-074-08A0-8D	7.0-7.4	8	57	66.6	36	1.01	7	
075-079-08A0-8D	7.5-7.9	8	61	70.6	36	1.10	7.5	
080-084-10A0-8D	8.0-8.4	10	65	75.4	40	1.20	8	
085-089-10A0-8D	8.5-8.9	10	69	79.4	40	1.29	8.5	
090-094-10A0-8D	9.0-9.4	10	73	83.8	40	1.35	9	
095-099-10A0-8D	9.5-9.9	10	77	87.8	40	1.44	9.5	

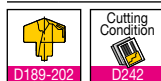

▶ OAL: LPR+LS
▶ SSC: Seat size code

TCDM...-M12-2D



Head changeable drill holder with T-FLEXTEC type shank



- Drilling depth: 2x diameter

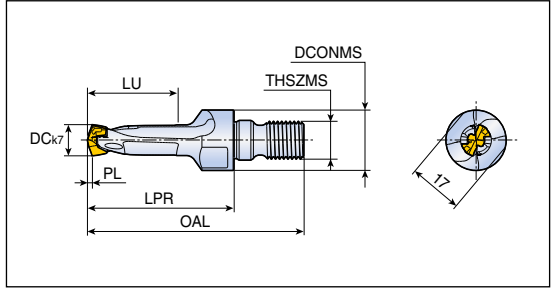

Designation	Dimension (mm)								Clamping key	
	DC	DCONMS	LU	LPR	PL	OAL	THSZMS	SSC		
TCDM 100-104-M12-2D	10.0-10.4	19	28.7	46.2	1.5	68.2	M12	10	K TCD D100-D199	
105-109-M12-2D	10.5-10.9	19	29.7	47.2	1.6	69.2	M12	10		
110-114-M12-2D	11.0-11.4	19	31.1	48.6	1.7	70.6	M12	11		
115-119-M12-2D	11.5-11.9	19	32.1	49.6	1.8	71.6	M12	11		
120-124-M12-2D	12.0-12.4	19	33.5	51.0	1.8	73.0	M12	12		
125-129-M12-2D	12.5-12.9	19	34.5	52.0	1.9	74.0	M12	12		
130-134-M12-2D	13.0-13.4	19	36.1	53.6	2.0	75.6	M12	13		
135-139-M12-2D	13.5-13.9	19	37.1	54.6	2.1	76.6	M12	13		
140-144-M12-2D	14.0-14.4	19	38.7	56.2	2.1	78.2	M12	14		
145-149-M12-2D	14.5-14.9	19	39.7	57.2	2.2	79.2	M12	14		
150-159-M12-2D	15.0-15.9	19	41.2	58.7	2.3	80.7	M12	15		

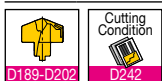

- ▶ SSC: Seat size code
- ▶ Matched with T-FLEXTEC holder

TCDM...-M12-3D



Head changeable drill holder with T-FLEXTEC type shank



- Drilling depth: 3xdiameter

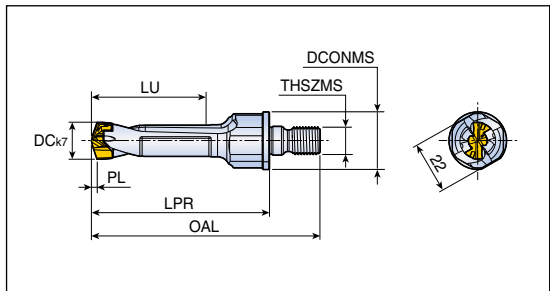

Designation	Dimension (mm)								Clamping key	
	DC	DCONMS	LU	LPR	PL	OAL	THSZMS	SSC		
TCDM 060-064-M12-3D	6.0-6.4	25	19.0	42.0	1.0	64.0	M12	6	K TCD D060-D099	
065-069-M12-3D	6.5-6.9	25	20.7	44.3	1.2	66.3	M12	6.5		
070-074-M12-3D	7.0-7.4	25	22.0	45.6	1.0	67.6	M12	7		
075-079-M12-3D	7.5-7.9	25	23.6	47.6	1.1	69.6	M12	7		
080-084-M12-3D	8.0-8.4	25	25.2	49.4	1.2	71.4	M12	8		
085-089-M12-3D	8.5-8.9	25	26.8	50.4	1.3	72.4	M12	8		
090-094-M12-3D	9.0-9.4	25	28.4	52.8	1.4	74.8	M12	9		
095-099-M12-3D	9.5-9.9	25	29.9	54.8	1.4	76.8	M12	9		
100-104-M12-3D	10.0-10.4	25	31.5	56.2	1.5	78.2	M12	10		K TCD D100-D199
105-109-M12-3D	10.5-10.9	25	33.1	58.2	1.6	80.2	M12	10		
110-114-M12-3D	11.0-11.4	25	34.7	59.6	1.7	81.6	M12	11		
115-119-M12-3D	11.5-11.9	25	36.3	61.6	1.8	83.6	M12	11		
120-124-M12-3D	12.0-12.4	25	37.8	63.0	1.8	85.0	M12	12		
125-129-M12-3D	12.5-12.9	25	39.4	64.0	1.9	86.0	M12	12		
130-134-M12-3D	13.0-13.4	25	41.0	66.6	2.0	88.6	M12	13		
135-139-M12-3D	13.5-13.9	25	42.6	68.6	2.1	90.6	M12	13		
140-144-M12-3D	14.0-14.4	25	44.1	70.2	2.1	92.2	M12	14		
145-149-M12-3D	14.5-14.9	25	45.7	72.2	2.2	94.2	M12	14		
150-159-M12-3D	15.0-15.9	25	47.3	73.7	2.3	95.7	M12	15		
160-169-M12-3D	16.0-16.9	25	50.4	77.3	2.4	99.3	M12	16		
170-179-M12-3D	17.0-17.9	25	53.6	80.9	2.6	102.9	M12	17	K TCD D200-D269	
180-189-M12-3D	18.0-18.9	25	56.7	84.5	2.7	106.5	M12	18		
190-199-M12-3D	19.0-19.9	25	59.9	88.0	2.9	110.0	M12	19		
200-209-M12-3D	20.0-20.9	25	63.0	91.6	3.0	113.6	M12	20		



- ▶ SSC: Seat size code
- ▶ Matched with T-FLEXTEC holder

TCDM...-M12-4D





Head changeable drill holder with T-FLEXTEC type shank

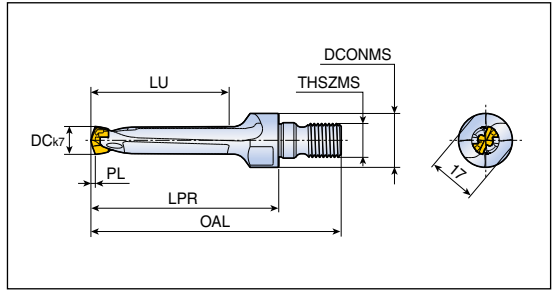

- Drilling depth: 4x diameter



Designation	Dimension (mm)								Clamping key	
	DC	DCONMS	LU	LPR	PL	OAL	THSZMS	SSC		
TCDM 100-104-M12-4D	10.0-10.4	19	48.7	66.2	1.5	88.2	M12	10	K TCD D100-D199	
105-109-M12-4D	10.5-10.9	19	50.7	68.2	1.6	90.2	M12	10		
110-114-M12-4D	11.0-11.4	19	53.1	70.6	1.7	92.6	M12	11		
115-119-M12-4D	11.5-11.9	19	55.1	72.6	1.8	94.6	M12	11		
120-124-M12-4D	12.0-12.4	19	57.5	75.0	1.8	97.0	M12	12		
125-129-M12-4D	12.5-12.9	19	59.5	77.0	1.9	99.0	M12	12		
130-134-M12-4D	13.0-13.4	19	62.1	79.6	2.0	101.6	M12	13		
135-139-M12-4D	13.5-13.9	19	64.1	81.6	2.1	103.6	M12	13		
140-144-M12-4D	14.0-14.4	19	66.7	84.2	2.1	106.2	M12	14		
145-149-M12-4D	14.5-14.9	19	68.7	86.2	2.2	108.2	M12	14		
150-159-M12-4D	15.0-15.9	19	71.2	88.7	2.3	110.7	M12	15		

 D189-D202 D242

- ▶ SSC: Seat size code
- ▶ Matched with T-FLEXTEC holder

Modular drill heads

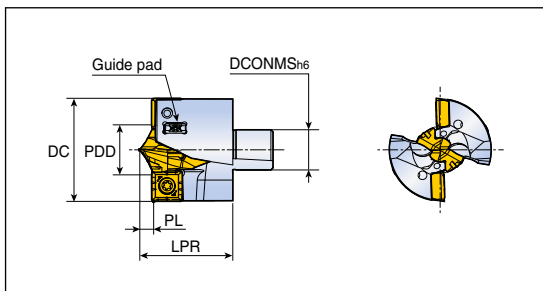

Designation	Dimension (mm)					Clamping Key	Insert	
	DC	DCONMS	LPR	PL	PDD		Center	Outer
TNDH 2600-C26-TP	26	10.4	24.9	3.98	15.9	K TCD D15-D16 CO	TCD-159-P-CO+	SPGX 06...DW
2700-C26-TP	27	10.4	25.4	4.14	16.9	K TCD D15-D16 CO	TCD-169-P-CO+	D204
2800-C28-TP	28	11.2	26.9	4.29	17.9	K TCD D17-D19 CO	TCD-179-P-CO+	
2900-C28-TP	29	11.2	26.6	3.97	15.9	K TCD D15-D16 CO	TCD-159-P-CO+	SPGX 07...DW
3000-C30-TP	30	12.0	28.3	4.14	16.9	K TCD D15-D16 CO	TCD-169-P-CO+	D204
3100-C30-TP	31	12.0	28.5	4.30	17.9	K TCD D17-D19 CO	TCD-179-P-CO+	
3200-C32-TP	32	12.8	30.3	4.46	18.9	K TCD D17-D19 CO	TCD-189-P-CO+	
3300-C32-TP	33	12.8	29.8	3.97	15.9	K TCD D15-D16 CO	TCD-159-P-CO+	SPGX 09...DW
3400-C34-TP	34	13.6	31.6	4.14	16.9	K TCD D15-D16 CO	TCD-169-P-CO+	D204
3500-C34-TP	35	13.6	31.8	4.30	17.9	K TCD D17-D19 CO	TCD-179-P-CO+	
3600-C36-TP	36	14.4	33.5	4.46	18.9	K TCD D17-D19 CO	TCD-189-P-CO+	
3700-C36-TP	37	14.4	33.3	4.14	16.9	K TCD D15-D16 CO	TCD-169-P-CO+	SPGX 11...DW
3800-C38-TP	38	15.2	35.0	4.30	17.9	K TCD D17-D19 CO	TCD-179-P-CO+	D204
3900-C38-TP	39	15.2	35.2	4.46	18.9	K TCD D17-D19 CO	TCD-189-P-CO+	
4000-C40-TP	40	16.0	36.9	4.62	19.9	K TCD D17-D19 CO	TCD-199-P-CO+	
4100-C40-TP	41	16.0	37.1	4.78	20.9	K TCD D20-D21 CO	TCD-209-P-CO+	
4200-C42-TP	42	16.8	38.9	4.95	21.9	K TCD D20-D21 CO	TCD-219-P-CO+	
4300-C42-TP	43	16.8	38.9	5.11	22.9	K TCD D22-D23 CO	TCD-229-P-CO+	

- ▶ DCONMS: Holder connection size
- ▶ Guide pad is sold separately from drill head

Spare parts

Designation	For double pitch screw		For SPGX		For Guide pad	
	Screw1	Wrench1	Screw2	Wrench2	Screw3	Wrench3
TNDH 2600-2800	TDPS 0512-T7	TD 7	TS 220521/HG	TD 7	TS 200431/HG-P	TD 6P
TNDH 2900-3200	TDPS 0512-T7	TD 7	TS 250641	TD 8	TS 200431/HG-P	TD 6P
TNDH 3300-3500	TDPS 0512-T7	TD 7	TS 350881	TD 10	TS 200431/HG-P	TD 6P
TNDH 3600	TDPS 0618-T8	TD 8	TS 350881	TD 10	TS 200431/HG-P	TD 6P
TNDH 3700-4300	TDPS 0618-T8	TD 8	TS 400931	TD 15	TS 200431/HG-P	TD 6P

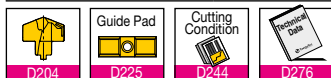

TNDH-TP



Modular drill heads

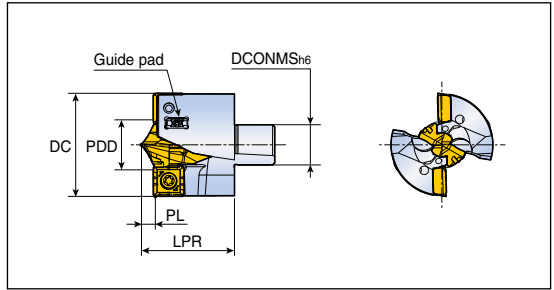

Designation	Dimension (mm)					Clamping Key	Insert	
	DC	DCONMS	LPR	PL	PDD		Center	Outer
TNDH 4400-C44-TP	44	17.6	40.8	5.28	23.9	K TCD D22-D23 CO	TCD-239-P-CO+	SPGX 11...DW
4500-C44-TP	45	17.6	41.0	5.44	24.9	K TCD D24-D25 CO	TCD-249-P-CO+	D204
4600-C46-TP	46	18.4	42.2	4.95	21.9	K TCD D20-D21 CO	TCD-219-P-CO+	SPGX 14...DW
4700-C46-TP	47	18.4	42.3	5.11	22.9	K TCD D22-D23 CO	TCD-229-P-CO+	D204
4800-C48-TP	48	19.2	44.0	5.28	23.9	K TCD D22-D23 CO	TCD-239-P-CO+	
4900-C48-TP	49	19.2	44.3	5.44	24.9	K TCD D24-D25 CO	TCD-249-P-CO+	
5000-C48-TP	50	19.2	46.0	5.61	25.9	K TCD D24-D25 CO	TCD-259-P-CO+	

- DCONMS: Holder connection size
- Guide pad is sold separately from drill head

Spare parts

Designation	For double pitch screw		For SPGX		For Guide pad	
	Screw1	Wrench1	Screw2	Wrench2	Screw3	Wrench3
TNDH 4400-4500	TDPS 0722-W3.0	F-W3.0	TS 40093I	TD 15	TS 20043I/HG-P	TD 6P
TNDH 4600-5000	TDPS 0722-W3.0	F-W3.0	SO 50090I	TD 20	TS 20043I/HG-P	TD 6P

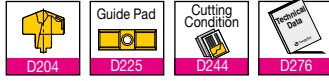

MDB...T2-3

Modular drill holders - Weldon type shank



- Drilling depth: 3x diameter

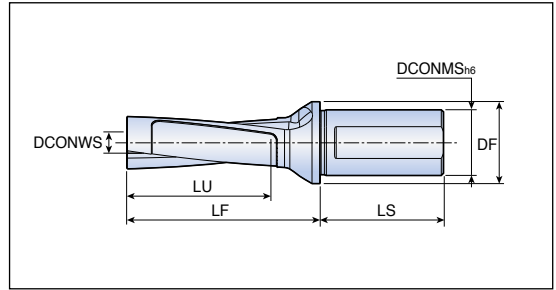

Designation	Dimension (mm)						
	DC	DCONWS	DCONMS	DF	LU	LF	LS
MDB D26/27-081-32T2-C26-3	26-27	10.4	32	40	60	94.3	60
D28/29-087-32T2-C28-3	28-29	11.2	32	40	64	100.5	60
D30/31-093-32T2-C30-3	30-31	12.0	32	40	69	105.5	60
D32/33-099-32T2-C32-3	32-33	12.8	32	40	73	111.7	60
D34/35-105-40T2-C34-3	34-35	13.6	40	50	78	120.2	68
D36/37-111-40T2-C36-3	36-37	14.4	40	50	82	126.5	68
D38/39-117-40T2-C38-3	38-39	15.2	40	50	86	131.4	68
D40/41-123-40T2-C40-3	40-41	16.0	40	50	91	137.6	68
D42/43-129-40T2-C42-3	42-43	16.8	40	50	95	143.8	68
D44/45-135-40T2-C44-3	44-45	17.6	40	50	99	150.0	68
D46/47-141-50T2-C46-3	46-47	18.4	50	60	104	154.5	80
D48/50-150-50T2-C48-3	48-50	19.2	50	60	111	160.9	80

- ▶ DC: Cutting diameter range
- ▶ DCONWS: Modular head connection size
- ▶ Refer to the Modular head information on page [D75-D76](#)

Spare parts

Designation	Wrench	Wrench handle		
MDB D26/27-D34/35-3	BLD H-W2.5x210	SW6-T-SH		
MDB D36/37-D42/43-3	BLD H-W3.0x225	SW6-T-SH		
MDB D44/45-D48/50-3	BLD H-W4.0x255	SW6-T-SH		

- ▶ Wrench: Disassemble the modular head from the modular body (Insert from the rear shank)



MDB...T2-5

Modular drill holders - Weldon type shank



- Drilling depth: 5x diameter

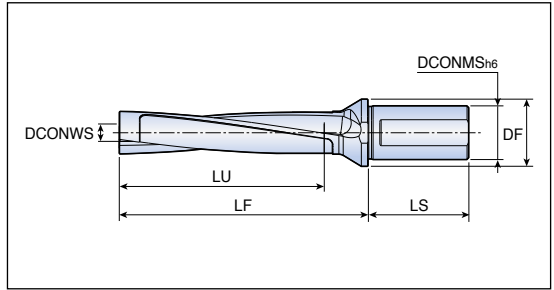

Designation	Dimension (mm)						
	DC	DCONWS	DCONMS	DF	LU	LF	LS
MDB D26/27-135-32T2-C26-5	26-27	10.4	32	40	114	148.3	60
D28/29-145-32T2-C28-5	28-29	11.2	32	40	122	158.5	60
D30/31-155-32T2-C30-5	30-31	12.0	32	40	131	167.5	60
D32/33-165-32T2-C32-5	32-33	12.8	32	40	139	177.7	60
D34/35-175-40T2-C34-5	34-35	13.6	40	50	148	190.2	68
D36/37-185-40T2-C36-5	36-37	14.4	40	50	156	200.5	68
D38/39-195-40T2-C38-5	38-39	15.2	40	50	164	209.4	68
D40/41-205-40T2-C40-5	40-41	16.0	40	50	173	219.6	68
D42/43-215-40T2-C42-5	42-43	16.8	40	50	181	229.8	68
D44/45-225-40T2-C44-5	44-45	17.6	40	50	189	240.0	68
D46/47-235-50T2-C46-5	46-47	18.4	50	60	198	248.5	80
D48/50-250-50T2-C48-5	48-50	19.2	50	60	211	258.9	80

- ▶ DC: Cutting diameter range
- ▶ DCONWS: Modular head connection size
- ▶ Refer to the Modular head information on page D75-D76

Spare parts

Designation	Wrench	Wrench handle		
MDB D26/27-D34/35-5	BLD H-W2.5x280	SW6-T-SH		
MDB D36/37-D42/43-5	BLD H-W3.0x310	SW6-T-SH		
MDB D44/45-D48/50-5	BLD H-W4.0x350	SW6-T-SH		

- ▶ Wrench: Disassemble the modular head from the modular body (Insert from the rear shank)



MDB...T2-7

Modular drill holders - Weldon type shank



- Drilling depth: 7x diameter

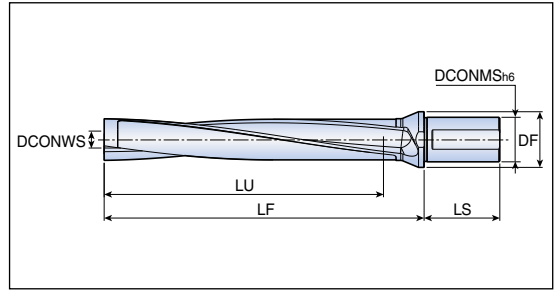

Designation	Dimension (mm)						
	DC	DCONWS	DCONMS	DF	LU	LF	LS
MDB D26/27-189-32T2-C26-7	26-27	10.4	32	40	168	202.3	60
D28/29-203-32T2-C28-7	28-29	11.2	32	40	180	216.5	60
D30/31-217-32T2-C30-7	30-31	12.0	32	40	193	229.5	60
D32/33-231-32T2-C32-7	32-33	12.8	32	40	205	243.7	60
D34/35-245-40T2-C34-7	34-35	13.6	40	50	218	260.2	68
D36/37-259-40T2-C36-7	36-37	14.4	40	50	230	274.5	68
D38/39-273-40T2-C38-7	38-39	15.2	40	50	242	287.4	68
D40/41-287-40T2-C40-7	40-41	16.0	40	50	255	301.6	68

- ▶ DC: Cutting diameter range
- ▶ DCONWS: Modular head connection size
- ▶ Refer to the Modular head information on page [D75-D76](#)

Spare parts

Designation	Wrench	Wrench handle		
MDB D26/27-7	BLD H-W2.5x280	SW6-T-SH		
MDB D28/29-D34/35-7	BLD H-W2.5x350	SW6-T-SH		
MDB D36/37-D40/41-7	BLD H-W3.0x400	SW6-T-SH		

- ▶ Wrench: Disassemble the modular head from the modular body (Insert from the rear shank)



Head changeable drill holders - Weldon type shank



- Drilling depth: 3x diameter

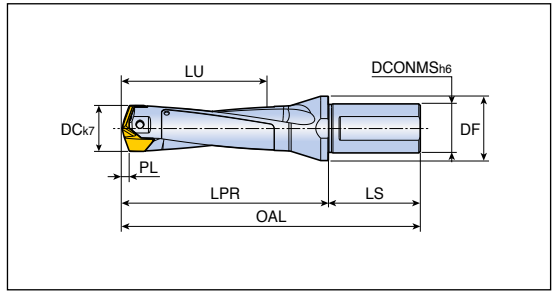

Designation	Dimension (mm)							
	DC	DCONMS	DF	LU	LPR	LS	PL	SSC
LCD 200-209-25T2-3D	20.0-20.9	25	32	63	92.1	56	3.11	20
210-219-25T2-3D	21.0-21.9	25	32	66	95.3	56	3.29	21
220-229-25T2-3D	22.0-22.9	25	32	69	98.4	56	3.42	22
230-239-25T2-3D	23.0-23.9	25	32	73	101.6	56	3.60	23
240-249-32T2-3D	24.0-24.9	32	40	76	110.7	60	3.73	24
250-259-32T2-3D	25.0-25.9	32	40	79	113.9	60	3.91	25
260-269-32T2-3D	26.0-26.9	32	40	82	117.0	60	4.04	26
270-279-32T2-3D	27.0-27.9	32	40	85	120.2	60	4.22	27
280-289-32T2-3D	28.0-28.9	32	40	88	128.4	60	4.35	28
290-299-32T2-3D	29.0-29.9	32	40	92	131.5	60	4.53	29
300-309-32T2-3D	30.0-30.9	32	42	95	134.7	60	4.67	30
310-319-32T2-3D	31.0-31.9	32	42	98	137.9	60	4.85	31
320-329-40T2-3D	32.0-32.9	40	48	101	143.0	68	4.98	32
330-339-40T2-3D	33.0-33.9	40	48	104	146.2	68	5.16	33
340-349-40T2-3D	34.0-34.9	40	48	107	149.3	68	5.34	34
350-359-40T2-3D	35.0-35.9	40	48	110	152.4	68	5.44	35
360-369-40T2-3D	36.0-36.9	40	48	114	155.6	68	5.62	36
370-379-40T2-3D	37.0-37.9	40	48	117	158.8	68	5.80	37
380-389-40T2-3D	38.0-38.9	40	50	120	166.9	68	5.91	38
390-399-40T2-3D	39.0-39.9	40	50	123	170.1	68	6.09	39
400-410-40T2-3D	40.0-41.0	40	50	126	173.3	68	6.27	40

► OAL: LPR+LS ► SSC: Seat size code

Spare parts

Designation	Screw	Wrench	Wrench handle	
LCD 200-219-3D	TS 40178D25	BLD T20/S7	SW6-T-SH	
LCD 220-239-3D	TS 40198D28	BLD T20/S7	SW6-T-SH	
LCD 240-259-3D	TS 40210D3	BLD T20/S7	SW6-T-SH	
LCD 260-279-3D	TS 50230D3	BLD T20/S7	SW6-T-SH	
LCD 280-299-3D	TS 50250D35	BLD T25/S7	SW6-T-SH	
LCD 300-319-3D	TS 60265D4	BLD T25/S7	SW6-T-SH	
LCD 320-349-3D	TS 60285D42	BLD T25/S7	SW6-T-SH	
LCD 350-379-3D	TS 60320D5	BLD T25/S7	SW6-T-SH	
LCD 380-410-3D	TS 80340D6	BLD T25/S7	SW6-T-SH	



Head changeable drill holders - Weldon type shank



- Drilling depth: 5xdiameter

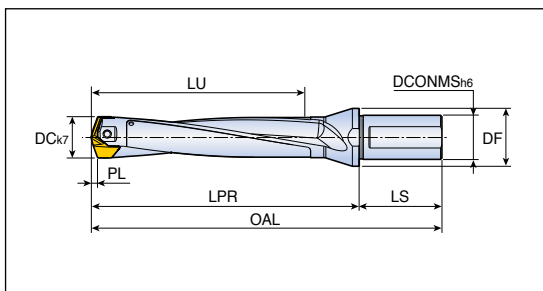

Designation	Dimension (mm)							
	DC	DCONMS	DF	LU	LPR	LS	PL	SSC
LCD 200-209-25T2-5D	20.0-20.9	25	32	103	132.1	56	3.11	20
210-219-25T2-5D	21.0-21.9	25	32	108	137.3	56	3.29	21
220-229-25T2-5D	22.0-22.9	25	32	113	142.4	56	3.42	22
230-239-25T2-5D	23.0-23.9	25	32	119	147.6	56	3.60	23
240-249-32T2-5D	24.0-24.9	32	40	124	158.7	60	3.73	24
250-259-32T2-5D	25.0-25.9	32	40	129	163.9	60	3.91	25
260-269-32T2-5D	26.0-26.9	32	40	134	169.0	60	4.04	26
270-279-32T2-5D	27.0-27.9	32	40	139	174.2	60	4.22	27
280-289-32T2-5D	28.0-28.9	32	40	144	184.4	60	4.35	28
290-299-32T2-5D	29.0-29.9	32	40	150	189.5	60	4.53	29
300-309-32T2-5D	30.0-30.9	32	42	155	194.7	60	4.67	30
310-319-32T2-5D	31.0-31.9	32	42	160	199.9	60	4.85	31
320-329-40T2-5D	32.0-32.9	40	48	165	207.0	68	4.98	32
330-339-40T2-5D	33.0-33.9	40	48	170	212.2	68	5.16	33
340-349-40T2-5D	34.0-34.9	40	48	175	217.3	68	5.34	34
350-359-40T2-5D	35.0-35.9	40	48	180	222.4	68	5.44	35
360-369-40T2-5D	36.0-36.9	40	48	186	227.6	68	5.62	36
370-379-40T2-5D	37.0-37.9	40	48	191	232.8	68	5.80	37
380-389-40T2-5D	38.0-38.9	40	50	196	242.9	68	5.91	38
390-399-40T2-5D	39.0-39.9	40	50	201	248.1	68	6.09	39
400-410-40T2-5D	40.0-41.0	40	50	206	253.3	68	6.27	40

- ▶ OAL: LPR+LS
- ▶ SSC: Seat size code

Spare parts

Designation	Screw	Wrench	Wrench handle	
LCD 200-219-5D	TS 40178D25	BLD T20/S7	SW6-T-SH	
LCD 220-239-5D	TS 40198D28	BLD T20/S7	SW6-T-SH	
LCD 240-259-5D	TS 40210D3	BLD T20/S7	SW6-T-SH	
LCD 260-279-5D	TS 50230D3	BLD T20/S7	SW6-T-SH	
LCD 280-299-5D	TS 50250D35	BLD T25/S7	SW6-T-SH	
LCD 300-319-5D	TS 60265D4	BLD T25/S7	SW6-T-SH	
LCD 320-349-5D	TS 60285D42	BLD T25/S7	SW6-T-SH	
LCD 350-379-5D	TS 60320D5	BLD T25/S7	SW6-T-SH	
LCD 380-410-5D	TS 80340D6	BLD T25/S7	SW6-T-SH	



Head changeable drill holders - Weldon type shank



- Drilling depth: 8x diameter

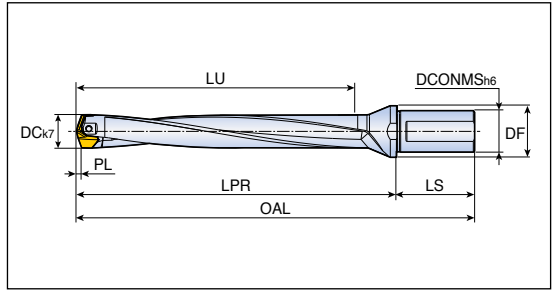

Designation	Dimension (mm)							
	DC	DCONMS	DF	LU	LPR	LS	PL	SSC
LCD 200-209-25T2-8D	20.0-20.9	25	32	163.1	192.1	56	3.11	20
210-219-25T2-8D	21.0-21.9	25	32	171.3	200.1	56	3.29	21
220-229-25T2-8D	22.0-22.9	25	32	179.4	208.4	56	3.42	22
230-239-25T2-8D	23.0-23.9	25	32	187.6	216.4	56	3.60	23
240-249-32T2-8D	24.0-24.9	32	40	195.7	230.7	60	3.73	24
250-259-32T2-8D	25.0-25.9	32	40	203.9	238.7	60	3.91	25
260-269-32T2-8D	26.0-26.9	32	40	212.0	247.0	60	4.04	26
270-279-32T2-8D	27.0-27.9	32	40	220.2	255.0	60	4.22	27
280-289-32T2-8D	28.0-28.9	32	40	228.4	268.4	60	4.35	28
290-299-32T2-8D	29.0-29.9	32	40	236.5	276.4	60	4.53	29
300-309-32T2-8D	30.0-30.9	32	42	244.7	284.7	60	4.67	30
310-319-32T2-8D	31.0-31.9	32	42	252.9	292.7	60	4.85	31
320-329-40T2-8D	32.0-32.9	40	48	261.0	303.0	68	4.98	32
330-339-40T2-8D	33.0-33.9	40	48	269.2	311.0	68	5.16	33
340-349-40T2-8D	34.0-34.9	40	48	277.3	319.0	68	5.34	34
350-359-40T2-8D	35.0-35.9	40	48	285.4	327.4	68	5.44	35
360-369-40T2-8D	36.0-36.9	40	48	293.6	335.4	68	5.62	36
370-379-40T2-8D	37.0-37.9	40	48	301.8	343.4	68	5.80	37
380-389-40T2-8D	38.0-38.9	40	50	309.9	356.9	68	5.91	38
390-399-40T2-8D	39.0-39.9	40	50	318.1	364.9	68	6.09	39
400-410-40T2-8D	40.0-41.0	40	50	326.3	372.9	68	6.27	40

► OAL: LPR+LS ► SSC: Seat size code ► It is recommended to make the pilot hole with a 3D holder

Spare parts

Designation	Screw	Wrench	Wrench handle
LCD 200-219-8D	TS 40178D25	BLD T20/S7	SW6-T-SH
LCD 220-239-8D	TS 40198D28	BLD T20/S7	SW6-T-SH
LCD 240-259-8D	TS 40210D3	BLD T20/S7	SW6-T-SH
LCD 260-279-8D	TS 50230D3	BLD T20/S7	SW6-T-SH
LCD 280-299-8D	TS 50250D35	BLD T25/S7	SW6-T-SH
LCD 300-319-8D	TS 60265D4	BLD T25/S7	SW6-T-SH
LCD 320-349-8D	TS 60285D42	BLD T25/S7	SW6-T-SH
LCD 350-379-8D	TS 60320D5	BLD T25/S7	SW6-T-SH
LCD 380-410-8D	TS 80340D6	BLD T25/S7	SW6-T-SH



3HD...PI3



3 flute solid carbide drills with oil holes



- Drilling depth: 3xdiameter

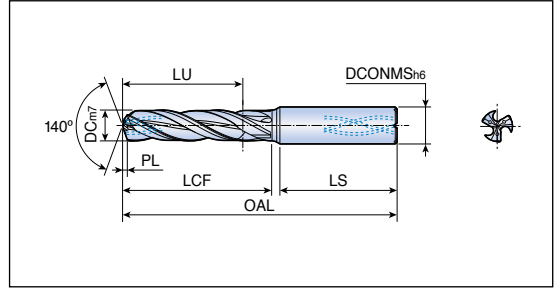

Designation	Dimension (mm)							Grade TT5130
	DC	DCONMS	OAL	LU	LCF	LS	PL	
3HD 040-017-06 PI3	4.0	6	66	17	25	35	0.82	●
045-017-06 PI3	4.5	6	66	17	25	35	0.88	●
050-020-06 PI3	5.0	6	66	20	29	36	0.96	●
051-020-06 PI3	5.1	6	66	20	29	36	0.98	●
055-020-06 PI3	5.5	6	66	20	29	36	1.08	●
060-020-06 PI3	6.0	6	66	20	29	36	1.17	●
065-024-08 PI3	6.5	8	79	24	35	36	1.26	●
068-024-08 PI3	6.8	8	79	24	35	36	1.31	●
070-024-08 PI3	7.0	8	79	24	35	36	1.35	●
075-029-08 PI3	7.5	8	79	29	42	36	1.40	●
080-029-08 PI3	8.0	8	79	29	42	36	1.49	●
085-035-10 PI3	8.5	10	89	35	48	40	1.63	●
086-035-10 PI3	8.6	10	89	35	48	40	1.65	●
090-035-10 PI3	9.0	10	89	35	48	40	1.72	●
095-035-10 PI3	9.5	10	89	35	48	40	1.75	●
100-035-10 PI3	10.0	10	89	35	48	40	1.85	●
103-040-12 PI3	10.3	12	102	40	55	45	1.94	●
105-040-12 PI3	10.5	12	102	40	55	45	1.98	●
110-040-12 PI3	11.0	12	102	40	55	45	2.07	●
115-040-12 PI3	11.5	12	102	40	56	45	2.12	●
120-040-12 PI3	12.0	12	102	40	56	45	2.21	●

●: Standard items



3HD...PI5



3 flute solid carbide drills with oil holes



- Drilling depth: 5x diameter

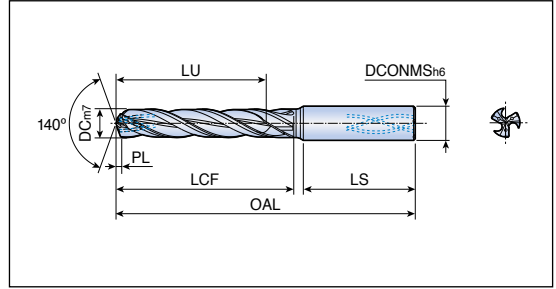

Designation	Dimension (mm)							Grade
	DC	DCONMS	OAL	LU	LCF	LS	PL	TT5130
3HD 040-029-06 PI5	4.0	6	74	29	37	35	0.82	●
045-029-06 PI5	4.5	6	74	29	37	35	0.88	●
050-035-06 PI5	5.0	6	82	35	45	36	0.96	●
051-035-06 PI5	5.1	6	82	35	45	36	0.98	●
055-035-06 PI5	5.5	6	82	35	45	36	1.08	●
060-035-06 PI5	6.0	6	82	35	45	36	1.17	●
065-043-08 PI5	6.5	8	91	43	54	36	1.26	●
068-043-08 PI5	6.8	8	91	43	54	36	1.31	●
070-043-08 PI5	7.0	8	91	43	54	36	1.35	●
075-043-08 PI5	7.5	8	91	43	54	36	1.40	●
080-043-08 PI5	8.0	8	91	43	54	36	1.49	●
085-049-10 PI5	8.5	10	103	49	62	40	1.63	●
086-049-10 PI5	8.6	10	103	49	62	40	1.65	●
090-049-10 PI5	9.0	10	103	49	62	40	1.72	●
095-049-10 PI5	9.5	10	103	49	62	40	1.75	●
100-049-10 PI5	10.0	10	103	49	62	40	1.85	●
103-056-12 PI5	10.3	12	118	56	71	45	1.94	●
105-056-12 PI5	10.5	12	118	56	71	45	1.98	●
110-056-12 PI5	11.0	12	118	56	71	45	2.07	●
115-056-12 PI5	11.5	12	118	56	72	45	2.12	●
120-056-12 PI5	12.0	12	118	56	72	45	2.21	●

• Standard items



3HD...PI8



3 flute solid carbide drills with oil holes



- Drilling depth: 8x diameter

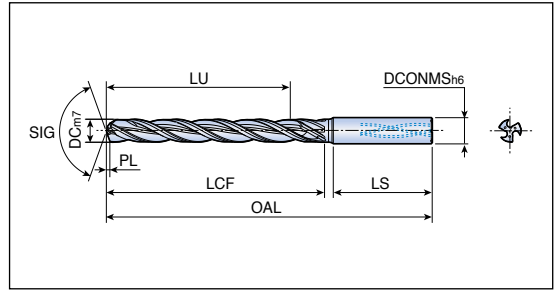

Designation	Dimension (mm)								Grade TT5130
	DC	DCONMS	OAL	SIG	LU	LCF	LS	PL	
3HD 040-036-06 PI8	4.0	6	81	140	36	43	35	0.82	•
045-036-06 PI8	4.5	6	81	140	36	43	35	0.88	•
050-048-06 PI8	5.0	6	95	140	48	57	36	0.96	•
055-048-06 PI8	5.5	6	95	140	48	57	36	1.08	•
060-048-06 PI8	6.0	6	95	140	48	57	36	1.17	•
065-064-08 PI8	6.5	8	114	140	64	76	36	1.26	•
070-064-08 PI8	7.0	8	114	140	64	76	36	1.35	•
075-064-08 PI8	7.5	8	114	140	64	76	36	1.40	•
080-064-08 PI8	8.0	8	114	140	64	76	36	1.49	•
085-080-10 PI8	8.5	10	142	130	80	95	40	2.04	•
090-080-10 PI8	9.0	10	142	130	80	95	40	2.16	•
095-080-10 PI8	9.5	10	142	130	80	95	40	2.29	•
100-080-10 PI8	10.0	10	142	130	80	95	40	2.33	•
105-096-12 PI8	10.5	12	162	130	96	113	45	2.50	•
110-096-12 PI8	11.0	12	162	130	96	113	45	2.61	•
115-096-12 PI8	11.5	12	162	130	96	113	45	2.67	•
120-096-12 PI8	12.0	12	162	130	96	113	45	2.80	•



- ▶ Ø4.00-Ø8.00: SIG 140°
- ▶ Ø8.01-Ø12.00: SIG 130°

- Standard items



3HD...CI12

3 flute solid carbide drill with oil holes

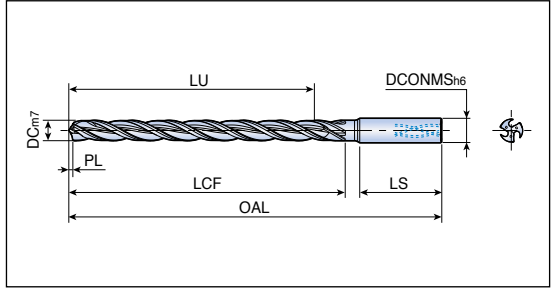

• Drilling depth: 12xdiameter



Designation	Dimension (mm)							Grade
	DC	DCONMS	OAL	LU	LCF	LS	PL	TT5130
3HD 060-069-06 CI12	6.0	6	116	69	78	36	1.38	●
065-096-08 CI12	6.5	8	146	96	108	36	1.57	●
070-096-08 CI12	7.0	8	146	96	108	36	1.60	●
075-096-08 CI12	7.5	8	146	96	108	36	1.78	●
080-096-08 CI12	8.0	8	146	96	108	36	1.81	●
085-105-10 CI12	8.5	10	162	105	120	40	2.07	●
090-105-10 CI12	9.0	10	162	105	120	40	2.10	●
095-105-10 CI12	9.5	10	162	105	120	40	2.27	●
100-105-10 CI12	10.0	10	162	105	120	40	2.30	●
105-139-12 CI12	10.5	12	204	139	156	45	2.56	●
110-139-12 CI12	11.0	12	204	139	156	45	2.59	●
115-139-12 CI12	11.5	12	204	139	156	45	2.76	●
120-139-12 CI12	12.0	12	204	139	156	45	2.79	●

• Standard items



3HD...FI3



3 flute solid carbide drills for flat bottom holes



- Drilling depth: 3xdiameter

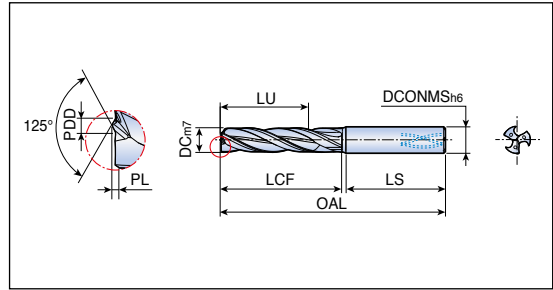

Designation	Dimension (mm)								Grade
	DC	DCONMS	OAL	LU	LCF	LS	PDD	PL	TT5130
3HD 040-017-06 FI3	4.0	6	66	17	25	35	0.77	0.43	●
045-017-06 FI3	4.5	6	66	17	25	35	0.86	0.45	●
050-020-06 FI3	5.0	6	66	20	29	36	0.97	0.47	●
055-020-06 FI3	5.5	6	66	20	29	36	1.08	0.58	●
060-020-06 FI3	6.0	6	66	20	29	36	1.08	0.58	●
065-024-08 FI3	6.5	8	79	24	35	36	1.26	0.62	●
070-024-08 FI3	7.0	8	79	24	35	36	1.26	0.62	●
075-029-08 FI3	7.5	8	79	29	42	36	1.44	0.66	●
080-029-08 FI3	8.0	8	79	29	42	36	1.44	0.66	●
085-035-10 FI3	8.5	10	89	35	48	40	1.62	0.79	●
090-035-10 FI3	9.0	10	89	35	48	40	1.62	0.79	●
095-035-10 FI3	9.5	10	89	35	48	40	1.80	0.82	●
100-035-10 FI3	10.0	10	89	35	48	40	1.80	0.82	●
105-040-12 FI3	10.5	12	102	40	55	45	1.98	0.95	●
110-040-12 FI3	11.0	12	102	40	55	45	1.98	0.95	●
115-040-12 FI3	11.5	12	102	40	56	45	2.16	0.98	●
120-040-12 FI3	12.0	12	102	40	56	45	2.16	0.98	●



• Standard items

3HD...F15



3 flute solid carbide drills for flat bottom holes



- Drilling depth: 5xdiameter

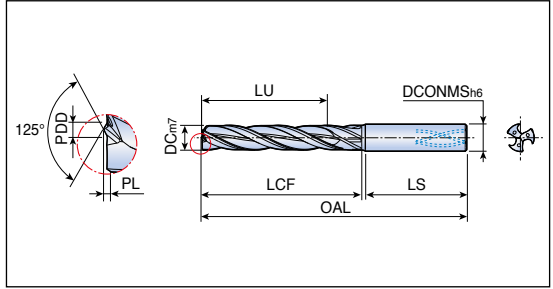

Designation	Dimension (mm)								Grade TT5130
	DC	DCONMS	OAL	LU	LCF	LS	PDD	PL	
3HD 040-029-06 F15	4.0	6	74	29	37	35	0.77	0.43	●
045-029-06 F15	4.5	6	74	29	37	35	0.86	0.45	●
050-035-06 F15	5.0	6	82	35	45	36	0.97	0.47	●
055-035-06 F15	5.5	6	82	35	45	36	1.08	0.58	●
060-035-06 F15	6.0	6	82	35	45	36	1.08	0.58	●
065-043-08 F15	6.5	8	91	43	54	36	1.26	0.62	●
070-043-08 F15	7.0	8	91	43	54	36	1.26	0.62	●
075-043-08 F15	7.5	8	91	43	54	36	1.44	0.66	●
080-043-08 F15	8.0	8	91	43	54	36	1.44	0.66	●
085-049-10 F15	8.5	10	103	49	62	40	1.62	0.79	●
090-049-10 F15	9.0	10	103	49	62	40	1.62	0.79	●
095-049-10 F15	9.5	10	103	49	62	40	1.80	0.82	●
100-049-10 F15	10.0	10	103	49	62	40	1.80	0.82	●
105-056-12 F15	10.5	12	118	56	71	45	1.98	0.95	●
110-056-12 F15	11.0	12	118	56	71	45	1.98	0.95	●
115-056-12 F15	11.5	12	118	56	72	45	2.16	0.98	●
120-056-12 F15	12.0	12	118	56	72	45	2.16	0.98	●

● Standard items



NHD...PE3



Solid carbide drills without oil holes



- Drilling depth: 3xdiameter

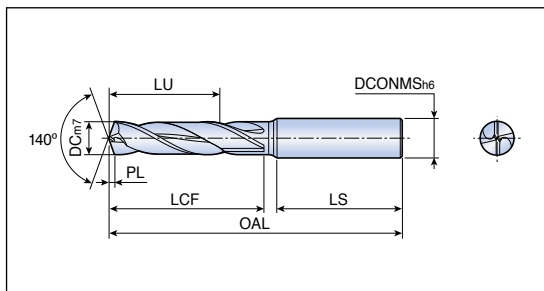

Designation	Dimension (mm)							Grade
	DC	DCONMS	OAL	LU	LCF	LS	PL	TT9030
NHD 030-014-06 PE3	3.0	6	62	14	21	34	0.5	●
031-014-06 PE3	3.1	6	62	14	21	34	0.5	●
032-014-06 PE3	3.2	6	62	14	21	34	0.5	●
033-014-06 PE3	3.3	6	62	14	21	34	0.5	●
034-014-06 PE3	3.4	6	62	14	21	34	0.5	●
035-014-06 PE3	3.5	6	62	14	21	34	0.6	●
036-014-06 PE3	3.6	6	62	14	21	34	0.6	●
037-014-06 PE3	3.7	6	62	14	21	34	0.6	●
038-017-06 PE3	3.8	6	66	17	25	35	0.6	●
039-017-06 PE3	3.9	6	66	17	25	35	0.6	●
040-017-06 PE3	4.0	6	66	17	25	35	0.6	●
041-017-06 PE3	4.1	6	66	17	25	35	0.7	●
042-017-06 PE3	4.2	6	66	17	25	35	0.7	●
043-017-06 PE3	4.3	6	66	17	25	35	0.7	●
044-017-06 PE3	4.4	6	66	17	25	35	0.7	●
045-017-06 PE3	4.5	6	66	17	25	35	0.7	●
046-017-06 PE3	4.6	6	66	17	25	35	0.7	●
047-017-06 PE3	4.7	6	66	17	25	35	0.8	●
048-020-06 PE3	4.8	6	66	20	29	36	0.8	●
049-020-06 PE3	4.9	6	66	20	29	36	0.8	●
050-020-06 PE3	5.0	6	66	20	29	36	0.8	●
051-020-06 PE3	5.1	6	66	20	29	36	0.8	●
052-020-06 PE3	5.2	6	66	20	29	36	0.8	●
053-020-06 PE3	5.3	6	66	20	29	36	0.8	●
054-020-06 PE3	5.4	6	66	20	29	36	0.8	●
055-020-06 PE3	5.5	6	66	20	29	36	0.9	●
056-020-06 PE3	5.6	6	66	20	29	36	0.9	●
057-020-06 PE3	5.7	6	66	20	29	36	0.9	●
058-020-06 PE3	5.8	6	66	20	29	36	0.9	●
059-020-06 PE3	5.9	6	66	20	29	36	0.9	●
060-020-06 PE3	6.0	6	66	20	29	36	0.9	●
061-024-08 PE3	6.1	8	79	24	35	36	1.0	●
062-024-08 PE3	6.2	8	79	24	35	36	1.0	●
063-024-08 PE3	6.3	8	79	24	35	36	1.0	●
064-024-08 PE3	6.4	8	79	24	35	36	1.0	●

- : Standard items



Solid carbide drills without oil holes



• Drilling depth: 3xdiameter

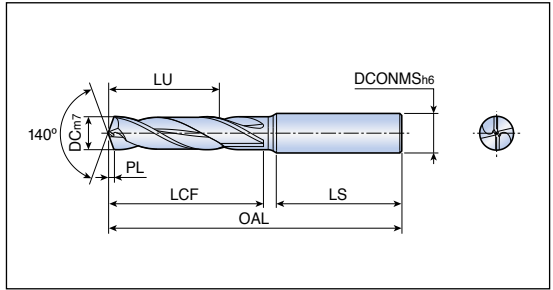

Designation	Dimension (mm)							Grade
	DC	DCONMS	OAL	LU	LCF	LS	PL	TT9030
NHD 065-024-08 PE3	6.5	8	79	24	35	36	1.0	●
066-024-08 PE3	6.6	8	79	24	35	36	1.0	●
067-024-08 PE3	6.7	8	79	24	35	36	1.1	●
068-024-08 PE3	6.8	8	79	24	35	36	1.1	●
069-024-08 PE3	6.9	8	79	24	35	36	1.1	●
070-024-08 PE3	7.0	8	79	24	35	36	1.1	●
071-029-08 PE3	7.1	8	79	29	42	36	1.1	●
072-029-08 PE3	7.2	8	79	29	42	36	1.1	●
073-029-08 PE3	7.3	8	79	29	42	36	1.1	●
074-029-08 PE3	7.4	8	79	29	42	36	1.2	●
075-029-08 PE3	7.5	8	79	29	42	36	1.2	●
076-029-08 PE3	7.6	8	79	29	42	36	1.2	●
077-029-08 PE3	7.7	8	79	29	42	36	1.2	●
078-029-08 PE3	7.8	8	79	29	42	36	1.2	●
079-029-08 PE3	7.9	8	79	29	42	36	1.3	●
080-029-08 PE3	8.0	8	79	29	42	36	1.3	●
081-035-10 PE3	8.1	10	89	35	48	40	1.3	●
082-035-10 PE3	8.2	10	89	35	48	40	1.3	●
083-035-10 PE3	8.3	10	89	35	48	40	1.3	●
084-035-10 PE3	8.4	10	89	35	48	40	1.3	●
085-035-10 PE3	8.5	10	89	35	48	40	1.3	●
086-035-10 PE3	8.6	10	89	35	48	40	1.4	●
087-035-10 PE3	8.7	10	89	35	48	40	1.4	●
088-035-10 PE3	8.8	10	89	35	48	40	1.4	●
089-035-10 PE3	8.9	10	89	35	48	40	1.4	●
090-035-10 PE3	9.0	10	89	35	48	40	1.4	●
091-035-10 PE3	9.1	10	89	35	48	40	1.4	●
092-035-10 PE3	9.2	10	89	35	48	40	1.4	●
093-035-10 PE3	9.3	10	89	35	48	40	1.5	●
094-035-10 PE3	9.4	10	89	35	48	40	1.5	●
095-035-10 PE3	9.5	10	89	35	48	40	1.5	●
096-035-10 PE3	9.6	10	89	35	48	40	1.5	●
097-035-10 PE3	9.7	10	89	35	48	40	1.5	●
098-035-10 PE3	9.8	10	89	35	48	40	1.6	●
099-035-10 PE3	9.9	10	89	35	48	40	1.6	●

• Standard items



NHD...PE3



Solid carbide drills without oil holes



- Drilling depth: 3xdiameter

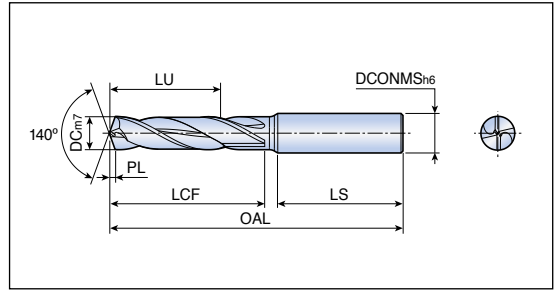

Designation	Dimension (mm)							Grade
	DC	DCONMS	OAL	LU	LCF	LS	PL	TT9030
NHD 100-035-10 PE3	10.0	10	89	35	48	40	1.6	●
101-040-12 PE3	10.1	12	101	40	54	45	1.6	●
102-040-12 PE3	10.2	12	101	40	54	45	1.6	●
103-040-12 PE3	10.3	12	101	40	54	45	1.6	●
104-040-12 PE3	10.4	12	101	40	54	45	1.6	●
105-040-12 PE3	10.5	12	101	40	54	45	1.6	●
106-040-12 PE3	10.6	12	101	40	54	45	1.7	●
107-040-12 PE3	10.7	12	101	40	54	45	1.7	●
108-040-12 PE3	10.8	12	101	40	54	45	1.7	●
109-040-12 PE3	10.9	12	101	40	54	45	1.7	●
110-040-12 PE3	11.0	12	101	40	54	45	1.7	●
111-040-12 PE3	11.1	12	101	40	55	45	1.7	●
112-040-12 PE3	11.2	12	101	40	55	45	1.8	●
113-040-12 PE3	11.3	12	101	40	55	45	1.8	●
114-040-12 PE3	11.4	12	101	40	55	45	1.8	●
115-040-12 PE3	11.5	12	101	40	55	45	1.8	●
116-040-12 PE3	11.6	12	101	40	55	45	1.8	●
117-040-12 PE3	11.7	12	101	40	55	45	1.9	●
118-040-12 PE3	11.8	12	101	40	55	45	1.9	●
119-040-12 PE3	11.9	12	101	40	55	45	1.9	●
120-040-12 PE3	12.0	12	101	40	55	45	1.9	●

●: Standard items



Solid carbide drills without oil holes



• Drilling depth: 5xdiameter

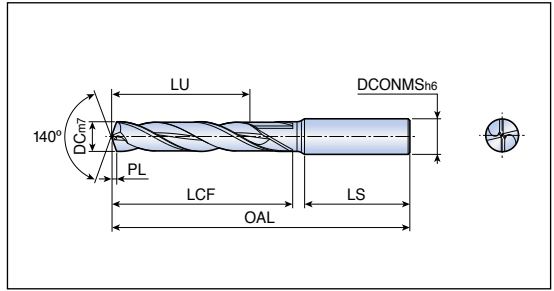

Designation	Dimension (mm)							Grade
	DC	DCONMS	OAL	LU	LCF	LS	PL	TT9030
NHD 030-023-06 PE5	3.0	6	66	23	29	34	0.5	●
031-023-06 PE5	3.1	6	66	23	29	34	0.5	●
032-023-06 PE5	3.2	6	66	23	29	34	0.5	●
033-023-06 PE5	3.3	6	66	23	29	34	0.5	●
034-023-06 PE5	3.4	6	66	23	29	34	0.5	●
035-023-06 PE5	3.5	6	66	23	29	34	0.6	●
036-023-06 PE5	3.6	6	66	23	29	34	0.6	●
037-023-06 PE5	3.7	6	66	23	29	34	0.6	●
038-029-06 PE5	3.8	6	74	29	37	35	0.6	●
039-029-06 PE5	3.9	6	74	29	37	35	0.6	●
040-029-06 PE5	4.0	6	74	29	37	35	0.6	●
041-029-06 PE5	4.1	6	74	29	37	35	0.7	●
042-029-06 PE5	4.2	6	74	29	37	35	0.7	●
043-029-06 PE5	4.3	6	74	29	37	35	0.7	●
044-029-06 PE5	4.4	6	74	29	37	35	0.7	●
045-029-06 PE5	4.5	6	74	29	37	35	0.7	●
046-029-06 PE5	4.6	6	74	29	37	35	0.7	●
047-029-06 PE5	4.7	6	74	29	37	35	0.8	●
048-035-06 PE5	4.8	6	82	35	45	36	0.8	●
049-035-06 PE5	4.9	6	82	35	45	36	0.8	●
050-035-06 PE5	5.0	6	82	35	45	36	0.8	●
051-035-06 PE5	5.1	6	82	35	45	36	0.8	●
052-035-06 PE5	5.2	6	82	35	45	36	0.8	●
053-035-06 PE5	5.3	6	82	35	45	36	0.8	●
054-035-06 PE5	5.4	6	82	35	45	36	0.8	●
055-035-06 PE5	5.5	6	82	35	45	36	0.9	●
056-035-06 PE5	5.6	6	82	35	45	36	0.9	●
057-035-06 PE5	5.7	6	82	35	45	36	0.9	●
058-035-06 PE5	5.8	6	82	35	45	36	0.9	●
059-035-06 PE5	5.9	6	82	35	45	36	0.9	●
060-035-06 PE5	6.0	6	82	35	45	36	0.9	●
061-043-08 PE5	6.1	8	91	43	54	36	1.0	●
062-043-08 PE5	6.2	8	91	43	54	36	1.0	●
063-043-08 PE5	6.3	8	91	43	54	36	1.0	●
064-043-08 PE5	6.4	8	91	43	54	36	1.0	●

• Standard items



NHD...PE5



Solid carbide drills without oil holes



- Drilling depth: 5x diameter

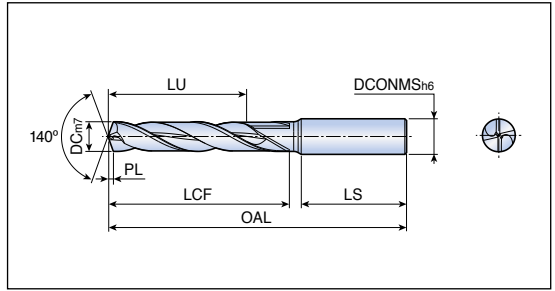

Designation	Dimension (mm)							Grade TT9030
	DC	DCONMS	OAL	LU	LCF	LS	PL	
NHD 065-043-08 PE5	6.5	8	91	43	54	36	1.0	●
066-043-08 PE5	6.6	8	91	43	54	36	1.0	●
067-043-08 PE5	6.7	8	91	43	54	36	1.1	●
068-043-08 PE5	6.8	8	91	43	54	36	1.1	●
069-043-08 PE5	6.9	8	91	43	54	36	1.1	●
070-043-08 PE5	7.0	8	91	43	54	36	1.1	●
071-043-08 PE5	7.1	8	91	43	54	36	1.1	●
072-043-08 PE5	7.2	8	91	43	54	36	1.1	●
073-043-08 PE5	7.3	8	91	43	54	36	1.1	●
074-043-08 PE5	7.4	8	91	43	54	36	1.2	●
075-043-08 PE5	7.5	8	91	43	54	36	1.2	●
076-043-08 PE5	7.6	8	91	43	54	36	1.2	●
077-043-08 PE5	7.7	8	91	43	54	36	1.2	●
078-043-08 PE5	7.8	8	91	43	54	36	1.2	●
079-043-08 PE5	7.9	8	91	43	54	36	1.3	●
080-043-08 PE5	8.0	8	91	43	54	36	1.3	●
081-049-10 PE5	8.1	10	103	49	62	40	1.3	●
082-049-10 PE5	8.2	10	103	49	62	40	1.3	●
083-049-10 PE5	8.3	10	103	49	62	40	1.3	●
084-049-10 PE5	8.4	10	103	49	62	40	1.3	●
085-049-10 PE5	8.5	10	103	49	62	40	1.3	●
086-049-10 PE5	8.6	10	103	49	62	40	1.4	●
087-049-10 PE5	8.7	10	103	49	62	40	1.4	●
088-049-10 PE5	8.8	10	103	49	62	40	1.4	●
089-049-10 PE5	8.9	10	103	49	62	40	1.4	●
090-049-10 PE5	9.0	10	103	49	62	40	1.4	●
091-049-10 PE5	9.1	10	103	49	62	40	1.4	●
092-049-10 PE5	9.2	10	103	49	62	40	1.4	●
093-049-10 PE5	9.3	10	103	49	62	40	1.5	●
094-049-10 PE5	9.4	10	103	49	62	40	1.5	●
095-049-10 PE5	9.5	10	103	49	62	40	1.5	●
096-049-10 PE5	9.6	10	103	49	62	40	1.5	●
097-049-10 PE5	9.7	10	103	49	62	40	1.5	●
098-049-10 PE5	9.8	10	103	49	62	40	1.6	●
099-049-10 PE5	9.9	10	103	49	62	40	1.6	●

●: Standard items



NHD...PE5



Solid carbide drills without oil holes



- Drilling depth: 5x diameter

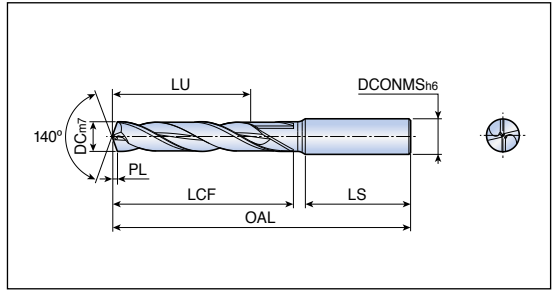

Designation	Dimension (mm)							Grade TT9030
	DC	DCONMS	OAL	LU	LCF	PL	LS	
NHD 100-049-10 PE5	10.0	10	103	49	62	1.6	40	●
101-056-12 PE5	10.1	12	118	56	71	1.6	45	●
102-056-12 PE5	10.2	12	118	56	71	1.6	45	●
103-056-12 PE5	10.3	12	118	56	71	1.6	45	●
104-056-12 PE5	10.4	12	118	56	71	1.6	45	●
105-056-12 PE5	10.5	12	118	56	71	1.6	45	●
106-056-12 PE5	10.6	12	118	56	71	1.7	45	●
107-056-12 PE5	10.7	12	118	56	71	1.7	45	●
108-056-12 PE5	10.8	12	118	56	71	1.7	45	●
109-056-12 PE5	10.9	12	118	56	71	1.7	45	●
110-056-12 PE5	11.0	12	118	56	71	1.7	45	●
111-056-12 PE5	11.1	12	118	56	72	1.7	45	●
112-056-12 PE5	11.2	12	118	56	72	1.8	45	●
113-056-12 PE5	11.3	12	118	56	72	1.8	45	●
114-056-12 PE5	11.4	12	118	56	72	1.8	45	●
115-056-12 PE5	11.5	12	118	56	72	1.8	45	●
116-056-12 PE5	11.6	12	118	56	72	1.8	45	●
117-056-12 PE5	11.7	12	118	56	72	1.9	45	●
118-056-12 PE5	11.8	12	118	56	72	1.9	45	●
119-056-12 PE5	11.9	12	118	56	72	1.9	45	●
120-056-12 PE5	12.0	12	118	56	72	1.9	45	●

● Standard items



NHD...PI3



Solid carbide drills with oil holes

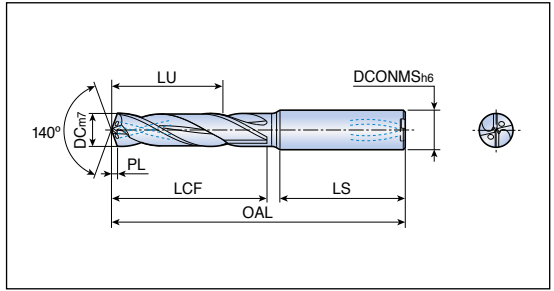

- Drilling depth: 3xdiameter



Designation	Dimension (mm)							Grade
	DC	DCONMS	OAL	LU	LCF	LS	PL	TT9030
NHD 030-014-06 PI3	3.0	6	62	14	21	34	0.5	●
031-014-06 PI3	3.1	6	62	14	21	34	0.5	●
032-014-06 PI3	3.2	6	62	14	21	34	0.5	●
033-014-06 PI3	3.3	6	62	14	21	34	0.5	●
034-014-06 PI3	3.4	6	62	14	21	34	0.5	●
035-014-06 PI3	3.5	6	62	14	21	34	0.6	●
036-014-06 PI3	3.6	6	62	14	21	34	0.6	●
037-014-06 PI3	3.7	6	62	14	21	34	0.6	●
038-017-06 PI3	3.8	6	66	17	25	35	0.6	●
039-017-06 PI3	3.9	6	66	17	25	35	0.6	●
040-017-06 PI3	4.0	6	66	17	25	35	0.6	●
041-017-06 PI3	4.1	6	66	17	25	35	0.7	●
042-017-06 PI3	4.2	6	66	17	25	35	0.7	●
043-017-06 PI3	4.3	6	66	17	25	35	0.7	●
044-017-06 PI3	4.4	6	66	17	25	35	0.7	●
045-017-06 PI3	4.5	6	66	17	25	35	0.7	●
046-017-06 PI3	4.6	6	66	17	25	35	0.7	●
047-017-06 PI3	4.7	6	66	17	25	35	0.8	●
048-020-06 PI3	4.8	6	66	20	29	36	0.8	●
049-020-06 PI3	4.9	6	66	20	29	36	0.8	●
050-020-06 PI3	5.0	6	66	20	29	36	0.8	●
051-020-06 PI3	5.1	6	66	20	29	36	0.8	●
052-020-06 PI3	5.2	6	66	20	29	36	0.8	●
053-020-06 PI3	5.3	6	66	20	29	36	0.8	●
054-020-06 PI3	5.4	6	66	20	29	36	0.8	●
055-020-06 PI3	5.5	6	66	20	29	36	0.9	●
056-020-06 PI3	5.6	6	66	20	29	36	0.9	●
057-020-06 PI3	5.7	6	66	20	29	36	0.9	●
058-020-06 PI3	5.8	6	66	20	29	36	0.9	●
059-020-06 PI3	5.9	6	66	20	29	36	0.9	●
060-020-06 PI3	6.0	6	66	20	29	36	0.9	●
061-024-08 PI3	6.1	8	79	24	35	36	1.0	●
062-024-08 PI3	6.2	8	79	24	35	36	1.0	●
063-024-08 PI3	6.3	8	79	24	35	36	1.0	●
064-024-08 PI3	6.4	8	79	24	35	36	1.0	●

- Standard items



Solid carbide drills with oil holes



- Drilling depth: 3xdiameter

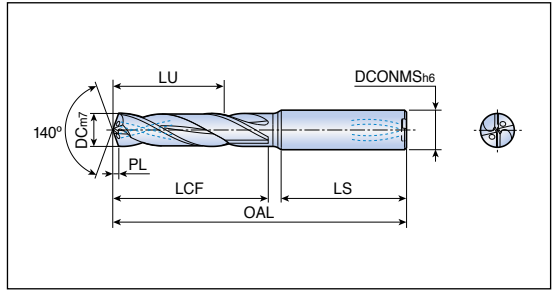

Designation	Dimension (mm)							Grade
	DC	DCONMS	OAL	LU	LCF	LS	PL	TT9030
NHD 065-024-08 PI3	6.5	8	79	24	35	36	1.0	•
066-024-08 PI3	6.6	8	79	24	35	36	1.0	•
067-024-08 PI3	6.7	8	79	24	35	36	1.1	•
068-024-08 PI3	6.8	8	79	24	35	36	1.1	•
069-024-08 PI3	6.9	8	79	24	35	36	1.1	•
070-024-08 PI3	7.0	8	79	24	35	36	1.1	•
071-029-08 PI3	7.1	8	79	29	42	36	1.1	•
072-029-08 PI3	7.2	8	79	29	42	36	1.1	•
073-029-08 PI3	7.3	8	79	29	42	36	1.1	•
074-029-08 PI3	7.4	8	79	29	42	36	1.2	•
075-029-08 PI3	7.5	8	79	29	42	36	1.2	•
076-029-08 PI3	7.6	8	79	29	42	36	1.2	•
077-029-08 PI3	7.7	8	79	29	42	36	1.2	•
078-029-08 PI3	7.8	8	79	29	42	36	1.2	•
079-029-08 PI3	7.9	8	79	29	42	36	1.3	•
080-029-08 PI3	8.0	8	79	29	42	36	1.3	•
081-035-10 PI3	8.1	10	89	35	48	40	1.3	•
082-035-10 PI3	8.2	10	89	35	48	40	1.3	•
083-035-10 PI3	8.3	10	89	35	48	40	1.3	•
084-035-10 PI3	8.4	10	89	35	48	40	1.3	•
085-035-10 PI3	8.5	10	89	35	48	40	1.3	•
086-035-10 PI3	8.6	10	89	35	48	40	1.4	•
087-035-10 PI3	8.7	10	89	35	48	40	1.4	•
088-035-10 PI3	8.8	10	89	35	48	40	1.4	•
089-035-10 PI3	8.9	10	89	35	48	40	1.4	•
090-035-10 PI3	9.0	10	89	35	48	40	1.4	•
091-035-10 PI3	9.1	10	89	35	48	40	1.4	•
092-035-10 PI3	9.2	10	89	35	48	40	1.4	•
093-035-10 PI3	9.3	10	89	35	48	40	1.5	•
094-035-10 PI3	9.4	10	89	35	48	40	1.5	•
095-035-10 PI3	9.5	10	89	35	48	40	1.5	•
096-035-10 PI3	9.6	10	89	35	48	40	1.5	•
097-035-10 PI3	9.7	10	89	35	48	40	1.5	•
098-035-10 PI3	9.8	10	89	35	48	40	1.6	•
099-035-10 PI3	9.9	10	89	35	48	40	1.6	•

- Standard items



Solid carbide drills with oil holes



- Drilling depth: 5x diameter

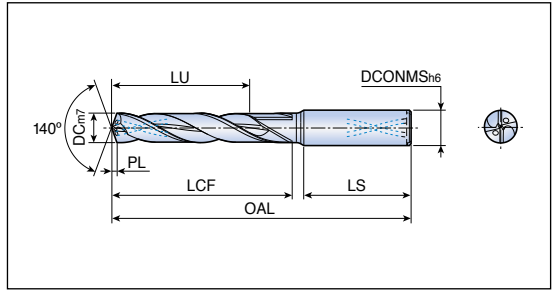

Designation	Dimension (mm)							Grade
	DC	DCONMS	OAL	LU	LCF	LS	PL	TT9030
NHD 030-023-06 PI5	3.0	6	66	23	29	34	0.5	●
031-023-06 PI5	3.1	6	66	23	29	34	0.5	●
032-023-06 PI5	3.2	6	66	23	29	34	0.5	●
033-023-06 PI5	3.3	6	66	23	29	34	0.5	●
034-023-06 PI5	3.4	6	66	23	29	34	0.5	●
035-023-06 PI5	3.5	6	66	23	29	34	0.6	●
036-023-06 PI5	3.6	6	66	23	29	34	0.6	●
037-023-06 PI5	3.7	6	66	23	29	34	0.6	●
038-029-06 PI5	3.8	6	74	29	37	35	0.6	●
039-029-06 PI5	3.9	6	74	29	37	35	0.6	●
040-029-06 PI5	4.0	6	74	29	37	35	0.6	●
041-029-06 PI5	4.1	6	74	29	37	35	0.7	●
042-029-06 PI5	4.2	6	74	29	37	35	0.7	●
043-029-06 PI5	4.3	6	74	29	37	35	0.7	●
044-029-06 PI5	4.4	6	74	29	37	35	0.7	●
045-029-06 PI5	4.5	6	74	29	37	35	0.7	●
046-029-06 PI5	4.6	6	74	29	37	35	0.7	●
047-029-06 PI5	4.7	6	74	29	37	35	0.8	●
048-035-06 PI5	4.8	6	82	35	45	36	0.8	●
049-035-06 PI5	4.9	6	82	35	45	36	0.8	●
050-035-06 PI5	5.0	6	82	35	45	36	0.8	●
051-035-06 PI5	5.1	6	82	35	45	36	0.8	●
052-035-06 PI5	5.2	6	82	35	45	36	0.8	●
053-035-06 PI5	5.3	6	82	35	45	36	0.8	●
054-035-06 PI5	5.4	6	82	35	45	36	0.8	●
055-035-06 PI5	5.5	6	82	35	45	36	0.9	●
056-035-06 PI5	5.6	6	82	35	45	36	0.9	●
057-035-06 PI5	5.7	6	82	35	45	36	0.9	●
058-035-06 PI5	5.8	6	82	35	45	36	0.9	●
059-035-06 PI5	5.9	6	82	35	45	36	0.9	●
060-035-06 PI5	6.0	6	82	35	45	36	0.9	●
061-043-08 PI5	6.1	8	91	43	54	36	1.0	●
062-043-08 PI5	6.2	8	91	43	54	36	1.0	●
063-043-08 PI5	6.3	8	91	43	54	36	1.0	●
064-043-08 PI5	6.4	8	91	43	54	36	1.0	●

- Standard items



NHD...PI5



Solid carbide drills with oil holes



- Drilling depth: 5xdiameter

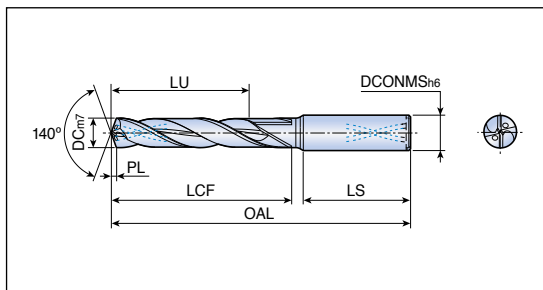

Designation	Dimension (mm)							Grade TT9030
	DC	DCONMS	OAL	LU	LCF	LS	PL	
NHD 065-043-08 PI5	6.5	8	91	43	54	36	1.0	●
066-043-08 PI5	6.6	8	91	43	54	36	1.0	●
067-043-08 PI5	6.7	8	91	43	54	36	1.1	●
068-043-08 PI5	6.8	8	91	43	54	36	1.1	●
069-043-08 PI5	6.9	8	91	43	54	36	1.1	●
070-043-08 PI5	7.0	8	91	43	54	36	1.1	●
071-043-08 PI5	7.1	8	91	43	54	36	1.1	●
072-043-08 PI5	7.2	8	91	43	54	36	1.1	●
073-043-08 PI5	7.3	8	91	43	54	36	1.1	●
074-043-08 PI5	7.4	8	91	43	54	36	1.2	●
075-043-08 PI5	7.5	8	91	43	54	36	1.2	●
076-043-08 PI5	7.6	8	91	43	54	36	1.2	●
077-043-08 PI5	7.7	8	91	43	54	36	1.2	●
078-043-08 PI5	7.8	8	91	43	54	36	1.2	●
079-043-08 PI5	7.9	8	91	43	54	36	1.3	●
080-043-08 PI5	8.0	8	91	43	54	36	1.3	●
081-049-10 PI5	8.1	10	103	49	62	40	1.3	●
082-049-10 PI5	8.2	10	103	49	62	40	1.3	●
083-049-10 PI5	8.3	10	103	49	62	40	1.3	●
084-049-10 PI5	8.4	10	103	49	62	40	1.3	●
085-049-10 PI5	8.5	10	103	49	62	40	1.3	●
086-049-10 PI5	8.6	10	103	49	62	40	1.4	●
087-049-10 PI5	8.7	10	103	49	62	40	1.4	●
088-049-10 PI5	8.8	10	103	49	62	40	1.4	●
089-049-10 PI5	8.9	10	103	49	62	40	1.4	●
090-049-10 PI5	9.0	10	103	49	62	40	1.4	●
091-049-10 PI5	9.1	10	103	49	62	40	1.4	●
092-049-10 PI5	9.2	10	103	49	62	40	1.4	●
093-049-10 PI5	9.3	10	103	49	62	40	1.5	●
094-049-10 PI5	9.4	10	103	49	62	40	1.5	●
095-049-10 PI5	9.5	10	103	49	62	40	1.5	●
096-049-10 PI5	9.6	10	103	49	62	40	1.5	●
097-049-10 PI5	9.7	10	103	49	62	40	1.5	●
098-049-10 PI5	9.8	10	103	49	62	40	1.6	●
099-049-10 PI5	9.9	10	103	49	62	40	1.6	●

- : Standard items



NHD...PI5



Solid carbide drills with oil holes



• Drilling depth: 5xdiameter

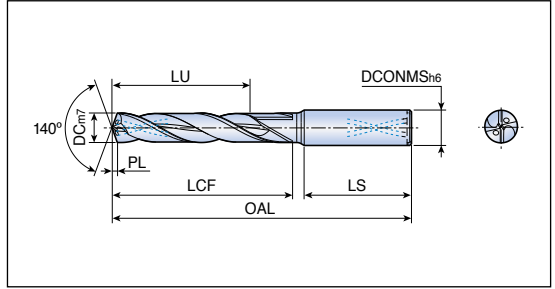

Designation	Dimension (mm)							Grade
	DC	DCONMS	OAL	LU	LCF	LS	PL	TT9030
NHD 100-049-10 PI5	10.0	10	103	49	62	40	1.6	●
101-056-12 PI5	10.1	12	118	56	71	45	1.6	●
102-056-12 PI5	10.2	12	118	56	71	45	1.6	●
103-056-12 PI5	10.3	12	118	56	71	45	1.6	●
104-056-12 PI5	10.4	12	118	56	71	45	1.6	●
105-056-12 PI5	10.5	12	118	56	71	45	1.6	●
106-056-12 PI5	10.6	12	118	56	71	45	1.7	●
107-056-12 PI5	10.7	12	118	56	71	45	1.7	●
108-056-12 PI5	10.8	12	118	56	71	45	1.7	●
109-056-12 PI5	10.9	12	118	56	71	45	1.7	●
110-056-12 PI5	11.0	12	118	56	71	45	1.7	●
111-056-12 PI5	11.1	12	118	56	72	45	1.7	●
112-056-12 PI5	11.2	12	118	56	72	45	1.8	●
113-056-12 PI5	11.3	12	118	56	72	45	1.8	●
114-056-12 PI5	11.4	12	118	56	72	45	1.8	●
115-056-12 PI5	11.5	12	118	56	72	45	1.8	●
116-056-12 PI5	11.6	12	118	56	72	45	1.8	●
117-056-12 PI5	11.7	12	118	56	72	45	1.9	●
118-056-12 PI5	11.8	12	118	56	72	45	1.9	●
119-056-12 PI5	11.9	12	118	56	72	45	1.9	●
120-056-12 PI5	12.0	12	118	56	72	45	1.9	●



• Standard items

NHD...KI3



Solid carbide drills with oil holes for cast iron machining

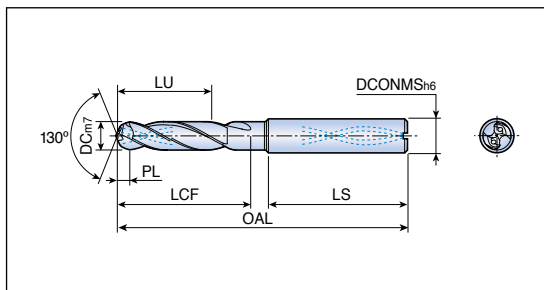

- Drilling depth: 3xdiameter



Designation	Dimension (mm)							Grade
	DC	DCONMS	OAL	LU	LCF	LS	PL	TT9030
NHD 030-014-06 KI3	3.0	6	62	14	20	34	1.4	●
033-014-06 KI3	3.3	6	62	14	20	34	1.6	●
035-014-06 KI3	3.5	6	62	14	20	34	1.7	●
040-017-06 KI3	4.0	6	66	17	24	35	1.9	●
041-017-06 KI3	4.1	6	66	17	24	35	2.0	●
042-017-06 KI3	4.2	6	66	17	24	35	2.0	●
045-017-06 KI3	4.5	6	66	17	24	35	2.2	●
046-017-06 KI3	4.6	6	66	17	24	35	2.2	●
050-020-06 KI3	5.0	6	66	20	27	36	2.4	●
051-020-06 KI3	5.1	6	66	20	27	36	2.5	●
052-020-06 KI3	5.2	6	66	20	27	36	2.5	●
055-020-06 KI3	5.5	6	66	20	27	36	2.6	●
060-020-06 KI3	6.0	6	66	20	27	36	2.9	●
061-024-08 KI3	6.1	8	79	24	34	36	2.9	●
065-024-08 KI3	6.5	8	79	24	34	36	3.1	●
067-024-08 KI3	6.7	8	79	24	34	36	3.2	●
068-024-08 KI3	6.8	8	79	24	34	36	3.3	●
070-024-08 KI3	7.0	8	79	24	34	36	3.4	●
075-029-08 KI3	7.5	8	79	29	40	36	3.6	●
080-029-08 KI3	8.0	8	79	29	40	36	3.8	●
081-035-10 KI3	8.1	10	89	35	45	40	3.9	●
085-035-10 KI3	8.5	10	89	35	45	40	4.1	●
087-035-10 KI3	8.7	10	89	35	45	40	4.2	●
089-035-10 KI3	8.9	10	89	35	45	40	4.3	●
090-035-10 KI3	9.0	10	89	35	45	40	4.3	●
095-035-10 KI3	9.5	10	89	35	45	40	4.6	●
100-035-10 KI3	10.0	10	89	35	45	40	4.8	●
103-040-12 KI3	10.3	12	102	40	53	45	4.9	●
105-040-12 KI3	10.5	12	102	40	53	45	5.0	●
110-040-12 KI3	11.0	12	102	40	53	45	5.3	●
115-040-12 KI3	11.5	12	102	40	53	45	5.5	●
120-040-12 KI3	12.0	12	102	40	53	45	5.8	●



- : Standard items

NHD...KI5



Solid carbide drills with oil holes for cast iron machining



• Drilling depth: 5x diameter

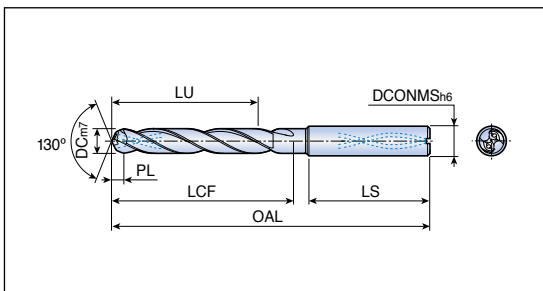

Designation	Dimension (mm)							Grade
	DC	DCONMS	OAL	LU	LCF	LS	PL	TT9030
NHD 030-023-06 KI5	3.0	6	66	23	27	34	1.4	●
033-023-06 KI5	3.3	6	66	23	27	34	1.6	●
035-023-06 KI5	3.5	6	66	23	27	34	1.7	●
040-029-06 KI5	4.0	6	74	29	34	35	1.9	●
042-029-06 KI5	4.2	6	74	29	34	35	2.0	●
045-029-06 KI5	4.5	6	74	29	35	35	2.2	●
046-029-06 KI5	4.6	6	74	29	35	35	2.2	●
050-035-06 KI5	5.0	6	82	35	43	36	2.4	●
052-035-06 KI5	5.2	6	82	35	43	36	2.5	●
055-035-06 KI5	5.5	6	82	35	43	36	2.6	●
060-035-06 KI5	6.0	6	82	35	43	36	2.9	●
065-043-08 KI5	6.5	8	91	43	52	36	3.1	●
067-043-08 KI5	6.7	8	91	43	52	36	3.2	●
068-043-08 KI5	6.8	8	91	43	52	36	3.3	●
070-043-08 KI5	7.0	8	91	43	52	36	3.4	●
075-043-08 KI5	7.5	8	91	43	52	36	3.6	●
080-043-08 KI5	8.0	8	91	43	52	36	3.8	●
081-049-10 KI5	8.1	10	103	49	59	40	3.9	●
085-049-10 KI5	8.5	10	103	49	59	40	4.1	●
087-049-10 KI5	8.7	10	103	49	59	40	4.2	●
089-049-10 KI5	8.9	10	103	49	59	40	4.3	●
090-049-10 KI5	9.0	10	103	49	59	40	4.3	●
095-049-10 KI5	9.5	10	103	49	59	40	4.6	●
100-049-10 KI5	10.0	10	103	49	59	40	4.8	●
103-056-12 KI5	10.3	12	118	56	69	45	4.9	●
105-056-12 KI5	10.5	12	118	56	69	45	5.0	●
110-056-12 KI5	11.0	12	118	56	69	45	5.3	●
115-056-12 KI5	11.5	12	118	56	69	45	5.5	●
120-056-12 KI5	12.0	12	118	56	69	45	5.8	●

• Standard items



SHO 3...-PH



Solid pilot drills for solid long drill



• M.Q.L drilling is available

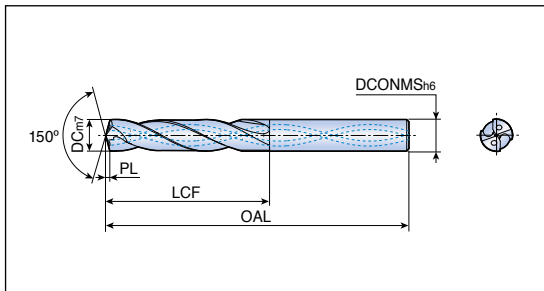

Designation	Dimension (mm)					Grade
	DC	DCONMS	OAL	LCF	PL	TT9030
SHO 30403-PH	4.03	4	66.5	24.5	0.5	●
30503-PH	5.03	5	68.6	30.6	0.6	●
30603-PH	6.03	6	68.7	30.7	0.7	●
30703-PH	7.03	7	73.8	35.8	0.8	●
30803-PH	8.03	8	79.9	41.9	0.9	●
30903-PH	9.03	9	91.0	49.0	1.0	●
31003-PH	10.03	10	91.1	49.1	1.1	●



• Standard items

SHO 10/15/20



Solid long drills with oil holes



- Drilling depth: 10/15/20xdiameter
- M.Q.L drilling is available

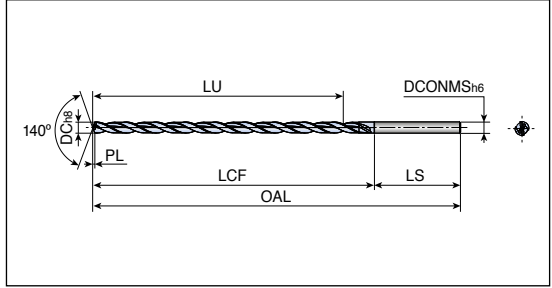

Designation	Dimension (mm)							Grade
	DC	DCONMS	OAL	LU	LCF	LS	PL	
SHO 10040	4.0	4	105.6	50	55.6	50	0.6	●
10050	5.0	5	115.8	60	65.8	50	0.8	●
10060	6.0	6	131.0	76	81.0	50	1.0	●
10070	7.0	7	141.1	86	91.1	50	1.1	●
10080	8.0	8	156.3	98	106.3	50	1.3	●
10090	9.0	9	171.4	108	116.4	55	1.4	●
10100	10.0	10	191.6	123	131.6	60	1.6	●
15040	4.0	4	125.6	70	75.6	50	0.6	●
15050	5.0	5	140.8	85	90.8	50	0.8	●
15060	6.0	6	161.0	106	111.0	50	1.0	●
15070	7.0	7	176.1	121	126.1	50	1.1	●
15080	8.0	8	196.3	138	146.3	50	1.3	●
15090	9.0	9	221.4	153	161.4	60	1.4	●
15100	10.0	10	241.6	173	181.6	60	1.6	●
20040	4.0	4	140.6	85	90.6	50	0.6	●
20050	5.0	5	165.8	110	115.8	50	0.8	●
20060	6.0	6	191.0	136	141.0	50	1.0	●
20070	7.0	7	211.1	156	161.1	50	1.1	●
20080	8.0	8	231.3	173	181.3	50	1.3	●
20090	9.0	9	266.4	198	206.4	60	1.4	●
20100	10.0	10	286.6	218	226.6	60	1.6	●

● Standard items



SHO...-M



Solid carbide drills for pre-thread holes

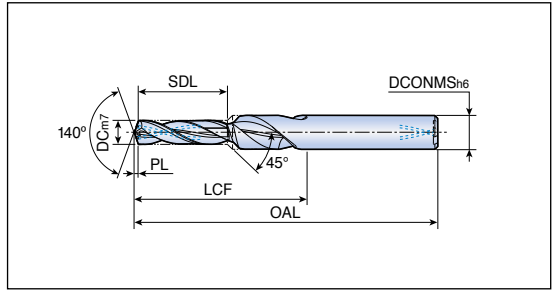

Designation	ISO thread	Dimension (mm)						Grade TT9030
		DC	OAL	SDL	LCF	DCONMS	PL	
SHO 033x12x6-M4	M4	3.3	62.5	12	26.5	6	0.5	●
042x15x6-M5	M5	4.2	66.6	15	28.6	6	0.6	●
050x18x8-M6	M6	5.0	79.8	18	36.8	8	0.8	●
068x24x10-M8	M8	6.8	91.0	24	49.0	10	1.0	●
085x30x12-M10	M10	8.5	103.3	30	56.3	12	1.3	●



●: Standard items

Solid carbide drills for composite material

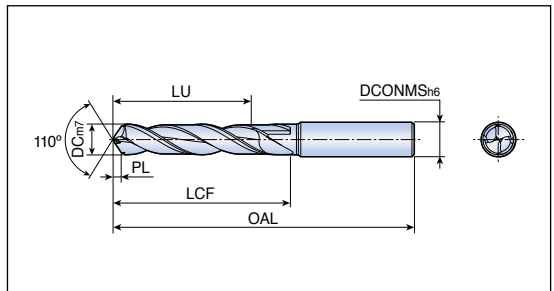

Designation	Dimension (mm)							Grade
	DC (Metric)	DC (Inch)	DCONMS	OAL	LU	LCF	PL	TTD610
CDF 030-027-06	3	-	6	72.7	28	34.7	0.7	●
040-027-06	4	-	6	73.0	28	35.0	1.0	●
0476-034-06	4.76	3/16	6	81.3	35	43.3	1.3	●
050-034-06	5	-	6	81.3	35	43.3	1.3	●
060-034-06	6	-	6	81.7	36	43.7	1.7	●
0635-040-08	6.35	-	8	89.7	42	51.7	1.7	●
070-040-08	7	-	8	89.9	42	51.9	1.9	●
0794-040-08	7.94	5/16	8	90.2	42	52.2	2.2	●
080-040-08	8	-	8	90.2	42	52.2	2.2	●
090-045-10	9	-	10	101.5	48	59.5	2.5	●
0952-045-10	9.52	3/8	10	101.6	48	59.6	2.6	●
100-045-10	10	-	10	101.8	48	59.8	2.8	●
110-052-12	11	-	12	117.1	55	70.1	3.1	●
1111-052-12	11.11	7/16	12	117.1	55	70.1	3.1	●
120-052-12	12	-	12	117.4	55	70.4	3.4	●
127-055-14	12.7	1/2	14	122.6	59c	75.6	3.6	●

● Standard items



T-CHAMFER...T1



Chamfering tools with solid carbide drill

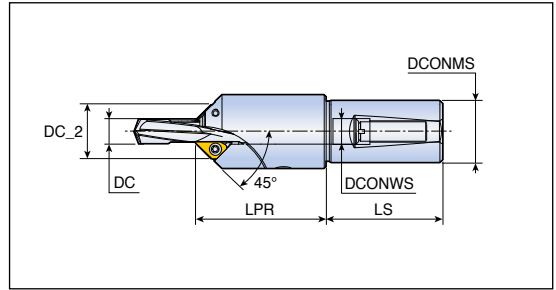

Designation	DC	Dimension (mm)					Insert
		DCONWS	DC_2	DCONMS	LPR	LS	
T-CHAMFER 080-20T1-06	7.1-8.0	8	18.8	20	47.4	50	XCGT 06...-C..
090-20T1-06	8.1-9.0	9	19.8	20	47.4	50	D210
100-32T1-09	9.1-10.0	10	24.9	32	67.3	60	XCGT 09...-C..
110-32T1-09	10.1-11.0	11	25.9	32	67.3	60	D210
120-32T1-09	11.1-12.0	12	26.9	32	67.3	60	
130-32T1-09	12.1-13.0	13	27.9	32	67.3	60	
140-32T1-09	13.1-14.0	14	28.4	32	67.3	60	
150-32T1-09	14.1-15.0	15	29.4	32	67.3	60	
160-32T1-09	15.1-16.0	16	30.4	32	67.3	60	
170-32T1-09	16.1-17.0	17	31.4	32	67.3	60	
180-32T1-09	17.1-18.0	18	32.4	32	67.3	60	
190-32T1-09	18.1-19.0	19	33.4	32	75.0	60	
200-32T1-09	19.1-20.0	20	34.4	32	75.0	60	

Spare parts

Designation	Side screw	Back screw	L-wrench	Insert screw	Wrench
	T-CHAMFER 080 - 090	SS M6x1x6	M6x1-SP	L-W 3	TS 25064I
T-CHAMFER 100 - 200	SS M10x1.5x10	M10x1.5-SP	L-W 5	TS 40093I	TD 15



SHD 3...-CF



Solid carbide drills for T-CHAMFER

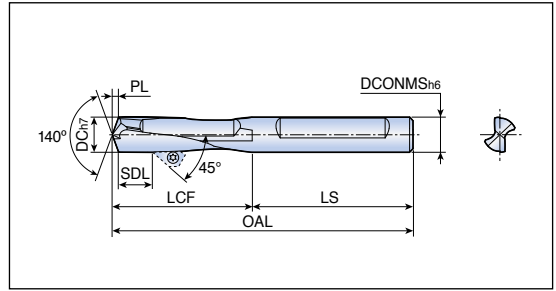

Designation	Dimension (mm)								Grade
	DC	DCONMS	OAL	LCF	LS	SDL _{min}	SDL _{max}	PL	
SHD 3080-CF	8.0	8.0	80.3	37.3	43	9.5	17.5	1.3	●
3090-CF	9.0	9.0	85.4	42.4	43	13.0	23.5	1.4	●
3100-CF	10.0	10.0	90.6	47.6	43	15.5	25.0	1.6	●
3110-CF	11.0	11.0	96.8	53.8	43	21.5	30.0	1.8	●
3120-CF	12.0	12.0	103.9	60.9	43	25.5	37.0	1.9	●
3130-CF	13.0	13.0	104.1	61.1	43	25.5	35.0	2.1	●
3150-CF	15.0	15.0	113.4	65.4	48	26.5	40.5	2.4	●
3170-CF	17.0	17.0	121.7	71.7	50	24.5	44.0	2.7	●
3180-CF	18.0	18.0	125.9	75.9	50	26.5	48.0	2.9	●
3190-CF	19.0	19.0	130.0	76.0	54	26.5	49.0	3.0	●

- ▶ 'SDL' is factored with a 45° insert positioned in insert pocket
- ▶ Solid carbide drill with internal coolant holes is available on request
- : Standard items

Insert	Chamfer angle (°)	Chamfer size
XCGT 0603-C30	30	1.5
0603-C45	45	4.5
0603-C60	60	2.5
XCGT 0903-C30	30	1.5
0903-C45	45	6.0
0903-C60	60	3.5

▶ The maximum chamfer size is obtained when using the smallest drill diameter in the drilling range

TSL-NC

Drill sleeves for Swiss type automatic lathes (Fixed type, internal coolant)

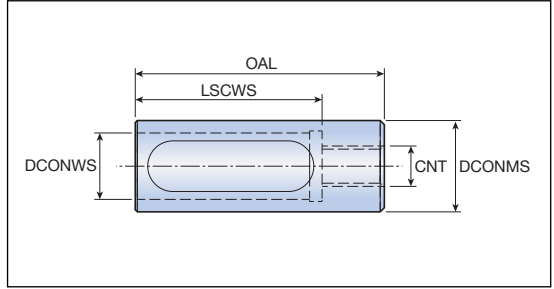

Designation	Dimension (mm)				
	DCONMS	DCONWS	LSCWS	OAL	CNT
TSL-NC 19.05-12	19.05	12.0	45	60	Rc 1/8
19.05-16	19.05	16.0	45	60	Rc 1/8
20-12	20.0	12.0	45	60	Rc 1/8
20-16	20.0	16.0	45	60	Rc 1/8
22-16	22.0	16.0	45	60	Rc 1/8
25-20	25.0	20.0	45	60	Rc 1/8
25.4-20	25.4	20.0	45	60	Rc 1/8
32-25	32.0	25.0	45	60	Rc 1/8

TSL-SW

Drill sleeves for Swiss type automatic lathes (Adjustable type, internal coolant)

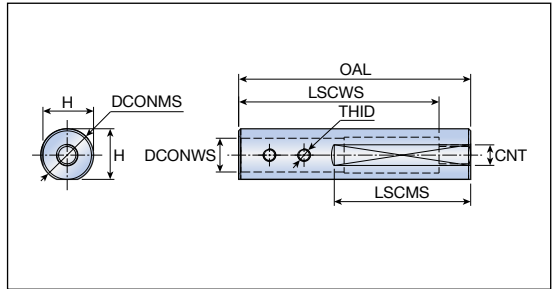

Designation	Dimension (mm)							
	DCONMS	DCONWS	LSCWS	LSCMS	OAL	H	THID	CNT
TSL-SW 22-12	22.0	12.0	95	65	110	21.0	M6	Rc 1/8
25-12	25.0	12.0	95	65	110	24.0	M8	Rc 1/8
25-16	25.0	16.0	95	65	110	24.0	M6	Rc 1/8
25.4-12	25.4	12.0	95	65	110	24.4	M8	Rc 1/8
25.4-16	25.4	16.0	95	65	110	24.4	M6	Rc 1/8
32-12	32.0	12.0	95	65	110	31.0	M8	Rc 1/8
32-16	32.0	16.0	95	65	110	31.0	M8	Rc 1/8
32-20	32.0	20.0	95	65	110	31.0	M8	Rc 1/8

Accessories

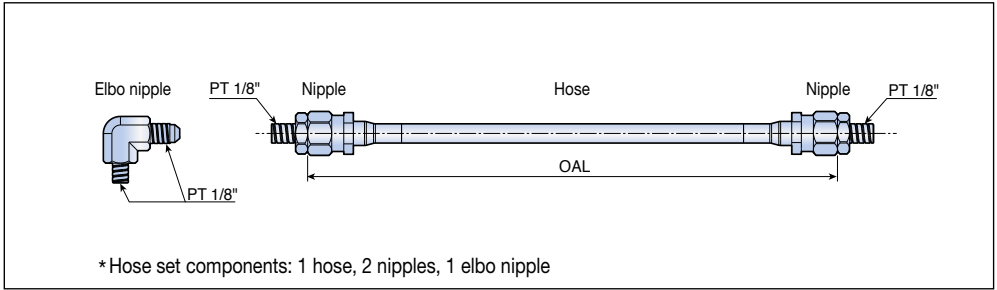

Hose set



Designation	Dimension (mm)	
	OAL (mm)	Max. pressure (bar)
S-TSL HOSE R1/8-220	220	100
R1/8-350	350	100

► Hose set is ordered separately

Spare parts

Designation	Mounting screw	Wrench		
				
TSL-SW 22-12	SS M6X1X5	L-W 3		
TSL-SW 25-12	SS M8X1.25X6	L-W 4		
TSL-SW 25-16	SS M6X1X5	L-W 3		
TSL-SW 25.4-12	SS M8X1.25X6	L-W 4		
TSL-SW 25.4-16	SS M6X1X5	L-W 3		
TSL-SW 32-12	SS M8X1.25X6	L-W 4		
TSL-SW 32-16	SS M8X1.25X6	L-W 4		
TSL-SW 32-20	SS M8X1.25X6	L-W 4		

Reaming Tools



XR...-3B/5B-SO



Head changeable reamer holders for small diameter blind hole



• Cylindrical shank

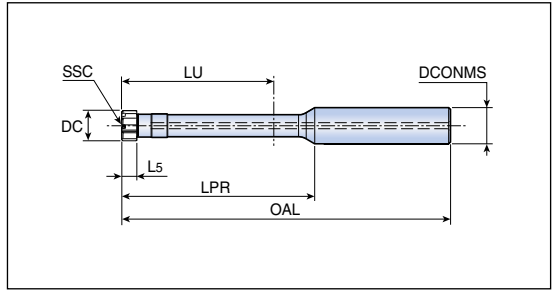

Designation	DC	SSC	Dimension (mm)					Overhang
			DCONMS	L5	OAL	LU	LPR	
XR-D08-3B-10S0	8.000-8.999	8	10	4.0	81.0	28.0	36.0	3XD
D09-3B-10S0	9.000-9.999	9	10	4.5	85.5	31.5	40.5	
D10-3B-12S0	10.000-10.999	10	12	5.0	89.0	35.0	44.0	
D11-3B-12S0	11.000-11.999	11	12	5.5	92.5	38.5	47.5	
D12-3B-12S0	12.000-12.999	12	12	6.0	96.0	42.0	51.0	
XR-D08-5B-10S0	8.000-8.999	8	10	4.0	97.0	44.0	52.0	5XD
D09-5B-10S0	9.000-9.999	9	10	4.5	103.5	49.5	58.5	
D10-5B-12S0	10.000-10.999	10	12	5.0	109.0	55.0	64.0	
D11-5B-12S0	11.000-11.999	11	12	5.5	114.5	60.5	69.5	
D12-5B-12S0	12.000-12.999	12	12	6.0	120.0	66.0	75.0	

- ▶ SSC: Seat size code
- ▶ Matched with XR...-AS reamer heads
- ▶ Reamer head is sold separately from reamer holder

Spare parts

Designation	Clamping key	Key handle
XR-D08	W XR D08-KEY	SW6-T-SH
XR-D09	W XR D08-KEY	SW6-T-SH
XR-D10	W XR D10-KEY	SW6-T-SH
XR-D11	W XR D10-KEY	SW6-T-SH
XR-D12	W XR D12-KEY	SW6-T-SH



▶ Clamping key & clamping screw are included

XR...-3T/5T-S0



Head changeable reamer holders for small diameter through hole



• Cylindrical shank

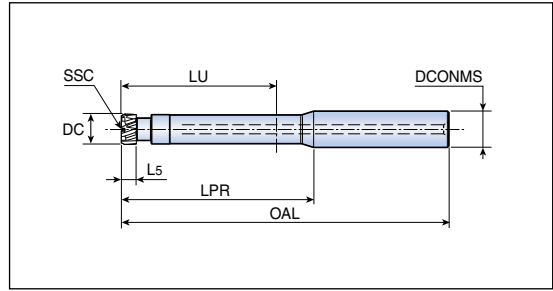

Designation	DC	SSC	Dimension (mm)					Overhang
			DCONMS	L5	OAL	LU	LPR	
XR-D08-3T-10S0	8.000-8.999	8	10	4.0	81.0	28.0	36.0	3XD
D09-3T-10S0	9.000-9.999	9	10	4.5	85.5	31.5	40.5	
D10-3T-12S0	10.000-10.999	10	12	5.0	89.0	35.0	44.0	
D11-3T-12S0	11.000-11.999	11	12	5.5	92.5	38.5	47.5	
D12-3T-12S0	12.000-12.999	12	12	6.0	95.0	42.0	50.0	
XR-D08-5T-10S0	8.000-8.999	8	10	4.0	97.0	44.0	52.0	5XD
D09-5T-10S0	9.000-9.999	9	10	4.5	103.5	49.5	58.5	
D10-5T-12S0	10.000-10.999	10	12	5.0	109.0	55.0	64.0	
D11-5T-12S0	11.000-11.999	11	12	5.5	114.5	60.5	69.5	
D12-5T-12S0	12.000-12.999	12	12	6.0	119.0	66.0	74.0	

- ▶ SSC: Seat size code
- ▶ Matched with XR...-BL reamer heads
- ▶ Reamer head is sold separately from reamer holder

Spare parts

Designation	Clamping key	Key handle
XR-D08	W XR D08-KEY	SW6-T-SH
XR-D09	W XR D08-KEY	SW6-T-SH
XR-D10	W XR D10-KEY	SW6-T-SH
XR-D11	W XR D10-KEY	SW6-T-SH
XR-D12	W XR D12-KEY	SW6-T-SH



▶ Clamping key & clamping screw are included

XR...-AS



Head changeable reamer head

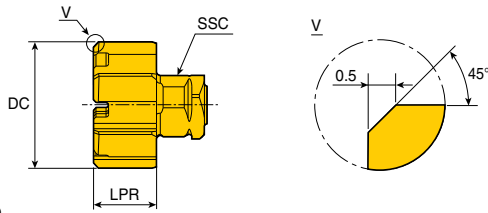

- Straight flute for blind hole
- For H7 hole tolerance

Head	Designation	Dimension (mm)		NOF	SSC	Flute type	Edge type	Grade TT9030
		DC	LPR					
	XR-08.000-AS	8.000	4.0	6	8	S	A	●
	09.000-AS	9.000	4.5	6	9	S	A	●
	10.000-AS	10.000	5.0	6	10	S	A	●
	11.000-AS	11.000	5.5	6	11	S	A	●
	12.000-AS	12.000	6.0	6	6	12	S	A



- ▶ NOF: Number of flutes
- ▶ SSC: Seat size code

●: Standard items

XR...-BL



Head changeable reamer head

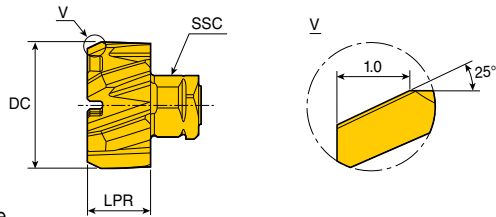

- Helical flute for through hole
- For H7 hole tolerance

Head	Designation	Dimension (mm)		NOF	SSC	Flute type	Edge type	Grade TT9030
		DC	LPR					
	XR-08.000-BL	8.000	4.0	6	8	L	B	●
	09.000-BL	9.000	4.5	6	9	L	B	●
	10.000-BL	10.000	5.0	6	10	L	B	●
	11.000-BL	11.000	5.5	6	11	L	B	●
	12.000-BL	12.000	6.0	6	6	12	L	B



- ▶ NOF: Number of flutes
- ▶ SSC: Seat size code

●: Standard items

Head changeable reamer holders



- Cylindrical shank

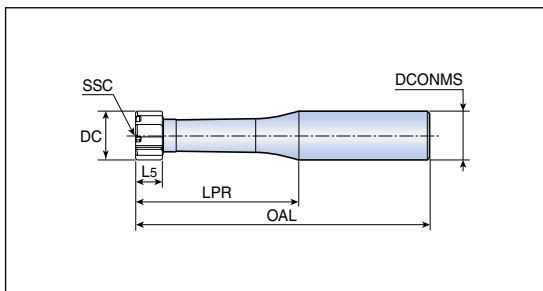

Designation	DC	SSC	Dimension (mm)				Overhang
			DCONMS	L5	OAL	LPR	
TM-3B5-16TO	11.501-13.500	B5	16	9.3	97.8	49.8	3XD
3B6-16TO	13.501-16.000	B6	16	9.4	105.4	57.4	
3B7-20TO	16.000-20.000	B7	20	10.6	120.6	70.6	
3B8-20TO	20.001-25.400	B8	20	12.8	137.8	87.8	
3B9-32TO	25.401-32.000	B9	32	12.8	167.1	107.1	
5B5-16TO	11.501-13.500	B5	16	9.3	125.0	77.0	5XD
5B6-16TO	13.501-16.000	B6	16	9.4	137.4	89.4	
5B7-20TO	16.000-20.000	B7	20	10.6	160.6	110.6	
5B8-20TO	20.001-25.400	B8	20	12.8	187.8	137.8	
5B9-32TO	25.401-32.000	B9	32	12.8	231.1	171.1	
8B5-16TO	11.501-13.500	B5	16	9.3	165.5	117.5	8XD
8B6-16TO	13.501-16.000	B6	16	9.4	185.4	137.4	
8B7-20TO	16.000-20.000	B7	20	10.6	220.6	170.6	
8B8-20TO	20.001-25.400	B8	20	12.8	262.8	212.8	
8B9-32TO	25.401-32.000	B9	32	12.8	327.1	267.1	

- ▶ SSC: Seat size code
- ▶ Reamer head is sold separately from reamer holder

Spare parts

Designation	Clamping screw	Clamping key
TM...B5-16TO	TM-B5-SCR	TM-B5-KEY
TM...B6-16TO	TM-B6-SCR	TM-B6-KEY
TM...B7-20TO	TM-B7-SCR	TM-B7-KEY
TM...B8-20TO	TM-B8-SCR	TM-B8-KEY
TM...B9-32TO	TM-B9-SCR	TM-B9-KEY

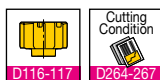

- ▶ Clamping key & clamping screw are included

Head changeable reamer heads

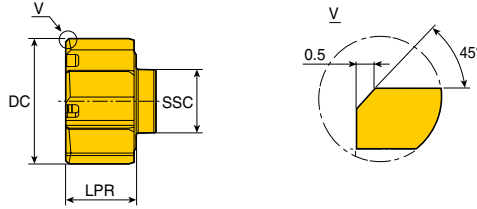

- Straight flute for blind hole
- For H7 hole tolerance

Head	Designation	Dimension (mm)		NOF	SSC	Flute type	Edge type	Grade TT9030	
		DC	LPR						
	TM- 11.501-AS-B5	11.501	9.5	6	B5	S	A	●	
	12.000-AS-B5	12.000	9.5	6	B5	S	A	●	
	13.000-AS-B5	13.000	9.5	6	B5	S	A	●	
	13.500-AS-B5	13.500	9.5	6	B5	S	A	●	
	13.501-AS-B6	13.501	9.5	6	B6	S	A	●	
	14.000-AS-B6	14.000	9.5	6	B6	S	A	●	
	15.000-AS-B6	15.000	9.5	6	B6	S	A	●	
	16.000-AS-B6	16.000	9.5	6	B6	S	A	●	
	16.001-AS-B7	16.001	10.7	6	B7	S	A	●	
	17.000-AS-B7	17.000	10.7	6	B7	S	A	●	
	18.000-AS-B7	18.000	10.7	6	B7	S	A	●	
	19.000-AS-B7	19.000	10.7	6	B7	S	A	●	
	20.000-AS-B7	20.000	10.7	6	B7	S	A	●	
	20.001-AS-B8	20.001	12.9	8	B8	S	A	●	
	21.000-AS-B8	21.000	12.9	8	B8	S	A	●	
	22.000-AS-B8	22.000	12.9	8	B8	S	A	●	
	23.000-AS-B8	23.000	12.9	8	B8	S	A	●	
	24.000-AS-B8	24.000	12.9	8	B8	S	A	●	
	25.000-AS-B8	25.000	12.9	8	B8	S	A	●	
	26.000-AS-B9	26.000	12.9	8	B9	S	A	●	
	27.000-AS-B9	27.000	12.9	8	B9	S	A	●	
	28.000-AS-B9	28.000	12.9	8	B9	S	A	●	
	29.000-AS-B9	29.000	12.9	8	B9	S	A	●	
	30.000-AS-B9	30.000	12.9	8	B9	S	A	●	
	31.000-AS-B9	31.000	12.9	8	B9	S	A	●	
	32.000-AS-B9	32.000	12.9	8	B9	S	A	●	

▶ NOF: Number of flutes
 ▶ SSC: Seat size code

●: Standard items

Head changeable reamer heads

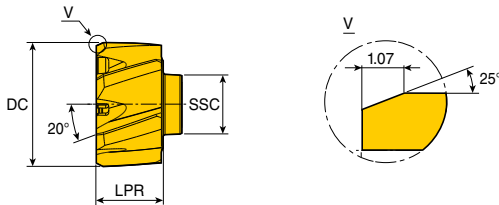

- Helical flute for through hole
- For H7 hole tolerance

Head	Designation	Dimension (mm)		NOF	SSC	Flute type	Edge type	Grade TT9030	
		DC	LPR						
	TM - 11.501-BL-B5	11.501	9.5	6	B5	L	B	•	
	12.000-BL-B5	12.000	9.5	6	B5	L	B	•	
	13.000-BL-B5	13.000	9.5	6	B5	L	B	•	
	13.500-BL-B5	13.500	9.5	6	B5	L	B	•	
	13.501-BL-B6	13.501	9.5	6	B6	L	B	•	
	14.000-BL-B6	14.000	9.5	6	B6	L	B	•	
	15.000-BL-B6	15.000	9.5	6	B6	L	B	•	
	16.000-BL-B6	16.000	9.5	6	B6	L	B	•	
	16.001-BL-B7	16.001	10.7	6	B7	L	B	•	
	17.000-BL-B7	17.000	10.7	6	B7	L	B	•	
	18.000-BL-B7	18.000	10.7	6	B7	L	B	•	
	19.000-BL-B7	19.000	10.7	6	B7	L	B	•	
	20.000-BL-B7	20.000	10.7	6	B7	L	B	•	
	20.001-BL-B8	20.001	12.9	8	B8	L	B	•	
	21.000-BL-B8	21.000	12.9	8	B8	L	B	•	
	22.000-BL-B8	22.000	12.9	8	B8	L	B	•	
	23.000-BL-B8	23.000	12.9	8	B8	L	B	•	
	24.000-BL-B8	24.000	12.9	8	B8	L	B	•	
	25.000-BL-B8	25.000	12.9	8	B8	L	B	•	
	26.000-BL-B9	26.000	12.9	8	B9	L	B	•	
	27.000-BL-B9	27.000	12.9	8	B9	L	B	•	
	28.000-BL-B9	28.000	12.9	8	B9	L	B	•	
	29.000-BL-B9	29.000	12.9	8	B9	L	B	•	
	30.000-BL-B9	30.000	12.9	8	B9	L	B	•	
	31.000-BL-B9	31.000	12.9	8	B9	L	B	•	
	32.000-BL-B9	32.000	12.9	8	B9	L	B	•	



- ▶ NOF: Number of flutes
- ▶ SSC: Seat size code

•: Standard items

Indexable reamer holders



• For through hole

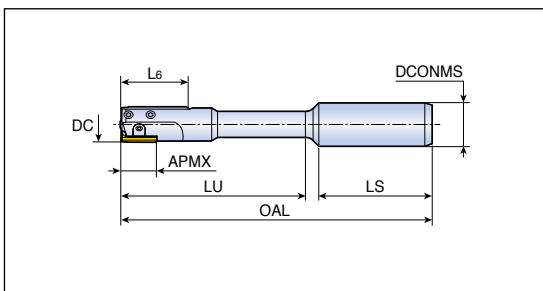

Designation	Dimension (mm)							SSC
	DC	APMX	OAL	LU	LS	L6	DCONMS	
TB - T08.000-S-16T0-1B	8	15.5	123.5	75	45	30	16	1
T09.000-S-16T0-1B	9	15.5	123.5	75	45	30	16	1
T10.000-S-16T0-2B	10	15.5	123.5	75	45	30	16	2
T11.000-S-16T0-2B	11	15.5	123.5	75	45	30	16	2
T12.000-S-16T0-3B	12	17.0	135	85	45	30	16	3
T13.000-S-16T0-3B	13	17.0	135	85	45	30	16	3
T14.000-S-16T0-3B	14	17.0	135	85	45	30	16	3
T15.000-S-16T0-3B	15	17.0	135	85	45	30	16	3
T16.000-S-20T0-3B	16	17.0	165	110	50	30	20	3
T17.000-S-20T0-3B	17	17.0	165	110	50	30	20	3
T18.000-S-20T0-3B	18	17.0	165	110	50	30	20	3
T19.000-S-20T0-3B	19	17.0	165	110	50	30	20	3
T20.000-S-25T0-3B	20	17.0	171	110	56	30	25	3
T21.000-S-25T0-3B	21	17.0	171	110	56	30	25	3
T22.000-S-25T0-3B	22	17.0	191	130	56	30	25	3
T23.000-S-25T0-3B	23	17.0	191	130	56	30	25	3
T24.000-S-25T0-3B	24	17.0	191	130	56	30	25	3
T25.000-S-25T0-3B	25	17.0	191	130	56	30	25	3
T26.000-S-25T0-4B	26	22.5	221	160	56	30	25	4
T27.000-S-25T0-4B	27	22.5	221	160	56	30	25	4
T28.000-S-25T0-4B	28	22.5	221	160	56	30	25	4
T29.000-S-25T0-4B	29	22.5	221	160	56	30	25	4
T30.000-S-25T0-4B	30	22.5	221	160	56	30	25	4
T31.000-S-25T0-4B	31	22.5	221	160	56	30	25	4
T32.000-S-25T0-4B	32	22.5	221	160	56	30	25	4

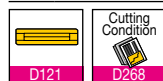

► SSC: Seat size code

► Available upon request

Indexable reamer holders



- For blind hole

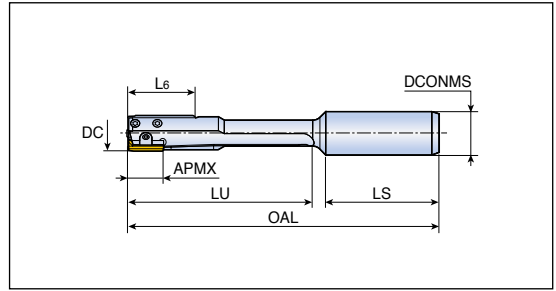

Designation	Dimension (mm)							SSC
	DC	APMX	OAL	LU	LS	L6	DCONMS	
TB-B08.000-S-16T0-1B	8	15.5	123.5	75	45	30	16	1
B09.000-S-16T0-1B	9	15.5	123.5	75	45	30	16	1
B10.000-S-16T0-2B	10	15.5	123.5	75	45	30	16	2
B11.000-S-16T0-2B	11	15.5	123.5	75	45	30	16	2
B12.000-S-16T0-3B	12	17.0	135	85	45	30	16	3
B13.000-S-16T0-3B	13	17.0	135	85	45	30	16	3
B14.000-S-16T0-3B	14	17.0	135	85	45	30	16	3
B15.000-S-16T0-3B	15	17.0	135	85	45	30	16	3
B16.000-S-20T0-3B	16	17.0	165	110	50	30	20	3
B17.000-S-20T0-3B	17	17.0	165	110	50	30	20	3
B18.000-S-20T0-3B	18	17.0	165	110	50	30	20	3
B19.000-S-20T0-3B	19	17.0	165	110	50	30	20	3
B20.000-S-25T0-3B	20	17.0	171	110	56	30	25	3
B21.000-S-25T0-3B	21	17.0	171	110	56	30	25	3
B22.000-S-25T0-3B	22	17.0	191	130	56	30	25	3
B23.000-S-25T0-3B	23	17.0	191	130	56	30	25	3
B24.000-S-25T0-3B	24	17.0	191	130	56	30	25	3
B25.000-S-25T0-3B	25	17.0	191	130	56	30	25	3
B26.000-S-25T0-4B	26	22.5	221	160	56	30	25	4
B27.000-S-25T0-4B	27	22.5	221	160	56	30	25	4
B28.000-S-25T0-4B	28	22.5	221	160	56	30	25	4
B29.000-S-25T0-4B	29	22.5	221	160	56	30	25	4
B30.000-S-25T0-4B	30	22.5	221	160	56	30	25	4
B31.000-S-25T0-4B	31	22.5	221	160	56	30	25	4
B32.000-S-25T0-4B	32	22.5	221	160	56	30	25	4



► SSC: Seat size code

► Available upon request

TB Blade



Indexable blades

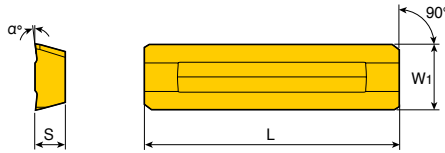

• For H6 hole tolerance

Insert	Designation	Dimension (mm)				SSC	Lead type	Grades	
		Rake angle (α°)	L	W1	S			TT5030	TT5050
	TB-1B06	6	15.5	2.8	1.5	1	B	•	
	1B12	12	15.5	2.8	1.5	1	B	•	
	1A06	6	15.5	2.8	1.5	1	A		•
	1B06	6	15.5	2.8	1.5	1	B		•
	2B06	6	15.5	3.6	1.5	2	B	•	
	2B12	12	15.5	3.6	1.5	2	B	•	
	2A06	6	15.5	3.6	1.5	2	A		•
	2B06	6	15.5	3.6	1.5	2	B		•
	3B06	6	17.0	4.4	2.0	3	B	•	
	3B12	12	17.0	4.4	2.0	3	B	•	
	3A06	6	17.0	4.4	2.0	3	A		•
	3B06	6	17.0	4.4	2.0	3	B		•
	4B06	6	22.5	6.6	3.0	4	B	•	
	4B12	12	22.5	6.6	3.0	4	B	•	
	4A06	6	22.5	6.6	3.0	4	A		•
	4B06	6	22.5	6.6	3.0	4	B		•



▶ Grades application
 -TT5030: TiAlN coating for steel(P) and stainless steel(M) -TT5050: TiCN + TiN coating for cast iron(K)
 ▶ SSC: Seat size code

•: Standard items

TS-S...-NS



Solid reamers for blind hole



- Straight flute - DIN1420

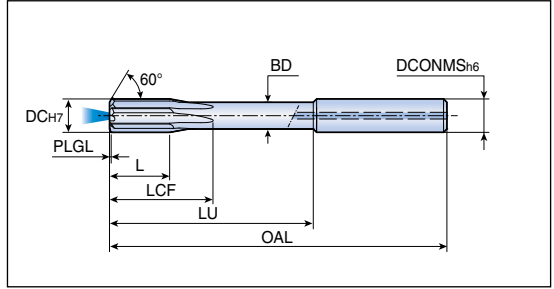

Designation	Dimension (mm)								NOF	Grade TT5040
	DC	L	PLGL	LCF	BD	LU	OAL	DCONMS		
TS-S0300-NS*	3.0	12	0.25	21	2.4	31	60	4.0	4	●
S0400-NS	4.0	12	0.3	17	3.4	40	68	6.0	4	●
S0500-NS	5.0	12	0.3	17	3.8	40	76	6.0	4	●
S0600-NS	6.0	12	0.3	17	4.5	40	76	6.0	4	●
S0700-NS	7.0	15	0.4	20	5.6	65	101	8.0	6	●
S0800-NS	8.0	15	0.4	20	6.4	65	101	8.0	6	●
S0900-NS	9.0	18	0.4	23	7.2	61	101	10.0	6	●
S1000-NS	10.0	18	0.5	23	8.0	61	101	10.0	6	●
S1050-NS	10.5	18	0.5	23	8.4	85	130	12.0	6	●
S1100-NS	11.0	18	0.5	23	8.8	85	130	12.0	6	●
S1150-NS	11.5	18	0.5	23	9.2	85	130	12.0	6	●
S1200-NS	12.0	18	0.5	23	9.6	85	130	12.0	6	●

Cutting Condition
 D270
 ▶ Special diameters are available on request
 ▶ NOF: Number of flutes
 ▶ *: Ø3 reamer does not include a coolant hole

●: Standard items

Solid reamers for through hole



• Left flute - DIN1420

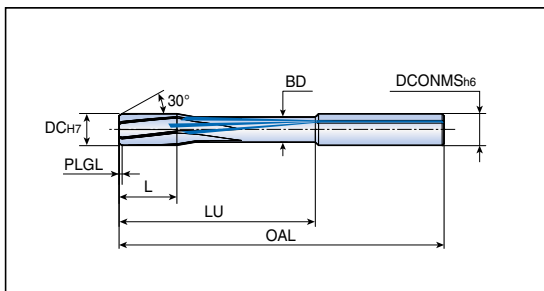

Designation	Dimension (mm)							NOF	Grade TT5040
	DC	L	PLGL	BD	LU	OAL	DCONMS		
TS-L0300-NS *	3.0	12	0.7	2.2	31	60	4.0	4	●
L0400-NS	4.0	12	0.7	3.0	40	68	6.0	4	●
L0500-NS	5.0	12	0.9	3.8	40	76	6.0	4	●
L0600-NS	6.0	12	0.9	4.5	40	76	6.0	4	●
L0700-NS	7.0	15	0.9	5.6	65	101	8.0	6	●
L0800-NS	8.0	15	0.9	6.4	65	101	8.0	6	●
L0900-NS	9.0	18	0.95	7.2	61	101	10.0	6	●
L1000-NS	10.0	18	0.95	8.0	61	101	10.0	6	●
L1050-NS	10.5	18	1.05	8.4	85	130	12.0	6	●
L1100-NS	11.0	18	1.05	8.8	85	130	12.0	6	●
L1150-NS	11.5	18	1.05	9.2	85	130	12.0	6	●
L1200-NS	12.0	18	1.05	9.6	85	130	12.0	6	●

 ▶ Special diameters are available on request
 ▶ NOF: Number of flutes
 ▶ *: Ø3 reamer does not include a coolant hole

●: Standard items

Deep Drilling Tools



DRILL-RUSH head-changeable and modular shank gundrill holders



- Drilling depth: 16-20x diameter

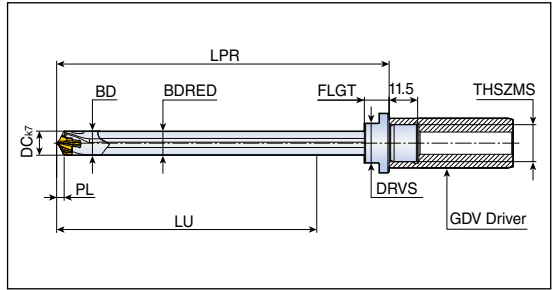

Designation	Dimension (mm)										Clamping Key
	DC	LU	LPR	PL	THSZMS	BD	BDRED	FLGT	DRVS	SSC	
TCDGN 100X200-MF16X1	10.0-10.4	200	274	2.33	MF16X1	9.7	9.6	10	16	10	K TCD D100-D199
100X400-MF16X1	10.0-10.4	400	474	2.33	MF16X1	9.7	9.6	10	16	10	
110X200-MF16X1	11.0-11.4	200	275	2.50	MF16X1	10.7	10.6	10	16	11	
110X400-MF16X1	11.0-11.4	400	474	2.50	MF16X1	10.7	10.6	10	16	11	
120X200-MF16X1	12.0-12.4	200	275	2.67	MF16X1	11.7	11.6	10	16	12	
120X400-MF16X1	12.0-12.4	400	475	2.67	MF16X1	11.7	11.6	10	16	12	
130X200-MF16X1	13.0-13.4	200	276	2.85	MF16X1	12.7	12.6	12	16	13	
130X400-MF16X1	13.0-13.4	400	476	2.85	MF16X1	12.7	12.6	12	16	13	
140X250-MF16X1	14.0-14.4	250	326	3.02	MF16X1	13.7	13.6	12	16	14	
140X400-MF16X1	14.0-14.4	400	476	3.02	MF16X1	13.7	13.6	12	16	14	
145X250-MF16X1	14.5-14.9	250	326	3.02	MF16X1	14.2	14.1	12	18	14	
145X400-MF16X1	14.5-14.9	400	476	3.02	MF16X1	14.2	14.1	12	18	14	
150X400-MF16X1	15.0-15.9	400	484	3.19	MF16X1	14.7	14.6	12	18	15	
160X400-MF20X1	16.0-16.9	400	484	3.46	MF20X1	15.5	15.4	12	18	16	
170X400-MF20X1	17.0-17.9	400	485	3.63	MF20X1	16.5	16.4	12	22	17	
180X400-MF20X1	18.0-18.9	400	486	3.81	MF20X1	17.5	17.4	12	22	18	
190X400-MF20X1	19.0-19.9	400	486	3.98	MF20X1	18.5	18.4	12	22	19	
200X400-MF20X1	20.0-20.9	400	487	4.15	MF20X1	19.5	19.4	12	22	20	K TCD D200-D269
210X400-MF20X1	21.0-21.9	400	503	4.32	MF20X1	20.5	20.4	21	28	21	
220X400-MF20X1	22.0-22.9	400	504	4.50	MF20X1	21.5	21.4	21	28	22	
230X400-MF20X1	23.0-23.9	400	504	4.67	MF20X1	22.5	22.4	21	28	23	
240X400-MF20X1	24.0-24.9	400	505	4.84	MF20X1	23.5	23.4	21	28	24	
250X400-MF20X1	25.0-25.9	400	506	5.01	MF20X1	24.5	24.4	21	28	25	



- ▶ OAL: LPR+11.5
- ▶ Driver is sold separately from drill holder
- ▶ SSC: Seat size code

TCDGN holder drivers

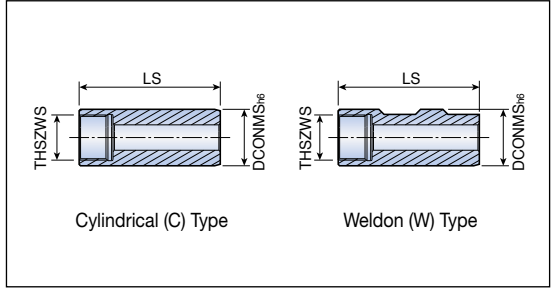

Designation	Dimension (mm)				Shank
	DC	THSZMS	DCONMS	LS	
GDV 10-MF16X1-M-C20-T	10.0-15.9	MF16X1	20	50	C
11-MF20X1-M-C25-T	16.0-25.9	MF20X1	25	56	C
22-MF16X1-M-W20-T	10.0-15.9	MF16X1	20	50	W
23-MF20X1-M-W25-T	16.0-25.9	MF20X1	25	56	W

Standard gundrill holders



- Drilling depth: 10-25x diameter

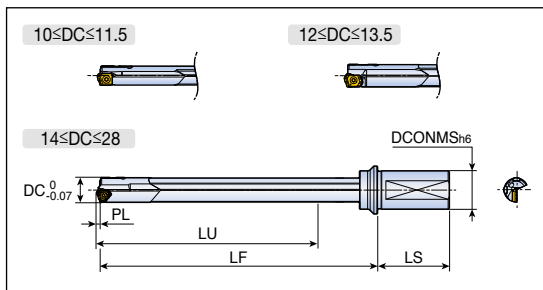

Designation	Dimension (mm)						
	DC	LU	LF	LS	DCONMS	PL	L/D
TRGD 16.00xM25-10	16.0	172	209	56	25	2.2	10
16.50xM25-10	16.5	172	209	56	25	2.2	10
17.00xM25-10	17.0	182	220	56	25	2.2	10
18.00xM25-10	18.0	193	232	56	25	3.0	10
19.00xM25-10	19.0	203	243	56	25	3.0	10
20.00xM32-10	20.0	213	255	60	32	3.2	10
29.00xFM40-10	29.0	294.6	360	69	40	4.57	10
30.00xFM40-10	30.0	314.6	383	69	40	4.57	10
31.00xFM40-10	31.0	314.6	383	69	40	4.57	10
32.00xFM40-10	33.0	324.6	395	69	40	4.57	10
12.00XM20-15	12.0	196.8	225	50	20	1.8	15
12.50XM20-15	12.5	196.8	226	50	20	1.8	15
13.00XM25-15	13.0	211.8	245	56	25	1.8	15
13.50XM25-15	13.5	211.8	245	56	25	1.8	15
14.00xM25-15	14.0	227	261	56	25	2.0	15
14.50xM25-15	14.5	227	262	56	25	2.0	15
15.00xM25-15	15.0	242	278	56	25	2.0	15
16.00xM25-15	16.0	257	294	56	25	2.2	15
16.50xM25-15	16.5	257	294	56	25	2.2	15
17.00xM25-15	17.0	272	310	56	25	2.2	15
17.50xM25-15	17.5	272	310	56	25	2.2	15
18.00xM25-15	18.0	288	327	56	25	3.0	15
18.50xM25-15	18.5	288	327	56	25	3.0	15
19.00xM25-15	19.0	303	343	56	25	3.0	15
19.50xM25-15	19.5	303	343	56	25	3.0	15
20.00xM32-15	20.0	318	360	60	32	3.2	15
21.00xM32-15	21.0	333	376	60	32	3.2	15
22.00xM32-15	22.0	348	393	60	32	3.4	15
23.00xM32-15	23.0	363	409	60	32	3.4	15
24.00xM32-15	24.0	378	426	60	32	3.4	15
25.00xM32-15	25.0	394	442	60	32	3.6	15
26.00xM40-15	26.0	409	449	70	40	3.6	15
27.00xM40-15	27.0	424	465	70	40	3.6	15
28.00xM40-15	28.0	424	467	70	40	3.6	15



► Guide pad is sold separately from drill body

► Available upon request

D129

D260

Standard gundrill holders



• Drilling depth: 10-25x diameter

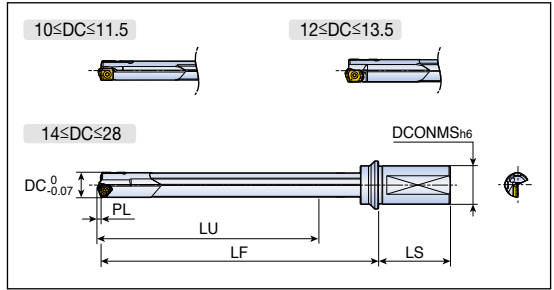

Designation	Dimension (mm)						
	DC	LU	LF	LS	DCONMS	PL	L/D
TRGD 12.00XM20-20	12.0	261.8	290	50	20	1.8	20
12.50XM20-20	12.5	261.8	291	50	20	1.8	20
13.00XM25-20	13.0	281.8	315	56	25	1.8	20
13.50XM25-20	13.5	281.8	315	56	25	1.8	20
14.00xM25-20	14.0	302	336	56	25	2.0	20
14.50xM25-20	14.5	302	337	56	25	2.0	20
15.00xM25-20	15.0	322	358	56	25	2.0	20
29.00xFM40-20	29.0	584.6	650	69	40	4.57	20
30.00xFM40-20	30.0	624.6	693	69	40	4.57	20
31.00xFM40-20	31.0	624.6	693	69	40	4.57	20
32.00xFM40-20	32.0	644.6	715	69	40	4.57	20
10.00XM20-25	10.0	264.5	289.5	50	20	1.8	25
11.00XM20-25	11.0	301.7	329	50	20	1.8	25
11.50XM20-25	11.5	301.7	329	50	20	1.8	25
12.00XM20-25	12.0	326.8	355	50	20	1.8	25
12.50XM20-25	12.5	326.8	356	50	20	1.8	25
13.00XM25-25	13.0	351.8	385	56	25	1.8	25
13.50XM25-25	13.5	351.8	385	56	25	1.8	25
14.00xM25-25	14.0	377	411	56	25	2.0	25
14.50xM25-25	14.5	377	412	56	25	2.0	25
15.00xM25-25	15.0	402	438	56	25	2.0	25
16.00xM25-25	16.0	427	464	56	25	2.2	25
16.50xM25-25	16.5	427	464	56	25	2.2	25
17.00xM25-25	17.0	452	490	56	25	2.2	25
17.50xM25-25	17.5	452	490	56	25	2.2	25
18.00xM25-25	18.0	478	517	56	25	3.0	25
18.50xM25-25	18.5	478	517	56	25	3.0	25
19.00xM25-25	19.0	503	543	56	25	3.0	25
19.50xM25-25	19.5	503	543	56	25	3.0	25
20.00xM32-25	20.0	528	570	60	32	3.2	25
21.00xM32-25	21.0	553	596	60	32	3.2	25
22.00xM32-25	22.0	578	623	60	32	3.4	25
23.00xM32-25	23.0	603	649	60	32	3.4	25
24.00xM32-25	24.0	628	676	60	32	3.4	25
25.00xM32-25	25.0	654	702	60	32	3.6	25

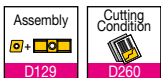

▶ Guide pad is sold separately from drill body

▶ Available upon request

Standard gundrill holders



- Drilling depth: 10-25x diameter

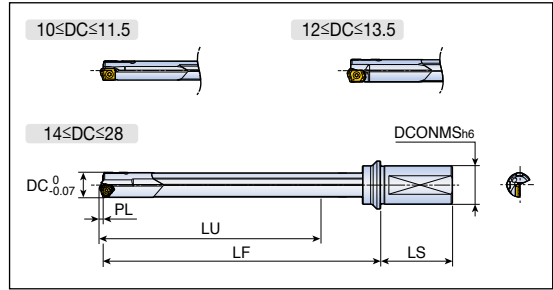

Designation	Dimension (mm)						
	DC	LU	LF	LS	DCONMS	PL	L/D
TRGD 26.00xM40-25	26.0	679	729	70	40	3.6	25
27.00xM40-25	27.0	704	755	70	40	3.6	25
28.00xM40-25	28.0	704	757	70	40	3.6	25

Insert & guide pad

Tool dia. (mm)	Insert			Guide pad		
	Insert	Screw	Wrench	Guide pad	Screw	Wrench
10.00-10.99	ZSGT 060204R-RS	SR-M2.5X0.35L3.8	T-7F	PAD-GP04-16-045-DC-SB	CSTB-2	T-6F
11.00-11.99	LOGT 060204R-RS	SR 10503833L040	T-7F	PAD-GP04-16-050-DC-SB	CSTB-2	T-6F
12.00-13.99				PAD-GP04-16-055-DC-SB		
12.00-13.99				PAD-GP04-16-055-DC-SC		
14.00-15.99	TOGT 070304 RS TT9030	CSTB2.5S*	T-8F	PAD-GP05-18-060-DC-SB PAD-GP05-18-060-DC-SC	SR 34-508	T-7F
16.00-18.00	TOGT 080305 RS TT9030	CSTB2.5S*	T-8F	PAD-GP05-18-075-DC-SB PAD-GP05-18-075-DC-SC	SR 34-508	T-7F
18.01-20.00	TOGT 090305 RS TT9030	CSTB2.5S*	T-8F	PAD-GP06-20-085-DC-SB PAD-GP06-20-085-DC-SC	SR 34-508	T-7F
20.01-21.00	TOGT 100305 RS TT9030	CSTB3S*	T-9F			
21.01-21.99	TOGT 100305 RS TT9030	CSTB3S*	T-9F	PAD-GP06-20-100-DC-SB PAD-GP06-20-100-DC-SC	SR 34-508	T-7F
22.00-25.00	TOGT 110405 RS TT9030	SR14-571/S	T-10/5			
25.01-28.00	TOGT 120405 RS TT9030	CSTB4S	T-15F	PAD-GP06-20-120-DC-SB PAD-GP06-20-120-DC-SC	SR 34-508	T-7F
28.01-29.99	TOGT 130408 RS	SR 16-212/L10	T-20/5	PAD-GP06-20-120-DC-SB PAD-GP06-20-120-DC-SC	SR 34-508	T-7F
30.00-32.00	TOGT 130408 RS	SR 16-212/L10	T-20/5	PAD-GP07-20-120-DC-SB PAD-GP07-20-120-DC-SC	CSTB-3S	T-9F



- ▶ Guide pad with "SB" is the first choice in general purpose machining
- "SC" is an excellent toughness grade used with water-soluble coolant
- ▶ Inserts and guide pads must be ordered separately

Standard gundrill holders



- Drilling depth: 10-15x diameter

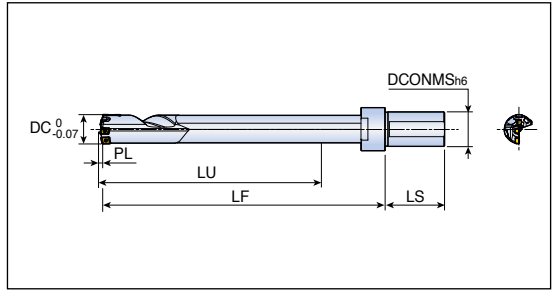

Designation	Dimension (mm)						
	DC	LU	LF	LS	DCONMS	PL	L/D
TRGD3 29.00xFM40-10	29.0	293	360	69	40	2.6	10
30.00xFM40-10	30.0	313	383	69	40	2.9	10
31.00xFM40-10	31.0	313	383	69	40	2.9	10
32.00xFM40-10	32.0	323	395	69	40	3.0	10
33.00xFM40-10	33.0	333	406	69	40	3.1	10
34.00xFM40-10	34.0	343	418	69	40	3.0	10
35.00xFM40-10	35.0	353	428	69	40	3.1	10
36.00xFM40-10	36.0	363	441	69	40	3.1	10
29.00xFM40-15	29.0	438	505	69	40	2.6	15
30.00xFM40-15	30.0	468	538	69	40	2.9	15
31.00xFM40-15	31.0	468	538	69	40	2.9	15
32.00xFM40-15	32.0	483	555	69	40	3.0	15
33.00xFM40-15	33.0	498	571	69	40	3.1	15
34.00xFM40-15	34.0	513	588	69	40	3.0	15
35.00xFM40-15	35.0	528	603	69	40	3.1	15
36.00xFM40-15	36.0	543	621	69	40	3.1	15

- ▶ Guide pad is sold separately from drill body.
- ▶ Supply up to 40.0mm drill diameter

▶ Available upon request

Insert & guide pad

Parts	Diameter (mm)				
	29.0-29.99	30.0-33.0	33.01-35.0	35.01-36.0	
Insert	Peripheral insert	NPHT 060304R-G-P	NPHT 080404R-G-P	NPHT 080404R-G-P	NPHT 080404R-G-P
	Screw	CSTB2.2	CSTB2.5	CSTB2.5	CSTB2.5
	Wrench	T-7F	T-8F	T-8F	T-8F
	Inner insert	NPMT 060304R-G-I	NPMT 070404R-G-I	NPMT 070404R-G-I	NPMT 070404R-G-I
	Screw	CSTB2.2	CSTB2.5	CSTB2.5	CSTB2.5
	Wrench	T-7F	T-8F	T-8F	T-8F
	Center insert	NPMT 070408L-G-C	NPMT 070408L-G-C	NPMT 070408L-G-C	NPMT 080408L-L-C
	Screw	CSTB2.5	CSTB2.5	CSTB2.5	CSTB2.5
	Wrench	T-8F	T-8F	T-8F	T-8F
Pad	Guide pad	PAD-GP06-20-120-DC-SB	PAD-GP06-20-120-DC-SB	PAD-GP07-20-120-DC-SB	PAD-GP07-20-120-DC-SB
	Screw	PAD-GP06-20-120-DC-SC	PAD-GP06-20-120-DC-SC	PAD-GP07-20-120-DC-SC	PAD-GP07-20-120-DC-SC
	Wrench	SR 34-508	SR 34-508	CSTB3S	CSTB3S



- ▶ Inserts and guide pads must be ordered separately

Standard gundrill holders

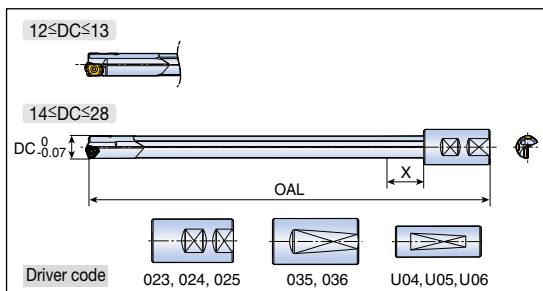

Designation	Driver code	Dimension (mm)		
		DC	OAL	X
TRGDL 12.00X800-XXX	U03 022	12	801.8	18
12.00X800-XXX		12	801.8	18
12.00X1000-XXX		12	1001.8	18
12.00X1000-XXX		12	1001.8	18
12.00X1650-XXX		12	1651.8	18
12.00X1650-XXX		12	1651.8	18
12.70X1219-XXX	U04	12.7	1220.8	19
12.70X1524-XXX		12.7	1525.8	19
13.00X800-XXX	U04 023	13	801.8	20
13.00X800-XXX		13	801.8	20
13.00X1000-XXX		13	1001.8	20
13.00X1000-XXX		13	1001.8	20
13.00X1650-XXX		13	1651.8	20
13.00X1650-XXX		13	1651.8	20
13.49X1219-XXX	U04	13.49	1220.8	20
13.49X1527-XXX		13.49	1528.8	20
14.00x800-XXX	U04 023	14	800	21
14.00x1000-XXX		14	1000	21
14.00x1650-XXX		14	1650	21
14.50x800-XXX		14.5	800	22
14.50x1000-XXX		14.5	1000	22
14.50x1650-XXX		14.5	1650	22
15.00x800-XXX	U04 023 035	15	800	23
15.00x1000-XXX		15	1000	23
15.00x1650-XXX		15	1650	23
16.00x800-XXX		16	800	24
16.00x1000-XXX		16	1000	24
16.00x1500-XXX		16	1500	24
17.00x1000-XXX		17	1000	25
17.00x1500-XXX		17	1500	25
18.00x800-XXX		18	800	27
18.00x1000-XXX		18	1000	27
18.00x1500-XXX		18	1500	27
19.00x800-XXX		19	800	28
19.00x1000-XXX	19	1000	28	
19.00x1500-XXX	19	1500	28	



▶ Guide pad is sold separately from drill body

▶ Available upon request
▶ Select "XXX" driver code

Standard gundrill holders

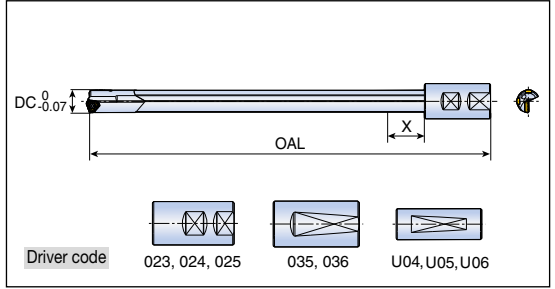

Designation	Driver code	Dimension (mm)			
		DC	OAL	X	
TRGDL 20.00x800-XXX	U05 024 036	20	800	30	
20.00x1000-XXX		20	1000	30	
20.00x1500-XXX		20	1500	30	
21.00x1000-XXX		21	1000	31	
21.00x1500-XXX		21	1500	31	
22.00x1000-XXX		22	1000	33	
22.00x1500-XXX		22	1500	33	
23.00x1000-XXX		23	1000	34	
23.00x1500-XXX		23	1500	34	
24.00x1000-XXX		24	1000	36	
24.00x1500-XXX		24	1500	36	
25.00x1000-XXX		25	1000	37	
25.00x1500-XXX		25	1500	37	
26.00x1000-XXX		U06 025 026 036	26	1000	39
26.00x1500-XXX			26	1500	39
27.00x1000-XXX			27	1000	40
27.00x1500-XXX			27	1500	40
28.00x1000-XXX	28		1000	42	
28.00x1500-XXX	28		1500	42	

Assembly Cutting Condition

D133 D260

▶ Guide pad is sold separately from drill body

▶ Available upon request
▶ Select "XXX" driver code

Insert & guide pad

Tool dia. (mm)	Insert			Guide pad		
	Insert	Screw	Wrench	Guide pad	Screw	Wrench
12.00-13.99	LOGT 060204R-RS	SR 10503833L040	T-7F	PAD-GP04-16-055-DC-SB PAD-GP04-16-055-DC-SC	TS 20043/HG-P	T-7F
14.00-15.99	TOGT 070304 RS TT9030	CSTB2.5S	T-8F	PAD-GP05-18-060-DC-SB PAD-GP05-18-060-DC-SC	SR 34-508	T-7F
16.00-18.00	TOGT 080305 RS TT9030	CSTB2.5S	T-8F	PAD-GP05-18-075-DC-SB PAD-GP05-18-075-DC-SC	SR 34-508	T-7F
18.01-20.00	TOGT 090305 RS TT9030	CSTB2.5S*	T-8F	PAD-GP06-20-085-DC-SB PAD-GP06-20-085-DC-SC	SR 34-508	T-7F
20.01-21.00	TOGT 100305 RS TT9030	CSTB3S*	T-9F			
21.01-21.99	TOGT 100305 RS TT9030	CSTB3S*	T-9F	PAD-GP06-20-100-DC-SB PAD-GP06-20-100-DC-SC	SR 34-508	T-7F
22.00-25.00	TOGT 110405 RS TT9030	SR14-571/S	T-10/5			
25.01-28.00	TOGT 120405 RS TT9030	CSTB4S	T-15F	PAD-GP07-20-120-DC-SB PAD-GP07-20-120-DC-SC	SR 34-508	T-7F



- ▶ Guide pad with "SB" is the first choice in general purpose machining
- "SC" is a excellent toughness grade used with water-soluble coolant
- ▶ Inserts and guide pads must be ordered separately

Driver for TRGDL Type

Driver	Driver code	Dimension (mm)	
		LS	DCONMS
	022	50	20.00
	023	56	25.00
	024	60	32.00
	025	70	40.00
	026	80	50.00
	035	56	25.00
	036	60	32.00
	U03	70	19.05
	U04	70	25.40
	U05	70	31.75
	U06	70	38.10

TBTA3...SE4



Single tube system



- Outer four start thread

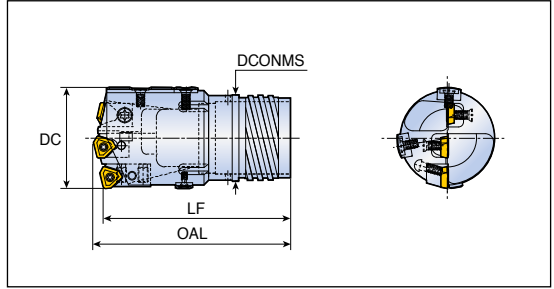

Designation	DC	Dimension (mm)			Tube	
		LF	OAL	DCONMS	Part	Diameter (mm)
TBTA3-xxx.xxSE4-33	38.00-39.60	85	90	30	BTSI 033	33
xxx.xxSE4-36	39.61-43.00	85	91	33	BTSI 036	36
xxx.xxSE4-39	43.01-47.00	95	101	36	BTSI 039	39
xxx.xxSE4-43	47.01-51.70	95	102	39	BTSI 043	43
xxx.xxSE4-47	51.71-56.20	100	107	43	BTSI 047	47
xxx.xxSE4-51	56.21-60.60	110	118	47	BTSI 051	51
xxx.xxSE4-56A	60.61-64.99	110	119	51	BTSI 056A	56
xxx.xxSE4-56B	65.00-66.99	150	159	52	BTSI 056B	56
xxx.xxSE4-62	67.00-72.99	150	159	58	BTSI 062	62
xxx.xxSE4-68	73.00-79.99	150	160	63	BTSI 068	68
xxx.xxSE4-75	80.00-86.99	180	191	70	BTSI 075	75
xxx.xxSE4-82	87.00-99.99	180	193	77	BTSI 082	82
xxx.xxSE4-94	100.00-106.99	180	193	89	BTSI 094	94

Assembly

D137

Tube

D170-D171

Cutting Condition

D252

TBTA3...SI1

Single tube system

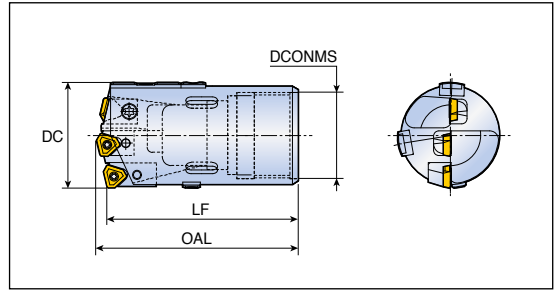

- Inner single start thread

Designation	DC	Dimension (mm)			Tube	
		LF	OAL	DCONMS	Part	Diameter (mm)
TBTA3- xxx.xxSI1-33	38.00-39.99	80	85	30	BTSE 033	33
xxx.xxSI1-36	40.00-43.99	80	86	33	BTSE 036	36
xxx.xxSI1-39	44.00-46.99	90	96	37	BTSE 039	39
xxx.xxSI1-43	47.00-51.99	90	97	41	BTSE 043	43
xxx.xxSI1-47	52.00-56.99	100	107	44	BTSE 047	47
xxx.xxSI1-51	57.00-60.99	110	118	49	BTSE 051	51
xxx.xxSI1-56	61.00-67.99	110	119	53	BTSE 056	56
xxx.xxSI1-62	68.00-74.99	120	129	59	BTSE 062	62
xxx.xxSI1-68	75.00-80.99	150	161	65	BTSE 068	68
xxx.xxSI1-75	81.00-90.99	150	162	71	BTSE 075	75
xxx.xxSI1-82	91.00-98.99	150	162	79	BTSE 082	82
xxx.xxSI1-94	99.00-106.99	150	163	90	BTSE 094	94

Assembly D137	Tube D172-D173	Cutting Condition D252
----------------------	-----------------------	-------------------------------

TBTA3...DE4



Double tube system

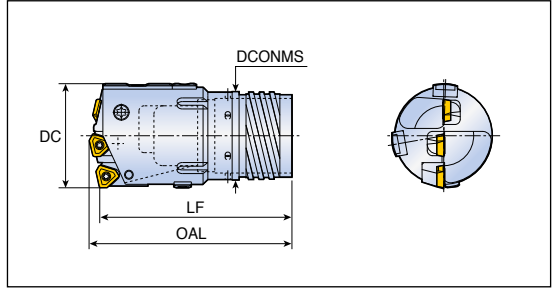

- Outer four start thread

Designation	DC	Dimension (mm)			Tube		
		LF	OAL	DCONMS	Outer tube	Inner tube	Diameter (mm)
TBTA3- xxx.xxDE4-35.5	38.00-39.60	85	90	33	BTDO 035.5	BTDI 026	35.5
xxx.xxDE4-39	39.61-43.00	85	91	36	BTDO 039	BTDI 029	39.0
xxx.xxDE4-42.5	43.01-47.00	95	101	39	BTDO 042.5	BTDI 032	42.5
xxx.xxDE4-46.5	47.01-51.70	100	102	43	BTDO 046.5	BTDI 035	46.5
xxx.xxDE4-51	51.71-56.20	100	107	47	BTDO 051	BTDI 039	51.0
xxx.xxDE4-55.5	56.21-65.00	110	119	51	BTDO 055.5	BTDI 043A	55.5
xxx.xxDE4-56	65.00-66.99	150	159	52	BTDO 056	BTDI 043B	56.0
xxx.xxDE4-62	67.00-72.99	150	159	58	BTDO 062	BTDI 048	62.0
xxx.xxDE4-68	73.00-79.99	150	160	63	BTDO 068	BTDI 053	68.0
xxx.xxDE4-75	80.00-86.99	180	191	70	BTDO 075	BTDI 059	75.0
xxx.xxDE4-82	87.00-99.99	180	193	77	BTDO 082	BTDI 066	82.0
xxx.xxDE4-94	100.00-106.99	180	193	89	BTDO 094	BTDI 078	94.0

Assembly

D137

Tube

D174-D176

Cutting Condition

D252

TBTA3 Series



Assembly of TBTA3 series

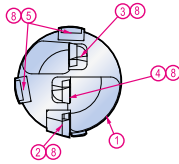
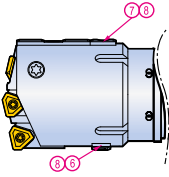

- 1. Head shank
- 2. Outer cartridge
- 3. Inner cartridge
- 4. Center cartridge
- 5. Guide pad
- 6. Sub guide pad
- 7. Guide pad protector
- 8. Lock screw

Parts		Diameter (mm)				
		38.00-39.99	40.00-44.99	45.00-47.99	48.00-51.99	52.00-54.99
Cartridge	Outer	PERC 05R	PERC 402-04	PERC 402-04	PERC 402-04	PERC 402-32
	Adjust screw	AS0003-5	AS0004-8	AS0004-8	AS0004-8	AS0005-10
	Wrench	H1.5	H2	H2	H2	H2.5
	Screw	LS1803RH	LS1803.5RH	LS1803.5RH	LS1803.5RH	LS1805RH
	Wrench	H2	H2.5	H2.5	H2.5	H3
	Inner	CENC 05R	CENC 05R	CENC 05R	CENC 402-04	CENC 402-04
	Screw	CSTB3	CSTB3	CSTB3	CSTB3.5	CSTB3.5
	Wrench	T-9D	T-9D	T-9D	T-15D	T-15D
	Center	CENC 05R	CENC 05R	CENC 402-04	CENC 402-04	CENC 402-04
	Screw	CSTB3	CSTB3	CSTB3.5	CSTB3.5	CSTB3.5
Wrench	T-9D	T-9D	T-15D	T-15D	T-15D	
Insert	Outer	NPMX 080308R-G	TPMX 140308R-G	TPMX 140308R-G	TPMX 140308R-G	TPMX 170408R-G
	Screw	CSTB2.2	CSTB2.5	CSTB2.5	CSTB2.5	CSTB3.5D
	Wrench	T-7D	T-8D	T-8D	T-8D	T-9D
	Inner	NPMX 080308R-G	NPMX 080308R-G	NPMX 080308R-G	TPMX 140308R-G	TPMX 140308R-G
	Screw	CSTB2.2	CSTB2.2	CSTB2.2	CSTB2.5	CSTB2.5
	Wrench	T-7D	T-7D	T-7D	T-8D	T-8D
	Center	NPMX 080308R-G	NPMX 080308R-G	TPMX 140308R-G	TPMX 140308R-G	TPMX 140308R-G
Screw	CSTB2.2	CSTB2.2	CSTB2.5	CSTB2.5	CSTB2.5	
Wrench	T-7D	T-7D	T-8D	T-8D	T-8D	
Pad	Guide pad	PAD-GP08-25-155-DC-SB	PAD-GP08-25-155-DC-SB	PAD-GP10-35-200-DC-SB	PAD-GP10-35-200-DC-SB	PAD-GP10-35-200-DC-SB
	Screw	PAD-GP08-25-155-DC-SC	PAD-GP08-25-155-DC-SC	PAD-GP10-35-200-DC-SC	PAD-GP10-35-200-DC-SC	PAD-GP10-35-200-DC-SC
	Wrench	T-9D	T-9D	T-15D	T-15D	T-15D
	Guide pad protector	PAD-P08	PAD-P08	PAD-P10	PAD-P10	PAD-P10
	Screw	CSTB3S	CSTB3S	CSTB4S	CSTB4S	CSTB4S
	Wrench	T-9D	T-9D	T-15D	T-15D	T-15D
	Sub guide pad	PAD-S08	PAD-S08	PAD-S08	PAD-S08	PAD-S08
	Screw	CSTB3S	CSTB3S	CSTB3S	CSTB3S	CSTB3S
	Wrench	T-9D	T-9D	T-9D	T-9D	T-9D



Assembly of TBTA3 series

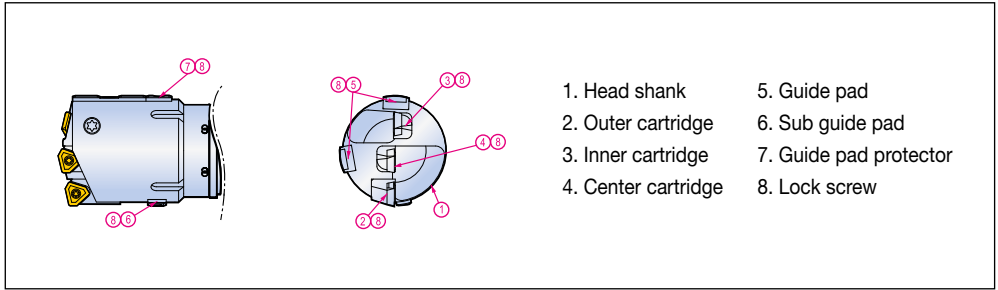

- | | |
|---------------------|------------------------|
| 1. Head shank | 5. Guide pad |
| 2. Outer cartridge | 6. Sub guide pad |
| 3. Inner cartridge | 7. Guide pad protector |
| 4. Center cartridge | 8. Lock screw |

Parts		Diameter (mm)				
		55.00-57.99	58.00-59.99	60.00-63.99	64.00-67.99	68.00-77.99
Cartridge	Outer	PERC 402-32	PERC 402-32	PERC 402-32	PERC 402-43	PERC 402-32
	Adjust screw	AS0005-10	AS0005-10	AS0005-10	AS0005-15	AS0005-10
	Wrench	H2.5	H2.5	H2.5	H2.5	H2.5
	Screw	LS1805RH	LS1805RH	LS1805RH	LS1806RH	LS1805RH
	Wrench	H3	H3	H3	H4	H3
	Inner	CENC 402-04	CENC 402-32	CENC 402-32	CENC 402-32	CENC 402-43
	Screw	CSTB3.5	CSTA5	CSTA5	CSTA5	LS1206
	Wrench	T-15D	T-15D	T-15D	T-15D	H3
	Center	CENC 402-32	CENC 402-32	CENC 402-32	CENC 402-32	CENC 402-43
	Screw	CSTA5	CSTA5	CSTA5	CSTA5	LS1206
Wrench	T-15D	T-15D	T-15D	T-15D	H3	
Insert	Outer	TPMX 170408R-G	TPMX 170408R-G	TPMX 170408R-G	TPMX 240512R-G	TPMX 170408R-G
	Screw	CSTB3.5D	CSTB3.5D	CSTB3.5D	CSTB4M	CSTB3.5D
	Wrench	T-9D	T-9D	T-9D	T-15D	T-9D
	Inner	TPMX 140308R-G	TPMX 170408R-G	TPMX 170408R-G	TPMX 170408R-G	TPMX 240512R-G
	Screw	CSTB2.5	CSTB3.5D	CSTB3.5D	CSTB3.5D	CSTB4M
	Wrench	T-8D	T-9D	T-9D	T-9D	T-15D
	Center	TPMX 170408R-G	TPMX 170408R-G	TPMX 170408R-G	TPMX 170408R-G	TPMX 240512R-G
	Screw	CSTB3.5D	CSTB3.5D	CSTB3.5D	CSTB3.5D	CSTB4M
Wrench	T-9D	T-9D	T-9D	T-9D	T-15D	
Pad	Guide pad	PAD-GP10-35-200-DC-SB	PAD-GP10-35-200-DC-SB	PAD-GP14-40-250-DC-SB	PAD-GP14-40-250-DC-SB	PAD-GP14-40-250-DC-SB
		PAD-GP10-35-200-DC-SC	PAD-GP10-35-200-DC-SC	PAD-GP14-40-250-DC-SC	PAD-GP14-40-250-DC-SC	PAD-GP14-40-250-DC-SC
	Screw	CSTB4S	CSTB4S	CSTA5S	CSTA5S	CSTA5S
	Wrench	T-15D	T-15D	T-15D	T-15D	T-15D
	Guide pad protector	PAD-P10	PAD-P10	PAD-P14	PAD-P14	PAD-P14
	Screw	CSTB4S	CSTB4S	CSTA5S	CSTA5S	CSTA5S
	Wrench	T-15D	T-15D	T-15D	T-15D	T-15D
	Sub guide pad	PAD-S08	PAD-S08	PAD-S08	PAD-S10	PAD-S10
	Screw	CSTB3S	CSTB3S	CSTB3S	CSTB3S	CSTB3S
	Wrench	T-9D	T-9D	T-9D	T-9D	T-9D



TBTA3 Series



Assembly of TBTA3 series

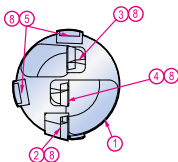
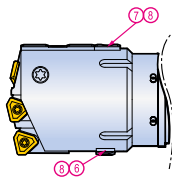

1. Head shank
2. Outer cartridge
3. Inner cartridge
4. Center cartridge
5. Guide pad
6. Sub guide pad
7. Guide pad protector
8. Lock screw

Parts	Diameter (mm)				
	78.00-84.99	85.00-91.99	92.00-98.99	99.00-106.99	
Cartridge	Outer	PERC 402-43	PERC 402-63	PERC 402-43	PERC 402-63
	Adjust screw	AS0005-15	AS0006-15	AS0005-15	AS0006-15
	Wrench	H2.5	H3	H2.5	H3
	Screw	LS1806RH	LS1806RH	LS1806RH	LS1806RH
	Wrench	H4	H4	H4	H4
	Inner	CENC 402-43	CENC 402-43	CENC 402-63	CENC 402-63
	Screw	LS1206	LS1206	LS1206	LS1206
	Wrench	H3	H3	H3	H3
	Center	CENC 402-43	CENC 402-43	CENC 402-63	CENC 402-63
	Screw	LS1206	LS1206	LS1206	LS1206
Insert	Outer	TPMX 240512R-G	TPMX 280716R-G	TPMX 240512R-G	TPMX 280716R-G
	Screw	CSTB4M	CSTB5	CSTB4M	CSTB5
	Wrench	T-15D	T-20D	T-15D	T-20D
	Inner	TPMX 240512R-G	TPMX 240512R-G	TPMX 280716R-G	TPMX 280716R-G
	Screw	CSTB4M	CSTB4M	CSTB5	CSTB5
	Wrench	T-15D	T-15D	T-20D	T-20D
	Center	TPMX 240512R-G	TPMX 240512R-G	TPMX 280716R-G	TPMX 280716R-G
Pad	Screw	CSTB4M	CSTB4M	CSTB5	CSTB5
	Wrench	T-15D	T-15D	T-20D	T-20D
	Guide pad	PAD-GP14-40-250-DC-SB	PAD-GP14-40-250-DC-SB	PAD-GP14-40-250-DC-SB	PAD-GP18-40-300-DC-SB
	Screw	PAD-GP14-40-250-DC-SC	PAD-GP14-40-250-DC-SC	PAD-GP14-40-250-DC-SC	PAD-GP18-40-300-DC-SC
	Wrench	CSTA5S	CSTA5S	CSTA5S	LS1206S
	Wrench	T-15D	T-15D	T-15D	H3
	Guide pad protector	PAD-P14	PAD-P14	PAD-P14	PAD-P18
	Screw	CSTA5S	CSTA5S	CSTA5SS	LS1206S
	Wrench	T-15D	T-15D	T-15D	H3
	Sub guide pad	PAD-S10	PAD-S10	PAD-S10	PAD-S14
Screw	CSTB3S	CSTB3S	CSTB3S	CSTA5S	
Wrench	T-9D	T-9D	T-9D	T-15D	



TBTA5...SE4



Single tube system



- Outer four start thread

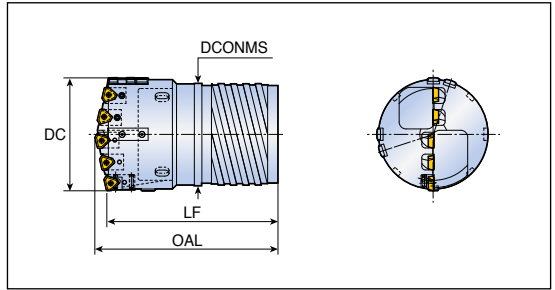

Designation	DC	Dimension (mm)			Tube	
		LF	OAL	DCONMS	Part	Diameter (mm)
TBTA5- xxx.xxSE4-094	107.00-111.99	180	197	89	BTSI 094	94
xxx.xxSE4-106	112.00-123.99	205	221	101	BTSI 106	106
xxx.xxSE4-118	124.00-135.99	205	222	113	BTSI 118	118
xxx.xxSE4-130	136.00-147.99	205	223	125	BTSI 130	130
xxx.xxSE4-142	148.00-159.99	225	245	137	BTSI 142	142
xxx.xxSE4-154	160.00-168.99	225	246	149	BTSI 154	154

TBTA5...SI1



Single tube system



- Inner single start thread

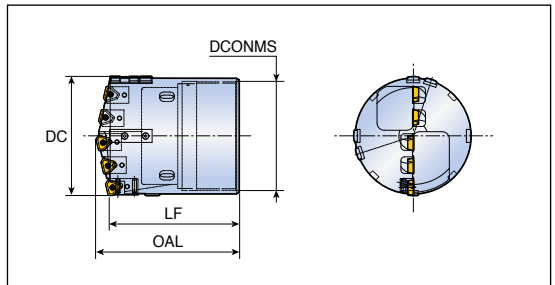

Designation	DC	Dimension (mm)			Tube	
		LF	OAL	DCONMS	Part	Diameter (mm)
TBTA5- xxx.xxSI1-094	107.00-110.99	150	164	90	BTSE 094	94
xxx.xxSI1-106	111.00-122.99	150	165	102	BTSE 106	106
xxx.xxSI1-118	123.00-134.99	150	167	114	BTSE 118	118
xxx.xxSI1-130	135.00-148.99	150	168	126	BTSE 130	130
xxx.xxSI1-142	149.00-161.99	150	170	139	BTSE 142	142
xxx.xxSI1-154	162.00-168.99	190	211	151	BTSE 154	154

Assembly	Tube	Cutting Condition
D142	D171, D173	D252

TBTA5...DE4



Double tube system

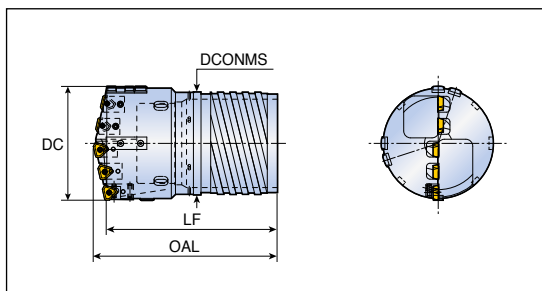

- Outer four start thread

Designation	DC	Dimension (mm)			Tube		
		LF	OAL	DCONMS	Outer Tube	Inner Tube	Diameter (mm)
TBTA5 - xxx.xxDE4-094	107.00-111.99	180	197	89	BTDO 094	BTDI 078	94
xxx.xxDE4-106	112.00-123.99	205	221	101	BTDO 106	BTDI 090	106
xxx.xxDE4-118	124.00-135.99	205	222	113	BTDO 118	BTDI 092	118
xxx.xxDE4-130	136.00-147.99	205	223	125	BTDO 130	BTDI 104	130
xxx.xxDE4-142	148.00-159.99	225	245	137	BTDO 142	BTDI 116	142
xxx.xxDE4-154	160.00-168.99	225	246	149	BTDO 154	BTDI 128	154

<p>Assembly</p>	<p>Tube</p>	<p>Cutting Condition</p>
D142	D174	D252

Assembly of TBTA5 series

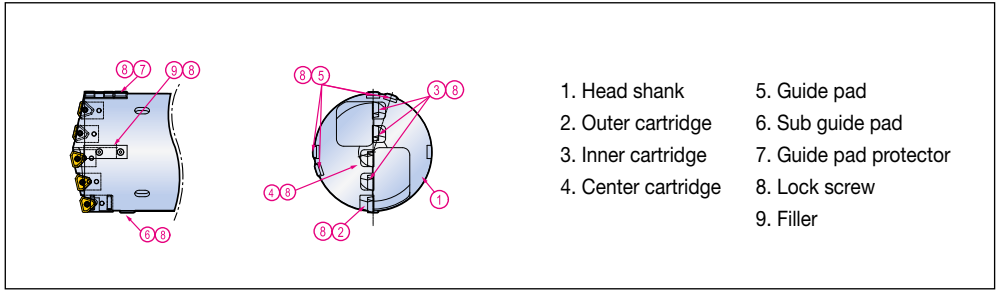

Parts		Diameter (mm)			
		107.00-117.99	118.00-135.99	136.00-144.99	145.00-150.99
Cartridge	Outer	PERC 402-43	PERC 402-43	PERC 402-43	PERC 402-43
	Adjust screw	AS0005-15	AS0005-15	AS0005-15	AS0005-15
	Wrench	H2.5	H2.5	H2.5	H2.5
	Screw	LS1806RH	LS1806RH	LS1806RH	LS1806RH
	Wrench	H4	H4	H4	H4
	Inner	CENC 402-32	CENC 402-43	CENC 402-43	CENC 402-43
	Screw	CSTA5	LS1206	LS1206	LS1206
	Wrench	T-15D	H3	H3	H3
	Center	CENC 402-43	CENC 402-43	CENC 402-63	CENC 402-63
	Screw	LS1206	LS1206	LS1206	LS1206
Insert	Outer	TPMX 240512R-G	TPMX 240512R-G	TPMX 240512R-G	TPMX 240512R-G
	Screw	CSTB4M	CSTB4M	CSTB4M	CSTB4M
	Wrench	T-15D	T-15D	T-15D	T-15D
	Inner	TPMX 170408R-G	TPMX 240512R-G	TPMX 240512R-G	TPMX 240512R-G
	Screw	CSTB3.5D	CSTB4M	CSTB4M	CSTB4M
	Wrench	T-9D	T-15D	T-15D	T-15D
	Center	TPMX 240512R-G	TPMX 240512R-G	TPMX 280716R-G	TPMX 280716R-G
Pad	Screw	CSTB4M	CSTB4M	CSTB5	CSTB5
	Wrench	T-15D	T-15D	T-20D	T-20D
	Guide pad	PAD-GP18-40-300-DC-SB PAD-GP18-40-300-DC-SC	PAD-GP18-40-300-DC-SB PAD-GP18-40-300-DC-SC	PAD-GP18-40-300-DC-SB PAD-GP18-40-300-DC-SC	PAD-GP18-40-300-DC-SB PAD-GP18-40-300-DC-SC
	Screw	LS1206S	LS1206S	LS1206S	LS1206S
	Wrench	H3	H3	H3	H3
	Guide pad protector	PAD-P18	PAD-P18	PAD-P18	PAD-P18
	Screw	LS1206S	LS1206S	LS1206S	LS1206S
	Wrench	H3	H3	H3	H3
	Sub guide pad	PAD-S14	PAD-S14	PAD-S14	PAD-S14
	Screw	CSTA5S	CSTA5S	CSTA5S	CSTA5S
Wrench	T-15D	T-15D	T-15D	T-15D	



TBTA5 Series



Assembly of TBTA5 series

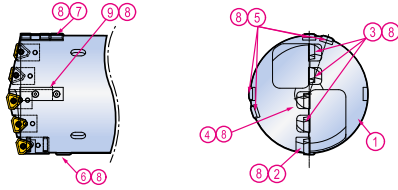

1. Head shank
2. Outer cartridge
3. Inner cartridge
4. Center cartridge
5. Guide pad
6. Sub guide pad
7. Guide pad protector
8. Lock screw
9. Filler

Parts	Diameter (mm)			
	151.00-156.99	157.00-162.99	163.00-168.99	
Cartridge	Outer	PERC 402-63	PERC 402-63	PERC 402-63
	Adjust screw	AS0006-15	AS0006-15	AS0006-15
	Wrench	H3	H3	H3
	Screw	LS1806RH	LS1806RH	LS1806RH
	Wrench	H4	H4	H4
	Inner	CENC 402-43	CENC 402-43	CENC 402-63
	Screw	LS1206	LS1206	LS1206
	Wrench	H3L	H3L	H3L
	Center	CENC 402-63	CENC 402-63	CENC 402-63
	Screw	LS1206S	LS1206S	LS1206S
Insert	Outer	TPMX 280716R-G	TPMX 280716R-G	TPMX 280716R-G
	Screw	CSTB5	CSTB5	CSTB5
	Wrench	T-20D	T-20D	T-20D
	Inner	TPMX 240512R-G	TPMX 240512R-G	TPMX 280716R-G
	Screw	CSTB4M	CSTB4M	CSTB5
	Wrench	T-15D	T-15D	T-20D
	Center	TPMX 280716R-G	TPMX 280716R-G	TPMX 280716R-G
Pad	Screw	CSTB5	CSTB5	CSTB5
	Wrench	T-20D	T-20D	T-20D
	Guide pad	PAD-GP18-40-300-DC-SB	PAD-GP18-40-300-DC-SB	PAD-GP18-40-300-DC-SB
		PAD-GP18-40-300-DC-SC	PAD-GP18-40-300-DC-SC	PAD-GP18-40-300-DC-SC
	Screw	LS1206S	LS1206S	LS1206S
	Wrench	H3	H3	H3L
	Guide pad protector	PAD-P18	PAD-P18	PAD-P18
	Screw	LS1206S	LS1206S	LS1206S
	Wrench	H3	H3	H3
	Sub guide pad	PAD-S14	PAD-S14	PAD-S14
Screw	CSTA5S	CSTA5S	CSTA5S	
Wrench	T-15D	T-15D	T-15D	



TBTA7...SE4



Single tube system

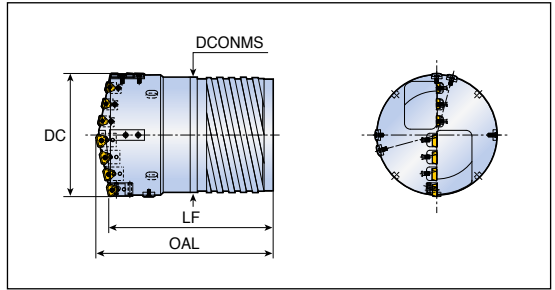

- Outer four start thread
- Double tube system also available on request

Designation	DC	Dimension (mm)			Tube	
		LF	OAL	DCONMS	Part	Diameter (mm)
TBTA7- xxx.xxSE4-154	169.00-171.99	225	246	149	BTSI 154	154
xxx.xxSE4-166	172.00-183.99	225	247	161	BTSI 166	166
xxx.xxSE4-178	184.00-195.99	245	267	173	BTSI 178	178
xxx.xxSE4-190	196.00-207.99	245	270	185	BTSI 190	190
xxx.xxSE4-202	208.00-219.99	245	271	197	BTSI 202	202
xxx.xxSE4-214	220.00-231.99	265	293	208	BTSI 214	214
xxx.xxSE4-226	232.00-232.99	265	293	220	BTSI 226	226

TBTA7...SI1



Single tube system

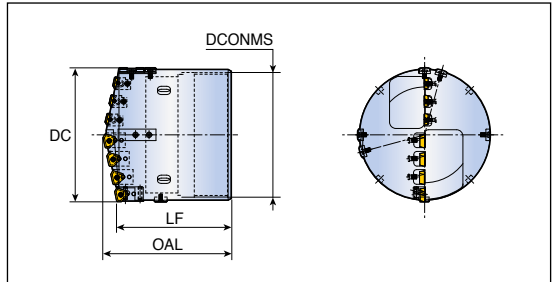

- Inner single start thread

Designation	DC	Dimension (mm)			Tube	
		LF	OAL	DCONMS	Part	Diameter (mm)
TBTA7- xxx.xxSI1-154	169.00-173.99	190	211	151	BTSE 154	154
xxx.xxSI1-166	174.00-185.99	190	213	163	BTSE 166	166
xxx.xxSI1-178	186.00-197.99	190	212	175	BTSE 178	178
xxx.xxSI1-190	198.00-209.99	190	215	187	BTSE 190	190
xxx.xxSI1-202	210.00-221.99	190	217	199	BTSE 202	202
xxx.xxSI1-214	222.00-232.99	190	218	211	BTSE 214	214

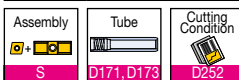

TBTA7 Series



Assembly of TBTA7 series

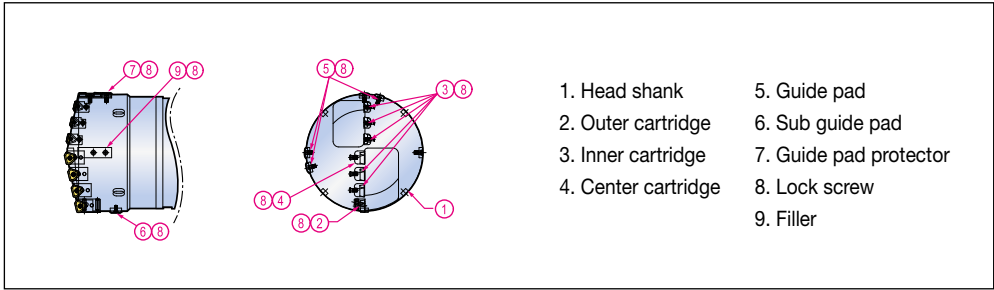

Parts		Diameter (mm)			
		169.00-188.99	189.00-196.99	197.00-202.99	203.00-208.99
Cartridge	Outer	PERC 402-43	PERC 402-43	PERC 402-43	PERC 402-43
	Adjust screw	AS0005-15	AS0005-15	AS0005-15	AS0005-15
	Wrench	H2.5	H2.5	H2.5	H2.5
	Screw	LS1806RH	LS1806RH	LS1806RH	LS1806RH
	Wrench	H4	H4	H4	H4
	Inner	CENC 402-43	CENC 402-43	CENC 402-43	CENC 402-43
	Screw	LS1206	LS1206	LS1206	LS1206
	Wrench	H3L	H3L	H3L	H3L
	Center	CENC 402-43	CENC 402-63	CENC 402-63	CENC 402-63
	Screw	LS1206	LS1206S	LS1206S	LS1206S
Insert	Outer	TPMX 240512R-G	TPMX 240512R-G	TPMX 240512R-G	TPMX 240512R-G
	Screw	CSTB4M	CSTB4M	CSTB4M	CSTB4M
	Wrench	T-15D	T-15D	T-15D	T-15D
	Inner	TPMX 240512R-G	TPMX 240512R-G	TPMX 240512R-G	TPMX 240512R-G
	Screw	CSTB4M	CSTB4M	CSTB4M	CSTB4M
	Wrench	T-15D	T-15D	T-15D	T-15D
	Center	TPMX 240512R-G	TPMX 280716R-G	TPMX 280716R-G	TPMX 280716R-G
Pad	Screw	CSTB4M	CSTB5	CSTB5	CSTB5
	Wrench	T-15D	T-15D	T-15D	T-15D
	Guide pad	PAD-GP18-40-300-DC-SB	PAD-GP18-40-300-DC-SB	PAD-GP18-40-300-DC-SB	PAD-GP18-40-300-DC-SB
		PAD-GP18-40-300-DC-SC	PAD-GP18-40-300-DC-SC	PAD-GP18-40-300-DC-SC	PAD-GP18-40-300-DC-SC
	Screw	LS1206S	LS1206S	LS1206S	LS1206S
	Wrench	H3	H3	H3	H3
	Guide pad protector	PAD-P18	PAD-P18	PAD-P18	PAD-P18
	Screw	LS1206S	LS1206S	LS1206S	LS1206S
	Wrench	H3	H3	H3	H3
	Sub guide pad	PAD-S14	PAD-S14	PAD-S14	PAD-S14
Screw	CSTA5S	CSTA5S	CSTA5S	CSTA5S	
Wrench	T-15D	T-15D	T-15D	T-15D	



TBTA7 Series



Assembly of TBTA7 series

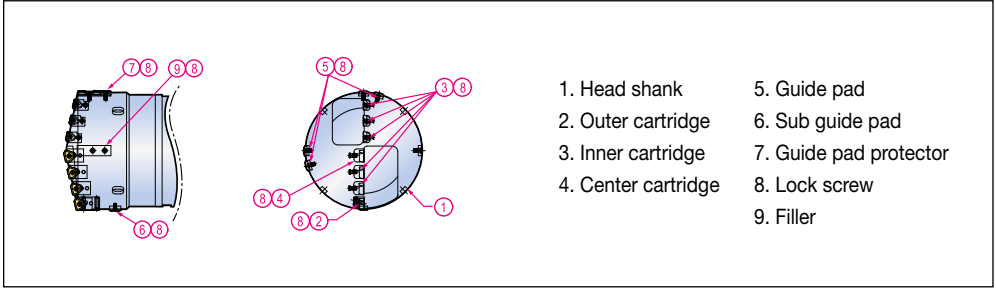

Parts		Diameter (mm)			
		209.00-214.99	215.00-220.99	221.00-226.99	227.00-232.99
Cartridge	Outer	PERC 402-63	PERC 402-63	PERC 402-63	PERC 402-63
	Adjust screw	AS0006-15	AS0006-15	AS0006-15	AS0005-15
	Wrench	H3	H3	H3	H3
	Screw	L1806RH	L1806RH	L1806RH	LS1806RH
	Wrench	H4	H4	H4	H4
	Inner	CENC 402-43	CENC 402-43	CENC 402-43	CENC 402-63
	Screw	LS1206	LS1206	LS1206	LS1206
	Wrench	H3L	H3L	H3L	H3L
	Center	CENC 402-63	CENC 402-63	CENC 402-63	CENC 402-63
	Screw	LS1206S	LS1206	LS1206	LS1206S
Insert	Outer	TPMX 280716R-G	TPMX 280716R-G	TPMX 280716R-G	TPMX 280716R-G
	Screw	CSTB5	CSTB5	CSTB5	CSTB5
	Wrench	T-20D	T-20D	T-20D	T-20D
	Inner	TPMX 240512R-G	TPMX 240512R-G	TPMX 240512R-G	TPMX 280716R-G
	Screw	CSTB4M	CSTB4M	CSTB4M	CSTB5
	Wrench	T-15D	T-15D	T-15D	T-15D
	Center	TPMX 280716R-G	TPMX 280716R-G	TPMX 280716R-G	TPMX 280716R-G
Pad	Screw	CSTB5	CSTB5	CSTB5	CSTB5
	Wrench	T-20D	T-20D	T-20D	T-20D
	Guide pad	PAD-GP18-40-300-DC-SB	PAD-GP18-40-300-DC-SB	PAD-GP18-40-300-DC-SB	PAD-GP18-40-300-DC-SB
	Screw	PAD-GP18-40-300-DC-SC	PAD-GP18-40-300-DC-SC	PAD-GP18-40-300-DC-SC	PAD-GP18-40-300-DC-SC
	Wrench	H3	H3	H3	H3
	Guide pad protector	PAD-P18	PAD-P18	PAD-P18	PAD-P18
	Screw	LS1206S	LS1206S	LS1206S	LS1206S
	Wrench	H3	H3	H3	H3
	Sub guide pad	PAD-S14	PAD-S14	PAD-S14	PAD-S14
	Screw	CSTA5S	CSTA5S	CSTA5S	CSTA5S
Wrench	T-15D	T-15D	T-15D	T-15D	



TBTA9...SE4



Single tube system

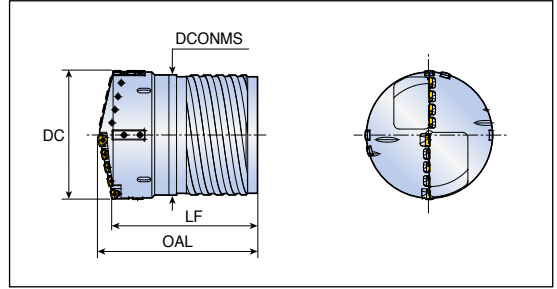

- Outer four start thread

Designation	DC	Dimension (mm)			Tube	
		LF	OAL	DCONMS	Part	Diameter (mm)
TBTA9 - xxx.xxSE4-226	233.00-243.99	265	294	220	BTSI 226	226
xxx.xxSE4-238	244.00-255.99	265	294	232	BTSI 238	238
xxx.xxSE4-250	256.00-267.99	290	322	244	BTSI 250	250
xxx.xxSE4-262	268.00-279.99	290	323	256	BTSI 262	262
xxx.xxSE4-274	280.00-291.99	290	325	268	BTSI 274	274

TBTA9...SI1



Single tube system

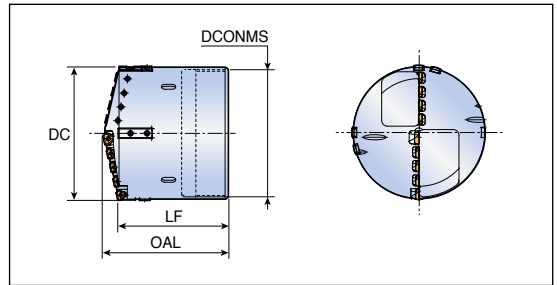

- Inner single start thread

Designation	DC	Dimension (mm)			Tube	
		LF	OAL	DCONMS	Part	Diameter (mm)
TBTA9 - xxx.xxSI1-214	233.00-233.99	190	217	211	BTSE 214	214
xxx.xxSI1-226	234.00-245.99	190	219	223	BTSE 226	226
xxx.xxSI1-238	246.00-257.99	190	221	235	BTSE 238	238
xxx.xxSI1-250	258.00-269.99	210	242	245	BTSE 250	250
xxx.xxSI1-262	270.00-281.99	210	244	259	BTSE 262	262
xxx.xxSI1-274	282.00-293.99	210	245	271	BTSE 274	274

Assembly D148	Tube D171, D173	Cutting Condition D252
----------------------	------------------------	-------------------------------

TBTA9 Series



Assembly of TBTA9 series

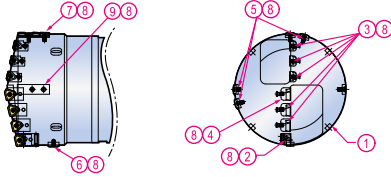

1. Head shank
2. Outer cartridge
3. Inner cartridge
4. Center cartridge
5. Guide pad
6. Sub guide pad
7. Guide pad protector
8. Lock screw
9. Filler

Parts		Diameter (mm)				
		233.00-247.99	248.00-253.99	254.00-258.99	259.00-264.99	265.00-271.99
Cartridge	Outer	PERC 402-43	PERC 402-63	PERC 402-63	PERC 402-63	PERC 402-63
	Adjust screw	AS0005-15	AS0006-15	AS0006-15	AS0006-15	AS0006-15
	Wrench	H2.5	H3	H3	H3	H3
	Screw	LS1806RH	L1806RH	L1806RH	L1806RH	L1806RH
	Wrench	H4	H4	H4	H4	H4
	Inner	CENC 402-43	CENC 402-43	CENC 402-43	CENC 402-43	CENC 402-43
	Screw	LS1206	LS1206	LS1206	LS1206	LS1206
	Wrench	H3L	H3L	H3L	H3L	H3L
	Center	CENC 402-63	CENC 402-63	CENC 402-63	CENC 402-63	CENC 402-63
	Screw	LS1206S	LS1206S	LS1206S	LS1206S	LS1206S
Wrench	H3L	H3L	H3L	H3L	H3L	
Insert	Outer	TPMX 240512R-G	TPMX 280716R-G	TPMX 280716R-G	TPMX 280716R-G	TPMX 280716R-G
	Screw	CSTB4M	CSTB5	CSTB5	CSTB5	CSTB5
	Wrench	T-15D	T-20D	T-20D	T-20D	T-20D
	Inner	TPMX 240512R-G	TPMX 240512R-G	TPMX 240512R-G	TPMX 240512R-G	TPMX 240512R-G
	Screw	CSTB4M	CSTB4M	CSTB4M	CSTB4M	CSTB4M
	Wrench	T-15D	T-15D	T-15D	T-15D	T-15D
	Center	TPMX 280716R-G	TPMX 280716R-G	TPMX 280716R-G	TPMX 280716R-G	TPMX 280716R-G
Screw	CSTB5	CSTB5	CSTB5	CSTB5	CSTB5	
Wrench	T-20D	T-20D	T-20D	T-20D	T-20D	
Pad	Guide pad	PAD-GP18-40-300-DC-SB	PAD-GP18-40-300-DC-SB	PAD-GP18-40-300-DC-SB	PAD-GP18-40-300-DC-SB	PAD-GP18-40-300-DC-SB
	Screw	LS1206S	LS1206S	LS1206S	LS1206S	LS1206S
	Wrench	H3	H3	H3	H3	H3
	Guide pad protector	PAD-P18	PAD-P18	PAD-P18	PAD-P18	PAD-P18
	Screw	LS1206S	LS1206S	LS1206S	LS1206S	LS1206S
	Wrench	H3	H3	H3	H3	H3
	Sub guide pad	PAD-S14	PAD-S14	PAD-S14	PAD-S14	PAD-S14
	Screw	CSTA5S	CSTA5S	CSTA5S	CSTA5S	CSTA5S
	Wrench	T-15D	T-15D	T-15D	T-15D	T-15D



TBTA9 Series



Assembly of TBTA9 series

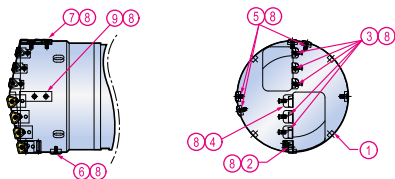

1. Head shank
2. Outer cartridge
3. Inner cartridge
4. Center cartridge
5. Guide pad
6. Sub guide pad
7. Guide pad protector
8. Lock screw
9. Filler

Parts		Diameter (mm)			
		272.00-275.99	276.00-284.99	285.00-289.99	290.00-293.99
Cartridge	Outer	PERC 402-63	PERC 402-63	PERC 402-63	PERC 402-63
	Adjust screw	AS0006-15	AS0006-15	AS0006-15	AS0006-15
	Wrench	H3	H3	H3	H3
	Screw	L1806RH	L1806RH	L1806RH	L1806RH
	Wrench	H4	H4	H4	H4
	Inner	CENC 402-63	CENC 402-63	CENC 402-63	CENC 402-63
	Screw	LS1206S	LS1206S	LS1206S	LS1206S
	Wrench	H3L	H3L	H3L	H3L
	Center	CENC 402-63	CENC 402-63	CENC 402-63	CENC 402-63
	Screw	LS1206S	LS1206S	LS1206S	LS1206S
Insert	Outer	TPMX 280716R-G	TPMX 280716R-G	TPMX 280716R-G	TPMX 280716R-G
	Screw	CSTB5	CSTB5	CSTB5	CSTB5
	Wrench	T-20D	T-20D	T-20D	T-20D
	Inner	TPMX 280716R-G	TPMX 280716R-G	TPMX 280716R-G	TPMX 280716R-G
	Screw	CSTB5	CSTB5	CSTB5	CSTB5
	Wrench	T-20D	T-20D	T-20D	T-20D
	Center	TPMX 280716R-G	TPMX 280716R-G	TPMX 280716R-G	TPMX 280716R-G
Pad	Guide pad	PAD-GP18-40-300-DC-SB	PAD-GP18-40-300-DC-SB	PAD-GP18-40-300-DC-SB	PAD-GP18-40-300-DC-SB
		PAD-GP18-40-300-DC-SC	PAD-GP18-40-300-DC-SC	PAD-GP18-40-300-DC-SC	PAD-GP18-40-300-DC-SC
	Screw	LS1206S	LS1206S	LS1206S	LS1206S
	Wrench	H3	H3	H3	H3
	Guide pad protector	PAD-P18	PAD-P18	PAD-P18	PAD-P18
	Screw	LS1206S	LS1206S	LS1206S	LS1206S
	Wrench	H3	H3	H3	H3
	Sub guide pad	PAD-S14	PAD-S14	PAD-S14	PAD-S14
	Screw	CSTA5S	CSTA5S	CSTA5S	CSTA5S
	Wrench	T-15D	T-15D	T-15D	T-15D



Single tube system

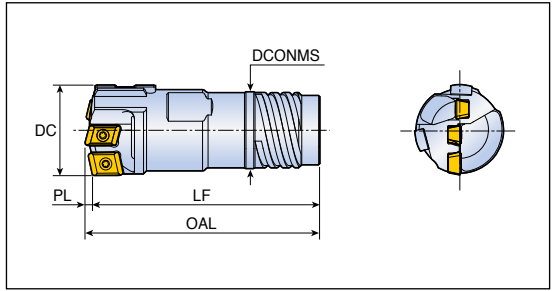

- Outer four start thread

Designation	DC	Dimension (mm)				Tube	
		LF	OAL	DCONMS	PL	Part	Diameter (mm)
TBTA-FB xx.xxSE4-22	25.00-26.40	70	73	19.5	3	BTSI 022	22
xx.xxSE4-24	26.41-28.70	70	73	21.0	3	BTSI 024	24
xx.xxSE4-26	28.71-31.00	75	78	23.5	3	BTSI 026	26
xx.xxSE4-28	31.01-33.30	75	78	25.5	3	BTSI 028	28
xx.xxSE4-30	33.31-36.20	80	83	28.0	3	BTSI 030	30
xx.xxSE4-33	36.21-39.60	90	93	30.0	3	BTSI 033	33
xx.xxSE4-36	39.61-43.00	95	99	33.0	4	BTSI 036	36
xx.xxSE4-39	43.01-47.00	100	104	36.0	4	BTSI 039	39
xx.xxSE4-43	47.01-51.70	100	104	39.0	4	BTSI 043	43
xx.xxSE4-47	51.71-56.20	110	114	43.0	4	BTSI 047	47
xx.xxSE4-51	56.21-60.60	115	120	47.0	5	BTSI 051	51
xx.xxSE4-51	60.61-65.00	115	120	47.0	5	BTSI 051	51
xx.xxSE4-56A	60.61-65.00	115	120	51.0	5	BTSI 056A	56
xx.xxSE4-56B	65.01-66.99	141	149	52.0	8	BTSI 056B	56
xx.xxSE4-62	67.00-72.99	141	149	58.0	8	BTSI 062	62
xx.xxSE4-68	73.00-79.99	141	150	63.0	9	BTSI 068	68
xx.xxSE4-75	80.00-86.99	164	173	70.0	9	BTSI 075	75
xx.xxSE4-82	87.00-89.00	164	173	77.0	9	BTSI 082	82

► Insert and guide pad are sold separately from drill body

Assembly 	Tube 	Cutting Condition
D153	D170-D171	D254

Single tube system

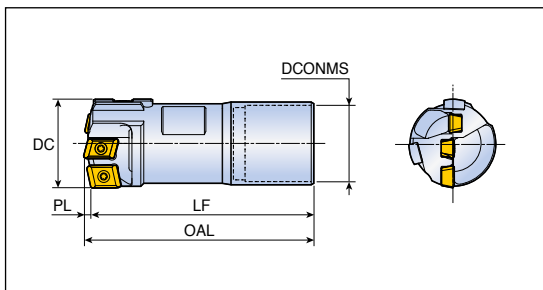

- Inner single start thread

Designation	DC	Dimension (mm)				Tube	
		LF	OAL	DCONMS	PL	Part	Diameter (mm)
TBTA-FB xx.xxSI1-22	25.00-26.99	70	73	20	3	BTSE 022	22
xx.xxSI1-24	27.00-29.00	70	73	22	3	BTSE 024	24
xx.xxSI1-24	29.01-29.99	70	73	22	3	BTSE 024	24
xx.xxSI1-26	30.00-31.99	75	78	24	3	BTSE 026	26
xx.xxSI1-28	32.00-33.99	75	78	26	3	BTSE 028	28
xx.xxSI1-30	34.00-36.99	90	93	27	3	BTSE 030	30
xx.xxSI1-33	37.00-39.99	95	98	30	3	BTSE 033	33
xx.xxSI1-36	40.00-43.99	100	104	33	4	BTSE 036	36
xx.xxSI1-39	44.00-46.99	105	109	37	4	BTSE 039	39
xx.xxSI1-43	47.00-51.99	105	109	41	4	BTSE 043	43
xx.xxSI1-47	52.00-56.99	110	114	44	4	BTSE 047	47
xx.xxSI1-51	57.00-60.99	115	120	49	5	BTSE 051	51
xx.xxSI1-56	61.00-65.00	115	120	53	5	BTSE 056	56
xx.xxSI1-56	65.01-67.99	104	112	53	8	BTSE 056	56
xx.xxSI1-62	68.00-74.99	104	113	59	9	BTSE 062	62
xx.xxSI1-68	75.00-80.99	134	143	65	9	BTSE 068	68
xx.xxSI1-75	81.00-89.00	134	143	71	9	BTSE 075	75

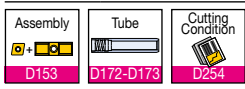

► Insert and guide pad are sold separately from drill body

TBTA-FB Series



Assembly of TBTA-FB series

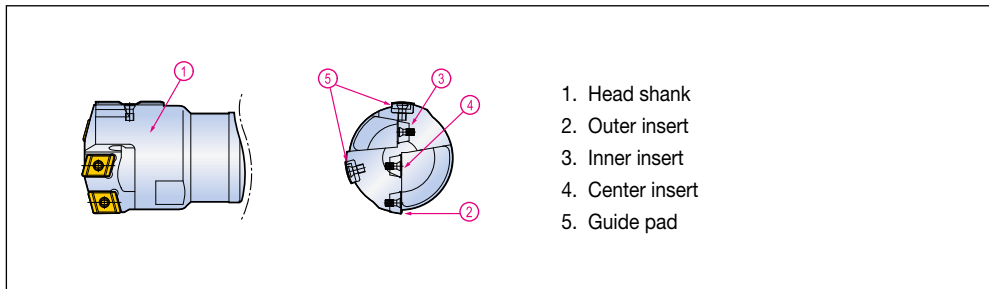

1. Head shank
2. Outer insert
3. Inner insert
4. Center insert
5. Guide pad

Parts		Diameter (mm)			
		25.00-28.00	28.01-29.99	30.00-35.00	35.01-38.00
Insert	PER	NPHT 060304R-G-P	NPHT 060304R-G-P	NPHT 080404R-G-P	NPHT 080404R-G-P
	Screw	CSTB2.2	CSTB2.2	SR 14-560-HG	SR 14-560-HG
	Wrench	T-7F	T-7F	T-8F	T-8F
	INT	NPMT 060304R-G-I	NPMT 060304R-G-I	NPMT 070404R-G-I	NPMT 070404R-G-I
	Screw	CSTB2.2	CSTB2.2	SR 14-560-HG	SR 14-560-HG
	Wrench	T-7F	T-7F	T-8F	T-8F
	CEN	NPMT 060308L-G-C	NPMT 070408L-G-C	NPMT 070408L-G-C	NPMT 080480L-G-C
	Screw	CSTB2.2	SR 14-560-HG	SR 14-560-HG	SR 14-560-HG
Pad	Wrench	T-7F	T-8F	T-8F	T-8F
		Wrench	T-7F	T-7F	T-9F
	PAD	PAD-GP06-20-120-DC-SB	PAD-GP06-20-120-DC-SB	PAD-GP07-20-120-DC-SB	PAD-GP07-20-120-DC-SB
		PAD-GP06-20-120-DC-SC	PAD-GP06-20-120-DC-SC	PAD-GP07-20-120-DC-SC	PAD-GP07-20-120-DC-SC
	Screw	CSTB2.2S	CSTB2.2S	CSTB3S	CSTB3S

Parts		Diameter (mm)			
		38.01-39.00	39.01-41.00	41.01-44.00	44.01-45.00
Insert	PER	NPHT 090404R-G-P	NPHT 090404R-G-P	NPHT 090404R-G-P	NPHT 090404R-G-P
	Screw	SR 14-560-HG	SR 14-560-HG	SR 14-560-HG	SR 14-560-HG
	Wrench	T-8F	T-8F	T-8F	T-8F
	INT	NPMT 070404R-G-I	NPMT 070404R-G-I	NPMT 080404R-G-I	NPMT 080404R-G-I
	Screw	SR 14-560-HG	SR 14-560-HG	SR 14-560-HG	SR 14-560-HG
	Wrench	T-8F	T-8F	T-8F	T-8F
	CEN	NPMT 080408L-G-C	NPMT 080408L-G-C	NPMT 080408L-G-C	NPMT 100408L-G-C
	Screw	SR 14-560-HG	SR 14-560-HG	SR 14-560-HG	SR 14-560-HG
Pad	Wrench	T-8F	T-8F	T-8F	T-8F
		Wrench	T-9F	T-9F	T-9F
	PAD	PAD-GP07-20-120-DC-SB	PAD-GP08-25-155-DC-SB	PAD-GP08-25-155-DC-SB	PAD-GP08-25-155-DC-SB
		PAD-GP07-20-120-DC-SC	PAD-GP08-25-155-DC-SC	PAD-GP08-25-155-DC-SC	PAD-GP08-25-155-DC-SC
	Screw	CSTB3S	CSTB3S	CSTB3S	CSTB3S

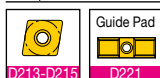

▶ Insert and guide pad are sold separately from drill body

Assembly of TBTA-FB series

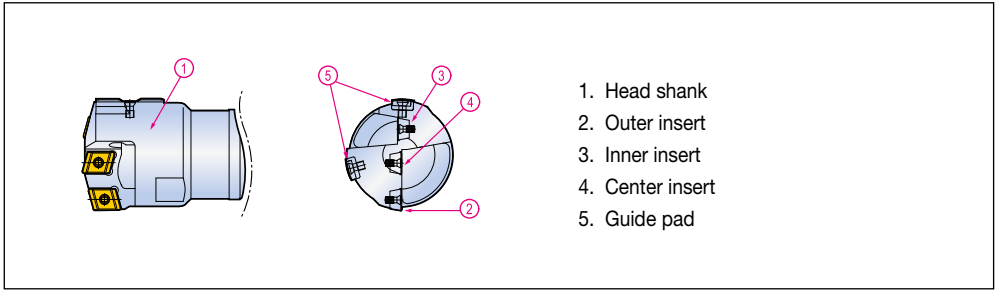

1. Head shank
2. Outer insert
3. Inner insert
4. Center insert
5. Guide pad

Parts		Diameter (mm)			
		45.01-47.00	47.01-51.00	51.01-54.00	54.01-57.00
Insert	PER	NPHT 090404R-G-P	NPHT 110404R-G-P	NPHT 110404R-G-P	NPHT 110404R-G-P
	Screw	SR 14-560-HG	SR 14-560-HG	SR 14-560-HG	SR 14-560-HG
	Wrench	T-8F	T-8F	T-8F	T-8F
	INT	NPMT 080404R-G-I	NPMT 080404R-G-I	NPMT 100404R-G-I	NPMT 100404R-G-I
	Screw	SR 14-560-HG	SR 14-560-HG	SR 14-560-HG	SR 14-560-HG
	Wrench	T-8F	T-8F	T-8F	T-8F
	CEN	NPMT 100408L-G-C	NPMT 100408L-G-C	NPMT 100408L-G-C	NPMT 130408L-G-C
	Screw	SR 14-560-HG	SR 14-560-HG	SR 14-560-HG	SR 14-560-HG
	Wrench	T-8F	T-8F	T-8F	T-8F
Pad	PAD	PAD-GP10-30-200-DC-SB	PAD-GP10-30-200-DC-SB	PAD-GP10-30-200-DC-SB	PAD-GP10-30-200-DC-SB
		PAD-GP10-30-200-DC-SC	PAD-GP10-30-200-DC-SC	PAD-GP10-30-200-DC-SC	PAD-GP10-30-200-DC-SC
	Screw	CSTB3.5	CSTB3.5	CSTB3.5	CSTB3.5
	Wrench	T-15F	T-15F	T-15F	T-15F

Parts		Diameter (mm)		
		57.01-60.00	60.01-64.00	64.01-65.00
Insert	PER	NPHT 110404R-G-P	NPHT 130404R-G-P	NPHT 130404R-G-P
	Screw	SR 14-560-HG	SR 14-560-HG	SR 14-560-HG
	Wrench	T-8F	T-8F	T-8F
	INT	NPMT 100404R-G-I	NPMT 100404R-G-I	NPMT 130404R-G-I
	Screw	SR 14-560-HG	SR 14-560-HG	SR 14-560-HG
	Wrench	T-8F	T-8F	T-8F
	CEN	NPMT 130408L-G-C	NPMT 130408L-G-C	NPMT 130408L-G-C
	Screw	SR 14-560-HG	SR 14-560-HG	SR 14-560-HG
	Wrench	T-8F	T-8F	T-8F
Pad	PAD	PAD-GP12-35-250-DC-SB	PAD-GP12-35-250-DC-SB	PAD-GP12-35-250-DC-SB
		PAD-GP12-35-250-DC-SC	PAD-GP12-35-250-DC-SC	PAD-GP12-35-250-DC-SC
	Screw	CSTB3.5	CSTB3.5	CSTB3.5
	Wrench	T-15F	T-15F	T-15F

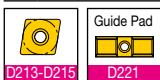

▶ Insert and guide pad are sold separately from drill body

TBTA-FB Series



Assembly of TBTA-FB series

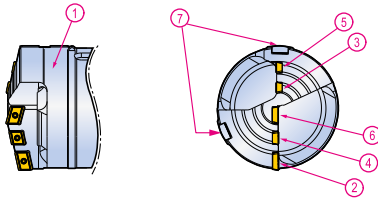

- | | |
|-------------------|-------------------|
| 1. Head shank | 5. Inner insert 3 |
| 2. Outer insert | 6. Center insert |
| 3. Inner insert 1 | 7. Guide pad |
| 4. Inner insert 2 | |

Parts	Diameter (mm)		
	65.01-71.00	71.01-83.00	83.01-89.00
PER	NPHT 110404R-G-P	NPHT 130404R-G-P	NPHT 130404R-G-P
Screw	SR 14-560-HG	SR 14-560-HG	SR 14-560-HG
Wrench	T-8F	T-8F	T-8F
INT	NPMT 080404R-G-I	NPMT 080404R-G-I	NPMT 080404R-G-I
Screw	SR 14-560-HG	SR 14-560-HG	SR 14-560-HG
Wrench	T-8F	T-8F	T-8F
INT2	NPMT 080404R-G-I	NPMT 080404R-G-I	NPMT 100404R-G-I
Screw	SR 14-560-HG	SR 14-560-HG	SR 14-560-HG
Wrench	T-8F	T-8F	T-8F
INT3	NPMT 070404R-G-I	NPMT 080404R-G-I	NPMT 080404R-G-I
Screw	SR 14-560-HG	SR 14-560-HG	SR 14-560-HG
Wrench	T-8F	T-8F	T-8F
CEN	NPMT 100408L-G-C	NPMT 100408L-G-C	NPMT 130408L-G-C
Screw	SR 14-560-HG	SR 14-560-HG	SR 14-560-HG
Wrench	T-8F	T-8F	T-8F
PAD	PAD-GP12-35-250-DC-SB	PAD-GP12-35-250-DC-SB	PAD-GP12-35-250-DC-SB
	PAD-GP12-35-250-DC-SC	PAD-GP12-35-250-DC-SC	PAD-GP12-35-250-DC-SC
Screw	CSTB3.5	CSTB3.5	CSTB3.5
Wrench	T-15F	T-15F	T-15F



▶ Insert and guide pad are sold separately from drill body

TBTA-R...SE4



Single tube system

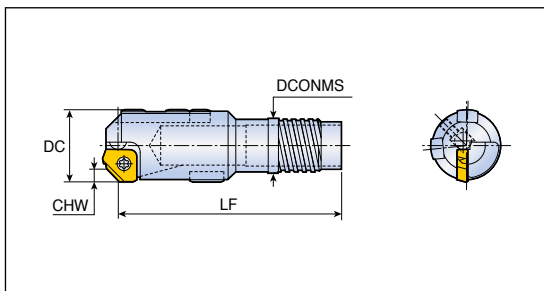

- Outer four start thread

Designation	DC	CHW	Dimension (mm)		Tube	
			LF	DCONMS	Part	Diameter (mm)
TBTA-R xxx.xxSE4-22	25.00-26.40	2.8	72.5	19.5	BTSI 022	22
xxx.xxSE4-24	26.41-28.70	2.8	72.5	21.0	BTSI 024	24
xxx.xxSE4-26	28.71-31.00	2.8	72.5	23.5	BTSI 026	26
xxx.xxSE4-28	31.01-33.30	2.8	75.5	25.5	BTSI 028	28
xxx.xxSE4-30	33.31-36.20	2.8	75.5	28.0	BTSI 030	30
xxx.xxSE4-33	36.21-39.60	2.8	90.5	30.0	BTSI 033	33
xxx.xxSE4-36	39.61-39.99	2.8	90.5	33.0	BTSI 036	36

Assembly 	Tube 	Cutting Condition
D159	D170-D171	D252

Single tube system

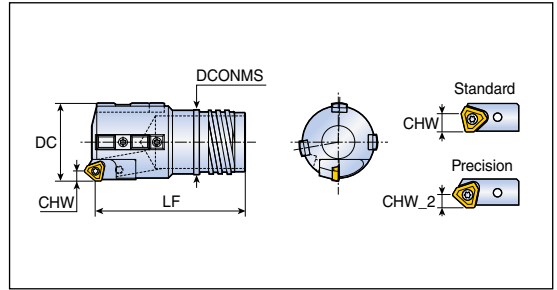

- Outer four start thread

Designation	DC	CHW (mm)		Dimension (mm)		Tube	
		Standard	Precision	LF	DCONMS	Part	Diameter (mm)
TBTA-R xxx.xxSE4-36	40.00-43.00	6.4	4	90	33.0	BTSI 036	36
xxx.xxSE4-39	43.01-47.00	6.4	4	95	36.0	BTSI 039	39
xxx.xxSE4-43	47.01-51.70	6.4	4	95	39.0	BTSI 043	43
xxx.xxSE4-47	51.71-56.20	6.4/7.2	4/4.8	100	43.0	BTSI 047	47
xxx.xxSE4-51	56.21-60.60	7.2	4.8	110	47.0	BTSI 051	51
xxx.xxSE4-56A	60.61-65.00	7.2	4.8	110	51.0	BTSI 056A	56
xxx.xxSE4-56B	65.00-66.99	7.2	4.8	150	52.0	BTSI 056B	56
xxx.xxSE4-62	67.00-72.99	10.4	6.4	150	58.0	BTSI 062	62
xxx.xxSE4-68	73.00-79.99	10.4	6.4	150	63.0	BTSI 068	68
xxx.xxSE4-75	80.00-86.99	10.4	6.4	180	70.0	BTSI 075	75
xxx.xxSE4-82	87.00-99.99	10.4	6.4	180	77.0	BTSI 082	82

 Assembly D159	 Tube D170-D171	 Cutting Condition D252
----------------------	-----------------------	-------------------------------

TBTA-R...SI1



Single tube system

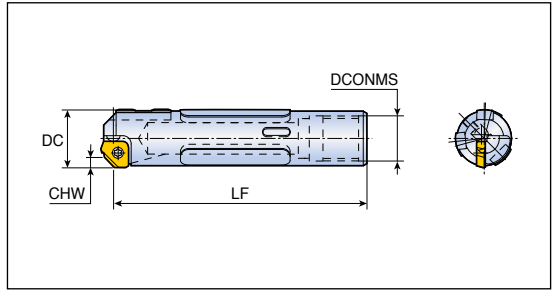

- Inner single start thread

Designation	DC	CHW (mm)	Dimension (mm)		Tube	
			LF	DCONMS	Part	Diameter (mm)
TBTA-R- xxx.xxSI1-22	25.00-26.99	2.8	110.5	20	BTSE 022	22
xxx.xxSI1-24	27.00-29.99	2.8	110.5	22	BTSE 024	24
xxx.xxSI1-26	30.00-31.99	2.8	110.5	24	BTSE 026	26
xxx.xxSI1-28	32.00-33.99	2.8	110.5	26	BTSE 028	28
xxx.xxSI1-30	34.00-36.99	2.8	135.5	27	BTSE 030	30
xxx.xxSI1-33	37.00-39.99	2.8	135.5	30	BTSE 033	33

TBTA-R...SI1



Single tube system

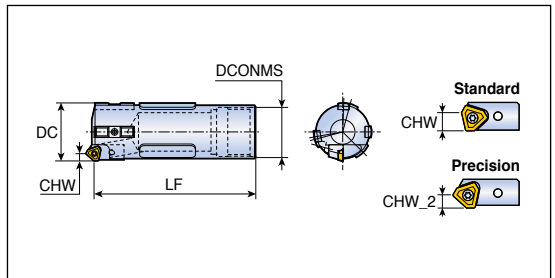

- Inner single start thread

Designation	DC	CHW (mm)		Dimension (mm)		Tube	
		Standard	Precision	LF	DCONMS	Part	Diameter (mm)
TBTA-R- xxx.xxSI1-36	40.00-43.99	6.4	4	135	33	BTSE 036	36
xxx.xxSI1-39	44.00-46.99	6.4	4	135	37	BTSE 039	39
xxx.xxSI1-43	47.00-51.99	6.4	4	145	41	BTSE 043	43
xxx.xxSI1-47	52.00-56.99	7.2	4.8	145	44	BTSE 047	47
xxx.xxSI1-51	57.00-60.99	7.2	4.8	170	49	BTSE 051	51
xxx.xxSI1-56	61.00-67.99	7.2/10.4	4.8/6.4	170	53	BTSE 056	56
xxx.xxSI1-62	68.00-74.99	10.4	6.4	170	59	BTSE 062	62
xxx.xxSI1-68	75.00-80.99	10.4	6.4	205	65	BTSE 068	68
xxx.xxSI1-75	81.00-90.99	10.4	6.4	215	71	BTSE 075	75
xxx.xxSI1-82	91.00-98.99	10.4	6.4	225	79	BTSE 082	82
xxx.xxSI1-94	99.00-110.99	10.4	6.4	235	90	BTSE 094	94

Assembly	Tube	Cutting Condition
D159	D172-D173	D252

TBTA-R Series



Assembly of TBTA-R series

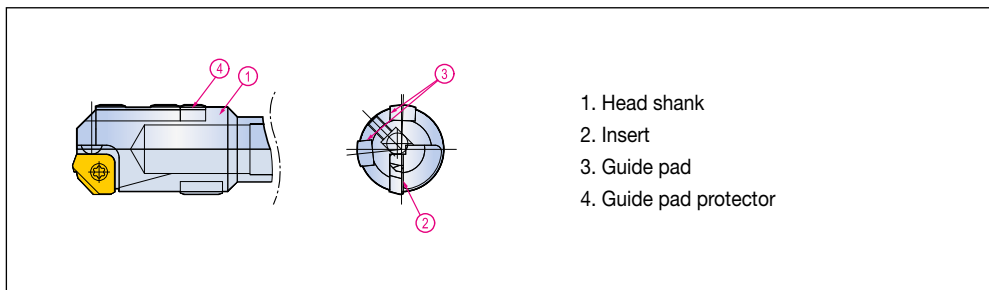

1. Head shank
2. Insert
3. Guide pad
4. Guide pad protector

Parts		Diameter (mm)					
		25.00-27.99	28.00-29.99	30.00-37.99	38.00-39.99		
Close tolerance	Cartridge	Adjust ball	BALL5	BALL5	BALL5	BALL5	
		Adjust screw	AS0005-5	AS0005-5	AS0005-5	AS0005-5	
		Wrench	H2.5	H2.5	H2.5	H2.5	
	Insert	Screw	-	-	-	-	
		Wrench	-	-	-	-	
		Insert	XPMT 16002-45	XPMT 16002-45	XPMT 16002-45	XPMT 16002-45	
Normal tolerance	Cartridge	Screw	CSTANO3	CSTANO3	CSTANO3	CSTANO3	
		Wrench	T-9D	T-9D	T-9D	T-9D	
		Outer	-	-	-	-	
		Adjust screw	-	-	-	-	
		Wrench	-	-	-	-	
		Screw	-	-	-	-	
	Insert	Wrench	-	-	-	-	
		Insert	XPMT 16002-45	XPMT 16002-45	XPMT 16002-45	XPMT 16002-45	
		Screw	CSTANO3	CSTANO3	CSTANO3	CSTANO3	
		Wrench	T-9D	T-9D	T-9D	T-9D	
		Pad	Guide pad (A)	PAD-GP06-20-120-DC-SB	PAD-GP06-20-120-DC-SB	PAD-GP07-20-120-DC-SB	PAD-GP08-25-155-DC-SB
				PAD-GP06-20-120-DC-SC	PAD-GP06-20-120-DC-SC	PAD-GP07-20-120-DC-SC	PAD-GP08-25-155-DC-SC
Screw	CSTB2.2S		CSTB2.2S	CSTB3S	CSTB3S		
Wrench	T-9D		T-9D	T-9D	T-9D		
Guide pad protector (B)	-		-	-	PAD-P08		
	Screw		-	-	-	CSTB3S	
Wrench	-	-	-	T-9D			
Resin guide pad (C)	PAD-R10	PAD-R10	PAD-R12	PAD-R15			
	Screw	LS0902, 5-6	LS0902, 5-6	LS0903-8	LS0904-10		
Wrench	-	-	H2	H2.5			



- ▶ A+B is for outer four start thread connection type
- ▶ A+C is for inner single start thread connection type

Assembly of TBTA-R series

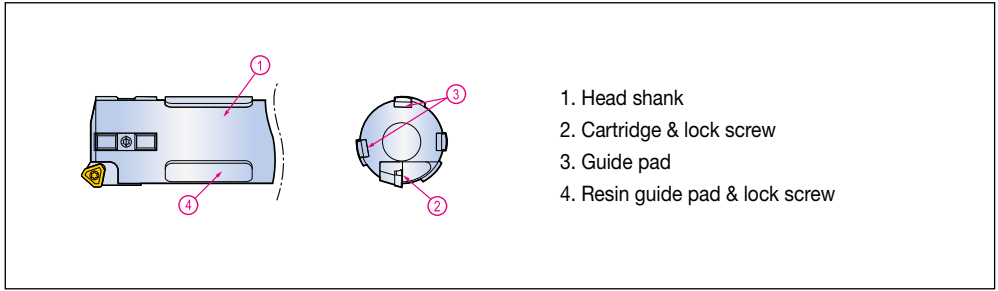

1. Head shank
2. Cartridge & lock screw
3. Guide pad
4. Resin guide pad & lock screw

Parts		Diameter (mm)				
		40.00-45.99	46.00-51.99	52.00-56.99	57.00-59.99	
Close tolerance	Cartridge	Outer	PERC-P 04R	PERC-P 04R	PERC-P 32R	PERC-P 32R
		Adjust screw	AS0004-8	AS0004-8	AS0005-10	AS0005-10
		Wrench	H2	H2	H2.5	H2.5
	Insert	Screw	LS1803.5RH	LS1803.5RH	LS1805RH	LS1805RH
		Wrench	H2.5	H2.5	H3	H3
		Insert	TPMX 1403LG	TPMX 1403LG	TPMX 1704LG	TPMX 1704LG
		Screw	CSTB2.5	CSTB2.5	CSTB3.5D	CSTB3.5D
Wrench	T-8D	T-8D	T-8D	T-8D		
Normal tolerance	Cartridge	Outer	PERC 402-04	PERC 402-04	PERC 402-32	PERC 402-32
		Adjust screw	AS0004-8	AS0004-8	AS0005-10	AS0005-10
		Wrench	H2	H2	H2.5	H2.5
	Insert	Screw	LS1803.5RH	LS1803.5RH	LS1805RH	LS1805RH
		Wrench	H2.5	H2.5	H3	H3
		Insert	TPMX 140308R-G	TPMX 140308R-G	TPMX 170408R-G	TPMX 170408R-G
		Screw	CSTB2.5	CSTB2.5	CSTB3.5D	CSTB3.5D
	Wrench	T-8D	T-8D	T-8D	T-8D	
	Pad	Guide pad (A)	PAD-GP08-25-155-DC-SB	PAD-GP10-35-200-DC-SB	PAD-GP10-35-200-DC-SB	PAD-GP10-35-200-DC-SB
			PAD-GP08-25-155-DC-SC	PAD-GP10-35-200-DC-SC	PAD-GP10-35-200-DC-SC	PAD-GP10-35-200-DC-SC
Screw		CSTB3S	CSTB4S	CSTB4S	CSTB4S	
Wrench		T-9D	T-15D	T-15D	T-15D	
Guide pad protector (B)		PAD-P08	PAD-P10	PAD-P10	PAD-P14	
		Screw	CSTB3S	CSTB4S	CSTB4S	CSTB4S
Wrench		T-9D	T-15D	T-15D	T-15D	
Resin guide pad (C)		PAD-R15	PAD-R15	PAD-R15	PAD-R20	
		Screw	LS0904-10	LS0904-10	LS0904-10	LS0905-12
Wrench		H2.5	H2.5	H2.5	H3	



- ▶ A+B is for outer four start thread connection type
- ▶ A+C is for inner single start thread connection type

TBTA-R Series



Assembly of TBTA-R series

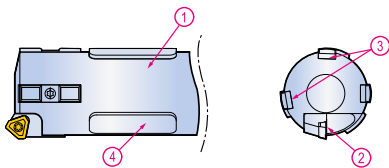

1. Head shank
2. Cartridge & lock screw
3. Guide pad
4. Resin guide pad & lock screw

Parts		Diameter (mm)			
		60.00-66.99	67.00-99.99	100.00-122.99	
Close tolerance	Cartridge	Outer	PERC-P 32R	PERC-P 43R	PERC-P 43R
		Adjust screw	AS0005-10	AS0005-15	AS0005-15
		Wrench	H2.5	H2.5	H2.5
	Insert	Screw	LS1805RH	LS1806RH	LS1806RH
		Wrench	H3	H4	H4
		Insert	TPMX 1704LG	TPMX 2405LG	TPMX 2405LG
Normal tolerance	Cartridge	Screw	CSTB3.5D	CSTB4M	CSTB4M
		Wrench	T-8D	T-15D	T-15D
		Outer	PERC 402-32	PERC 402-43	PERC 402-43
	Cartridge	Adjust screw	AS0005-10	AS0005-15	AS0005-15
		Wrench	H2.5	H2.5	H2.5
		Screw	LS1805RH	LS1806RH	LS1806RH
	Insert	Wrench	H3	H4	H4
		Insert	TPMX 170408R-G	TPMX 240512R-G	TPMX 240512R-G
		Screw	CSTB3.5D	CSTB4M	CSTB4M
	Wrench	T-8D	T-15D	T-15D	
	Pad	Guide pad (A)	PAD-GP14-40-250-DC-SB	PAD-GP14-40-250-DC-SB	PAD-GP18-40-300-DC-SB
			PAD-GP14-40-250-DC-SC	PAD-GP14-40-250-DC-SC	PAD-GP18-40-300-DC-SC
Screw		CSTA5S	CSTA5S	LS1206S	
Wrench		T-15D	T-15D	H3	
Guide pad protector (B)		PAD-P14	PAD-P14	PAD-P18	
		Screw	CSTA5S	CSTA5S	LS1206S
Wrench		T-15D	T-15D	H3	
Resin guide pad (C)		PAD-R20	PAD-R35	PAD-R35	
		Screw	LS0905-12	LS0906-15	LS0906-15
Wrench		H3	H4	H4	



- ▶ A+B is for outer four start thread connection type
- ▶ A+C is for inner single start thread connection type

TBTA-TR...SE4



Single tube system

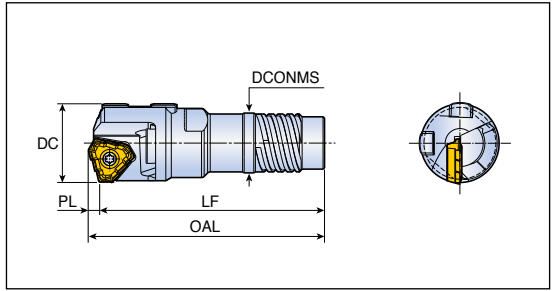

- Outer four start thread

Designation	DC	Dimension (mm)				Tube	
		LF	OAL	DCONMS	PL	Part	Diameter (mm)
TBTA-TRxx.xxSE4-14	16.00-16.70	55.0	57.2	12.6	2.2	BTSI 014	14
TRxx.xxSE4-15	16.71-17.70	55.0	57.2	13.6	2.2	BTSI 015	15
TRxx.xxSE4-16	17.71-18.90	56.0	59.0	14.5	3.0	BTSI 016	16
TRxx.xxSE4-17	18.91-20.00	56.0	59.0	15.5	3.0	BTSI 017	17
TRxx.xxSE4-18	20.01-21.80	60.0	63.2	16.0	3.2	BTSI 018	18
TRxx.xxSE4-20	21.81-21.99	63.5	66.7	18.0	3.2	BTSI 020	20
TRxx.xxSE4-20	22.00-24.10	65.5	68.9	18.0	3.4	BTSI 020	20
TRxx.xxSE4-22	24.11-26.40	65.5	69.1	19.5	3.6	BTSI 022	22
TRxx.xxSE4-24	26.41-28.00	65.6	69.1	21.0	3.6	BTSI 024	24
TRxx.xxSE4-24	28.01-28.70	70.0	74.6	21.0	4.6	BTSI 024	24
TRxx.xxSE4-26	28.71-29.99	75.0	79.6	23.5	4.6	BTSI 026	26
TRxx.xxSE4-26	30.00-31.00	75.0	79.6	23.5	4.6	BTSI 026	26
TRxx.xxSE4-28	31.01-32.00	75.0	79.6	25.5	4.6	BTSI 028	28
TRxx.xxSE4-28	32.01-33.30	74.5	79.9	25.5	5.4	BTSI 028	28
TRxx.xxSE4-30	33.31-36.20	79.5	84.9	28.0	5.4	BTSI 030	30
TRxx.xxSE4-33	36.21-39.00	89.5	94.9	30.0	5.4	BTSI 033	33
TRxx.xxSE4-33	39.01-39.60	89.5	94.9	30.0	5.4	BTSI 033	33
TRxx.xxSE4-36	39.61-40.00	94.5	99.9	33.0	5.4	BTSI 036	36

Assembly: Tube: Cutting Condition:

D165 D170 D260

► Insert and guide pad are sold separately from drill body

TBTA-TR...SI1



Single tube system

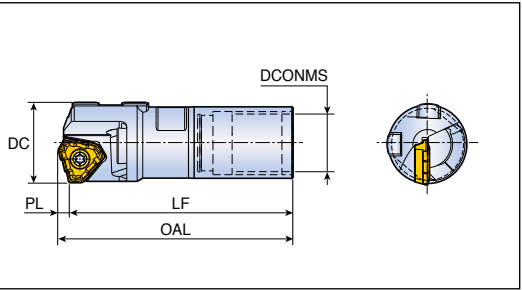

- Inner single start thread

Designation	DC	Dimension (mm)				Tube	
		LF	OAL	DCONMS	PL	Part	Diameter (mm)
TBTA- TR16.00SI1-13A	16.00	53.5	55.7	10.8	2.2	BTSE 013A	13
TRxx.xxSI1-13B	16.01-16.50	53.5	55.7	11.1	2.2	BTSE 013B	13
TRxx.xxSI1-14A	16.51-17.25	53.5	55.7	11.8	2.2	BTSE 014A	14
TRxx.xxSI1-14B	17.26-18.00	53.5	55.7	12.1	2.2	BTSE 014B	14
TRxx.xxSI1-15	18.01-19.00	53.5	56.5	12.8	3.0	BTSE 015	15
TRxx.xxSI1-16.5	19.01-19.99	53.5	56.7	13.8	3.2	BTSE 016.5	16.5
TRxx.xxSI1-18	20.00-21.99	58.0	61.2	14.5	3.2	BTSE 018	18
TRxx.xxSI1-20	22.00-24.99	60.0	63.4	16.0	3.4	BTSE 020	20
TRxx.xxSI1-22	25.00	60.0	63.5	17.0	3.5	BTSE 022	22
TRxx.xxSI1-22	25.01-26.99	65.0	68.5	17.0	3.5	BTSE 022	22
TRxx.xxSI1-24	27.00-28.00	65.0	68.5	19.0	3.5	BTSE 024	24
TRxx.xxSI1-24	28.01-29.99	70.0	74.6	22.0	4.6	BTSE 024	24
TRxx.xxSI1-26	30.00-31.99	75.0	79.6	24.0	4.6	BTSE 026	26
TRxx.xxSI1-28	32.00	75.0	79.6	26.0	4.6	BTSE 028	28
TRxx.xxSI1-28	32.01-33.99	74.5	79.9	26.0	5.4	BTSE 028	28
TRxx.xxSI1-30	34.00-36.99	89.5	94.9	27.0	5.4	BTSE 030	30
TRxx.xxSI1-33	37.00-39.00	94.5	99.9	30.0	5.4	BTSE 033	33
TRxx.xxSI1-33	39.01-39.99	94.5	99.9	30.0	5.4	BTSE 033	33
TRxx.xxSI1-36	40.00	99.5	104.9	33.0	5.4	BTSE 036	36

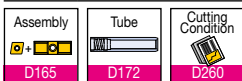

► Insert and guide pad are sold separately from drill body

TBTA-TR Series



Assembly of TBTA-TR series

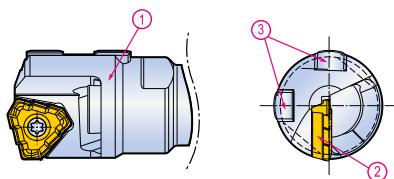

1. Head shank
2. Insert
3. Guide pad

Parts		Diameter (mm)		
		16.00-18.00	18.01-20.00	20.01-21.00
Insert	Insert	TOGT 080305 RS	TOGT 090305 RS	TOGT 100305 RS
	Screw	CSTB2.5S	CSTB2.5S*	CSTB3S*
	Wrench	T-8F	T-8F	T-9F
Guide Pad	Guide Pad	PAD-GP06-20-075-DC-SB	PAD-GP06-20-085-DC-SB	PAD-GP06-20-085-DC-SB
		PAD-GP06-20-075-DC-SC	PAD-GP06-20-085-DC-SC	PAD-GP06-20-085-DC-SC
	Screw	CSTB2.2S	CSTB2.2S*	CSTB2.2S*
	Wrench	T-7F	T-7F	T-7F

Parts		Diameter (mm)		
		21.01-21.99	22.00-25.00	25.01-28.00
Insert	Insert	TOGT 100305 RS	TOGT 110405 RS	TOGT 120405 RS
	Screw	CSTB3S*	SR14-571/S	CSTB4S
	Wrench	T-9F	T-10/5	T-15F
Guide Pad	Guide Pad	PAD-GP06-20-100-DC-SB	PAD-GP06-20-100-DC-SB	PAD-GP06-20-120-DC-SB
		PAD-GP06-20-100-DC-SC	PAD-GP06-20-100-DC-SC	PAD-GP06-20-120-DC-SC
	Screw	CSTB2.2S*	CSTB2.2S*	CSTB2.2S*
	Wrench	T-7F	T-7F	T-7F

Parts		Diameter (mm)			
		28.01-29.99	30.00-32.00	32.01-39.00	39.01-40.00
Insert	Insert	TOGT 130408 RS	TOGT 130408 RS	TOGT 140510 RS	TOGT 140510 RS
	Screw	SR 16-212/L10	SR 16-212/L10	SR 16-212/L10	SR 16-212/L10
	Wrench	T-20/5	T-20/5	T-20/5	T-20/5
Guide Pad	Guide Pad	PAD-GP06-20-120-DC-SB	PAD-GP07-20-120-DC-SB	PAD-GP07-20-120-DC-SB	PAD-GP08-25-155-DC-SB
		PAD-GP06-20-120-DC-SC	PAD-GP07-20-120-DC-SC	PAD-GP07-20-120-DC-SC	PAD-GP08-25-155-DC-SC
	Screw	CSTB2.2	CSTB3S	CSTB3S	CSTB3S
	Wrench	T-7F	T-9F	T-9F	T-9F



► Insert and guide pad are sold separately from drill body.

Single tube system



Ø12.60 - Ø15.59

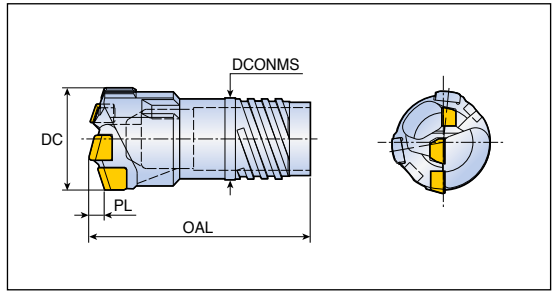

- Outer four start thread

Designation	DC	Dimension (mm)			Tube	
		OAL	PL	DCONMS	Part	Diameter (mm)
BTA xxx.xx SE2-11*	12.60-13.10	43.0	1.1	9.6	BTSI011	11
xxx.xx SE2-11*	13.11-13.60	43.0	1.1	9.6	BTSI011	11
xxx.xx SE2-12*	13.61-14.10	43.0	1.2	10.6	BTSI012	12
xxx.xx SE2-12*	14.11-14.60	43.0	1.2	10.6	BTSI012	12
xxx.xx SE2-13*	14.61-15.10	43.0	1.3	11.6	BTSI013	13
xxx.xx SE2-13*	15.11-15.59	43.0	1.3	11.6	BTSI013	13
xxx.xx SE4-14	15.60-16.20	43.0	2.7	12.6	BTSI014	14
xxx.xx SE4-14	16.21-16.70	43.0	2.7	12.6	BTSI014	14
xxx.xx SE4-15	16.71-17.20	43.0	2.7	13.6	BTSI015	15
xxx.xx SE4-15	17.21-17.70	43.0	2.7	13.6	BTSI015	15
xxx.xx SE4-16	17.71-18.40	47.0	2.8	14.5	BTSI016	16
xxx.xx SE4-16	18.41-18.90	47.0	2.9	14.5	BTSI016	16
xxx.xx SE4-17	18.91-19.20	47.0	2.9	15.5	BTSI017	17
xxx.xx SE4-17	19.21-20.00	47.0	2.9	15.5	BTSI017	17
xxx.xx SE4-18	20.01-20.90	52.5	3.2	16.0	BTSI018	18
xxx.xx SE4-18	20.91-21.80	52.5	3.2	16.0	BTSI018	18
xxx.xx SE4-20	21.81-22.90	56.0	3.2	18.0	BTSI020	20
xxx.xx SE4-20	22.91-24.10	56.0	3.2	18.0	BTSI020	20
xxx.xx SE4-22	24.11-25.20	57.5	3.5	19.5	BTSI022	22
xxx.xx SE4-22	25.21-26.40	57.5	3.5	19.5	BTSI022	22
xxx.xx SE4-24	26.41-27.50	57.5	3.7	21.0	BTSI024	24
xxx.xx SE4-24	27.51-28.70	57.5	3.7	21.0	BTSI024	24
xxx.xx SE4-26	28.71-29.80	63.5	4.0	23.5	BTSI026	26
xxx.xx SE4-26	29.81-31.00	63.5	4.0	23.5	BTSI026	26
xxx.xx SE4-28	31.01-32.10	63.5	4.3	25.5	BTSI028	28
xxx.xx SE4-28	32.11-33.30	63.5	4.3	25.5	BTSI028	28
xxx.xx SE4-30	33.31-34.80	63.5	4.5	28.0	BTSI030	30
xxx.xx SE4-30	34.81-36.20	63.5	4.5	28.0	BTSI030	30
xxx.xx SE4-33	36.21-37.30	73.5	4.8	30.0	BTSI033	33
xxx.xx SE4-33	37.31-38.40	73.5	4.8	30.0	BTSI033	33
xxx.xx SE4-33	38.41-39.60	73.5	4.8	30.0	BTSI033	33
xxx.xx SE4-36	39.61-40.60	73.5	5.6	33.0	BTSI036	36
xxx.xx SE4-36	40.61-41.80	73.5	5.6	33.0	BTSI036	36
xxx.xx SE4-36	41.81-43.00	73.5	5.6	33.0	BTSI036	36
xxx.xx SE4-39	43.01-44.30	75.0	5.4	36.0	BTSI039	39

► *: 2 cutting edge head, 2 start thread

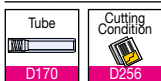

Double tube system

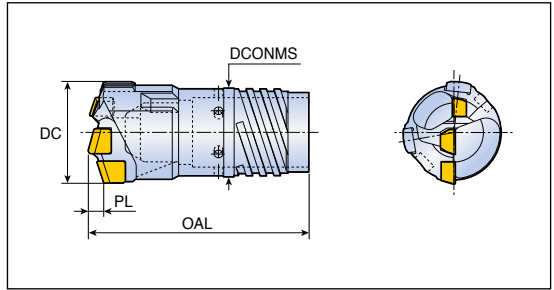

- Outer four start thread

Designation	DC	Dimension (mm)			Tube		
		OAL	PL	DCONMS	Outer tube	Inner tube	Diameter (mm)
BTA xxx.xx DE4-18	18.41-19.20	50.0	2.9	16.0	BTDO018	BTDI012	18.0
xxx.xx DE4-18	19.21-20.00	50.0	2.9	16.0	BTDO018	BTDI012	18.0
xxx.xx DE4-19.5	20.01-20.90	56.0	3.2	18.0	BTDO019.5	BTDI014	19.5
xxx.xx DE4-19.5	20.91-21.80	56.0	3.2	18.0	BTDO019.5	BTDI014	19.5
xxx.xx DE4-21.5	21.81-22.90	56.0	3.2	19.5	BTDO021.5	BTDI015	21.5
xxx.xx DE4-21.5	22.91-24.10	56.0	3.2	19.5	BTDO021.5	BTDI015	21.5
xxx.xx DE4-23.5	24.11-25.20	57.5	3.5	21.0	BTDO023.5	BTDI016	23.5
xxx.xx DE4-23.5	25.21-26.40	57.5	3.5	21.0	BTDO023.5	BTDI016	23.5
xxx.xx DE4-26	26.41-27.50	60.5	3.7	23.5	BTDO026	BTDI018	26.0
xxx.xx DE4-26	27.51-28.70	60.5	3.7	23.5	BTDO026	BTDI018	26.0
xxx.xx DE4-28	28.71-29.80	63.5	4.0	25.5	BTDO028	BTDI020	28.0
xxx.xx DE4-28	29.81-31.00	63.5	4.0	25.5	BTDO028	BTDI020	28.0
xxx.xx DE4-30.5	31.01-32.10	63.5	4.1	28.0	BTDO030.5	BTDI022	30.5
xxx.xx DE4-30.5	32.11-33.30	63.5	4.1	28.0	BTDO030.5	BTDI022	30.5
xxx.xx DE4-33	33.31-34.80	70.5	4.5	30.0	BTDO033.0	BTDI024	33.0
xxx.xx DE4-33	34.81-36.20	70.5	4.5	30.0	BTDO033.0	BTDI024	33.0
xxx.xx DE4-35.5	36.21-37.30	73.5	4.8	33.0	BTDO035.5	BTDI026	35.5
xxx.xx DE4-35.5	37.31-38.40	73.5	4.8	33.0	BTDO035.5	BTDI026	35.5
xxx.xx DE4-35.5	38.41-39.60	73.5	4.8	33.0	BTDO035.5	BTDI026	35.5
xxx.xx DE4-39	39.61-40.60	73.5	5.3	36.0	BTDO039	BTDI029	39.0
xxx.xx DE4-39	40.61-41.80	73.5	5.3	36.0	BTDO039	BTDI029	39.0
xxx.xx DE4-39	41.81-43.00	73.5	5.3	36.0	BTDO039	BTDI029	39.0
xxx.xx DE4-42.5	43.01-44.30	75.0	5.5	39.0	BTDO042.5	BTDI032	42.5
xxx.xx DE4-42.5	44.31-45.60	75.0	5.5	39.0	BTDO042.5	BTDI032	42.5
xxx.xx DE4-42.5	45.61-47.00	75.0	5.5	39.0	BTDO042.5	BTDI032	42.5
xxx.xx DE4-46.5	47.01-48.50	79.0	6.1	43.0	BTDO046.5	BTDI035	46.5
xxx.xx DE4-46.5	48.51-50.10	79.0	6.1	43.0	BTDO046.5	BTDI035	46.5
xxx.xx DE4-46.5	50.11-51.70	79.0	6.1	43.0	BTDO046.5	BTDI035	46.5
xxx.xx DE4-51	51.71-53.20	82.0	6.5	47.0	BTDO051	BTDI039	51.0
xxx.xx DE4-51	53.21-54.70	82.0	6.5	47.0	BTDO051	BTDI039	51.0
xxx.xx DE4-51	54.71-56.20	82.0	6.5	47.0	BTDO051	BTDI039	51.0
xxx.xx DE4-55.5	56.21-58.40	84.0	6.6	51.0	BTDO055.5	BTDI043A	55.5
xxx.xx DE4-55.5	58.41-60.60	84.0	6.6	51.0	BTDO055.5	BTDI043A	55.5
xxx.xx DE4-55.5	60.61-62.80	84.0	6.6	51.0	BTDO055.5	BTDI043A	55.5
xxx.xx DE4-55.5	62.81-65.00	84.0	6.6	51.0	BTDO055.5	BTDI043A	55.5

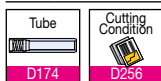

BTS...SE1



Single tube system

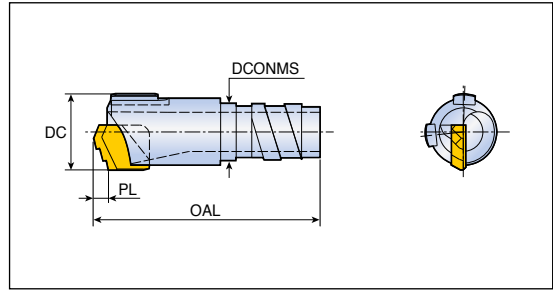

- Outer single start thread

Designation	DC	Dimension (mm)			Tube	
		OAL	PL	DCONMS	Part	Diameter (mm)
BTS xxx.xx SE1-7.1	8.00-8.99	34	2.0	6.0	BTSO071	7.1
xxx.xx SE1-8.3	9.00-9.99	34	2.0	7.2	BTSO083	8.3
xxx.xx SE1-9	10.00-10.99	34	2.2	7.6	BTSO090	9.0
xxx.xx SE1-10	11.00-11.99	34	2.2	8.6	BTSO100	10.0
xxx.xx SE1-11	12.00-13.49	34	2.3	9.1	BTSO110	11.0
xxx.xx SE1-12	13.50-14.79	34	2.4	10.8	BTSO120	12.0

BTS...SE2/SE4



Single tube system

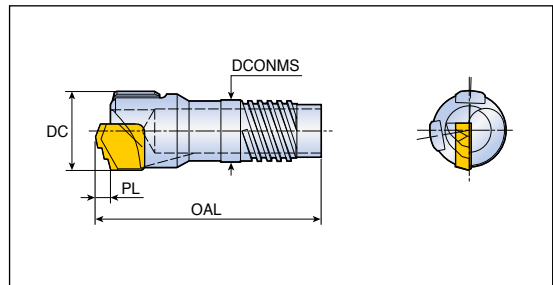

- Outer four start thread

Designation	DC	Dimension (mm)			Tube	
		OAL	PL	DCONMS	Part	Diameter (mm)
BTS xxx.xx SE2-11*	12.60-13.60	40	2.3	9.6	BTSI011	11
xxx.xx SE2-12*	13.61-14.60	40	2.4	10.6	BTSI012	12
xxx.xx SE2-13*	14.61-15.59	40	3.0	11.6	BTSI013	13
xxx.xx SE4-14	15.60-16.70	40	2.4	12.6	BTSI014	14
xxx.xx SE4-15	16.71-17.70	40	3.0	13.6	BTSI015	15
xxx.xx SE4-16	17.71-18.90	40	3.3	14.5	BTSI016	16
xxx.xx SE4-17	18.91-20.00	40	3.3	15.5	BTSI017	17



► *: Designates outer two start thread

Single tube

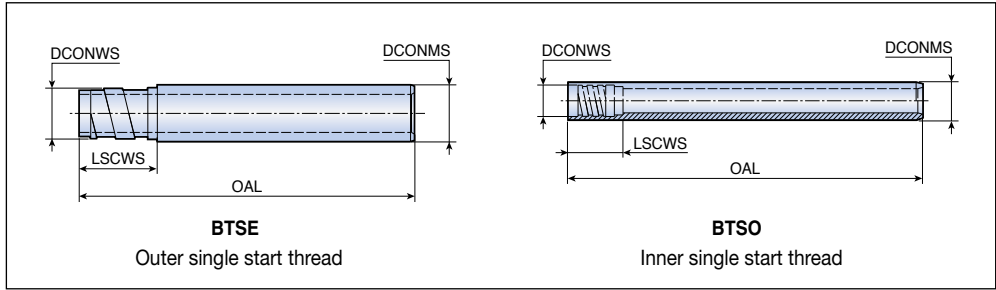

Designation	DC	Dimension (mm)			
		DCONMS	DCONWS		LSCWS
BTSE 047	52.00-56.99	47.0	44	-	41
051	57.00-60.99	51.0	49	-	41
056	61.00-67.99	56.0	53	-	41
062	68.00-74.99	62.0	59	-	41
068	75.00-80.99	68.0	65	-	71
075	81.00-90.99	75.0	71	-	71
082	91.00-98.99	82.0	79	-	71
094	99.00-110.99	94.0	90	-	71
106	111.00-122.99	106.0	102	-	71
118	123.00-134.99	118.0	114	-	71
130	135.00-148.99	130.0	126	-	71
142	149.00-161.99	142.0	139	-	71
154	162.00-173.99	154.0	151	-	86
166	174.00-185.99	166.0	163	-	86
178	186.00-197.99	178.0	175	-	86
190	198.00-209.99	190.0	187	-	86
202	210.00-221.99	202.0	199	-	86
214	222.00-233.99	214.0	211	-	86
226	234.00-245.99	226.0	223	-	86
238	246.00-257.99	238.0	235	-	86
250	258.00-269.99	250.0	247	-	121
262	270.00-281.99	262.0	259	-	121
274	282.00-293.99	274.0	271	-	121
BTSO 071	8.00-8.99	7.1	-	6.0	13.5
083	9.00-9.99	8.3	-	7.2	13.5
090	10.00-10.99	9.0	-	7.6	13.5
100	11.00-11.99	10.0	-	8.6	13.5
110	12.00-13.49	11.0	-	9.1	13.5
120	13.50-14.79	12.0	-	10.8	13.5

► Please indicate overall length (OAL) when ordering

Assembly of Double Tube System

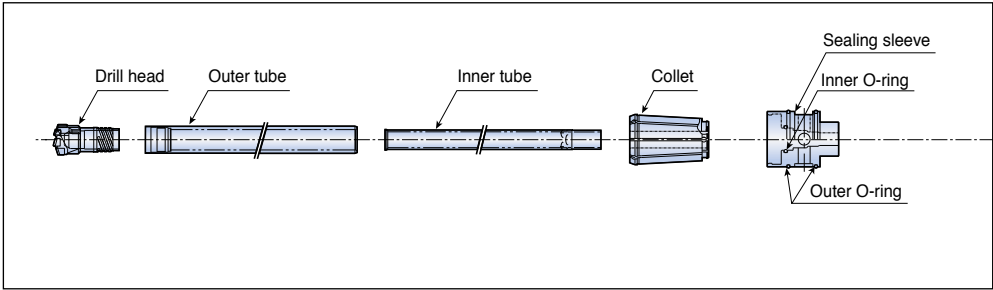

Designation		DC	Collet
BTDO 018	BTDI 012	18.40-19.20	COLLET 4-18
018	012	19.21-20.00	COLLET 4-18
019.5	014	20.01-20.90	COLLET 4-19.5
019.5	014	20.91-21.80	COLLET 4-19.5
021.5	015	21.81-22.90	COLLET 4-21.5
021.5	015	22.91-24.10	COLLET 4-21.5
023.5	016	24.11-25.20	COLLET 4-23.5
023.5	016	25.21-26.40	COLLET 4-23.5
026	018	26.41-27.50	COLLET 4-26
026	018	27.51-28.70	COLLET 4-26
028	020	28.71-29.80	COLLET 4-28
028	020	29.81-31.00	COLLET 4-28
030.5	022	31.01-32.10	COLLET 4-30.5
030.5	022	32.11-33.30	COLLET 4-30.5
033	024	33.31-34.80	COLLET 4-33
033	024	34.81-36.20	COLLET 4-33
035.5	026	36.21-37.30	COLLET 4-35.5
035.5	026	37.31-38.40	COLLET 4-35.5
035.5	026	38.41-39.60	COLLET 4-35.5
039	029	39.61-40.60	COLLET 4-39
039	029	40.61-41.80	COLLET 4-39
039	029	41.81-43.00	COLLET 4-39
042.5	032	43.01-44.30	COLLET 4-42.5
042.5	032	44.31-45.60	COLLET 4-42.5
042.5	032	45.61-47.00	COLLET 4-42.5
046.5	035	47.01-48.50	COLLET 4-46.5
046.5	035	48.51-50.10	COLLET 4-46.5
046.5	035	50.11-51.70	COLLET 4-46.5
051	039	51.71-53.20	COLLET 4-51
051	039	53.21-54.70	COLLET 4-51
051	039	54.71-56.20	COLLET 4-51
055.5	043A	56.21-58.40	COLLET 4-55.5
055.5	043A	58.41-60.60	COLLET 4-55.5
055.5	043A	60.61-62.80	COLLET 4-55.5
055.5	043A	62.81-65.00	COLLET 4-55.5

▶ Inner tube should be longer than outer tube. Please refer to page D174 for details

Assembly of Double Tube System



Connector

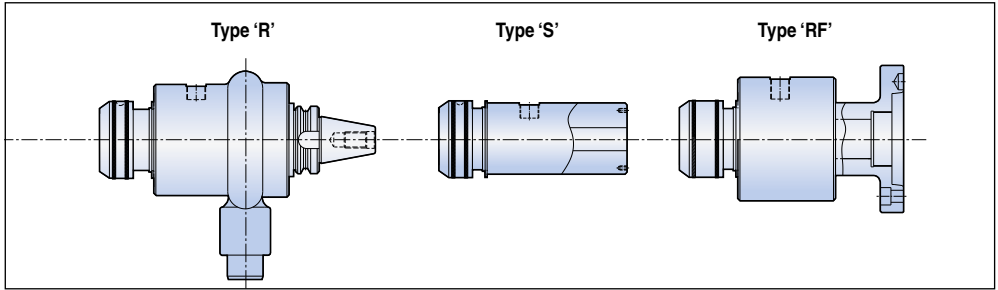

Sealing sleeve	Outer O-ring	Inner O-ring	Connector
SEALING SLEEVE 4R-18	OOR 25.24	IOR18	DTC-4S/4R/4RF
SEALING SLEEVE 4R-18		IOR18	
SEALING SLEEVE 4R-19.5		IOR19.5	
SEALING SLEEVE 4R-19.5		IOR19.5	
SEALING SLEEVE 4R-21.5		IOR21.5	
SEALING SLEEVE 4R-21.5		IOR21.5	
SEALING SLEEVE 4R-23.5		IOR23.5	
SEALING SLEEVE 4R-23.5		IOR23.5	
SEALING SLEEVE 4R-26		IOR26	
SEALING SLEEVE 4R-26		IOR26	
SEALING SLEEVE 4R-28		IOR28	
SEALING SLEEVE 4R-28		IOR28	
SEALING SLEEVE 4R-30.5		IOR30.5	
SEALING SLEEVE 4R-30.5		IOR30.5	
SEALING SLEEVE 4R-33	IOR33		
SEALING SLEEVE 4R-33	IOR33		
SEALING SLEEVE 4R-35.5	OOR65	IOR35.5	
SEALING SLEEVE 4R-35.5		IOR35.5	
SEALING SLEEVE 4R-35.5		IOR35.5	
SEALING SLEEVE 4R-39		IOR39	
SEALING SLEEVE 4R-39		IOR39	
SEALING SLEEVE 4R-39		IOR39	
SEALING SLEEVE 4R-42.5		IOR42.5	
SEALING SLEEVE 4R-42.5		IOR42.5	
SEALING SLEEVE 4R-42.5		IOR42.5	
SEALING SLEEVE 4R-46.5		IOR46.5	
SEALING SLEEVE 4R-46.5		IOR46.5	
SEALING SLEEVE 4R-46.5		IOR46.5	
SEALING SLEEVE 4R-51		IOR51	
SEALING SLEEVE 4R-51		IOR51	
SEALING SLEEVE 4R-51		IOR51	
SEALING SLEEVE 4R-55.5		IOR55.5	
SEALING SLEEVE 4R-55.5	IOR55.5		
SEALING SLEEVE 4R-55.5	IOR55.5		
SEALING SLEEVE 4R-55.5	IOR55.5		

'S' type connector

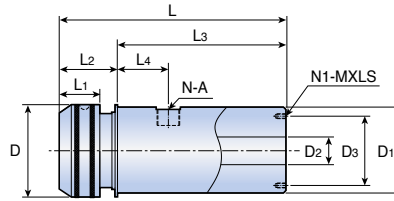

Designation	DC	D	D1	D2	D3	L	L1	L2	L3	L4	N-A	N1-MXLS
DTC 4S	18.4-65.0	115	100	45	80	310	50	60	250	68	2-PT3/4"	4-M8x15
5S	65.0-123.9	164	140	81	120	415	47	115	300		2-PT1"	6-M8x20

'R' type connector

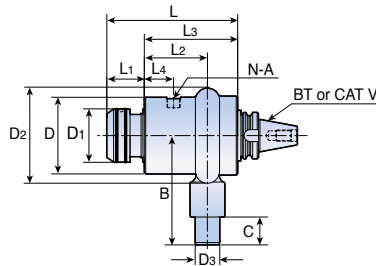

Designation	DC	D	D1	D2	D3	B	C	L	L1	L2	L3	L4	N-A
DTC 4R	18.4-65.0	165	115	206	53	186.5	60	319.7	59.2	152	228	75	2-PT1"
5R	65.0-123.9	225	164	312	100	310	100	382	62	201	320	95	2-PT1 1/4"
6R	124.0-183.9	350	244	445	152.4	412	120	487	75	250	412	118	4-PT1-1/4"

'RF' type connector

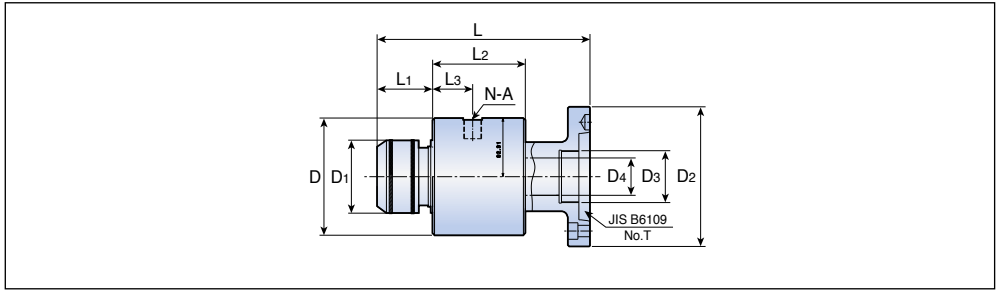

Designation	DC	D	D1	D2	D3	D4	L	L1	L2	L3	N-A
DTC 4RF	18.4-65.0	160	115	210	M62x2	46	291.5	64.5	150	75	2-PT1"

Collet / Sealing Sleeve

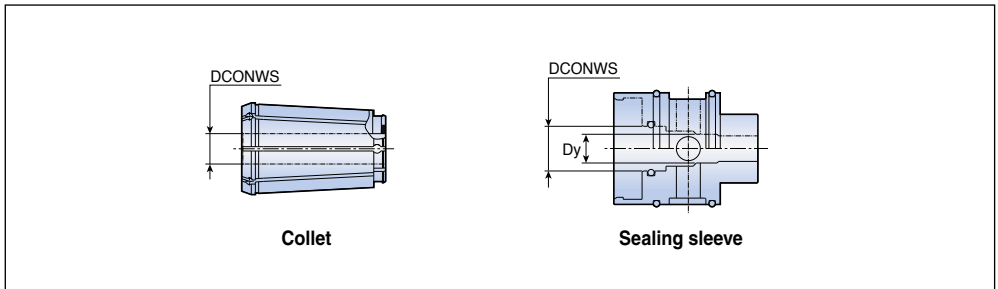

Designation	DC	DCONWS	Designation	DC	DCONWS	Dy	Outer O-ring	Inner O-ring
COLLET 4-18	18.40-20.00	18.0	SEALING SLEEVE 4-18	4-18	18.40-20.00	18.0	OOR 65	IOR 18
4-19.5	20.01-21.80	19.5		4-19.5	20.01-21.80	19.5		IOR 19.5
4-21.5	21.81-24.10	21.5		4-21.5	21.81-24.10	21.5		IOR 21.5
4-23.5	24.11-26.40	23.5		4-23.5	24.11-26.40	23.5		IOR 23.5
4-26	26.41-28.70	26.0		4-26	26.41-28.70	26.0		IOR 26
4-28	28.71-31.00	28.0		4-28	28.71-31.00	28.0		IOR 28
4-30.5	31.01-33.30	30.5		4-30.5	31.01-33.30	30.5		IOR 30.5
4-33	33.31-36.20	33.0		4-33	33.31-36.20	33.0		IOR 33
4-35.5	36.21-39.60	35.5		4-35.5	36.21-39.60	35.5		IOR 35.5
4-39	39.61-43.00	39.0		4-39	39.61-43.00	39.0		IOR 39
4-42.5	43.01-47.00	42.5		4-42.5	43.01-47.00	42.5		IOR 42.5
4-46.5	47.01-51.70	46.5		4-46.5	47.01-51.70	46.5		IOR 46.5
4-51	51.71-56.20	51.0		4-51	51.71-56.20	51.0		IOR 51
4-55.5	56.21-65.00	55.5		4-55.5	56.21-65.00	55.5		IOR 55.5

Drilling Heads & Inserts



SOMT...DP



Inserts for general purpose

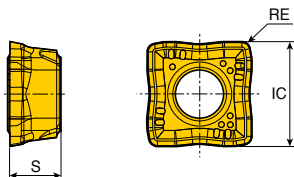

Size	Dimension (mm)		
	IC	S	RE
04	4.4	2.38	0.4
05	4.9	2.38	0.4
06	5.7	2.38	0.4
07	6.8	2.80	0.6
08	7.9	3.97	0.6
09	9.2	3.97	0.8
11	11.0	3.97	0.8
13	12.8	4.40	0.8
15	15.0	4.80	1.0

Insert	Designation	Coated						Uncoated	
		TT9080	TT8020	TT9300	TT9030	TT6030	TT7400	K10	
	SOMT 040204 DP	●	●	●					
	050204 DP	●	●	●					
	060204 DP	●	●	●					
	070306 DP	●	●	●					
	08T306 DP	●	●	●					
	09T308 DP	●	●	●					
	11T308 DP	●	●	●					
	130408 DP	●	●	●					
	150510 DP	●	●	●					



- ▶ TT9080: First choice for general purpose
- ▶ TT8020: For unstable condition
- ▶ TT9300: For high speed machining on a steel application (Peripheral **ONLY**)

●: Standard items

SOMT...DL



Inserts for low carbon steel

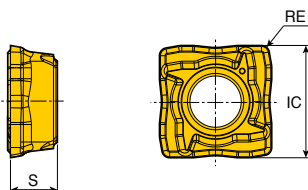

Size	Dimension (mm)		
	IC	S	RE
05	4.9	2.38	0.4
06	5.7	2.38	0.4
07	6.8	2.80	0.6
08	7.9	3.97	0.6
09	9.2	3.97	0.8
11	11.0	3.97	0.8
13	12.8	4.40	0.8
15	15.0	4.80	1.0

Insert	Designation	Coated						Uncoated	
		TT9080	TT9030	TT8020	TT6030	TT9300	TT7400	K10	
	SOMT 050204 DL	●							
	060204 DL	●							
	070306 DL	●							
	08T306 DL	●							
	09T308 DL	●							
	11T308 DL	●							
	130408 DL	●							
	150510 DL	●							



- ▶ TT9080: First choice for general purpose

●: Standard items

SOMT...DK



Inserts for cast iron

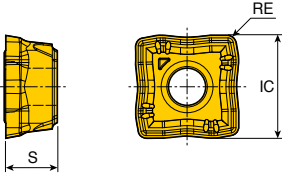

Size	Dimension (mm)		
	IC	S	RE
05	4.9	2.38	0.4
06	5.7	2.38	0.4
07	6.8	2.80	0.6
08	7.9	3.97	0.6
09	9.2	3.97	0.8
11	11.0	3.97	0.8
13	12.8	4.40	0.8
15	15.0	4.80	1.0

Insert	Designation	Coated						Uncoated	
		TT9080	TT8020	TT9300	TT9030	TT6030	TT6080	TT7400	K10
	SOMT 050204 DK						•		
	060204 DK						•		
	070306 DK						•		
	08T306 DK						•		
	09T308 DK						•		
	11T308 DK						•		
	130408 DK						•		
	150510 DK						•		



•: Standard items

SOMT...DA



Inserts for aluminum alloy

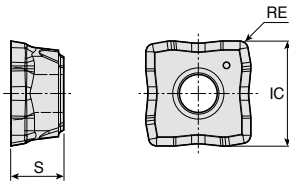

Size	Dimension (mm)		
	IC	S	RE
05	4.9	2.38	0.4
06	5.7	2.38	0.4
07	6.8	2.80	0.6
08	7.9	3.97	0.6
09	9.2	3.97	0.8
11	11.0	3.97	0.8
13	12.8	4.40	0.8
15	15.0	4.80	1.0

Insert	Designation	Coated						Uncoated	
		TT9080	TT8020	TT9300	TT9030	TT6030	TT6080	TT7400	K10
	SOMT 050204 DA								•
	060204 DA								•
	070306 DA								•
	08T306 DA								•
	09T308 DA								•
	11T308 DA								•
	130408 DA								•
	150510 DA								•



•: Standard items

SPMG...DG



Inserts for general purpose

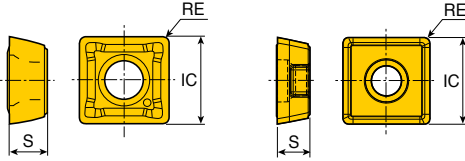

SPMG 120408 DG

Size	Dimension (mm)		
	IC	S	RE
05	5.00	2.38	0.4
06	6.00	2.38	0.4
07	7.94	3.97	0.8
09	9.80	4.30	0.8
11	11.50	4.80	0.8
12	12.70	4.76	0.8
14	14.30	5.20	1.2

Insert	Designation	Coated						Uncoated	
		TT9080	TT9030	TT8020	TT6030	TT9300	TT7400		
	SPMG 050204 DG		●	●			●		
	060204 DG		●	●			●		
	07T308 DG		●	●			●		
	090408 DG		●	●			●		
	110408 DG		●	●			●		
	120408 DG		●						
	140512 DG		●	●			●		



- ▶ TT9030: First choice for general purpose
- ▶ TT8020: For unstable condition
- ▶ TT7400: For high speed machining on a steel application (Peripheral **ONLY**)

●: Standard items

SPMG...DK



Inserts for cast iron

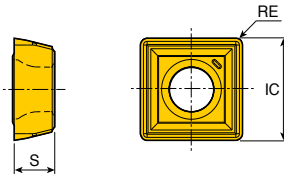

Size	Dimension (mm)		
	IC	S	RE
05	5.00	2.38	0.4
06	6.00	2.38	0.4
07	7.94	3.97	0.8
09	9.80	4.30	0.8
11	11.50	4.80	0.8
14	14.30	5.20	1.2

Insert	Designation	Coated						Uncoated	
		TT9080	TT9030	TT8020	TT6030	TT9300	TT7400		
	SPMG 050204 DK				●				
	060204 DK				●				
	07T308 DK				●				
	090408 DK				●				
	110408 DK				●				
	140512 DK				●				



●: Standard items

SPGG...DA



Inserts for aluminum alloy

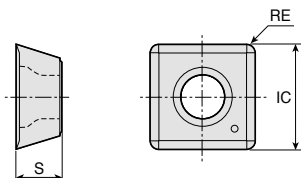

Size	Dimension (mm)		
	IC	S	RE
05	5.00	2.38	0.4
06	6.00	2.38	0.4
07	7.94	3.97	0.8
09	9.80	4.30	0.8
11	11.50	4.80	0.8
14	14.30	5.20	1.2

Insert	Designation	Coated						Uncoated	
		TT9080	TT9030	TT8020	TT6030	TT9300	TT7400		
	SPGG 050204 DA							•	K10
	060204 DA							•	
	07T308 DA							•	
	090408 DA							•	
	110408 DA							•	
	140512 DA							•	



D34-D49

•: Standard items

3 flute drill heads

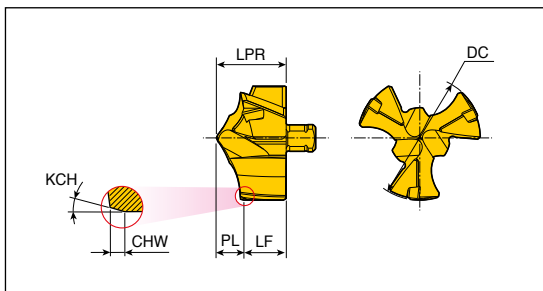

Designation	Dimension (mm)							Grade TT5130
	DC	LPR	PL	LF	CHW	KCH	SSC	
3ED-120-P+	12.0	6.7	2.74	3.96	0.4	15	12	●
121-P+	12.1	6.7	2.74	3.96	0.4	15	12	●
122-P+	12.2	6.7	2.74	3.96	0.4	15	12	●
123-P+	12.3	6.7	2.74	3.96	0.4	15	12	●
124-P+	12.4	6.7	2.74	3.96	0.4	15	12	●
125-P+	12.5	6.7	2.76	3.94	0.4	15	12	●
126-P+	12.6	6.7	2.76	3.94	0.4	15	12	●
127-P+	12.7	6.7	2.76	3.94	0.4	15	12	●
128-P+	12.8	6.7	2.76	3.94	0.4	15	12	●
129-P+	12.9	6.7	2.76	3.94	0.4	15	12	●
130-P+	13.0	7.3	2.91	4.39	0.4	15	13	●
131-P+	13.1	7.3	2.91	4.39	0.4	15	13	●
132-P+	13.2	7.3	2.91	4.39	0.4	15	13	●
133-P+	13.3	7.3	2.91	4.39	0.4	15	13	●
134-P+	13.4	7.3	2.91	4.39	0.4	15	13	●
135-P+	13.5	7.3	2.93	4.37	0.4	15	13	●
136-P+	13.6	7.3	2.93	4.37	0.4	15	13	●
137-P+	13.7	7.3	2.93	4.37	0.4	15	13	●
138-P+	13.8	7.3	2.93	4.37	0.4	15	13	●
139-P+	13.9	7.3	2.93	4.37	0.4	15	13	●
140-P+	14.0	7.9	3.17	4.73	0.4	15	14	●
141-P+	14.1	7.9	3.17	4.73	0.4	15	14	●
142-P+	14.2	7.9	3.17	4.73	0.4	15	14	●
143-P+	14.3	7.9	3.17	4.73	0.4	15	14	●
144-P+	14.4	7.9	3.17	4.73	0.4	15	14	●
145-P+	14.5	7.9	3.19	4.71	0.4	15	14	●
146-P+	14.6	7.9	3.19	4.71	0.4	15	14	●
147-P+	14.7	7.9	3.19	4.71	0.4	15	14	●
148-P+	14.8	7.9	3.19	4.71	0.4	15	14	●
149-P+	14.9	7.9	3.19	4.71	0.4	15	14	●
150-P+	15.0	8.4	3.31	5.09	0.5	30	15	●
151-P+	15.1	8.4	3.31	5.09	0.5	30	15	●
152-P+	15.2	8.4	3.31	5.09	0.5	30	15	●
153-P+	15.3	8.4	3.31	5.09	0.5	30	15	●
154-P+	15.4	8.4	3.31	5.09	0.5	30	15	●



► SSC: Seat size code

●: Standard items

3ED...-P+

3 flute drill heads

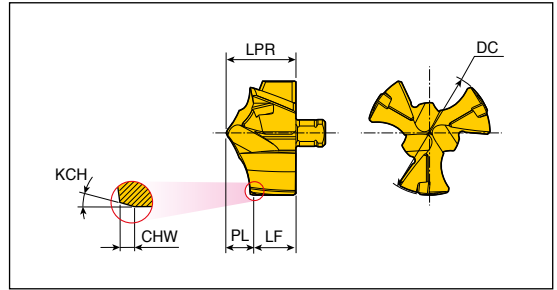

Designation	Dimension (mm)							Grade TT5130
	DC	LPR	PL	LF	CHW	KCH	SSC	
3ED-155-P+	15.5	8.4	3.32	5.08	0.5	30	15	●
156-P+	15.6	8.4	3.32	5.08	0.5	30	15	●
157-P+	15.7	8.4	3.32	5.08	0.5	30	15	●
158-P+	15.8	8.4	3.32	5.08	0.5	30	15	●
159-P+	15.9	8.4	3.32	5.08	0.5	30	15	●
160-P+	16.0	9.0	3.70	5.30	0.7	30	16	●
161-P+	16.1	9.0	3.70	5.30	0.7	30	16	●
162-P+	16.2	9.0	3.70	5.30	0.7	30	16	●
163-P+	16.3	9.0	3.70	5.30	0.7	30	16	●
164-P+	16.4	9.0	3.70	5.30	0.7	30	16	●
165-P+	16.5	9.0	3.71	5.29	0.7	30	16	●
166-P+	16.6	9.0	3.71	5.29	0.7	30	16	●
167-P+	16.7	9.0	3.71	5.29	0.7	30	16	●
168-P+	16.8	9.0	3.71	5.29	0.7	30	16	●
169-P+	16.9	9.0	3.71	5.29	0.7	30	16	●
170-P+	17.0	9.5	3.88	5.62	0.7	30	17	●
171-P+	17.1	9.5	3.88	5.62	0.7	30	17	●
172-P+	17.2	9.5	3.88	5.62	0.7	30	17	●
173-P+	17.3	9.5	3.88	5.62	0.7	30	17	●
174-P+	17.4	9.5	3.88	5.62	0.7	30	17	●
175-P+	17.5	9.5	3.89	5.61	0.7	30	17	●
176-P+	17.6	9.5	3.89	5.61	0.7	30	17	●
177-P+	17.7	9.5	3.89	5.61	0.7	30	17	●
178-P+	17.8	9.5	3.89	5.61	0.7	30	17	●
179-P+	17.9	9.5	3.89	5.61	0.7	30	17	●
180-P+	18.0	10.1	4.07	6.03	0.7	30	18	●
181-P+	18.1	10.1	4.07	6.03	0.7	30	18	●
182-P+	18.2	10.1	4.07	6.03	0.7	30	18	●
183-P+	18.3	10.1	4.07	6.03	0.7	30	18	●
184-P+	18.4	10.1	4.07	6.03	0.7	30	18	●
185-P+	18.5	10.1	4.08	6.02	0.7	30	18	●
186-P+	18.6	10.1	4.08	6.02	0.7	30	18	●
187-P+	18.7	10.1	4.08	6.02	0.7	30	18	●
188-P+	18.8	10.1	4.08	6.02	0.7	30	18	●
189-P+	18.9	10.1	4.08	6.02	0.7	30	18	●



► SSC: Seat size code

●: Standard items

D55-D57

3 flute drill heads

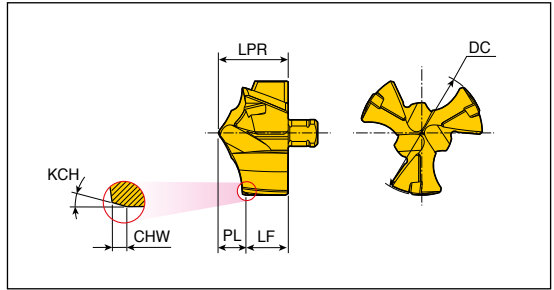

Designation	Dimension (mm)							Grade TT5130
	DC	LPR	PL	LF	CHW	KCH	SSC	
3ED-190-P+	19.0	10.7	4.26	6.44	0.7	30	19	●
191-P+	19.1	10.7	4.26	6.44	0.7	30	19	●
192-P+	19.2	10.7	4.26	6.44	0.7	30	19	●
193-P+	19.3	10.7	4.26	6.44	0.7	30	19	●
194-P+	19.4	10.7	4.26	6.44	0.7	30	19	●
195-P+	19.5	10.7	4.27	6.43	0.7	30	19	●
196-P+	19.6	10.7	4.27	6.43	0.7	30	19	●
197-P+	19.7	10.7	4.27	6.43	0.7	30	19	●
198-P+	19.8	10.7	4.27	6.43	0.7	30	19	●
199-P+	19.9	10.7	4.27	6.43	0.7	30	19	●
200-P+	20.0	11.3	4.44	6.86	0.7	30	20	●
201-P+	20.1	11.3	4.44	6.86	0.7	30	20	●
202-P+	20.2	11.3	4.44	6.86	0.7	30	20	●
203-P+	20.3	11.3	4.44	6.86	0.7	30	20	●
204-P+	20.4	11.3	4.44	6.86	0.7	30	20	●
205-P+	20.5	11.3	4.45	6.85	0.7	30	20	●
206-P+	20.6	11.3	4.45	6.85	0.7	30	20	●
207-P+	20.7	11.3	4.45	6.85	0.7	30	20	●
208-P+	20.8	11.3	4.45	6.85	0.7	30	20	●
209-P+	20.9	11.3	4.45	6.85	0.7	30	20	●
210-P+	21.0	11.8	4.62	7.18	0.4	15	21	●
215-P+	21.5	11.8	4.64	7.16	0.4	15	21	●
220-P+	22.0	12.4	4.78	7.62	0.4	15	22	●
225-P+	22.5	12.4	4.80	7.60	0.4	15	22	●
230-P+	23.0	12.8	5.02	7.78	0.4	15	23	●
235-P+	23.5	12.8	5.04	7.76	0.4	15	23	●
240-P+	24.0	13.4	5.18	8.22	0.4	15	24	●
245-P+	24.5	13.4	5.20	8.20	0.4	15	24	●
250-P+	25.0	14.0	5.29	8.71	0.4	15	25	●
255-P+	25.5	14.0	5.31	8.69	0.4	15	25	●



► SSC: Seat size code

●: Standard items

D65-D57

3ED...-F

3 flute drill heads for flat bottom hole

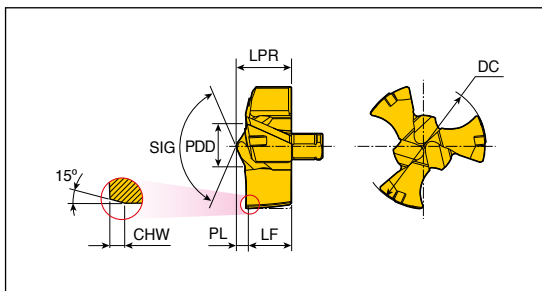

Designation	Dimension (mm)								Grade
	DC	LPR	PL	LF	PDD	SIG	CHW	SSC	TT5130
3ED- 120-F	12.0	5.14	1.18	3.96	3.38	133	0.4	12	●
125-F	12.5	5.14	1.20	3.94	3.38	133	0.4	12	●
130-F	13.0	5.61	1.22	4.39	3.58	132	0.4	13	●
135-F	13.5	5.61	1.24	4.37	3.58	132	0.4	13	●
140-F	14.0	6.01	1.28	4.73	4.01	133	0.4	14	●
145-F	14.5	6.01	1.30	4.71	4.01	133	0.4	14	●
150-F	15.0	6.38	1.32	5.06	4.16	133	0.4	15	●
155-F	15.5	6.38	1.34	5.04	4.16	133	0.4	15	●
160-F	16.0	6.86	1.38	5.48	4.52	134	0.4	16	●
165-F	16.5	6.86	1.40	5.46	4.52	134	0.4	16	●
170-F	17.0	7.22	1.45	5.77	4.79	134	0.4	17	●
175-F	17.5	7.22	1.47	5.75	4.79	134	0.4	17	●
180-F	18.0	7.93	1.75	6.18	5.96	133	0.4	18	●
185-F	18.5	7.93	1.77	6.16	5.96	133	0.4	18	●
190-F	19.0	8.41	1.83	6.58	6.32	133	0.4	19	●
195-F	19.5	8.41	1.85	6.56	6.32	133	0.4	19	●
200-F	20.0	8.89	1.90	6.99	6.61	133	0.4	20	●
205-F	20.5	8.89	1.92	6.97	6.61	133	0.4	20	●
210-F	21.0	9.17	1.99	7.18	7.01	133	0.4	21	●
215-F	21.5	9.17	2.01	7.16	7.01	133	0.4	21	●
220-F	22.0	9.72	2.10	7.62	7.30	133	0.4	22	●
225-F	22.5	9.72	2.12	7.60	7.30	133	0.4	22	●
230-F	23.0	9.96	2.18	7.78	7.49	132	0.4	23	●
235-F	23.5	9.96	2.20	7.76	7.49	132	0.4	23	●
240-F	24.0	10.46	2.24	8.22	7.81	132	0.4	24	●
245-F	24.5	10.46	2.26	8.20	7.81	132	0.4	24	●
250-F	25.0	11.03	2.31	8.72	8.16	132	0.4	25	●
255-F	25.5	11.03	2.33	8.70	8.16	132	0.4	25	●



▶ SSC: Seat size code

●: Standard items

TCD...-P

Drill heads

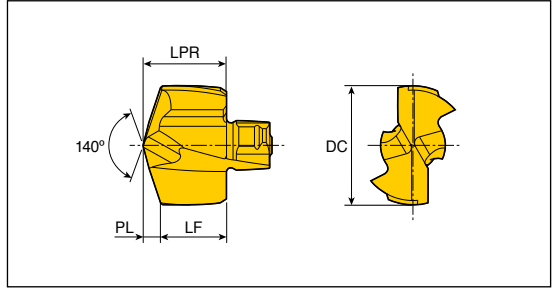

Designation	Dimension (mm)					Grade
	DC	LPR	PL	LF	SSC	TT9080
TCD - 040-P	4.0	3.10	0.62	2.48	4	●
041-P	4.1	3.10	0.64	2.46	4	●
042-P	4.2	3.10	0.66	2.44	4	●
043-P	4.3	3.10	0.67	2.43	4	●
044-P	4.4	3.10	0.69	2.41	4	●
045-P	4.5	3.55	0.66	2.89	4.5	●
046-P	4.6	3.55	0.68	2.87	4.5	●
047-P	4.7	3.55	0.70	2.85	4.5	●
048-P	4.8	3.55	0.71	2.84	4.5	●
049-P	4.9	3.55	0.73	2.82	4.5	●
050-P	5.0	3.70	0.73	2.97	5	●
051-P	5.1	3.70	0.75	2.95	5	●
052-P	5.2	3.70	0.77	2.93	5	●
053-P	5.3	3.70	0.78	2.92	5	●
054-P	5.4	3.70	0.80	2.90	5	●
055-P	5.5	3.85	0.80	3.05	5.5	●
056-P	5.6	3.85	0.82	3.03	5.5	●
057-P	5.7	3.85	0.84	3.01	5.5	●
058-P	5.8	3.85	0.85	3.00	5.5	●
059-P	5.9	3.85	0.87	2.98	5.5	●

●: Standard items



TCD...P/M/K



Drill heads

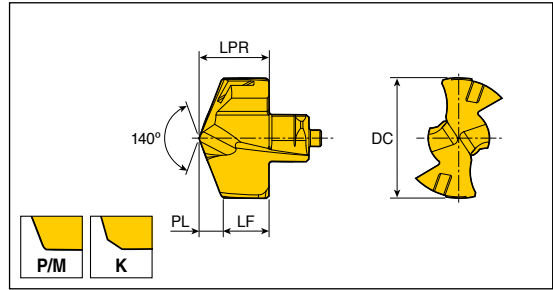

Designation	Dimension (mm)					Grade
	DC	LPR	PL	LF	SSC	
TCD - 060-P/M/K	6.0	4.0	0.96	3.04	6	●
061-P/M/K	6.1	4.0	0.98	3.02	6	●
062-P/M/K	6.2	4.0	1.00	3.00	6	●
063-P/M/K	6.3	4.0	1.01	2.99	6	●
064-P/M/K	6.4	4.0	1.03	2.97	6	●
065-P/M/K	6.5	4.3	1.18	3.12	6.5	●
066-P/M/K	6.6	4.3	1.20	3.10	6.5	●
067-P/M/K	6.7	4.3	1.22	3.08	6.5	●
068-P/M/K	6.8	4.3	1.23	3.07	6.5	●
069-P/M/K	6.9	4.3	1.25	3.05	6.5	●
070-P/M/K	7.0	4.6	1.01	3.59	7	●
071-P/M/K	7.1	4.6	1.03	3.57	7	●
072-P/M/K	7.2	4.6	1.05	3.55	7	●
073-P/M/K	7.3	4.6	1.06	3.54	7	●
074-P/M/K	7.4	4.6	1.08	3.52	7	●
075-P/M/K	7.5	4.6	1.10	3.50	7	●
076-P/M/K	7.6	4.6	1.12	3.48	7	●
077-P/M/K	7.7	4.6	1.14	3.46	7	●
078-P/M/K	7.8	4.6	1.16	3.44	7	●
079-P/M/K	7.9	4.6	1.17	3.43	7	●
080-P/M/K	8.0	5.4	1.20	4.20	8	●
081-P/M/K	8.1	5.4	1.22	4.18	8	●
082-P/M/K	8.2	5.4	1.24	4.16	8	●
083-P/M/K	8.3	5.4	1.25	4.15	8	●
084-P/M/K	8.4	5.4	1.27	4.13	8	●
085-P/M/K	8.5	5.4	1.29	4.11	8	●
086-P/M/K	8.6	5.4	1.31	4.09	8	●
087-P/M/K	8.7	5.4	1.33	4.07	8	●
088-P/M/K	8.8	5.4	1.35	4.05	8	●
089-P/M/K	8.9	5.4	1.36	4.04	8	●
090-P/M/K	9.0	5.8	1.35	4.45	9	●
091-P/M/K	9.1	5.8	1.37	4.43	9	●
092-P/M/K	9.2	5.8	1.39	4.41	9	●
093-P/M/K	9.3	5.8	1.40	4.40	9	●
094-P/M/K	9.4	5.8	1.42	4.38	9	●

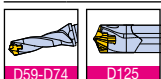

► Drill head can be ordered by an application
 Order example) Diameter 10.0mm drill head for
 ISO P application: TCD-100-P TT9080

●: Standard items

P Steel **M** Stainless steel **K** Cast iron

Drill heads

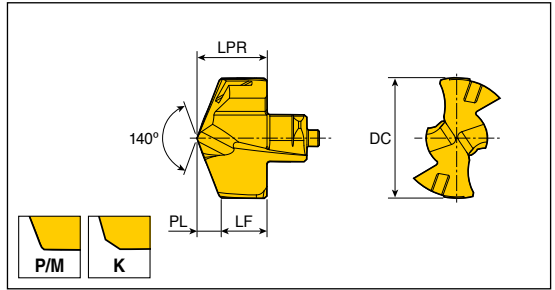

Designation	Dimension (mm)					Grade
	DC	LPR	PL	LF	SSC	
TCD - 095-P/M/K	9.5	5.8	1.44	4.36	9	●
096-P/M/K	9.6	5.8	1.46	4.34	9	●
097-P/M/K	9.7	5.8	1.48	4.32	9	●
098-P/M/K	9.8	5.8	1.50	4.30	9	●
099-P/M/K	9.9	5.8	1.51	4.29	9	●
100-P/M/K	10.0	6.2	1.50	4.70	10	●
101-P/M/K	10.1	6.2	1.52	4.68	10	●
102-P/M/K	10.2	6.2	1.54	4.66	10	●
103-P/M/K	10.3	6.2	1.55	4.65	10	●
104-P/M/K	10.4	6.2	1.57	4.63	10	●
105-P/M/K	10.5	6.2	1.59	4.61	10	●
106-P/M/K	10.6	6.2	1.61	4.59	10	●
107-P/M/K	10.7	6.2	1.63	4.57	10	●
108-P/M/K	10.8	6.2	1.65	4.55	10	●
109-P/M/K	10.9	6.2	1.66	4.54	10	●
110-P/M/K	11.0	6.6	1.67	4.93	11	●
111-P/M/K	11.1	6.6	1.69	4.91	11	●
112-P/M/K	11.2	6.6	1.71	4.89	11	●
113-P/M/K	11.3	6.6	1.72	4.88	11	●
114-P/M/K	11.4	6.6	1.74	4.86	11	●
115-P/M/K	11.5	6.6	1.76	4.84	11	●
116-P/M/K	11.6	6.6	1.78	4.82	11	●
117-P/M/K	11.7	6.6	1.80	4.80	11	●
118-P/M/K	11.8	6.6	1.82	4.78	11	●
119-P/M/K	11.9	6.6	1.83	4.77	11	●
120-P/M/K	12.0	7.0	1.82	5.18	12	●
121-P/M/K	12.1	7.0	1.84	5.16	12	●
122-P/M/K	12.2	7.0	1.86	5.14	12	●
123-P/M/K	12.3	7.0	1.87	5.13	12	●
124-P/M/K	12.4	7.0	1.89	5.11	12	●
125-P/M/K	12.5	7.0	1.91	5.09	12	●
126-P/M/K	12.6	7.0	1.93	5.07	12	●
127-P/M/K	12.7	7.0	1.95	5.05	12	●
128-P/M/K	12.8	7.0	1.97	5.03	12	●
129-P/M/K	12.9	7.0	1.98	5.02	12	●

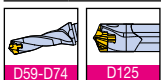

▶ Drill head can be ordered by an application
 Order example) Diameter 10.0mm drill head for
 ISO P application: TCD-100-P TT9080

●: Standard items

P Steel **M** Stainless steel **K** Cast iron

Drill heads

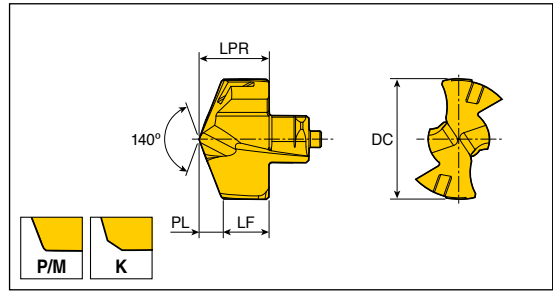

Designation	Dimension (mm)					Grade
	DC	LPR	PL	LF	SSC	TT9080
TCD - 130-P/M/K	13.0	7.6	1.96	5.64	13	●
131-P/M/K	13.1	7.6	1.98	5.62	13	●
132-P/M/K	13.2	7.6	2.00	5.60	13	●
133-P/M/K	13.3	7.6	2.01	5.59	13	●
134-P/M/K	13.4	7.6	2.03	5.57	13	●
135-P/M/K	13.5	7.6	2.05	5.55	13	●
136-P/M/K	13.6	7.6	2.07	5.53	13	●
137-P/M/K	13.7	7.6	2.09	5.51	13	●
138-P/M/K	13.8	7.6	2.11	5.49	13	●
139-P/M/K	13.9	7.6	2.12	5.48	13	●
140-P/M/K	14.0	8.1	2.12	5.98	14	●
141-P/M/K	14.1	8.1	2.14	5.96	14	●
142-P/M/K	14.2	8.1	2.16	5.94	14	●
143-P/M/K	14.3	8.1	2.17	5.93	14	●
144-P/M/K	14.4	8.1	2.19	5.91	14	●
145-P/M/K	14.5	8.1	2.21	5.89	14	●
146-P/M/K	14.6	8.1	2.23	5.87	14	●
147-P/M/K	14.7	8.1	2.25	5.85	14	●
148-P/M/K	14.8	8.1	2.27	5.83	14	●
149-P/M/K	14.9	8.1	2.28	5.82	14	●
150-P/M/K	15.0	8.7	2.27	6.43	15	●
151-P/M/K	15.1	8.7	2.29	6.41	15	●
152-P/M/K	15.2	8.7	2.31	6.39	15	●
153-P/M/K	15.3	8.7	2.32	6.38	15	●
154-P/M/K	15.4	8.7	2.34	6.36	15	●
155-P/M/K	15.5	8.7	2.36	6.34	15	●
156-P/M/K	15.6	8.7	2.38	6.32	15	●
157-P/M/K	15.7	8.7	2.40	6.30	15	●
158-P/M/K	15.8	8.7	2.42	6.28	15	●
159-P/M/K	15.9	8.7	2.43	6.27	15	●
160-P/M/K	16.0	9.3	2.42	6.88	16	●
161-P/M/K	16.1	9.3	2.44	6.86	16	●
162-P/M/K	16.2	9.3	2.46	6.84	16	●
163-P/M/K	16.3	9.3	2.47	6.83	16	●
164-P/M/K	16.4	9.3	2.49	6.81	16	●



► Drill head can be ordered by an application
 Order example) Diameter 10.0mm drill head for
 ISO P application: TCD-100-P TT9080

●: Standard items



Stainless steel



Cast iron

Drill heads

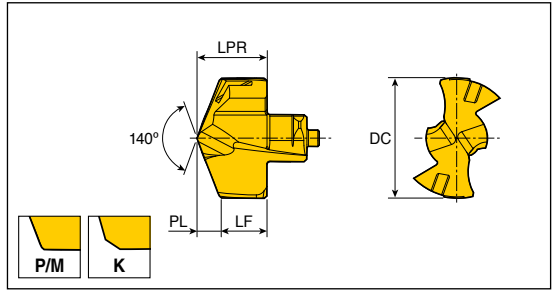

Designation	Dimension (mm)					Grade
	DC	LPR	PL	LF	SSC	
TCD - 165-P/M/K	16.5	9.3	2.51	6.79	16	●
166-P/M/K	16.6	9.3	2.53	6.77	16	●
167-P/M/K	16.7	9.3	2.55	6.75	16	●
168-P/M/K	16.8	9.3	2.57	6.73	16	●
169-P/M/K	16.9	9.3	2.58	6.72	16	●
170-P/M/K	17.0	9.9	2.59	7.31	17	●
171-P/M/K	17.1	9.9	2.61	7.29	17	●
172-P/M/K	17.2	9.9	2.63	7.27	17	●
173-P/M/K	17.3	9.9	2.64	7.26	17	●
174-P/M/K	17.4	9.9	2.66	7.24	17	●
175-P/M/K	17.5	9.9	2.68	7.22	17	●
176-P/M/K	17.6	9.9	2.70	7.20	17	●
177-P/M/K	17.7	9.9	2.72	7.18	17	●
178-P/M/K	17.8	9.9	2.74	7.16	17	●
179-P/M/K	17.9	9.9	2.75	7.15	17	●
180-P/M/K	18.0	10.5	2.73	7.77	18	●
181-P/M/K	18.1	10.5	2.75	7.75	18	●
182-P/M/K	18.2	10.5	2.77	7.73	18	●
183-P/M/K	18.3	10.5	2.78	7.72	18	●
184-P/M/K	18.4	10.5	2.80	7.70	18	●
185-P/M/K	18.5	10.5	2.82	7.68	18	●
186-P/M/K	18.6	10.5	2.84	7.66	18	●
187-P/M/K	18.7	10.5	2.86	7.64	18	●
188-P/M/K	18.8	10.5	2.88	7.62	18	●
189-P/M/K	18.9	10.5	2.89	7.61	18	●
190-P/M/K	19.0	11.0	2.88	8.12	19	●
191-P/M/K	19.1	11.0	2.90	8.10	19	●
192-P/M/K	19.2	11.0	2.92	8.08	19	●
193-P/M/K	19.3	11.0	2.93	8.07	19	●
194-P/M/K	19.4	11.0	2.95	8.05	19	●
195-P/M/K	19.5	11.0	2.97	8.03	19	●
196-P/M/K	19.6	11.0	2.99	8.01	19	●
197-P/M/K	19.7	11.0	3.01	7.99	19	●
198-P/M/K	19.8	11.0	3.03	7.97	19	●
199-P/M/K	19.9	11.0	3.04	7.96	19	●

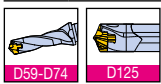

► Drill head can be ordered by an application
 Order example) Diameter 10.0mm drill head for
 ISO P application: TCD-100-P TT9080

●: Standard items

P Steel **M** Stainless steel **K** Cast iron

Drill heads

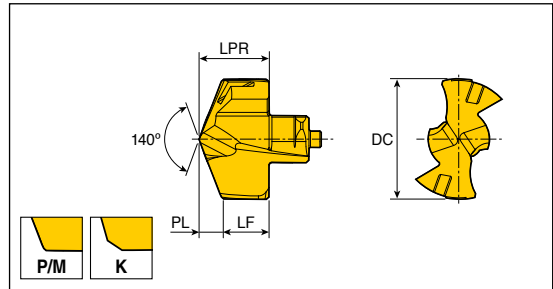

Designation	Dimension (mm)					Grade
	DC	LPR	PL	LF	SSC	TT9080
TCD - 200-P/M/K	20.0	11.6	3.02	8.58	20	●
201-P/M/K	20.1	11.6	3.04	8.56	20	●
202-P/M/K	20.2	11.6	3.06	8.54	20	●
203-P/M/K	20.3	11.6	3.07	8.53	20	●
204-P/M/K	20.4	11.6	3.09	8.51	20	●
205-P/M/K	20.5	11.6	3.11	8.49	20	●
206-P/M/K	20.6	11.6	3.13	8.47	20	●
207-P/M/K	20.7	11.6	3.15	8.45	20	●
208-P/M/K	20.8	11.6	3.17	8.43	20	●
209-P/M/K	20.9	11.6	3.18	8.42	20	●
210-P/M/K	21.0	12.1	3.18	8.92	21	●
211-P/M/K	21.1	12.1	3.20	8.90	21	●
212-P/M/K	21.2	12.1	3.22	8.88	21	●
213-P/M/K	21.3	12.1	3.23	8.87	21	●
214-P/M/K	21.4	12.1	3.25	8.85	21	●
215-P/M/K	21.5	12.1	3.27	8.83	21	●
216-P/M/K	21.6	12.1	3.29	8.81	21	●
217-P/M/K	21.7	12.1	3.31	8.79	21	●
218-P/M/K	21.8	12.1	3.33	8.77	21	●
219-P/M/K	21.9	12.1	3.34	8.76	21	●
220-P/M/K	22.0	12.7	3.24	9.46	22	●
221-P/M/K	22.1	12.7	3.26	9.44	22	●
222-P/M/K	22.2	12.7	3.28	9.42	22	●
223-P/M/K	22.3	12.7	3.29	9.41	22	●
224-P/M/K	22.4	12.7	3.31	9.39	22	●
225-P/M/K	22.5	12.7	3.33	9.37	22	●
226-P/M/K	22.6	12.7	3.35	9.35	22	●
227-P/M/K	22.7	12.7	3.37	9.33	22	●
228-P/M/K	22.8	12.7	3.39	9.31	22	●
229-P/M/K	22.9	12.7	3.40	9.30	22	●
230-P/M/K	23.0	13.3	3.46	9.84	23	●
231-P/M/K	23.1	13.3	3.48	9.82	23	●
232-P/M/K	23.2	13.3	3.50	9.80	23	●
233-P/M/K	23.3	13.3	3.51	9.79	23	●
234-P/M/K	23.4	13.3	3.53	9.77	23	●



D59-D74



D125

► Drill head can be ordered by an application
 Order example) Diameter 10.0mm drill head for
 ISO P application: TCD-100-P TT9080

●: Standard items



Stainless steel



Cast iron

Drill heads

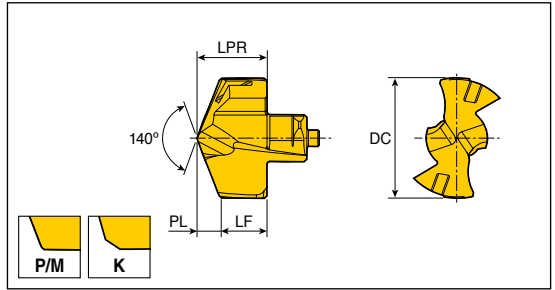

Designation	Dimension (mm)					Grade
	DC	LPR	PL	LF	SSC	
TCD - 235-P/M/K	23.5	13.3	3.55	9.75	23	●
236-P/M/K	23.6	13.3	3.57	9.73	23	●
237-P/M/K	23.7	13.3	3.59	9.71	23	●
238-P/M/K	23.8	13.3	3.61	9.69	23	●
239-P/M/K	23.9	13.3	3.62	9.68	23	●
240-P/M/K	24.0	13.9	3.62	10.28	24	●
241-P/M/K	24.1	13.9	3.64	10.26	24	●
242-P/M/K	24.2	13.9	3.66	10.24	24	●
243-P/M/K	24.3	13.9	3.67	10.23	24	●
244-P/M/K	24.4	13.9	3.69	10.21	24	●
245-P/M/K	24.5	13.9	3.71	10.19	24	●
246-P/M/K	24.6	13.9	3.73	10.17	24	●
247-P/M/K	24.7	13.9	3.75	10.15	24	●
248-P/M/K	24.8	13.9	3.77	10.13	24	●
249-P/M/K	24.9	13.9	3.78	10.12	24	●
250-P/M/K	25.0	14.5	3.80	10.70	25	●
251-P/M/K	25.1	14.5	3.82	10.68	25	●
252-P/M/K	25.2	14.5	3.84	10.66	25	●
253-P/M/K	25.3	14.5	3.85	10.65	25	●
254-P/M/K	25.4	14.5	3.87	10.63	25	●
255-P/M/K	25.5	14.5	3.89	10.61	25	●
256-P/M/K	25.6	14.5	3.91	10.59	25	●
257-P/M/K	25.7	14.5	3.93	10.57	25	●
258-P/M/K	25.8	14.5	3.95	10.55	25	●
259-P/M/K	25.9	14.5	3.96	10.54	25	●

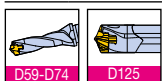

► Drill head can be ordered by an application
 Order example) Diameter 10.0mm drill head for
 ISO P application: TCD-100-P TT9080

●: Standard items

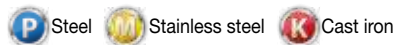

TCD...N



Drill heads for aluminum alloy

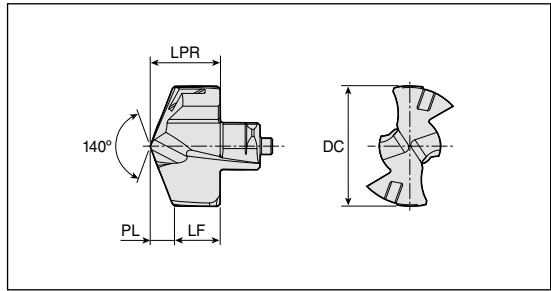

Designation	Dimension (mm)					Grade	
	DC	LPR	PL	LF	SSC	UF10	
TCD - 060-N	6.0	4.00	0.96	3.04	6	●	
065-N	6.5	4.30	1.18	3.12	6.5	●	
070-N	7.0	4.60	1.01	3.59	7	●	
075-N	7.5	4.60	1.10	3.50	7	●	
080-N	8.0	5.40	1.20	4.20	8	●	
085-N	8.5	5.40	1.29	4.11	8	●	
090-N	9.0	5.80	1.35	4.45	9	●	
095-N	9.5	5.80	1.44	4.36	9	●	
100-N	10.0	6.20	1.50	4.70	10	●	
105-N	10.5	6.20	1.59	4.61	10	●	
110-N	11.0	6.60	1.67	4.93	11	●	
115-N	11.5	6.60	1.76	4.84	11	●	
120-N	12.0	7.00	1.82	5.18	12	●	
125-N	12.5	7.00	1.91	5.09	12	●	
130-N	13.0	7.60	1.96	5.64	13	●	
135-N	13.5	7.60	2.05	5.55	13	●	
140-N	14.0	8.15	2.12	6.03	14	●	
145-N	14.5	8.15	2.21	5.94	14	●	
150-N	15.0	8.73	2.27	6.46	15	●	
155-N	15.5	8.73	2.36	6.37	15	●	
160-N	16.0	9.30	2.42	6.88	16	●	
165-N	16.5	9.30	2.51	6.79	16	●	
170-N	17.0	9.90	2.59	7.31	17	●	
175-N	17.5	9.90	2.68	7.22	17	●	
180-N	18.0	10.50	2.73	7.77	18	●	
185-N	18.5	10.50	2.82	7.68	18	●	
190-N	19.0	11.00	2.88	8.12	19	●	
195-N	19.5	11.00	2.97	8.03	19	●	

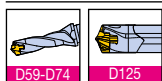

► SSC: Seat size code

●: Standard items

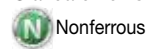

Self-centering drill heads

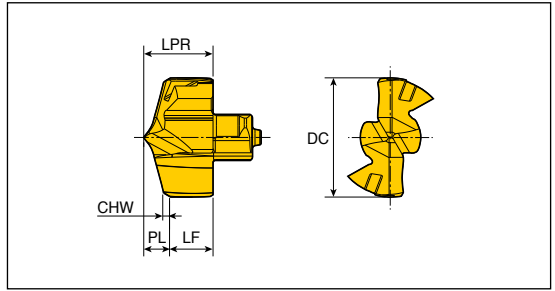

Designation	Dimension (mm)						Grade TT9080
	DC	LPR	PL	LF	CHW	SSC	
TCD-060-P+	6.0	4.00	1.46	2.54	0.5	6	●
065-P+	6.5	4.30	1.55	2.75	0.5	6.5	●
068-P+	6.8	4.30	1.59	2.71	0.5	6.5	●
070-P+	7.0	4.60	1.64	2.96	0.5	7	●
072-P+	7.2	4.60	1.67	2.93	0.5	7	●
075-P+	7.5	4.60	1.71	2.89	0.5	7	●
080-P+	8.0	5.40	1.81	3.59	0.5	8	●
081-P+	8.1	5.40	1.82	3.58	0.5	8	●
082-P+	8.2	5.40	1.84	3.56	0.5	8	●
083-P+	8.3	5.40	1.85	3.55	0.5	8	●
085-P+	8.5	5.40	1.88	3.52	0.5	8	●
086-P+	8.6	5.40	1.89	3.51	0.5	8	●
087-P+	8.7	5.40	1.90	3.50	0.5	8	●
088-P+	8.8	5.40	1.92	3.48	0.5	8	●
089-P+	8.9	5.40	1.93	3.47	0.5	8	●
090-P+	9.0	5.80	1.98	3.82	0.5	9	●
093-P+	9.3	5.80	2.02	3.78	0.5	9	●
095-P+	9.5	5.80	2.05	3.75	0.5	9	●
096-P+	9.6	5.80	2.06	3.74	0.5	9	●
097-P+	9.7	5.80	2.07	3.73	0.5	9	●
098-P+	9.8	5.80	2.09	3.71	0.5	9	●
099-P+	9.9	5.80	2.10	3.70	0.5	9	●
100-P+	10.0	6.20	2.33	3.87	0.7	10	●
101-P+	10.1	6.20	2.34	3.86	0.7	10	●
102-P+	10.2	6.20	2.36	3.84	0.7	10	●
103-P+	10.3	6.20	2.37	3.83	0.7	10	●
105-P+	10.5	6.20	2.40	3.80	0.7	10	●
106-P+	10.6	6.20	2.41	3.79	0.7	10	●
107-P+	10.7	6.20	2.42	3.78	0.7	10	●
108-P+	10.8	6.20	2.44	3.76	0.7	10	●
109-P+	10.9	6.20	2.45	3.75	0.7	10	●
110-P+	11.0	6.60	2.50	4.10	0.7	11	●
111-P+	11.1	6.60	2.51	4.09	0.7	11	●
112-P+	11.2	6.60	2.53	4.07	0.7	11	●
113-P+	11.3	6.60	2.54	4.06	0.7	11	●

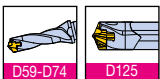

▶ SSC: Seat size code

●: Standard items

TCD-P+

Self-centering drill heads

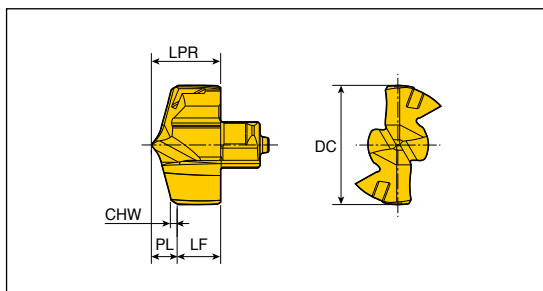

Designation	Dimension (mm)						Grade TT9080
	DC	LPR	PL	LF	CHW	SSC	
TCD-114-P+	11.4	6.60	2.55	4.05	0.7	11	●
115-P+	11.5	6.60	2.57	4.03	0.7	11	●
116-P+	11.6	6.60	2.58	4.02	0.7	11	●
117-P+	11.7	6.60	2.59	4.01	0.7	11	●
118-P+	11.8	6.60	2.61	3.99	0.7	11	●
119-P+	11.9	6.60	2.62	3.98	0.7	11	●
120-P+	12.0	7.00	2.67	4.33	0.7	12	●
121-P+	12.1	7.00	2.68	4.32	0.7	12	●
122-P+	12.2	7.00	2.70	4.30	0.7	12	●
123-P+	12.3	7.00	2.71	4.29	0.7	12	●
124-P+	12.4	7.00	2.72	4.28	0.7	12	●
125-P+	12.5	7.00	2.74	4.26	0.7	12	●
126-P+	12.6	7.00	2.75	4.25	0.7	12	●
127-P+	12.7	7.00	2.76	4.24	0.7	12	●
128-P+	12.8	7.00	2.78	4.22	0.7	12	●
130-P+	13.0	7.60	2.85	4.75	0.7	13	●
131-P+	13.1	7.60	2.86	4.74	0.7	13	●
132-P+	13.2	7.60	2.88	4.72	0.7	13	●
133-P+	13.3	7.60	2.89	4.71	0.7	13	●
134-P+	13.4	7.60	2.90	4.70	0.7	13	●
135-P+	13.5	7.60	2.92	4.68	0.7	13	●
136-P+	13.6	7.60	2.93	4.67	0.7	13	●
137-P+	13.7	7.60	2.94	4.66	0.7	13	●
138-P+	13.8	7.60	2.96	4.64	0.7	13	●
139-P+	13.9	7.60	2.97	4.63	0.7	13	●
140-P+	14.0	8.15	3.02	5.13	0.7	14	●
141-P+	14.1	8.15	3.03	5.12	0.7	14	●
142-P+	14.2	8.15	3.05	5.10	0.7	14	●
143-P+	14.3	8.15	3.06	5.09	0.7	14	●
144-P+	14.4	8.15	3.07	5.08	0.7	14	●
145-P+	14.5	8.15	3.09	5.06	0.7	14	●
146-P+	14.6	8.15	3.10	5.05	0.7	14	●
147-P+	14.7	8.15	3.11	5.04	0.7	14	●
148-P+	14.8	8.15	3.13	5.02	0.7	14	●
150-P+	15.0	8.73	3.19	5.54	0.7	15	●

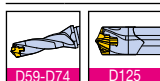

► SSC: Seat size code

●: Standard items

Self-centering drill heads

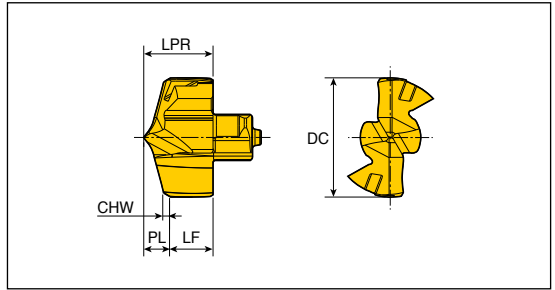

Designation	Dimension (mm)						Grade TT9080
	DC	LPR	PL	LF	CHW	SSC	
TCD-151-P+	15.1	8.73	3.20	5.53	0.7	15	●
152-P+	15.2	8.73	3.22	5.51	0.7	15	●
153-P+	15.3	8.73	3.23	5.50	0.7	15	●
154-P+	15.4	8.73	3.24	5.49	0.7	15	●
155-P+	15.5	8.73	3.26	5.47	0.7	15	●
156-P+	15.6	8.73	3.27	5.46	0.7	15	●
157-P+	15.7	8.73	3.28	5.45	0.7	15	●
158-P+	15.8	8.73	3.30	5.43	0.7	15	●
159-P+	15.9	8.73	3.31	5.42	0.7	15	●
160-P+	16.0	9.30	3.46	5.84	0.81	16	●
161-P+	16.1	9.30	3.47	5.83	0.81	16	●
162-P+	16.2	9.30	3.49	5.81	0.81	16	●
163-P+	16.3	9.30	3.50	5.80	0.81	16	●
164-P+	16.4	9.30	3.51	5.79	0.81	16	●
165-P+	16.5	9.30	3.53	5.77	0.81	16	●
166-P+	16.6	9.30	3.54	5.76	0.81	16	●
167-P+	16.7	9.30	3.55	5.75	0.81	16	●
168-P+	16.8	9.30	3.57	5.73	0.81	16	●
170-P+	17.0	9.90	3.63	6.27	0.81	17	●
171-P+	17.1	9.90	3.64	6.26	0.81	17	●
172-P+	17.2	9.90	3.66	6.24	0.81	17	●
173-P+	17.3	9.90	3.67	6.23	0.81	17	●
174-P+	17.4	9.90	3.68	6.22	0.81	17	●
175-P+	17.5	9.90	3.70	6.20	0.81	17	●
176-P+	17.6	9.90	3.71	6.19	0.81	17	●
177-P+	17.7	9.90	3.72	6.18	0.81	17	●
178-P+	17.8	9.90	3.74	6.16	0.81	17	●
179-P+	17.9	9.90	3.75	6.15	0.81	17	●
180-P+	18.0	10.50	3.81	6.69	0.81	18	●
181-P+	18.1	10.50	3.82	6.68	0.81	18	●
182-P+	18.2	10.50	3.84	6.66	0.81	18	●
183-P+	18.3	10.50	3.85	6.65	0.81	18	●
185-P+	18.5	10.50	3.88	6.62	0.81	18	●
186-P+	18.6	10.50	3.89	6.61	0.81	18	●
187-P+	18.7	10.50	3.90	6.60	0.81	18	●

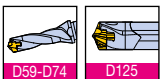

▶ SSC: Seat size code

●: Standard items

TCD-P+

Self-centering drill heads

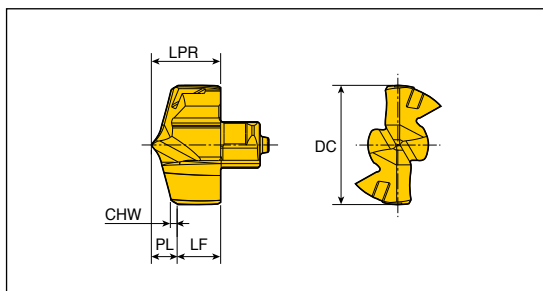

Designation	Dimension (mm)						Grade TT9080
	DC	LPR	PL	LF	CHW	SSC	
TCD-188-P+	18.8	10.50	3.92	6.58	0.81	18	●
190-P+	19.0	11.00	3.98	7.02	0.81	19	●
191-P+	19.1	11.00	3.99	7.01	0.81	19	●
192-P+	19.2	11.00	4.01	6.99	0.81	19	●
193-P+	19.3	11.00	4.02	6.98	0.81	19	●
194-P+	19.4	11.00	4.03	6.97	0.81	19	●
195-P+	19.5	11.00	4.05	6.95	0.81	19	●
196-P+	19.6	11.00	4.06	6.94	0.81	19	●
197-P+	19.7	11.00	4.07	6.93	0.81	19	●
198-P+	19.8	11.00	4.09	6.91	0.81	19	●
199-P+	19.9	11.00	4.10	6.90	0.81	19	●
200-P+	20.0	11.60	4.15	7.45	0.81	20	●
201-P+	20.1	11.60	4.16	7.44	0.81	20	●
202-P+	20.2	11.60	4.18	7.42	0.81	20	●
205-P+	20.5	11.60	4.22	7.38	0.81	20	●
206-P+	20.6	11.60	4.23	7.37	0.81	20	●
207-P+	20.7	11.60	4.24	7.36	0.81	20	●
210-P+	21.0	12.18	4.32	7.86	0.81	21	●
212-P+	21.2	12.18	4.35	7.83	0.81	21	●
213-P+	21.3	12.18	4.36	7.82	0.81	21	●
214-P+	21.4	12.18	4.37	7.81	0.81	21	●
215-P+	21.5	12.18	4.39	7.79	0.81	21	●
218-P+	21.8	12.18	4.43	7.75	0.81	21	●
220-P+	22.0	12.76	4.50	8.26	0.81	22	●
225-P+	22.5	12.76	4.57	8.19	0.81	22	●
229-P+	22.9	12.76	4.62	8.14	0.81	22	●
230-P+	23.0	13.33	4.67	8.66	0.81	23	●
235-P+	23.5	13.33	4.74	8.59	0.81	23	●
240-P+	24.0	13.90	4.84	9.06	0.81	24	●
245-P+	24.5	13.90	4.91	8.99	0.81	24	●
250-P+	25.0	14.50	5.01	9.49	0.81	25	●
254-P+	25.4	14.50	5.06	9.44	0.81	25	●
255-P+	25.5	14.50	5.08	9.42	0.81	25	●
256-P+	25.6	14.50	5.09	9.41	0.81	25	●
257-P+	25.7	14.50	5.10	9.40	0.81	25	●

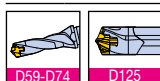

► SSC: Seat size code

●: Standard items

Drill heads for flat bottom hole

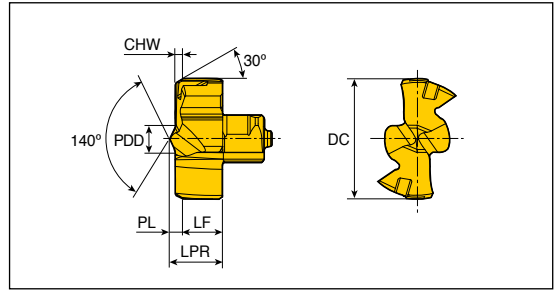

Designation	Dimension (mm)							Grade TT9080
	DC	PDD	LPR	PL	LF	CHW	SSC	
TCD - 080-F	8.0	2.33	4.4	1.09	3.3	0.7	8	●
085-F	8.5	2.33	4.4	1.09	3.3	0.7	8	●
090-F	9.0	2.29	4.6	1.11	3.5	0.7	9	●
095-F	9.5	2.29	4.6	1.11	3.5	0.7	9	●
100-F	10.0	2.44	4.9	1.17	3.7	0.7	10	●
105-F	10.5	2.44	4.9	1.17	3.7	0.7	10	●
110-F	11.0	3.09	5.1	1.25	3.8	0.7	11	●
115-F	11.5	3.09	5.1	1.25	3.8	0.7	11	●
120-F	12.0	2.95	5.4	1.26	4.1	0.7	12	●
125-F	12.5	2.95	5.4	1.26	4.1	0.7	12	●
130-F	13.0	3.04	5.7	1.30	4.4	0.7	13	●
135-F	13.5	3.04	5.7	1.30	4.4	0.7	13	●
140-F	14.0	3.30	6.1	1.31	4.8	0.7	14	●
145-F	14.5	3.30	6.1	1.31	4.8	0.7	14	●
150-F	15.0	3.54	6.6	1.35	5.23	0.7	15	●
155-F	15.5	3.54	6.6	1.35	5.23	0.7	15	●
160-F	16.0	3.74	7.0	1.39	5.6	0.7	16	●
165-F	16.5	3.74	7.0	1.39	5.6	0.7	16	●
170-F	17.0	3.75	7.3	1.40	5.9	0.7	17	●
175-F	17.5	3.75	7.3	1.40	5.9	0.7	17	●
180-F	18.0	3.85	7.6	1.42	6.18	0.7	18	●
185-F	18.5	3.85	7.6	1.42	6.18	0.7	18	●
190-F	19.0	3.86	7.9	1.44	6.5	0.7	19	●
195-F	19.5	3.86	7.9	1.44	6.5	0.7	19	●
200-F	20.0	6.76	9.3	1.77	7.5	0.7	20	●
205-F	20.5	6.76	9.3	1.77	7.5	0.7	20	●
210-F	21.0	6.98	9.7	1.79	7.9	0.7	21	●
215-F	21.5	6.98	9.7	1.79	7.9	0.7	21	●
220-F	22.0	7.42	10.0	1.81	8.2	0.7	22	●
225-F	22.5	7.42	10.0	1.81	8.2	0.7	22	●
230-F	23.0	7.60	10.4	1.83	8.6	0.7	23	●
235-F	23.5	7.60	10.4	1.83	8.6	0.7	23	●
240-F	24.0	8.13	10.9	1.86	9.0	0.7	24	●
245-F	24.5	8.13	10.9	1.86	9.0	0.7	24	●
250-F	25.0	8.16	11.3	1.89	9.4	0.7	25	●

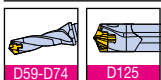

► SSC: Seat size code

●: Standard items

Chamfering inserts for pre-thread hole

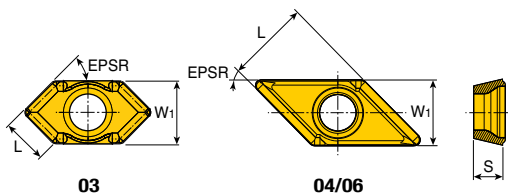

Size	Dimension (mm)			
	W1	L	S	EPSR
03-C30	4.0	4.00	1.59	30
03-C45	4.0	2.80	1.59	45
04-C45	3.6	5.20	1.80	45
06-C45	4.5	5.66	1.96	45

Insert	Designation	Coated						Uncoated	
		TT9080	TT9030	TT8020	TT6030	TT9300	TT7400		
	AOMT 030204-C30	●						K10	
	030204-C45	●							
	AOMT 040204-C45	●							
	060204-C45	●							



●: Standard items

CRNG 0802-45CD

Chamfering inserts for chamfering ring

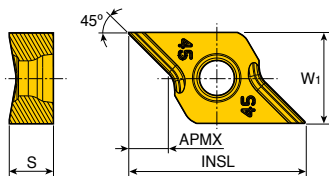

Size	Dimension (mm)			
	W1	INSL	S	APMX
08	7.5	14.80	3.65	3.3

Insert	Designation	Coated						Uncoated	
		TT9080	TT9030	TT8020	TT6030	TT9300	TT7400		
	CRNG 0802-45CD	●						K10	



●: Standard items

TCD...P-CO+

Drill heads

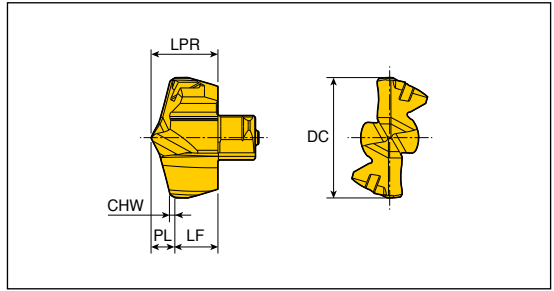

Designation	Dimension (mm)						Grade
	DC	LPR	PL	LF	CHW	SSC	TT9080
TCD-159-P-CO+	15.9	8.73	3.17	5.56	0.7	15	●
169-P-CO+	16.9	9.30	3.34	5.96	0.81	16	●
179-P-CO+	17.9	9.90	3.50	6.40	0.81	17	●
189-P-CO+	18.9	10.50	3.66	6.84	0.81	18	●
199-P-CO+	19.9	11.00	3.82	7.18	0.81	19	●
209-P-CO+	20.9	11.60	3.98	7.62	0.81	20	●
219-P-CO+	21.9	12.18	4.15	8.03	0.81	21	●
229-P-CO+	22.9	12.76	4.31	8.45	0.81	22	●
239-P-CO+	23.9	13.33	4.48	8.85	0.81	23	●
249-P-CO+	24.9	13.90	4.64	9.26	0.81	24	●
259-P-CO+	25.9	14.50	4.81	9.69	0.81	25	●



► SSC: Seat size code

●: Standard items

SPGX...DW

Inserts

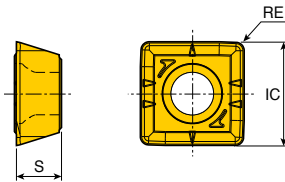

Size	Dimension (mm)			
	IC	S	RE	
06	6.07	2.38	0.4	
07	8.02	3.97	0.8	
09	9.91	4.30	0.8	
11	11.62	4.80	0.8	
14	14.41	5.20	1.2	

Insert	Designation	Coated						Uncoated	
		TT9080	TT8020	TT9300	TT9030	TT6030	TT7400	K10	
	SPGX 060204 DW	●							
	07T308 DW	●							
	090408 DW	●							
	110408 DW	●							
	140512 DW	●							



●: Standard items

Drill heads

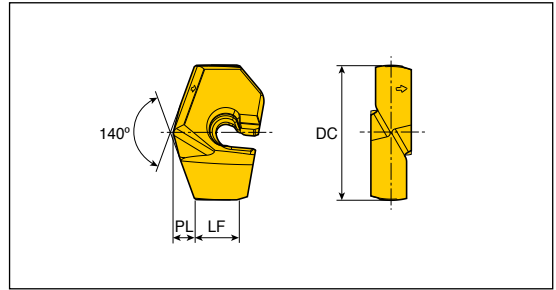

Designation	Dimension (mm)				Grade TT9080
	DC	PL	LF	SSC	
LCD- 200-P	20.0	3.11	6.54	20	●
205-P	20.5	3.20	6.45	20	●
210-P	21.0	3.29	6.36	21	●
215-P	21.5	3.38	6.27	21	●
220-P	22.0	3.42	7.12	22	●
225-P	22.5	3.51	7.03	22	●
230-P	23.0	3.60	6.94	23	●
235-P	23.5	3.69	6.85	23	●
240-P	24.0	3.73	7.03	24	●
245-P	24.5	3.82	6.94	24	●
250-P	25.0	3.91	6.85	25	●
255-P	25.5	4.00	6.76	25	●
260-P	26.0	4.04	7.51	26	●
265-P	26.5	4.13	7.42	26	●
270-P	27.0	4.22	7.33	27	●
275-P	27.5	4.31	7.24	27	●
280-P	28.0	4.35	7.39	28	●
285-P	28.5	4.44	7.30	28	●
290-P	29.0	4.53	7.21	29	●
295-P	29.5	4.62	7.12	29	●
300-P	30.0	4.67	9.47	30	●
305-P	30.5	4.76	9.38	30	●
310-P	31.0	4.85	9.29	31	●
315-P	31.5	4.94	9.20	31	●
320-P	32.0	4.98	9.55	32	●
325-P	32.5	5.07	9.46	32	●
330-P	33.0	5.16	9.37	33	●
335-P	33.5	5.25	9.28	33	●
340-P	34.0	5.34	9.19	34	●
345-P	34.5	5.44	9.10	34	●
350-P	35.0	5.44	11.12	35	●
355-P	35.5	5.53	11.03	35	●
360-P	36.0	5.62	10.94	36	●
365-P	36.5	5.71	10.85	36	●
370-P	37.0	5.80	10.76	37	●



► SSC: Seat size code

●: Standard items

LCD...-P+

Self-centering drill head

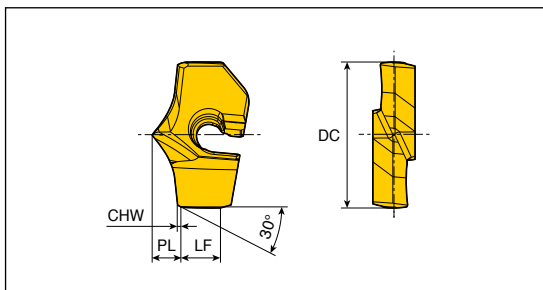

Designation	Dimension (mm)					Grade
	DC	PL	LF	CHW	SSC	
LCD- 200-P+	20.0	4.55	5.83	0.86	20	●
205-P+	20.5	4.58	5.60	0.86	20	●
210-P+	21.0	4.60	5.36	0.86	21	●
215-P+	21.5	4.63	5.13	0.86	21	●
220-P+	22.0	4.92	6.21	0.86	22	●
225-P+	22.5	4.95	5.98	0.86	22	●
230-P+	23.0	4.97	5.74	0.86	23	●
235-P+	23.5	5.00	5.51	0.86	23	●
240-P+	24.0	5.30	5.93	0.86	24	●
245-P+	24.5	5.33	5.70	0.86	24	●
250-P+	25.0	5.35	5.46	0.86	25	●
255-P+	25.5	5.38	5.23	0.86	25	●
260-P+	26.0	5.67	7.39	0.86	26	●
265-P+	26.5	5.70	7.16	0.86	26	●
270-P+	27.0	5.72	6.92	0.86	27	●
275-P+	27.5	5.75	6.69	0.86	27	●
280-P+	28.0	5.73	7.26	0.86	28	●
285-P+	28.5	5.76	7.03	0.86	28	●
290-P+	29.0	5.78	6.79	0.86	29	●
295-P+	29.5	5.81	6.56	0.86	29	●
300-P+	30.0	6.08	9.17	0.86	30	●
305-P+	30.5	6.11	8.94	0.86	30	●
310-P+	31.0	6.13	8.70	0.86	31	●
315-P+	31.5	6.16	8.47	0.86	31	●
320-P+	32.0	6.43	9.18	0.86	32	●
325-P+	32.5	6.46	8.95	0.86	32	●
330-P+	33.0	6.48	8.71	0.86	33	●
335-P+	33.5	6.51	8.48	0.86	33	●
340-P+	34.0	6.53	8.24	0.86	34	●
345-P+	34.5	6.56	8.01	0.86	34	●



► SSC: Seat size code

●: Standard items

Drill heads for flat bottom hole

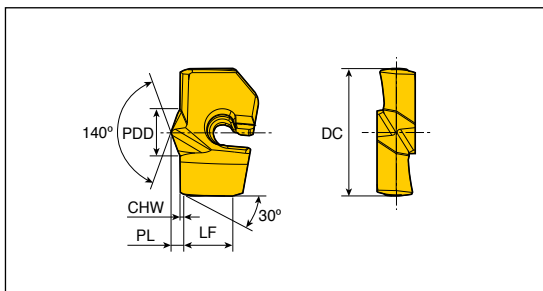

Designation	Dimension (mm)						Grade
	DC	PL	LF	CHW	SSC	PDD	TT9080
LCD - 200-F	20.0	2.18	7.63	0.7	20	8.3	●
205-F	20.5	2.18	7.63	0.7	20	8.3	●
210-F	21.0	2.18	7.63	0.7	21	8.3	●
215-F	21.5	2.18	7.63	0.7	21	8.3	●
220-F	22.0	2.38	8.17	0.7	22	9.0	●
225-F	22.5	2.38	8.17	0.7	22	9.0	●
230-F	23.0	2.38	8.17	0.7	23	9.0	●
235-F	23.5	2.38	8.17	0.7	23	9.0	●
240-F	24.0	2.52	8.10	0.7	24	10.0	●
245-F	24.5	2.52	8.10	0.7	24	10.0	●
250-F	25.0	2.52	8.10	0.7	25	10.0	●
255-F	25.5	2.52	8.10	0.7	25	10.0	●
260-F	26.0	2.48	9.84	0.7	26	10.5	●
265-F	26.5	2.48	9.84	0.7	26	10.5	●
270-F	27.0	2.48	9.84	0.7	27	10.5	●
275-F	27.5	2.48	9.84	0.7	27	10.5	●
280-F	28.0	2.72	9.50	0.7	28	11.6	●
285-F	28.5	2.72	9.50	0.7	28	11.6	●
290-F	29.0	2.72	9.50	0.7	29	11.6	●
295-F	29.5	2.72	9.50	0.7	29	11.6	●
300-F	30.0	2.80	11.63	0.7	30	12.4	●
305-F	30.5	2.80	11.63	0.7	30	12.4	●
310-F	31.0	2.80	11.63	0.7	31	12.4	●
315-F	31.5	2.80	11.63	0.7	31	12.4	●
320-F	32.0	3.13	11.59	0.7	32	13.6	●
325-F	32.5	3.13	11.59	0.7	32	13.6	●
330-F	33.0	3.13	11.59	0.7	33	13.6	●
335-F	33.5	3.13	11.59	0.7	33	13.6	●
340-F	34.0	3.13	11.59	0.7	34	13.6	●
345-F	34.5	3.13	11.59	0.7	34	13.6	●
350-F	35.0	3.31	13.20	0.7	35	14.6	●
355-F	35.5	3.31	13.20	0.7	35	14.6	●
360-F	36.0	3.31	13.20	0.7	36	14.6	●
365-F	36.5	3.31	13.20	0.7	36	14.6	●
370-F	37.0	3.31	13.20	0.7	37	14.6	●



▶ SSC: Seat size code

●: Standard items



XCGT ...-C

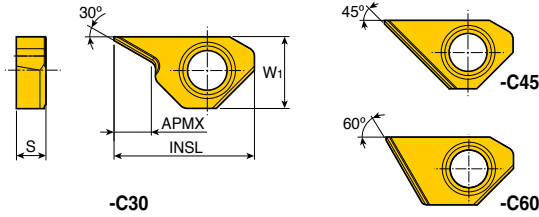

Chamfering inserts for T-CHAMFER holder



Size	Dimension (mm)			
	W1	INSL	S	APMX
06-C30	6.18	12.3	2.8	3.49
09-C30	8.50	16.0	3.3	4.43
06-C45	6.18	12.3	2.8	5.89
09-C45	8.50	16.0	3.3	8.07
06-C60	6.18	12.3	2.8	3.43
09-C60	8.50	16.0	3.3	4.78

Insert	Designation	Coated						Uncoated	
		TT9080	TT9030	TT8020	TT6030	TT9300	TT7400		K10
	XCGT 0603-C30	•							
	0903-C30	•							
	XCGT 0603-C45	•							
	0903-C45	•							
	XCGT 0603-C60	•							
	0903-C60	•							

• Standard items



XCGT...TA



Inserts

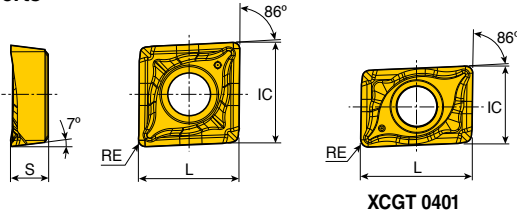

Size	Dimension (mm)			
	IC	L	S	RE
04	4.4	6.4	1.70	0.4
05	5.6	5.6	2.10	0.4
06	6.4	6.4	2.38	0.4
07	7.5	7.5	3.18	0.4
08	8.4	8.4	3.18	0.4
10	10.5	10.5	3.97	0.4
13	13.4	13.4	4.76	0.4
17	17.5	17.5	5.56	0.8

XCGT 0401

• For aluminum alloy

Insert	Designation	Turning		Drilling	Coated					Uncoated	
		ap (mm)	Feed (mm/rev)	Feed (mm/rev)	TT9080	TT8020	TT9300	TT9030	TT6030	TT7400	K10
<p>Right hand shown (XCGT 0401)</p>	XCGT 040104R TA	0.2-1.8	0.02-0.15	0.02-0.09							•
	040104L TA	0.2-1.8	0.02-0.15	0.02-0.09							•
	050204 TA	0.2-2.2	0.03-0.18	0.02-0.11							•
	060204 TA	0.3-2.5	0.03-0.20	0.03-0.12							•
	070304 TA	0.4-2.8	0.05-0.22	0.03-0.13							•
	080304 TA	0.4-3.2	0.06-0.25	0.03-0.13							•
	10T304 TA	0.5-3.5	0.06-0.30	0.03-0.13							•
	130404 TA	0.6-4.3	0.08-0.33	0.03-0.13							•
170508 TA	0.7-5.3	0.10-0.38	0.03-0.13							•	

•: Standard items



XCMT..R-GV



Inserts

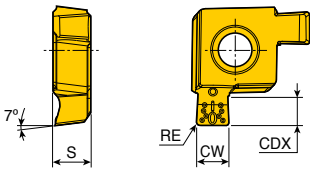

Size	Dimension (mm)			
	CW	CDX	S	RE
05	2.0	1.8	2.27	0.2
06	2.0	2.0	2.62	0.2
07	2.5	2.0	3.42	0.2
08	2.5	2.5	3.50	0.2
10	3.0	3.0	4.37	0.3
13	3.5	3.5	5.24	0.3
17	4.0	4.0	6.06	0.4

• For grooving

Insert	Designation	Coated						Uncoated
		TT9080	TT8020	TT9300	TT9030	TT6030	TT7400	K10
	XCMT 05R-200020GV	•	•					
	06R-200020GV	•	•					
	07R-250020GV	•	•					
	08R-250020GV	•	•					
	10R-300030GV	•	•					
	13R-350030GV	•	•					
17R-400040GV	•	•						

► Grooving insert is available only for right handed type

•: Standard items



NPHT...R-G-P/R-HF-P



Inserts for TBTA-FB & TRGD3

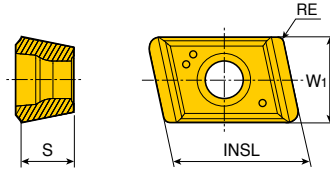

Size	Dimension (mm)			
	W1	INSL	S	RE
06	6.0	8	3.0	0.4/0.8
08	7.5	10	4.0	0.4/0.8
09	9.0	10	4.0	0.4/0.8
11	11.0	10	4.0	0.4/0.8
13	13.0	10	4.0	0.4/0.8

Insert	Designation	Pocket			Coated						Uncoated			
		Center	Inner	Outer	TT9030	TT9130	TT8125	TT7200	TT6130	TT6020	TT5100	TT5030	K10	
	NPHT 060304R-G-P			●					●			●		
	060308R-G-P			●	●	●			●			●		
	060308R-HF-P			●	●	●			●			●		
	080404R-G-P			●	●				●			●		
	080408R-G-P			●	●	●			●			●		
	080408R-HF-P			●	●	●			●			●		
	090404R-G-P			●	●				●			●		
	090408R-G-P			●	●	●			●			●		
	090408R-HF-P			●	●	●			●			●		
	110404R-G-P			●	●				●			●		
	110408R-G-P			●	●	●			●			●		
	110408R-HF-P			●	●	●			●			●		
	130404R-G-P			●	●				●			●		
	130408R-G-P			●	●	●			●			●		
130404R-HF-P			●	●	●			●			●			



●: Standard items

NPMT...L-G-C/L-HF-C



Inserts for TBTA-FB & TRGD

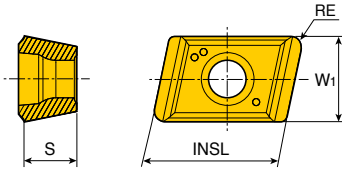

Size	Dimension (mm)			
	W1	INSL	S	RE
06	5.5	8	3.0	0.8
07	6.5	10	4.0	0.8
08	8.0	10	4.0	0.8
10	10.0	10	4.0	0.8
13	12.5	10	4.0	0.8

Insert	Designation	Pocket			Coated						Uncoated			
		Center	Inner	Outer	TT9030	TT9130	TT8125	TT7200	TT6130	TT6020	TT5100	TT5030	K10	
	NPMT 060308L-G-C	●			●	●	●		●			●		
	060308L-HF-C	●			●	●	●		●			●		
	070408L-G-C	●			●	●	●		●			●		
	070408L-HF-C	●			●	●	●		●			●		
	080408L-G-C	●			●	●	●		●			●		
	080408L-HF-C	●			●	●	●		●			●		
	100408L-G-C	●			●	●	●		●			●		
	100408L-HF-C	●			●	●	●		●			●		
	130408L-G-C	●			●	●	●		●			●		
	130408L-HF-C	●			●	●	●		●			●		

●: Standard items

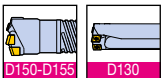

NPMT...R-G-I/R-HF-I



Inserts for TBTA-FB & TRGD

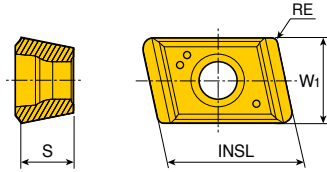

Size	Dimension (mm)			
	W ₁	INSL	S	RE
06	5.5	8	3.0	0.4
07	6.5	10	4.0	0.4
08	8.0	10	4.0	0.4
10	10.0	10	4.0	0.4
13	12.5	10	4.0	0.4

Insert	Designation	Pocket			Coated							Uncoated		
		Center	Inner	Outer	TT9030	TT9130	TT8125	TT7200	TT6130	TT6020	TT5100	TT5030	K10	
	NPMT 060304R-G-I		●		●	●	●	●			●			
	060304R-HF-I		●		●	●	●	●			●			
	070404R-G-I		●		●	●	●	●			●			
	070404R-HF-I		●		●	●	●	●			●			
	080404R-G-I		●		●	●	●	●			●			
	080404R-HF-I		●		●	●	●	●			●			
	100404R-G-I		●		●	●	●	●			●			
	100404R-HF-I		●		●	●	●	●			●			
	130404R-G-I		●		●	●	●	●			●			
	130404R-HF-I		●		●	●	●	●			●			

●: Standard items

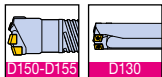

NPMX...R-B/R-G



Inserts for TBTA...3/5/7/9

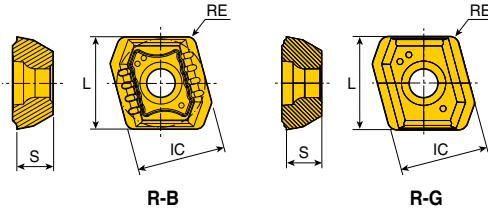

Size	Dimension (mm)			
	IC	L	S	RE
08	8.0	8.36	3.18	0.8

Insert	Designation	Pocket			Coated					Uncoated		
		Center	Inner	Outer	TT9030	TT8125	TT7200	TT6130	TT6020	TT5100	TT5030	K10
	NPMX 080308R-B	●	●	●	●	●		●				
	080308R-G	●	●	●	●	●			●	●		



●: Standard items

TPMX...R-B/R-G



Inserts for TBTA...3/5/7/9 & TBTA-R

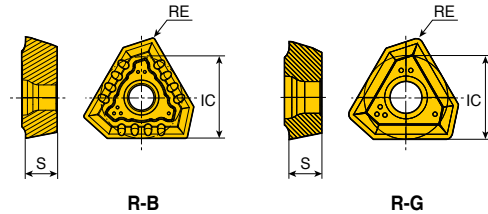

Size	Dimension (mm)		
	IC	S	RE
140304 R-B	8.45	3.5	0.4
140308 R-B/R-G	8.45	3.5	0.8
170404 R-B	10.30	4.0	0.4
170408 R-B/R-G	10.30	4.0	0.8
240504 R-B	14.20	5.5	0.4
240512 R-B/R-G	14.20	5.5	1.2
280708 R-B	17.00	7.5	0.8
280716 R-B/R-G	17.00	7.5	1.6

Insert	Designation	Pocket			Coated					Uncoated			
		Center	Inner	Outer	TT9030	TT9130	TT8125	TT7200	TT6130	TT6020	TT5100	TT5030	K10
	TPMX 140304R-B	●	●	●	●		●						
	140308R-B	●	●	●		●					●		
	140308R-G	●	●	●	●	●	●			●	●	●	
	170404R-B	●	●	●	●		●		●				
	170408R-B	●	●	●		●						●	
	170408R-G	●	●	●	●	●	●			●	●	●	
	240504R-B	●	●	●	●		●		●				
	240512R-B	●	●	●		●						●	
	240512R-G	●	●	●	●	●	●			●	●	●	
	280708R-B	●	●	●	●				●				
	280716R-B	●	●	●		●						●	
280716R-G	●	●	●	●	●	●	●		●	●	●		



●: Standard items

ZSGT



Deep drilling inserts with single chip splitting cutting edge and a wiper for high hole surface quality

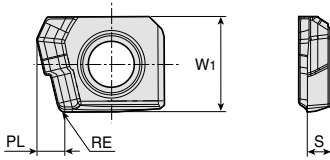

Size	Dimension (mm)			
	W1	RE	PL	S
06	6.00	0.40	1.80	1.50

Insert	Designation	Coated							Uncoated		
		TT9030	TT9130	TT8125	TT7200	TT6130	TT6020	TT5100	TT5030	K10	
	ZSGT 060204R-RS		●								



●: Standard items

LOGT



Deep drilling inserts with 2 chip splitting cutting edges, positive rake chipbreaker and a wiper for high hole surface quality

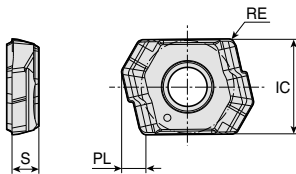

Size	Dimension (mm)			
	IC	RE	PL	S
06	7.00	0.40	1.80	2.00

Insert	Designation	Coated							Uncoated		
		TT9030	TT9130	TT8125	TT7200	TT6130	TT6020	TT5100	TT5030	K10	
	LOGT 060204R-RS		●	●							



●: Standard items

D127, D131

Inserts for TBTA-TR & TRGD

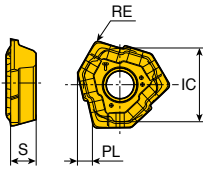

Fig.1

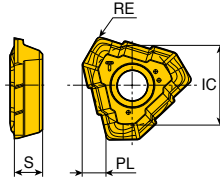

Fig.2

Size	Dimension (mm)			
	IC	PL	S	RE
07	7.69	2.0	2.3	0.4
08	8.32	2.2	2.8	0.5
09	8.55	3.0	3.0	0.5
10	9.23	3.2	3.3	0.5
11	10.40	3.4	3.8	0.5
12	11.59	3.7	4.3	0.5
13	12.85	4.6	4.8	0.8
14	16.85	5.4	5.3	1.0

Insert	Designation	Fig.	Coated						Uncoated		
			TT9030	TT8125	TT7200	TT6130	TT6020	TT5100	TT5030	K10	
	TOGT 070304 RS	1	●								
	070304 GF	1	●								
	080305 RS	1	●								
	080305 GF	1	●								
	090305 RS	2	●								
	090305 GF	2	●								
	100305 RS	2	●								
	100305 GF	2	●								
	110405 RS	2	●								
	110405 GF	2	●								
	120405 RS	2	●								
	120405 GF	2	●								
	130408 RS	2	●								
	130408 GF	2	●								
	140510 RS	2	●								



- ▶ RS: First choice for general purpose
- ▶ GF: Exotic materials

●: Standard items

TPMX...LG



Inserts for TBTA-R

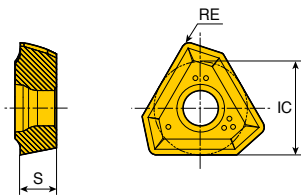

Size	Dimension (mm)			
	IC	S	RE	
14	8.45	3.5	0.8	
17	10.30	4.0	0.8	
24	14.20	5.5	1.2	

Insert	Designation	Pocket			Coated						Uncoated			
		Center	Inner	Outer	TT9030	TT9130	TT8125	TT7200	TT6130	TT6020	TT5100	TT5030	K10	
	TPMX 140308 LG			•	•						•			
	170408 LG			•	•	•				•	•			
	240512 LG			•	•	•				•	•			



•: Standard items

XPMT...-45



Inserts for TBTA-R

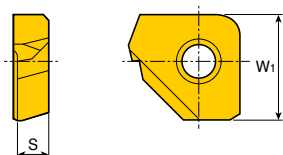

Size	Dimension (mm)		
	W1	S	
16	9.5	2.70	

Insert	Designation	Pocket			Coated						Uncoated		
		Center	Inner	Outer	TT9030	TT8125	TT7100	TT3500	TT6020	TT9300	TT7400	K10	
	XPMT 16002-45			•	•								



•: Standard items

Pad for TBTA 3.../5.../7.../9...

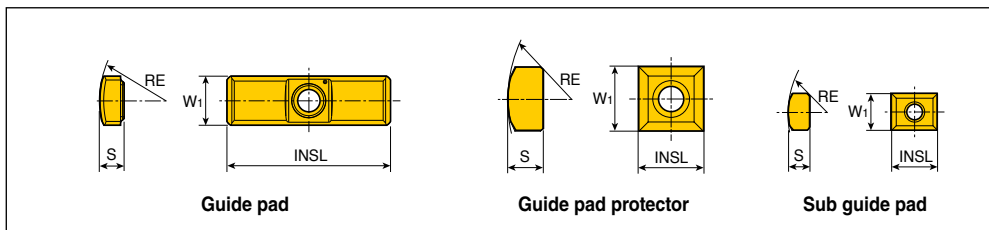

Designation	Dimension (mm)				Screw	
	W1	S	INSL	RE		
Guide pad	PAD - GP08-25-155-DC-SB	8	4.5	25	15.5	CSTB3S
	GP08-25-155-DC-SC	8	4.5	25	15.5	CSTB3S
	GP10-35-200-DC-SB	10	6.0	35	20.0	CSTB4S
	GP10-35-200-DC-SC	10	6.0	35	20.0	CSTB4S
	GP14-40-250-DC-SB/SC	14	7.5	40	25.0	CSTA5S
	GP18-40-300-DC-SB/SC	18	9.0	40	30.0	LS1206S
Guide pad protector	PAD - P08	8	4.5	8	17.5	CSTB3S
	P10	10	6.0	10	20.0	CSTB4S
	P14	14	7.5	14	25.0	CSTA5S
	P18	18	9.0	18	30.0	LS1206S
	Sub guide pad	PAD - S08	8	4.5	10	17.5
S10		10	5.0	10	29.0	CSTB3S
S14		14	7.0	20	45.0	CCSTA5S



Plus Guide Pad for TBTA 3.../5.../7.../9...

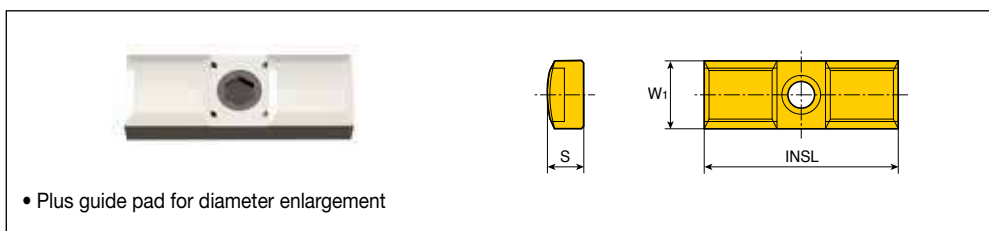

Designation								
DC	PAD-GC08	S	PAD-GC10	S	PAD-GC14	S	PAD-GC18	S
DC+1mm	PAD-GC08-DC+1	5.0	PAD-GC10-DC+1	6.5	PAD-GC14-DC+1	8.0	PAD-GC18-DC+1	9.5
DC+2mm	PAD-GC08-DC+2	5.5	PAD-GC10-DC+2	7.0	PAD-GC14-DC+2	8.5	PAD-GC18-DC+2	10.0
DC+3mm	PAD-GC08-DC+3	6.0	PAD-GC10-DC+3	7.5	PAD-GC14-DC+3	9.0	PAD-GC18-DC+3	10.5
DC+4mm	-	-	PAD-GC10-DC+4	8.0	PAD-GC14-DC+4	9.5	PAD-GC18-DC+4	11.0
DC+5mm	-	-	-	-	PAD-GC14-DC+5	10.0	PAD-GC18-DC+5	11.5



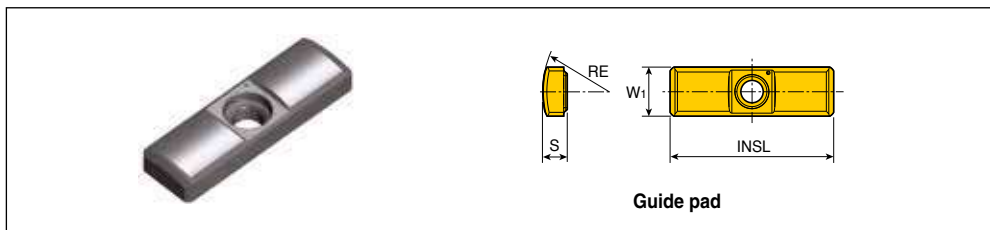

Guide pad

Designation	Dimension (mm)				Screw
	W1	S	INSL	RE	
Guide pad PAD - GP06-20-120-DC-SB	6	3.0	20	12.0	CSTB2.2S
GP06-20-120-DC-SC	6	3.0	20	12.0	CSTB2.2S
GP07-20-120-DC-SB	7	3.5	20	12.0	CSTB3S
GP07-20-120-DC-SC	7	3.5	20	12.0	CSTB3S
GP08-25-155-DC-SB	8	4.5	25	15.5	CSTB3S
GP08-25-155-DC-SC	8	4.5	25	15.5	CSTB3S
GP10-30-200-DC-SB	10	4.5	30	20.0	CSTB3.5
GP10-30-200-DC-SC	10	4.5	30	20.0	CSTB3.5
GP12-35-250-DC-SB	12	5.5	35	25.0	CSTB3.5
GP12-35-250-DC-SC	12	5.5	35	25.0	CSTB3.5



D150-D155

Pad for TBTA-R

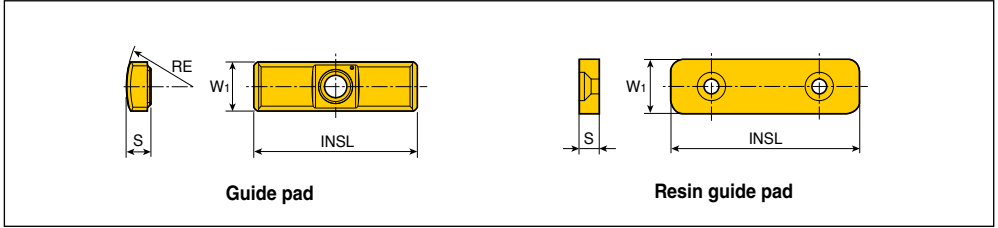

Designation		Dimension (mm)				Screw
		W1	S	INSL	RE	
Guide pad	PAD - GP08-25-155-DC-SB	8	4.5	25	15.5	CSTB3S
	GP08-25-155-DC-SC	8	4.5	25	15.5	CSTB3S
	GP10-35-200-DC-SB	10	6.0	35	20.0	CSTB4S
	GP10-35-200-DC-SC	10	6.0	35	20.0	CSTB4S
	GP14-40-250-DC-SB	14	7.5	40	25.0	CSTA5S
	GP14-40-250-DC-SC	14	7.5	40	25.0	CSTA5S
	GP18-40-300-DC-SB	18	9.0	40	30.0	LS1206S
	GP18-40-300-DC-SC	18	9.0	40	30.0	LS1206S
Resin guide pad	PAD - R10	10	4.0	40	-	LS0902.5-6
	R12	12	5.0	45	-	LS0903-8
	R15	15	5.8	50	-	LS0904-10
	R20	20	7.5	70	-	LS0905-12
	R30	30	12.5	80	-	LS0906-15
	R35	35	15.5	100	-	LS0906-15



Cartridge for TBTA 3.../5.../7.../9

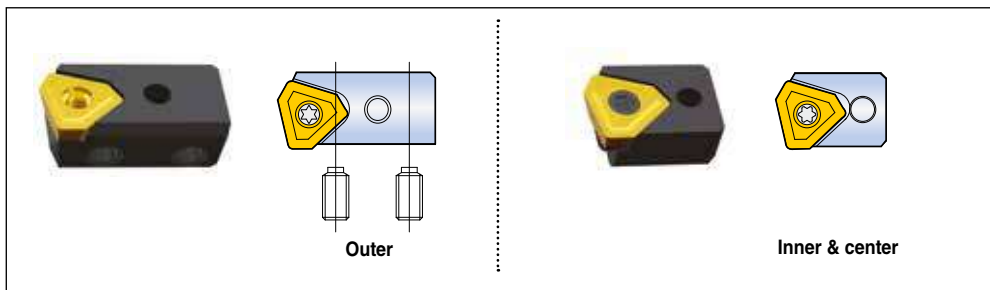

	Designation	Adjust screw	Wrench	Lock screw	Wrench	Insert
Outer	PERC 05R	AS0003-5	H1.5	LS1803RH	H2	NPMX0803..
	402-04	AS0004-8	H2	LS1803.5RH	H2.5	TPMX1403..
	402-32	AS0005-10	H2.5	LS1805RH	H3	TPMX1704..
	402-43	AS0005-15	H2.5	L1806RH	H4	TPMX2405..
	402-63	AS0006-15	H3	L1806RH	H4	TPMX2807..
Inner & center	CENC 05R	-	-	CSTB3	T9	NPMX0803..
	402-04	-	-	CSTB3.5	T15	TPMX1403..
	402-32	-	-	CSTA5	T15	TPMX1704..
	402-43	-	-	LS1206	H3	TPMX2405..
	402-63	-	-	LS1206	H3	TPMX2807..



Plus Cartridge for TBTA 3.../5.../7.../9



Designation					
DC	DC+1mm	DC+2mm	DC+3mm	DC+4mm	DC+5mm
PERC 05R	PERC 05R+1	PERC 05R+2	-	-	-
PERC 402-04	PERC 402-04+1	PERC 402-04+2	PERC 402-04+3	-	-
PERC 402-32	PERC 402-32+1	PERC 402-32+2	PERC 402-32+3	PERC 402-32+4	-
PERC 402-43	PERC 402-43+1	PERC 402-43+2	PERC 402-43+3	PERC 402-43+4	PERC 402-43+5
PERC 402-63	PERC 402-63+1	PERC 402-63+2	PERC 402-63+3	PERC 402-63+4	PERC 402-63+5



Cartridge for TBTA-R

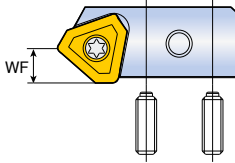

Accurate tolerance applications

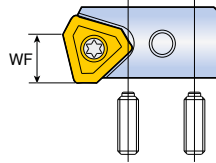

Open tolerance applications

Designation		WF (mm)	Adjust screw	Wrench	Lock screw	Wrench	Insert
Accurate tolerance applications	PERC P04R	5	AS0004-8	H2	LS1803.5RH	H2.5	TPMX1403..LG
	P32R	6	AS0005-10	H2.5	LS1805RH	H3	TPMX1704..LG
	P43R	8	AS0005-15	H2.5	LS1806RH	H4	TPMX2405..LG
Open tolerance applications	PERC 402-04	8	AS0004-8	H2	LS1803.5RH	H2.5	TPMX1403..RG
	402-32	9	AS0005-10	H2.5	LS1805RH	H3	TPMX1704..RG
	402-43	13	AS0005-15	H2.5	LS1806RH	H4	TPMX2405..RG



► PERC-P and PERC 402-□□ cartridges are interchangeable in the same pocket

D156-D161

Guide pad for TNDH-TP

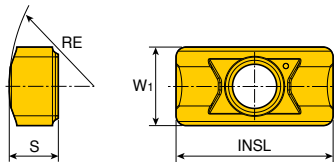

Designation	Dimension (mm)				Screw	Grade TT9030
	W1	S	INSL	RE		
PAD-G04-08	4	2.5	8	9	TS 20043I/HG-P	●



► Guide pad is sold separately from drill heads

●: Standard items

D75-D76

Recommended Cutting Conditions



Machining data for TOP-DRILL 2,3,4xD

ISO	Material	Condition	Tensile strength (N/mm ²)	Hardness HB	Material No.	Cutting speed Vc (m/min)	
P	Non-alloy steel, cast steel, free cutting steel	<0.25%C	Annealed	420	125	1	220-350
		>=0.25%C	Annealed	650	190	2	180-280
		<0.55%C	Quenched and tempered	850	250	3	140-240
		>=0.55%C	Annealed	750	220	4	140-240
			Quenched and tempered	1000	300	5	140-240
	Low alloy steel and cast steel (Less than 5% of alloying elements)	Quenched and tempered	Annealed	600	200	6	140-240
			930	275	7	100-180	
			1000	300	8	100-180	
			1200	350	9	100-180	
	High alloy steel, cast steel and tool steel	Annealed	680	200	10	140-200	
		Quenched and tempered	1100	325	11	100-160	
M	Stainless steel and cast steel	Ferritic / martensitic	680	200	12	150-250	
		Martensitic	820	240	13	150-250	
		Austenitic	600	180	14	150-250	
K	Gray cast iron (GG)	Ferritic		160	15	160-260	
		Pearlitic		250	16	160-260	
	Cast iron nodular (GGG)	Ferritic		180	17	160-260	
		Pearlitic		260	18	160-260	
	Malleable cast iron	Ferritic		130	19	120-220	
Pearlitic			230	20	120-220		
N	Aluminum - Wrought alloy	Not cureable		60	21	200-350	
		Cured		100	22	200-350	
	Aluminum-cast, alloyed	<=12% Si	Not cureable		75	23	200-350
			Cured		90	24	200-350
		>12% Si	High temp.		130	25	200-350
	Copper alloys	>1% Pb	Free cutting		110	26	150-250
		Brass			90	27	150-250
			Electrolitic copper		100	28	150-250
	Non-metallic		Duroplastics, fiber plastics		70 Shore D	29	150-250
Hard rubber				55 Shore D	30	150-250	
S	High temp. alloys	Fe based	Annealed		200	31	30-60
			Cured		280	32	30-60
		Ni or Co based	Annealed		250	33	30-60
			Cured		350	34	30-60
			Cast		320	35	30-60
	Titanium, Ti alloys	Pure	Rm 400	190	36	50-80	
Alpha+beta alloys cured		Rm 1050	310	37	50-80		
H	Hardened steel	Hardened		55HRC	38	30-60	
		Hardened		60HRC	39	30-60	
	Chilled cast iron	Cast		400	40	30-60	
	Cast iron nodular	Hardened		55HRC	41	30-60	

► For more information of material groups, see the materials & grades "material conversion table"

■ Steel
 ■ Stainless steel
 ■ Cast iron
 ■ Nonferrous
 ■ High temp. alloys
 ■ Hardened steel

Recommended Cutting Conditions



Machining data for TOP-DRILL 2,3,4xD

Feed (mm/rev) vs. drill diameter Drill length 2,3,4xD								
SOMT 04 Ø12 - Ø13.5	SOMT 05 Ø14 - Ø16	SOMT 06 Ø17 - Ø19	SOMT 07 Ø20 - Ø22	SOMT 08 Ø23 - Ø26	SOMT 09 Ø27 - Ø31	SOMT 11 Ø32 - Ø36	SOMT 13 Ø37 - Ø43	SOMT 15 Ø44 - Ø50
0.04-0.06	0.04-0.06	0.04-0.06	0.04-0.08	0.04-0.08	0.06-0.10	0.06-0.10	0.08-0.12	0.08-0.12
0.06-0.10	0.06-0.10	0.06-0.10	0.06-0.12	0.06-0.12	0.08-0.14	0.08-0.14	0.08-0.16	0.10-0.16
0.08-0.12	0.08-0.12	0.08-0.12	0.08-0.16	0.08-0.16	0.10-0.16	0.10-0.16	0.10-0.18	0.10-0.18
0.08-0.12	0.08-0.12	0.08-0.12	0.08-0.16	0.08-0.16	0.10-0.16	0.10-0.16	0.10-0.18	0.10-0.18
0.08-0.12	0.08-0.12	0.08-0.12	0.08-0.16	0.08-0.16	0.10-0.16	0.10-0.16	0.10-0.18	0.10-0.18
0.06-0.16	0.06-0.16	0.06-0.16	0.08-0.20	0.08-0.20	0.08-0.20	0.10-0.22	0.10-0.22	0.10-0.24
0.06-0.16	0.06-0.16	0.06-0.16	0.08-0.20	0.08-0.20	0.08-0.20	0.08-0.22	0.10-0.22	0.10-0.22
0.06-0.16	0.06-0.16	0.06-0.16	0.08-0.20	0.08-0.20	0.08-0.20	0.08-0.22	0.10-0.22	0.10-0.22
0.06-0.16	0.06-0.16	0.06-0.16	0.08-0.20	0.08-0.20	0.08-0.20	0.08-0.22	0.10-0.22	0.10-0.22
0.06-0.12	0.06-0.12	0.06-0.12	0.08-0.16	0.08-0.16	0.08-0.18	0.08-0.20	0.10-0.20	0.10-0.20
0.06-0.12	0.06-0.12	0.06-0.12	0.08-0.16	0.08-0.16	0.08-0.18	0.08-0.20	0.10-0.20	0.10-0.20
0.06-0.12	0.06-0.12	0.06-0.12	0.06-0.16	0.06-0.16	0.08-0.18	0.08-0.20	0.10-0.20	0.10-0.20
0.06-0.12	0.06-0.12	0.06-0.12	0.06-0.16	0.06-0.16	0.08-0.18	0.08-0.20	0.10-0.20	0.10-0.20
0.08-0.18	0.08-0.18	0.08-0.18	0.10-0.20	0.10-0.20	0.10-0.20	0.10-0.20	0.10-0.22	0.10-0.22
0.08-0.18	0.08-0.18	0.08-0.18	0.10-0.20	0.10-0.20	0.10-0.20	0.10-0.20	0.10-0.22	0.10-0.22
0.08-0.18	0.08-0.18	0.08-0.18	0.10-0.20	0.10-0.20	0.10-0.20	0.10-0.20	0.10-0.22	0.10-0.22
0.08-0.18	0.08-0.18	0.08-0.18	0.10-0.20	0.10-0.20	0.10-0.20	0.10-0.20	0.10-0.22	0.10-0.22
0.08-0.14	0.08-0.14	0.08-0.14	0.10-0.16	0.10-0.16	0.10-0.16	0.10-0.18	0.10-0.18	0.10-0.18
0.08-0.14	0.08-0.14	0.08-0.14	0.10-0.16	0.10-0.16	0.10-0.16	0.10-0.18	0.10-0.18	0.10-0.18
0.06-0.15	0.06-0.15	0.06-0.15	0.08-0.16	0.08-0.16	0.08-0.18	0.08-0.18	0.10-0.18	0.10-0.18
0.06-0.15	0.06-0.15	0.06-0.15	0.08-0.16	0.08-0.16	0.08-0.18	0.08-0.18	0.10-0.18	0.10-0.18
0.06-0.15	0.06-0.15	0.06-0.15	0.08-0.16	0.08-0.16	0.08-0.18	0.08-0.18	0.10-0.18	0.10-0.18
0.06-0.15	0.06-0.15	0.06-0.15	0.08-0.16	0.08-0.16	0.08-0.18	0.08-0.18	0.10-0.18	0.10-0.18
0.06-0.15	0.06-0.15	0.06-0.15	0.08-0.16	0.08-0.16	0.08-0.18	0.08-0.18	0.10-0.18	0.10-0.18
0.06-0.15	0.06-0.15	0.06-0.15	0.08-0.16	0.08-0.16	0.08-0.18	0.08-0.17	0.10-0.18	0.10-0.18
0.06-0.15	0.06-0.15	0.06-0.15	0.08-0.16	0.08-0.16	0.08-0.18	0.08-0.17	0.10-0.18	0.10-0.18
0.06-0.15	0.06-0.15	0.06-0.15	0.08-0.16	0.08-0.16	0.08-0.18	0.08-0.17	0.10-0.18	0.10-0.18
0.06-0.15	0.06-0.15	0.06-0.15	0.08-0.16	0.08-0.16	0.10-0.17	0.10-0.17	0.10-0.18	0.10-0.18
0.06-0.15	0.06-0.15	0.06-0.15	0.08-0.16	0.08-0.16	0.10-0.17	0.10-0.17	0.10-0.18	0.10-0.18
0.05-0.08	0.05-0.08	0.05-0.08	0.05-0.09	0.05-0.09	0.06-0.10	0.06-0.10	0.06-0.12	0.06-0.12
0.05-0.08	0.05-0.08	0.05-0.08	0.05-0.09	0.05-0.09	0.06-0.10	0.06-0.10	0.06-0.12	0.06-0.12
0.05-0.08	0.05-0.08	0.05-0.08	0.05-0.09	0.05-0.09	0.06-0.10	0.06-0.10	0.06-0.12	0.06-0.12
0.05-0.08	0.05-0.08	0.05-0.08	0.05-0.09	0.05-0.09	0.06-0.10	0.06-0.10	0.06-0.12	0.06-0.12
0.06-0.09	0.06-0.09	0.06-0.09	0.06-0.10	0.06-0.10	0.06-0.10	0.06-0.10	0.06-0.10	0.06-0.10
0.06-0.09	0.06-0.09	0.06-0.09	0.06-0.10	0.06-0.10	0.06-0.10	0.06-0.10	0.06-0.10	0.06-0.10
0.05-0.09	0.05-0.09	0.05-0.09	0.05-0.10	0.05-0.10	0.05-0.10	0.05-0.10	0.05-0.10	0.05-0.10
0.05-0.09	0.05-0.09	0.05-0.09	0.05-0.10	0.05-0.10	0.05-0.10	0.05-0.10	0.05-0.10	0.05-0.10
0.05-0.09	0.05-0.09	0.05-0.09	0.05-0.10	0.05-0.10	0.05-0.10	0.05-0.10	0.05-0.10	0.05-0.10
0.05-0.09	0.05-0.09	0.05-0.09	0.05-0.10	0.05-0.10	0.05-0.10	0.05-0.10	0.05-0.10	0.05-0.10

Recommended Cutting Conditions



Machining data for TOP-DRILL 5xD

ISO	Material	Condition	Tensile strength (N/mm ²)	Hardness HB	Material No.	Cutting speed Vc (m/min)	
P	Non-alloy steel, cast steel, free cutting steel	<0.25%C	Annealed	420	125	1	220-350
		>=0.25%C	Annealed	650	190	2	180-280
		<0.55%C	Quenched and tempered	850	250	3	140-240
		>=0.55%C	Annealed	750	220	4	140-240
			Quenched and tempered	1000	300	5	140-240
	Low alloy steel and cast steel (Less than 5% of alloying elements)	Quenched and tempered	Annealed	600	200	6	140-240
			930	275	7	100-180	
			1000	300	8	100-180	
			1200	350	9	100-180	
	High alloy steel, cast steel and tool steel	Annealed	680	200	10	140-200	
		Quenched and tempered	1100	325	11	100-160	
M	Stainless steel and cast steel	Ferritic / martensitic	680	200	12	150-250	
		Martensitic	820	240	13	150-250	
		Austenitic	600	180	14	150-250	
K	Gray cast iron (GG)	Ferritic		160	15	160-260	
		Pearlitic		250	16	160-260	
	Cast iron nodular (GGG)	Ferritic		180	17	160-260	
		Pearlitic		260	18	160-260	
	Malleable cast iron	Ferritic		130	19	120-220	
Pearlitic			230	20	120-220		
N	Aluminum - Wrought alloy	Not cureable		60	21	200-350	
		Cured		100	22	200-350	
	Aluminum-cast, alloyed	<=12% Si	Not cureable		75	23	200-350
			Cured		90	24	200-350
		>12% Si	High temp.		130	25	200-350
	Copper alloys	>1% Pb	Free cutting		110	26	150-250
		Brass			90	27	150-250
			Electrolytic copper		100	28	150-250
	Non-metallic		Duroplastics, fiber plastics		70 Shore D	29	150-250
			Hard rubber		55 Shore D	30	150-250
S	High temp. alloys	Fe based	Annealed		200	31	30-60
			Cured		280	32	30-60
		Ni or Co based	Annealed		250	33	30-60
			Cured		350	34	30-60
			Cast		320	35	30-60
	Titanium, Ti alloys	Pure	Rm 400	190	36	50-80	
Alpha+beta alloys cured		Rm 1050	310	37	50-80		
H	Hardened steel	Hardened		55HRC	38	30-60	
		Hardened		60HRC	39	30-60	
	Chilled cast iron	Cast		400	40	30-60	
	Cast iron nodular	Hardened		55HRC	41	30-60	

► For more information of material groups, see the materials & grades "material conversion table"

■ Steel
 ■ Stainless steel
 ■ Cast iron
 ■ Nonferrous
 ■ High temp. alloys
 ■ Hardened steel

Recommended Cutting Conditions



Machining data for TOP-DRILL 5xD

Feed (mm/rev) vs. drill diameter Drill length 5xD								
SOMT 04 Ø12 - Ø13.5	SOMT 05 Ø14 - Ø16	SOMT 06 Ø17 - Ø19	SOMT 07 Ø20 - Ø22	SOMT 08 Ø23 - Ø26	SOMT 09 Ø27 - Ø31	SOMT 11 Ø32 - Ø36	SOMT 13 Ø37 - Ø43	SOMT 15 Ø44 - Ø50
0.04-0.05	0.04-0.05	0.04-0.05	0.04-0.05	0.04-0.06	0.06-0.08	0.06-0.08	0.08-0.10	0.08-0.10
0.06-0.08	0.06-0.08	0.06-0.08	0.06-0.10	0.06-0.10	0.08-0.12	0.08-0.12	0.08-0.14	0.10-0.14
0.06-0.10	0.06-0.10	0.06-0.10	0.06-0.12	0.06-0.12	0.10-0.15	0.10-0.15	0.10-0.17	0.10-0.17
0.06-0.10	0.06-0.10	0.06-0.10	0.06-0.12	0.06-0.12	0.10-0.15	0.10-0.15	0.10-0.17	0.10-0.17
0.06-0.10	0.06-0.10	0.06-0.10	0.06-0.12	0.06-0.12	0.10-0.15	0.10-0.15	0.10-0.17	0.10-0.17
0.06-0.12	0.06-0.12	0.06-0.12	0.08-0.16	0.08-0.16	0.08-0.18	0.10-0.20	0.10-0.20	0.10-0.22
0.06-0.12	0.06-0.12	0.06-0.12	0.08-0.16	0.08-0.16	0.08-0.18	0.10-0.20	0.10-0.20	0.10-0.22
0.06-0.12	0.06-0.12	0.06-0.12	0.08-0.16	0.08-0.16	0.08-0.18	0.10-0.20	0.10-0.20	0.10-0.22
0.06-0.12	0.06-0.12	0.06-0.12	0.08-0.16	0.08-0.16	0.08-0.18	0.10-0.20	0.10-0.20	0.10-0.22
0.06-0.10	0.06-0.10	0.06-0.10	0.08-0.12	0.08-0.12	0.08-0.16	0.08-0.18	0.10-0.18	0.10-0.20
0.06-0.10	0.06-0.10	0.06-0.10	0.08-0.12	0.08-0.12	0.08-0.16	0.08-0.18	0.10-0.18	0.10-0.20
0.06-0.10	0.06-0.10	0.06-0.10	0.06-0.12	0.06-0.12	0.08-0.16	0.08-0.18	0.10-0.18	0.10-0.20
0.06-0.10	0.06-0.10	0.06-0.10	0.06-0.12	0.06-0.12	0.08-0.16	0.08-0.18	0.10-0.18	0.10-0.20
0.08-0.14	0.08-0.14	0.08-0.14	0.08-0.16	0.08-0.16	0.10-0.18	0.10-0.18	0.10-0.20	0.10-0.20
0.08-0.14	0.08-0.14	0.08-0.14	0.08-0.16	0.08-0.16	0.10-0.18	0.10-0.18	0.10-0.20	0.10-0.20
0.08-0.14	0.08-0.14	0.08-0.14	0.08-0.16	0.08-0.16	0.10-0.18	0.10-0.18	0.10-0.20	0.10-0.20
0.08-0.14	0.08-0.14	0.08-0.14	0.08-0.16	0.08-0.16	0.10-0.18	0.10-0.18	0.10-0.20	0.10-0.20
0.08-0.12	0.08-0.12	0.08-0.14	0.08-0.16	0.08-0.16	0.10-0.16	0.10-0.16	0.10-0.16	0.10-0.16
0.08-0.12	0.08-0.12	0.08-0.14	0.08-0.16	0.08-0.16	0.10-0.16	0.10-0.16	0.10-0.16	0.10-0.16
0.06-0.15	0.06-0.15	0.06-0.15	0.08-0.16	0.08-0.16	0.08-0.16	0.08-0.16	0.10-0.17	0.10-0.17
0.06-0.15	0.06-0.15	0.06-0.15	0.08-0.16	0.08-0.16	0.08-0.16	0.08-0.16	0.10-0.17	0.10-0.17
0.06-0.15	0.06-0.15	0.06-0.15	0.08-0.16	0.08-0.16	0.08-0.16	0.08-0.16	0.10-0.17	0.10-0.17
0.06-0.15	0.06-0.15	0.06-0.15	0.08-0.16	0.08-0.16	0.08-0.16	0.08-0.16	0.10-0.17	0.10-0.17
0.06-0.15	0.06-0.15	0.06-0.15	0.08-0.16	0.08-0.16	0.08-0.16	0.08-0.16	0.10-0.17	0.10-0.17
0.06-0.15	0.06-0.15	0.06-0.15	0.08-0.16	0.08-0.16	0.08-0.15	0.08-0.16	0.10-0.17	0.10-0.17
0.06-0.15	0.06-0.15	0.06-0.15	0.08-0.16	0.08-0.16	0.08-0.15	0.08-0.16	0.10-0.17	0.10-0.17
0.06-0.15	0.06-0.15	0.06-0.15	0.08-0.16	0.08-0.16	0.08-0.15	0.08-0.16	0.10-0.17	0.10-0.17
0.06-0.15	0.06-0.15	0.06-0.15	0.08-0.16	0.08-0.16	0.10-0.16	0.10-0.16	0.10-0.17	0.10-0.17
0.06-0.15	0.06-0.15	0.06-0.15	0.08-0.16	0.08-0.16	0.10-0.16	0.10-0.16	0.10-0.17	0.10-0.17
0.05-0.07	0.05-0.07	0.05-0.08	0.05-0.08	0.05-0.08	0.06-0.09	0.06-0.09	0.06-0.10	0.06-0.10
0.05-0.07	0.05-0.07	0.05-0.08	0.05-0.08	0.05-0.08	0.06-0.09	0.06-0.09	0.06-0.10	0.06-0.10
0.05-0.07	0.05-0.07	0.05-0.08	0.05-0.08	0.05-0.08	0.06-0.09	0.06-0.09	0.06-0.10	0.06-0.10
0.05-0.07	0.05-0.07	0.05-0.08	0.05-0.08	0.05-0.08	0.06-0.09	0.06-0.09	0.06-0.10	0.06-0.10
0.05-0.08	0.05-0.08	0.05-0.08	0.06-0.09	0.06-0.09	0.06-0.10	0.06-0.10	0.06-0.10	0.06-0.10
0.05-0.08	0.05-0.08	0.05-0.08	0.06-0.09	0.06-0.09	0.06-0.10	0.06-0.10	0.06-0.10	0.06-0.10
0.05-0.08	0.05-0.08	0.05-0.08	0.05-0.09	0.05-0.09	0.05-0.10	0.05-0.10	0.05-0.10	0.05-0.10
0.05-0.08	0.05-0.08	0.05-0.08	0.05-0.09	0.05-0.09	0.05-0.10	0.05-0.10	0.05-0.10	0.05-0.10
0.05-0.08	0.05-0.08	0.05-0.08	0.05-0.09	0.05-0.09	0.05-0.10	0.05-0.10	0.05-0.10	0.05-0.10

Recommended Cutting Conditions



Machining data for TOP-DRILL cartridge

ISO	Material	Condition	Tensile strength (N/mm ²)	Hardness HB	Material No.	Cutting speed Vc (m/min)	
P	Non-alloy steel, cast steel, free cutting steel	<0.25%C	Annealed	420	125	1	250-350
		>=0.25%C	Annealed	650	190	2	160-250
		<0.55%C	Quenched and tempered	850	250	3	140-240
		>=0.55%C	Annealed	750	220	4	140-240
			Quenched and tempered	1000	300	5	140-240
	Low alloy steel and cast steel (Less than 5% of alloying elements)	Quenched and tempered	Annealed	600	200	6	140-240
			930	275	7	100-180	
			1000	300	8	100-180	
			1200	350	9	100-180	
	High alloy steel, cast steel and tool steel	Annealed	680	200	10	140-200	
		Quenched and tempered	1100	325	11	100-160	
M	Stainless steel and cast steel	Ferritic / martensitic	680	200	12	150-250	
		Martensitic	820	240	13	150-250	
		Austenitic	600	180	14	150-250	
K	Gray cast iron (GG)	Ferritic		160	15	160-260	
		Pearlitic		250	16	160-260	
	Cast iron nodular (GGG)	Ferritic		180	17	160-260	
		Pearlitic		260	18	160-260	
	Malleable cast iron	Ferritic		130	19	120-220	
Pearlitic			230	20	120-220		
N	Aluminum - Wrought alloy	Not cureable		60	21	200-350	
		Cured		100	22	200-350	
	Aluminum-cast, alloyed	<=12% Si	Not cureable		75	23	200-350
			Cured		90	24	200-350
		>12% Si	High temp.		130	25	200-350
	Copper alloys	>1% Pb	Free cutting		110	26	150-250
		Brass			90	27	150-250
			Electrolitic copper		100	28	150-250
	Non-metallic		Duroplastics, fiber plastics		70 Shore D	29	150-250
			Hard rubber		55 Shore D	30	150-250
S	High temp. alloys	Fe based	Annealed		200	31	30-60
			Cured		280	32	30-60
		Ni or Co based	Annealed		250	33	30-60
			Cured		350	34	30-60
			Cast		320	35	30-60
	Titanium, Ti alloys	Pure	Rm 400	190	36	50-80	
Alpha+beta alloys cured		Rm 1050	310	37	50-80		
H	Hardened steel	Hardened		55HRC	38	30-60	
		Hardened		60HRC	39	30-60	
	Chilled cast iron	Cast		400	40	30-60	
	Cast iron nodular	Hardened		55HRC	41	30-60	

► For more information of material groups, see the materials & grades "material conversion table"

■ Steel
 ■ Stainless steel
 ■ Cast iron
 ■ Nonferrous
 ■ High temp. alloys
 ■ Hardened steel

Recommended Cutting Conditions



Machining data for TOP-DRILL cartridge

Feed (mm/rev) vs. drill diameter Drill length 2,3,4xD					
SOMT 09 Ø51 - Ø55	SOMT 11 Ø56 - Ø60	SOMT 11 Ø61 - Ø65	SOMT 11 Ø66 - Ø70	SOMT 13 Ø71 - Ø75	SOMT 13 Ø76 - Ø80
0.06-0.12	0.06-0.12	0.06-0.12	0.06-0.12	0.06-0.12	0.06-0.12
0.06-0.16	0.06-0.16	0.06-0.16	0.06-0.16	0.06-0.16	0.06-0.16
0.08-0.18	0.08-0.18	0.08-0.18	0.08-0.18	0.08-0.18	0.08-0.18
0.08-0.18	0.08-0.18	0.08-0.18	0.08-0.18	0.08-0.18	0.08-0.18
0.08-0.18	0.08-0.18	0.08-0.18	0.08-0.18	0.08-0.18	0.08-0.18
0.08-0.20	0.08-0.20	0.08-0.20	0.08-0.20	0.08-0.20	0.08-0.20
0.08-0.20	0.08-0.20	0.08-0.20	0.08-0.20	0.08-0.20	0.08-0.20
0.08-0.20	0.08-0.20	0.08-0.20	0.08-0.20	0.08-0.20	0.08-0.20
0.08-0.20	0.08-0.20	0.08-0.20	0.08-0.20	0.08-0.20	0.08-0.20
0.08-0.20	0.08-0.20	0.08-0.20	0.08-0.20	0.08-0.20	0.08-0.20
0.08-0.18	0.08-0.18	0.08-0.18	0.08-0.18	0.08-0.18	0.08-0.18
0.08-0.18	0.08-0.18	0.08-0.18	0.08-0.18	0.08-0.18	0.08-0.18
0.08-0.18	0.08-0.18	0.08-0.18	0.08-0.18	0.08-0.18	0.08-0.18
0.08-0.18	0.08-0.18	0.08-0.18	0.08-0.18	0.08-0.18	0.08-0.18
0.10-0.22	0.10-0.22	0.10-0.22	0.10-0.22	0.10-0.22	0.10-0.22
0.10-0.22	0.10-0.22	0.10-0.22	0.10-0.22	0.10-0.22	0.10-0.22
0.10-0.22	0.10-0.22	0.10-0.22	0.10-0.22	0.10-0.22	0.10-0.22
0.10-0.22	0.10-0.22	0.10-0.22	0.10-0.22	0.10-0.22	0.10-0.22
0.10-0.18	0.10-0.18	0.10-0.18	0.10-0.18	0.10-0.18	0.10-0.18
0.10-0.18	0.10-0.18	0.10-0.18	0.10-0.18	0.10-0.18	0.10-0.18
0.06-0.18	0.06-0.18	0.06-0.18	0.06-0.18	0.06-0.18	0.06-0.18
0.06-0.18	0.06-0.18	0.06-0.18	0.06-0.18	0.06-0.18	0.06-0.18
0.06-0.18	0.06-0.18	0.06-0.18	0.06-0.18	0.06-0.18	0.06-0.18
0.06-0.18	0.06-0.18	0.06-0.18	0.06-0.18	0.06-0.18	0.06-0.18
0.06-0.18	0.06-0.18	0.06-0.18	0.06-0.18	0.06-0.18	0.06-0.18
0.10-0.18	0.10-0.18	0.10-0.18	0.10-0.18	0.10-0.18	0.10-0.18
0.10-0.18	0.10-0.18	0.10-0.18	0.10-0.18	0.10-0.18	0.10-0.18
0.10-0.18	0.10-0.18	0.10-0.18	0.10-0.18	0.10-0.18	0.10-0.18
0.10-0.18	0.10-0.18	0.10-0.18	0.10-0.18	0.10-0.18	0.10-0.18
0.10-0.18	0.10-0.18	0.10-0.18	0.10-0.18	0.10-0.18	0.10-0.18
0.06-0.10	0.06-0.10	0.06-0.10	0.06-0.10	0.06-0.10	0.06-0.10
0.06-0.10	0.06-0.10	0.06-0.10	0.06-0.10	0.06-0.10	0.06-0.10
0.06-0.10	0.06-0.10	0.06-0.10	0.06-0.10	0.06-0.10	0.06-0.10
0.06-0.10	0.06-0.10	0.06-0.10	0.06-0.10	0.06-0.10	0.06-0.10
0.06-0.10	0.06-0.10	0.06-0.10	0.06-0.10	0.06-0.10	0.06-0.10
0.06-0.10	0.06-0.10	0.06-0.10	0.06-0.10	0.06-0.10	0.06-0.10
0.06-0.10	0.06-0.10	0.06-0.10	0.06-0.10	0.06-0.10	0.06-0.10
0.05-0.10	0.05-0.10	0.05-0.10	0.05-0.10	0.05-0.10	0.05-0.10
0.05-0.10	0.05-0.10	0.05-0.10	0.05-0.10	0.05-0.10	0.05-0.10
0.05-0.10	0.05-0.10	0.05-0.10	0.05-0.10	0.05-0.10	0.05-0.10
0.05-0.10	0.05-0.10	0.05-0.10	0.05-0.10	0.05-0.10	0.05-0.10

Recommended Cutting Conditions



Machining data for T-DRILL 2,3,4xD

ISO	Material	Condition	Tensile strength (N/mm ²)	Hardness HB	Material No.	Cutting speed Vc (m/min)	
P	Non-alloy steel, cast steel, free cutting steel	<0.25%C	Annealed	420	125	1	250-350
		>=0.25%C	Annealed	650	190	2	180-250
		<0.55%C	Quenched and tempered	850	250	3	160-220
		>=0.55%C	Annealed	750	220	4	160-220
			Quenched and tempered	1000	300	5	160-220
	Low alloy steel and cast steel (Less than 5% of alloying elements)	Quenched and tempered	Annealed	600	200	6	150-220
			930	275	7	120-160	
			1000	300	8	120-160	
			1200	350	9	120-160	
	High alloy steel, cast steel and tool steel	Annealed	680	200	10	140-180	
		Quenched and tempered	1100	325	11	130-180	
M	Stainless steel and cast steel	Ferritic / martensitic	680	200	12	170-240	
		Martensitic	820	240	13	170-240	
		Austenitic	600	180	14	170-240	
K	Gray cast iron (GG)	Ferritic		160	15	180-250	
		Pearlitic		250	16	180-250	
	Cast iron nodular (GGG)	Ferritic		180	17	180-250	
		Pearlitic		260	18	180-250	
	Malleable cast iron	Ferritic		130	19	130-200	
Pearlitic			230	20	130-200		
N	Aluminum - Wrought alloy	Not cureable		60	21	330-380	
		Cured		100	22	330-380	
	Aluminum-cast, alloyed	<=12% Si	Not cureable		75	23	330-380
			Cured		90	24	330-380
		>12% Si	High temp.		130	25	330-380
	Copper alloys	>1% Pb	Free cutting		110	26	150-230
		Brass			90	27	150-230
			Electrolytic copper		100	28	150-230
	Non-metallic		Duroplastics, fiber plastics		70 Shore D	29	150-230
			Hard rubber		55 Shore D	30	150-230
S	High temp. alloys	Fe based	Annealed		200	31	30-60
			Cured		280	32	30-60
		Ni or Co based	Annealed		250	33	30-60
			Cured		350	34	30-60
			Cast		320	35	30-60
	Titanium, Ti alloys	Pure	Rm 400	190	36	30-60	
Alpha+beta alloys cured		Rm 1050	310	37	30-60		
H	Hardened steel	Hardened		55HRC	38	30-60	
		Hardened		60HRC	39	30-60	
	Chilled cast iron	Cast		400	40	30-60	
	Cast iron nodular	Hardened		55HRC	41	30-60	

► For more information of material groups, see the materials & grades "material conversion table"

■ Steel
 ■ Stainless steel
 ■ Cast iron
 ■ Nonferrous
 ■ High temp. alloys
 ■ Hardened steel

Recommended Cutting Conditions



Machining data for T-DRILL 2,3,4xD

Feed (mm/rev) vs. drill diameter Drill length 2,3,4xD					
SPMG 05 Ø12.5 - Ø15	SPMG 06 Ø16 - Ø21	SPMG 07 Ø22 - Ø27	SPMG 09 Ø28 - Ø33	SPMG 11 Ø34 - Ø41	SPMG 14 Ø42 - Ø50
0.04-0.06	0.04-0.06	0.04-0.08	0.04-0.08	0.06-0.10	0.06-0.12
0.05-0.08	0.06-0.10	0.06-0.12	0.07-0.13	0.08-0.15	0.08-0.16
0.06-0.12	0.08-0.15	0.10-0.18	0.12-0.22	0.12-0.24	0.13-0.25
0.06-0.12	0.08-0.15	0.10-0.18	0.12-0.22	0.12-0.24	0.13-0.25
0.06-0.12	0.08-0.14	0.10-0.18	0.12-0.20	0.12-0.20	0.13-0.20
0.06-0.15	0.06-0.15	0.08-0.18	0.08-0.18	0.08-0.18	0.08-0.18
0.06-0.15	0.06-0.15	0.08-0.18	0.08-0.18	0.08-0.18	0.08-0.18
0.06-0.15	0.06-0.15	0.08-0.18	0.08-0.18	0.08-0.18	0.08-0.18
0.06-0.10	0.06-0.10	0.08-0.12	0.08-0.14	0.08-0.14	0.08-0.14
0.06-0.10	0.08-0.12	0.10-0.15	0.12-0.15	0.12-0.18	0.13-0.18
0.05-0.10	0.06-0.12	0.08-0.15	0.09-0.16	0.10-0.17	0.11-0.18
0.05-0.10	0.06-0.12	0.08-0.15	0.09-0.16	0.10-0.17	0.11-0.18
0.05-0.10	0.06-0.12	0.08-0.15	0.09-0.16	0.10-0.17	0.11-0.18
0.06-0.12	0.08-0.16	0.12-0.20	0.15-0.25	0.16-0.28	0.18-0.30
0.06-0.12	0.08-0.16	0.12-0.20	0.15-0.25	0.16-0.28	0.18-0.30
0.06-0.12	0.08-0.16	0.12-0.20	0.15-0.25	0.16-0.28	0.18-0.30
0.06-0.12	0.08-0.16	0.12-0.20	0.15-0.25	0.16-0.28	0.18-0.30
0.06-0.10	0.08-0.15	0.10-0.18	0.12-0.20	0.15-0.23	0.16-0.25
0.06-0.10	0.08-0.15	0.10-0.18	0.12-0.20	0.15-0.23	0.16-0.25
0.06-0.14	0.08-0.15	0.10-0.20	0.12-0.22	0.14-0.23	0.15-0.26
0.06-0.14	0.08-0.15	0.10-0.20	0.12-0.22	0.14-0.23	0.15-0.26
0.06-0.14	0.08-0.15	0.10-0.20	0.12-0.22	0.14-0.23	0.15-0.26
0.06-0.14	0.08-0.15	0.10-0.20	0.12-0.22	0.14-0.23	0.15-0.26
0.06-0.13	0.06-0.13	0.08-0.15	0.08-0.15	0.08-0.15	0.08-0.15
0.06-0.13	0.06-0.13	0.08-0.15	0.08-0.15	0.08-0.15	0.08-0.15
0.06-0.13	0.06-0.13	0.08-0.15	0.08-0.15	0.08-0.15	0.08-0.15
0.06-0.13	0.06-0.13	0.08-0.15	0.08-0.15	0.08-0.15	0.08-0.15
0.05-0.08	0.05-0.08	0.05-0.09	0.05-0.09	0.05-0.09	0.05-0.09
0.05-0.08	0.05-0.08	0.05-0.09	0.05-0.09	0.05-0.09	0.05-0.09
0.05-0.08	0.05-0.08	0.05-0.09	0.05-0.09	0.05-0.09	0.05-0.09
0.05-0.08	0.05-0.08	0.05-0.09	0.05-0.09	0.05-0.09	0.05-0.09
0.05-0.10	0.06-0.14	0.08-0.18	0.10-0.22	0.14-0.23	0.15-0.24
0.05-0.10	0.06-0.14	0.08-0.18	0.10-0.22	0.14-0.23	0.15-0.24
0.05-0.09	0.05-0.09	0.05-0.10	0.05-0.10	0.05-0.10	0.05-0.10
0.05-0.09	0.05-0.09	0.05-0.10	0.05-0.10	0.05-0.10	0.05-0.10
0.05-0.09	0.05-0.09	0.05-0.10	0.05-0.10	0.05-0.10	0.05-0.10

Recommended Cutting Conditions



Machining data for T-DRILL 5xD

ISO	Material	Condition	Tensile strength (N/mm ²)	Hardness HB	Material No.	Cutting speed Vc (m/min)	
P	Non-alloy steel, cast steel, free cutting steel	<0.25%C	Annealed	420	125	1	250-350
		>=0.25%C	Annealed	650	190	2	180-250
		<0.55%C	Quenched and tempered	850	250	3	160-220
		>=0.55%C	Annealed	750	220	4	160-220
			Quenched and tempered	1000	300	5	160-220
	Low alloy steel and cast steel (Less than 5% of alloying elements)	Quenched and tempered	Annealed	600	200	6	150-220
			930	275	7	120-160	
			1000	300	8	120-160	
			1200	350	9	120-160	
	High alloy steel, cast steel and tool steel	Annealed	680	200	10	140-180	
		Quenched and tempered	1100	325	11	130-180	
M	Stainless steel and cast steel	Ferritic / martensitic	680	200	12	170-240	
		Martensitic	820	240	13	170-240	
		Austenitic	600	180	14	170-240	
K	Gray cast iron (GG)	Ferritic		160	15	180-250	
		Pearlitic		250	16	180-250	
	Cast iron nodular (GGG)	Ferritic		180	17	180-250	
		Pearlitic		260	18	180-250	
	Malleable cast iron	Ferritic		130	19	130-200	
Pearlitic			230	20	130-200		
N	Aluminum - Wrought alloy	Not cureable		60	21	330-380	
		Cured		100	22	330-380	
	Aluminum-cast, alloyed	<=12% Si	Not cureable		75	23	330-380
			Cured		90	24	330-380
		>12% Si	High temp.		130	25	330-380
	Copper alloys	>1% Pb	Free cutting		110	26	150-230
		Brass			90	27	150-230
			Electrolytic copper		100	28	150-230
	Non-metallic		Duroplastics, fiber plastics		70 Shore D	29	150-230
			Hard rubber		55 Shore D	30	150-230
S	High temp. alloys	Fe based	Annealed		200	31	30-60
			Cured		280	32	30-60
		Ni or Co based	Annealed		250	33	30-60
			Cured		350	34	30-60
			Cast		320	35	30-60
	Titanium, Ti alloys	Pure	Rm 400	190	36	30-60	
Alpha+beta alloys cured		Rm 1050	310	37	30-60		
H	Hardened steel	Hardened		55HRC	38	30-60	
		Hardened		60HRC	39	30-60	
	Chilled cast iron	Cast		400	40	30-60	
	Cast iron nodular	Hardened		55HRC	41	30-60	

► For more information of material groups, see the materials & grades "material conversion table"

■ Steel
 ■ Stainless steel
 ■ Cast iron
 ■ Nonferrous
 ■ High temp. alloys
 ■ Hardened steel

Recommended Cutting Conditions



Machining data for T-DRILL 5xD

Feed (mm/rev) vs. drill diameter Drill length 5xD					
SPMG 05 Ø12.5 - Ø15	SPMG 06 Ø16 - Ø21	SPMG 07 Ø22 - Ø27	SPMG 09 Ø28 - Ø33	SPMG 11 Ø34 - Ø41	SPMG 14 Ø42 - Ø50
0.04-0.05	0.04-0.05	0.04-0.06	0.04-0.07	0.06-0.08	0.06-0.10
0.06-0.08	0.06-0.08	0.06-0.10	0.07-0.12	0.08-0.13	0.08-0.14
0.06-0.10	0.08-0.13	0.10-0.16	0.12-0.20	0.12-0.22	0.13-0.23
0.06-0.10	0.08-0.13	0.10-0.16	0.12-0.20	0.12-0.22	0.13-0.23
0.06-0.10	0.08-0.12	0.10-0.16	0.12-0.18	0.12-0.18	0.13-0.18
0.06-0.12	0.06-0.13	0.08-0.16	0.08-0.16	0.08-0.17	0.08-0.17
0.06-0.12	0.06-0.13	0.08-0.16	0.08-0.16	0.08-0.17	0.08-0.17
0.06-0.12	0.06-0.13	0.08-0.16	0.08-0.16	0.08-0.17	0.08-0.17
0.06-0.08	0.06-0.08	0.08-0.10	0.08-0.12	0.08-0.12	0.08-0.12
0.06-0.09	0.08-0.10	0.10-0.13	0.12-0.13	0.12-0.15	0.12-0.16
0.05-0.09	0.06-0.10	0.08-0.13	0.09-0.15	0.10-0.15	0.10-0.17
0.05-0.09	0.06-0.10	0.08-0.13	0.09-0.15	0.10-0.15	0.10-0.17
0.05-0.09	0.06-0.10	0.08-0.13	0.09-0.15	0.10-0.15	0.10-0.17
0.06-0.10	0.08-0.15	0.12-0.18	0.15-0.22	0.16-0.25	0.18-0.28
0.06-0.10	0.08-0.15	0.12-0.18	0.15-0.22	0.16-0.25	0.18-0.28
0.06-0.10	0.08-0.15	0.12-0.18	0.15-0.22	0.16-0.25	0.18-0.28
0.06-0.10	0.08-0.15	0.12-0.18	0.15-0.22	0.16-0.25	0.18-0.28
0.06-0.08	0.08-0.12	0.10-0.16	0.12-0.18	0.15-0.22	0.16-0.23
0.06-0.08	0.08-0.12	0.10-0.16	0.12-0.18	0.15-0.22	0.16-0.23
0.06-0.12	0.08-0.15	0.10-0.13	0.12-0.18	0.14-0.20	0.14-0.24
0.06-0.12	0.08-0.15	0.10-0.13	0.12-0.18	0.14-0.20	0.14-0.24
0.06-0.12	0.08-0.15	0.10-0.13	0.12-0.18	0.14-0.20	0.14-0.24
0.06-0.12	0.08-0.15	0.10-0.13	0.12-0.18	0.14-0.20	0.14-0.24
0.06-0.12	0.08-0.15	0.10-0.13	0.12-0.18	0.14-0.20	0.14-0.24
0.06-0.12	0.06-0.12	0.08-0.13	0.08-0.13	0.08-0.14	0.08-0.14
0.06-0.12	0.06-0.12	0.08-0.13	0.08-0.13	0.08-0.14	0.08-0.14
0.06-0.12	0.06-0.12	0.08-0.13	0.08-0.13	0.08-0.14	0.08-0.14
0.06-0.12	0.06-0.12	0.08-0.13	0.08-0.13	0.08-0.14	0.08-0.14
0.05-0.07	0.05-0.07	0.05-0.08	0.05-0.08	0.05-0.08	0.05-0.08
0.05-0.07	0.05-0.07	0.05-0.08	0.05-0.08	0.05-0.08	0.05-0.08
0.05-0.07	0.05-0.07	0.05-0.08	0.05-0.08	0.05-0.08	0.05-0.08
0.05-0.07	0.05-0.07	0.05-0.08	0.05-0.08	0.05-0.08	0.05-0.08
0.05-0.07	0.05-0.07	0.05-0.08	0.05-0.08	0.05-0.08	0.05-0.08
0.05-0.09	0.08-0.13	0.08-0.17	0.10-0.20	0.14-0.22	0.14-0.24
0.05-0.09	0.08-0.13	0.08-0.17	0.10-0.20	0.14-0.22	0.14-0.24
0.05-0.08	0.05-0.08	0.05-0.09	0.05-0.09	0.05-0.09	0.05-0.09
0.05-0.08	0.05-0.08	0.05-0.09	0.05-0.09	0.05-0.09	0.05-0.09
0.05-0.08	0.05-0.08	0.05-0.09	0.05-0.09	0.05-0.09	0.05-0.09
0.05-0.08	0.05-0.08	0.05-0.09	0.05-0.09	0.05-0.09	0.05-0.09

Recommended Cutting Conditions



Machining data for T-DRILL cartridge

ISO	Material	Condition	Tensile strength (N/mm ²)	Hardness HB	Material No.	Cutting speed Vc (m/min)	
P	Non-alloy steel, cast steel, free cutting steel	<0.25%C	Annealed	420	125	1	250-350
		>=0.25%C	Annealed	650	190	2	180-250
		<0.55%C	Quenched and tempered	850	250	3	160-220
		>=0.55%C	Annealed	750	220	4	160-220
			Quenched and tempered	1000	300	5	160-220
	Low alloy steel and cast steel (Less than 5% of alloying elements)	Quenched and tempered	Annealed	600	200	6	150-220
			930	275	7	120-160	
			1000	300	8	120-160	
			1200	350	9	120-160	
	High alloy steel, cast steel and tool steel	Annealed	680	200	10	140-180	
		Quenched and tempered	1100	325	11	130-180	
M	Stainless steel and cast steel	Ferritic / martensitic	680	200	12	170-240	
		Martensitic	820	240	13	170-240	
		Austenitic	600	180	14	170-240	
K	Gray cast iron (GG)	Ferritic		160	15	180-250	
		Pearlitic		250	16	180-250	
	Cast iron nodular (GGG)	Ferritic		180	17	180-250	
		Pearlitic		260	18	180-250	
	Malleable cast iron	Ferritic		130	19	130-200	
Pearlitic			230	20	130-200		
N	Aluminum - Wrought alloy	Not cureable		60	21	330-380	
		Cured		100	22	330-380	
	Aluminum-cast, alloyed	<=12% Si	Not cureable		75	23	330-380
			Cured		90	24	330-380
		>12% Si	High temp.		130	25	330-380
	Copper alloys	>1% Pb	Free cutting		110	26	150-230
		Brass			90	27	150-230
			Electrolitic copper		100	28	150-230
	Non-metallic		Duroplastics, fiber plastics		70 Shore D	29	150-230
Hard rubber				55 Shore D	30	150-230	
S	High temp. alloys	Fe based	Annealed		200	31	30-60
			Cured		280	32	30-60
		Ni or Co based	Annealed		250	33	30-60
			Cured		350	34	30-60
			Cast		320	35	30-60
	Titanium, Ti alloys	Pure	Rm 400	190	36	30-60	
Alpha+beta alloys cured		Rm 1050	310	37	30-60		
H	Hardened steel	Hardened		55HRC	38	30-60	
		Hardened		60HRC	39	30-60	
	Chilled cast iron	Cast		400	40	30-60	
	Cast iron nodular	Hardened		55HRC	41	30-60	

► For more information of material groups, see the materials & grades "material conversion table"

■ Steel
 ■ Stainless steel
 ■ Cast iron
 ■ Nonferrous
 ■ High temp. alloys
 ■ Hardened steel

Recommended Cutting Conditions



Machining data for T-DRILL cartridge

Feed (mm/rev) vs. drill diameter Drill length 5xD					
SPMG 07 Ø51 - Ø53	SPMG 07 Ø54 - Ø56	SPMG 09 Ø57 - Ø62	SPMG 09 Ø63- Ø66	SPMG 11 Ø67 - Ø73	SPMG 12 Ø74 - Ø80
0.06-0.12	0.06-0.12	0.06-0.12	0.06-0.12	0.06-0.12	0.06-0.12
0.06-0.16	0.06-0.12	0.06-0.16	0.06-0.16	0.06-0.16	0.06-0.16
0.08-0.16	0.08-0.16	0.08-0.16	0.08-0.16	0.08-0.18	0.08-0.18
0.08-0.16	0.08-0.16	0.08-0.16	0.08-0.16	0.08-0.18	0.08-0.18
0.08-0.16	0.08-0.16	0.08-0.16	0.08-0.16	0.08-0.18	0.08-0.18
0.08-0.18	0.08-0.18	0.08-0.18	0.08-0.18	0.08-0.18	0.08-0.18
0.08-0.18	0.08-0.18	0.08-0.18	0.08-0.18	0.08-0.18	0.08-0.18
0.08-0.18	0.08-0.18	0.08-0.18	0.08-0.18	0.08-0.18	0.08-0.18
0.08-0.18	0.08-0.18	0.08-0.18	0.08-0.18	0.08-0.18	0.08-0.18
0.08-0.18	0.08-0.18	0.08-0.18	0.08-0.18	0.08-0.18	0.08-0.18
0.08-0.16	0.08-0.16	0.08-0.16	0.08-0.16	0.08-0.16	0.08-0.16
0.06-0.12	0.06-0.12	0.08-0.15	0.08-0.15	0.08-0.15	0.08-0.15
0.06-0.12	0.06-0.12	0.08-0.15	0.08-0.15	0.08-0.15	0.08-0.15
0.06-0.12	0.06-0.12	0.08-0.15	0.08-0.15	0.08-0.15	0.08-0.15
0.12-0.20	0.12-0.20	0.12-0.20	0.12-0.20	0.15-0.22	0.15-0.22
0.12-0.20	0.12-0.20	0.12-0.20	0.12-0.20	0.15-0.22	0.15-0.22
0.12-0.20	0.12-0.20	0.12-0.20	0.12-0.20	0.15-0.22	0.15-0.22
0.12-0.20	0.12-0.20	0.12-0.20	0.12-0.20	0.15-0.22	0.15-0.22
0.10-0.18	0.10-0.18	0.10-0.18	0.10-0.18	0.12-0.20	0.12-0.20
0.10-0.18	0.10-0.18	0.10-0.18	0.10-0.18	0.12-0.20	0.12-0.20
0.06-0.18	0.06-0.18	0.06-0.18	0.06-0.18	0.06-0.18	0.06-0.18
0.06-0.18	0.06-0.18	0.06-0.18	0.06-0.18	0.06-0.18	0.06-0.18
0.06-0.18	0.06-0.18	0.06-0.18	0.06-0.18	0.06-0.18	0.06-0.18
0.06-0.18	0.06-0.18	0.06-0.18	0.06-0.18	0.06-0.18	0.06-0.18
0.06-0.18	0.06-0.18	0.06-0.18	0.06-0.18	0.06-0.18	0.06-0.18
0.10-0.18	0.10-0.18	0.10-0.18	0.10-0.18	0.10-0.18	0.10-0.18
0.10-0.18	0.10-0.18	0.10-0.18	0.10-0.18	0.10-0.18	0.10-0.18
0.10-0.18	0.10-0.18	0.10-0.18	0.10-0.18	0.10-0.18	0.10-0.18
0.10-0.18	0.10-0.18	0.10-0.18	0.10-0.18	0.10-0.18	0.10-0.18
0.10-0.18	0.10-0.18	0.10-0.18	0.10-0.18	0.10-0.18	0.10-0.18
0.06-0.10	0.06-0.10	0.06-0.10	0.06-0.10	0.06-0.10	0.06-0.10
0.06-0.10	0.06-0.10	0.06-0.10	0.06-0.10	0.06-0.10	0.06-0.10
0.06-0.10	0.06-0.10	0.06-0.10	0.06-0.10	0.06-0.10	0.06-0.10
0.06-0.10	0.06-0.10	0.06-0.10	0.06-0.10	0.06-0.10	0.06-0.10
0.06-0.10	0.06-0.10	0.06-0.10	0.06-0.10	0.06-0.10	0.06-0.10
0.06-0.10	0.06-0.10	0.06-0.10	0.06-0.10	0.06-0.10	0.06-0.10
0.06-0.10	0.06-0.10	0.06-0.10	0.06-0.10	0.06-0.10	0.06-0.10
0.05-0.10	0.05-0.10	0.05-0.10	0.05-0.10	0.05-0.10	0.05-0.10
0.05-0.10	0.05-0.10	0.05-0.10	0.05-0.10	0.05-0.10	0.05-0.10
0.05-0.10	0.05-0.10	0.05-0.10	0.05-0.10	0.05-0.10	0.05-0.10
0.05-0.10	0.05-0.10	0.05-0.10	0.05-0.10	0.05-0.10	0.05-0.10

Recommended Cutting Conditions



Machining data for TOP-CAP

ISO	Material	Condition	Tensile strength (N/mm ²)	Hardness HB	Material No.	
P	Non-alloy steel, cast steel, free cutting steel	<0.25%C	Annealed	420	125	1
		>=0.25%C	Annealed	650	190	2
		<0.55%C	Quenched and tempered	850	250	3
		>=0.55%C	Annealed	750	220	4
			Quenched and tempered	1000	300	5
	Low alloy steel and cast steel (Less than 5% of alloying elements)		Annealed	600	200	6
			Quenched and tempered	930	275	7
				1000	300	8
				1200	350	9
	High alloy steel, cast steel and tool steel		Annealed	680	200	10
			Quenched and tempered	1100	325	11
M	Stainless steel and cast steel	Ferritic / martensitic	680	200	12	
		Martensitic	820	240	13	
		Austenitic	600	180	14	
K	Gray cast iron (GG)	Ferritic		160	15	
		Pearlitic		250	16	
	Cast iron nodular (GGG)	Ferritic		180	17	
		Pearlitic		260	18	
	Malleable cast iron	Ferritic		130	19	
	Pearlitic		230	20		
N	Aluminum - Wrought alloy	Not cureable		60	21	
		Cured		100	22	
	Aluminum-cast, alloyed	<=12% Si	Not cureable		75	23
			Cured		90	24
		>12% Si	High temp.		130	25
	Copper alloys		>1% Pb	Free cutting	110	26
			Brass		90	27
			Electrolitic copper		100	28
Non-metallic		Duroplastics, fiber plastics		70 Shore D	29	
		Hard rubber		55 Shore D	30	
S	High temp. alloys	Fe based	Annealed		200	31
			Cured		280	32
		Ni or Co based	Annealed		250	33
			Cured		350	34
			Cast		320	35
	Titanium, Ti alloys		Pure	Rm 400	190	36
Alpha+beta alloys cured			Rm 1050	310	37	
H	Hardened steel	Hardened		55HRC	38	
		Hardened		60HRC	39	
	Chilled cast iron	Cast		400	40	
Cast iron nodular	Hardened		55HRC	41		

► For more information of material groups, see the materials & grades "material conversion table"

■ Steel
 ■ Stainless steel
 ■ Cast iron
 ■ Nonferrous
 ■ High temp. alloys
 ■ Hardened steel

Recommended Cutting Conditions



Machining data for TOP-CAP

Drilling		Turning & boring		Grooving	
Vc (m/min)	Feed (mm/rev)	Vc (m/min)	Feed (mm/rev)	Vc (m/min)	Feed (mm/rev)
120-260	0.05-0.06	140-280	0.04-0.14	120-250	0.04-0.25
80-190	0.05-0.15	90-200	0.04-0.12	80-180	0.04-0.25
100-280	0.06-0.18	100-200	0.04-0.15	80-180	0.04-0.25
100-280	0.06-0.18	100-200	0.04-0.15	80-180	0.04-0.25
100-280	0.06-0.18	100-200	0.04-0.15	80-180	0.04-0.25
100-280	0.06-0.18	100-200	0.04-0.15	80-180	0.04-0.25
60-180	0.04-0.15	80-180	0.07-0.12	60-160	0.04-0.25
60-180	0.04-0.15	80-180	0.07-0.12	60-160	0.04-0.25
60-180	0.04-0.15	80-180	0.07-0.12	60-160	0.04-0.25
80-190	0.05-0.15	80-200	0.04-0.12	80-160	0.04-0.25
50-150	0.04-0.14	60-150	0.04-0.12	50-120	0.04-0.25
50-210	0.04-0.15	60-230	0.07-0.12	50-200	0.04-0.25
50-210	0.04-0.15	60-230	0.07-0.12	50-200	0.04-0.25
50-210	0.04-0.15	60-230	0.07-0.12	50-200	0.04-0.25
100-300	0.06-0.23	120-230	0.07-0.2	100-200	0.04-0.25
100-300	0.06-0.23	120-230	0.07-0.2	100-200	0.04-0.25
100-300	0.06-0.23	120-230	0.07-0.2	100-200	0.04-0.25
100-300	0.06-0.23	120-230	0.07-0.2	100-200	0.04-0.25
100-200	0.06-0.15	120-230	0.04-0.13	100-200	0.04-0.25
100-200	0.06-0.15	120-230	0.04-0.13	100-200	0.04-0.25
120-500	0.05-0.3	120-700	0.04-0.25	100-700	0.04-0.25
120-500	0.05-0.3	120-700	0.04-0.25	100-700	0.04-0.25
120-500	0.05-0.3	120-700	0.04-0.25	100-700	0.04-0.25
120-500	0.05-0.3	120-700	0.04-0.25	100-700	0.04-0.25
120-500	0.05-0.3	120-700	0.04-0.25	100-700	0.04-0.25
80-380	0.05-0.23	80-500	0.04-0.2	80-350	0.04-0.25
80-380	0.05-0.23	80-500	0.04-0.2	80-350	0.04-0.25
80-380	0.05-0.23	80-500	0.04-0.2	80-350	0.04-0.25
50-140	0.04-0.14	50-160	0.04-0.12	50-140	0.04-0.25
50-140	0.04-0.14	50-160	0.04-0.12	50-140	0.04-0.25
20-50	0.04-0.05	20-80	0.04-0.05	20-50	0.04-0.05
20-50	0.04-0.05	20-80	0.04-0.05	20-50	0.04-0.05
20-50	0.04-0.05	20-80	0.04-0.05	20-50	0.04-0.05
20-50	0.04-0.05	20-80	0.04-0.05	20-50	0.04-0.05
20-50	0.04-0.05	20-80	0.04-0.05	20-50	0.04-0.05
20-50	0.04-0.05	20-80	0.04-0.05	20-50	0.04-0.05
30-60	0.04-0.05	30-100	0.04-0.05	30-80	0.04-0.05
30-60	0.04-0.05	30-100	0.04-0.05	30-80	0.04-0.05
20-40	0.04-0.05	20-70	0.04-0.05	20-50	0.04-0.05
20-40	0.04-0.05	20-70	0.04-0.05	20-50	0.04-0.05
20-40	0.04-0.05	20-70	0.04-0.05	20-50	0.04-0.05
20-40	0.04-0.05	20-70	0.04-0.05	20-50	0.04-0.05
20-40	0.04-0.05	20-70	0.04-0.05	20-50	0.04-0.05

Recommended Cutting Conditions

Machining data for DRILL-SFEED 3,5,8xD

ISO	Material	Condition	Tensile strength (N/mm ²)	Hardness HB	Material No.	
P	Non-alloy steel, cast steel, free cutting steel	<0.25%C	Annealed	420	125	1
		≥0.25%C	Annealed	650	190	2
		<0.55%C	Quenched and tempered	850	250	3
		≥0.55%C	Annealed	750	220	4
			Quenched and tempered	1000	300	5
	Low alloy steel and cast steel (Less than 5% of alloying elements)	Quenched and tempered	Annealed	600	200	6
			930	275	7	
			1000	300	8	
			1200	350	9	
	High alloy steel, cast steel and tool steel	Annealed	680	200	10	
		Quenched and tempered	1100	325	11	
M	Stainless steel and cast steel	Ferritic / martensitic	680	200	12	
		Martensitic	820	240	13	
		Austenitic	600	180	14	
K	Gray cast iron (GG)	Ferritic		160	15	
		Pearlitic		250	16	
	Cast iron nodular (GGG)	Ferritic		180	17	
		Pearlitic		260	18	
	Malleable cast iron	Ferritic		130	19	
		Pearlitic		230	20	
N	Aluminum - Wrought alloy	Not cureable		60	21	
		Cured		100	22	
	Aluminum-cast, alloyed	≤12% Si	Not cureable		75	23
			Cured		90	24
		>12% Si	High temp.		130	25
	Copper alloys	>1% Pb	Free cutting		110	26
			Brass		90	27
		Electrolitic copper		100	28	
Non-metallic		Duroplastics, fiber plastics		70 Shore D	29	
		Hard rubber		55 Shore D	30	
S	High temp. alloys	Fe based	Annealed		200	31
			Cured		280	32
		Ni or Co based	Annealed		250	33
			Cured		350	34
			Cast		320	35
	Titanium, Ti alloys	Pure	Rm 400	190	36	
Alpha+beta alloys cured		Rm 1050	310	37		
H	Hardened steel	Hardened		55HRC	38	
		Hardened		60HRC	39	
	Chilled cast iron	Cast		400	40	
	Cast iron nodular	Hardened		55HRC	41	

► For more information of material groups, see the materials & grades "material conversion table"

■ Steel
 ■ Stainless steel
 ■ Cast iron
 ■ Nonferrous
 ■ High temp. alloys
 ■ Hardened steel

Recommended Cutting Conditions



Machining data for DRILL-RUSH

ISO	Material	Condition	Tensile strength (N/mm ²)	Hardness HB	Material No.	Cutting speed Vc (m/min)	
P	Non-alloy steel, cast steel, free cutting steel	<0.25%C	Annealed	420	125	1	80-140
		>=0.25%C	Annealed	650	190	2	80-130
		<0.55%C	Quenched and tempered	850	250	3	80-120
		>=0.55%C	Annealed	750	220	4	70-110
			Quenched and tempered	1000	300	5	50-90
	Low alloy steel and cast steel (Less than 5% of alloying elements)	Quenched and tempered	Annealed	600	200	6	70-120
			930	275	7	70-110	
			1000	300	8	50-90	
			1200	350	9	40-70	
	High alloy steel, cast steel and tool steel	Annealed	680	200	10	50-90	
		Quenched and tempered	1100	325	11	40-80	
M	Stainless steel and cast steel	Ferritic / martensitic	680	200	12	40-70	
		Martensitic	820	240	13	40-70	
		Austenitic	600	180	14	30-70	
K	Gray cast iron (GG)	Ferritic		160	15	90-160	
		Pearlitic		250	16	80-140	
	Cast iron nodular (GGG)	Ferritic		180	17	90-180	
		Pearlitic		260	18	80-140	
	Malleable cast iron	Ferritic		130	19	90-160	
Pearlitic			230	20	80-140		
N	Aluminum - Wrought alloy	Not cureable		60	21	90-220	
		Cured		100	22	90-220	
	Aluminum-cast, alloyed	<=12% Si	Not cureable		75	23	90-220
			Cured		90	24	90-220
		>12% Si	High temp.		130	25	80-160
	Copper alloys	>1% Pb	Free cutting		110	26	90-220
		Brass			90	27	90-220
			Electrolytic copper		100	28	90-220
	Non-metallic		Duroplastics, fiber plastics		70 Shore D	29	
Hard rubber				55 Shore D	30		
S	High temp. alloys	Fe based	Annealed		200	31	30-60
			Cured		280	32	20-50
		Ni or Co based	Annealed		250	33	20-50
			Cured		350	34	20-50
			Cast		320	35	20-50
	Titanium, Ti alloys	Pure	Rm 400	190	36	20-50	
Alpha+beta alloys cured		Rm 1050	310	37	20-50		
H	Hardened steel	Hardened		55HRC	38	20-50	
		Hardened		60HRC	39	20-50	
	Chilled cast iron	Cast		400	40		
	Cast iron nodular	Hardened		55HRC	41		

► For more information of material groups, see the materials & grades "material conversion table"

■ Steel
 ■ Stainless steel
 ■ Cast iron
 ■ Nonferrous
 ■ High temp. alloys
 ■ Hardened steel

Recommended Cutting Conditions



Machining data for MODU-R-DRILL

ISO	Material	Condition	Tensile strength (N/mm ²)	Hardness HB	Material No.	Cutting speed Vc (m/min)	
P	Non-alloy steel, cast steel, free cutting steel	<0.25%C	Annealed	420	125	1	120-200
		>=0.25%C	Annealed	650	190	2	120-200
		<0.55%C	Quenched and tempered	850	250	3	130-190
		>=0.55%C	Annealed	750	220	4	130-190
			Quenched and tempered	1000	300	5	130-190
	Low alloy steel and cast steel (Less than 5% of alloying elements)	Quenched and tempered	Annealed	600	200	6	100-200
			930	275	7	100-200	
			1000	300	8	100-200	
			1200	350	9	100-200	
	High alloy steel, cast steel and tool steel	Annealed	680	200	10	100-160	
		Quenched and tempered	1100	325	11	100-160	
M	Stainless steel and cast steel	Ferritic / martensitic	680	200	12	80-140	
		Martensitic	820	240	13	80-140	
		Austenitic	600	180	14	80-140	
K	Gray cast iron (GG)	Ferritic		160	15	100-250	
		Pearlitic		250	16	100-250	
	Cast iron nodular (GGG)	Ferritic		180	17	100-250	
		Pearlitic		260	18	100-250	
	Malleable cast iron	Ferritic		130	19	100-250	
Pearlitic			230	20	100-250		
N	Aluminum - Wrought alloy	Not cureable		60	21	160-260	
		Cured		100	22	160-260	
	Aluminum-cast, alloyed	<=12% Si	Not cureable		75	23	160-260
			Cured		90	24	160-260
		>12% Si	High temp.		130	25	160-260
	Copper alloys	>1% Pb	Free cutting		110	26	160-260
		Brass			90	27	160-260
			Electrolitic copper		100	28	160-260
	Non-metallic		Duroplastics, fiber plastics		70 Shore D	29	
			Hard rubber		55 Shore D	30	
S	High temp. alloys	Fe based	Annealed		200	31	30-60
			Cured		280	32	30-80
		Ni or Co based	Annealed		250	33	30-80
			Cured		350	34	30-80
			Cast		320	35	30-80
	Titanium, Ti alloys	Pure	Rm 400	190	36	30-80	
		Alpha+beta alloys cured	Rm 1050	310	37	30-80	
H	Hardened steel	Hardened		55HRC	38	20-50	
		Hardened		60HRC	39	20-50	
	Chilled cast iron	Cast		400	40		
	Cast iron nodular	Hardened		55HRC	41		

► For more information of material groups, see the materials & grades "material conversion table"

■ Steel
 ■ Stainless steel
 ■ Cast iron
 ■ Nonferrous
 ■ High temp. alloys
 ■ Hardened steel

Recommended Cutting Conditions



Machining data for MODU-R-DRILL

Feed (mm/rev) vs. drill diameter

SPGX 06 Ø26 - Ø28	SPGX 07 Ø29 - Ø32	SPGX 09 Ø33 - Ø36	SPGX 11 Ø37 - Ø43	SPGX 11 Ø44 - Ø45	SPGX 14 Ø46 - Ø50
0.20-0.35	0.25-0.35	0.2-0.4	0.25-0.4	0.28-0.45	0.28-0.45
0.20-0.35	0.25-0.35	0.2-0.4	0.25-0.4	0.28-0.45	0.28-0.45
0.20-0.35	0.25-0.35	0.2-0.4	0.25-0.4	0.28-0.45	0.28-0.45
0.20-0.35	0.25-0.35	0.2-0.4	0.25-0.4	0.28-0.45	0.28-0.45
0.20-0.35	0.25-0.35	0.2-0.4	0.25-0.4	0.28-0.45	0.28-0.45
0.20-0.33	0.25-0.33	0.25-0.36	0.25-0.36	0.25-0.40	0.25-0.40
0.20-0.33	0.25-0.33	0.25-0.36	0.25-0.36	0.25-0.40	0.25-0.40
0.20-0.33	0.25-0.33	0.25-0.36	0.25-0.36	0.25-0.40	0.25-0.40
0.20-0.33	0.25-0.33	0.25-0.36	0.25-0.36	0.25-0.40	0.25-0.40
0.20-0.33	0.25-0.33	0.25-0.36	0.25-0.36	0.25-0.40	0.25-0.40
0.20-0.33	0.25-0.33	0.25-0.36	0.25-0.36	0.25-0.40	0.25-0.40
0.12-0.24	0.15-0.24	0.16-0.25	0.18-0.28	0.18-0.30	0.18-0.30
0.12-0.24	0.15-0.24	0.16-0.25	0.18-0.28	0.18-0.30	0.18-0.30
0.12-0.24	0.15-0.24	0.16-0.25	0.18-0.28	0.18-0.30	0.18-0.30
0.25-0.45	0.25-0.45	0.3-0.5	0.3-0.5	0.35-0.55	0.35-0.55
0.25-0.45	0.25-0.45	0.3-0.5	0.3-0.5	0.35-0.55	0.35-0.55
0.25-0.45	0.25-0.45	0.3-0.5	0.3-0.5	0.35-0.55	0.35-0.55
0.25-0.45	0.25-0.45	0.3-0.5	0.3-0.5	0.35-0.55	0.35-0.55
0.25-0.45	0.25-0.45	0.3-0.5	0.3-0.5	0.35-0.55	0.35-0.55
0.25-0.45	0.25-0.45	0.3-0.5	0.3-0.5	0.35-0.55	0.35-0.55
0.3-0.5	0.3-0.5	0.35-0.55	0.35-0.55	0.4-0.6	0.4-0.6
0.3-0.5	0.3-0.5	0.35-0.55	0.35-0.55	0.4-0.6	0.4-0.6
0.3-0.5	0.3-0.5	0.35-0.55	0.35-0.55	0.4-0.6	0.4-0.6
0.3-0.5	0.3-0.5	0.35-0.55	0.35-0.55	0.4-0.6	0.4-0.6
0.3-0.5	0.3-0.5	0.35-0.55	0.35-0.55	0.4-0.6	0.4-0.6
0.3-0.5	0.3-0.5	0.35-0.55	0.35-0.55	0.4-0.6	0.4-0.6
0.3-0.5	0.3-0.5	0.35-0.55	0.35-0.55	0.4-0.6	0.4-0.6
0.3-0.5	0.3-0.5	0.35-0.55	0.35-0.55	0.4-0.6	0.4-0.6
0.3-0.5	0.3-0.5	0.35-0.55	0.35-0.55	0.4-0.6	0.4-0.6
0.1-0.16	0.10-0.18	0.15-0.20	0.15-0.22	0.16-0.24	0.16-0.24
0.1-0.16	0.10-0.18	0.15-0.20	0.15-0.22	0.16-0.24	0.16-0.24
0.1-0.16	0.10-0.18	0.15-0.20	0.15-0.22	0.16-0.24	0.16-0.24
0.1-0.16	0.10-0.18	0.15-0.20	0.15-0.22	0.16-0.24	0.16-0.24
0.1-0.16	0.10-0.18	0.15-0.20	0.15-0.22	0.16-0.24	0.16-0.24
0.1-0.16	0.10-0.18	0.15-0.20	0.15-0.22	0.16-0.24	0.16-0.24
0.1-0.16	0.10-0.18	0.15-0.20	0.15-0.22	0.16-0.24	0.16-0.24
0.1-0.16	0.12-0.18	0.14-0.20	0.14-0.20	0.16-0.22	0.16-0.22
0.1-0.16	0.12-0.18	0.14-0.20	0.14-0.20	0.16-0.22	0.16-0.22

Recommended Cutting Conditions



Machining data for SPADE-RUSH

ISO	Material	Condition	Tensile strength (N/mm ²)	Hardness HB	Material No.	Cutting speed Vc (m/min)		
P	Non-alloy steel, cast steel, free cutting steel	<0.25%C	Annealed	420	125	1	80-140	
		>=0.25%C	Annealed	650	190	2	80-130	
		<0.55%C	Quenched and tempered	850	250	3	80-120	
		>=0.55%C	Annealed	750	220	4	70-110	
			Quenched and tempered	1000	300	5	50-90	
	Low alloy steel and cast steel (Less than 5% of alloying elements)		Annealed		600	200	6	80-120
					930	275	7	70-110
			Quenched and tempered		1000	300	8	50-90
					1200	350	9	40-70
	High alloy steel, cast steel and tool steel		Annealed	680	200	10	50-90	
			Quenched and tempered	1100	325	11	40-80	
M	Stainless steel and cast steel	Ferritic / martensitic	680	200	12	40-70		
		Martensitic	820	240	13	40-70		
		Austenitic	600	180	14	30-70		
K	Gray cast iron (GG)	Ferritic		160	15	90-180		
		Pearlitic		250	16	80-140		
	Cast iron nodular (GGG)	Ferritic		180	17	90-165		
		Pearlitic		260	18	80-140		
	Malleable cast iron	Ferritic		130	19	90-160		
	Pearlitic		230	20	80-140			
N	Aluminum - Wrought alloy	Not cureable		60	21	90-220		
		Cured		100	22	90-220		
	Aluminum-cast, alloyed	<=12% Si	Not cureable		75	23	90-220	
			Cured		90	24	90-220	
		>12% Si	High temp.		130	25	80-160	
	Copper alloys	>1% Pb	Free cutting		110	26	90-220	
			Brass		90	27	90-220	
			Electrolitic copper		100	28	90-220	
Non-metallic		Duroplastics, fiber plastics		70 Shore D	29			
		Hard rubber		55 Shore D	30			
S	High temp. alloys	Fe based	Annealed		200	31	30-60	
			Cured		280	32	20-50	
		Ni or Co based	Annealed		250	33	20-50	
			Cured		350	34	20-50	
			Cast		320	35	20-50	
	Titanium, Ti alloys	Pure	Rm 400	190	36	20-50		
		Alpha+beta alloys cured	Rm 1050	310	37	20-50		
H	Hardened steel	Hardened		55HRC	38	20-50		
		Hardened		60HRC	39	20-50		
	Chilled cast iron	Cast		400	40			
	Cast iron nodular	Hardened		55HRC	41			

► For more information of material groups, see the materials & grades "material conversion table"

■ Steel
 ■ Stainless steel
 ■ Cast iron
 ■ Nonferrous
 ■ High temp. alloys
 ■ Hardened steel

Recommended Cutting Conditions



Machining data for SPADE-RUSH

Feed (mm/rev) vs. drill diameter						
Ø20 - Ø25.9		Ø26 - Ø29.9		Ø30 - Ø34.9		Ø35 - Ø41
LCD...-P	LCD...-P+	LCD...-P	LCD...-P+	LCD...-P	LCD...-P+	
0.30-0.50	0.25-0.45	0.30-0.50	0.30-0.50	0.30-0.50	0.30-0.50	0.35-0.55
0.30-0.50	0.25-0.45	0.30-0.50	0.30-0.50	0.30-0.50	0.30-0.50	0.35-0.55
0.30-0.50	0.25-0.45	0.30-0.50	0.30-0.50	0.30-0.50	0.30-0.50	0.35-0.55
0.30-0.50	0.25-0.45	0.30-0.50	0.30-0.50	0.30-0.50	0.30-0.50	0.35-0.55
0.30-0.50	0.25-0.45	0.30-0.50	0.30-0.50	0.30-0.50	0.30-0.50	0.35-0.55
0.25-0.45	0.20-0.40	0.25-0.45	0.25-0.45	0.25-0.45	0.25-0.45	0.30-0.50
0.25-0.45	0.20-0.40	0.25-0.45	0.25-0.45	0.25-0.45	0.25-0.45	0.30-0.50
0.25-0.45	0.20-0.40	0.25-0.45	0.25-0.45	0.25-0.45	0.25-0.45	0.30-0.50
0.25-0.45	0.20-0.40	0.25-0.45	0.25-0.45	0.25-0.45	0.25-0.45	0.30-0.50
0.25-0.35	0.20-0.30	0.25-0.35	0.25-0.35	0.25-0.35	0.25-0.35	0.30-0.40
0.25-0.35	0.20-0.30	0.25-0.35	0.25-0.35	0.25-0.35	0.25-0.35	0.30-0.40
0.15-0.30		0.15-0.30		0.15-0.30		0.20-0.35
0.15-0.30		0.15-0.30		0.15-0.30		0.20-0.35
0.15-0.30		0.15-0.30		0.15-0.30		0.20-0.35
0.35-0.55	0.30-0.50	0.35-0.55	0.35-0.55	0.35-0.55	0.35-0.55	0.40-0.60
0.35-0.55	0.30-0.50	0.35-0.55	0.35-0.55	0.35-0.55	0.35-0.55	0.40-0.60
0.35-0.55	0.30-0.50	0.35-0.55	0.35-0.55	0.35-0.55	0.35-0.55	0.40-0.60
0.35-0.55	0.30-0.50	0.35-0.55	0.35-0.55	0.35-0.55	0.35-0.55	0.40-0.60
0.35-0.55	0.30-0.50	0.35-0.55	0.35-0.55	0.35-0.55	0.35-0.55	0.40-0.60
0.35-0.55	0.30-0.50	0.35-0.55	0.35-0.55	0.35-0.55	0.35-0.55	0.40-0.60
0.40-0.60		0.40-0.60		0.40-0.60		0.50-0.70
0.40-0.60		0.40-0.60		0.40-0.60		0.50-0.70
0.40-0.60		0.40-0.60		0.40-0.60		0.50-0.70
0.40-0.60		0.40-0.60		0.40-0.60		0.50-0.70
0.40-0.60		0.40-0.60		0.40-0.60		0.50-0.70
0.40-0.60		0.40-0.60		0.40-0.60		0.50-0.70
0.40-0.60		0.40-0.60		0.40-0.60		0.50-0.70
0.40-0.60		0.40-0.60		0.40-0.60		0.50-0.70
0.10-0.20		0.10-0.20		0.15-0.25		0.15-0.25
0.10-0.20		0.10-0.20		0.15-0.25		0.15-0.25
0.10-0.20		0.10-0.20		0.15-0.25		0.15-0.25
0.10-0.20		0.10-0.20		0.15-0.25		0.15-0.25
0.10-0.20		0.10-0.20		0.15-0.25		0.15-0.25
0.10-0.20		0.10-0.20		0.15-0.25		0.15-0.25
0.10-0.20		0.10-0.20		0.15-0.25		0.15-0.25
0.10-0.20		0.10-0.20		0.15-0.25		0.15-0.25
0.10-0.20		0.10-0.20		0.15-0.25		0.15-0.25

Recommended Cutting Conditions



Machining data for SOLID-3-DRILL

ISO	Material	Condition	Tensile strength (N/mm ²)	Hardness HB	Material No.	Cutting speed Vc (m/min)		
P	Non-alloy steel, cast steel, free cutting steel	<0.25%C	Annealed	420	125	1	80-140	
		>=0.25%C	Annealed	650	190	2	80-130	
		<0.55%C	Quenched and tempered	850	250	3	80-120	
		>=0.55%C	Annealed	750	220	4	70-110	
			Quenched and tempered	1000	300	5	50-90	
	Low alloy steel and cast steel (Less than 5% of alloying elements)		Annealed		600	200	6	80-120
					930	275	7	70-110
			Quenched and tempered		1000	300	8	50-90
					1200	350	9	40-70
	High alloy steel, cast steel and tool steel		Annealed	680	200	10	50-90	
			Quenched and tempered	1100	325	11	40-80	
M	Stainless steel and cast steel	Ferritic / martensitic	680	200	12			
		Martensitic	820	240	13			
		Austenitic	600	180	14			
K	Gray cast iron (GG)	Ferritic		160	15	80-140		
		Pearlitic		250	16	70-120		
	Cast iron nodular (GGG)	Ferritic		180	17	80-120		
		Pearlitic		260	18	70-110		
	Malleable cast iron	Ferritic		130	19	80-120		
Pearlitic			230	20	70-110			
N	Aluminum - Wrought alloy	Not cureable		60	21			
		Cured		100	22			
	Aluminum-cast, alloyed	<=12% Si	Not cureable		75	23		
			Cured		90	24		
		>12% Si	High temp.		130	25		
	Copper alloys	>1% Pb	Free cutting		110	26		
			Brass		90	27		
			Electrolitic copper		100	28		
Non-metallic		Duroplastics, fiber plastics		70 Shore D	29			
		Hard rubber		55 Shore D	30			
S	High temp. alloys	Fe based	Annealed		200	31		
			Cured		280	32		
		Ni or Co based	Annealed		250	33		
			Cured		350	34		
			Cast		320	35		
	Titanium, Ti alloys		Pure	Rm 400	190	36		
Alpha+beta alloys cured			Rm 1050	310	37			
H	Hardened steel	Hardened		55HRC	38			
		Hardened		60HRC	39			
	Chilled cast iron	Cast		400	40			
	Cast iron nodular	Hardened		55HRC	41			

► For more information of material groups, see the materials & grades "material conversion table"

■ Steel
 ■ Stainless steel
 ■ Cast iron
 ■ Nonferrous
 ■ High temp. alloys
 ■ Hardened steel

Recommended Cutting Conditions



Machining data for H-DRILL

ISO	Material	Condition	Tensile strength (N/mm ²)	Hardness HB	Material No.	Cutting speed Vc (m/min)	
P	Non-alloy steel, cast steel, free cutting steel	<0.25%C	Annealed	420	125	1	80-120
		>=0.25%C	Annealed	650	190	2	80-110
		<0.55%C	Quenched and tempered	850	250	3	70-100
		>=0.55%C	Annealed	750	220	4	70-100
			Quenched and tempered	1000	300	5	70-100
	Low alloy steel and cast steel (Less than 5% of alloying elements)	Quenched and tempered	Annealed	600	200	6	70-90
			930	275	7	70-90	
			1000	300	8	50-80	
			1200	350	9	40-70	
	High alloy steel, cast steel and tool steel	Annealed	680	200	10	50-80	
		Quenched and tempered	1100	325	11	40-70	
M	Stainless steel and cast steel	Ferritic / martensitic	680	200	12	30-60	
		Martensitic	820	240	13	30-60	
		Austenitic	600	180	14	30-60	
K	Gray cast iron (GG)	Ferritic		160	15	65-80	
		Pearlitic		250	16	65-80	
	Cast iron nodular (GGG)	Ferritic		180	17	85-105	
		Pearlitic		260	18	75-90	
	Malleable cast iron	Ferritic		130	19	65-80	
Pearlitic			230	20	65-80		
N	Aluminum - Wrought alloy	Not cureable		60	21	70-200	
		Cured		100	22	70-200	
	Aluminum-cast, alloyed	<=12% Si	Not cureable		75	23	70-200
			Cured		90	24	70-200
		>12% Si	High temp.		130	25	70-150
	Copper alloys	>1% Pb	Free cutting		110	26	70-200
		Brass			90	27	70-200
			Electrolytic copper		100	28	70-200
	Non-metallic		Duroplastics, fiber plastics		70 Shore D	29	
Hard rubber				55 Shore D	30		
S	High temp. alloys	Fe based	Annealed		200	31	15-40
			Cured		280	32	15-40
		Ni or Co based	Annealed		250	33	15-40
			Cured		350	34	15-40
			Cast		320	35	15-40
	Titanium, Ti alloys	Pure	Rm 400	190	36		
Alpha+beta alloys cured		Rm 1050	310	37			
H	Hardened steel	Hardened		55HRC	38	10-40	
		Hardened		60HRC	39	10-40	
	Chilled cast iron	Cast		400	40		
	Cast iron nodular	Hardened		55HRC	41		

► For more information of material groups, see the materials & grades "material conversion table"

■ Steel
 ■ Stainless steel
 ■ Cast iron
 ■ Nonferrous
 ■ High temp. alloys
 ■ Hardened steel

Recommended Cutting Conditions



Machining data for H-DRILL

Feed (mm/rev) vs. drill diameter		
Ø3 - Ø5	Ø5.1 - Ø8	Ø8.1 - Ø12
0.10-0.20	0.15-0.25	0.20-0.30
0.10-0.20	0.15-0.25	0.20-0.30
0.10-0.20	0.15-0.25	0.20-0.30
0.10-0.20	0.15-0.25	0.20-0.30
0.10-0.20	0.15-0.25	0.20-0.30
0.10-0.20	0.15-0.25	0.20-0.30
0.10-0.20	0.15-0.25	0.20-0.30
0.10-0.20	0.15-0.25	0.20-0.30
0.10-0.20	0.15-0.25	0.20-0.30
0.08-0.18	0.10-0.20	0.15-0.25
0.08-0.18	0.10-0.20	0.15-0.25
0.06-0.12	0.10-0.15	0.12-0.18
0.06-0.12	0.10-0.15	0.12-0.18
0.06-0.12	0.10-0.15	0.12-0.18
0.10-0.20	0.15-0.25	0.20-0.30
0.10-0.20	0.15-0.25	0.20-0.30
0.10-0.20	0.15-0.25	0.20-0.30
0.10-0.20	0.15-0.25	0.20-0.30
0.10-0.20	0.15-0.25	0.20-0.30
0.10-0.20	0.15-0.25	0.20-0.30
0.10-0.25	0.15-0.35	0.25-0.45
0.10-0.25	0.15-0.35	0.25-0.45
0.10-0.25	0.15-0.35	0.25-0.45
0.10-0.25	0.15-0.35	0.25-0.45
0.10-0.25	0.15-0.35	0.25-0.45
0.08-0.18	0.15-0.25	0.20-0.35
0.08-0.18	0.15-0.25	0.20-0.35
0.08-0.18	0.15-0.25	0.20-0.35
0.02-0.08	0.04-0.10	0.06-0.12
0.02-0.08	0.04-0.10	0.06-0.12
0.02-0.08	0.04-0.10	0.06-0.12
0.02-0.08	0.04-0.10	0.06-0.12
0.02-0.08	0.04-0.10	0.06-0.12
0.02-0.08	0.04-0.10	0.06-0.12
0.02-0.08	0.04-0.10	0.06-0.12

Recommended Cutting Conditions



Machining data for TBTA 3/5/7/9 & TBTA-R

ISO	Material	Condition	Tensile strength (N/mm ²)	Hardness HB	Material No.	Cutting speed Vc (m/min)	
P	Non-alloy steel, cast steel, free cutting steel	<0.25%C	Annealed	420	125	1	60-120
		>=0.25%C	Annealed	650	190	2	60-120
		<0.55%C	Quenched and tempered	850	250	3	60-120
		>=0.55%C	Annealed	750	220	4	60-120
			Quenched and tempered	1000	300	5	50-100
	Low alloy steel and cast steel (Less than 5% of alloying elements)	Quenched and tempered	Annealed	600	200	6	50-100
			930	275	7	50-100	
			1000	300	8	50-100	
			1200	350	9	50-100	
	High alloy steel, cast steel and tool steel	Annealed	680	200	10	60-120	
		Quenched and tempered	1100	325	11	60-120	
M	Stainless steel and cast steel	Ferritic / martensitic	680	200	12	60-110	
		Martensitic	820	240	13	60-110	
		Austenitic	600	180	14	60-110	
K	Gray cast iron (GG)	Ferritic		160	15	60-100	
		Pearlitic		250	16	60-100	
	Cast iron nodular (GGG)	Ferritic		180	17	60-100	
		Pearlitic		260	18	60-100	
	Malleable cast iron	Ferritic		130	19	60-100	
Pearlitic			230	20	60-100		
N	Aluminum - Wrought alloy	Not cureable		60	21	60-130	
		Cured		100	22	60-130	
	Aluminum-cast, alloyed	<=12% Si	Not cureable		75	23	60-130
		Cured		90	24	60-130	
	>12% Si	High temp.		130	25	60-130	
		>1% Pb	Free cutting		110	26	60-130
	Copper alloys	Brass		90	27	60-130	
		Electrolitic copper		100	28	60-130	
	Non-metallic	Duroplastics, fiber plastics		70 Shore D	29		
		Hard rubber		55 Shore D	30		
S	High temp. alloys	Fe based	Annealed		200	31	20-65
			Cured		280	32	20-65
		Ni or Co based	Annealed		250	33	20-65
			Cured		350	34	20-65
			Cast		320	35	20-65
	Titanium, Ti alloys	Pure	Rm 400	190	36	30-100	
		Alpha+beta alloys cured	Rm 1050	310	37	30-100	
H	Hardened steel	Hardened		55HRC	38		
		Hardened		60HRC	39		
	Chilled cast iron	Cast		400	40		
	Cast iron nodular	Hardened		55HRC	41		

► For more information of material groups, see the materials & grades "material conversion table"

■ Steel
 ■ Stainless steel
 ■ Cast iron
 ■ Nonferrous
 ■ High temp. alloys
 ■ Hardened steel

Recommended Cutting Conditions



Machining data for TBTA-FB

ISO	Material	Condition	Tensile strength (N/mm ²)	Hardness HB	Material No.	Cutting speed Vc (m/min)		
P	Non-alloy steel, cast steel, free cutting steel	<0.25%C	Annealed	420	125	1	70-130	
		>=0.25%C	Annealed	650	190	2	70-130	
		<0.55%C	Quenched and tempered	850	250	3	70-130	
		>=0.55%C	Annealed	750	220	4	70-130	
			Quenched and tempered	1000	300	5	70-130	
	Low alloy steel and cast steel (Less than 5% of alloying elements)		Annealed		600	200	6	70-120
					930	275	7	60-120
			Quenched and tempered		1000	300	8	60-120
					1200	350	9	60-120
	High alloy steel, cast steel and tool steel		Annealed	680	200	10	70-130	
			Quenched and tempered	1100	325	11	70-130	
M	Stainless steel and cast steel	Ferritic / martensitic	680	200	12	70-130		
		Martensitic	820	240	13	70-130		
		Austenitic	600	180	14	70-130		
K	Gray cast iron (GG)	Ferritic		160	15	60-110		
		Pearlitic		250	16	60-110		
	Cast iron nodular (GGG)	Ferritic		180	17	50-110		
		Pearlitic		260	18	50-110		
	Malleable cast iron	Ferritic		130	19	70-110		
Pearlitic			230	20	70-110			
N	Aluminum - Wrought alloy	Not cureable		60	21	65-130		
		Cured		100	22	65-130		
	Aluminum-cast, alloyed	<=12% Si	Not cureable		75	23	65-130	
			Cured		90	24	65-130	
		>12% Si	High temp.		130	25	65-130	
	Copper alloys	>1% Pb	Free cutting		110	26	65-130	
			Brass		90	27	65-130	
			Electrolitic copper		100	28	65-130	
	Non-metallic		Duroplastics, fiber plastics		70 Shore D	29		
			Hard rubber		55 Shore D	30		
S	High temp. alloys	Fe based	Annealed		200	31	20-50	
			Cured		280	32	20-50	
		Ni or Co based	Annealed		250	33	20-50	
			Cured		350	34	20-50	
			Cast		320	35	20-50	
	Titanium, Ti alloys		Pure	Rm 400	190	36	30-60	
			Alpha+beta alloys cured	Rm 1050	310	37	30-60	
H	Hardened steel	Hardened		55HRC	38			
		Hardened		60HRC	39			
	Chilled cast iron	Cast		400	40			
	Cast iron nodular	Hardened		55HRC	41			

► For more information of material groups, see the materials & grades "material conversion table"

■ Steel
 ■ Stainless steel
 ■ Cast iron
 ■ Nonferrous
 ■ High temp. alloys
 ■ Hardened steel

Recommended Cutting Conditions



Machining data for BTA & BTS

ISO	Material	Condition	Tensile strength (N/mm ²)	Hardness HB	Material No.	Cutting speed Vc (m/min)		
P	Non-alloy steel, cast steel, free cutting steel	<0.25%C	Annealed	420	125	1	70-120	
		>=0.25%C	Annealed	650	190	2	70-120	
		<0.55%C	Quenched and tempered	850	250	3	40-70	
		>=0.55%C	Annealed	750	220	4	70-120	
			Quenched and tempered	1000	300	5	55-100	
	Low alloy steel and cast steel (Less than 5% of alloying elements)		Annealed		600	200	6	70-100
					930	275	7	55-100
			Quenched and tempered		1000	300	8	55-100
					1200	350	9	55-100
	High alloy steel, cast steel and tool steel		Annealed	680	200	10	50-85	
			Quenched and tempered	1100	325	11	55-100	
M	Stainless steel and cast steel	Ferritic / martensitic	680	200	12	60-100		
		Martensitic	820	240	13	60-100		
		Austenitic	600	180	14	60-100		
K	Gray cast iron (GG)	Ferritic		160	15	60-100		
		Pearlitic		250	16	60-100		
	Cast iron nodular (GGG)	Ferritic		180	17	80-100		
		Pearlitic		260	18	80-100		
	Malleable cast iron	Ferritic		130	19	50-100		
Pearlitic			230	20	50-100			
N	Aluminum - Wrought alloy	Not cureable		60	21	65-130		
		Cured		100	22	65-100		
	Aluminum-cast, alloyed	<=12% Si	Not cureable		75	23	65-130	
			Cured		90	24	65-130	
		>12% Si	High temp.		130	25	65-130	
	Copper alloys	>1% Pb	Free cutting		110	26	65-130	
			Brass		90	27	65-130	
			Electrolitic copper		100	28	65-130	
	Non-metallic		Duroplastics, fiber plastics		70 Shore D	29		
			Hard rubber		55 Shore D	30		
S	High temp. alloys	Fe based	Annealed		200	31	10-50	
			Cured		280	32	10-50	
		Ni or Co based	Annealed		250	33	10-50	
			Cured		350	34	10-50	
			Cast		320	35	10-50	
	Titanium, Ti alloys		Pure	Rm 400	190	36	30-50	
Alpha+beta alloys cured			Rm 1050	310	37	30-50		
H	Hardened steel	Hardened		55HRC	38			
		Hardened		60HRC	39			
	Chilled cast iron	Cast		400	40			
	Cast iron nodular	Hardened		55HRC	41			

► For more information of material groups, see the materials & grades "material conversion table"

■ Steel
 ■ Stainless steel
 ■ Cast iron
 ■ Nonferrous
 ■ High temp. alloys
 ■ Hardened steel

Recommended Cutting Conditions



Machining data for WIN-GUN

ISO	Material	Condition	Tensile strength (N/mm ²)	Hardness HB	Material No.	Cutting speed Vc (m/min)	
P	Non-alloy steel, cast steel, free cutting steel	<0.25%C	Annealed	420	125	1	80-110-140
		>=0.25%C	Annealed	650	190	2	80-105-130
		<0.55%C	Quenched and tempered	850	250	3	80-100-120
		>=0.55%C	Annealed	750	220	4	70-90-110
			Quenched and tempered	1000	300	5	50-70-90
	Low alloy steel and cast steel (Less than 5% of alloying elements)		Annealed	600	200	6	80-100-120
			Quenched and tempered	930	275	7	70-90-110
				1000	300	8	50-70-90
				1200	350	9	40-55-70
	High alloy steel, cast steel and tool steel		Annealed	680	200	10	50-70-90
			Quenched and tempered	1100	325	11	40-60-80
M	Stainless steel and cast steel	Ferritic / martensitic	680	200	12	40-55-70	
		Martensitic	820	240	13		
K	Gray cast iron (GG)	Ferritic		160	15	90-125-160	
		Pearlitic		250	16	80-110-140	
	Cast iron nodular (GGG)	Ferritic		180	17	90-135-180	
		Pearlitic		260	18	80-110-140	
	Malleable cast iron	Ferritic		130	19	90-125-160	
		Pearlitic		230	20	80-110-140	
N	Aluminum - Wrought alloy	Not cureable		60	21	90-155-220	
		Cured		100	22		
	Aluminum-cast, alloyed	<=12% Si	Not cureable		75		23
			Cured		90		24
		>12% Si	High temp.		130		25

► For more information of material groups, see the materials & grades "material conversion table"

■ Steel
 ■ Stainless steel
 ■ Cast iron
 ■ Nonferrous

Pressure and Coolant Flow Rate for WIN-GUN

Pressure (Bar)

Coolant Flow Rate (l/min)

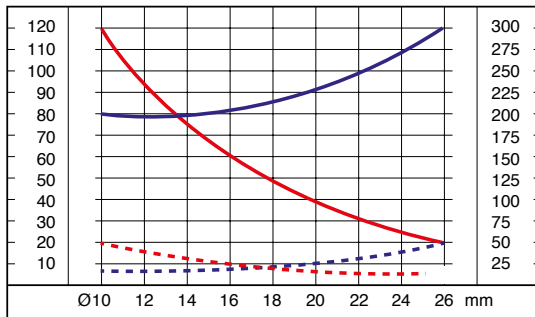

Drilling Diameter (mm)

Q (l/min) **P (bar)**
— — GUN-DRILL Machines
- - - - - - Milling and Turning Machines

Recommended Cutting Conditions



Machining data for WIN-GUN

Feed (mm/rev) vs. drill diameter				
Ø10 - Ø11.9	Ø12 - Ø13.9	Ø14 - Ø15.9	Ø16 - Ø19.9	Ø20 - Ø25.9
0.15 0.18 0.21	0.18 0.21 0.24	0.20 0.23 0.27	0.25 0.30 0.35	0.25 0.30 0.35
0.14 0.17 0.21	0.16 0.20 0.24	0.18 0.22 0.26	0.23 0.27 0.31	0.25 0.30 0.35
0.12 0.14 0.17	0.15 0.17 0.20	0.18 0.20 0.23	0.20 0.22 0.25	0.22 0.24 0.27
0.12 0.13 0.15	0.14 0.15 0.17	0.16 0.18 0.20	0.16 0.19 0.21	0.18 0.21 0.24
0.20 0.23 0.27	0.25 0.28 0.32	0.30 0.33 0.37	0.35 0.40 0.45	0.35 0.42 0.47
0.25 0.28 0.32	0.30 0.33 0.37	0.35 0.38 0.42	0.40 0.45 0.50	0.45 0.50 0.57

- ▶ **Red text:** Recommended cutting data
- ▶ Mandatory use of emulsion or oil when drilling
- ▶ For the 400 mm long tools, please reduce the cutting speed by 20%

Recommended Cutting Conditions



Machining data for TRGD / TRGD3 / TRGDL / TBTA-TR

ISO	Material	Condition	Tensile strength (N/mm ²)	Hardness HB	Material No.	
P	Non-alloy steel, cast steel, free cutting steel	<0.25%C	Annealed	420	125	1
		>=0.25%C	Annealed	650	190	2
		<0.55%C	Quenched and tempered	850	250	3
		>=0.55%C	Annealed	750	220	4
			Quenched and tempered	1000	300	5
	Low alloy steel and cast steel (Less than 5% of alloying elements)	Quenched and tempered	Annealed	600	200	6
			930	275	7	
			1000	300	8	
			1200	350	9	
	High alloy steel, cast steel and tool steel	Annealed	680	200	10	
		Quenched and tempered	1100	325	11	
M	Stainless steel and cast steel	Ferritic / martensitic	680	200	12	
		Martensitic	820	240	13	
		Austenitic	600	180	14	
K	Gray cast iron (GG)	Ferritic		160	15	
		Pearlitic		250	16	
	Cast iron nodular (GGG)	Ferritic		180	17	
		Pearlitic		260	18	
	Malleable cast iron	Ferritic		130	19	
		Pearlitic		230	20	
N	Aluminum - Wrought alloy	Not cureable		60	21	
		Cured		100	22	
	Aluminum-cast, alloyed	<=12% Si	Not cureable		75	23
			Cured		90	24
		>12% Si	High temp.		130	25
	Copper alloys	>1% Pb	Free cutting		110	26
			Brass		90	27
		Electrolitic copper		100	28	
Non-metallic		Duroplastics, fiber plastics		70 Shore D	29	
		Hard rubber		55 Shore D	30	
S	High temp. alloys	Fe based	Annealed		200	31
			Cured		280	32
		Ni or Co based	Annealed		250	33
			Cured		350	34
	Titanium, Ti alloys	Cast		320	35	
		Pure	Rm 400	190	36	
	Alpha+beta alloys cured	Rm 1050	310	37		
H	Hardened steel	Hardened		55 HRC	38	
		Hardened		60 HRC	39	
	Chilled cast iron	Cast		400	40	
	Cast iron nodular	Hardened		55 HRC	41	

► For more information of material groups, see the materials & grades "material conversion table"

■ Steel
 ■ Stainless steel
 ■ Cast iron
 ■ Nonferrous
 ■ High temp. alloys
 ■ Hardened steel

Recommended Cutting Conditions



Machining data for TRGD / TRGD3 / TRGD L / TBTA-TR

Feed (mm/rev) vs. drill diameter							
TRGD / TRGD3 / TRGD L						TBTA-TR	
Cutting speed Vc (m/min)	Ø10.00-Ø11.80	Ø12.00-Ø13.99	Ø14.00-Ø15.99	Ø16.00-Ø28.00	Ø28.01-Ø40.00	Cutting speed Vc (m/min)	Ø16.00-Ø28.00
80-140	0.05-0.08	0.05-0.10	0.05-0.10	0.05-0.10	0.05-0.15	90-130	0.15-0.20
80-140	0.05-0.14	0.05-0.16	0.05-0.10	0.05-0.10	0.05-0.15	90-130	0.15-0.20
80-140	0.05-0.14	0.05-0.16	0.05-0.16	0.05-0.20	0.05-0.20	90-130	0.15-0.20
80-140	0.05-0.14	0.05-0.16	0.05-0.16	0.05-0.20	0.05-0.20	70-130	0.10-0.25
80-140	0.05-0.14	0.05-0.16	0.05-0.16	0.05-0.20	0.05-0.20	70-130	0.10-0.25
80-140	0.05-0.14	0.05-0.16	0.05-0.10	0.05-0.10	0.05-0.15	70-120	0.10-0.25
80-120	0.05-0.14	0.05-0.16	0.05-0.16	0.05-0.20	0.05-0.20	60-120	0.10-0.25
80-120			0.05-0.16	0.05-0.20	0.05-0.20	60-120	0.10-0.25
80-120			0.05-0.16	0.05-0.20	0.05-0.20	60-120	0.10-0.25
80-140			0.05-0.10	0.05-0.10	0.05-0.15	70-130	0.10-0.25
80-120			0.05-0.16	0.05-0.20	0.05-0.20	70-130	0.10-0.25
60-100	0.05-0.08	0.05-0.10	0.05-0.10	0.05-0.10	0.05-0.15	80-130	0.06-0.10
60-100	0.05-0.08	0.05-0.10	0.05-0.10	0.05-0.10	0.05-0.15	80-130	0.06-0.10
60-100	0.05-0.08	0.05-0.10	0.05-0.10	0.05-0.10	0.05-0.15	80-130	0.06-0.10
80-140	0.05-0.20	0.05-0.25	0.05-0.25	0.05-0.30	0.05-0.30	50-110	0.10-0.20
80-140	0.05-0.20	0.05-0.25	0.05-0.25	0.05-0.30	0.05-0.30	50-110	0.10-0.20
80-140	0.05-0.20	0.05-0.25	0.05-0.25	0.05-0.30	0.05-0.30	60-110	0.10-0.20
80-140	0.05-0.20	0.05-0.25	0.05-0.25	0.05-0.30	0.05-0.30	60-110	0.10-0.20
80-140			0.05-0.25	0.05-0.30	0.05-0.30	70-110	0.10-0.20
80-140			0.05-0.25	0.05-0.30	0.05-0.30	70-110	0.10-0.20
100-200	0.05-0.18	0.05-0.20	0.05-0.20	0.05-0.20	0.05-0.25	65-130	0.08-0.18
100-200	0.05-0.18	0.05-0.20	0.05-0.20	0.05-0.20	0.05-0.25	65-130	0.08-0.18
100-200	0.05-0.18	0.05-0.20	0.05-0.20	0.05-0.20	0.05-0.25	65-130	0.08-0.18
100-200	0.05-0.18	0.05-0.20	0.05-0.20	0.05-0.20	0.05-0.25	65-130	0.08-0.18
						65-130	0.08-0.18
						65-130	0.08-0.18
						65-130	0.08-0.18
						65-130	0.08-0.18
						65-130	0.08-0.18
						65-130	0.08-0.18
20-50	0.04-0.06	0.04-0.08	0.04-0.08	0.04-0.10	0.04-0.13	20-50	0.08-0.18
20-50	0.04-0.06	0.04-0.08	0.04-0.08	0.04-0.10	0.04-0.13	20-50	0.08-0.18
20-50	0.04-0.06	0.04-0.08	0.04-0.08	0.04-0.10	0.04-0.13	20-50	0.08-0.18
20-50	0.04-0.06	0.04-0.08	0.04-0.08	0.04-0.10	0.04-0.13	20-50	0.08-0.18
20-50	0.04-0.06	0.04-0.08	0.04-0.08	0.04-0.10	0.04-0.13	20-50	0.08-0.18
30-60	0.04-0.10	0.05-0.13	0.05-0.13	0.05-0.15	0.05-0.18	30-60	0.08-0.18
30-60	0.04-0.10	0.05-0.13	0.05-0.13	0.05-0.15	0.05-0.18	30-60	0.08-0.18
50-100	0.04-0.06	0.04-0.08	0.04-0.08	0.04-0.10	0.04-0.13		
50-100	0.04-0.06	0.04-0.08	0.04-0.08	0.04-0.10	0.04-0.13		
50-100	0.04-0.06	0.04-0.08	0.04-0.08	0.04-0.10	0.04-0.13		
50-100	0.04-0.06	0.04-0.08	0.04-0.08	0.04-0.10	0.04-0.13		

Recommended Cutting Conditions



Machining data for XM-REAM

ISO	Material	Condition	Tensile strength (N/mm ²)	Hardness HB	Material No.	Cutting speed Vc (m/min)	Feed (mm/rev) vs. reamer diameter			
							Ø8-9.99	Ø10-11.99	Ø12-12.99	
P	Non-alloy steel, cast steel, free cutting steel	<0.25%C	Annealed	420	125	1	50-150	0.25-0.50	0.30-0.60	0.35-0.80
		>=0.25%C	Annealed	650	190	2	50-150	0.25-0.50	0.30-0.60	0.35-0.80
		<0.55%C	Quenched and tempered	850	250	3	50-150	0.25-0.50	0.30-0.60	0.35-0.80
		>=0.55%C	Annealed	750	220	4	50-150	0.25-0.50	0.30-0.60	0.35-0.80
			Quenched and tempered	1000	300	5	50-150	0.25-0.50	0.30-0.60	0.35-0.80
	Low alloy steel and cast steel (Less than 5% of alloying elements)	Annealed	600	200	6	50-150	0.25-0.50	0.30-0.60	0.35-0.80	
			930	275	7	50-150	0.25-0.50	0.30-0.60	0.35-0.80	
		Quenched and tempered	1000	300	8	50-150	0.25-0.50	0.30-0.60	0.35-0.80	
			1200	350	9	50-150	0.25-0.50	0.30-0.60	0.35-0.80	
	High alloy steel, cast steel and tool steel	Annealed	680	200	10	20-60	0.20-0.30	0.25-0.40	0.30-0.50	
		Quenched and tempered	1100	325	11	20-60	0.20-0.30	0.25-0.40	0.30-0.50	
M	Stainless steel and cast steel	Ferritic / martensitic	680	200	12	20-40	0.20-0.30	0.25-0.40	0.30-0.50	
		Martensitic	820	240	13	20-40	0.20-0.30	0.25-0.40	0.30-0.50	
		Austenitic	600	180	14	20-40	0.20-0.30	0.25-0.40	0.30-0.50	
K	Gray cast iron (GG)	Ferritic		160	15	50-200	0.30-0.60	0.35-0.80	0.40-1.00	
		Pearlitic		250	16	50-200	0.30-0.60	0.35-0.80	0.40-1.00	
	Cast iron nodular (GGG)	Ferritic		180	17	50-200	0.30-0.60	0.35-0.80	0.40-1.00	
		Pearlitic		260	18	50-200	0.30-0.60	0.35-0.80	0.40-1.00	
	Malleable cast iron	Ferritic		130	19	50-200	0.30-0.60	0.35-0.80	0.40-1.00	
Pearlitic			230	20	50-200	0.30-0.60	0.35-0.80	0.40-1.00		
N	Aluminum - Wrought alloy	Not cureable		60	21	100-250	0.30-0.60	0.35-0.80	0.40-1.00	
		Cured		100	22	100-250	0.30-0.60	0.35-0.80	0.40-1.00	
	Aluminum-cast, alloyed	<=12% Si	Not cureable		75	23	100-250	0.30-0.60	0.35-0.80	0.40-1.00
		Cured		90	24	100-250	0.30-0.60	0.35-0.80	0.40-1.00	
	>12% Si	High temp.		130	25	100-250	0.30-0.60	0.35-0.80	0.40-1.00	
	Copper alloys	>1% Pb	Free cutting		110	26	100-250	0.30-0.60	0.35-0.80	0.40-1.00
		Brass			90	27	100-250	0.30-0.60	0.35-0.80	0.40-1.00
			Electrolitic copper		100	28	100-250	0.30-0.60	0.35-0.80	0.40-1.00
	Non-metallic	Duroplastics, fiber plastics		70 Shore D	29					
Hard rubber			55 Shore D	30						
S	High temp. alloys	Fe based	Annealed		200	31				
			Cured		280	32				
		Ni or Co based	Annealed		250	33				
			Cured		350	34				
			Cast		320	35				
	Titanium, Ti alloys	Pure	Rm 400	190	36					
Alpha+beta alloys cured		Rm 1050	310	37						
H	Hardened steel	Hardened		55 HRC	38					
		Hardened		60 HRC	39					
	Chilled cast iron	Cast		400	40					
	Cast iron nodular	Hardened		55 HRC	41					

► For more information of material groups, see the materials & grades "material conversion table"

■ Steel
 ■ Stainless steel
 ■ Cast iron
 ■ Nonferrous
 ■ High temp. alloys
 ■ Hardened steel

Recommended Cutting Conditions



Machining data for TM-REAM - Through hole

ISO	Material	Condition	Material No.	Through hole		Interrupted through Hole		
P	Non-alloy steel, cast steel, free cutting steel	<0.25%C	Annealed	1	TT9030	BL	TT9030	BL
		>=0.25%C	Annealed	2	Vc = 80 - 200		Vc = 60 - 120	
		<0.55%C	Quenched and tempered	3	B4 - B6	fz = 0.08 - 0.21	B4 - B6	fz = 0.08 - 0.21
		>=0.55%C	Annealed	4				
		Quenched and tempered	5	B7 - B9	fz = 0.12 - 0.27	B7 - B9	fz = 0.09 - 0.21	
	Low alloy steel and cast steel (Less than 5% of alloying elements)	Annealed	6	TT9030	BL	TT9030	BL	
		Quenched and tempered	7	Vc = 80 - 200		Vc = 60 - 120		
			8	B4 - B6	fz = 0.08 - 0.21	B4 - B6	fz = 0.08 - 0.21	
			9	B7 - B9	fz = 0.12 - 0.27	B7 - B9	fz = 0.09 - 0.21	
	High alloy steel, cast steel and tool steel	Annealed	10	TT9030	BL	TT9030	BL	
		Quenched and tempered	11	Vc = 20 - 60		Vc = 20 - 60		
			B4 - B6	fz = 0.05 - 0.13	B4 - B6	fz = 0.04 - 0.11		
M	Stainless steel and cast steel	Ferritic / martensitic	12	TT9030	BL	TT9030	BL	
			13	Vc = 20 - 40		Vc = 20 - 40		
		Martensitic	14	B4 - B6	fz = 0.05 - 0.13	B4 - B6	fz = 0.04 - 0.11	
K	Gray cast iron (GG)	Austenitic	14	B7 - B9	fz = 0.07 - 0.17	B7 - B9	fz = 0.05 - 0.14	
		Ferritic	15	TT9030	BL	TT9030	BL	
	Cast iron nodular (GGG)	Pearlitic	16	Vc = 120 - 220		Vc = 80 - 200		
			17	B4 - B6	fz = 0.08 - 0.18	B4 - B6	fz = 0.05 - 0.13	
	Malleable cast iron	Ferritic	17	B7 - B9	fz = 0.10 - 0.24	B7 - B9	fz = 0.07 - 0.17	
			18	TT9030	AS or BL	TT9030	BL	
		Pearlitic	18	Vc = 160 - 280		Vc = 150 - 250		
			19	B4 - B6	fz = 0.11 - 0.20	B4 - B6	fz = 0.06 - 0.15	
		20	B7 - B9	fz = 0.11 - 0.24	B7 - B9	fz = 0.08 - 0.19		
		19	TT9030	AS or BL	TT9030	BL		
		20	Vc = 100 - 220		Vc = 100 - 220			
			B4 - B6	fz = 0.11 - 0.20	B4 - B6	fz = 0.06 - 0.15		
			B7 - B9	fz = 0.11 - 0.24	B7 - B9	fz = 0.08 - 0.20		

► For more information of material groups, see the materials & grades "material conversion table"

■ Steel
 ■ Stainless steel
 ■ Cast iron
 ■ Nonferrous
 ■ High temp. alloys
 ■ Hardened steel

Recommended Cutting Conditions



Machining data for TM-REAM - Through hole

ISO	Material	Condition	Material No.	Through hole		Interrupted through Hole		
N	Aluminum - Wrought alloy	Not cureable	21	B7 - B9	BL or GS	UF10	BL	
		Cured	22	Vc = 150 - 400		Vc = 150 - 400		
	Aluminum-cast, alloyed	<=12% Si	Not cureable	23	B4 - B6	fz = 0.08 - 0.16	B4 - B6	fz = 0.08 - 0.16
			Cured	24				
		>12% Si	High temp.	25	B7 - B9	fz = 0.10 - 0.20	B7 - B9	fz = 0.10 - 0.20
	Copper alloys	>1% Pb	Free cutting	26	TT9030	BL	TT9030	BL
					Vc = 50 - 200		Vc = 50 - 200	
		Brass	27	B4 - B6	fz = 0.08 - 0.18	B4 - B6	fz = 0.05 - 0.13	
	Electrolytic copper		28	B7 - B9	fz = 0.10 - 0.23	B7 - B9	fz = 0.07 - 0.16	
	Non-metallic	Duroplastics, fiber plastics	29	TT9030	AS	TT9030	AS	
Vc = 25 - 80				Vc = 25 - 80				
Hard rubber			30	B4 - B6	fz = 0.05 - 0.10	B4 - B6	fz = 0.05 - 0.10	
S	High temp. alloys	Fe based	Annealed	31	TT9030	L *	TT9030	L *
			Cured	32	Vc = 15 - 50		Vc = 15 - 50	
		Ni or Co based	Annealed	33	B4 - B6	fz = 0.04 - 0.10	B4 - B6	fz = 0.03 - 0.08
	Cured	34						
	Cast	35						
	Titanium, Ti alloys	Pure	36	B7 - B9	fz = 0.05 - 0.13	B4 - B6	fz = 0.04 - 0.11	
Alpha+beta alloys cured		37						
H	Hardened steel	Hardened	38	TT9030	BL	TT9030	BL	
		Hardened	39	Vc = 25 - 50		Vc = 25 - 50		
	Chilled cast iron	Cast	40	B4 - B6	fz = 0.06 - 0.15	B4 - B6	fz = 0.06 - 0.15	
Cast iron nodular	Hardened	41	B7 - B9	fz = 0.10 - 0.20	B7 - B9	fz = 0.10 - 0.20		

* Standard edge geometries are not suitable for reaming titanium and high temperature alloys. In order to choose a proper geometry, please ask for our recommendations.

- ▶ The given cutting data recommendations refer to the short holders (3xD effective reaming overhang). For longer holders, the cutting speed to be reduced proportionally.
- ▶ For relatively large leading angles (spot-facing geometries), the feed to be reduced up to 30%.
- ▶ All the given cutting data recommendations refer to the machines with spindle through coolant supply.

Legend:

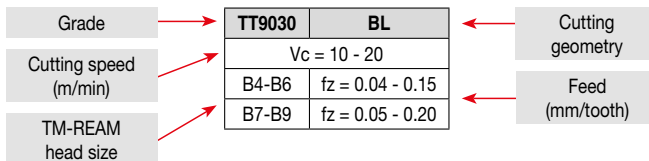

Recommended Cutting Conditions



Machining data for TM-REAM - Blind hole

ISO	Material	Condition	Material No.	Blind hole		Interrupted blind hole		
P	Non-alloy steel, cast steel, free cutting steel	<0.25%C	Annealed	1	TT9030	AS	TT9030	AS
		>=0.25%C	Annealed	2	Vc = 60-160		Vc = 60 - 120	
		<0.55%C	Quenched and tempered	3	B4 - B6	fz = 0.06 - 0.18	B4 - B6	fz = 0.05 - 0.15
		>=0.55%C	Annealed	4				
			Quenched and tempered	5	B7 - B9	fz = 0.08 - 0.20	B7 - B9	fz = 0.07 - 0.16
	Low alloy steel and cast steel (Less than 5% of alloying elements)	Annealed	6	TT9030	AS	TT9030	AS	
		Quenched and tempered	7	Vc = 60-160		Vc = 60 - 120		
			8	B4 - B6	fz = 0.06 - 0.18	B4 - B6	fz = 0.05 - 0.15	
			9	B7 - B9	fz = 0.08 - 0.20	B7 - B9	fz = 0.07 - 0.16	
	High alloy steel, cast steel and tool steel	Annealed	10	TT9030	AS	TT9030	AS	
		Quenched and tempered	11	Vc = 20 - 60		Vc = 20 - 60		
			B4 - B6	fz = 0.04 - 0.10	B4 - B6	fz = 0.03 - 0.08		
M	Stainless steel and cast steel	Ferritic / martensitic	12	TT9030	AS	TT9030	AS	
				Vc = 20 - 40		Vc = 20 - 40		
		Martensitic	13	B4 - B6	fz = 0.04 - 0.10	B4 - B6	fz = 0.03 - 0.08	
		Austenitic	14	B7 - B9	fz = 0.05 - 0.13	B7 - B9	fz = 0.05 - 0.10	
K	Gray cast iron (GG)	Ferritic	15	TT9030	AS	TT9030	AS	
			Vc = 80 - 200		Vc = 60 - 120			
	Pearlitic	16	B4 - B6	fz = 0.06 - 0.18	B4 - B6	fz = 0.05 - 0.13		
			B7 - B9	fz = 0.08 - 0.23	B7 - B9	fz = 0.08 - 0.18		
	Cast iron nodular (GGG)	Ferritic	17	TT9030	AS	TT9030	AS	
			Vc = 160 - 280		Vc = 160 - 240			
	Pearlitic	18	B4 - B6	fz = 0.06 - 0.18	B4 - B6	fz = 0.06 - 0.16		
			B7 - B9	fz = 0.08 - 0.23	B7 - B9	fz = 0.08 - 0.18		
Malleable cast iron	Ferritic	19	TT9030	AS	TT9030	AS		
		Vc = 100 - 220		Vc = 100 - 220				
	Pearlitic	20	B4 - B6	fz = 0.06 - 0.18	B4 - B6	fz = 0.05 - 0.15		
		B7 - B9	fz = 0.08 - 0.23	B7 - B9	fz = 0.08 - 0.20			

► For more information of material groups, see the materials & grades "material conversion table"

■ Steel
 ■ Stainless steel
 ■ Cast iron
 ■ Nonferrous
 ■ High temp. alloys
 ■ Hardened steel

Recommended Cutting Conditions



Machining data for TM-REAM - Blind hole

ISO	Material	Condition	Material No.	Blind hole		Interrupted blind hole		
N	Aluminum - Wrought alloy	Not cureable	21	UF10	GS or AS	UF10	GS or AS	
		Cured	22	Vc = 150 - 400		Vc = 150 - 300		
	Aluminum-cast, alloyed	<=12% Si	Not cureable	23	B4 - B6	fz = 0.08 - 0.16	B4 - B6	fz = 0.07 - 0.15
			Cured	24				
		>12% Si	High temp.	25	B7 - B9	fz = 0.11 - 0.20	B7 - B9	fz = 0.11 - 0.20
	Copper alloys	>1% Pb	Free cutting	26	TT9030	AS	TT9030	AS
					Vc = 50 - 200		Vc = 50 - 200	
		Brass	27	B4 - B6	fz = 0.08 - 0.16	B4 - B6	fz = 0.08 - 0.16	
	Electrolytic copper		28	B7 - B9	fz = 0.10 - 0.20	B7 - B9	fz = 0.10 - 0.20	
	Non-metallic	Duroplastics, fiber plastics	29	TT9030	AS	TT9030	AS	
				Vc = 25 - 80		Vc = 25 - 80		
			Hard rubber	30	B4 - B6	fz = 0.05 - 0.10	B4 - B6	fz = 0.05 - 0.10
S	High temp. alloys	Fe based	Annealed	31	TT9030	L *	TT9030	L *
			Cured	32	Vc = 15 - 50		Vc = 15 - 50	
		Ni or Co based	Annealed	33	B4 - B6	fz = 0.03 - 0.08	B4 - B6	fz = 0.03 - 0.08
	Cured	34						
	Cast	35						
	Titanium, Ti alloys	Pure	36	B7 - B9	fz = 0.04 - 0.11	B7 - B9	fz = 0.04 - 0.11	
Alpha+beta alloys cured		37						
H	Hardened steel	Hardened	38	TT9030	AS	TT9030	AS	
		Hardened	39	Vc = 25 - 50		Vc = 25 - 50		
	Chilled cast iron	Cast	40	B4 - B6	fz = 0.05 - 0.13	B4 - B6	fz = 0.05 - 0.13	
Cast iron nodular	Hardened	41	B7 - B9	fz = 0.10 - 0.20	B7 - B9	fz = 0.10 - 0.20		

* Standard edge geometries are not suitable for reaming titanium and high temperature alloys. In order to choose a proper geometry, please ask for our recommendations.

- ▶ The given cutting data recommendations refer to the short holders (3xD effective reaming overhang). For longer holders, the cutting speed to be reduced proportionally.
- ▶ For relatively large leading angles (spot-facing geometries), the feed to be reduced up to 30%.
- ▶ All the given cutting data recommendations refer to the machines with spindle through coolant supply.

Legend:

Grade	→	TT9030	BL	←	Cutting geometry
Cutting speed (m/min)	→	Vc = 10 - 20		←	Feed (mm/tooth)
TM-REAM head size	→	B4-B6	fz = 0.04 - 0.15	←	
		B7-B9	fz = 0.05 - 0.20		

Recommended Cutting Conditions



Machining data for TB-REAM

			Lead A (15°/3°) (Reaming allowance: 0.1 ~ 0.3)						
			Feed (mm/rev)	Rake (°)	Cutting speed Vc (m/min)				
ISO	Material	Material No.			Carbide	Coated carbide	Cermet	PCD	CBN
P	Non-alloy steel and cast steel, free cutting steel	1 - 5	0.1-0.4	6	40-60	60-80	110-160		
	Low alloy steel and cast steel (Less than 5% of alloying elements)	6 - 9	0.1-0.4	6	20-40	40-60	110-160		
	High alloyed steel, cast steel and tool steel	10 - 11	0.1-0.4	6	20-40	20-60	20-60		
M	Stainless steel, cast steel	12 - 14	0.1-0.3	12	20-40	40-60	20-60		
K	Grey cast iron (GG)	15 - 16	0.1-0.3	0 / 6	40-60	60-100			Please ask
	Cast iron nodular (GGG)	17 - 18	0.1-0.3	0 / 6	40-60	60-100			
	Malleable cast iron	19 - 20	0.1-0.3	0 / 6	40-60	60-100			
N	Aluminum wrought alloy	21 - 22						Please ask	
	Aluminum-cast, alloyed	23 - 25							
	Copper alloys	26 - 28							
	Non-metallic	29 - 30							

			Lead C (75°) (Reaming allowance: 0.2 ~ 0.4)						
			Feed (mm/rev)	Rake (°)	Cutting speed Vc (m/min)				
ISO	Material	Material No.			Carbide	Coated carbide	Cermet	PCD	CBN
P	Non-alloy steel and cast steel, free cutting steel	1 - 5							
	Low alloy steel and cast steel (Less than 5% of alloying elements)	6 - 9							
	High alloyed steel, cast steel and tool steel	10 - 11							
M	Stainless steel, cast steel	12 - 14							
K	Grey cast iron (GG)	15 - 16							Please ask
	Cast iron nodular (GGG)	17 - 18							
	Malleable cast iron	19 - 20							
N	Aluminum wrought alloy	21 - 22	0.15-0.3	12	150-250			Please ask	
	Aluminum-cast, alloyed	23 - 25	0.15-0.3	12	150-250				
	Copper alloys	26 - 28							
	Non-metallic	29 - 30							

▶ The cutting conditions in the table below should be used to start a new application. Optimal conditions for a specific application should be evaluated by examining the results and changing the machining conditions accordingly.

▶ For more information of material groups, see the materials & grades "material conversion table"

■ Steel
 ■ Stainless steel
 ■ Cast iron
 ■ Nonferrous

Recommended Cutting Conditions



Machining data for TB-REAM

			Lead B (30°/3°) (Reaming allowance: 0.1 ~ 0.3)						
			Feed (mm/rev)	Rake (°)	Cutting speed Vc (m/min)				PCD
ISO	Material	Material No.			Carbide	Coated carbide	Cermet		
P	Non-alloy steel and cast steel, free cutting steel	1 - 5	0.1-0.4	6	60-80	80-120	110-160		
	Low alloy steel and cast steel (Less than 5% of alloying elements)	6 - 9	0.1-0.4	6	60-80	80-120	110-160		
	High alloyed steel, cast steel and tool steel	10 - 11	0.1-0.4	6	40-60	40-80	40-80		
M	Stainless steel, cast steel	12 - 14	0.1-0.3	12	40-60	60-80	60-80		
K	Grey cast iron (GG)	15 - 16	0.1-0.3	0 / 6	60-80	80-120			Please ask
	Cast iron nodular (GGG)	17 - 18	0.1-0.3	0 / 6	60-80	80-120			
	Malleable cast iron	19 - 20	0.1-0.3	0 / 6	60-80	80-120			
N	Aluminum wrought alloy	21 - 22		12	160-200			Please ask	
	Aluminum-cast, alloyed	23 - 25		12	160-200				
	Copper alloys	26 - 28		0	80-100				
	Non-metallic	29 - 30		0	10-70				

			Lead D (30°/3°) (Reaming allowance: 0.1 ~ 0.2)						
			Feed (mm/rev)	Rake (°)	Cutting speed Vc (m/min)				PCD
ISO	Material	Material No.			Carbide	Coated carbide	Cermet		
P	Non-alloy steel and cast steel, free cutting steel	1 - 5	0.1-0.4	6	60-80	80-120	110-160		
	Low alloy steel and cast steel (Less than 5% of alloying elements)	6 - 9	0.1-0.4	6	60-80	80-120	110-160		
	High alloyed steel, cast steel and tool steel	10 - 11	0.1-0.4	6	40-60	40-80	40-80		
M	Stainless steel, cast steel	12 - 14	0.1-0.3	12	40-60	60-80	60-80		
K	Grey cast iron (GG)	15 - 16	0.1-0.3	0 / 6	60-80	80-120			Please ask
	Cast iron nodular (GGG)	17 - 18	0.1-0.3	0 / 6	60-80	80-120			
	Malleable cast iron	19 - 20	0.1-0.3	0 / 6	60-80	80-120			
N	Aluminum wrought alloy	21 - 22		12	110-200			Please ask	
	Aluminum-cast, alloyed	23 - 25		12	160-200				
	Copper alloys	26 - 28		0	80-100				
	Non-metallic	29 - 30							

▶ The cutting conditions in the table below should be used to start a new application. Optimal conditions for a specific application should be evaluated by examining the results and changing the machining conditions accordingly.

▶ For more information of material groups, see the materials & grades "material conversion table"

■ Steel
 ■ Stainless steel
 ■ Cast iron
 ■ Nonferrous

Recommended Cutting Conditions



Machining data for TS-REAM

ISO	Material	Condition	Tensile strength (N/mm ²)	Hardness HB	Material No.	Cutting speed Vc (m/min)	
P	Non-alloy steel, cast steel, free cutting steel	<0.25%C	Annealed	420	125	1	120-250
		>=0.25%C	Annealed	650	190	2	120-250
		<0.55%C	Quenched and tempered	850	250	3	120-250
		>=0.55%C	Annealed	750	220	4	
			Quenched and tempered	1000	300	5	
	Low alloy steel and cast steel (Less than 5% of alloying elements)	Quenched and tempered	Annealed	600	200	6	120-250
			930	275	7	120-250	
			1000	300	8	120-250	
			1200	350	9	120-250	
	High alloy steel, cast steel and tool steel	Annealed	680	200	10	120-250	
		Quenched and tempered	1100	325	11	120-250	
M	Stainless steel and cast steel	Ferritic / martensitic	680	200	12	60-120	
		Martensitic	820	240	13	60-120	
		Austenitic	600	180	14	60-120	
K	Gray cast iron (GG)	Ferritic		160	15	60-120	
		Pearlitic		250	16	60-120	
	Cast iron nodular (GGG)	Ferritic		180	17	60-120	
		Pearlitic		260	18	60-120	
	Malleable cast iron	Ferritic		130	19	60-120	
Pearlitic			230	20	60-120		
N	Aluminum - Wrought alloy	Not cureable		60	21	250-500	
		Cured		100	22	250-500	
	Aluminum-cast, alloyed	<=12% Si	Not cureable		75	23	250-500
			Cured		90	24	250-500
		>12% Si	High temp.		130	25	
	Copper alloys	>1% Pb	Free cutting		110	26	
		Brass			90	27	
			Electrolitic copper		100	28	
Non-metallic		Duroplastics, fiber plastics		70 Shore D	29		
		Hard rubber		55 Shore D	30		
S	High temp. alloys	Fe based	Annealed		200	31	
			Cured		280	32	
		Ni or Co based	Annealed		250	33	25-50
			Cured		350	34	25-50
			Cast		320	35	
	Titanium, Ti alloys	Pure	Rm 400	190	36	30-80	
Alpha+beta alloys cured		Rm 1050	310	37	30-80		
H	Hardened steel	Hardened		55HRC	38	25-60	
		Hardened		60HRC	39		
	Chilled cast iron	Cast		400	40		
	Cast iron nodular	Hardened		55HRC	41		

► For more information of material groups, see the materials & grades "material conversion table"

■ Steel
 ■ Stainless steel
 ■ Cast iron
 ■ Nonferrous
 ■ High temp. alloys
 ■ Hardened steel

► Chamfering ring design - DRILL-RUSH

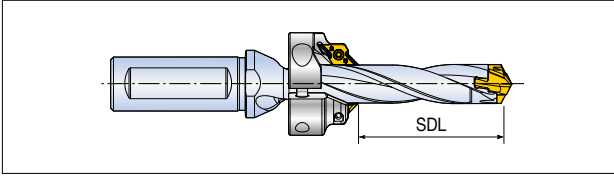

	Designation	CFR designation	SDL	
			min	max
3D	TCD 130-134-16T3/S0-3D	CFR D130-A45	19	19
	135-139-16T3/S0-3D	CFR D135-A45	19	20
	140-144-16T3/S0-3D	CFR D140-A45	21	22
	145-149-16T3/S0-3D	CFR D145-A45	22	23
	150-159-20T3/S0-3D	CFR D150-A45	23	23
	160-169-20T3/S0-3D	CFR D160-A45	24	25
	170-179-20T3/S0-3D	CFR D170-A45	26	28
	180-189-25T2/S0-3D	CFR D180-A45	27	30
	190-199-25T2/S0-3D	CFR D190-A45	29	33
	200-209-25T2/S0-3D	CFR D200-A45	30	36
	210-219-25T2/S0-3D	CFR D210-A45	32	39
	220-229-25T2/S0-3D	CFR D220-A45	33	42
	230-239-32T2/S0-3D	CFR D230-A45	35	45
240-249-32T2/S0-3D	CFR D240-A45	36	48	
250-259-32T2/S0-3D	CFR D250-A45	38	51	
5D	TCD 100-104-16T3/S0-5D	CFR D100-A45	28	28
	105-109-16T3/S0-5D	CFR D105-A45	29	30
	110-114-16T3/S0-5D	CFR D110-A45	31	33
	115-119-16T3/S0-5D	CFR D115-A45	32	35
	120-124-16T3/S0-5D	CFR D120-A45	33	45
	125-129-16T3/S0-5D	CFR D125-A45	34	40
	130-134-16T3/S0-5D	CFR D130-A45	36	43
	135-139-16T3/S0-5D	CFR D135-A45	37	43
	140-144-16T3/S0-5D	CFR D140-A45	38	48
	145-149-16T3/S0-5D	CFR D145-A45	39	48
	150-159-20T3/S0-5D	CFR D150-A45	41	53
	160-169-20T3/S0-5D	CFR D160-A45	43	58
	170-179-20T3/S0-5D	CFR D170-A45	46	63
	180-189-25T2/S0-5D	CFR D180-A45	48	68
	190-199-25T2/S0-5D	CFR D190-A45	51	73
200-209-25T2/S0-5D	CFR D200-A45	53	78	
210-219-25T2/S0-5D	CFR D210-A45	56	79	
220-229-25T2/S0-5D	CFR D220-A45	58	84	
230-239-32T2/S0-5D	CFR D230-A45	61	89	
240-249-32T2/S0-5D	CFR D240-A45	63	94	
250-259-32T2/S0-5D	CFR D250-A45	66	99	

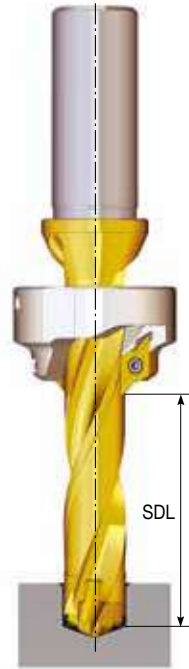

► Chamfering ring designation - DRILL-RUSH

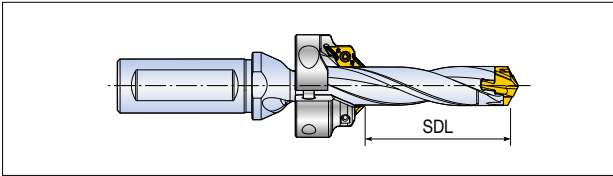

	Designation	CFR designation	SDL	
			min	max
8D	TCD 100-104-16T3/S0-8D	CFR D100-A45	45	58
	105-109-16T3/S0-8D	CFR D105-A45	49	62
	110-114-16T3/S0-8D	CFR D110-A45	49	66
	115-119-16T3/S0-8D	CFR D115-A45	53	70
	120-124-16T3/S0-8D	CFR D120-A45	53	74
	125-129-16T3/S0-8D	CFR D125-A45	57	78
	130-134-16T3/S0-8D	CFR D130-A45	57	82
	135-139-16T3/S0-8D	CFR D135-A45	61	84
	140-144-16T3/S0-8D	CFR D140-A45	61	88
	145-149-16T3/S0-8D	CFR D145-A45	65	92
	150-159-20T3/S0-8D	CFR D150-A45	65	96
	160-169-20T3/S0-8D	CFR D160-A45	69	103
	170-179-20T3/S0-8D	CFR D170-A45	73	111
	180-189-25T2/S0-8D	CFR D180-A45	77	118
	190-199-25T2/S0-8D	CFR D190-A45	81	126
	200-209-25T2/S0-8D	CFR D200-A45	85	134
	210-219-25T2/S0-8D	CFR D210-A45	89	142
	220-229-25T2/S0-8D	CFR D220-A45	93	150
230-239-32T2/S0-8D	CFR D230-A45	97	158	
240-249-32T2/S0-8D	CFR D240-A45	101	166	
250-259-32T2/S0-8D	CFR D250-A45	105	174	
12D	TCD 120-124-16S0-12D	CFR D120-A45	87	121
	125-129-16S0-12D	CFR D125-A45	90	127
	130-134-16S0-12D	CFR D130-A45	93	133
	135-139-16S0-12D	CFR D135-A45	96	137
	140-144-16S0-12D	CFR D140-A45	99	143
	145-149-16S0-12D	CFR D145-A45	102	149
	150-159-20S0-12D	CFR D150-A45	105	155
	160-169-20S0-12D	CFR D160-A45	111	166
	170-179-20S0-12D	CFR D170-A45	117	178
	180-189-25S0-12D	CFR D180-A45	123	189
	190-199-25S0-12D	CFR D190-A45	129	201
	200-209-25S0-12D	CFR D200-A45	135	213
210-219-25S0-12D	CFR D210-A45	141	225	
220-229-25S0-12D	CFR D220-A45	147	237	

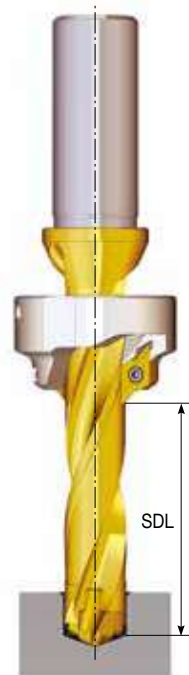

► Modular head replacement instructions

1. Remove both outer inserts, then remove the center drill head.
(When clamping, go in the reverse order)
2. Use a wrench to turn the screw counter-clock-wise to remove the modular head.
3. Insert the setting gauge into the bottom of the disconnected modular head.

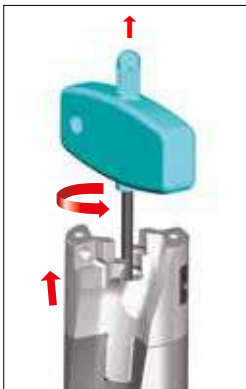

4. Rotate the screw to adjust to the same height with the setting gauge.

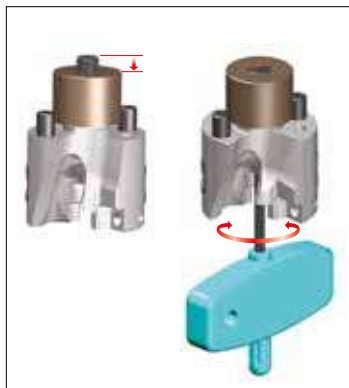

Setting gauge

Drill dia.	Designation
D26-D29	SG TNDH D26-29-TP
D30-D35	SG TNDH D30-35-TP
D36-D39	SG TNDH D36-39-TP
D40-D43	SG TNDH D40-43-TP
D44-D50	SG TNDH D44-50-TP

5. Remove the height adjusted modular head from the setting gauge and attach it to the holder.

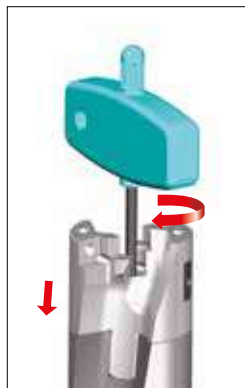

► Modular head disassembly in the event of center drill damage

If the modular head cannot be unclamped due to center drill damage, insert the wrench into the rear section of the shank. Then, turn it clock-wise to disassemble the modular head.

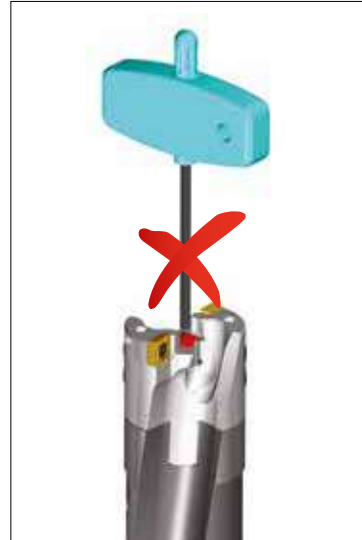

Damaged center drill



► Disassembling wrench and handle are included with the modular drill holder. (MDB Dxx/xx...)

► XM-REAM user guide and notice

How to check reamer diameter

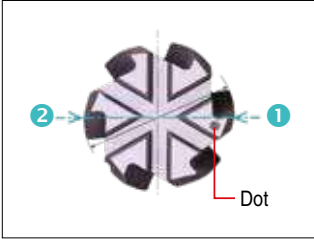

Measure the dot side edge **1** and opposite side edge **2**.

Reaming allowance

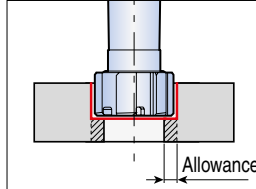

Material	Diameter	
	< Ø10	Ø10-12
Steel & Cast iron	0.07-0.10	0.07-0.15
Aluminum & brass	0.07-0.10	0.10-0.15

* Based on diameter

Ex) Ø9.85-9.93 mm pre-hole is recommended for Ø10H7 reaming in cast iron.

Caution

- To ensure smooth coolant flow, the dot and slot orientation of the head must be aligned as illustrated.

O

Dot orientation match between head and holder

Coolant hole slightly visible through flutes

Smooth coolant flow

X

Dot orientation mismatch between head and holder

Coolant hole is hidden by the flute

Reduced coolant flow

► Screw torque

For SPADE-RUSH

Designation	Thread	Length	Torx	Tightening Torque
TS 30138D33	M3	13.8	Torx 10	2.0 Nm
TS 40178D25	M4	17.8	Torx 20	4.5 Nm
TS 40198D28	M4	19.8	Torx 20	4.5 Nm
TS 40210D3	M4	21	Torx 20	5.0 Nm
TS 50230D3	M5	23	Torx 20	5.0 Nm
TS 50250D35	M5	25	Torx 25	5.5 Nm
TS 60265D4	M6	26.5	Torx 25	6.0 Nm
TS 60285D42	M6	28.5	Torx 25	6.0 Nm
TS 60320D5	M6	31	Torx 25	6.0 Nm
TS 80340D6	M8	34	Torx 25	7.0 Nm

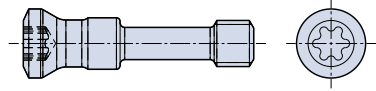

For MODU-R-DRILL

Designation	Thread	Length	Torx	Tightening Torque
TDPS 0512-T7	M5	12	Torx 7	1.0 Nm
TDPS 0618-T8	M6	18	Torx 8	2.0 Nm

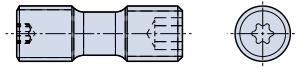

For MODU-R-DRILL

Designation	Thread	Length	Torx	Tightening Torque
TDPS 0722-W3.0	M7	22	Hexa 3.0 mm	5.0 Nm

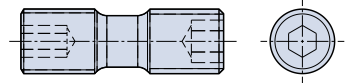

Technical Data

► Hole tolerance



Diameter D(mm)		Tolerance (µm)															
>D	≤D	B10	C9	C10	D8	D9	D10	E7	E8	E9	F6	F7	F8	G6	G7	H6	H7
-	3	+180 +140	+85 +60	+100 +60	+34 +20	+45 +20	+60 +20	+24 +14	+28 +14	+39 +14	+12 +6	+16 +6	+20 +6	+8 +2	+12 +2	+6 0	+10 0
3	6	+180 +140	+100 +70	+118 +70	+48 +30	+60 +30	+78 +30	+32 +20	+38 +20	+50 +20	+18 +10	+22 +10	+28 +10	+12 +4	+16 +4	+8 0	+12 0
6	10	+208 +150	+116 +80	+138 +80	+62 +40	+76 +40	+98 +40	+40 +25	+47 +25	+61 +25	+22 +13	+28 +13	+35 +13	+14 +5	+20 +5	+9 0	+15 0
10	14	+220 +150	+138 +95	+165 +95	+77 +50	+93 +50	+120 +50	+50 +32	+59 +32	+75 +32	+27 +16	+34 +16	+43 +16	+17 +6	+24 +6	+11 0	+18 0
14	18																
18	24	+244 +160	+162 +110	+194 +110	+98 +65	+117 +65	+149 +65	+61 +40	+73 +40	+92 +40	+33 +20	+41 +20	+53 +20	+20 +7	+28 +7	+13 0	+21 0
24	30																
30	40	+270 +170	+182 +120	+220 +120	+119 +80	+142 +80	+180 +80	+75 +50	+89 +50	+112 +50	+41 +25	+50 +25	+64 +25	+25 +9	+34 +9	+16 0	+25 0
40	50	+280 +180	+192 +130	+230 +130													
50	65	+310 +190	+214 +140	+260 +140	+146 +100	+174 +100	+220 +146	+90 +60	+106 +60	+134 +60	+49 +30	+60 +30	+76 +30	+29 +10	+40 +10	+19 0	+30 0
65	80	+320 +200	+224 +150	+270 +150													



Technical Data

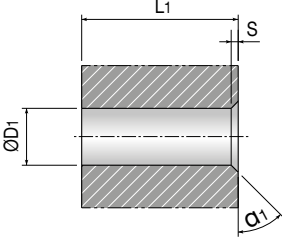
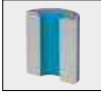

► Hole tolerance

Tolerance (µm)																		
H8	H9	H10	JS6	JS7	K6	K7	M6	M7	N6	N7	P6	P7	R7	S7	T7	U7	X7	
+14 0	+25 0	+40 0	±3	±5	0 -6	0 -10	-2 -8	-2 -12	-4 -10	-4 -14	-6 -12	-6 -16	-10 -20	-14 -24	-	-18 -28	-20 -30	
+18 0	+30 0	+48 0	±4	±6	+2 -6	+3 -9	-1 -9	0 -12	-5 -13	-4 -16	-9 -17	-8 -20	-11 -23	-15 -27	-	-19 -31	-24 -36	
+22 0	+36 0	+58 0	±4.5	±7.5	+2 -7	+5 -10	-3 -12	0 -15	-7 -16	-4 -19	-12 -21	-9 -24	-13 -28	-17 -32	-	-22 -37	-28 -43	
+27 0	+43 0	+70 0	±5.5	±9	+2 -9	+6 -12	-4 -15	0 -18	-9 -20	-5 -23	-15 -26	-11 -29	-16 -34	-21 -39	-	-26 -44	-33 -51 -38 -56	
+33 0	+52 0	+84 0	±6.5	±10.5	+2 -11	+6 -15	-4 -17	0 -21	-11 -24	-7 -28	-18 -31	-14 -35	-20 -41	-27 -48	-	-33 -54 -40 -61	-46 -67 -56 -77	
+39 0	+62 0	+100 0	±8	±12.5	+3 -13	+7 -18	-4 -20	0 -25	-12 -28	-8 -33	-21 -37	-17 -42	-25 -50	-34 -59	-39 -64 -45 -70	-51 -76 -61 -86	-	
+46 0	+74 0	+120 0	±9.5	±15	+4 -15	+9 -21	-5 -24	0 -30	-14 -33	-9 -39	-26 -45	-21 -51	-30 -60 -32 -62	-42 -72 -48 -78	-55 -85 -64 -94	-76 -106 -91 -121	-	

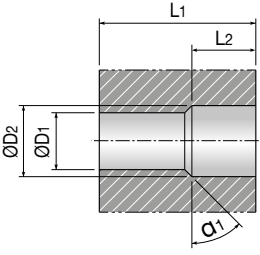
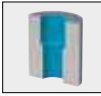
► Specific dimensions

	<div style="display: flex; justify-content: space-around;">   </div> <p>Through <input type="checkbox"/> Blind <input type="checkbox"/></p> <p>ØD1 _____ L1 _____</p> <p>α1 _____ S _____</p> <p>•Hole tolerance _____</p>
---	--

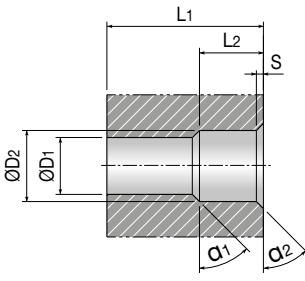
	<div style="display: flex; justify-content: space-around;">   </div> <p>Through <input type="checkbox"/> Blind <input type="checkbox"/></p> <p>ØD1 _____ ØD2 _____</p> <p>L1 _____ L2 _____</p> <p>α1 _____</p> <p>•Hole tolerance _____</p>
---	--

	<div style="display: flex; justify-content: space-around;">   </div> <p>Through <input type="checkbox"/> Blind <input type="checkbox"/></p> <p>ØD1 _____ ØD2 _____</p> <p>L1 _____ L2 _____</p> <p>α1 _____ α2 _____</p> <p>S _____</p> <p>•Hole tolerance _____</p>
--	--

<table border="1" style="width: 100%;"> <tr> <td style="padding: 5px;">Comment</td> </tr> <tr> <td style="height: 150px;"></td> </tr> </table>	Comment	
Comment		

Drill type

- TOPDRILL _____
- T-DRILL _____

Technical data





- Machine type
- MCT Lathe
- Vertical Horizontal
- Machine name _____
- Power _____ kW

- Coolant supply
- Internal External
- Coolant pressure _____ bar
- Coolant type _____

Workpiece

- Part _____
- Material _____
- Hardness _____

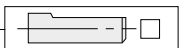
Shank type

-  Cylindrical shank (ISO 9766)
-  Whistle notch shank
-  Cylindrical with flat type
-  Weldon shank

► Specific dimensions

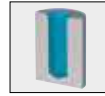
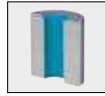
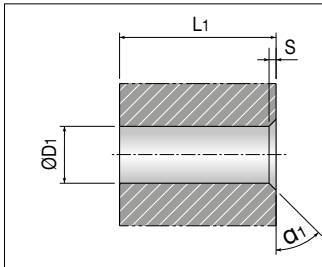

Through

Blind

ØD1 _____

L1 _____

Q1 _____

S _____

•Hole tolerance _____

Technical data

•Machine type

MCT Lathe

Vertical Horizontal

Machine name _____

Power _____ kW

•Coolant supply

Internal External

Coolant pressure _____ bar

Coolant type _____

Workpiece

•Part _____

•Material _____

•Hardness _____

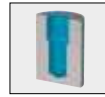
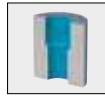
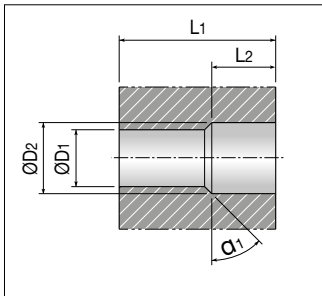

Through

Blind

ØD1 _____

ØD2 _____

L1 _____

L2 _____

Q1 _____

•Hole tolerance _____

Shank type



Cylindrical shank (ISO 9766)



Whistle notch shank



Cylindrical with flat type



Weldon shank

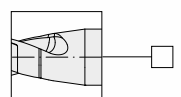
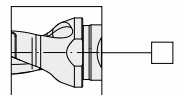

•Shank dia: _____

•Shank length: _____

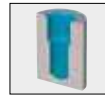
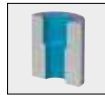
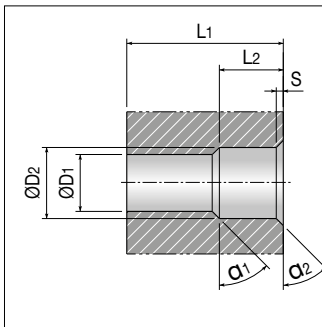

Through

Blind

ØD1 _____

ØD2 _____

L1 _____

L2 _____

Q1 _____

Q2 _____

S _____

•Hole tolerance _____

Comment

► Specific dimensions

• DC, DC_2 would be hole dimensions and please note hole tolerance if possible

Technical data

- Machine type
 MCT Lathe
 Vertical Horizontal
 Machine name _____
 Power _____ kW
- Coolant supply
 Internal External
 Coolant pressure _____ bar
 Coolant type _____

Workpiece

- Part _____
- Material _____
- Hardness _____

Hole type

- Blind hole
- Through hole

Coating

- TiAlN
- Non-coated

Shank type

- Cylindrical shank
- Whistle notch shank
- Cylindrical with flat type
- Weldon shank

Comment

Tailor-made Order Form



▶ Deep hole drilling order form

★: Mandatory data field

Company name :	Inquiry number :
Address :	Inquiry date :
Contact person :	Customer No. :

Workpiece (If possible, please attach a drawing)	
Product name	
Hole diameter (ø)	(mm)
Hole depth (drilling length)	(mm)
No. of holes	
Tolerance (of hole)	
Surface finish (Rz, Ra...)	
Deviation (mm/100)	
Straightness (mm/100)	
Material	
Material (DIN, AISI, JIS...)	
Hardness (HB, HS, HRC...)	
Condition ★	<input type="checkbox"/> Annealed <input type="checkbox"/> Quenched <input type="checkbox"/> Tempered <input type="checkbox"/> Cast <input type="checkbox"/> <input type="checkbox"/> Other <input type="checkbox"/>

Machine	
Machine supplier name	
Machine type/model	
Rigidity	<input type="checkbox"/> Good <input type="checkbox"/> Normal <input type="checkbox"/> Bad
Date of manufacture	
Retrofitted	<input type="checkbox"/> NC lathe <input type="checkbox"/> M/C <input type="checkbox"/> Other
Double rotation (TR/WR)	<input type="checkbox"/> Tool and workpiece
Rotating workpiece (WR)	<input type="checkbox"/>
Rotating tool (TR)	<input type="checkbox"/>
Safety devices	
Motor power	(kW)

Type of coolant	
Coolant supplier name	
Water based	<input type="checkbox"/> Soluble <input type="checkbox"/> Emulsion %
Oil based	<input type="checkbox"/>
Coolant pressure	(bar)
Coolant volume	(L/min)

Tailor-made Order Form



► Deep hole drilling order form

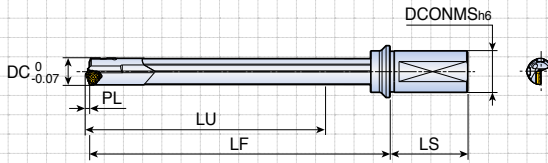

Sketch of drilling application

• Note: It may be necessary to change several of the parameters that you indicated based on our experience with your application.

Tool	
Quantity	
Nominal diameter and tolerance	
- Please fill in dimensions on the sketch above.	
Driver	
Code No	

- For standard drivers, please use codes from next pages and for special drivers, please attach sketch and specifications.

Workpiece (If possible, please attach a drawing)	
Material description (DIN material number or any other standard)	
Hardness and properties	
Hole type	<input type="checkbox"/> Blind hole <input type="checkbox"/> Through hole <input type="checkbox"/> Drilling into pre-hole
	<input type="checkbox"/> Angled entry <input type="checkbox"/> Drilling into solid <input type="checkbox"/> Boring
	<input type="checkbox"/> Angled exit
Drilling depth	mm
Hole tolerance	
Application	Workpiece <input type="checkbox"/> Stationary <input type="checkbox"/> Rotating
	Tool <input type="checkbox"/> Stationary <input type="checkbox"/> Rotating

Machine	
Machine type	
Power kW	
Cutting data	Cutting speed (Vc) m/min
	Revolutions Nmin : RPM Nmax : RPM
	Feed Fmin : mm/rev Fmin : mm/rev
	Feed rate (VF) mm/min
Coolant	Coolant type <input type="checkbox"/> Oil <input type="checkbox"/> Soluble oil <input type="checkbox"/> Other
	Coolant pressure Bar
	Coolant volume liter/min

► Standard gundrill drivers for machining centers and lathes

Drivers

Drivers are available for dedicated and CNC machines as well as any specified diameter or length. Please note that the driver codes and technical data can be found in the chart below.

Driver type	Drawing	DCONMS x LS	Driver code
Cylindrical DIN1835A DIN6535HA		20x50	10
		25x56	11
		32x60	12
		40x70	13
		.75x2.03"	95
		1.00x2.28"	96
		1.25x2.28"	97
Weldon DIN1835B DIN6535HB		20x50	22
		25x56	23
		32x60	24
		40x70	25
		.75x2.03"	99
		1.00x2.28"	100
Whistle notch DIN1835E		20x50	34
		25x56	35
		32x60	36
		40x70	37

► Standard drivers for gundrill machines









Driver type	Drawing	DCONMS x LS	Driver code
DIN228AK		CM2	46
		CM3	47
		CM4	48
DIN228BK		CM2	50
		CM3	51
		CM4	52
Central clamping surface 15°		.750x2.75"	56
		25x70	57
		1.00x2.75"	58
		1.25x2.75"	59
		1.50x2.75"	60
Frontal clamping surface 15°		16x50	61
Cylindrical with thread		25x100 M16x1.5	66
		36x120 M24x1.5	67
VDI design		25x112 M16x1.5	70
		36x135 M24x1.5	71
Central clamping hexagonal		25x70	72
		32x70	73
Central clamping tapered		.75x2.75"	76
		20x70	77
Frontal clamping surface 2°		1.00x2.75"	80
		1.00x3.94"	81
		1.25x2.75"	82
		1.25x3.94"	83
		1.50x2.75"	84
		1.50x3.94"	85
Trapezoidal thread		28x126 Tr 28x2	88
		36x162 Tr 36x2	89
Spraymist driver		25x50	91
		35x60	92

► Reamer order form

★: Mandatory data field

Date:	Subsidiary:
Company★ :	Enquiry dead line:
Contact person:	
Address:	

Request reason	
New tool <input type="checkbox"/>	Problem <input type="checkbox"/>
Quality	
Cycle time	
Alternative supplier	
Other	

Workpiece	
Description★	
Hardness★	
Pre-hole size★	(Tolerance :)
Depth★	
Bore type	
<input type="checkbox"/>  <input type="checkbox"/>  <input type="checkbox"/>  <input type="checkbox"/>  <input type="checkbox"/> 	
<input type="checkbox"/>  <input type="checkbox"/>  <input type="checkbox"/>  <input type="checkbox"/> 	
Clamping information	

Existing tool	
Maker	
Tool type	
Speed & Feed	
Tool life	
No of teeth	
Coolant type	

Machine	
Model	
Type★	vertical <input type="checkbox"/>
	horizontal <input type="checkbox"/>
	multi-spindle <input type="checkbox"/>
Adaption★	
Max RPM	
Power	
Spindle accuracy	
Coolant	

Lubricant	
Oil	<input type="checkbox"/>
MQL	<input type="checkbox"/>
Emulsion	<input type="checkbox"/>
Ratio of mixture	
Coolant pressure	

Quality requirement	
Tolerance★	
Surface finish(Ra)★	
Roundness	
Straightness	
Cylindricity	
Concentricity	

Tool	
Type★	TM(Index multi-edge) <input type="checkbox"/> TB(Single blade) <input type="checkbox"/> TS(Solid) <input type="checkbox"/> Other <input type="checkbox"/> ()
Diameter★	
Depth of cut★	
Coolant★	Internal <input type="checkbox"/> External <input type="checkbox"/>
Shank type★	
Holder type	Collet <input type="checkbox"/> Hydraulic <input type="checkbox"/> Other <input type="checkbox"/>
Adjustable adaptor	Yes <input type="checkbox"/> No <input type="checkbox"/>

MILLING



MILLING



contents

Tool Selection Guide

Face Mills	E4
End Mills & Modular Heads	E13
High Feed End Mills & Modular Heads	E19
Extended Flute Cutters	E21
Slotting Cutters	E24
Milling Inserts	E27
Slotting Inserts	E37
Tailor-made Inserts	E38

Grades















E39

Milling Cutters

Face Mills	E44
High Feed Face Mills	E102
End Mills & Modular Heads	E113
High Feed End Mills & Modular Heads	E181
Extended Flute Cutters	E201
Slotting Cutters	E219
MAXI-SFEED	E238

Tool Selection Guide

Face mills

Series		TANGSPEED	BILLRUSH	BILL2RUSH	BILL2RUSH	WINMILL	
		4T-TF90	3P TF90	6N TF90	SCRM90TN	TFM90AV	
							
Pages		E44	E45-E47	E48-E50	E51-E52	E53	
Approach angle		90°	90°	90°	90°	90°	
Max. depth of cut(mm)		8.3-12.5	4.7-15	4.1-9.2	13-15	10	
Diameter range(mm)		Ø40-Ø200	Ø32-Ø250	Ø40-Ø250	Ø50-Ø250	Ø40-Ø63	
Insert		LPK(H)U 0904 LPKU 1407	3PK(H)T 0603 3PK(H)T 1004 3PK(H)T 1505 3PK(H)T 1906	6NKU 0403 6NGU 0604 6NGU 0905	TNMX 1806 TNM(G)X 2207	AVKT 1004 AVCT 1004-AL	
Application	Facing		●	●	●	●	●
	High feed milling						○
	Shouldering		●	●	●	●	●
	Slotting		●	●	●	●	●
	Straight ramping		●	●			●
	Helical ramping		●	●			●
	Side slotting						
	Profiling						○
	Step down						●
	Counter boring						

Tool Selection Guide















Face mills

					
TFM90AX 2S-TFM90AP TFM90AP	TFM90AN	4N TF90	8D-TF90	TFM90XEV	For Finishing 4W-TF90
					
E54 -E57	E58-E59	E60-E61	E62-E64	E65	E66
90°	90°	90°	90°	90°	-
5.5-17.9	11-15	3.5-13.8	5.0-8.5	16-21	0.5
Ø32-Ø200	Ø40-Ø200	Ø32-Ø100	Ø32-Ø160	Ø40-Ø200	Ø50-Ø160
AXM(C)T 0602 APK(C)T 09T3 APK(C)T 1204 APK(C)T 1705 APKT1907	ANM(H)X 1106 ANM(H)X 1607	4NK(H)T 0402 4NK(H)T 0603 4NK(H)T 0904 4NKT 1106 4NKT 1407	SQKU 0703 SQK(H)U 1004 SQK(H)U 1206	XEVT 1605 XEVT 2206	4WHU 1207
●	●	●	●	●	●
○		○			
●	●	●	●	●	
●	●	●	●	●	
●	●	●		●	
●	●	●		●	
○		○			
		●		●	

● Recommended, ○ Suitable





















Tool Selection Guide

Face mills

Series		CHASE2QUAD	CHASE2QUAD	LIONMILL	LIONMILL	CHASE2QUAD
		For Finishing	For Finishing			
		TFM90SNS	TQ90SNS	LM90TP	LM90SE	TFM90SN TFM88SN
						
Pages		E67	E68	E69	E70	E71-E72
Approach angle		90°	90°	90°	90°	90°, 88°
Max. depth of cut(mm)		1.0	1.0	17.6	17.0	12.0
Diameter range(mm)		Ø50-Ø250	Ø250-Ø400	Ø80-Ø315	Ø125-Ø315	Ø50-Ø200
Insert		SNEX 1204 SNET 1205	SNEX 1204 SNET 1205	TPKN 2204	SEKX 2107	SNGX 1306 SNGX 1306 ZN
Application	Facing		●	●	●	●
	High feed milling					
	Shouldering				●	●
	Slotting					
	Straight ramping					
	Helical ramping					
	Side slotting					
	Profiling					
	Step down					
	Counter boring					

Tool Selection Guide

Face mills

						
Series		12D-TF45	14D-F45XN	14D-F45XNH	14D-F45XNW	7S-F45
						
Pages		E81-E82	E83-E84	E85	E86	E87
Approach angle		45°	45°	45°	45°	45°
Max. depth of cut(mm)		3.0-5.0	3.5-5.0	3.5-5.0	5.0	3.2
Diameter range(mm)		Ø50-Ø250	Ø50-Ø250	Ø63-Ø125	Ø80-Ø315	Ø32-Ø125
Insert		HXK(H)U 0605 HXK(H)U 1007	XNM(H)U 0605 XNM(H)U 0906	XNM(H)U 0605 XNM(H)U 0906	XNHU 0906	7EMT 0604
Application	Facing		●	●	●	●
	High feed milling					
	Shouldering					
	Slotting					
	Straight ramping					●
	Helical ramping					●
	Side slotting					
	Profiling					
	Step down					
	Counter boring					

Tool Selection Guide















Face mills

CHASE2QUAD	CHASE2QUAD	CHASE2QUAD	CHASE2QUAD	CHASE2MILL	LIONMILL
TFM45SN	TFM45SNS	TFM45SNS-CA	TFM45SNW TQ45SNW	TFM45AN	LM45SD
					
E88	E89	E90	E91	E92	E93
45°	45°	45°	45°	45°	45°
7.0	8.8	8.8	8.8	8.4	6.5-8.7
Ø40-Ø250	Ø63-Ø250	Ø125-Ø315	Ø80-Ø355	Ø50-Ø160	Ø80-Ø315
SNM(G)X 1306 AN SNMX 1306 XTN	SNMX 1607 SNHX 1606	SNMX 1607 SNHX 1606	SNHX 1606	ANHX 1607 ANR-M	SDKN 1203 SDKN 1504
●	●	●	●	●	●

● Recommended, ○ Suitable













Tool Selection Guide

Face mills

Series		LIONMILL	CHASE2MOLD	CHASEMOLD	CHASESPEED	CHASESPEED	
		LM45SE	TFMRNS	TFMRY	TFMRN	TFMRP	
							
Pages		E94	E95-E96	E97-E99	E100	E101	
Approach angle		45°	-	-	-	-	
Max. depth of cut(mm)		6.5-8.7	5.0-8.0	4.0-10.0	6.3	6.3	
Diameter range(mm)		Ø80-Ø250	Ø32-Ø200	Ø32-Ø250	Ø50-Ø80	Ø50	
Insert		SEKN 1203 SEKN 1504	RNMU 1004 RNMU 1205 RNMU 1606	RYM(H)X 0803 RYM(H)X 1004 RYM(H)X 1205 RYM(H)X 1606 RYMX 2007	RNGN 1207 FL	RPGN 1204 FL	
Application	Facing		●	●	●	●	●
	High feed milling						
	Shouldering						
	Slotting						
	Straight ramping			●	●	●	●
	Helical ramping			●	●	●	●
	Side slotting						
	Profiling			●	●	●	●
	Step down						
	Counter boring						

Tool Selection Guide















Face mills

					
<u>TFMBN-09CH</u>	<u>TFMBN-12</u>	<u>TFMPT</u>	<u>8D-TF20</u>	<u>TFMBLV</u>	<u>TFMBL</u>
					
E102	E103	E104	E105	E106	E107-E108
-	-	25°	20°	-	-
1.5	2.5	1.5-3.0	1.8-2.5	1.0	1.0-2.0
Ø40-Ø50	Ø50-Ø80	Ø40-Ø200	Ø50-Ø125	Ø32-Ø63	Ø32-Ø200
BNGX 0904	BNGX 1207	PTKU 0503 PTKU 1006	SQKU 1105	BLMV 0603	BLMP 0603 BLMP 0904 BLMP 1105
●	●	●	●	●	●
●	●	●	●	●	●
●	●	●		●	●
●	●	●		●	●
●	●	●		●	●
				●	

● Recommended, ○ Suitable







Tool Selection Guide

Face mills

Series						
		TFMBL-13	TFMSB			
						
Pages		E109-E110	E111-E112			
Approach angle		-	-			
Max. depth of cut(mm)		2.0	1.0-2.0			
Diameter range(mm)		Ø40-Ø250	Ø32-Ø250			
Insert		BLMP 1306	SBMT 0603 SBMT 0904 SBMT 1306			
Application	Facing		●	●		
	High feed milling		●	●		
	Shouldering					
	Slotting					
	Straight ramping		●	●		
	Helical ramping		●	●		
	Side slotting					
	Profiling		●	●		
	Step down					
	Counter boring					

Tool Selection Guide



End mills & modular heads

		<i>WINMILL</i>	<i>TANGSPEED</i>	<i>TANGSPEED</i>	<i>BILLRUSH</i>	<i>BELL2RUSH</i>
		2S-TE90CV	4T-MTE90	4T-TE90	3P-TE90	6N TE90
Series						
Pages		E113-E114	E115-E116	E117-E118	E119-E124	E125-E126
Approach angle		90°	90°	90°	90°	90°
Max. depth of cut(mm)		5.0	4.6	4.6-8.3	3.5-15.0	4.1-9.2
Diameter range(mm)		Ø6-Ø20	Ø10-Ø30	Ø10-Ø40	Ø8-Ø50	Ø20-Ø40
Insert		CVK(H)T 0502	LPHU 05	LPK(H)U 0502 LPK(H)U 0904	3PKT 0402 3PK(H)T 0603 3PK(H)T 1004 3PK(H)T 1505 3PK(H)T 1906	6NKU 0403 6NGU 0604 6NGU 0905
Application	Facing		●	●	●	●
	High feed milling		○			
	Shouldering		●	●	●	●
	Slotting		●	●	●	●
	Straight ramping		●	●	●	●
	Helical ramping		●	●	●	●
	Chamfer & serration					
	Profiling		○			
	Plunging					
	Step down					
	Counter boring					

● Recommended, ○ Suitable





Tool Selection Guide

End mills & modular heads

						
Series		SCRM90TN 	TE90AV 	MTE90AX-06-L 	TE90AX 2S-TE90AP TE90AP 	TE90AN 
Pages		E127	E128-E129	E130	E131-E139	E140-E141
Approach angle		90°	90°	90°	90°	90°
Max. depth of cut(mm)		13.0	10.0	5.5	5.5-17.9	11.0-15.0
Diameter range(mm)		Ø35-Ø40	Ø16-Ø32	Ø8-Ø30	Ø8-Ø42	Ø25-Ø50
Insert		TNMX 1806	AVKT 1004 AVCT 1004-AL	AXCT 06-L	AXM(C)T 0602 APK(C)T 09T3 APK(C)T 1204 APK(C)T 1705 APKT 1907	ANM(H)X 1106 ANM(H)X 1607
Application	Facing 	●	●	●	●	●
	High feed milling 		○		○	
	Shouldering 	●	●	●	●	●
	Slotting 	●	●	●	●	●
	Straight ramping 		●		●	●
	Helical ramping 		●		●	●
	Chamfer & serration 					
	Profiling 			○		○
	Plunging 			●		
	Step down 			●		
	Counter boring 					
	Drill mill 					

Tool Selection Guide

End mills & modular heads

<i>CHASE4MILL</i>	<i>CHASE8MILL</i>	<i>CHASEALU</i>	<i>CHASEALU</i>	<i>MILLRUSH</i>	<i>CHASEQDND</i>
4N TE90	8D-TE90	TE90XEV-HSK63A	TE90XEV	3P-TCF	TSF
					
E142-E147	E148-E151	E152	E153	E154-E155	E156
90°	90°	90°	90°	30°-60°	90°
3.5-13.8	5.0	16	16-21	-	5.6-13.4
Ø8-Ø40	Ø16-Ø40	Ø25-Ø50	Ø25-Ø40	Ø3.3-Ø31	Ø12-Ø50
4NKT 0402 4NK(H)T 0603 4NK(H)T 0904 4NKT 1106 4NKT 1407	SQKU 0703 SQK(H)U 1004	XEVT 1605	XEVT 1605 XEVT 2206	3PKT 0402 3PK(H)T 0603 3PK(H)T 1004	XOMT 0602 SPMG(T) 0904 SPMG(T) 1104 SPMG(T) 1405
●	●	●	●		●
○					
●	●	●	●		●
●	●	●	●		●
●		●	●		
●		●	●		
				●	
○					
					●
●		●	●		
					●

● Recommended, ○ Suitable

Tool Selection Guide

End mills & modular heads

Series						
		TDM	TCF	7S-E45	TBR	TERNS
						
Pages		E157	E158	E159	E160-E162	E163-E164
Approach angle		90°	45°-75°	45°	37°-90°	-
Max. depth of cut(mm)		12-40	-	3.2	6.3-12.0	5.0-8.0
Diameter range(mm)		Ø12-Ø50	Ø8.3-Ø38.9	Ø32-Ø50	Ø12-Ø32	Ø25-Ø50
Insert		XOMT 0602 SPMG(T) 0904 SPMG(T) 1104 SPMG(T) 1405	SPMG(T) 1104	7EMT 0604	BRHU 06R2 BRHU 12R3	RNMU 1004 RNMU 1205 RNMU 1606
Application	Facing		●	●		●
	High feed milling					
	Shouldering		●			
	Slotting		●			
	Straight ramping		●		●	●
	Helical ramping		●		●	●
	Chamfer & serration			●	●	
	Profiling					●
	Plunging		●			
	Step down		●			
	Counter boring		●			
	Drill mill		●			

Tool Selection Guide















End mills & modular heads

CHASEMOLD	FINEBALL	FINEBALL	CHASESPEED	DUSTBALL	TRIOBALL
TERY	TNF	TNFR	TERP	2F	3F
					
E165-E167	E168-E170	E171-E173	E174-E175	E176-E177	E178
-	-	-	-	-	-
4.0-10.0	-	-	4.7-6.3	11.8-55.3	39-94
Ø16-Ø50	Ø6-Ø32	Ø6-Ø32	Ø20-Ø40	Ø16-Ø32	Ø32-Ø50
RYM(H)X 0803 RYM(H)X 1004 RYM(H)X 1205 RYM(H)X 1606 RYM(H)X 2007	NFB (NFR) NFLB NFCB	NFR	RPGN 0903 FL RPGN 1204 FL	2FB APKT 09T3 APKT 1204	3FB CNHX 1311 CNHX 1606
●		●	●		
		●			
		●			
●	●	●	●	●	●
●	●	●	●	●	●
●	●	●	●	●	●
	○	○			
	○	○			

● Recommended, ○ Suitable

Tool Selection Guide

End mills & modular heads

Series						
		TDB50X	TDB50X-WT			
						
Pages		E179	E180			
Approach angle		-	-			
Max. depth of cut(mm)		59-69	59-69			
Diameter range(mm)		Ø50	Ø50			
Insert		6RBE 50-M	6RBE 50-M			
Application	Facing					
	High feed milling					
	Shouldering					
	Slotting					
	Straight ramping		•	•		
	Helical ramping		•	•		
	Profiling		•	•		
	Plunging					
	Step down					
	Counter boring					
	Drill mill					

Tool Selection Guide















High feed end mills & modular heads

						
		THFN	TEBN	TEPT	TEBLV	TEBL
Series						
Pages		E181-E182	E183-E184	E185	E186-E188	E189-E196
Approach angle		20°	-	25°	-	-
Max. depth of cut(mm)		0.3-0.5	1.0-1.5	1.5-3.0	0.7-1.0	0.5-2.0
Diameter range(mm)		Ø6-Ø8	Ø16-Ø40	Ø20-Ø40	Ø16-Ø40	Ø8-Ø42
Insert		HFN 060 HFN 080	BNGX 0603 BNGX 0904	PTKU 0503 PTKU 1006	BLMV 0603	BLMP 0402 BLMP 0603 BLMP 0904 BLMP 1105
Application	Facing		●	●	●	●
	High feed milling		●	●	●	●
	Shouldering		○	○	○	○
	Slotting					
	Straight ramping		●	●	●	●
	Helical ramping		●	●	●	●
	Profiling		●	●	●	●
	Plunging					●
	Step down					●
	Counter boring					
	Drill mill					

● Recommended, ○ Suitable





















Tool Selection Guide

High feed end mills & modular heads

Series						
		TEBL-13	TESB			
						
Pages		E197	E198-E200			
Approach angle		-	-			
Max. depth of cut(mm)		2.0	1.0-2.0			
Diameter range(mm)		Ø32-Ø42	Ø16-Ø42			
Insert		BLMP 1306	SBMT 0603 SBMT 0904 SBMT 1306			
Application	Facing		●	●		
	High feed milling		●	●		
	Shouldering		○	○		
	Slotting					
	Straight ramping		●	●		
	Helical ramping		●	●		
	Profiling		●	●		
	Plunging					
	Step down					
	Counter boring					
	Drill mill					

Tool Selection Guide





















Extended flute cutters

						
Series		4T-TEF 	4T-TES 	4S-TEF 4S-TES 	4S-TFP 4S-TEF-B 4S-TES-B 	3P TEF 3P TES 
Pages		E201	E202	E203-E204	E205-E207	E208-E209
Approach angle		90°	90°	90°	90°	90°
Max. depth of cut(mm)		15-51	34-56	52-77.9	34-76	20-83
Diameter range(mm)		Ø16-Ø40	Ø50-Ø100	Ø32-Ø80	Ø40-Ø80	Ø20-Ø100
Insert		LPK(H)U 0502 LPK(H)U 0904	LPKU 1407	SVKT 0938 SVK(H)T 1145	SVKT 0938 SVK(H)T 1145	3PK(H)T 0603 3PK(H)T 1004 3PK(H)T 1505 3PK(H)T 1906
Application	Facing 					
	High feed milling 					
	Shouldering 	●	●	●	●	●
	Slotting 					
	Trochoidal milling 	●	●	●	●	
	Straight ramping 					
	Helical ramping 					
	Profiling 					
	Plunging 					
	Step down 					
	Counter boring 					

● Recommended, ○ Suitable

Tool Selection Guide

Extended flute cutters

						
Series		TEF-TN TES-TN 	TEF-AN TES-AN 	TEF-AV10 TES-AV10 	TEF-AX 2S-TEF-AP TEF-AP 	TES-AP 
Pages		E210-E211	E212-E213	E214-E215	E216	E217
Approach angle		90°	90°	90°	90°	90°
Max. depth of cut(mm)		48-71	40-69	27-44	16-45	45-88
Diameter range(mm)		Ø50-Ø100	Ø32-Ø100	Ø25-Ø50	Ø16-Ø40	Ø50-Ø100
Insert		TNMX 1806	ANM(H)X 1106 ANM(H)X 1607	AVKT 1004 AVCT 1004-AL	AXM(C)T 0602 APK(C)T 09T3 APK(C)T 1204 APK(C)T 1705	APK(C)T 1204 APK(C)T 1705
Application	Facing 					
	High feed milling 					
	Shouldering 	•	•	•	•	•
	Slotting 					
	Trochoidal milling 				•	•
	Straight ramping 					
	Helical ramping 					
	Profiling 					
	Plunging 					
	Step down 					
	Counter boring 					

**TEF
TES**



E218

90°

23.8-48.4

Ø32-Ø80

SPMG(T) 0904
SPMG(T) 1104
SPMG(T) 1405

●

Tool Selection Guide

Slotting cutters

Series		TOPSLOT	TOPSLOT	TOPSLOT	TOPSLOT	TOPSLOT
		TSM-TS16	TSM-SL	TSM-FD-Z	TSM-FD-ZN	TSM-FD-S/W-ZN
						
Pages		E219-E220	E221-E222	E223-E224	E225	E226-E228
Approach angle		-	-	-	-	-
Max. width of cut(mm)		1.2-6.0	3-6	3-10	10-20	10-26
Diameter range(mm)		Ø32.2-Ø80	Ø25-Ø63	Ø63-Ø250	Ø80-Ø125	Ø100-Ø315
Insert		TS16	SLOT	ZNHT	ZNHU 080 ZNHU 110	ZNHU 080 ZNHU 110 ZNHU 140
Application	Facing		●			
	Shouldering					
	Slotting					
	T slotting		●	●		
	Side slotting		●	●	●	●
	Internal groove milling		●	●		
	Bottom shouldering		●	●	●	●
	Slitting				●	●

Tool Selection Guide















Slotting cutters

TOPSLOT	TOPSLOT	TOPSLOT	TSC Slotting Cutter	TANGSPEED	MAXITANG
TSM-FF-Z	TSM-FF-ZN	TSM-FF-S/W-ZN	TSC	4T-TSM-W	4T-TSM-TR
					
E229	E230	E231-E233	E234	E235	E236
-	-	-	-	-	-
3-10	10-20	10-26	1.6-4.52	7	7
Ø80-Ø160	Ø63-Ø125	Ø100-Ø315	Ø75-Ø160	Ø16-Ø40	Ø23-Ø40
ZNHT	ZNHU 080 ZNHU 110	ZNHU 080 ZNHU 110 ZNHU 140	TIMC TIMJ TIPV	LXHU 0502	LXHU 0502
●	●	●		●	●
●	●	●	●	●	●
●	●	●		●	●
			●		

● Recommended, ○ Suitable

















Tool Selection Guide

Slotting cutters

		<i>MAXITANG</i>	<i>MAXISPEED</i>	<i>MAXISPEED</i>	<i>MAXISPEED</i>	
Series		4T-TE90-TR	TR-S	TR-F	TR-T-W55 TR-T-M60	
						
Pages		E237	E238	E239	E240	
Approach angle		-	-	-	-	
Max. width of cut(mm)		4.6	3-10	8-10	7.7-9.5	
Diameter range(mm)		Ø25-Ø40	Ø24.7-Ø39.7	Ø24.25-Ø39.25	Ø24.7-Ø39.7	
Insert		LPK(H)U 0502	-	-	-	
Application	Facing		●		●	
	Shouldering		●		●	
	Slotting					
	T slotting			●		
	Side slotting			●		
	Internal groove milling					
	Bottom shouldering			●		
	Slitting					
	External threading					●
	Internal threading					●

Tool Selection Guide

Milling inserts

















		WINMILL	MAXITANG	TANGSPEED	MILLRUSH	MILL2RUSH
		CVK(H)T 0502	LXHU 05-04	LPK(H)U 0502 LPK(H)U 0904 LPKU 1407	3PKT 0402 3PK(H)T 0603 3PK(H)T 1004 3PK(H)T 1505 3PK(H)T 1906	6NKU 0403 6NGU 0604 6NGU 0905
Series						
Material		P M N S	P M K S H	P M K S H	P M K N S H	P M K N S H
Pages		E273	E277	E276	E250-E251	E254-E255
Approach angle		90°	90°	90°	90°	90°
Max. depth of cut(mm)		0.5-5	*	4.6-12.5	3.5-15	4.1-9.2
Application	Facing		●	●	●	●
	High feed milling		○			
	Shouldering		●	●	●	●
	Slotting		●	●	●	●
	Straight ramping		●	●	●	
	Helical ramping		●	●	●	
	Step down					
	Profiling		○			
	T slotting			●		
	Side slotting			●		
	Bottom shouldering			●		

▶ *1 Marked: For CDX, refer to the cutter page

● Recommended, ○ Suitable



Tool Selection Guide

Milling inserts

		BELL2RUSH	WINMILL	CHASEMILL	CHASEMILL	CHASEMILL
Series		TNMX 1806 TNM(G)X 2207	AVK(C)T 1004	AXCT 0602-L	AXM(C)T 0602 APK(C)T 09T3 APK(C)T 1204 APK(C)T 1705 APKT 1907	APCT 12-PCD35
						
Material		P M K S H	P M K N S H	P M S	P M K N S H	N
Pages		E302	E267	E266	E259-E267	E260
Approach angle		90°	90°	90°	90°	90°
Max. depth of cut(mm)		13-15	1.0-10	5.5	0.5-17.9	3.5
Application	Facing 	●	●	●	●	●
	High feed milling 		○		○	
	Shouldering 	●	●	●	●	●
	Slotting 	●	●	●	●	●
	Straight ramping 		●		●	
	Helical ramping 		●		●	
	Chamfer & serration 					
	Profiling 		○		○	
	Plunging 					
	Step down 					
	Counter boring 					

Tool Selection Guide

















Milling inserts

CHASE2MILL	CHASE4MILL	CHASE3MILL	CHASE3SPEED	CHASEALU	CHASE4FINISH
ANM(H)X 1106 ANM(H)X 1607	4NKT 0402 4NK(H)T 0603 4NK(H)T 0904 4NKT 1106 4NKT 1407	SQKU 0703 SQK(H)U 1004 SQK(H)U 1206	SQKU 1105 SQKU 1406	XEVT 1605 XEVT 2206	4WHU 1207
					
P M K N S H	P M K N S H	P M K S H	P M K S H	N	P M K N S H
E258	E252-E253	E297	E298	E305	E254
90°	90°	90°	20°,45°	90°	90°
11-15	0.5-13.8	5.0-8.5	1.8-6.0	14-21	0.5
●	●	●	●	●	●
	○				
●	●	●		●	
●	●	●		●	
●	●			●	
●	●			●	
			●		
	○				
	●			●	

● Recommended, ○ Suitable







Tool Selection Guide

Milling inserts

Series		CHASE ² QUAD	LION ^{MILL}	LION ^{MILL}	CHASE ^V QUAD	CHASE ² QUAD
		SNEX 1204 SNET 1205	TPKN 2204	SEKX 2107	SVK(H)T 1145	SNGX 1306... SNGX 1306 ZN
						
Material		P K	P M K	P K	P M K S H P M K	
Pages		E291	E303	E289	E299	E291
Approach angle		75°	75°	65°	60°	45°
Max. depth of cut(mm)		9.5-12.5	3.9	3.3-6.5	13-18	3.0-5.0
Application	Facing	 ●	●	●		●
	High feed milling	 HF				
	Shouldering	 ●	●	●	●	●
	Slotting	 ●		●	●	
	Straight ramping					
	Helical ramping					
	Chamfer & serration					
	Profiling					
	Plunging					
	Step down					
	Counter boring					

Tool Selection Guide





















Milling inserts

<i>CHASE2QUAD</i>	<i>LIONMILL</i>	<i>CHASEMILL</i>	<i>CHASE10MILL</i>	<i>LIONMILL</i>	<i>CHASE2MILL</i>
SNM(G)X 1306 EN... SNMX 1306 XTN	SPKN 1203 SPKN 1504	APKT 1705	PTKU 0503 PTKU 1006	SCKN 2107 SCKN 2708	HXX(H)U 0605 HXX(H)U 1007
					
P M K	P M K	P M K N S H	P M K	P K	P K
E292	E296	E262	E282	E288	E275
75°	75°	75°	65°	60°	45°
9.5	9.5-12.5	3.9	3.3-6.5	13-18	3.0-5.0
●	●	●	●	●	●
●	●		●	●	●

● Recommended, ○ Suitable

Tool Selection Guide

Milling inserts

							
Series		XNM(H)U 0605 XNM(H)U 0906	7EMT 0604	SNM(G)X 1306 AN... SNMX 1306 XTN	SNMX 1607 SNHX 1606	ANHX 1607	
							
Material		P M K	P M K	P M K N	P M K	P M K N S	
Pages		E306-E307	E257	E292	E294	E258	
Approach angle		45°	45°	45°	45°	45°	
Max. depth of cut(mm)		1.0-5.0	3.2	6-7	8.8	8.4	
Application	Facing		●	●	●	●	●
	High feed milling						
	Shouldering						
	Slotting						
	Straight ramping			●			
	Helical ramping			●			
	Chamfer & serration		●	●	●	●	
	Profiling						
	Plunging						
	Step down						
	Counter boring						

Tool Selection Guide

Milling inserts

LIONMILL	SPEEDBARREL	CHASE2MOLD	CHASEMOLD	CHASESPEED	CERAMICSPEED
SDKN 1203 SDKN 1504 SEKN 1203 SEKN 1504	BRHU 06R2 BRHU 12R3	RNMU 1004 RNMU 1205 RNMU 1606	RYM(H)X 0803 RYM(H)X 1004 RYM(H)X 1205 RYM(H)X 1606 RYMX 2007	RNGN 1207 FL RPGN 0903 FL RPGN 1204 FL	BNGX 0603 BNGX 0904
					
P	P M K S H	P M K S H	P M K S H	S	S
E288-E289	E272	E284	E285-E286	E283	E271
45°	90°,75°,45°	-	-	-	-
6.5-8.7	4.2-12.0	5-8	4-10	4.7-6.3	1.5
●		●	●	●	●
					●
					○
		●	●	●	●
		●	●	●	●
●					
	●	●	●	●	●

● Recommended, ○ Suitable







Tool Selection Guide

Milling inserts

Series		BNGX 1207 	PTKU 0503 PTKU 1006 	BLMV 0603 	BLMP 0402 BLMP 0603 BLMP 0904 BLMP 1105 	BLMP 1306
Material		S	P M K	P M K S H	P M K S H	P M K S H
Pages		E271	E282	E270	E268	E269
Approach angle		-	25°	-	-	-
Max. depth of cut(mm)		2.5	1.5-3.0	0.7-1.0	0.5-2.0	2.0
Application	Facing 	●	●	●	●	●
	High feed milling 	●	●	●	●	●
	Shouldering 	○	○	○	○	○
	Slotting 					
	Straight ramping 	●	●	●	●	●
	Helical ramping 	●	●	●	●	●
	Chamfer & serration 					
	Profiling 	●	●	●	●	●
	Plunging 			●		
	Step down 			●		
	Counter boring 					
	Drill mill 					

Tool Selection Guide













Milling inserts

CHASE FEED			MILL RUSH			CHASE QUAD			NAN RUSH			FINE BARREL			FINE BARREL								
SBMT 0603 SBMT 0904 SBMT 1306			3PKT 0402 3PK(H)T 0603 3PK(H)T 1004			SPMG(T) 0904 SPMG(T) 1104 SPMG(T) 1405 XOMT 0602			HFN 060 HFN 080			NFLB			NFCB								
																							
P	M	K	S	H	P	M	K	N	S	H	P	M	K	P	M	K	S	H	P	M	K	S	H
E287			E250			E295			E274			E279			E279								
-			30°-60°			15°-45°, 90°			20°			-			-								
1.0-2.0			-			-			0.3-0.5			-			-								
●						●			●														
●									●														
○						●			○														
						●			●														
●						●			●														
●						●			●														
			●			●																	
●						●			●			●			●								
						●																	
						●																	
						●																	
						●																	

● Recommended, ○ Suitable













Tool Selection Guide

Milling inserts

Series	<i>FINEBALL</i>	<i>FINEBALL</i>	<i>DUETBALL</i>	<i>TRIOBALL</i>	<i>CHASEBALL</i>
	NFB	NFR	2FB	3FB	6RBE
Material	P M K S H	P M K S H	P M K S H	P M K S H	P M K S H
Pages	E278	E280-E281	E248/	E249	E256
Approach angle	-	-	-	-	-
Max. depth of cut(mm)	-	-	11.8-44.7	39-94	59-69
Application	Facing 	●			
	High feed milling 		●		
	Shouldering 		●		
	Slotting 		●	●	●
	Straight ramping 	●	●	●	●
	Helical ramping 	●			
	Chamfer & serration 		○	●	●
	Profiling 	●	●		
	Plunging 	○	○		
	Step down 				
	Counter boring 	○	○		
	Drill mill 				

Tool Selection Guide

Slotting inserts









		TOP SLOT	TOP SLOT	TOP SLOT	TOP SLOT	TSC slotting cutter
Series		TS16	SLOT	ZNHT	ZNHU	TIMC TIMJ TIPV
						
Material		P M K S H	P M K	P M K N	P M K	P M K N
Pages		E304	E290	E308	E309	E300-E301
Approach angle		-	-	-	-	-
Max. depth of cut(mm)		4.8	*	*	*	
Application	Facing 	●				
	Shouldering 					
	Slotting 					
	T slotting 					
	Side slotting 	●	●	●	●	●
	Internal groove milling 					
	Bottom shouldering 					
	Slitting 			●	●	●

▶ *: For CDX, refer to the cutter page

● Recommended, ○ Suitable

Tool Selection Guide

Tailor-made inserts

Series		Tailor-made Insert								
		LNC	PMIN	SNA	SNB					
										
Material		P	M	K	N	S	H			
Pages		E310-E311								
Approach angle		-								
Max. depth of cut(mm)		-								
Application	Facing		●							
	Shouldering		●							
	Slotting		●							
	T slotting									
	Side slotting		●							
	Internal groove milling									
	Bottom shouldering									
	Slitting									

● Recommended, ○ Suitable

Grades

Selection guide for milling grades

For steel

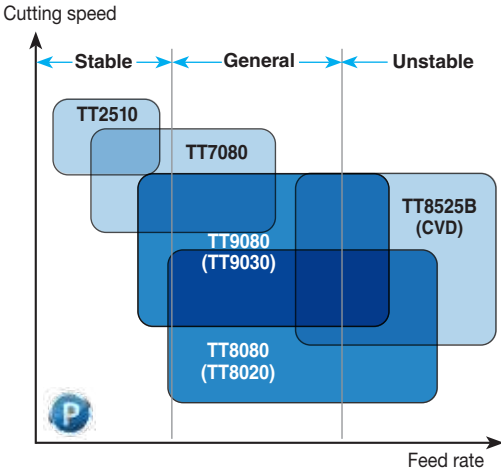

For stainless steel & super alloy

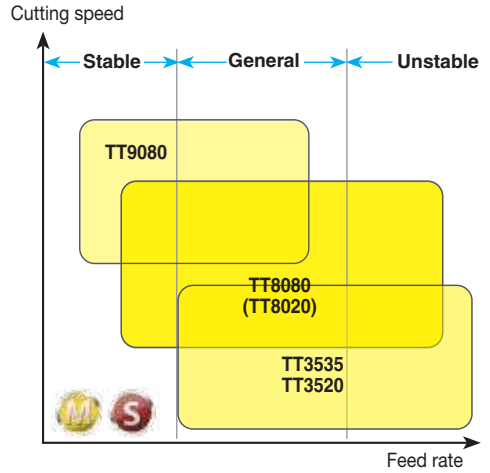

For cast iron

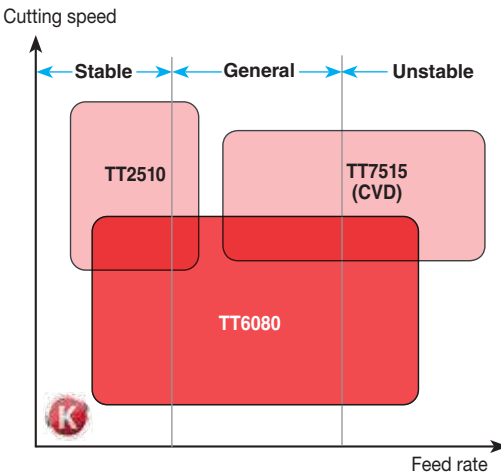

For hardened material

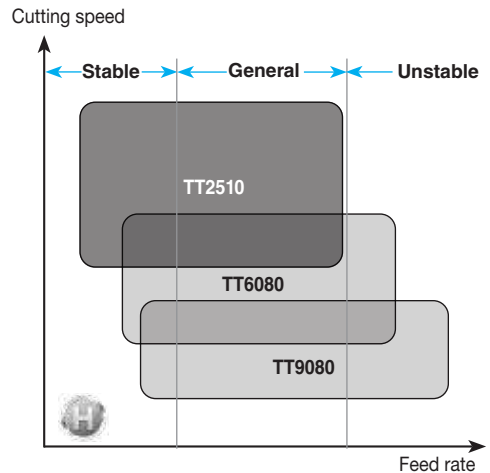

Grades

Carbide grades

Grades	ISO	Characteristics & applications
K10 Carbide	K05 – K15 N05 – N15 S05 – S15	<ul style="list-style-type: none"> • General machining of cast iron, aluminum alloys and non-ferrous materials
TT2510 PVD coated	P05 – P25 H05 – H25	<ul style="list-style-type: none"> • High speed milling of pre-hardened steel and hardened steel
TT3535 PVD coated	M30 – M50 S30 – S50	<ul style="list-style-type: none"> • Interrupted and rough machining of stainless steel • Low speed and interrupted machining of Ti-Alloy and heat-resistant alloy
TT3520 CVD coated	M30 – M50 S30 – S50	<ul style="list-style-type: none"> • Interrupted and rough machining of stainless steel • Low speed and interrupted machining of Ti-Alloy and heat-resistant alloy
TT6080 PVD coated	K05 – K25 H05 – H25	<ul style="list-style-type: none"> • General machining for gray and ductile cast iron • Finish and medium machining of hardened steel
TT7080 PVD coated	P05 – P25 K05 – K25	<ul style="list-style-type: none"> • General milling of steel • Heavy interrupted cutting of cast iron
TT9080 PVD coated	P20 – P40 M20 – M40 S20 – S40	<ul style="list-style-type: none"> • General machining of steel, stainless steel and heat-resistant alloy
TT9030 PVD coated	P20 – P40 M20 – M40 S20 – S40	<ul style="list-style-type: none"> • General machining of steel, stainless steel and heat-resistant alloy
TT8080 PVD coated	P30 – P50 M30 – M50 S30 – S50	<ul style="list-style-type: none"> • Interrupted and rough machining of steel and stainless steel • Low speed and interrupted machining of heat-resistant alloy
TT8020 PVD coated	P30 – P50 M30 – M50 S30 – S50	<ul style="list-style-type: none"> • Interrupted and rough machining of steel and stainless steel • Low speed and interrupted machining of heat-resistant alloy
TT5515 PVD coated	P10 – P30 M10 – M30 K10 – K30 S10 – S30 H10 – H30	<ul style="list-style-type: none"> • High speed milling of steel and hardened steel • General milling of stainless steel, cast iron and heat-resistant alloy
TT5525 PVD coated	P20 – P40 M20 – M40 S20 – S40	<ul style="list-style-type: none"> • General machining of steel, stainless steel and heat-resistant alloy
TT7515 CVD coated	K05 – K25 H05 – H25	<ul style="list-style-type: none"> • General machining for gray and ductile cast iron • Finish and medium machining of hardened steel
TT8525B CVD coated	P30 – P45 M30 – M45	<ul style="list-style-type: none"> • Rough milling & high speed drilling of carbon & alloy steel • Medium speed milling of stainless steel

Grades

Cermet, ceramic and CBN grades

Grades	ISO	Characteristics & applications
CT7000 cermet	P15 – P25 M15 – M25	<ul style="list-style-type: none"> • Finish milling of steel and stainless steel
AS10 Ceramic	K20 – K30	<ul style="list-style-type: none"> • General milling of cast iron
TC3030 Ceramic	S25 – S35	<ul style="list-style-type: none"> • High feed milling of super alloy • SiAlON ceramic grade
TB7015 CBN	H25 – H35 K10 – K20	<ul style="list-style-type: none"> • Machining of hardened steel • High speed machining of cast iron



Milling Cutters



Face mills

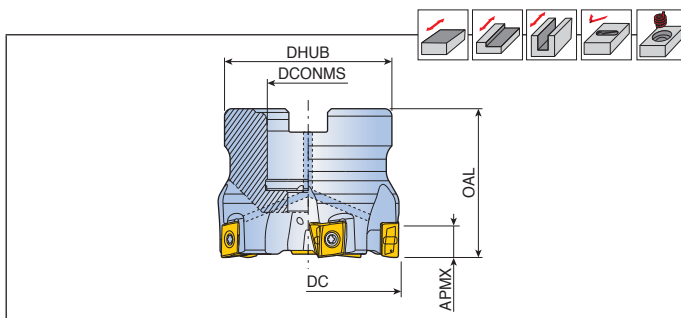

Designation		Dimension (mm)					Coolant hole	Arbor style		Mounting bolt	Insert
		DC	DCONMS	DHUB	OAL	APMX					
4T-TF90-640-16R-09	6	40	16	38	40	8.3	●	A	0.3	SH M8x30	LPK(H)U 0904...
550-22R-09	5	50	22	45	40	8.3	●	A	0.4	SH M10x30	
750-22R-09	7	50	22	45	40	8.3	●	A	0.4	SH M10x30	
663-22R-09	6	63	22	47	40	8.3	●	A	0.5	SH M10x30	
1063-22R-09	10	63	22	47	40	8.3	●	A	0.5	SH M10x30	
4T-TF90-440-16R-14	4	40	16	38	40	12.5	●	A	0.3	SH M8x30	LPKU 1407...
450-22R-14	4	50	22	45	40	12.5	●	A	0.3	SH M10x30	
650-22R-14	6	50	22	45	40	12.5	●	A	0.3	SH M10x30	
563-22R-14	5	63	22	47	40	12.5	●	A	0.5	SH M10x30	
863-22R-14	8	63	22	47	40	12.5	●	A	0.5	SH M10x30	
780-27R-14	7	80	27	58	50	12.5	●	A	1.0	SH M12x35	
1080-27R-14	10	80	27	58	50	12.5	●	A	1.2	SH M12x35	
8100-32R-14	8	100	32	85	50	12.5	●	A	2.0	SH M16x35	
12100-32R-14	12	100	32	85	50	12.5	●	A	2.1	SH M16x35	
10125-40R-14	10	125	40	85	63	12.5	●	A	3.1	SH M20x40	
14125-40R-14	14	125	40	85	63	12.5	●	A	3.3	SH M20x40	
12160-40R-14	12	160	40	110	63	12.5	x	C	4.1	-	
16160-40R-14	16	160	40	110	63	12.5	x	C	4.3	-	
14200-60R-14	14	200	60	130	63	12.5	x	C	5.7	-	
18200-60R-14	18	200	60	130	63	12.5	x	C	5.8	-	

▶ Mounting bolt with coolant through hole is available on request (ordering example: SH M10x1.5x30-C)

Spare parts

Designation	Screw	Wrench	Wrench handle	
4T-TF90-09	TS 30D082-P	TBLD T08P-W4	THND 4W	-
4T-TF90-14	TS 40G110I	TBLD T15-W6	-	SW6-T

 E312-E315	 E316-E317	 E318	 E333-E334
---------------	---------------	----------	---------------

3P TF90-06/10/15



Face mills

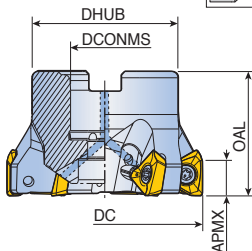
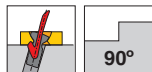
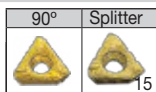

Designation	⊙	Dimension (mm)					Coolant hole	Arbor style	Kg	Mounting bolt	Insert
		DC	DCONMS	DHUB	OAL	APMX					
3P TF90-632-16R-06	6	32	16	30	32	4.7	●	A	0.1	SH M8x30	3PK(H)T 0603... E250
732-16R-06	7	32	16	30	32	4.7	●	A	0.1	SH M8x30	
735-16R-06	7	35	16	30	35	4.7	●	A	0.1	SH M8x30	
840-16R-06	8	40	16	38	40	4.7	●	A	0.2	SH M8x30	
840-22R-06	8	40	22	38	40	4.7	●	A	0.2	SH M10x30	
3P TF90-540-16R-10	5	40	16	38	40	7	●	A	0.3	SH M8x30	3PK(H)T 1004... E250
640-16R-10	6	40	16	38	40	7	●	A	0.3	SH M8x30	
650-22R-10	6	50	22	45	40	7	●	A	0.4	SH M10x30	
750-22R-10	7	50	22	45	40	7	●	A	0.4	SH M10x30	
663-22R-10	6	63	22	45	40	7	●	A	0.5	SH M10x30	
863-22R-10	8	63	22	47	40	7	●	A	0.5	SH M10x30	
963-22R-10	9	63	22	47	40	7	●	A	0.5	SH M10x30	3PK(H)T 1505... E250-251
3P TF90-450-22R-15	4	50	22	45	40	11	●	A	0.3	SH M10x30	
550-22R-15	5	50	22	45	40	11	●	A	0.3	SH M10x30	
463-22R-15-B	4	63	22	47	40	11	●	A	0.5	SH M10x30	
463-27R-15-B	4	63	27	47	50	11	●	A	0.5	SH M12x35	
663-22R-15	6	63	22	47	40	11	●	A	0.5	SH M10x30	
480-27R-15-B	4	80	27	58	50	11	●	A	1.0	SH M12x35	
780-27R-15	7	80	27	58	50	11	●	A	1.0	SH M12x35	
880-27R-15	8	80	27	58	50	11	●	A	1.0	SH M12x35	
6100-32R-15-B	6	100	32	85	50	11	●	A	1.8	LH M16x35	
8100-32R-15	8	100	32	85	50	11	●	A	1.9	LH M16x35	
10100-32R-15	10	100	32	85	50	11	●	A	1.9	LH M16x35	
7125-40R-15-B	7	125	40	85	63	11	●	A	3.0	SH M20x40	
8125-40R-15	8	125	40	85	63	11	●	A	3.0	SH M20x40	
10125-40R-15	10	125	40	85	63	11	●	A	3.1	SH M20x40	
12125-40R-15	12	125	40	85	63	11	●	A	3.1	SH M20x40	
8160-40R-15	8	160	40	85	63	11	x	C	4.4	-	
12160-40R-15	12	160	40	110	63	11	x	C	4.4	-	
15160-40R-15	15	160	40	110	63	11	x	C	4.4	-	
15200-60R-15	15	200	60	130	63	11	x	C	6.0	-	
18200-60R-15	18	200	60	130	63	11	x	C	5.8	-	

► Mounting bolt with coolant through hole is available on request (ordering example: SH M10x1.5x30-C)



3P TF90-15/19



Face mills (Inch bore)

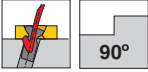
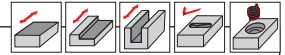
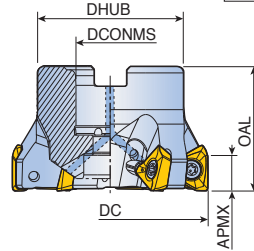
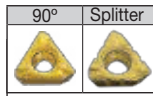

Designation	Z	Dimension (mm)					Coolant hole	Arbor style	Kg	Mounting bolt	Insert
		DC	DCONMS	DHUB	OAL	APMX					
3P TF90-480-25.4R-15-B	4	80	25.4	70	50	11	●	A	1.2	SH M12x35	3PK(H)T 1505... E250-251
780-25.4R-15	7	80	25.4	70	50	11	●	A	1.0	SH M12x35	
880-25.4R-15	8	80	25.4	70	50	11	●	A	1.0	SH M12x35	
6100-31.75R-15-B	6	100	31.75	80	50	11	●	B	1.5	-	
8100-31.75R-15	8	100	31.75	80	50	11	x	B	1.9	-	
10100-31.75R-15	10	100	31.75	80	50	11	x	B	1.9	-	
7125-38.1R-15-B	7	125	38.1	80	63	11	x	B	2.4	-	
10125-38.1R-15	10	125	38.1	80	63	11	x	B	3.1	-	
12125-38.1R-15	12	125	38.1	80	63	11	x	B	3.1	-	
8160-50.8R-15	8	160	50.8	100	63	11	x	B	2.6	-	
12160-50.8R-15	12	160	50.8	100	63	11	x	B	4.4	-	
15160-50.8R-15	15	160	50.8	100	63	11	x	B	4.4	-	
15200-47.625R-15	15	200	47.625	130	63	11	x	C	6.0	-	
3P TF90-480-25.4R-19	4	80	25.4	70	50	15	●	A	0.9	SH M12x35	3PK(H)T 1906... E250-251
780-25.4R-19	7	80	25.4	70	50	15	●	A	1.0	SH M12x35	
6100-31.75R-19	6	100	31.75	80	50	15	x	B	1.8	-	
8100-31.75R-19	8	100	31.75	80	50	15	x	B	2.6	-	
6125-38.1R-19	6	125	38.1	80	63	15	x	B	4.4	-	
8125-38.1R-19	8	125	38.1	80	63	15	x	B	3.0	-	
10125-38.1R-19	10	125	38.1	80	63	15	x	B	3.1	-	
8160-50.8R-19	8	160	50.8	100	63	15	x	B	4.2	-	
12160-50.8R-19	12	160	50.8	100	63	15	x	B	4.3	-	
10200-47.625R-19	10	200	47.625	130	63	15	x	C	6.0	-	
14200-47.625R-19	14	200	47.625	130	63	15	x	C	6.0	-	

▶ Mounting bolt with coolant through hole is available on request (ordering example: SH M10x1.5x30-C)

Spare parts

Designation	Screw	Wrench			
3P TF90-15	TS 40B100I	TD 15	-		
3P TF90-19	TS 45120I	-	T-T20		



6N TF90-06/09



Face mills

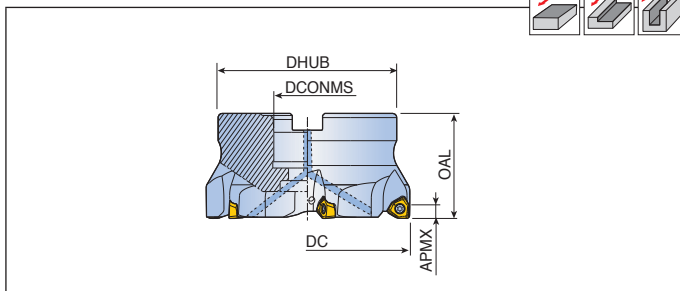

Designation	Z	Dimension (mm)					Coolant hole	Arbor style	Kg	Mounting bolt	Insert
		DC	DCONMS	DHUB	OAL	APMX					
6N TF90-440-16R-06	4	40	16	38	40	6.2	●	A	0.3	SH M8x30	6NGU 0604... E254
450-22R-06	4	50	22	45	40	6.2	●	A	0.4	LH M10x25	
650-22R-06	6	50	22	45	40	6.2	●	A	0.4	LH M10x25	
463-22R-06	4	63	22	47	40	6.2	●	A	0.5	LH M10x25	
663-22R-06	6	63	22	47	40	6.2	●	A	0.5	LH M10x25	
763-22R-06	7	63	22	47	40	6.2	●	A	0.5	LH M10x25	
580-27R-06	5	80	27	58	50	6.2	●	A	1.0	SH M12x35	
680-27R-06	6	80	27	58	50	6.2	●	A	1.0	SH M12x35	
780-27R-06	7	80	27	58	50	6.2	●	A	1.0	SH M12x35	
980-27R-06	9	80	27	58	50	6.2	●	A	1.0	SH M12x35	
6100-32R-06	6	100	32	85	50	6.2	●	A	1.9	SH M16x35	
8100-32R-06	8	100	32	85	50	6.2	●	A	1.9	SH M16x35	
11100-32R-06	11	100	32	85	50	6.2	●	A	1.9	SH M16x35	
7125-40R-06	7	125	40	85	63	6.2	●	A	3.2	SH M20x40	
11125-40R-06	11	125	40	85	63	6.2	●	A	3.2	SH M20x40	
6N TF90-450-22R-09	4	50	22	45	40	9.2	●	A	0.3	LH M10x25	6NGU 0905... E254
550-22R-09	5	50	22	45	40	9.2	●	A	0.4	LH M10x25	
463-22R-09	4	63	22	47	40	9.2	●	A	0.5	LH M10x25	
663-22R-09	6	63	22	47	40	9.2	●	A	0.5	LH M10x25	
763-22R-09	7	63	22	47	40	9.2	●	A	0.5	LH M10x25	
580-27R-09	5	80	27	58	50	9.2	●	A	1.0	SH M12x35	
780-27R-09	7	80	27	58	50	9.2	●	A	1.1	SH M12x35	
880-27R-09	8	80	27	58	50	9.2	●	A	1.1	SH M12x35	
980-27R-09	9	80	27	58	50	9.2	●	A	1.1	SH M12x35	
6100-32R-09	6	100	32	85	50	9.2	●	A	1.9	LH M16x35	
8100-32R-09	8	100	32	85	50	9.2	●	A	1.8	LH M16x35	
11100-32R-09	11	100	32	85	50	9.2	●	A	1.9	LH M16x35	
7125-40R-09	7	125	40	85	63	9.2	●	A	3.1	SH M20x40	
8125-40R-09	8	125	40	85	63	9.2	●	A	3.1	SH M20x40	
11125-40R-09	11	125	40	85	63	9.2	●	A	3.1	SH M20x40	
14125-40R-09	14	125	40	85	63	9.2	●	A	3.2	SH M20x40	
12160-40R-09	12	160	40	110	63	9.2	x	C	4.3	-	
16160-40R-09	16	160	40	110	63	9.2	x	C	4.3	-	
14200-60R-09	14	200	60	130	63	9.2	x	C	5.9	-	
18200-60R-09	18	200	60	130	63	9.2	x	C	5.9	-	
18250-60R-09	18	250	60	160	63	9.2	x	C	10.7	-	
22250-60R-09	22	250	60	160	63	9.2	x	C	10.8	-	



► Mounting bolt with coolant through hole is available on request (ordering example: SH M10x1.5x30-C)

6N TF90-06/09



Face mills (Inch bore)

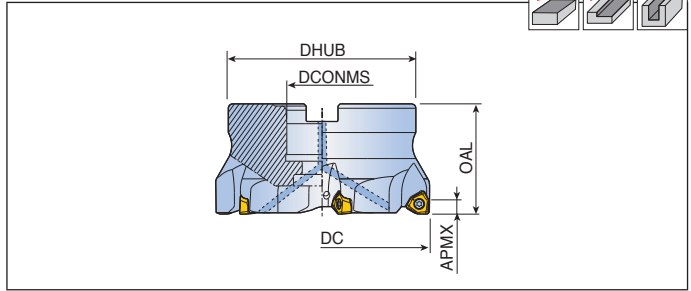

Designation		Dimension (mm)					Coolant hole	Arbor style	Kg	Mounting bolt	Insert
		DC	DCONMS	DHUB	OAL	APMX					
6N TF90-580-25.4R-06	5	80	25.4	70	50	6.2	●	A	1.0	SH M12x35	6NGU 0604...
780-25.4R-06	7	80	25.4	70	50	6.2	●	A	1.0	SH M12x35	E254
980-25.4R-06	9	80	25.4	70	50	6.2	●	A	1.0	SH M12x35	
6100-31.75R-06	6	100	31.75	80	50	6.2	x	B	1.9	-	
8100-31.75R-06	8	100	31.75	80	50	6.2	x	B	1.9	-	
11100-31.75R-06	11	100	31.75	80	50	6.2	x	B	1.9	-	
7125-38.1R-06	7	125	38.1	80	63	6.2	x	B	3.2	-	
6N TF90-580-25.4R-09	5	80	25.4	58	50	9.2	●	A	1.0	SH M12x35	6NGU 0905...
780-25.4R-09	7	80	25.4	58	50	9.2	●	A	1.1	SH M12x35	E254
980-25.4R-09	9	80	25.4	58	50	9.2	●	A	1.1	SH M12x35	
6100-31.75R-09	6	100	31.75	80	50	9.2	x	B	1.9	-	
8100-31.75R-09	8	100	31.75	80	50	9.2	x	B	1.8	-	
11100-31.75R-09	11	100	31.75	80	50	9.2	x	B	1.9	-	
7125-38.1R-09	7	125	38.1	80	63	9.2	x	B	3.1	-	
11125-38.1R-09	11	125	38.1	80	63	9.2	x	B	3.1	-	
14125-38.1R-09	14	125	38.1	80	63	9.2	x	B	3.2	-	
12160-50.8R-09	12	160	50.8	100	63	9.2	x	B	4.3	-	
16160-50.8R-09	16	160	50.8	100	63	9.2	x	B	4.3	-	

▶ Mounting bolt with coolant through hole is available on request (ordering example: SH M10x1.5x30-C)

Spare parts

Designation	Screw	Wrench			
6N TF90-06	TS 300851/HG	TD 9	-		
6N TF90-09	TS 40B100I	-	T-T15		

 E312-E315	 E316-E317	 E318
---------------	---------------	----------

SCRM90TN-18/22



Face mills

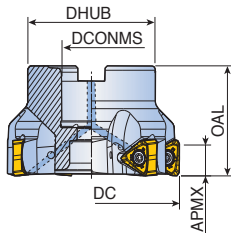
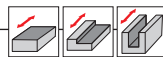
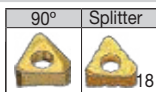

Designation		Dimension (mm)					Coolant hole	Arbor style	Kg	Mounting bolt	Insert
		DC	DCONMS	DHUB	OAL	APMX					
SCRM90TN 450-16R-18	4	50	16	38	40	13	●	A	0.3 SH M8x30	TNMX 1806... E302	
563-22R-18	5	63	22	47	40	13	●	A	0.5 SH M10x30		
580-27R-18	5	80	27	58	50	13	●	A	1.1 SH M12x35		
780-27R-18	7	80	27	58	50	13	●	A	1.1 SH M12x35		
6100-32R-18-B	6	100	32	85	50	13	●	A	2.0 SH M16x35		
8100-32R-18	8	100	32	85	50	13	●	A	2.0 SH M16x35		
7125-40R-18-B	7	125	40	85	63	13	●	A	3.4 SH M20x40		
10125-40R-18	10	125	40	85	63	13	●	A	3.3 SH M20x40		
10160-40R-18	10	160	40	110	63	13	x	C	4.5 -		
14160-40R-18	14	160	40	110	63	13	x	C	4.5 -		
16200-60R-18	16	200	60	130	63	13	x	C	6.2 -		
SCRM90TN 350-16R-22	3	50	16	38	40	15	●	A	0.3 SH M8x30	TNM(G)X 2207... E302	
463-22R-22	4	63	22	47	40	15	●	A	0.4 SH M10x30		
580-27R-22	5	80	27	58	50	15	●	A	0.9 SH M12x35		
6100-32R-22	6	100	32	85	50	15	●	A	1.8 SH M16x35		
8125-40R-22	8	125	40	85	63	15	●	A	3.0 SH M20x40		
10160-40R-22	10	160	40	110	63	15	x	C	4.2 -		
12200-60R-22	12	200	60	130	63	15	x	C	6 -		
14250-60R-22	14	250	60	160	63	15	x	C	10.6 -		

► Mounting bolt with coolant through hole is available on request (ordering example: SH M10x1.5x30-C)

Spare parts

Designation	Screw	Wrench			
SCRM90TN-18	TS 40B100I	T-T15			
SCRM90TN-22	TS 45I20I	T-T20			



SCRM90TN



Face mills (Inch bore)

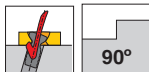
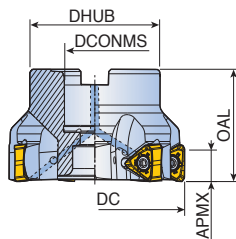
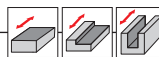
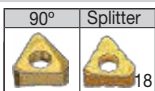

Designation		Dimension (mm)					Coolant hole	Arbor style	Kg	Mounting bolt	Insert
		DC	DCONMS	DHUB	OAL	APMX					
SCRM90TN 580-25.4R-18	5	80	25.4	70	50	13	●	A	1.1 SH M12x35	TNMX 1806...	
780-25.4R-18	7	80	25.4	70	50	13	●	A	1.1 SH M12x35	E302	
6100-31.75R-18-B	6	100	31.75	80	50	13	x	B	2.0 -		
8100-31.75R-18	8	100	31.75	80	50	13	x	B	2.0 -		
7125-38.1R-18-B	7	125	38.1	80	63	13	x	B	3.4 -		
10125-38.1R-18	10	125	38.1	80	63	13	x	B	3.3 -		
10160-50.8R-18	10	160	50.8	100	63	13	x	B	4.5 -		
14160-50.8R-18	14	160	50.8	100	63	13	x	B	4.5 -		
16200-47.625R-18	16	200	47.625	130	63	13	x	C	6.2 -		
SCRM90TN 580-25.4R-22	5	80	25.4	70	50	15	●	A	0.9 SH M12x35	TNM(G)X 2207...	
6100-31.75R-22	6	100	31.75	80	50	15	x	B	1.8 -	E302	
8125-38.1R-22	8	125	38.1	80	63	15	x	B	3.0 -		
10160-50.8R-22	10	160	50.8	100	63	15	x	B	4.3 -		
12200-47.625R-22	12	200	47.625	130	63	15	x	C	6.0 -		

▶ Mounting bolt with coolant through hole is available on request (ordering example: SH M10x1.5x30-C)

Spare parts

Designation	Screw	Wrench			
SCRM90TN-18	TS 40B100I	T-T15			
SCRM90TN-22	TS 45I20I	T-T20			



TFM90AX-06/2S-TFM90AP-09



Face mills

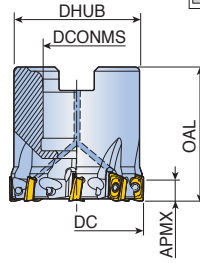
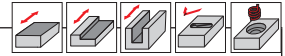
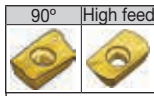

Designation	⚙️	Dimension (mm)						Coolant hole	Arbor style	⚖️ kg	Mounting bolt	Insert
		DC	DCONMS	DHUB	OAL	APMX						
TFM90AX	832-16R-06	8	32	16	30	32	5.5	●	A	0.1	SH M8x25	AXM(C)T 0602...
	1040-16R-06	10	40	16	38	40	5.5	●	A	0.2	SH M8x25	E264-E266
	1040-22R-06	10	40	22	38	40	5.5	●	A	0.2	SH M10x30	
2S-TFM90AP	540-16R-09	5	40	16	38	40	8.8	●	A	0.3	SH M8x30	APK(C)T 09T3...
	640-16R-09	6	40	16	38	40	8.8	●	A	0.2	SH M8x30	E259, E264
	550-22R-09-B	5	50	22	45	40	8.8	●	A	0.3	SH M10x30	
	650-22R-09	6	50	22	45	40	8.8	●	A	0.3	SH M10x30	
	750-22R-09	7	50	22	45	40	8.8	●	A	0.3	SH M10x30	
	863-22R-09	8	63	22	47	40	8.8	●	A	0.5	SH M10x30	
	1080-27R-09	10	80	27	58	50	8.8	●	A	1.1	SH M12x35	

- ▶ Mounting bolt with coolant through hole is available on request (ordering example: SH M10x1.5x30-C)
- ▶ Cutter body for 'AXMT 06' insert with corner radius more than 1.0mm should be modified accordingly body "RE"=Insert "RE"-0.1mm
- ▶ Cutter body for 'APKT09' insert with corner radius more than 2.4mm should be modified accordingly body "RE"=Insert "RE"-0.2mm

Spare parts

Designation	Screw	Wrench			
TFM90AX	TS 18041/HG	TD 6P			
2S-TFM90AP	TS 25075/HG	TD 8			

 E312-E315	 E316-E317	 E318	 E360-E366
---------------	---------------	----------	---------------

TFM90AP-12/17



Face mills

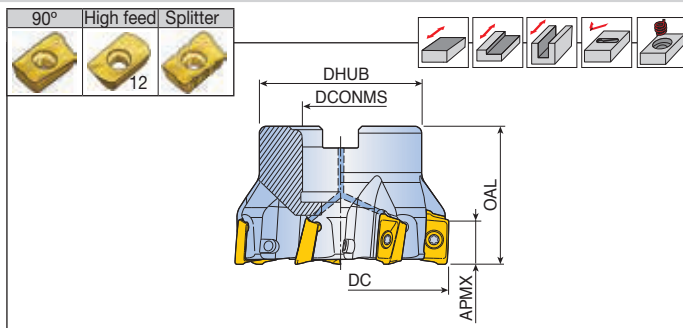

Designation	Z	Dimension (mm)					Coolant hole	Arbor style	Kg	Mounting bolt	Insert
		DC	DCONMS	DHUB	OAL	APMX					
TFM90AP 440-16R-12	4	40	16	38	40	12	●	A	0.2 SH M8x25	APK(C)T 1204... E260, E264	
540-16R-12	5	40	16	38	40	12	●	A	0.2 SH M8x25		
550-22R-12	5	50	22	45	40	12	●	A	0.3 SH M10x30		
650-22R-12	6	50	22	45	40	12	●	A	0.3 SH M10x30		
563-22R-12	5	63	22	47	40	12	●	A	0.5 SH M10x30		
663-22R-12	6	63	22	47	40	12	●	A	0.5 SH M10x30		
763-22R-12	7	63	22	47	40	12	●	A	0.5 SH M10x30		
680-27R-12	6	80	27	58	50	12	●	A	1.0 SH M10x25		
880-27R-12	8	80	27	58	50	12	●	A	1.0 SH M10x25		
TFM90AP 440-16R-17	4	40	16	38	40	16.1	●	A	0.3 SH M8x30		APK(C)T 1705... E261-E262
350-22R-17-B	3	50	22	45	40	16.1	●	A	0.4 SH M10x30		
450-22R-17-B	4	50	22	45	40	16.1	●	A	0.3 SH M10x30		
550-22R-17	5	50	22	45	40	16.1	●	A	0.4 SH M10x30		
463-22R-17-B	4	63	22	47	40	16.1	●	A	0.5 SH M10x30		
663-22R-17	6	63	22	47	50	16.1	●	A	0.5 SH M10x30		
480-27R-17-B	4	80	27	58	50	16.1	●	A	0.8 SH M12x35		
680-27R-17	6	80	27	58	50	16.1	●	A	0.9 SH M12x35		
780-27R-17	7	80	27	58	50	16.1	●	A	0.9 SH M12x35		
6100-32R-17-B	6	100	32	85	50	16.1	●	A	1.3 LH M16x35		
8100-32R-17	8	100	32	85	50	16.1	●	A	1.5 LH M16x35		
7125-40R-17-B	7	125	40	85	63	16.1	●	A	2.9 SH M20x40		
8125-40R-17	8	125	40	85	63	16.1	●	A	3.0 SH M20x40		
9125-40R-17	9	125	40	85	63	16.1	●	A	3.1 SH M20x40		
8160-40R-17-B	8	160	40	110	63	16.1	x	C	4.1 -		
10160-40R-17	10	160	40	110	63	16.1	x	C	4.2 -		
12200-60R-17	12	200	60	130	63	16.1	x	C	6.1 -		

- ▶ Mounting bolt with coolant through hole is available on request (ordering example: SH M10x1.5x30-C)
- ▶ Cutter body for 'APKT 12' insert with corner radius more than 1.6mm should be modified accordingly body "RE"=Insert "RE"-0.5mm
- ▶ Cutter body for 'APKT 17' insert with corner radius more than 1.6mm should be modified accordingly body "RE"=Insert "RE"-0.8mm

Cutting Condition E312-E315	Arbor Style E316-E317	Torque E318	Ramping Data E360-E366
--------------------------------	--------------------------	----------------	---------------------------

2S-TFM90AP-19



Face mills

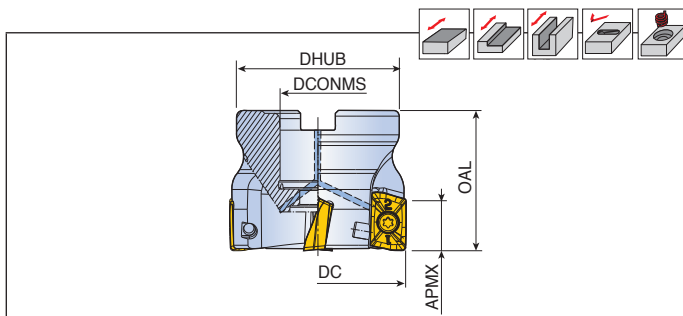

Designation		Dimension (mm)					Coolant hole	Arbor style	Kg	Mounting bolt	Insert
		DC	DCONMS	SDHUB	OAL	APMX					
2S-TFM90AP350-22R-19	3	50	22	45	45	17.9	●	A	0.3	LH M10x35	APKT 1907... E263
463-22R-19	4	63	22	47	40	17.9	●	A	0.7	SH M10x30	
463-27R-19	4	63	27	58	50	17.9	●	A	0.7	SH M12x35	
680-27R-19	6	80	27	58	50	17.9	●	A	1.1	SH M12x35	
7100-32R-19	7	100	32	85	50	17.9	●	A	1.9	SH M16x35	
6125-40R-19	6	125	40	85	63	17.9	●	A	3.0	SH M20x40	
8125-40R-19	8	125	40	85	63	17.9	●	A	3.0	SH M20x40	
10160-40R-19	10	160	40	110	63	17.9	x	C	4.2	-	
12200-60R-19	12	200	60	130	63	17.9	x	C	6.0	-	

► Mounting bolt with coolant through hole is available on request (ordering example: SH M10x1.5x30-C)

Spare parts

Designation	Screw	Wrench			
2S-TFM90AP-19	TS 50115I	T-T20			

E312-E315	E316-E317	E318	E360-E366
-----------	-----------	------	-----------

Face mills

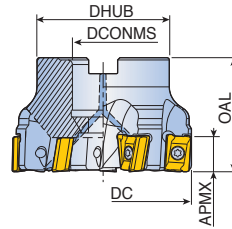
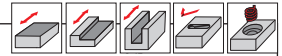

Designation		Dimension (mm)					Coolant hole	Arbor style	Kg	Mounting bolt	Insert	
		DC	DCONMS	DHUB	OAL	APMX						
TFM90AN 440-16R-11	4	40	16	38	40	11	●	A	0.2	SH M8x30	ANM(H)X 1106... E258	
450-22R-11	4	50	22	45	40	11	●	A	0.3	SH M10x30		
650-22R-11	6	50	22	45	40	11	●	A	0.3	SH M10x30		
563-22R-11	5	63	22	47	40	11	●	A	0.6	SH M10x30		
763-22R-11	7	63	22	47	40	11	●	A	0.6	SH M10x30		
880-27R-11	8	80	27	58	50	11	●	A	1.1	SH M12x35		
1080-27R-11	10	80	27	58	50	11	●	A	1.1	SH M12x35		
9100-32R-11	9	100	32	85	50	11	●	A	2.0	SH M16x35		
12100-32R-11	12	100	32	85	50	11	●	A	2.0	SH M16x35		
10125-40R-11	10	125	40	85	63	11	●	A	3.3	SH M20x40		
14125-40R-11	14	125	40	85	63	11	●	A	3.4	SH M20x40		
TFM90AN 350-22R-16	3	50	22	45	40	15	●	A	0.4	SH M10x30		ANM(H)X 1607... E258
450-22R-16	4	50	22	45	40	15	●	A	0.4	SH M10x30		
463-22R-16	4	63	22	47	40	15	●	A	0.5	SH M10x30		
663-22R-16	6	63	22	47	40	15	●	A	0.5	SH M10x30		
580-27R-16	5	80	27	58	50	15	●	A	0.8	SH M12x35		
680-27R-16	6	80	27	58	50	15	●	A	1.2	SH M12x35		
780-27R-16	7	80	27	58	50	15	●	A	0.9	SH M12x35		
5100-32R-16	5	100	32	85	50	15	●	A	1.3	SH M16x35		
8100-32R-16	8	100	32	85	50	15	●	A	1.5	SH M16x35		
7125-40R-16	7	125	40	85	63	15	●	A	3.9	SH M20x40		
10125-40R-16	10	125	40	85	63	15	●	A	3.7	SH M20x40		
8160-40R-16	8	160	40	110	63	15	x	C	5.0	-		
12160-40R-16	12	160	40	110	63	15	x	C	5.3	-		
14200-60R-16	14	200	60	130	63	15	x	C	7.0	-		

▶ Mounting bolt with coolant through hole is available on request (ordering example: SH M10x1.5x30-C)

Spare parts

Designation	Screw	Wrench			
TFM90AN-11	TS 35A088I/HG	TD 10P	-		
TFM90AN-16	TS 40120I	-	T-T15		



Face mills

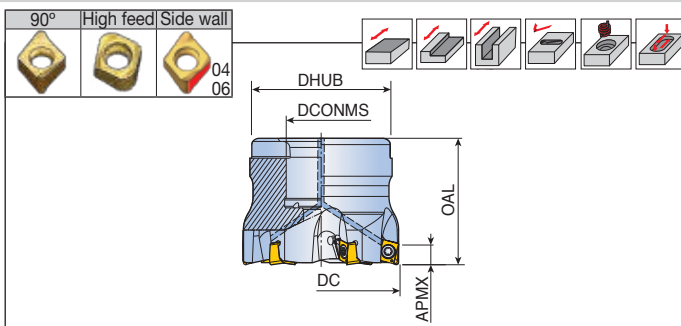

Designation		Dimension (mm)					Coolant hole	Arbor style		Mounting bolt	Insert
		DC	DCONMS	DHUB	OAL	APMX					
4N TF90- 832-16R-04	8	32	16	30	32	3.5	●	A	0.1	SH M8x25	4NK(H)T 0402... E252-E253
1040-16R-04	10	40	16	38	40	3.5	●	A	0.2	SH M8x25	
4N TF90- 432-16R-06	4	32	16	30	32	6.0	●	A	0.1	SH M8x25	4NK(H)T 0603... E252-E253
532-16R-06	5	32	16	30	32	6.0	●	A	0.1	SH M8x25	
540-16R-06	5	40	16	38	40	6.0	●	A	0.3	SH M8x25	
640-16R-06	6	40	16	38	40	6.0	●	A	0.3	SH M8x25	
650-22R-06	6	50	22	45	40	6.0	●	A	0.4	SH M10x30	
750-22R-06	7	50	22	47	40	6.0	●	A	0.4	SH M10x30	
752-22R-06	7	52	22	47	40	6.0	●	A	0.4	SH M10x30	
763-22R-06	7	63	22	47	40	6.0	●	A	0.6	SH M10x30	
863-22R-06	8	63	22	47	40	6.0	●	A	0.6	SH M10x30	
866-27R-06	8	66	27	58	50	6.0	●	A	0.8	SH M10x30	
4N TF90- 540-16R-09	5	40	16	38	40	8.0	●	A	0.3	SH M8x25	4NK(H)T 0904... E252-E253
650-22R-09	6	50	22	45	40	8.0	●	A	0.3	LH M10x25	
563-22R-09	5	63	22	47	40	8.0	●	A	0.5	LH M10x25	
763-22R-09	7	63	22	47	40	8.0	●	A	0.5	LH M10x25	
780-27R-09	7	80	27	58	50	8.0	●	A	1.0	SH M12x35	
980-27R-09	9	80	27	58	50	8.0	●	A	1.1	SH M12x35	

- ▶ Cutter body for '4NKT 040212R-HF' insert should be modified with body corner radius 1.2 mm
- ▶ Cutter body for '4NKT 060320R-HF' and '4NHT 060320R-F' inserts should be modified with body corner radius 2.0 mm
- ▶ Cutter body for '4NKT 090432R-HF' insert should be modified with body corner radius 3.2 mm
- ▶ Mounting bolt with coolant through hole is available on request (ordering example: SH M10x1.5x30-C)

Spare parts

Designation	Screw	Wrench		Wrench handle
4N TF90-04	TS 180411/HG	TD 6P	-	-
4N TF90-06	TS 30B0681/HG	TD 8	-	-
4N TF90-09	TS 35A0881/HG	-	TBLD T10P-W6	THND 6W



4N TF90-11/14



Face mills

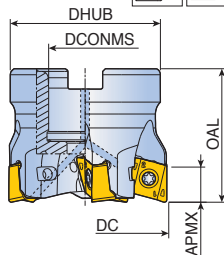
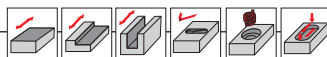
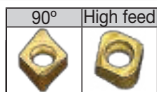

Designation		Dimension (mm)					Coolant hole	Arbor style	Kg	Mounting bolt	Insert
		DC	DCONMS	DHUB	OAL	APMX					
4N TF90- 440-16R-11	4	40	16	38	40	10.5	●	A	0.2	SH M8x30	4NKT 1106...
450-22R-11	4	50	22	45	40	10.5	●	A	0.3	LH M10x25	E252-E253
550-22R-11	5	50	22	45	40	10.5	●	A	0.3	LH M10x25	
463-22R-11	4	63	22	47	40	10.5	●	A	0.6	LH M10x25	
663-22R-11	6	63	22	47	40	10.5	●	A	0.5	LH M10x25	
480-27R-11	4	80	27	58	50	10.5	●	A	1.1	SH M12x35	
480-25.4R-11	4	80	25.4	70	50	10.5	●	A	1.3	SH M12x35	
680-27R-11	6	80	27	58	50	10.5	●	A	1.0	SH M12x35	
880-27R-11	8	80	27	58	50	10.5	●	A	1.0	SH M12x35	
9100-32R-11	9	100	32	85	50	10.5	●	A	1.9	SH M16x35	
4N TF90- 450-22R-14	4	50	22	45	45	13.8	●	A	0.4	SH M10x25	4NKT 1407...
463-22R-14	4	63	22	47	45	13.8	●	A	0.6	SH M10x25	E252-E253
663-22R-14	6	63	22	47	45	13.8	●	A	0.6	SH M10x25	
580-27R-14	5	80	27	58	50	13.8	●	A	1.0	SH M12x35	
580-25.4R-14	5	80	25.4	70	50	13.8	●	A	1.2	SH M12x35	
780-27R-14	7	80	27	58	50	13.8	●	A	1.0	SH M12x35	
8100-32R-14	8	100	32	85	50	13.8	●	A	1.9	SH M16x35	
8100-31.75R-14	8	100	31.75	80	50	13.8	●	B	1.7	-	

- ▶ Cutter body for '4NKT 110640R-HF' insert should be modified with body corner radius 4.0 mm
- ▶ Cutter body for '4NKT 140750R-HF' insert should be modified with body corner radius 5.0 mm
- ▶ Mounting bolt with coolant through hole is available on request (ordering example: SH M10x1.5x30-C)

Spare parts

Designation	Screw	Wrench	Wrench handle		
4N TF90-11	TS 400931/HG	TBLD T15-W6	SW6-T		
4N TF90-14	TS 50A1211/HG	TBLD T20-W6	SW6-T		

 E312-E315	 E316-E317	 E318	 E338-E359
---------------	---------------	----------	---------------

8D-TF90-10

Face mills

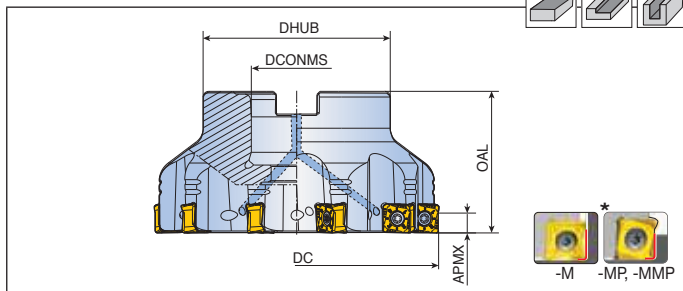

Designation		Dimension (mm)					Coolant hole	Arbor type	Kg	Mounting bolt	Insert
		DC	DCONMS	DHUB	OAL	APMX					
8D-TF90-440-16R-10	4	40	16	38	40	7.0**	●	A	0.2	SH M8x25	SQK(H)U 1004... E297
550-22R-10	5	50	22	45	40	7.0**	●	A	0.3	SH M10x30	
663-22R-10	6	63	22	47	40	7.0**	●	A	0.5	SH M10x30	
863-22R-10	8	63	22	47	40	7.0**	●	A	0.5	SH M10x30	
880-27R-10	8	80	27	58	50	7.0**	●	A	1.1	SH M12x35	
1080-27R-10	10	80	27	58	50	7.0**	●	A	1.1	SH M12x35	
10100-32R-10	10	100	32	66	50	7.0**	●	A	1.6	SH M16x35	
14100-32R-10	14	100	32	66	50	7.0**	●	A	1.7	SH M16x35	
12125-40R-10	12	125	40	85	63	7.0**	●	A	3.4	SH M20x40	
16125-40R-10	16	125	40	85	63	7.0**	●	A	3.5	SH M20x40	

- ▶ Mounting bolt with coolant through hole is available on request (ordering example: SH M10x1.5x30-C)
- ▶ *:Multi-Step milling is not recommended over the APMX ▶ **:When applying SQHU insert, APMX is 6.5 mm.

Spare parts

Designation	Screw	Wrench			
	8D-TF90-10	TS 35A0881/HG	TD 10P		

E312-E315	E316-E317	E318
-----------	-----------	------

8D-TF90-12



Face mills

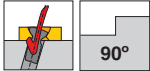
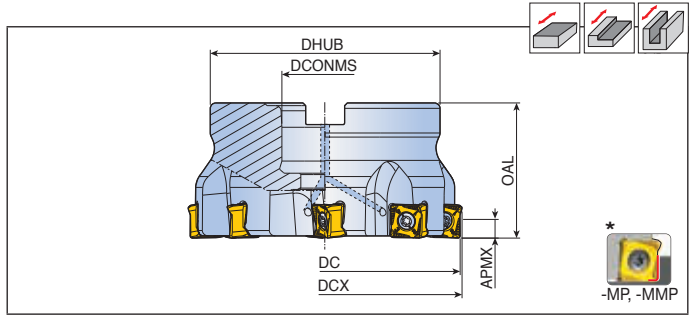
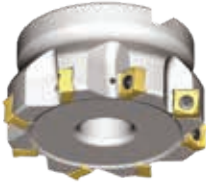

Designation	Z	Dimension (mm)						Coolant hole	Arbor style	Kg	Mounting bolt	Insert
		DC	DCX	DCONMS	DHUB	OAL	APMX					
8D-TF90-340-16R-12	3	40	41.3	16	38	40	8.5**	●	E	0.3	KTB 32B	SQK(H)U 1206... E297
440-16R-12	4	40	41.3	16	38	40	8.5**	●	E	0.3	KTB 32B	
450-22R-12	4	50	51.3	22	45	40	8.5**	●	A	0.3	SH M10x30	
650-22R-12	6	50	51.3	22	45	40	8.5**	●	A	0.4	SH M10x30	
563-22R-12	5	63	64.3	22	47	40	8.5**	●	A	0.5	SH M10x30	
863-22R-12	8	63	64.3	22	47	40	8.5**	●	A	0.6	SH M10x30	
680-27R-12	6	80	81.3	27	58	50	8.5**	●	A	1.1	SH M12x35	
680-25.4R-12	6	80	81.3	25.4	70	50	8.5**	●	A	1.3	SH M12x35	
980-27R-12	9	80	81.3	27	58	50	8.5**	●	A	1.2	SH M12x35	
1180-27R-12	11	80	81.3	27	58	50	8.5**	●	A	1.2	SH M12x35	
8100-32R-12	8	100	101.3	32	66	50	8.5**	●	A	1.6	SH M16x35	
8100-31.75R-12	8	100	101.3	31.75	80	50	8.5**	x	B	1.8	-	
11100-32R-12	11	100	101.3	32	66	50	8.5**	●	A	1.7	SH M16x35	
14100-32R-12	14	100	101.3	32	66	50	8.5**	●	A	1.7	SH M16x35	
10125-40R-12	10	125	126.3	40	85	63	8.5**	●	A	3.4	SH M20x40	
10125-38.1R-12	10	125	126.3	38.1	80	63	8.5**	x	B	3.0	-	
18125-40R-12	18	125	126.3	40	85	63	8.5**	●	A	3.5	SH M20x40	
12160-40R-12	12	160	161.3	40	110	63	8.5**	x	C	4.7	-	
12160-50.8R-12	12	160	161.3	50.8	100	63	8.5**	x	B	4.9	-	
22160-40R-12	22	160	161.3	40	110	63	8.5**	x	C	4.9	-	

- ▶ DC: Cutting diameter ▶ DCX: Cutting diameter maximum
- ▶ Mounting bolt with coolant through hole is available on request (ordering example: SH M10x1.5x30-C)
- ▶ *:Multi-Step milling is not recommended over the APMX ▶ **:When applying SQHU insert, APMX is 8.0mm.

Spare parts

Designation	Screw	Wrench	Wrench handle		
8D-TF90-12	TS 40M100/HG	TBLD T15-W6	SW6-T		



TFM90XEV-16/22



Face mills

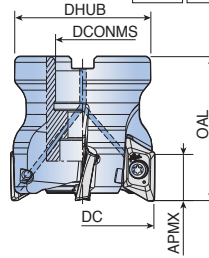
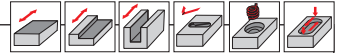

Designation		Dimension (mm)					Coolant hole	Arbor style	Max RPM	Kg	Mounting bolt	Insert
		DC	DCONMS	DHUB	OAL	APMX						
TFM90XEV 340-16R-16	3	40	16	38	50	16	●	A	41,200	0.2	SH M8x35-C	XEVT 1605... E305
350-22R-16	3	50	22	47	50	16	●	A	41,200	0.3	SH M8x35-C	
363-22R-16	3	63	22	47	50	16	●	A	41,200	0.5	SH M8x35-C	
450-22R-16	4	50	22	45	50	16	●	A	36,800	0.3	SH M10x30-C	
563-22R-16	5	63	22	47	50	16	●	A	32,700	0.5	SH M10x30-C	
480-27R-16	4	80	27	58	50	16	●	A	29,000	0.9	LH M12x30-C	
580-27R-16	5	80	27	58	50	16	●	A	29,000	0.9	LH M12x30-C	
680-27R-16	6	80	27	58	50	16	●	A	29,000	0.8	LH M12x30-C	
6100-32R-16	6	100	32	66	63	16	●	A	26,000	1.6	SH M16x35-C	
7125-40R-16	7	125	40	85	63	16	●	A	23,200	2.5	SH M20x40-C	
8160-40R-16	8	160	40	110	63	16	x	C	20,000	3.8	-	
TFM90XEV 350-22R-22	3	50	22	45	55	21	●	A	31,400	0.4	SH M10x30-C	XEVT 2206... E305
463-22R-22	4	63	22	47	55	21	●	A	28,000	0.6	SH M10x30-C	
580-27R-22	5	80	27	58	55	21	●	A	24,800	1.0	LH M12x30-C	
6100-32R-22	6	100	32	85	63	21	●	A	22,200	2.1	SH M16x35-C	
7125-40R-22	7	125	40	85	63	21	●	A	19,900	2.8	SH M20x40-C	

► Cutter body for inserts with corner radii more than 3.2mm (XEVT 16) and 3.0mm (XEVT 22) should be modified as follows: body "RE"=insert "RE"-0.3mm

Spare parts

Designation	Screw	Wrench			
TFM90XEV-16	TS 400931/HG	T-T15			
TFM90XEV-22	TS 501151	T-T20			



E312-E315

E316-E317

E318

E368-E372

4W-TF90-12



Face mills for finishing

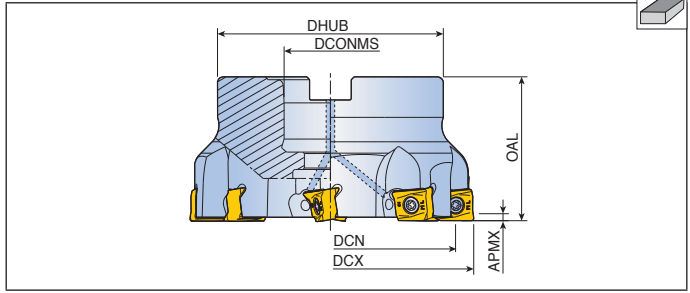

Designation		Dimension (mm)						Coolant hole	Arbor style	kg	Mounting bolt	Insert
		DCX	DCN	DCONMS	DHUB	OAL	APMX					
4W-TF90-550-22R-12	5	50	38.9	22	45	40	0.5	●	A	0.4	SH M10x30-C	4WHU 1207... E254
663-22R-12	6	63	50.9	22	47	40	0.5	●	A	0.5	SH M10x30-C	
880-27R-12	8	80	66.9	27	58	50	0.5	●	A	1.1	SH M12x35-C	
8100-32R-12	8	100	86.9	32	66	50	0.5	●	A	1.6	SH M16x35-C	
10125-40R-12	10	125	110.9	40	85	63	0.5	●	A	3.1	SH M20x40-C	
10160-40R-12	10	160	145.9	40	110	63	0.5	x	C	4.1	-	

- ▶ DCN: Cutting diameter minimum
- ▶ DCX: Cutting diameter maximum

Spare parts

Designation	Screw	Wrench	Wrench handle		
4W-TF90-12	TS 40A115I	TBLD T15-W6	SW6-T		

Cutting Condition E312-E315	Arbor Style E316-E317	Torque E318
--------------------------------	--------------------------	----------------

TFM90SNS-12

Face mills for finishing

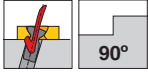
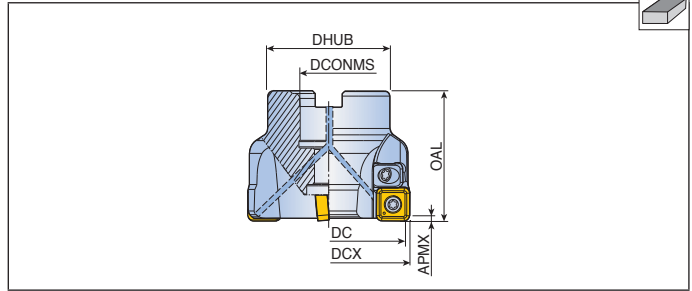

Designation	Z	Dimension (mm)						Coolant hole	Arbor style	Kg	Mounting bolt	Insert
		DCX	DC	DCONMS	DHUB	OAL	APMX					
TFM90SNS 350-22R-12	3	50	43.35	22	45	50	1.0	●	A	0.5	SH M10x40	SNEX 1204... SNET 1205... E291
463-22R-12	4	63	56.35	22	47	50	1.0	●	A	0.7	SH M10x40	
680-27R-12	6	80	73.35	27	58	50	1.0	●	A	1.0	SH M12x35	
8100-32R-12	8	100	93.35	32	66	63	1.0	●	A	2.0	SH M16x30	
12100-32R-12	12	100	93.35	32	66	63	1.0	●	A	2.0	SH M16x30	
10125-40R-12	10	125	118.35	40	85	63	1.0	x	B	2.9	-	
16125-40R-12	16	125	118.35	40	85	63	1.0	x	B	2.9	-	
12160-40R-12	12	160	153.35	40	110	63	1.0	x	C	4.4	-	
20160-40R-12	20	160	153.35	40	110	63	1.0	x	C	4.4	-	
16200-60R-12	16	200	193.35	60	130	63	1.0	x	C	6.0	-	
24200-60R-12	24	200	193.35	60	130	63	1.0	x	C	6.0	-	
30250-60R-12	30	250	243.35	60	160	63	1.0	x	C	10.8	-	

- Recommend to very stable machining condition at cast iron & steel
- Mounting bolt with coolant through hole is available on request (ordering example: SH M10x1.5x30-C)

Spare parts

Designation	Screw	Adj. wedge	Adj. screw	Wrench	
TFM90SNS-12	TS 35C110I	AJS 1010R	AWS 0620	T-T15	



LM90SE-21



Face mills

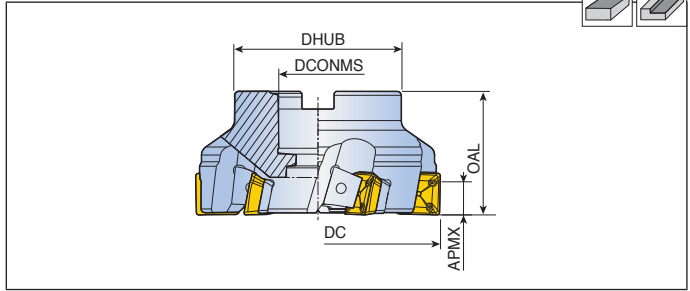

Designation		Dimension (mm)					Arbor style		Mounting bolt	Insert
		DC	DCONMS	DHUB	OAL	APMX				
LM90SE6125-40R-21	6	125	40	85	63	17.0	A	3.4	SH M20x40	SEKX 2107... E289
8160-40R-21	8	160	40	110	63	17.0	C	5.3	-	
10200-60R-21	10	200	60	130	80	17.0	C	9.6	-	
12200-60R-21	12	200	60	130	80	17.0	C	9.5	-	
12250-60R-21	12	250	60	160	80	17.0	C	16.4	-	
14250-60R-21	14	250	60	160	80	17.0	C	16.4	-	
12315-60R-21	12	315	60	220	80	17.0	D	21.0	-	
LM90SE6125-38.1R-21	6	125	38.1	85	63	17.0	B	3.4	-	
8160-50.8R-21	8	160	50.8	110	63	17.0	B	5.3	-	
10200-47.625R-21	10	200	47.625	130	80	17.0	C	9.6	-	

Spare parts

Designation	Shim	Shim screw	Wedge	Wedge screw	Wedge screw wrench	Shim screw wrench
LM90SE-21 (-Ø200)	TSSE 21N-ST	TS 50C130I/HG	WPA 8-SE16	TS 80160W	T-W 4	T-T20
LM90SE-21 (Ø250-)	TSSE 21N-ST	TS 50C130I/HG	WPA 8-SE16	TS 80200W	T-W 4	T-T20

► The shim screw wrench⁽¹⁾ shall be ordered separately

 E312-E315	 E316-E317	 E318
---------------	---------------	----------

TFM90SN/TFM88SN-13



Face mills

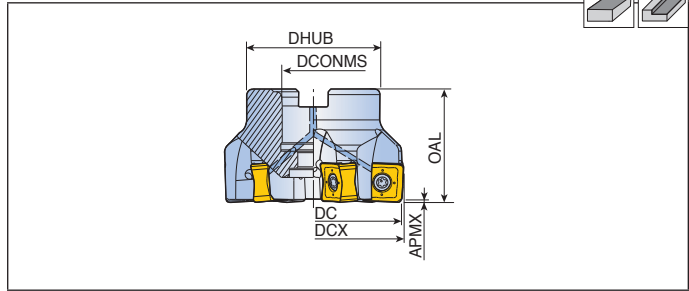
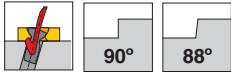

Designation		Dimension (mm)						Coolant hole	Arbor style	Kg	Mounting bolt	Insert
		DC	DCX	DCONMS	DHUB	OAL	APMX					
TFM90SN 550-22R-13	5	50	50.7	22	45	40	12.0	●	A	0.3	SH M10x30	SNGX 1306 ... E293
663-22R-13	6	63	63.7	22	47	40	12.0	●	A	0.5	SH M10x30	
780-27R-13	7	80	80.7	27	70	50	12.0	●	A	1.2	SH M12x35	
980-27R-13*	9	80	80.7	27	70	50	12.0	●	A	1.2	SH M12x35	
8100-32R-13	8	100	100.8	32	85	50	12.0	●	A	1.9	SH M16x30	
13100-32R-13*	13	100	100.8	32	85	50	12.0	●	A	1.9	SH M16x30	
10125-40R-13	10	125	125.8	40	85	63	12.0	x	B	2.8	-	
16125-40R-13*	16	125	125.8	40	85	63	12.0	x	B	2.8	-	
TFM88SN 550-22R-13	5	50	51.2	22	45	40	12.0	●	A	0.3	SH M10x30	SNGX 1306 ZN... E293
663-22R-13	6	63	64.2	22	47	40	12.0	●	A	0.5	SH M10x30	
780-27R-13	7	80	81.2	27	70	50	12.0	●	A	1.2	SH M12x35	
980-27R-13*	9	80	81.2	27	70	50	12.0	●	A	1.2	SH M12x35	
8100-32R-13	8	100	101.2	32	85	50	12.0	●	A	1.9	SH M16x30	
11100-32R-13*	11	100	101.2	32	85	50	12.0	●	A	1.9	SH M16x30	
10125-40R-13	10	125	126.1	40	85	63	12.0	x	B	2.8	-	
14125-40R-13*	14	125	126.1	40	85	63	12.0	x	B	2.8	-	
12160-40R-13	12	160	161.1	40	110	63	12.0	x	C	4.2	-	
18160-40R-13*	18	160	161.1	40	110	63	12.0	x	C	4.2	-	
14200-60R-13	14	200	201.1	60	130	63	12.0	x	C	6.0	-	
22200-60R-13*	22	200	201.1	60	130	63	12.0	x	C	6.0	-	

- ▶ *: Fine pitch cutter for cast iron
- ▶ Mounting bolt with coolant through hole is available on request (ordering example: SH M10x1.5x30-C)

Spare parts

Designation	Screw	Wrench			
TFM90SN	TS 40B100I	T-T15			
TFM88SN	TS 40B100I	T-T15			



TFM75SN-13



Face mills

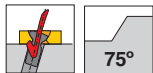
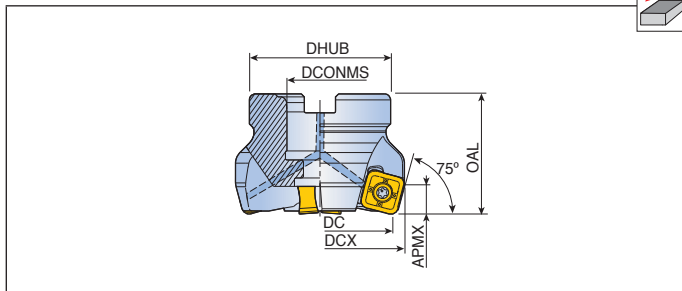

Designation		Dimension (mm)							Coolant hole	Arbor style	Kg	Mounting bolt	Insert
		DC	DCX	DCONMS	DHUB	OAL	APMX						
TFM75SN 450-22R-13	4	50	55.4	22	45	40	9.5	●	A	0.4	LH M10x25	SNM(G)X 1306 EN... SNMX 1306 XTN... E292	
650-22R-13	6	50	55.4	22	45	40	9.5	●	A	0.4	LH M10x25		
663-22R-13	6	63	68.4	22	47	40	9.5	●	A	0.6	LH M10x25		
863-22R-13	8	63	68.4	22	47	40	9.5	●	A	0.6	LH M10x25		
780-27R-13	7	80	85.4	27	70	50	9.5	●	A	1.3	LH M12x30		
1080-27R-13	10	80	85.4	27	70	50	9.5	●	A	1.3	LH M12x30		
8100-32R-13	8	100	105.4	32	85	50	9.5	●	A	1.9	LH M16x35		
12100-32R-13	12	100	105.4	32	85	50	9.5	●	A	2.0	LH M16x35		
10125-40R-13	10	125	130.3	40	85	63	9.5	●	A	3.2	SH M20x40		
16125-40R-13	16	125	130.4	40	85	63	9.5	●	A	3.2	SH M20x40		
12160-40R-13	12	160	165.3	40	110	63	9.5	x	C	4.7	-		
20160-40R-13	20	160	165.4	40	110	63	9.5	x	C	4.8	-		
16200-60R-13	16	200	205.3	60	130	63	9.5	x	C	6.4	-		
22200-60R-13	22	200	205.4	60	130	63	9.5	x	C	6.4	-		
20250-60R-13	20	250	255.3	60	160	63	9.5	x	C	11.7	-		
TFM75SN 580-25.4R-13B	5	80	85.4	25.4	70	50	9.5	●	A	1.3	LH M12x30		
1080-25.4R-13	10	80	85.4	25.4	70	50	9.5	●	A	1.5	LH M12x30		
6100-31.75R-13B	6	100	105.4	31.75	80	50	9.5	x	B	1.9	-		
8125-38.1R-13B	8	125	130.3	38.1	80	63	9.5	x	B	3.2	-		
12160-50.8R-13B	12	160	165.3	50.8	100	63	9.5	x	B	4.7	-		

► Mounting bolt with coolant through hole is available on request (ordering example: SH M10x1.5x30-C)

Spare parts

Designation	Screw	Wrench			
	TFM75SN	TS 40B100I	T-T15		



E312-E315

E316-E317

E318

LM75SP-12/15



Face mills

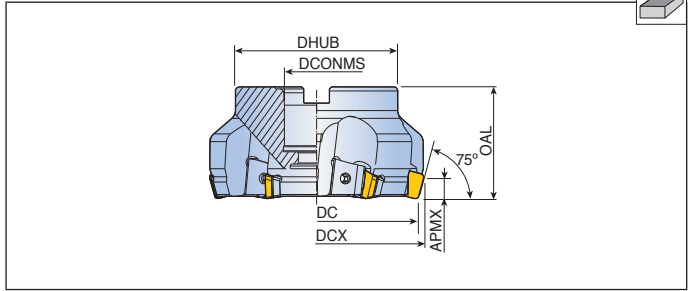

Designation		Dimension (mm)						Arbor style	Kg	Mounting bolt	Insert
		DC	DCX	DCONMS	DHUB	OAL	APMX				
LM75SP580-25.4 R-12	5	80	85.4	25.4	70	50	9.5	A	1.5	SH M12x35	SPKN 1203...
6100-31.75R-12	6	100	105.4	31.75	80	55	9.5	A	2.4	LH M16x35	E296
8125-38.1R-12	8	125	130.4	38.1	80	63	9.5	B	3.2	-	
10160-50.8R-12	10	160	165.4	50.8	100	63	9.5	B	5.0	-	
12200-47.625R-12	12	200	205.4	47.625	130	63	9.5	C	7.4	-	
16250-47.625R-12	16	250	255.4	47.625	160	63	9.5	C	10.8	-	
LM75SP580-25.4R-15	5	80	86.97	25.4	70	55	12.5	A	1.5	SH M12x35	SPKN 1504...
5100-31.75R-15	5	100	106.96	31.75	80	55	12.5	A	2.4	LH M16x35	E296
8125-38.1R-15	8	125	131.95	38.1	80	63	12.5	B	3.1	-	
10160-50.8R-15	10	160	166.94	50.8	100	63	12.5	B	5.0	-	
12200-47.625R-15	12	200	206.94	47.625	130	63	12.5	C	6.9	-	
16250-47.625R-15	16	250	256.93	47.625	160	63	12.5	C	10.8	-	
20315-47.625R-15	20	315	321.93	47.625	220	63	12.5	D	17.4	-	

▶ Metric bore cutter is available upon request

Spare parts

Designation	Carbide shim	Wedge	Shim screw	Wedge screw	Wrench	
						(1)
LM75SP-12 (Ø80)	TSSP 12N	WPA 8	TS 40B100I	TS 80160W	T-W 4	T-T15
LM75SP-12 (Ø100-)	TSSP 12N	WPA 8	TS 40B100I	TS 80200W	T-W 4	T-T15
LM75SP-15	TSSP 15N	WPA 8	TS 40B100I	TS 80200W	T-W 4	T-T15

▶ The shim screw wrench T-T15⁽¹⁾ shall be ordered separately

 E312-E315	 E316-E317	 E318
---------------	---------------	----------

TFM75AP-17



Face mills

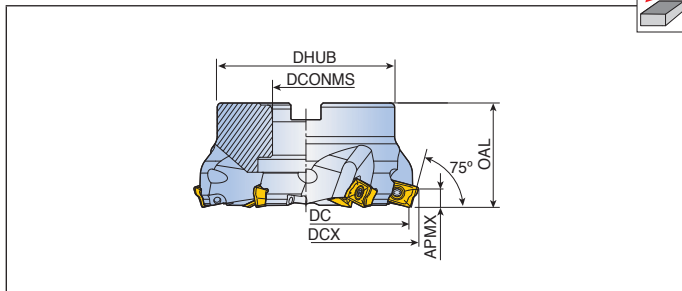

Designation		Dimension (mm)						Arbor style	Kg	Mounting bolt	Insert
		DC	DCX	DCONMS	DHUB	OAL	APMX				
TFM75AP 580-27R-17	5	80	87.82	27	58	50	3.9	A	0.8	SH M12x35	APKT 1705
6100-32R-17	6	100	107.82	32	85	50	3.9	B	1.3	-	PER-M
7125-40R-17	7	125	132.82	40	85	63	3.9	B	3.5	-	APKT 1705
TFM75AP 580-25.4R-17	5	80	87.82	25.4	70	50	3.9	A	0.8	SH M12x35	PER-EM
6100-31.75R-17	6	100	107.82	31.75	80	50	3.9	B	1.3	-	E262
7125-38.1R-17	7	125	132.82	38.1	80	63	3.9	B	3.5	-	

► Cutter for the other corner of APKT inserts

Spare parts

Designation	Screw	Wrench			
	TFM75AP-17	TS 40120I/HG	T-T15		

E312-E315	E316-E317	E318
-----------	-----------	------

Face mills

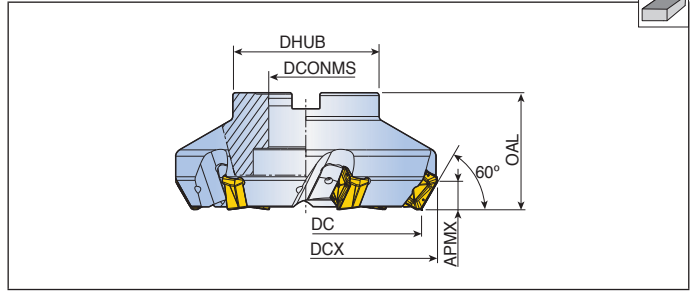

Designation		Dimension (mm)							Arbor style	Kg	Insert
		DC	DCX	DCONMS	DHUB	OAL	APMX				
LM60SC 5125-40R-21	5	125	141.2	40	85	63	13.0	B	4.1	SCKN 2107... E288	
8160-40R-21	8	160	176.1	40	110	63	13.0	C	6.5		
10160-40R-21	10	160	176.1	40	110	63	13.0	C	6.4		
10200-60R-21	10	200	216.1	60	130	80	13.0	C	11.8		
12200-60R-21	12	200	216.1	60	130	80	13.0	C	11.8		
12250-60R-21	12	250	266	60	160	80	13.0	C	19.2		
14250-60R-21	14	250	266	60	160	80	13.0	C	19.1		
16250-60R-21	16	250	266	60	160	80	13.0	C	19.1		
12315-60R-21	12	315	331	60	220	80	13.0	D	25.0		
16315-60R-21	16	315	331	60	220	80	13.0	D	25.0		
LM60SC 5125-38.1R-21	5	125	141.2	38.1	80	63	13.0	B	4.1		
10160-50.8R-21	10	160	176.1	50.8	100	63	13.0	B	6.4		
10200-47.625R-21	10	200	216.1	47.625	130	80	13.0	C	11.8		
12250-47.625R-21	12	250	266	47.625	160	80	13.0	C	19.2		
16250-47.625R-21	16	250	266	47.625	160	80	13.0	C	19.1		

Spare parts

Designation	Shim	Shim screw	Wedge	Wedge screw	Wrench	
LM60SC-21	TSSC 21R-ST	TS 50C130I/HG	WSC 8R-21	TS 80200W	T-W 4	T-T20



► The shim screw wrench⁽¹⁾ shall be ordered separately

Face mills

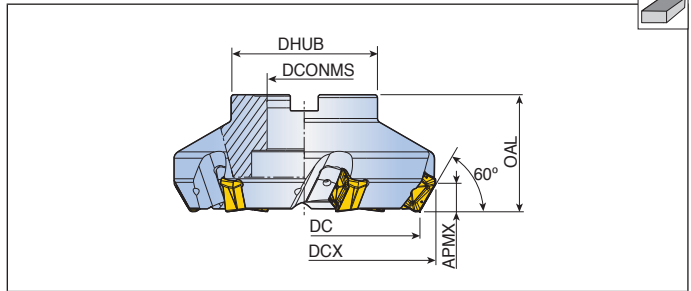

Designation		Dimension (mm)							Arbor style	Kg	Insert
		DC	DCX	DCONMS	DHUB	OAL	APMX				
LM60SC 5125-40R-27	5	125	146	40	85	63	18.0	B	4.6	SCKN 2708... E288	
6160-40R-27	6	160	181	40	110	80	18.0	C	8.7		
8160-40R-27	8	160	181	40	110	80	18.0	C	8.4		
8200-60R-27	8	200	220.9	60	130	80	18.0	C	12.4		
10200-60R-27	10	200	220.9	60	130	80	18.0	C	12.3		
10250-60R-27	10	250	270.8	60	160	80	18.0	C	19.9		
12250-60R-27	12	250	270.8	60	160	80	18.0	C	19.8		
12315-60R-27	12	315	335.8	60	220	80	18.0	D	26.0		
15315-60R-27	15	315	335.8	60	220	80	18.0	D	25.9		
LM60SC 12250-47.625R-27	12	250	270.8	47.625	160	80	18.0	C	19.8		
12315-47.625R-27	12	315	335.8	47.625	220	80	18.0	D	26.0		

Spare parts

Designation	Shim	Shim screw	Wedge	Wedge screw	Wrench		Wrench handle
LM60SC-27	TSSC 27R-TS	TS 60A130I	WSC 8R	TS 80200W	T-W 4	BLD T25	SW6-T



► The wrench⁽¹⁾ & wrench handle⁽²⁾ shall be ordered separately

8D-TF45-11

Face mills

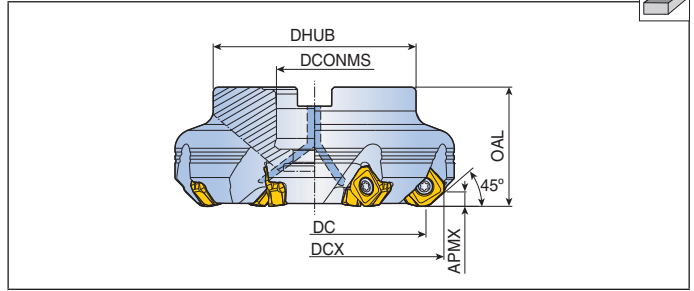

Designation		Dimension (mm)						Coolant hole	Arbor type	Kg	Mounting bolt	Insert
		DC	DCX	DCONMS	DHUB	OAL	APMX					
8D-TF45-440-16R-11	4	40	51	16	38	40	4.2	●	A	0.4	SH M8x25	SQKU
640-16R-11	6	40	51	16	38	40	4.2	●	A	0.4	SH M8x25	1105
650-22R-11	6	50	61	22	45	40	4.2	●	A	0.5	LH M10x25	E298
850-22R-11	8	50	61	22	45	40	4.2	●	A	0.5	LH M10x25	
763-22R-11	7	63	74	22	47	50	4.2	●	A	1.0	SH M10x30	
1063-22R-11	10	63	74	22	47	50	4.2	●	A	1.0	SH M10x30	
880-27R-11	8	80	91	27	70	50	4.2	●	A	1.6	LH M12x30	
1280-27R-11	12	80	91	27	70	50	4.2	●	A	1.6	LH M12x30	
9100-32R-11	9	100	111	32	85	50	4.2	●	A	2.4	LH M16x35	
14100-32R-11	14	100	111	32	85	50	4.2	●	A	2.5	LH M16x35	
8125-40R-11	8	125	136	40	85	63	4.2	●	A	4.1	SH M20x40	
12125-40R-11	12	125	136	40	85	63	4.2	●	A	4.0	SH M20x40	
18125-40R-11	18	125	136	40	85	63	4.2	●	A	4.1	SH M20x40	
10160-40R-11	10	160	171	40	110	63	4.2	x	C	5.7	-	
16160-40R-11	16	160	171	40	110	63	4.2	x	C	5.6	-	
24160-40R-11	24	160	171	40	110	63	4.2	x	C	5.6	-	

► Mounting bolt with coolant through hole is available on request (ordering example: SH M10x1.5x30-C)

Spare parts

Designation	Screw	Wrench	Wrench handle		
	8D-TF45-11	TS 40A1151	TBLD T15-W6	SW6-T	



8D-TF45-14

Face mills

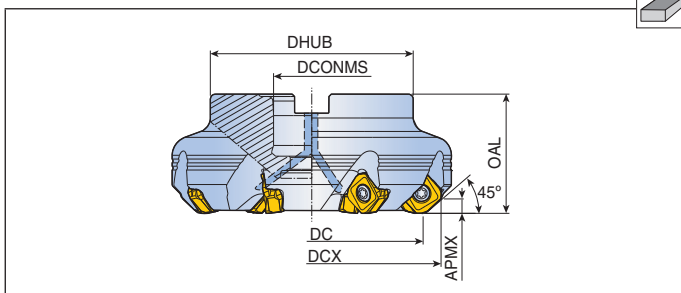

Designation		Dimension (mm)						Coolant hole	Arbor type	Kg	Mounting bolt	Insert
		DC	DCX	DCONMS	DHUB	OAL	APMX					
8D-TF45-450-22R-14	4	50	65.5	22	45	40	6	●	A	0.6	LH M10x25	SQKU 1406
650-22R-14	6	50	65.5	22	45	40	6	●	A	0.6	LH M10x25	
663-22R-14	6	63	78.5	22	47	50	6	●	A	1.1	SH M10x30	
863-22R-14	8	63	78.5	22	47	50	6	●	A	1.0	SH M10x30	
780-27R-14	7	80	95.5	27	70	50	6	●	A	1.7	LH M12x30	
1080-27R-14	10	80	95.5	27	70	50	6	●	A	1.7	LH M12x30	
8100-32R-14	8	100	115.5	32	85	50	6	●	A	2.6	LH M16x35	
12100-32R-14	12	100	115.5	32	85	50	6	●	A	2.5	LH M16x35	
6125-40R-14	6	125	140.5	40	85	63	6	●	A	4.1	SH M20x40	
10125-40R-14	10	125	140.5	40	85	63	6	●	A	4.4	SH M20x40	
16125-40R-14	16	125	140.5	40	85	63	6	●	A	4.3	SH M20x40	
7160-40R-14	7	160	175.5	40	110	63	6	x	C	5.6	-	
12160-40R-14	12	160	175.5	40	110	63	6	x	C	5.9	-	
20160-40R-14	20	160	175.5	40	110	63	6	x	C	5.9	-	
8200-60R-14	8	200	215.5	60	130	63	6	x	C	8.0	-	
18200-60R-14	18	200	215.5	60	130	63	6	x	C	8.4	-	
26200-60R-14	26	200	215.5	60	130	63	6	x	C	8.3	-	

► Mounting bolt with coolant through hole is available on request (ordering example: SH M10x1.5x30-C)

Spare parts

Designation	Screw	Wrench	Wrench handle		
8D-TF45-14	TS 50C130I/HG	TBLD T20-W6	SW6-T		



12D-TF45-06

Face mills

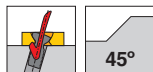
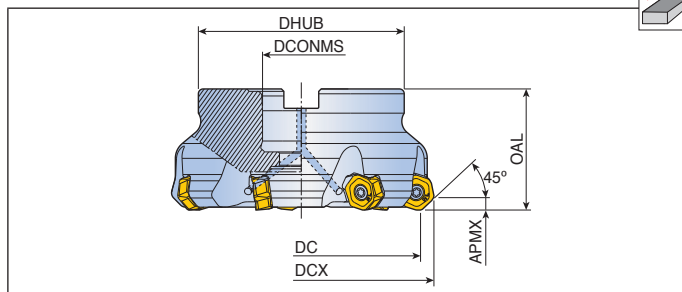

Designation	Z	Dimension (mm)						Coolant hole	Arbor style	Kg	Mounting bolt	Insert
		DC	DCX	DCONMS	DHUB	OAL	APMX					
12D-TF45-450-22R-06	4	50	60.8	22	45	40	3.0	●	A	0.5	LH M10x25	HXK(H)U
650-22R-06	6	50	60.8	22	45	40	3.0	●	A	0.5	LH M10x25	0605...
563-22R-06	5	63	73.8	22	47	40	3.0	●	A	0.7	LH M10x25	E275
763-22R-06	7	63	73.8	22	47	40	3.0	●	A	0.7	LH M10x25	
680-27R-06	6	80	90.8	27	70	50	3.0	●	A	1.5	SH M12x35	
1080-27R-06	10	80	90.8	27	70	50	3.0	●	A	1.5	SH M12x35	
7100-32R-06	7	100	110.8	32	85	50	3.0	●	A	2.2	LH M16x35	
12100-32R-06	12	100	110.8	32	85	50	3.0	●	A	2.2	LH M16x35	
10125-40R-06	10	125	135.8	40	85	63	3.0	●	A	3.6	SH M20x40	
16125-40R-06	16	125	135.8	40	85	63	3.0	●	A	3.6	SH M20x40	
12160-40R-06	12	160	170.8	40	110	63	3.0	x	C	4.9	-	
20160-40R-06	20	160	170.8	40	110	63	3.0	x	C	4.9	-	

► Mounting bolt with coolant through hole is available on request (ordering example: SH M10x1.5x30-C)

Spare parts

Designation	Screw	Wrench	Wrench handle		
12D-TF45-06	TS 40B100I	TBLD T15-W6	SW6-T		



12D-TF45-10



Face mills

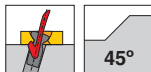
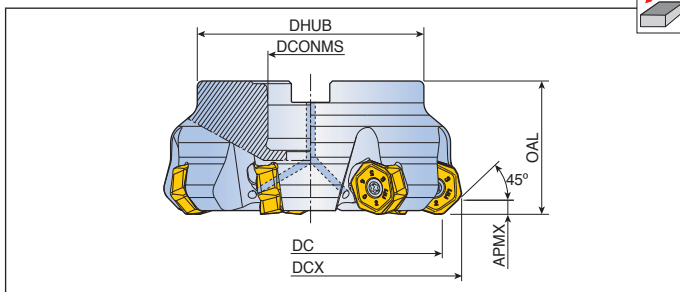

Designation	⊕	Dimension (mm)						Coolant hole	Arbor style	Kg	Mounting bolt	Insert
		DC	DCX	DCONMS	DHUB	OAL	APMX					
12D-TF45-563-22R-10	5	63	77.5	22	47	50	5.0	●	A	0.9	SH M10x30	HXK(H)U 1007...
763-22R-10	7	63	77.5	22	47	50	5.0	●	A	0.9	SH M10x30	
680-27R-10	6	80	94.5	27	70	50	5.0	●	A	1.6	SH M12x35	E275
980-27R-10	9	80	94.5	27	70	50	5.0	●	A	1.6	SH M12x35	
7100-32R-10	7	100	114.5	32	85	50	5.0	●	A	2.4	LH M16x35	
11100-32R-10	11	100	114.5	32	85	50	5.0	●	A	2.4	LH M16x35	
8125-40R-10	8	125	139.5	40	85	63	5.0	●	A	4.1	SH M20x40	
10125-40R-10	10	125	139.5	40	85	63	5.0	●	A	4.0	SH M20x40	
14125-40R-10	14	125	139.5	40	85	63	5.0	●	A	4.0	SH M20x40	
10160-40R-10	10	160	174.5	40	110	63	5.0	x	C	5.6	-	
16160-40R-10	16	160	174.5	40	110	63	5.0	x	C	5.6	-	
14200-60R-10	14	200	214.5	60	130	63	5.0	x	C	7.9	-	
21200-60R-10	21	200	214.5	60	130	63	5.0	x	C	7.9	-	
16250-60R-10	16	250	264.5	60	160	63	5.0	x	C	12.4	-	
26250-60R-10	26	250	264.5	60	160	63	5.0	x	C	12.4	-	

▶ Mounting bolt with coolant through hole is available on request (ordering example: SH M10x1.5x30-C)

Spare parts

Designation	Screw	Wrench	Wrench handle		
12D-TF45-10	TS 50C130/HG	TBLD T20-W6	SW6-T		

 E312-E315	 E316-E317	 E318
---------------	---------------	----------

14D-F45XN-06

Face mills

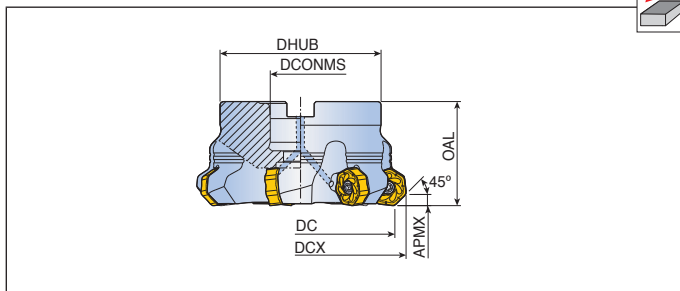
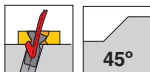

Designation		Dimension (mm)						Coolant hole	Arbor style	Kg	Mounting bolt	Insert
		DC	DCX	DCONMS	DHUB	OAL	APMX					
14D-F45XN 550-22R-06	5	50	59.1	22	45	40	3.5	●	A	0.4	LH M10x25	XNM(H)U 0605... E306
563-22R-06	5	63	72.1	22	47	50	3.5	●	A	0.8	SH M10x35	
763-22R-06	7	63	72.1	22	47	50	3.5	●	A	0.8	SH M10x35	
680-27R-06	6	80	89.1	27	70	50	3.5	●	A	1.4	SH M12x35	
980-27R-06	9	80	89.1	27	70	50	3.5	●	A	1.4	SH M12x35	
7100-32R-06	7	100	109.1	32	85	50	3.5	●	A	2.1	SH M16x35	
11100-32R-06	11	100	109.1	32	85	50	3.5	●	A	2.1	SH M16x35	
10125-40R-06	10	125	134.1	40	85	63	3.5	●	A	3.6	SH M20x40	
14125-40R-06	14	125	134.1	40	85	63	3.5	●	A	3.6	SH M20x40	
12160-40R-06	12	160	169.1	40	110	63	3.5	x	C	4.7	-	
16160-40R-06	16	160	169.1	40	110	63	3.5	x	C	4.9	-	
18160-40R-06	18	160	169.1	40	110	63	3.5	x	C	5.0	-	
14D-F45XN 763-25.4R-06	7	63	72.1	25.4	47	50	3.5	●	A	0.8	SH M12x30	
980-25.4R-06	9	80	89.1	25.4	70	50	3.5	●	A	1.4	SH M12x35	
11100-31.75R-06	11	100	109.1	31.75	80	50	3.5	●	A	1.9	LH M16x35	
14125-38.1R-06	14	125	134.1	38.1	80	63	3.5	x	B	3.9	-	

► Mounting bolt with coolant through hole is available on request (ordering example: SH M10x1.5x30-C)

Spare parts

Designation	Screw	Wrench			
	14D-F45XN-06	TS 40B100I	T-T15		



Face mills

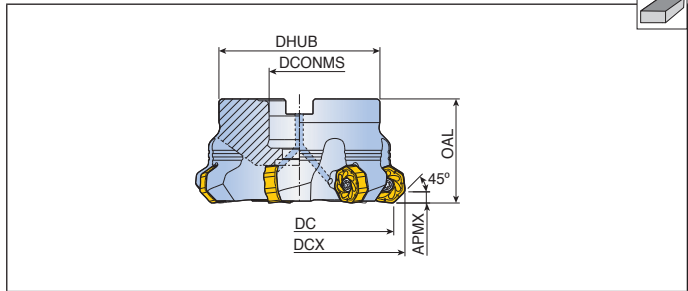

Designation		Dimension (mm)						Coolant hole	Arbor style	Kg	Mounting bolt	Insert
		DC	DCX	DCONMS	DHUB	OAL	APMX					
14D-F45XN 563-22R-09	5	63	74.9	22	47	50	5.0	●	A	0.9	SH M10x35	XNM(H)U 0906... E307
663-22R-09	6	63	74.9	22	47	50	5.0	●	A	0.9	SH M10x35	
680-27R-09	6	80	91.9	27	70	50	5.0	●	A	1.4	SH M12x35	
780-27R-09	7	80	91.9	27	70	50	5.0	●	A	1.5	SH M12x35	
7100-32R-09	7	100	112	32	85	55	5.0	●	A	2.4	SH M16x35	
9100-32R-09	9	100	112	32	85	55	5.0	●	A	2.5	SH M16x35	
8125-40R-09	8	125	137	40	85	63	5.0	●	A	3.5	SH M20x40	
10125-40R-09	10	125	137	40	85	63	5.0	●	A	3.6	SH M20x40	
12125-40R-09	12	125	137	40	85	63	5.0	●	A	3.4	SH M20x40	
10160-40R-09	10	160	172	40	110	63	5.0	x	C	4.8	-	
12160-40R-09	12	160	172	40	110	63	5.0	x	C	4.8	-	
14160-40R-09	14	160	172	40	110	63	5.0	x	C	4.8	-	
12200-60R-09	12	200	212	60	130	63	5.0	x	C	6.8	-	
16200-60R-09	16	200	212	60	130	63	5.0	x	C	6.9	-	
16250-60R-09	16	250	262	60	160	63	5.0	x	C	11.5	-	
20250-60R-09	20	250	262	60	160	63	5.0	x	C	11.5	-	
14D-F45XN 680-25.4R-09	6	80	91.9	25.4	70	50	5.0	●	A	1.4	SH M12x35	
7100-31.75R-09	7	100	112	31.75	80	55	5.0	●	A	2.4	SH M16x35	
8125-38.1R-09	8	125	137	38.1	80	63	5.0	x	B	3.5	-	
10160-50.8R-09	10	160	172	50.8	100	63	5.0	x	B	4.8	-	
12200-47.625R-09	12	200	212	47.625	130	63	5.0	x	C	6.8	-	

▶ Mounting bolt with coolant through hole is available on request (ordering example: SH M10x1.5x30-C)

Spare parts

Designation	Screw	Wrench			
14D-F45XN-09	TS 50C130/HG	T-T20			



E312-E315

E316-E317

E318

14D-F45XNH-06/09



Shim type face mills

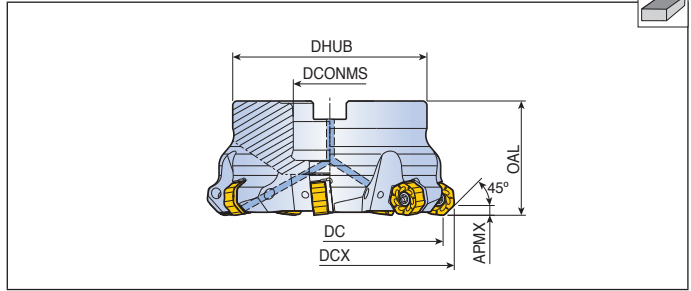

Designation		Dimension (mm)						Coolant hole	Arbor style	Kg	Mounting bolt	Insert
		DC	DCX	DCONMS	DHUB	OAL	APMX					
14D-F45XNH 763-22R-06	7	63	72.2	22	47	40	3.5	●	A	0.7	SH M10x25	XNM(H)U 0605... E306
780-27R-06	7	80	89.2	27	70	50	3.5	●	A	1.5	SH M12x35	
880-27R-06	8	80	89.2	27	70	50	3.5	●	A	1.5	SH M12x35	
7100-32R-06	7	100	109.2	32	85	50	3.5	●	A	2.2	SH M16x35	
8100-32R-06	8	100	109.2	32	85	50	3.5	●	A	2.2	SH M16x35	
11125-40R-06	11	125	134.2	40	85	63	3.5	●	A	3.5	SH M20x40	
14D-F45XNH 563-22R-09	5	63	75.1	22	47	40	5.0	●	A	0.6	SH M10x35	XNM(H)U 0906... E307
680-27R-09	6	80	92.1	27	70	50	5.0	●	A	1.5	SH M12x35	
7100-32R-09	7	100	112.1	32	85	50	5.0	●	A	2.2	SH M16x35	
9125-40R-09	9	125	137.0	40	85	63	5.0	●	A	3.6	SH M20x40	

► Mounting bolt with coolant through hole is available on request (ordering example: SH M10x1.5x30-C)

Spare parts

Designation	Screw	Shim	Shim screw	Wrench	Wrench handle
14D-F45XNH-06	TS 35C110I	TSXN 06N	TS 5035062S-B	TBLD T15-W6	SW6-T
14D-F45XNH-09	TS 50C130I/HG	TSXN 09N	TS 8050110S	TBLD T20-W6	SW6-T

E312-E315

E316-E317

E318

14D-F45XNW-09

Face mill

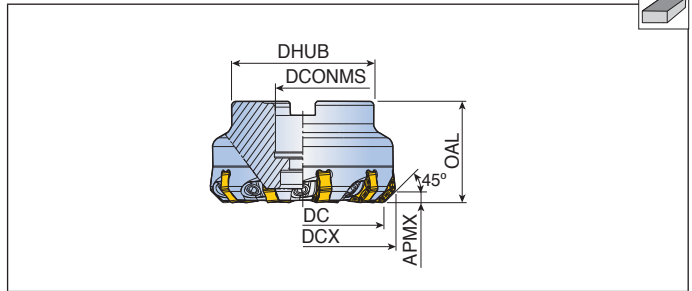

Designation		Dimension (mm)						Arbor style	Kg	Mounting bolt	Insert
		DC	DCX	DCONMS	DHUB	OAL	APMX				
14D-F45XNW 1080-27R-09	10	80	91.9	27	70	50	5.0	A	1.5	SH M12x35	XNHU 0906... E307
14100-32R-09	14	100	112	32	85	55	5.0	A	2.9	SH M16x35	
18125-40R-09	18	125	137	40	85	63	5.0	B	3.8	-	
18160-40R-09	18	160	172	40	110	63	5.0	C	5.6	-	
22160-40R-09	22	160	172	40	110	63	5.0	C	5.6	-	
28200-60R-09	28	200	212	60	130	63	5.0	C	7.9	-	
36250-60R-09	36	250	262	60	160	63	5.0	C	12.7	-	
44315-60R-09	44	315	327	60	220	63	5.0	D	19.9	-	

▶ Recommend to very stable machining condition at cast iron & steel

Spare parts

Designation	Wedge	Wedge screw	Wrench		
14D-F45XNW-09	WFZ 8H	WS 8	T-W 4		

 E312-E315	 E316-E317	 E318
---------------	---------------	----------

7S-F45-06



Face mills

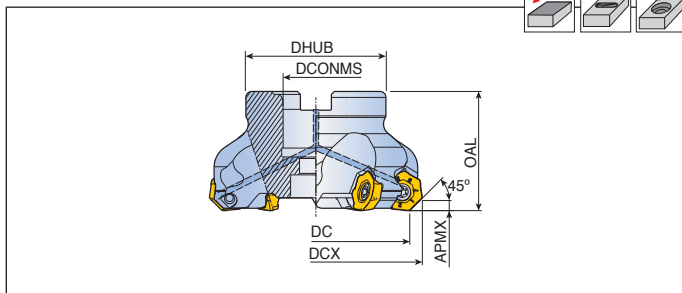

Designation	⚙️	Dimension (mm)						Coolant hole	Arbor style	Kg	Mounting bolt	Insert
		DC	DCX	DCONMS	DHUB	OAL	APMX					
7S-F45 332-16R-06	3	32	40.4	16	38	40	3.2	●	E	0.2	KTB 32B	7EMT 0604... E257
440-16R-06	4	40	48.5	16	38	40	3.2	●	A	0.3	SH M8x30	
550-22R-06	5	50	58.5	22	45	40	3.2	●	A	0.4	LH M10x25	
663-22R-06	6	63	71.5	22	47	40	3.2	●	A	0.5	LH M10x25	
780-27R-06	7	80	88.5	27	70	50	3.2	●	A	1.3	LH M12x30	
8100-32R-06	8	100	108.5	32	85	50	3.2	●	A	1.9	LH M16x35	
9125-40R-06	9	125	133.5	40	85	63	3.2	●	A	3.3	SH M20x40	
7S-F45 780-25.4R-06	7	80	88.5	25.4	70	50	3.2	●	A	1.3	LH M12x30	
8100-31.75R-06	8	100	108.5	31.75	80	50	3.2	●	A	1.8	LH M16x35	
9125-38.1R-06	9	125	133.5	38.1	80	63	3.2	x	B	2.8	-	

► Mounting bolt with coolant through hole is available on request (ordering example: SH M8x1.25x30-C)

Spare parts

Designation	Screw	Wrench			
	7S-F45-06	TS 400931/HG	T-T15		

E312-E315	E316-E317	E373	E318
-----------	-----------	------	------

TFM45SN-13



Face mills

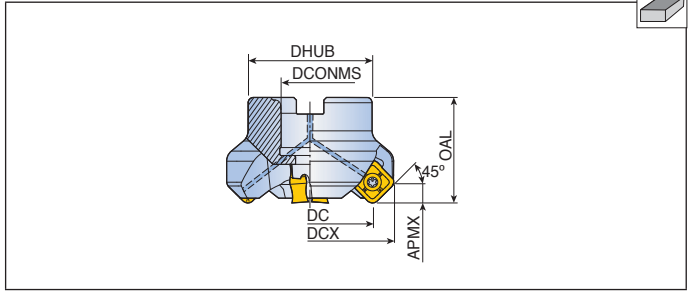

Designation	⊕	Dimension (mm)							Coolant hole	Arbor style	Kg	Mounting bolt	Insert
		DC	DCX	DCONMS	DHUB	OAL	APMX						
TFM45SN 440-16R-13	4	40	54.7	16	38	40	7.0	●	A	0.3	LH M10x25	SNM(G)X 1306 AN... SNMX 1306 XTN E292	
450-22R-13	4	50	64.7	22	45	40	7.0	●	A	0.5	LH M10x25		
650-22R-13	6	50	64.7	22	45	40	7.0	●	A	0.5	LH M10x25		
663-22R-13	6	63	77.7	22	47	40	7.0	●	A	0.7	LH M10x25		
863-22R-13	8	63	77.7	22	47	40	7.0	●	A	0.7	LH M10x25		
480-27R-13B	4	80	94.8	27	70	50	7.0	●	A	1.4	LH M12x30		
780-27R-13	7	80	94.8	27	70	50	7.0	●	A	1.5	LH M12x30		
1080-27R-13	10	80	94.8	27	70	50	7.0	●	A	1.5	LH M12x30		
5100-32R-13B	5	100	114.8	32	85	50	7.0	●	A	2.1	LH M16x35		
8100-32R-13	8	100	114.8	32	85	50	7.0	●	A	2.2	LH M16x35		
12100-32R-13	12	100	114.8	32	85	50	7.0	●	A	2.2	LH M16x35		
6125-40R-13B	6	125	139.8	40	85	63	7.0	●	A	3.8	SH M20x40		
10125-40R-13	10	125	139.8	40	85	63	7.0	●	A	3.8	SH M20x40		
16125-40R-13	16	125	139.6	40	85	63	7.0	●	A	3.8	SH M20x40		
8160-40R-13B	8	160	174.8	40	110	63	7.0	x	C	4.9	-		
12160-40R-13	12	160	174.8	40	110	63	7.0	x	C	4.9	-		
20160-40R-13	20	160	174.5	40	110	63	7.0	x	C	5.0	-		
10200-60R-13B	10	200	214.8	60	130	63	7.0	x	C	6.5	-		
18200-60R-13	18	200	214.8	60	130	63	7.0	x	C	6.6	-		
26200-60R-13	26	200	214.3	60	130	63	7.0	x	C	7.0	-		
20250-60R-13	20	250	264.8	60	160	63	7.0	x	C	12.9	-		
TFM45SN 480-25.4R-13B	4	80	94.8	25.4	70	50	7.0	●	A	1.4	LH M12x30		
5100-31.75R-13B	5	100	114.8	31.75	80	50	7.0	x	B	2.1	-		
6125-38.1R-13B	6	125	139.8	38.1	80	63	7.0	x	B	3.8	-		
10125-38.1R-13	10	125	139.8	38.1	80	63	7.0	x	B	3.4	-		
8160-50.8R-13B	8	160	174.8	50.8	100	63	7.0	x	B	4.9	-		
12160-50.8R-13	12	160	174.8	50.8	100	63	7.0	x	B	5.0	-		
10200-47.625R-13B	10	200	214.8	47.625	130	63	7.0	x	C	6.5	-		
12250-47.625R-13B	12	250	264.8	47.625	160	63	7.0	x	C	12.9	-		

► Mounting bolt with coolant through hole is available on request (ordering example: SH M10x1.5x30-C)

Cutting Condition E312-E315	Arbor Style E316-E317	Torque E318
--------------------------------	--------------------------	----------------

Face mills

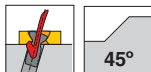
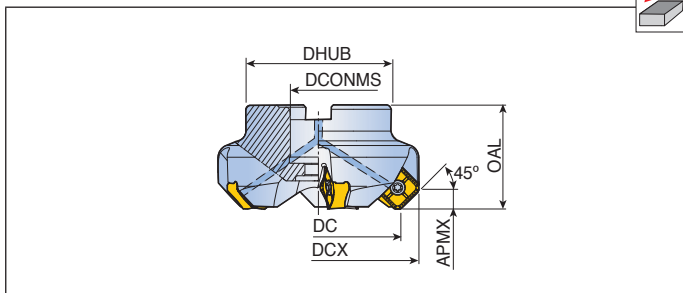

Designation		Dimension (mm)						Coolant hole	Arbor style	Kg	Mounting bolt	Insert
		DC	DCX	DCONMS	DHUB	OAL	APMX					
TFM45SNS 463-22R-16	4	63	81.1	22	47	50	8.8	●	A	1.0	LH M10x25	SNMX 1607... SNHX 1606... E294
580-27R-16	5	80	98.2	27	70	50	8.8	●	A	1.5	LH M12x30	
7100-32R-16	7	100	118.2	32	85	50	8.8	●	A	2.3	LH M16x35	
8125-40R-16	8	125	143.2	40	85	63	8.8	●	A	4.0	SH M20x40	
10125-40R-16	10	125	143.2	40	85	63	8.8	●	A	4.0	SH M20x40	
10160-40R-16	10	160	178.2	40	110	63	8.8	x	C	5.4	-	
12160-40R-16	12	160	178.2	40	110	63	8.8	x	C	5.4	-	
12200-60R-16	12	200	218.2	60	130	63	8.8	x	C	7.5	-	
14250-60R-16	14	250	268.2	60	160	63	8.8	x	C	13	-	
TFM45SNS 580-25.4R-16	5	80	98.2	25.4	70	50	8.8	●	A	1.5	LH M12x30	
7100-31.75R-16	7	100	118.2	31.75	80	50	8.8	x	B	2.3	-	
8125-38.1R-16	8	125	143.2	38.1	80	63	8.8	x	B	4.0	-	
10160-50.8R-16	10	160	178.2	50.8	100	63	8.8	x	B	5.4	-	
12200-47.625R-16	12	200	218.2	47.625	130	63	8.8	x	C	7.5	-	

► Mounting bolt with coolant through hole is available on request (ordering example: SH M10x1.5x30-C)

Spare parts

Designation	Screw	Wrench			
TFM45SN-13	TS 40B100I	T-T15			
TFM45SNS-16	TS 45120I	T-T20			



TFM45SNS-16B-CA



Face mills

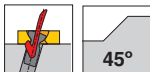
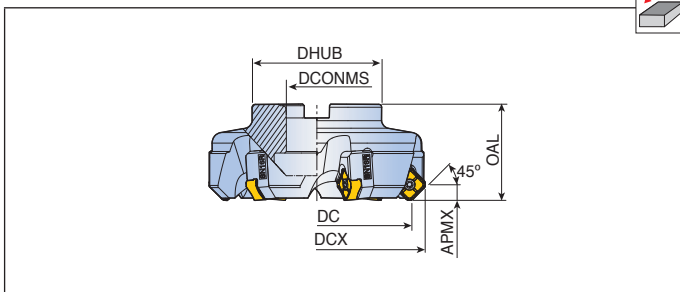

Designation		Dimension (mm)						Arbor style	Kg	Insert
		DC	DCX	DCONMS	DHUB	OAL	APMX			
TFM45SNS 6125-40R-16B-CA	6	125	143.2	40	85	63	8.8	B	4.0	SNMX 1607...
8160-40R-16B-CA	8	160	178.2	40	110	63	8.8	C	5.9	SNHX 1606...
10200-60R-16B-CA	10	200	218.2	60	130	63	8.8	C	8.1	E294
14250-60R-16-CA	14	250	268.2	60	160	63	8.8	C	13.3	
14315-60R-16B-CA	14	315	333.2	60	220	80	8.8	D	24.0	

Spare parts

Designation	Screw	Cartridge	Cartridge screw	Wrench	
TFM45SNS-16B-CA	TS 45120I	TCT23-SN16R	TS 60170I	T-T20	

Cutting Condition E312-E315	Arbor Style E316-E317	Torque E318
--------------------------------	--------------------------	----------------

TFM45SNW-16/TQ45SNW-16



Face mills

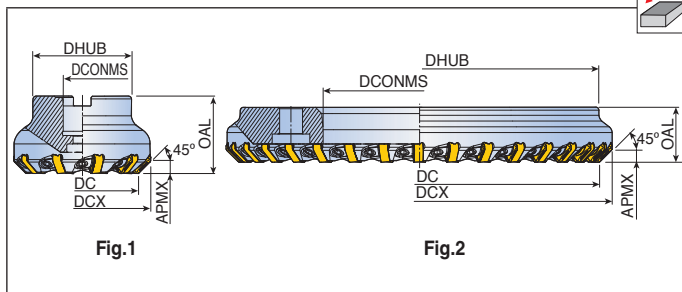

Designation		Dimension (mm)						Fig.	Arbor style	Kg	Mounting bolt	Insert
		DC	DCX	DCONMS	DHUB	OAL	APMX					
TFM45SNW 1080-27R-16	10	80	98.2	27	70	55	8.8	1	A	1.9	LH M12x30	SNHX 1606...
14100-32R-16	14	100	118.2	32	85	63	8.8	1	A	3.2	SH M16x35	E294
18125-40R-16	18	125	143.2	40	85	63	8.8	1	B	3.9	-	-
22160-40R-16	22	160	178.2	40	110	63	8.8	1	C	5.7	-	-
26200-60R-16	26	200	218.2	60	130	63	8.8	1	C	7.8	-	-
32250-60R-16	32	250	268.2	60	160	63	8.8	1	C	13.5	-	-

Designation		Dimension (mm)						Fig.	Kg	Adapter	Insert
		DC	DCX	DCONMS	DHUB	OAL	APMX				
TQ45SNW 26200R-16	26	200	218.2	63.5	200	38	8.8	2	6.3	QA 08 K/M	SNHX 1606...
34250R-16	34	250	268.2	133.35	248	38	8.8	2	7.9	QA 10 K/M	E294
44315R-16	44	315	333.2	146.05	313	38	8.8	2	13.2	QA 12 K/M	-
50355R-16	50	355	373.2	215.90	353	38	8.8	2	13.0	QA 14 K/M	-

► Recommend to very stable machining condition at cast iron & steel

Spare parts

Designation	Wedge 	Wedge screw 	Wrench 		
TFM45SNW	WFZ 8H-SN	WS 8	T-W 4		
TQ45SNW	WFZ 8H-SN	WS 8	T-W 4		

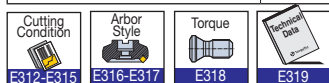

Face mills

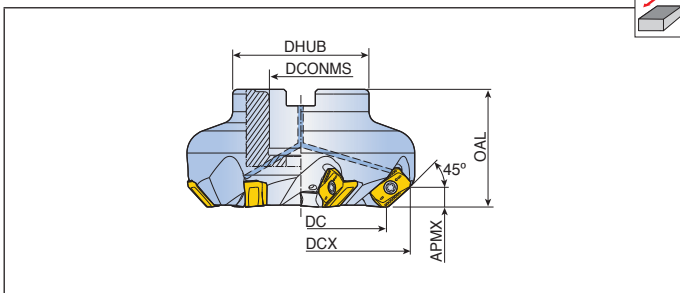

Designation		Dimension (mm)						Coolant hole	Arbor style	Kg	Mounting bolt	Insert
		DC	DCX	DCONMS	DHUB	OAL	APMX					
TFM45AN 450-22R-16	4	50	67.8	22	45	40	8.4	●	A	0.6	LH M10x25	ANHX 1607 ANR-M E257
663-22R-16	6	63	80.6	22	47	40	8.4	●	A	0.9	LH M10x25	
780-27R-16	7	80	97.5	27	58	50	8.4	●	A	1.6	SH M12x35	
8100-32R-16	8	100	117.5	32	85	50	8.4	●	A	2.5	LH M16x35	
9125-40R-16	9	125	142.6	40	85	63	8.4	●	A	4.3	SH M20x40	
10160-40R-16	10	160	177.7	40	110	63	8.4	x	C	5.8	-	

- ▶ 90° Inserts can not be mounted
- ▶ Mounting bolt with coolant through hole is available on request (ordering example: SH M10x1.5x30-C)

Spare parts

Designation	Screw	Wrench			
	TFM45AN	TS 40120I	T-T15		

Cutting Condition E312-E315	Arbor Style E316-E317	Torque E318
--------------------------------	--------------------------	----------------

LM45SD-12/15



Face mills (Inch bore)

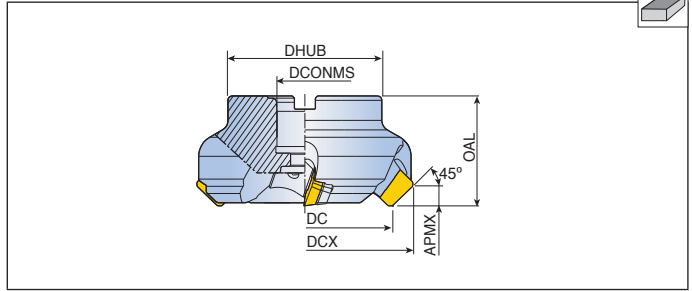

Designation		Dimension (mm)						Arbor style	Kg	Mounting bolt	Insert
		DC	DCX	DCONMS	DHUB	OAL	APMX				
LM45SD 480-25.4R-12	4	80	93.8	25.4	70	50	6.5	A	1.6	LH M12x30	SDKN 1203...
5100-31.75R-12	5	100	113.8	31.75	80	60	6.5	A	2.8	LH M16x35	E288
6125-38.1R-12	6	125	138.8	38.1	80	63	6.5	B	3.5	-	-
8160-50.8R-12	8	160	173.9	50.8	100	63	6.5	B	5.5	-	-
10200-47.625R-12	10	200	213.9	47.625	130	63	6.5	C	7.6	-	-
12250-47.625R-12	12	250	263.9	47.625	160	63	6.5	C	12.6	-	-
LM45SD 6125-38.1R/L-15	6	125	143.6	38.1	80	63	8.7	B	3.5	-	SDKN 1504...
8160-50.8R/L-15	8	160	178.6	50.8	100	63	8.7	B	5.5	-	E288
10200-47.625R-15	10	200	218.6	47.625	130	63	8.7	C	7.6	-	-
12250-47.625R/L-15	12	250	268.6	47.625	160	63	8.7	C	12.6	-	-
14315-47.625R/L-15	14	315	333.54	47.625	220	63	6.7	D	18.7	-	-

► Metric bore cutter is available upon request

Spare parts

Designation	Carbide shim	Wedge	Shim screw	Wedge screw	Wrench	
LM45SD-12 (Ø80)	TSSDSE 12N	WPA 8	TS 40B100I	TS 80160W	T-W 4	T-T15
LM45SD-15 (Ø100-)	TSSDSE 15N	WPA 8	TS 40B100I	TS 80200W	T-W 4	T-T15

E312-E315

E316-E317

E318

► The shim screw wrench T-T15⁽¹⁾ shall be ordered separately

LM45SE-12/15



Face mills (Inch bore)

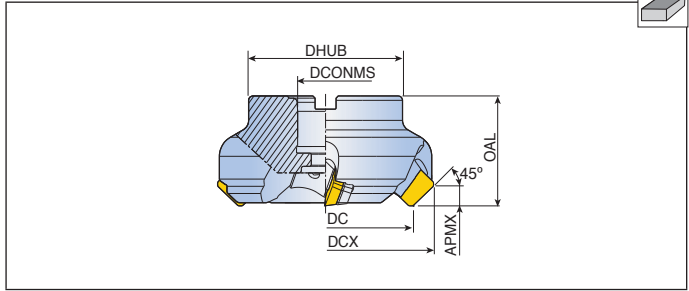

Designation		Dimension (mm)						Arbor style	Kg	Mounting bolt	Insert
		DC	DCX	DCONMS	DHUB	OAL	APMX				
LM45SE 480-25.4R-12	4	80	93.7	25.4	70	55	6.5	A	1.8	LH M12x30	SEKN 1203...
5100-31.75R-12	5	100	113.6	31.75	80	60	6.5	A	2.8	LH M16x35	E289
6125-38.1R-12	6	125	138.6	38.1	80	63	6.5	B	3.4	-	-
8160-50.8R-12	8	160	173.6	50.8	100	63	6.5	B	5.0	-	-
10200-47.625R-12	10	200	213.6	47.625	130	63	6.5	C	7.5	-	-
12250-47.625R-12	12	250	263.6	47.625	160	63	6.5	C	12.2	-	-
LM45SE 480-25.4R-15	4	80	97.8	25.4	70	55	8.7	A	1.8	LH M12x30	SEKN 1504...
5100-31.75R-15	5	100	118	31.75	80	60	8.7	A	2.8	LH M16x35	E289
6125-38.1R-15	6	125	143	38.1	80	63	8.7	B	3.5	-	-
8160-50.8R-15	8	160	178	50.8	100	63	8.7	B	5.7	-	-
10200-47.625R-15	10	200	218	47.625	130	63	8.7	C	7.8	-	-
12250-47.625R-15	12	250	268	47.625	160	63	8.7	C	12.8	-	-

► Metric bore cutter is available upon request

Spare parts

Designation	Carbide shim	Wedge	Shim screw	Wedge screw	Wrench	
LM45SE-12	TSSDSE 12N	WPA 8	TS 40B100I	TS 80200W	T-W 4	T-T15
LM45SE-15	TSSDSE 15N	WPA 8	TS 40B100I	TS 80160W ⁽¹⁾	T-W 4	T-T15

Cutting Condition
 E312-E315

Arbor Style
 E316-E317

Torque
 E318

► ⁽¹⁾ TS 80160W is for D80 cutter
 ► The shim screw wrench T-T15⁽²⁾ shall be ordered separately

TFMRNS-10/12



Face mills

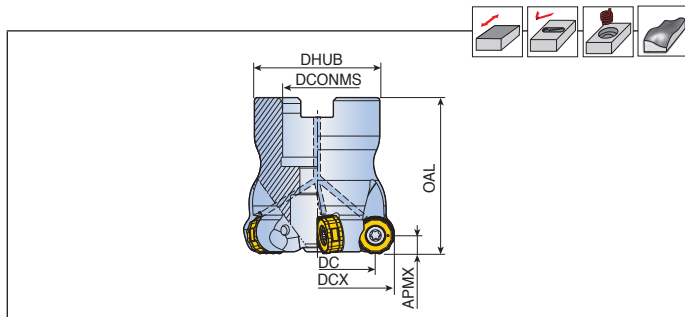

Designation		Dimension (mm)						Coolant hole	Arbor style	Kg	Mounting bolt	Insert
		DCX	DC	DCONMS	DHUB	OAL	APMX					
TFMRNS 432-16R-10	4	32	22	16	30	40	5.0	●	E	0.1	KTB 32B	RNMU 1004...
433-16R-10	4	33	23	16	30	40	5.0	●	E	0.1	KTB 32B	E284
540-16R-10	5	40	30	16	38	40	5.0	●	A	0.2	SH M8x30	
650-22R-10	6	50	40	22	45	50	5.0	●	A	0.4	SH M10x30	
652-22R-10	6	52	42	22	45	50	5.0	●	A	0.4	SH M10x30	
TFMRNS 440-16R-12	4	40	28	16	38	40	6.0	●	A	0.2	SH M8x30	RNMU 1205...
450-22R-12	4	50	38	22	45	50	6.0	●	A	0.3	SH M10x30	E284
550-22R-12	5	50	40	22	45	50	6.0	●	A	0.3	SH M10x30	
552-22R-12	5	52	40	22	45	50	6.0	●	A	0.4	SH M10x30	
563-22R-12	5	63	51	22	47	50	6.0	●	A	0.6	SH M10x30	
663-22R-12	6	63	51	22	47	50	6.0	●	A	0.6	SH M10x30	
666-27R-12	6	66	54	27	58	50	6.0	●	A	0.6	SH M12x35	
680-27R-12	6	80	68	27	58	50	6.0	●	A	1.1	SH M12x35	
780-27R-12	7	80	68	27	58	50	6.0	●	A	1.0	SH M12x35	
7100-32R-12	7	100	88	32	66	50	6.0	●	A	1.5	LH M16x35	
8100-32R-12	8	100	88	32	66	50	6.0	●	A	1.5	LH M16x35	

► Mounting bolt with coolant through hole is available on request (ordering example: SH M10x1.5x30-C)

Spare parts

Designation	Screw	Wrench			
TFMRNS-10	TS 35085I/HG	T-T15			
TFMRNS-12	TS 40G110I	T-T15			

 E312-E315	 E316-E317	 E318	 E386-E387
---------------	---------------	----------	---------------

TFMRNS-16



Face mills

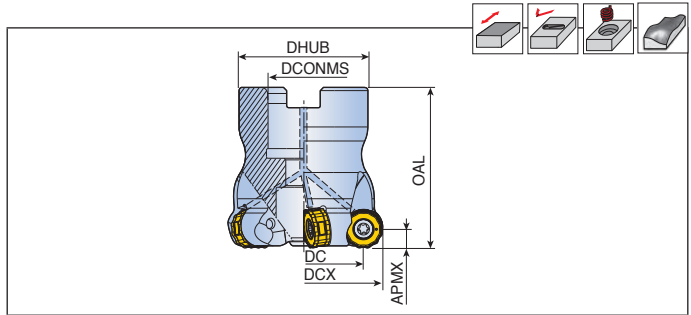

Designation		Dimension (mm)						Coolant hole	Arbor style	Kg	Mounting bolt	Insert
		DCX	DC	DCONMS	DHUB	OAL	APMX					
TFMRNS 350-16R-16	3	50	34	16	38	50	8.0	●	A	0.2	SH M8x30	RNMU 1606... E284
450-16R-16	4	50	34	16	38	50	8.0	●	A	0.2	SH M8x30	
452-22R-16	4	52	36	22	45	50	8.0	●	A	0.3	SH M10x30	
463-22R-16	4	63	47	22	47	50	8.0	●	A	0.5	SH M10x30	
566-27R-16	5	66	50	27	58	50	8.0	●	A	0.6	LH M12x30	
580-27R-16	5	80	64	27	58	50	8.0	●	A	0.9	LH M12x30	
680-27R-16	6	80	64	27	58	50	8.0	●	A	0.8	LH M12x30	
6100-32R-16	6	100	84	32	66	50	8.0	●	A	1.7	LH M16x35	
7125-40R-16	7	125	109	40	85	63	8.0	●	A	3.0	SH M20x40	
8125-40R-16	8	125	109	40	85	63	8.0	●	A	2.9	SH M20x40	
9160-40R-16	9	160	144	40	110	63	8.0	x	C	3.8	-	
10200-60R-16	10	200	184	60	130	63	8.0	x	C	5.6	-	

▶ Mounting bolt with coolant through hole is available on request (ordering example: SH M10x1.5x30-C)

Spare parts

Designation	Screw	Wrench			
TFMRNS-16	TS 50A1211/HG	T-T20			

 E312-E315	 E316-E317	 E318	 E386-E387
---------------	---------------	----------	---------------

Face mills

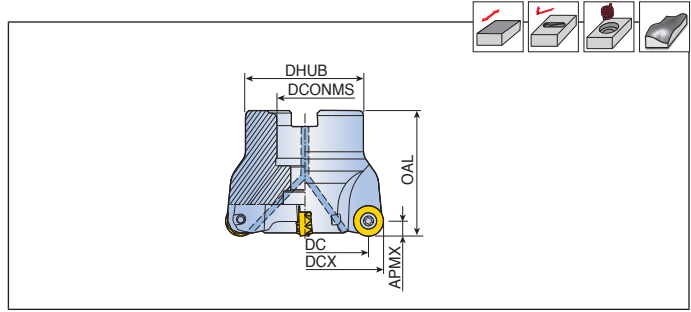

Designation		Dimension (mm)							Coolant hole	Arbor style	Kg	Mounting bolt	Insert
		DCX	DC	DCONMS	DHUB	OAL	APMX						
TFMRY 532-16R-08	5	32	24	16	30	40	4.0	●	A	0.12	SH M8x30	RYM(H)X 0803...	
640-16R-08	6	40	32	16	38	40	4.0	●	A	0.22	SH M8x30	E285-E286	
TFMRY 432-16R-10	4	32	22	16	30	40	5.0	●	A	0.12	SH M8x30	RYM(H)X 1004...	
540-16R-10	5	40	30	16	38	40	5.0	●	A	0.22	SH M8x30	E285-E286	
640-16R-10	6	40	30	16	38	40	5.0	●	A	0.23	SH M8x30		
650-22R-10	6	50	40	22	45	50	5.0	●	A	0.33	SH M10x30		
652-22R-10	6	52	42	22	45	50	5.0	●	A	0.36	SH M10x30		
763-22R-10	7	63	53	22	47	50	5.0	●	A	0.57	SH M10x30		
766-27R-10	7	66	56	27	58	50	5.0	●	A	0.68	LH M12x30		
TFMRY 332-16R-12	3	32	20	16	30	50	6.0	●	E	0.12	KTB 32B	RYM(H)X 1205...	
440-16R-12	4	40	28	16	38	40	6.0	●	A	0.15	SH M8x30	E285-E286	
442-16R-12	4	42	30	16	38	40	6.0	●	A	0.21	SH M8x30		
450-22R-12	4	50	38	22	45	50	6.0	●	A	0.33	SH M10x30		
550-22R-12	5	50	38	22	45	50	6.0	●	A	0.33	SH M10x30		
552-22R-12	5	52	40	22	45	50	6.0	●	A	0.34	SH M10x30		
463-22R-12	4	63	51	22	47	50	6.0	●	A	0.57	SH M10x30		
563-22R-12	5	63	51	22	47	50	6.0	●	A	0.58	SH M10x30		
663-22R-12	6	63	51	22	47	50	6.0	●	A	0.58	SH M10x30		
763-22R-12	7	63	51	22	47	50	6.0	●	A	0.71	SH M10x30		
666-27R-12	6	66	54	27	58	50	6.0	●	A	0.62	LH M12x30		
766-27R-12	7	66	54	27	58	50	6.0	●	A	0.62	LH M12x30		
680-27R-12	6	80	68	27	58	50	6.0	●	A	0.90	LH M12x30		
780-27R-12	7	80	68	27	58	50	6.0	●	A	0.92	LH M12x30		
880-27R-12	8	80	68	27	58	50	6.0	●	A	0.98	LH M12x30		
7100-32R-12	7	100	88	32	66	50	6.0	●	A	1.29	LH M16x35		
8100-32R-12	8	100	88	32	66	50	6.0	●	A	1.37	LH M16x35		
8125-40R-12	8	125	113	40	85	63	6.0	●	A	3.00	SH M20x40		
9125-40R-12	9	125	113	40	85	63	6.0	●	A	2.99	SH M20x40		

Cutting Condition E312-E315	Arbor Style E316-E317	Torque E318	Ramping Data E388-E390
--------------------------------	--------------------------	----------------	---------------------------

► Mounting bolt with coolant through hole is available on request (ordering example: SH M10x1.5x30-C)

Face mills

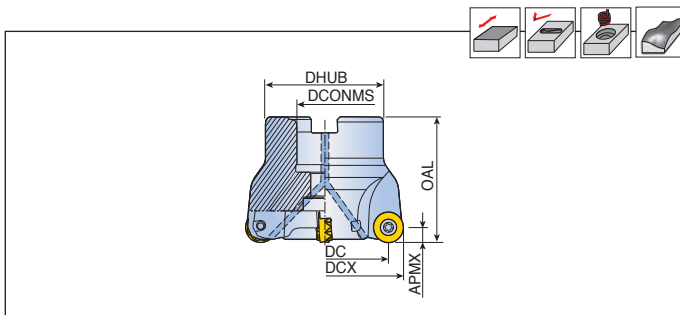

Designation		Dimension (mm)						Coolant hole	Arbor style	Kg	Mounting bolt	Insert
		DCX	DC	DCONMS	DHUB	OAL	APMX					
TFMRY 350-16R-16	3	50	34	16	38	50	8.0	●	A	0.3	SH M8x35	RYM(H)X 1606... E285-E286
450-16R-16	4	50	34	16	38	50	8.0	●	A	0.3	SH M8x35	
450-22R-16	4	50	34	22	45	50	8.0	●	A	0.3	SH M10x30	
452-22R-16	4	52	36	22	45	50	8.0	●	A	0.3	SH M10x30	
463-22R-16	4	63	47	22	47	50	8.0	●	A	0.5	SH M10x30	
463H-22R-16*	4	63	47	22	47	50	8.0	●	A	0.5	SH M10x30	
566-27R-16	5	66	50	27	58	50	8.0	●	A	0.6	LH M12x30	
580-27R-16	5	80	64	27	58	50	8.0	●	A	0.8	LH M12x30	
580H-27R-16*	5	80	64	27	58	50	8.0	●	A	0.8	LH M12x30	
680-27R-16	6	80	64	27	58	50	8.0	●	A	0.8	LH M12x30	
6100-32R-16	6	100	84	32	66	50	8.0	●	A	1.2	LH M16x35	
6100H-32R-16*	6	100	84	32	66	50	8.0	●	A	1.2	LH M16x35	
7125-40R-16	7	125	109	40	85	63	8.0	●	A	2.7	SH M20x40	
7125H-40R-16*	7	125	109	40	85	63	8.0	●	A	2.6	SH M20x40	
8125-40R-16	8	125	109	40	85	63	8.0	●	A	2.7	SH M20x40	
8160H-40R-16*	8	160	144	40	110	63	8.0	x	C	3.3	-	
TFMRY 580-25.4R-16	5	80	64	25.4	70	50	8.0	●	A	1.0	SH M12x35	

► *: Carbide shim type

► Mounting bolt with coolant through hole is available on request (ordering example: SH M10x1.5x30-C)

Spare parts

Designation	Shim	Shim screw	Screw	Wrench	
TFMRY-08	-	-	TS 30A60I/HG	TD 9	-
TFMRY-10	-	-	TS 35085/HG	-	T-T15
TFMRY-12	-	-	TS 40093I	-	T-T15
TFMRY-16	-	-	TS 50115I	-	T-T20
TFMRY...H-16	TSRY 16NS	TS 8050088S	TS 50A140I	-	T-T20



TFMRY-20



Face mills

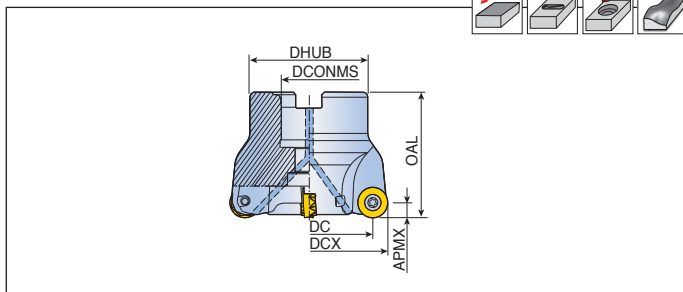

Designation		Dimension (mm)						Coolant hole	Arbor style	Kg	Mounting bolt	Insert
		DCX	DC	DCONMS	DHUB	OAL	APMX					
TFMRY 463-22R-20	4	63	43	22	47	50	10.0	●	A	0.5	SH M10x30	RVMX 2007...
580-27R-20	5	80	60	27	58	50	10.0	●	A	0.8	LH M12x30	
5100H-32R-20*	5	100	80	32	66	50	10.0	●	A	1.1	LH M16x35	E285-E286
6100-32R-20	6	100	80	32	66	50	10.0	●	A	1.2	LH M16x35	
5125H-40R-20*	5	125	105	40	85	63	10.0	●	A	2.7	SH M20x40	
7125-40R-20	7	125	105	40	85	63	10.0	●	A	2.5	SH M20x40	
6160H-40R-20*	6	160	140	40	110	63	10.0	x	C	2.7	-	
8160-40R-20	8	160	140	40	110	63	10.0	x	C	3.8	-	
8200H-60R-20*	8	200	180	60	130	63	10.0	x	C	5.3	-	
9250H-60R-20*	9	250	230	60	160	63	10.0	x	C	9.3	-	

- *: Carbide shim type
- ▶ Mounting bolt with coolant through hole is available on request (ordering example: SH M10x1.5x30-C)

Spare parts

Designation	Shim	Shim screw	Screw	Wrench	Wrench handle
TFMRY-20	-	-	TS 60A130I	BLD T25/M7	SW6-T
TFMRY...H-20	TSRY 20NS	TS 9060011S	TS 60A165I	BLD T25/M7	SW6-T

 E312-E315	 E316-E317	 E318	 E388-E390
---------------	---------------	----------	---------------

Face mills

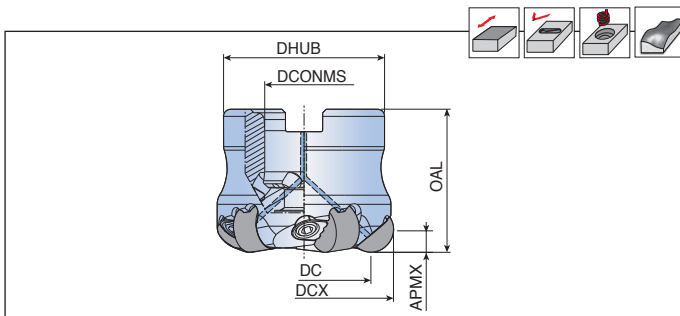

Designation		Dimension (mm)						Air hole ⁽¹⁾	Arbor style	Kg	Mounting bolt	Insert
		DCX	DC	DCONMS	DHUB	OAL	APMX					
TFMRN 450-22R-1207	4	50	37.3	22	45	40	6.3	●	A	0.4	SH M10x30	RNGN 1207
550-22R-1207	5	50	37.3	22	45	40	6.3	●	A	0.4	SH M10x30	FL...
463-22R-1207	4	63	50.3	22	47	40	6.3	●	A	0.6	SH M10x30	E283
663-22R-1207	6	63	50.3	22	47	40	6.3	●	A	0.6	SH M10x30	
763-22R-1207	7	63	50.3	22	47	40	6.3	●	A	0.6	SH M10x30	
580-27R-1207	5	80	67.3	27	58	50	6.3	●	A	1.1	SH M12x35	
780-27R-1207	7	80	67.3	27	58	50	6.3	●	A	1.1	SH M12x35	
880-27R-1207	8	80	67.3	27	58	50	6.3	●	A	1.1	SH M12x35	

- ▶ Mounting bolt with air through hole is available on request (ordering example: SH M10x1.5x30-C)
- ▶ ⁽¹⁾ Use only air (Coolant is prohibited)

Spare parts

Designation	Wedge 	Screw 	Wrench 		
TFMRN-12	WFZ 6-C	WS 6	T-W 3		

 Cutting Condition E312-E315	 Arbor Style E316-E317	 Torque E318
------------------------------------	------------------------------	--------------------

TFMRP-12



Face mills

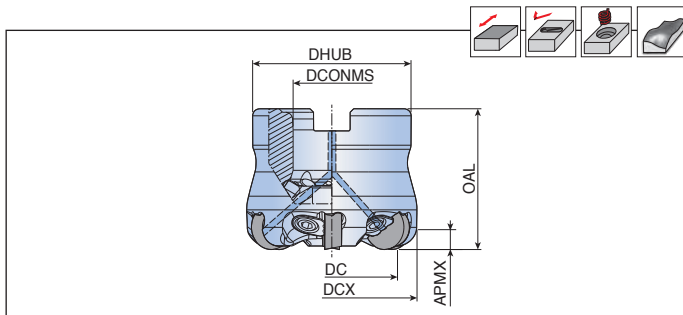

Designation		Dimension (mm)						Air hole ⁽¹⁾	Arbor style	Kg	Mounting bolt	Insert
		DCX	DC	DCONMS	DHUB	OAL	APMX					
TFMRP 450-22R-12	4	50	37.3	22	45	40	6.3	●	A	0.3	LH M10x25	RPGN 1204
650-22R-12	6	50	37.3	22	45	40	6.3	●	A	0.3	LH M10x25	FL... E283

- ▶ Mounting bolt with air through hole is available on request (ordering example: SH M10x1.5x30-C)
- ▶ ⁽¹⁾ Use only air (Coolant is prohibited)

Spare parts

Designation	Wedge 	Screw 	Wrench 		
TFMRP-12	WFZ 6-C	WS 6	T-W 3		

 E312-E315	 E316-E317	 E318
---------------	---------------	----------

High feed face mills

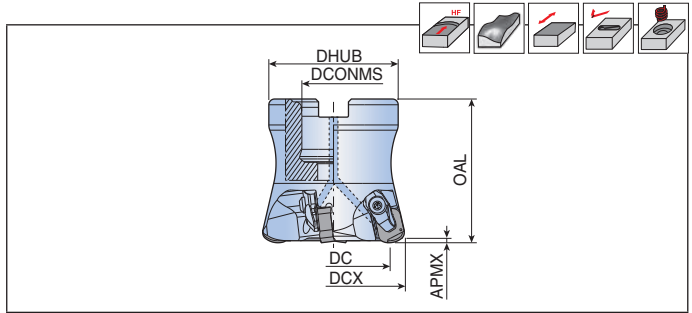

Designation		Dimension (mm)						Air hole ⁽¹⁾	Arbor style	Kg	Mounting bolt	Insert
		DCX	DC	DCONMS	DHUB	OAL	APMX					
TFMBN 440-16R-09CH	4	40	29.4	16	38	40	1.5	●	A	0.2	SH M8x30	BNGX 0904... E271
350-22R-09CH	3	50	39.4	22	45	40	1.5	●	A	0.5	SH M10x30	
550-22R-09CH	5	50	39.4	22	45	40	1.5	●	A	0.4	SH M10x30	

- ▶ Mounting bolt with air through hole is available on request (ordering example: SH M10x1.5x30-C)
- ▶ ⁽¹⁾ Use only air (Coolant is prohibited)

Spare parts

Designation	Clamp 	Screw 	Snap ring 	Wrench 	
TFMBN-09CH	CCL-3S	CLS-35A120/HG	CSR 1.25	L-W 2	

 Cutting Condition E312-E315	 Arbor Style E316-E317	 Torque E318	 Ramping Data E391-E392
------------------------------------	------------------------------	--------------------	-------------------------------

High feed face mills

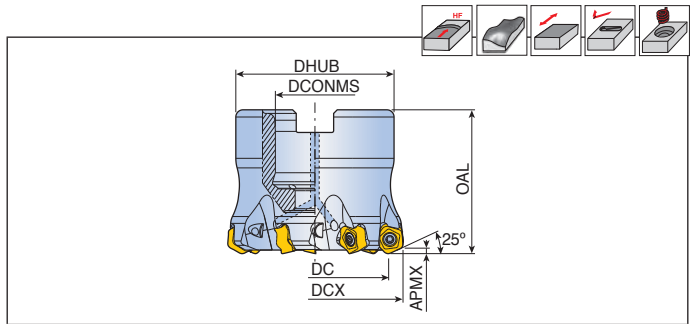

Designation	Z	Dimension (mm)						Coolant hole	Arbor style	K _g	Mounting bolt	Insert
		DCX	DC	DCONMS	DHUB	OAL	APMX					
TFMPT 640-16R-05	6	40	31.8	16	38	40	1.5	●	A	0.3	SH M8x25	PTKU 0503... E282
750-22R-05	7	50	41.8	22	45	40	1.5	●	A	0.4	LH M10x25	
752-22R-05	7	52	43.8	22	45	40	1.5	●	A	0.3	LH M10x25	
863-22R-05	8	63	54.8	22	58	50	1.5	●	A	0.8	SH M10x30	
866-27R-05	8	66	57.8	27	58	50	1.5	●	A	0.7	SH M12x35	
TFMPT 450-22R-10	4	50	33.4	22	45	40	3.0	●	E	0.3	TCS10-40	PTKU 1006... E282
563-22R-10	5	63	46.4	22	58	50	3.0	●	A	0.8	SH M10x30	
566-22R-10	5	66	49.4	22	58	50	3.0	●	A	0.8	SH M10x30	
680-27R-10	6	80	63.4	27	70	60	3.0	●	A	1.4	SH M12x30	
8100-32R-10	8	100	83.4	32	85	60	3.0	●	A	2.3	SH M16x35	
9125-32R-10	9	125	108.4	32	85	60	3.0	●	A	3.1	SH M16x35	
10160-40R-10	10	160	143.4	40	110	60	3.0	x	C	4.1	-	
12200-60R-10	12	200	183.4	60	130	60	3.0	x	C	5.7	-	
TFMPT 680-25.4R-10	6	80	63.4	25.4	70	60	3.0	●	A	1.5	SH M12x35	
8100-31.75R-10	8	100	83.4	31.75	80	60	3.0	x	B	2.0	-	
9125-38.1R-10	9	125	108.4	38.1	80	60	3.0	x	B	2.6	-	
10160-50.8R-10	10	160	143.4	50.8	100	60	3.0	x	B	4.2	-	

▶ Mounting bolt with coolant through hole is available on request (ordering example: SH M10x1.5x30-C)

Spare parts

Designation	Screw	Wrench		Wrench handle	
TFMPT-05	TS 25D060/HG-P	TD7P	-	-	
TFMPT-10	TS 50D130/HG-P	-	TBLD T20P-W6	SW6-T	

 E312-E315	 E316-E317	 E318	 E374-E375
---------------	---------------	----------	---------------

8D-TF20-11/14

High feed face mills

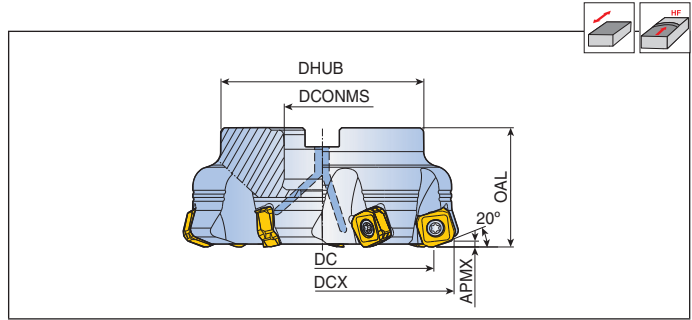

Designation	Z	Dimension (mm)						Coolant hole	Arbor type	Kg	Mounting bolt	Insert
		DC	DCX	DCONMS	DHUB	OAL	APMX					
8D-TF20-450-22R-11	4	50	63.5	22	45	40	1.8	●	A	0.5	SH M10X30	SQKU
563-22R-11	5	63	76.5	22	47	50	1.8	●	A	0.9	SH M10X30	1105
680-27R-11	6	80	93.5	27	70	50	1.8	●	A	1.5	SH M12X35	
8100-32R-11	8	100	113.5	32	85	50	1.8	●	A	2.2	LH M16X35	E298
8D-TF20-563-22R-14	5	63	80.6	22	47	50	2.5	●	A	1.0	SH M10X30	SQKU
680-27R-14	6	80	97.6	27	70	50	2.5	●	A	1.7	SH M12X35	1406
7100-32R-14	7	100	117.5	32	85	50	2.5	●	A	2.5	LH M16X35	
8125-40R-14	8	125	142.5	40	85	63	2.5	●	A	4.3	SH M20X40	E298

► Mounting bolt with coolant through hole is available on request (ordering example: SH M10x1.5x30-C)

Spare parts

Designation	Screw	Wrench	Wrench handle		
8D-TF20-11	TS 40A1151	TBLD T15-W6	SW6-T		
8D-TF20-14	TS 50C130I/HG	TBLD T20-W6	SW6-T		

 E312-E315	 E316-E317	 E318
---------------	---------------	----------

TFMBLV-06



High feed face mills

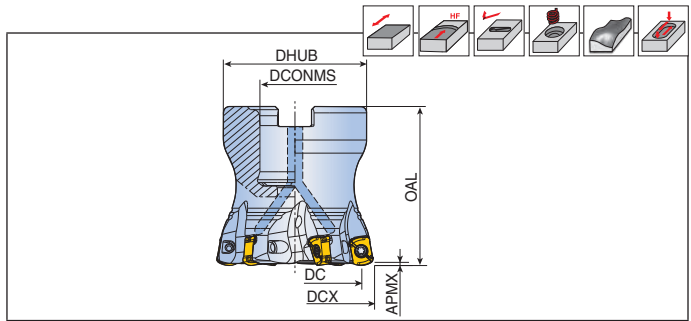

Designation		Dimension (mm)						Coolant hole	Arbor type		Mounting bolt	Insert
		DCX	DC	DCONMS	DHUB	OAL	APMX					
TFMBLV 432-16R-06	4	32	24	16	30	40	1.0	●	A	0.1	SH M8x25	BLMV 0603... E270
532-16R-06	5	32	24	16	30	40	1.0	●	A	0.1	SH M8x26	
640-16R-06	6	40	32	16	38	40	1.0	●	A	0.2	SH M8x25	
640-22R-06	6	40	32	22	38	40	1.0	●	A	0.2	SH M10x30	
650-22R-06	6	50	42	22	45	50	1.0	●	A	0.4	SH M10x30	
750-22R-06	7	50	42	22	45	50	1.0	●	A	0.4	SH M10x30	
850-22R-06	8	50	42	22	45	50	1.0	●	A	0.4	SH M10x30	
752-22R-06	7	52	44	22	45	40	1.0	●	A	0.4	SH M10x30	
852-22R-06	8	52	44	22	45	40	1.0	●	A	0.4	SH M10x30	
763-22R-06	7	63	55	22	48	50	1.0	●	A	0.6	SH M10x30	
863-22R-06	8	63	55	22	48	50	1.0	●	A	0.6	SH M10x30	
963-22R-06	9	63	55	22	48	50	1.0	●	A	0.6	SH M10x30	
966-27R-06	9	66	58	27	58	50	1.0	●	A	0.7	SH M12x30	

▶ Mounting bolt with coolant through hole is available on request (ordering example: SH M10x1.5x30-C)

Spare parts

Designation	Screw	Wrench			
	TEBLV/TFMBLV-06	 TS 25064/HG-P	 TD 8P		

 E312-E315	 E316-E317	 E318	 E377
---------------	---------------	----------	----------

TFMBL-06/09



High feed face mills

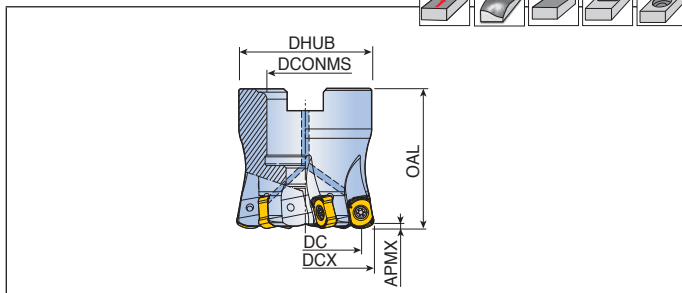
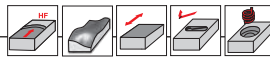

Designation		Dimension (mm)						Coolant hole	Arbor style	Kg	Mounting bolt	Insert
		DCX	DC	DCONMS	DHUB	OAL	APMX					
TFMBL 432-16R-06	4	32	24.3	16	30	40	1.0	●	A	0.1	SH M8x25	BLMP 0603...
532-16R-06	5	32	24.3	16	30	40	1.0	●	A	0.1	SH M8x25	
640-16R-06	6	40	32.2	16	38	40	1.0	●	A	0.2	SH M8x25	
640-22R-06	6	40	32.2	22	38	40	1.0	●	A	0.2	SH M10x30	
650-22R-06	6	50	42.2	22	45	50	1.0	●	A	0.4	SH M10x30	
750-22R-06	7	50	42.2	22	45	50	1.0	●	A	0.4	SH M10x30	
850-22R-06	8	50	42.2	22	45	50	1.0	●	A	0.4	SH M10x30	
752-22R-06	7	52	44.2	22	45	40	1.0	●	A	0.4	SH M10x30	
852-22R-06	8	52	44.2	22	45	40	1.0	●	A	0.4	SH M10x30	
763-22R-06	7	63	55.5	22	47	50	1.0	●	A	0.6	SH M10x30	
863-22R-06	8	63	55.5	22	47	50	1.0	●	A	0.6	SH M10x30	
963-22R-06	9	63	55.5	22	47	50	1.0	●	A	0.6	SH M10x30	
966-27R-06	9	66	58.5	27	58	50	1.0	●	A	0.7	SH M12x35	
TFMBL 432-16R-09	4	32	21.6	16	30	40	1.5	●	E	0.1	KTB 32B	BLMP 0904...
440-16R-09	4	40	29.6	16	38	40	1.5	●	A	0.2	SH M8x25	
540-16R-09	5	40	29.6	16	38	40	1.5	●	A	0.2	SH M8x25	
550-22R-09	5	50	39.6	22	45	50	1.5	●	A	0.4	SH M10x30	
650-22R-09	6	50	39.6	22	45	50	1.5	●	A	0.4	SH M10x30	
750-22R-09	7	50	39.6	22	45	50	1.5	●	A	0.4	SH M10x30	
652-22R-09	6	52	41.6	22	45	40	1.5	●	A	0.4	SH M10x30	
752-22R-09	7	52	41.6	22	45	40	1.5	●	A	0.4	SH M10x30	
663-22R-09	6	63	52.6	22	47	50	1.5	●	A	0.6	SH M10x30	
763-22R-09	7	63	52.6	22	47	50	1.5	●	A	0.6	SH M10x30	
863-22R-09	8	63	52.6	22	47	50	1.5	●	A	0.6	SH M10x30	
766-27R-09	7	66	55.6	27	58	50	1.5	●	A	0.7	SH M12x35	
866-27R-09	8	66	55.6	27	58	50	1.5	●	A	0.8	SH M12x35	
780-27R-09	7	80	69.6	27	70	50	1.5	●	A	1.2	SH M12x35	
880-27R-09	8	80	69.6	27	70	50	1.5	●	A	1.2	SH M12x35	
980-27R-09	9	80	69.6	27	70	50	1.5	●	A	1.2	SH M12x35	
1080-27R-09	10	80	69.6	27	70	50	1.5	●	A	1.2	SH M12x35	
8100-32R-09	8	100	89.6	32	85	60	1.5	●	A	2.3	SH M16x35	
9100-32R-09	9	100	89.6	32	85	60	1.5	●	A	2.3	SH M16x35	
10100-32R-09	10	100	89.6	32	85	60	1.5	●	A	2.3	SH M16x35	
11100-32R-09	11	100	89.6	32	85	60	1.5	●	A	2.3	SH M16x35	
12100-32R-09	12	100	89.6	32	85	60	1.5	●	A	2.3	SH M16x35	
12125-40R-09	12	125	114.6	40	85	60	1.5	●	A	2.7	SH M20x40	
14125-40R-09	14	125	114.6	40	85	60	1.5	●	A	2.7	SH M20x40	

Cutting Condition E312-E315	Arbor Style E316-E317	Torque E318	Ramping Data E379-E381
--------------------------------	--------------------------	----------------	---------------------------

TFMBL-11



High feed face mills

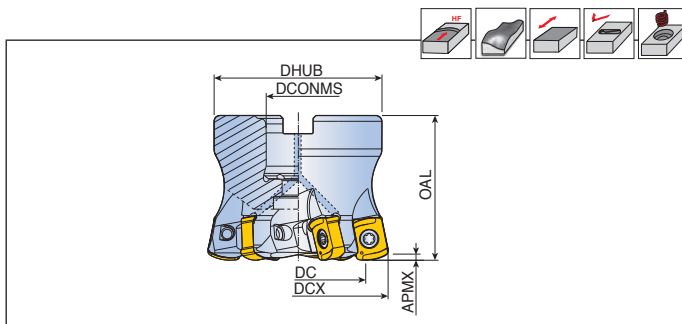

Designation	⚙️	Dimension (mm)						Coolant hole	Arbor style	⚖️ Kg	Mounting bolt	Insert
		DCX	DC	DCONMS	DHUB	OAL	APMX					
TFMBL 440-16R-11	4	40	24.4	16	30	40	2.0	●	E	0.2	KTB 32B	BLMP 1105... E268
450-22R-11	4	50	34.4	22	45	40	2.0	●	A	0.3	LH M10x25	
550-22R-11	5	50	34.4	22	45	40	2.0	●	A	0.3	LH M10x25	
552-22R-11	5	52	36.4	22	45	40	2.0	●	A	0.3	LH M10x25	
563-22R-11	5	63	48.4	22	58	50	2.0	●	A	0.7	SH M10x30	
663-22R-11	6	63	48.4	22	58	50	2.0	●	A	0.7	SH M10x30	
666-22R-11	6	66	50.3	22	58	50	2.0	●	A	0.8	SH M10x30	
666-27R-11	6	66	50.3	27	58	50	2.0	●	A	0.7	SH M12x35	
680-27R-11	6	80	64.3	27	70	60	2.0	●	A	1.4	SH M12x30	
780-27R-11	7	80	64.3	27	70	60	2.0	●	A	1.4	SH M12x30	
6100-32R-11	6	100	84.3	32	85	60	2.0	●	A	2.2	SH M16x35	
7100-32R-11	7	100	84.3	32	85	60	2.0	●	A	2.2	SH M16x35	
8125-32R-11	8	125	109.3	32	85	60	2.0	●	A	2.5	SH M20x40	
10125-40R-11	10	125	109.3	40	85	60	2.0	●	A	2.7	SH M20x40	
10160-40R-11	10	160	144.3	40	110	60	2.0	x	C	3.9	-	
12200-60R-11	12	200	184.3	60	130	60	2.0	x	C	5.8	-	
TFMBL 680-25.4R-11	6	80	64.3	25.4	70	60	2.0	●	A	1.4	SH M12x35	
6100-31.75R-11	6	100	84.3	31.75	80	60	2.0	x	B	1.8	-	

▶ Mounting bolt with coolant through hole is available on request (ordering example: SH M10x1.5x30-C)

Spare parts

Designation	Screw	Wrench		Wrench handle
TFMBL-06	TS 250641/HG-P	TD 8P	-	-
TFMBL-09	TS 35A0881/HG	TD 10P	-	-
TFMBL-11	TS 50A1211/HG	-	TBLD T20-W6	SW6-T

 E312-E315	 E316-E317	 E318	 E379-E381
---------------	---------------	----------	---------------

TFMBL-13

High feed face mills

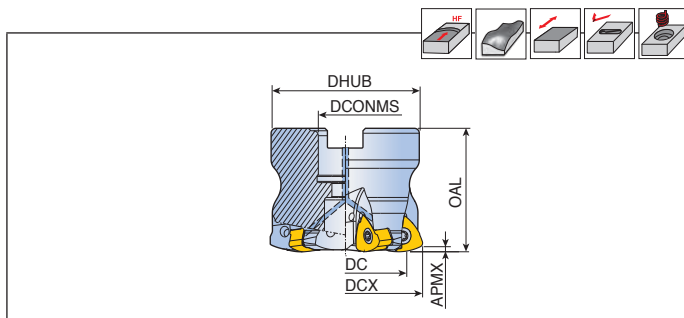

Designation		Dimension (mm)						Coolant hole	Arbor style	Kg	Mounting bolt	Insert
		DCX	DC	DCONMS	DHUB	OAL	APMX					
TFMBL 340-16R-13	3	40	20.7	16	30	50	2.0	●	A	0.2	KTB 32B	BLMP 1306... E269
350-22R-13	3	50	31.0	22	45	40	2.0	●	A	0.3	LH M10x25	
450-22R-13	4	50	31.0	22	45	40	2.0	●	A	0.3	LH M10x25	
452-22R-13	4	52	32.2	22	45	40	2.0	●	A	0.3	SH M10x30	
463-22R-13	4	63	45.8	22	60	50	2.0	●	A	0.8	SH M10x30	
563-22R-13	5	63	45.8	22	60	50	2.0	●	A	0.8	SH M10x30	
463-27R-13	4	63	45.8	27	58	50	2.0	●	A	0.7	SH M12x30	
466-22R-13	4	66	45.9	22	60	50	2.0	●	A	0.8	SH M10x30	
566-22R-13	5	66	45.9	22	60	50	2.0	●	A	0.8	SH M10x30	
566-27R-13	5	66	45.9	27	58	50	2.0	●	A	0.7	SH M12x30	
580-27R-13	5	80	59.8	27	70	60	2.0	●	A	1.4	SH M12x30	
680-27R-13	6	80	59.8	27	70	60	2.0	●	A	1.4	SH M12x30	
580-32R-13	5	80	59.8	32	76	60	2.0	●	A	1.4	SH M16x35	
5100-32R-13	5	100	79.7	32	76	60	2.0	●	A	1.9	SH M16x35	
6100-32R-13	6	100	79.7	32	76	60	2.0	●	A	2.0	SH M16x35	
7100-32R-13	7	100	79.7	32	76	60	2.0	●	A	2.0	SH M16x35	
6125-32R-13	6	125	104.5	32	85	60	2.0	●	A	3.0	SH M16x35	
7125-40R-13	7	125	104.5	40	85	60	2.0	●	A	2.9	SH M20x35	
7160-40R-13	7	160	139.5	40	110	60	2.0	x	C	3.6	-	
8160-40R-13	8	160	139.5	40	110	60	2.0	x	C	3.6	-	
9160-40R-13	9	160	139.5	40	110	60	2.0	x	C	3.8	-	
8200-60R-13	8	200	179.5	60	130	60	2.0	x	C	5.4	-	
9200-60R-13	9	200	179.5	60	130	60	2.0	x	C	5.3	-	
11200-60R-13	11	200	179.5	60	130	60	2.0	x	C	5.5	-	
9250-60R-13	9	250	229.5	60	160	60	2.0	x	C	10.6	-	
10250-60R-13	10	250	229.5	60	160	60	2.0	x	C	10.6	-	
12250-60R-13	12	250	229.5	60	160	60	2.0	x	C	10.7	-	

Cutting Condition E312-E315
 Arbor Style E316-E317
 Torque E318
 Ramping Data E382

► Mounting bolt with coolant through hole is available on request (ordering example: SH M10x1.5x30-C)

TFMBL-13



High feed face mills (Inch bore)

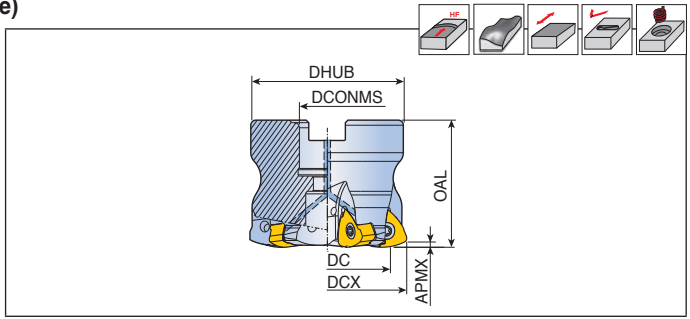

Designation		Dimension (mm)						Coolant hole	Arbor style	Kg	Mounting bolt	Insert
		DCX	DC	DCONMS	DHUB	OAL	APMX					
TFMBL 580-25.4R-13	5	80	59.8	25.4	70	60	2.0	●	A	1.3	SH M12x30	BLMP 1306...
580-31.75R-13	5	80	59.8	31.75	76	60	2.0	●	A	1.3	SH M16x35	E269
6100-31.75R-13	6	100	79.7	31.75	76	60	2.0	●	A	1.9	SH M16x35	
7125-38.1R-13	7	125	104.5	38.1	80	60	2.0	x	B	3.0	-	

► Mounting bolt with coolant through hole is available on request (ordering example: SH M10x1.5x30-C)

Spare parts

Designation	Screw	Wrench			
	TFMBL-13	TS 50B106/HG	T-T20		

Cutting Condition E312-E315	Arbor Style E316-E317	Torque E318	Ramping Data E382
--------------------------------	--------------------------	----------------	----------------------

TFMSB-06/09



High feed face mills

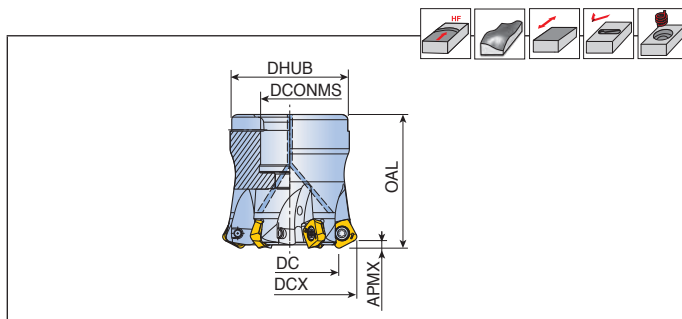

Designation		Dimension (mm)						Coolant hole	Arbor style	Kg	Mounting bolt	Insert
		DCX	DC	DCONMS	DHUB	OAL	APMX					
TFMSB 532-16R-06	5	32	21.7	16	30	40	1.0	●	A	0.1	SH M8x25	SBMT 0603...
640-16R-06	6	40	29.7	16	38	40	1.0	●	A	0.2	SH M8x25	E287
750-22R-06	7	50	39.7	22	45	50	1.0	●	A	0.4	SH M10x35	
863-22R-06	8	63	52.7	22	47	50	1.0	●	A	0.6	SH M10x35	
TFMSB 432-16R-09	4	32	17.4	16	30	40	1.2	●	E	0.1	KTB 32B	SBMT 0904...
440-16R-09	4	40	25.5	16	38	40	1.2	●	A	0.2	SH M8x25	E287
540-16R-09	5	40	25.5	16	38	40	1.2	●	A	0.2	SH M8x25	
450-22R-09	4	50	35.5	22	45	50	1.2	●	A	0.4	SH M10x30	
550-22R-09	5	50	35.5	22	45	50	1.2	●	A	0.4	SH M10x30	
650-22R-09	6	50	35.5	22	45	50	1.2	●	A	0.4	SH M10x30	
750-22R-09	7	50	35.5	22	45	50	1.2	●	A	0.4	SH M10x30	
652-22R-09	6	52	37.5	22	45	50	1.2	●	A	0.4	SH M10x30	
752-22R-09	7	52	37.5	22	45	50	1.2	●	A	0.4	SH M10x30	
663-22R-09	6	63	48.4	22	58	50	1.2	●	A	0.8	SH M10x30	
763-22R-09	7	63	48.4	22	58	50	1.2	●	A	0.8	SH M10x30	
763-27R-09	7	63	48.4	27	58	50	1.2	●	A	0.7	SH M12x35	
863-22R-09	8	63	48.4	22	58	50	1.2	●	A	0.8	SH M10x30	
866-22R-09	8	66	51.5	22	58	50	1.2	●	A	0.8	SH M10x30	
780-27R-09	7	80	65.8	27	70	60	1.2	●	A	1.4	SH M12x35	
880-27R-09	8	80	65.8	27	70	60	1.2	●	A	1.4	SH M12x35	

► Mounting bolt with coolant through hole is available on request (ordering example: SH M8x1.25x25-C)

Spare parts

Designation	Screw	Wrench			
TFMSB-06	TS 25064I/HG-P	TD 8P			
TFMSB-09	TS 35A088I/HG	TD 10P			
TFMSB 750-22R-09	TS 35A070I/HG	TD 10P			
TFMSB 752-22R-09	TS 35A070I/HG	TD 10P			



TFMSB-13

High feed face mills

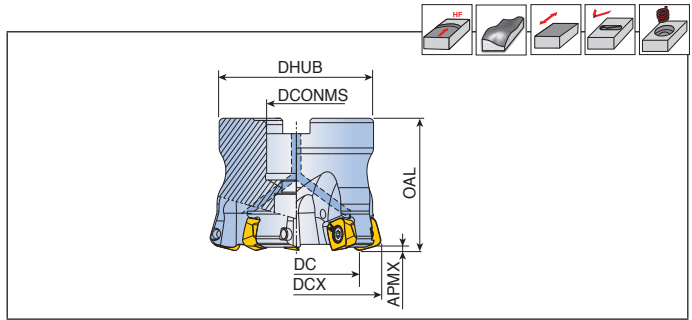

Designation		Dimension (mm)						Coolant hole	Arbor style	Kg	Mounting bolt	Insert
		DCX	DC	DCONMS	DHUB	OAL	APMX					
TFMSB 350-22R-13	3	50	29.3	22	45	40	2.0	●	A	0.3	LH M10x25	SBMT 1306... E287
450-22R-13	4	50	29.3	22	45	40	2.0	●	A	0.2	LH M10x25	
452-22R-13	4	52	31.3	22	45	40	2.0	●	A	0.3	LH M10x25	
552-22R-13	5	52	31.3	22	45	40	2.0	●	A	0.2	LH M10x25	
463-22R-13	4	63	42.4	22	58	50	2.0	●	A	0.6	SH M10x30	
563-22R-13	5	63	42.4	22	58	50	2.0	●	A	0.5	SH M10x30	
463-27R-13	4	63	42.4	27	58	50	2.0	●	A	0.5	SH M12x35	
566-27R-13	5	66	45.3	27	58	50	2.0	●	A	0.6	SH M12x35	
580-27R-13	5	80	59.4	27	70	60	2.0	●	A	1.3	SH M12x35	
680-27R-13	6	80	59.4	27	70	60	2.0	●	A	1.3	SH M12x35	
580-32R-13	5	80	59.4	32	76	60	2.0	●	A	1.3	SH M16x35	
6100-32R-13	6	100	79.4	32	76	60	2.0	●	A	1.9	SH M16x35	
7125-40R-13	7	125	104.7	40	85	60	2.0	●	A	2.5	SH M20x40	
8160-40R-13	8	160	139.4	40	110	60	2.0	x	C	3.5	-	
9200-60R-13	9	200	179.4	60	130	60	2.0	x	C	5.1	-	
10250-60R-13	10	250	229.4	60	160	60	2.0	x	C	9.1	-	
TFMSB 463-25.4R-13	4	63	42.4	25.4	58	50	2.0	●	A	0.5	SH M12x35	
580-25.4R-13	5	80	59.4	25.4	70	60	2.0	●	A	1.3	SH M12x35	
580-31.75R-13	5	80	59.4	31.75	76	60	2.0	●	A	1.3	SH M16x35	
7125-38.1R-13	7	125	104.7	38.1	80	60	2.0	x	B	2.2	-	

▶ Mounting bolt with coolant through hole is available on request (ordering example: SH M10x1.5x30-C)

Spare parts

Designation	Screw	Wrench			
	TFMSB-13	TS 50115I	T-T20		

Cutting Condition E312-E315	Arbor Style E316-E317	Torque E318	Ramping Data E383-E385
--------------------------------	--------------------------	----------------	---------------------------

2S-TE90CV-05



End mills

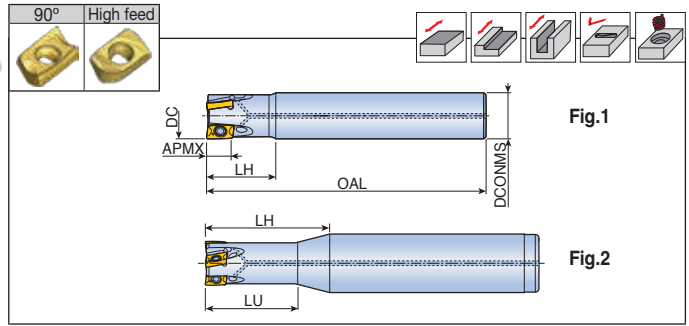
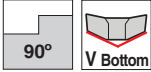

Designation		Dimension (mm)						Coolant hole	Fig.	Insert
		DC	DCONMS	OAL	LH	LU	APMX			
2S-TE90CV-106-06-05	1	6	6	60	12	-	5.0	●	1	CVK(H)T 0502... E273
106-06-05-L50	1	6	6	50	10	-	5.0	●	1	
208-07-05	2	8	7	80	12	-	5.0	●	1	
208-08-05	2	8	8	80	12	-	5.0	●	1	
208-08-05-L50	2	8	8	50	10	-	5.0	●	1	
208-12-05	2	8	12	80	25	18	5.0	●	2	
209-08-05	2	9	8	80	12	-	5.0	●	1	
210-10-05	2	10	10	80	15	-	5.0	●	1	
212-12-05	2	12	12	80	15	-	5.0	●	1	
310-09-05	3	10	9	80	12	-	5.0	●	1	
310-10-05	3	10	10	80	15	-	5.0	●	1	
310-10-05-L55	3	10	10	55	12	-	5.0	●	1	
310-16-05-L90	3	10	16	90	34	22	5.0	●	2	
311-10-05	3	11	10	80	12	-	5.0	●	1	
312-12-05	3	12	12	80	15	-	5.0	●	1	
412-11-05	4	12	11	80	12	-	5.0	●	1	
412-12-05	4	12	12	80	15	-	5.0	●	1	
412-12-05-L60	4	12	12	60	14	-	5.0	●	1	
412-16-05-L100	4	12	16	100	34	26	5.0	●	2	
413-12-05	4	13	12	80	12	-	5.0	●	1	
414-12-05	4	14	12	80	10	-	5.0	●	1	
514-14-05-L90	5	14	14	90	15	-	5.0	●	1	

► Cutter body for '-HF' insert should be modified with body corner radius 1.8 mm

Spare parts

Designation	Screw	Wrench			
2S-TE90CV-05	TS 18033/HG-P	TD 6P			

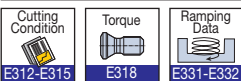

2S-TE90CV-M(S)-05



Modular heads

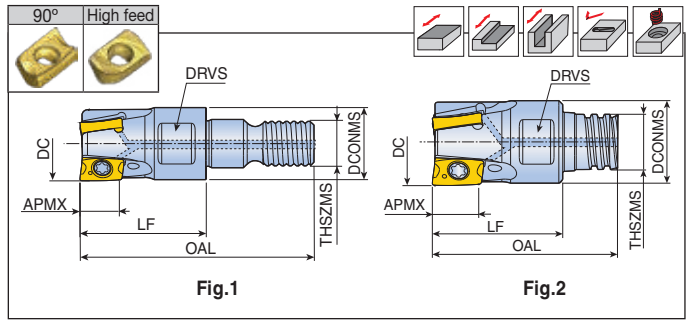
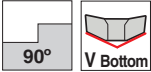

Designation	Recycling	Dimension (mm)							Coolant hole	Fig.	Insert
		DC	DCONMS	LF	OAL	THSZMS	APMX	DRVS			
2S-TE90CV- 208-M04-05	2	8	7.8	10	21.5	M04	5.0	6	●	1	CVK(H)T 0502... E273
310-M06-05	3	10	9.7	17	31.5	M06	5.0	8	●	1	
412-M06-05	4	12	11	17	31.5	M06	5.0	8	●	1	
516-M08-05	5	16	13	23	40.5	M08	5.0	10	●	1	
620-M10-05	6	20	18	23	43.0	M10	5.0	15	●	1	
720-M10-05	7	20	18	23	43.0	M10	5.0	15	●	1	
2S-TE90CV- 208-S05-05	2	8	7.6	10	16.7	S05	5.0	5.5	●	2	
310-S06-05	3	10	9.6	15	21.3	S06	5.0	8	●	2	
412-S08-05	4	12	11.5	16	23.5	S08	5.0	10	●	2	

- ▶ Cutter body for '-HF' insert should be modified with body corner radius 1.8 mm
- ▶ Matched with T-FLEXTEC holder (Fig.1) & MAXI-RUSH holder (Fig.2)

Spare parts

Designation	Screw	Wrench			
	2S-TE90CV-05	TS 18033/HG-P	TD 6P		

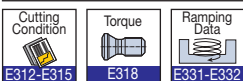

4T-MTE90-05



End mills

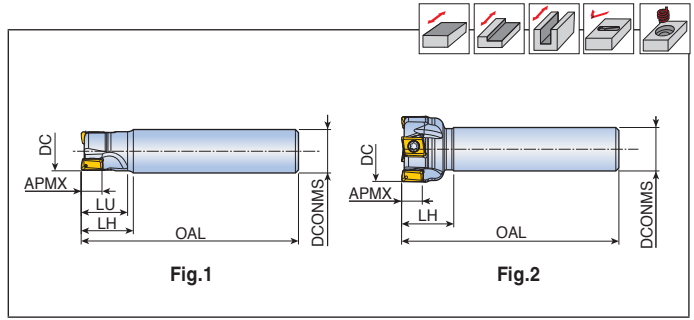

Designation	✳	Dimension (mm)						Fig.	Insert
		DC	DCONMS	OAL	LU	LH	APMX		
4T-MTE90- 210-10-05	2	10	10	50	10	12	4.6	1	LPHU 0502...
212-10-05	2	12	10	50	-	12	4.6	2	E276
314-10-05	3	14	10	50	-	12	4.6	2	
416-10-05	4	16	10	50	-	12	4.6	2	
420-10-05	4	20	10	50	-	12	4.6	2	
520-12-05	5	20	12	60	-	12	4.6	2	
430-10-05	4	30	10	50	-	12	4.6	2	
630-12-05	6	30	12	60	-	12	4.6	2	

Spare parts

Designation	Screw	Wrench			
4T-MTE90-05 (Ø10)	TS 18041/SG-P	TD 6P			
4T-MTE90-05 (Ø12-)	TS 18049/HG-P	TD 6P			

 Cutting Condition E312-E315	 Torque E318	 Ramping Data E333
------------------------------------	--------------------	--------------------------

End mills

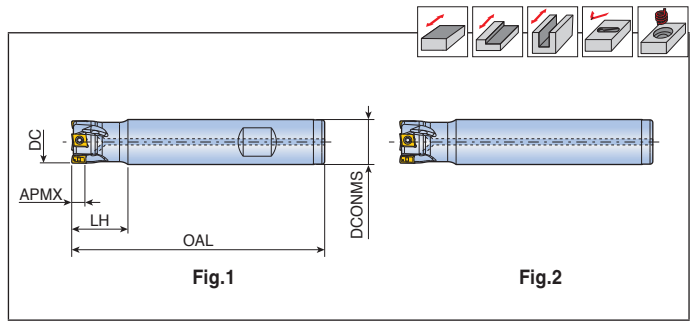

Designation		Dimension (mm)					Coolant hole	Fig.	Insert
		DC	DCONMS	OAL	LH	APMX			
4T-TE90-210-10-05	2	10	10	80	15	4.6	●	2	LPK(H)U 0502... E276
211-10-05	2	11	10	80	15	4.6	●	2	
212-12-05	2	12	12	80	15	4.6	●	2	
312-12-05	3	12	12	80	15	4.6	●	2	
313-12-05	3	13	12	80	15	4.6	●	2	
316-W16-05	3	16	16	90	20	4.6	●	1	
416-W16-05	4	16	16	90	20	4.6	●	1	
420-W20-05	4	20	20	100	25	4.6	●	1	
520-W20-05	5	20	20	100	25	4.6	●	1	
625-W25-05	6	25	25	110	30	4.6	●	1	
832-W25-05	8	32	25	110	20	4.6	●	1	
4T-TE90-220-W20-09	2	20	20	100	30	8.3	●	1	LPK(H)U 0904... E276
220-20-09-L170	2	20	20	170	30	8.3	●	2	
320-W20-09	3	20	20	100	30	8.3	●	1	
325-W25-09	3	25	25	100	30	8.3	●	1	
325-25-09-L200	3	25	25	200	30	8.3	●	2	
425-W25-09	4	25	25	100	30	8.3	●	1	
425-25-09-L120	4	25	25	120	30	8.3	●	2	
332-W32-09	3	32	32	110	35	8.3	●	1	
332-32-09-L210	3	32	32	210	35	8.3	●	2	
532-W32-09	5	32	32	110	35	8.3	●	1	
532-32-09-L130	5	32	32	130	35	8.3	●	2	
440-W32-09	4	40	32	115	30	8.3	●	1	
440-32-09-L150	4	40	32	150	30	8.3	●	2	
640-W32-09	6	40	32	115	30	8.3	●	1	

Spare parts

Designation	Screw	Wrench		Wrench handle	
4T-TE90-05 (Ø10,Ø11)	TS 18041/SG-P	TD 6P	-	-	
4T-TE90-05 (Ø12-)	TS 18049/HG-P	TD 6P	-	-	
4T-TE90-09	TS 30D082-P	-	TBLD T08P-W4	THND 4W	

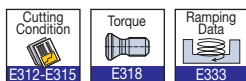

Modular heads

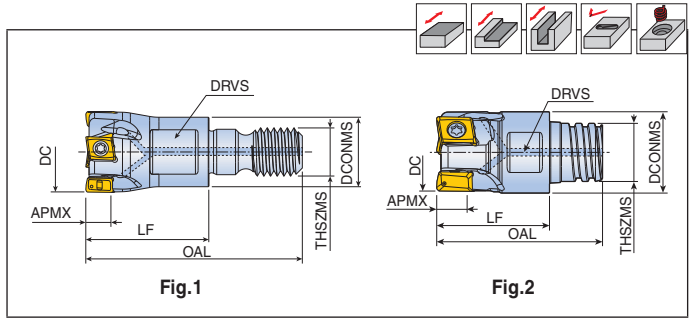

Designation		Dimension (mm)							Coolant hole	Fig.	Insert
		DC	DCONMS	LF	OAL	THSZMS	APMX	DRVS			
4T-TE90-210-M06-05	2	10	9.7	17	31.5	M06	4.6	8	●	1	LPK(H)U 0502... E276
312-M06-05	3	12	11	17	31.5	M06	4.6	8	●	1	
416-M08-05	4	16	13	23	40.5	M08	4.6	10	●	1	
520-M10-05	5	20	18	23	43	M10	4.6	15	●	1	
625-M12-05	6	25	21	27	49	M12	4.6	17	●	1	
832-M16-05	8	32	29	27	52	M16	4.6	25	●	1	
4T-TE90-210-S06-05	2	10	9.6	15	21.3	S06	4.6	8	●	2	LPK(H)U 0904... E276
312-S08-05	3	12	11.5	16	23.5	S08	4.6	10	●	2	
416-S10-05	4	16	15.2	20	31.3	S10	4.6	13	●	2	
4T-TE90-220-M10-09	2	20	18	30	50	M10	8.3	15	●	1	LPK(H)U 0904... E276
320-M10-09	3	20	18	30	50	M10	8.3	15	●	1	
425-M12-09	4	25	21	35	57	M12	8.3	17	●	1	
532-M16-09	5	32	29	43	68	M16	8.3	25	●	1	
640-M16-09	6	40	29	43	68	M16	8.3	25	●	1	

▶ Matched with T-FLEXTEC holder(Fig.1) & MAXI-RUSH holder(Fig.2)

Spare parts

Designation	Screw	Wrench		Wrench handle	
4T-TE90-05 (Ø10,Ø11)	TS 18041/SG-P	TD 6P	-	-	
4T-TE90-05 (Ø12-)	TS 18049/HG-P	TD 6P	-	-	
4T-TE90-09	TS 30D082-P	-	TBLD T08P-W4	THND 4W	

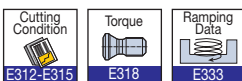

3P-TE90-04

End mills

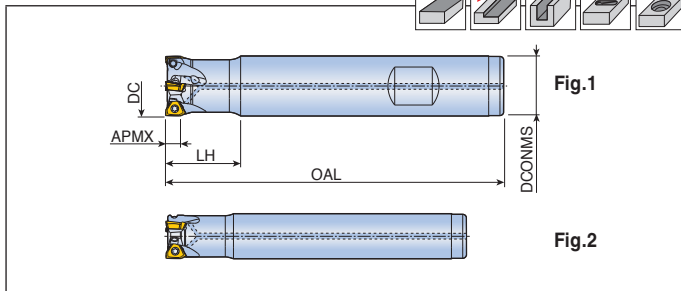
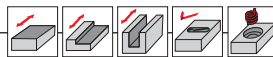

Designation	Flutes	Dimension (mm)					Coolant hole	Fig.	Insert
		DC	DCONMS	OAL	LH	APMX			
3P-TE90-108-08-04	1	8	8	80	17	3.5	●	2	3PKT 0402...
210-10-04	2	10	10	80	17	3.5	●	2	E250
210-09-04-L	2	10	9	120	10	3.5	●	2	
211-10-04	2	11	10	80	11	3.5	●	2	
212-11-04-L	2	12	11	120	11	3.5	●	2	
212-12-04	2	12	12	80	18	3.5	●	2	
212-12-04-L	2	12	12	120	18	3.5	●	2	
312-12-04	3	12	12	80	18	3.5	●	2	
313-12-04	3	13	12	90	11	3.5	●	2	
314-12-04	3	14	12	90	12	3.5	●	2	
316-16-04	3	16	16	110	20	3.5	●	2	
416-W16-04	4	16	16	90	20	3.5	●	1	

Spare parts

Designation	Screw	Wrench			
3P-TE90-04 (Ø8)	TS 18033/HG-P	TD 6P			
3P-TE90-04 (Ø10-)	TS 18041I/HG	TD 6P			

<p>Cutting Condition</p> <p>E312-E315</p>	<p>Torque</p> <p>E318</p>	<p>Ramping Data</p> <p>E335-E337</p>
---	---------------------------	--------------------------------------

3P TE90-06



End mills

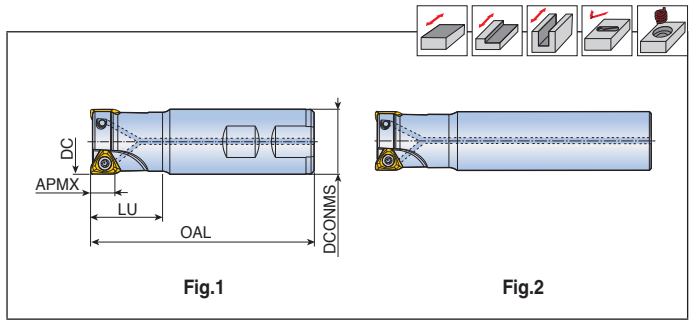

Designation		Dimension (mm)					Coolant hole	Fig.	Insert
		DC	DCONMS	OAL	LU	APMX			
3P TE90-112-12-06-L80	1	12	12	80	20	4.7	●	2	3PK(H)T 0603... E250
114-12-06-L80	1	14	12	80	20	4.7	●	2	
216-W16-06	2	16	16	90	25	4.7	●	1	
216-16-06-L110	2	16	16	110	25	4.7	●	2	
216-16-06-L150	2	16	16	150	25	4.7	●	2	
316-16-06-L110	3	16	16	110	25	4.7	●	2	
217-16-06-L200	2	17	16	200	25	4.7	●	2	
317-16-06-L110	3	17	16	110	25	4.7	●	2	
318-W16-06	3	18	16	90	25	4.7	●	1	
318-16-06-L150	3	18	16	150	25	4.7	●	2	
319-16-06-L150	3	19	16	150	25	4.7	●	2	
320-W20-06	3	20	20	105	25	4.7	●	1	
320-20-06-L160	3	20	20	160	25	4.7	●	2	
420-W20-06	4	20	20	105	25	4.7	●	1	
420-19-06-L160	4	20	19	160	25	4.7	●	2	
421-20-06-L160	4	21	20	160	25	4.7	●	2	
422-W20-06	4	22	20	110	25	4.7	●	1	
425-W20-06	4	25	20	115	25	4.7	●	1	
525-W20-06	5	25	20	115	25	4.7	●	1	
525-W25-06	5	25	25	115	25	4.7	●	1	
630-W25-06	6	30	25	130	30	4.7	●	1	
632-W25-06	6	32	25	130	30	4.7	●	1	
732-W25-06	7	32	25	130	30	4.7	●	1	
840-W32-06	8	40	32	130	30	4.7	●	1	

Spare parts

Designation	Screw	Wrench			
	3P TE90-06	TS 20043I/HG-P	TD 6P		

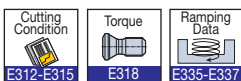

3P TE90-10



End mills

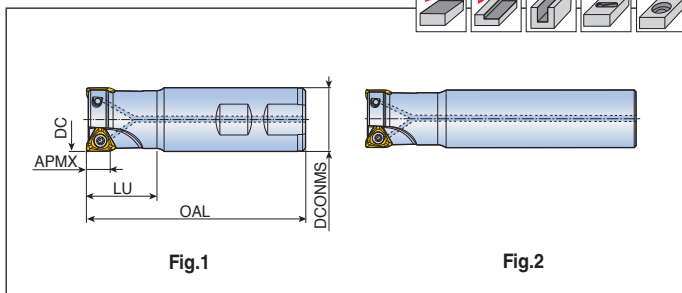
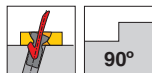
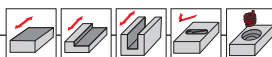

Designation	⊕	Dimension (mm)					Coolant hole	Fig.	Insert
		DC	DCONMS	OAL	LU	APMX			
3P TE90-116-16-10-L150	1	16	16	150	25	7.0	●	2	3PK(H)T 1004... E250
116-W16-10	1	16	16	90	20	7.0	●	1	
220-W20-10	2	20	20	90	25	7.0	●	1	
220-19-10-L170	2	20	19	170	30	7.0	●	2	
220-20-10-L170	2	20	20	170	40	7.0	●	2	
221-20-10-L200	2	21	20	200	30	7.0	●	2	
221-20-10-L250-C	2	21	20	250	40	7.0	●	2	
222-W20-10	2	22	20	100	25	7.0	●	1	
225-25-10-L210	2	25	25	210	40	7.0	●	2	
325-W20-10	3	25	20	100	30	7.0	●	1	
325-W25-10	3	25	25	100	30	7.0	●	1	
325-24-10-L210	3	25	24	210	35	7.0	●	2	
325-25-10-L210	3	25	25	210	40	7.0	●	2	
226-25-10-L250	2	26	25	250	30	7.0	●	2	
330-W25-10	3	30	25	110	35	7.0	●	1	
232-W25-10	2	32	25	110	35	7.0	●	1	
332-W25-10	3	32	25	110	35	7.0	●	1	
333-32-10-L250	3	33	32	250	35	7.0	●	2	
333-32-10-L300-C	3	33	32	300	60	7.0	●	2	
432-W32-10	4	32	32	110	40	7.0	●	1	
440-32-10-L200	4	40	32	200	40	7.0	●	2	
532-W32-10	5	32	32	110	40	7.0	●	1	
540-W32-10	5	40	32	115	40	7.0	●	1	
640-W32-10	6	40	32	115	40	7.0	●	1	

Spare parts

Designation	Screw	Wrench			
	3P TE90-10	TS 25C065I/HG	TD 8		

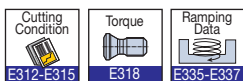

3P TE90-15/19



End mills

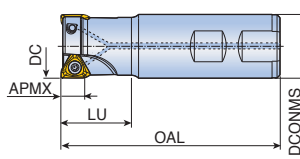
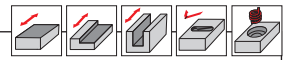
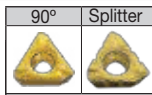

Fig.1



Fig.2



Designation	Flutes	Dimension (mm)					Coolant hole	Fig.	Insert
		DC	DCONMS	OAL	LU	APMX			
3P TE90-232-W32-15	2	32	32	110	40	11.0	●	1	3PK(H)T 1505... E250-E251
232-32-15-L250	2	32	32	250	60	11.0	●	2	
332-W25-15	3	32	25	100	40	11.0	●	1	
332-W25-15-L155	3	32	25	155	35	11.0	●	2	
332-W32-15	3	32	32	110	40	11.0	●	1	
332-32-15-L150	3	32	32	150	40	11.0	●	2	
332-32-15-L250	3	32	32	250	60	11.0	●	2	
233-32-15-L200	2	33	32	200	40	11.0	●	2	
233-32-15-L250	2	33	32	250	40	11.0	●	2	
335-W32-15	3	35	32	110	40	11.0	●	1	
340-W32-15	3	40	32	110	40	11.0	●	1	
340-32-15-L200	3	40	32	200	40	11.0	●	2	
440-W32-15	4	40	32	110	40	11.0	●	1	
3P TE90-240-32-19-L250	2	40	32	250	45	15.0	●	2	
340-W32-19	3	40	32	115	45	15.0	●	1	
340-32-19-L200	3	40	32	200	45	15.0	●	2	
450-W32-19	4	50	32	115	45	15.0	●	1	

Spare parts

Designation	Screw	Wrench			
3P TE90-15	TS 40B100I	TD 15	-		
3P TE90-19	TS 45120I	-	T-T20		

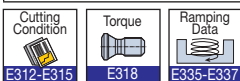

3P-TE90-M(S)-04/06



Modular heads

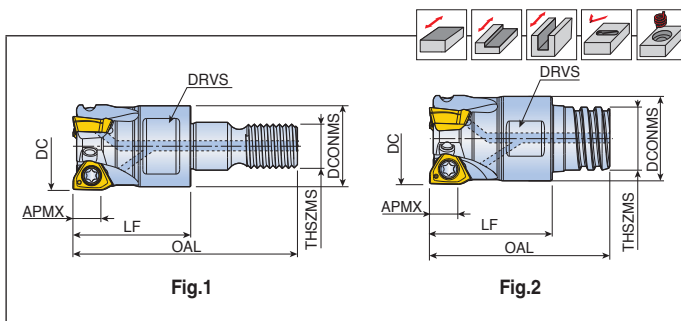

Designation	⊙	Dimension (mm)								Coolant hole	Fig.	Insert
		DC	DCONMS	LF	OAL	THSZMS	APMX	DRVS				
3P-TE90-210-M06-04	2	10	9.7	17	31.5	M06	3.5	8	●	1	3PKT 0402...	
312-M06-04	3	12	11	17	31.5	M06	3.5	8	●	1	E250	
416-M06-04	4	16	13	23	40.5	M08	3.5	10	●	1		
3P-TE90-210-S06-04	2	10	9.6	15	21.3	S06	3.5	8	●	2		
312-S08-04	3	12	11.5	16	23.5	S08	3.5	10	●	2		
416-S10-04	4	16	15.2	20	31.3	S10	3.5	13	●	2		
3P TE90-216-M08-06	2	16	13	23	40.5	M08	4.7	10	●	1	3PK(H)T 0603...	
217-M08-06	2	17	13	23	40.5	M08	4.7	10	●	1	E250	
320-M10-06	3	20	18	35	55	M10	4.7	15	●	1		
420-M10-06	4	20	18	35	55	M10	4.7	15	●	1		
425-M12-06	4	25	21	35	57	M12	4.7	17	●	1		
525-M12-06	5	25	21	35	57	M12	4.7	17	●	1		
632-M16-06	6	32	29	43	68	M16	4.7	25	●	1		
732-M16-06	7	32	29	43	68	M16	4.7	25	●	1		
735-M16-06	7	35	29	43	68	M16	4.7	25	●	1		

► Matched with T-FLEXTEC holder(Fig.1) & MAXI-RUSH holder(Fig.2)

Spare parts

Designation	Screw	Wrench			
3P-TE90-04 (∅8)	TS 18033/HG-P	TD 6P			
3P-TE90-04 (∅10-)	TS 18041/HG	TD 6P			
3P TE90-06	TS 20043/HG-P	TD 6P			

 Cutting Condition E312-E315	 Torque E318	 Ramping Data E335-E337
------------------------------------	--------------------	-------------------------------

3P TE90-M-10/15/19



Modular heads

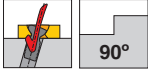
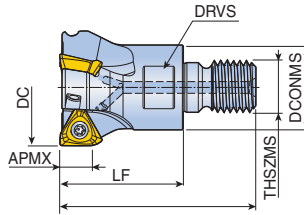
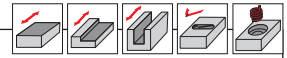
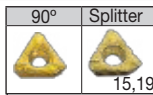

Designation	⊕	Dimension (mm)								Coolant hole	Insert
		DC	DCONMS	LF	OAL	THSZMS	APMX	DRVS			
3P TE90-220-M10-10	2	20	18	35	55	M10	7.0	15	●	3PK(H)T 1004...	
221-M10-10	2	21	18	35	55	M10	7.0	15	●	🔊 E250	
325-M12-10	3	25	21	35	57	M12	7.0	17	●		
326-M12-10	3	26	21	35	57	M12	7.0	17	●		
432-M16-10	4	32	29	43	68	M16	7.0	25	●		
532-M16-10	5	32	29	43	68	M16	7.0	25	●		
535-M16-10	5	35	29	43	68	M16	7.0	25	●		
540-M16-10	5	40	29	43	68	M16	7.0	25	●		
640-M16-10	6	40	29	43	68	M16	7.0	25	●		
642-M16-10	6	42	29	43	68	M16	7.0	25	●		
3P TE90-232-M16-15	2	32	29	43	68	M16	11.0	25	●	3PK(H)T 1505...	
233-M16-15	2	33	29	43	68	M16	11.0	25	●	🔊 E250-E251	
332-M16-15	3	32	29	43	68	M16	11.0	25	●		
340-M16-15	3	40	29	43	68	M16	11.0	25	●		
440-M16-15	4	40	29	43	68	M16	11.0	25	●		
3P TE90-340-M16-19	3	40	29	43	68	M16	15.0	25	●	3PK(H)T 1906...	
										🔊 E250-E251	

► Matched with T-FLEXTEC holder

Spare parts

Designation	Screw	Wrench			
3P TE90-10	TS 25C065I/HG	TD 8	-		
3P TE90-15	TS 40B100I	TD 15	-		
3P TE90-19	TS 45120I	-	T-T20		

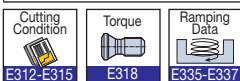

End Mills

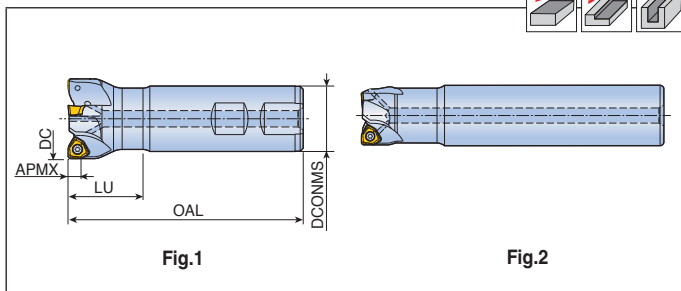
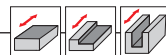

Designation		Dimension (mm)					Coolant hole	Fig.	Insert
		DC	DCONMS	OAL	LU	APMX			
6N TE90-320-W20-04	3	20	20	90	30	4.1	●	1	6N KU 0403...
320-20-04-L160	3	20	20	160	30	4.1	●	2	
425-25-04-L170	4	25	25	170	30	4.1	●	2	
525-W25-04	5	25	25	100	35	4.1	●	1	
332-W32-04	3	32	32	110	43	4.1	●	1	
532-32-04-L200	5	32	32	200	40	4.1	●	2	
632-W32-04	6	32	32	110	40	4.1	●	1	
440-W32-04	4	40	32	110	43	4.1	●	1	
6N TE90-225-W25-06	2	25	25	100	30	6.2	●	1	6N GU 0604...
225-25-06-L150	2	25	25	150	30	6.2	●	2	
232-W32-06	2	32	32	110	40	6.2	●	1	
232-32-06-L160	2	32	32	160	40	6.2	●	2	
332-W32-06	3	32	32	110	40	6.2	●	1	
332-32-06-L160	3	32	32	160	40	6.2	●	2	
332-32-06-L200	3	32	32	200	44	6.2	●	2	
340-W32-06	3	40	32	115	40	6.2	●	1	
340-32-06-L200	3	40	32	200	40	6.2	●	2	
440-W32-06	4	40	32	115	40	6.2	●	1	
6N TE90-232-W32-09	2	32	32	110	40	9.2	●	1	6N GU 0905...
232-32-09-L160	2	32	32	160	60	9.2	●	2	
340-W32-09	3	40	32	120	40	9.2	●	1	
340-32-09-L200	3	40	32	200	40	9.2	●	2	
440-W32-09	4	40	32	120	40	9.2	●	1	

Spare parts

Designation	Screw	Wrench			
6N TE90-04	TS 25064I	TD 8			
6N TE90-06	TS 30085I/HG	TD 9			
6N TE90-09	TS 40B100I	TD15			



Modular heads

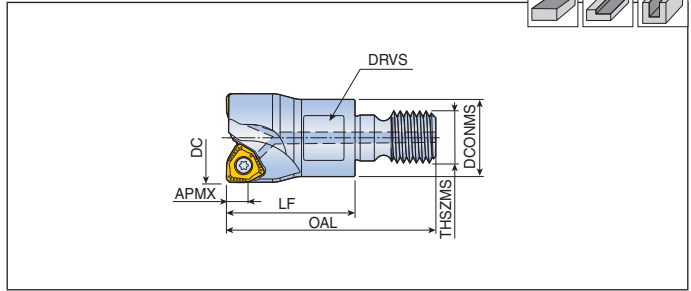

Designation		Dimension (mm)							Coolant hole	Insert
		DC	DCONMS	LF	OAL	THSZMS	APMX	DRVS		
6N TE90-320-M10-04	3	20	18	35	55	M10	4.1	15	●	6N KU 0403...
525-M12-04	5	25	21	35	57	M12	4.1	17	●	E256
632-M16-04	6	32	29	43	68	M16	4.1	25	●	
6N TE90-225-M12-06	2	25	21	35	57	M12	6.2	17	●	6N GU 0604...
332-M16-06	3	32	29	43	68	M16	6.2	25	●	E255
440-M16-06	4	40	29	43	68	M16	6.2	25	●	
6N TE90-232-M16-09	2	32	29	43	68	M16	9.2	25	●	6N GU 0905...
340-M16-09	3	40	29	43	68	M16	9.2	25	●	E255
440-M16-09	4	40	29	43	68	M16	9.2	25	●	

► Matched with T-FLEXTEC holder

Spare parts

Designation	Screw	Wrench			
6N TE90-04	TS 25064I	TD 8			
6N TE90-06	TS 30085I/HG	TD 9			
6N TE90-09	TS 40B100I	TD 15			

 Cutting Condition E312-E315	 Torque E318
------------------------------------	--------------------

SCRM90TN-18/SCRM90TN-M-18



End Mills & Modular heads

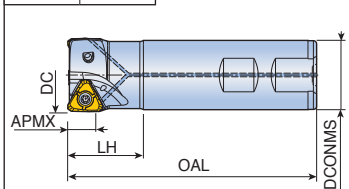
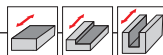
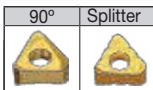
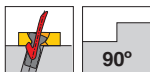

Fig.1

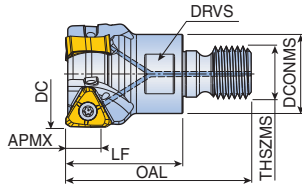

Fig.2

Designation	Flutes	Dimension (mm)								Coolant hole	Fig.	Insert
		DC	DCONMS	OAL	LH	LF	THSZMS	APMX	DRVS			
SCRM90TN 235-W32-18	2	35	32	115	35	-	-	13.0	-	•	1	TNMX 1806... E302
340-W32-18	3	40	32	115	35	-	-	13.0	-	•	1	
SCRM90TN 235-M16-18	2	35	29	68	-	43	M16	13.0	25	•	2	
340-M16-18	3	40	29	68	-	43	M16	13.0	25	•	2	

► Matched with T-FLEXTEC holder(Fig.2)

Spare parts

Designation	Screw	Wrench			
	SCRM90TN-18	 TS 40B100I	 T-T15		



TE90AV-10



End mills

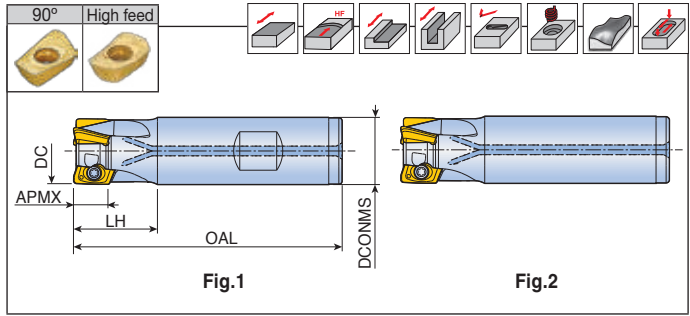
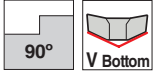

Designation		Dimension (mm)					Coolant hole	Fig.	Insert
		DC	DCONMS	OAL	LH	APMX			
TE90AV- 216-W16-10	2	16	16	75	20	10	●	1	AVKT 10-M/EL
218-W16-10	2	18	16	90	25	10	●	1	AVKT 10-HF
320-20-10-L120	3	20	20	120	40	10	●	2	AVCT 10-AL
320-W20-10	3	20	20	80	25	10	●	1	E267
325-W25-10	3	25	25	90	30	10	●	1	
425-W25-10	4	25	25	90	30	10	●	1	
532-W32-10	5	32	32	100	35	10	●	1	

- ▶ When using the 'AVKT 1004R-HF' insert, the cutter body needs to be modified to a corner radius of 3.0 mm
- ▶ When using 'AVKT 10' insert with a corner radius of 2.0 mm or bigger, the cutter body corner radius should be adjusted to insert "R" + 0.2 mm

Spare parts

Designation	Screw	Wrench			
	TE90AV-10	TS 30B062/HG-P	TD 8P		

Cutting Condition
E312-E315

Torque
E318

Ramping Data
E329-E330

TE90AV-M-10



Modular heads

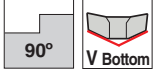
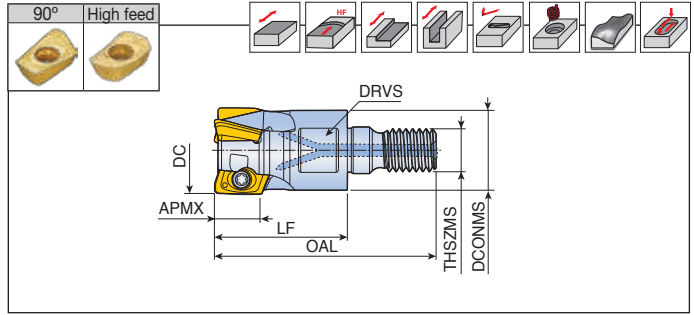

Designation		Dimension (mm)							Coolant hole	Insert
		DC	DCONMS	LF	OAL	THSZMS	APMX	DRVS		
TE90AV-216-M08-10	2	16	13	30	47.5	M08	10	10	●	AVKT 10-M/EL AVKT 10-HF AVCT 10-AL E267
320-M10-10	3	20	18	30	50	M10	10	15	●	
425-M12-10	4	25	21	35	57	M12	10	17	●	
532-M16-10	5	32	29	43	68	M16	10	25	●	

- ▶ When using the 'AVKT 1004R-HF' insert, the cutter body needs to be modified to a corner radius of 3.0 mm
- ▶ When using 'AVKT 10' insert with a corner radius of 2.0 mm or bigger, the cutter body corner radius should be adjusted to insert "R" + 0.2 mm
- ▶ Matched with T-FLEXTEC holder

Spare parts

Designation	Screw	Wrench			
	TE90AV-M-10	TS 30B062/HG-P	TD 8P		

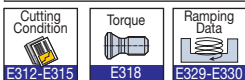

MTE90AX-06-L



End mills

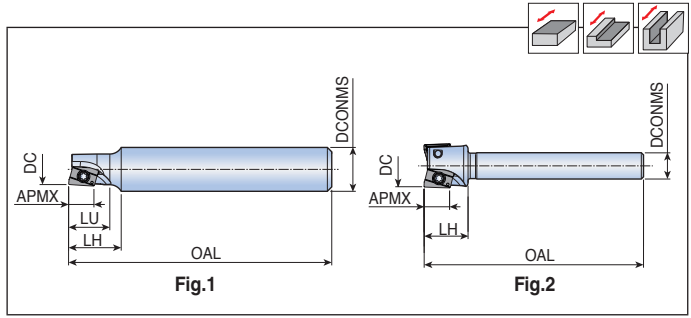

Designation	⌀	Dimension (mm)						Fig.	Insert
		DC	DCONMS	OAL	LU	LH	APMX		
MTE90AX 108-10-06-L60	1	8	10	60	9	12	5.5	1	AXCT 06-L... E265
210-05-06-L40	2	10	5	40	-	10	5.5	2	
210-06-06-L50	2	10	6	50	-	10	5.5	2	
210-07-06-L50	2	10	7	50	-	10	5.5	2	
210-10-06-L50	2	10	10	50	10	12	5.5	1	
212-10-06-L50	2	12	10	50	-	10	5.5	2	
214-10-06-L50	2	14	10	50	-	10	5.5	2	
315-05-06-L40	3	15	5	40	-	10	5.5	2	
316-07-06-L50	3	16	7	50	-	10	5.5	2	
316-10-06-L50	3	16	10	50	-	10	5.5	2	
320-07-06-L50	3	20	7	50	-	10	5.5	2	
320-10-06-L50	3	20	10	50	-	10	5.5	2	
530-10-06-L50	5	30	10	50	-	10	5.5	2	

▶ Cutter body for 'AXMT 06' insert with corner radius more than 1.0mm should be modified accordingly body "RE"=Insert "RE"-0.1mm

Spare parts

Designation	Screw	Wrench			
	MTE90AX-06-L	TS 180411/HG	TD 6P		



TE90AX-06



End mills

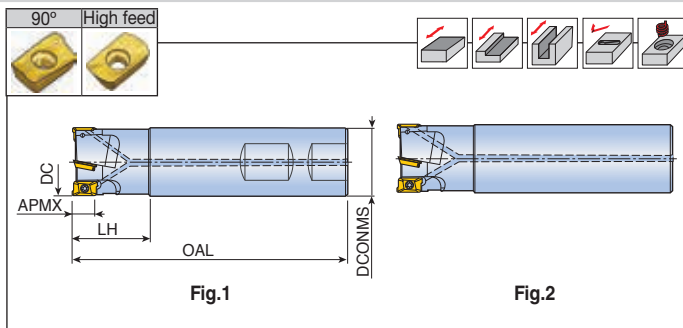

Designation	⌀	Dimension (mm)					Coolant hole	Fig.	Insert
		DC	DCONMS	OAL	LH	APMX			
TE90AX 108-08-06-C	1	8	8	80	17	5.5	●	2	AXM(C)T 0602 ... E264-E266
210-09-06-L120	2	10	9	120	17	5.5	x	2	
210-10-06-C	2	10	10	80	17	5.5	●	2	
211-10-06	2	11	10	80	17	5.5	x	2	
212-12-06-C	2	12	12	80	18	5.5	●	2	
212-12-06-L	2	12	12	130	18	5.5	x	2	
212-11-06-L120	2	12	11	120	20	5.5	x	2	
312-12-06-C	3	12	12	80	18	5.5	●	2	
313-12-06-C	3	13	12	90	20	5.5	●	2	
314-12-06	3	14	12	80	18	5.5	x	2	
415-12-06	4	15	12	80	18	5.5	x	2	
316-16-06-C	3	16	16	110	20	5.5	●	2	
316-16-06-L	3	16	16	150	20	5.5	x	2	
416-W16-06-C	4	16	16	90	20	5.5	●	1	
417-16-06	4	17	16	90	20	5.5	x	2	
418-W16-06-C	4	18	16	90	20	5.5	●	1	
418-16-06-L	4	18	16	150	20	5.5	x	2	
419-W16-06	4	19	16	90	20	5.5	x	1	
420-20-06	4	20	20	160	25	5.5	x	2	
420-W20-06-C	4	20	20	160	25	5.5	●	1	
520-19-06-L	5	20	19	160	25	5.5	x	1	
520-W20-06-C	5	20	20	105	25	5.5	●	1	
521-20-06	5	21	20	105	25	5.5	x	2	
725-W20-06-C	7	25	20	115	25	5.5	●	1	
725-W25-06	7	25	25	120	30	5.5	x	1	
832-W25-06-C	8	32	25	130	32	5.5	●	1	
1040-W32-06-C	10	40	32	140	40	5.5	●	1	

<p>Cutting Condition</p> <p>E312-E315</p>	<p>Torque</p> <p>E318</p>	<p>Ramping Data</p> <p>E360-E366</p>
---	---------------------------	--------------------------------------

TE90AX-M(S)-06



Modular heads

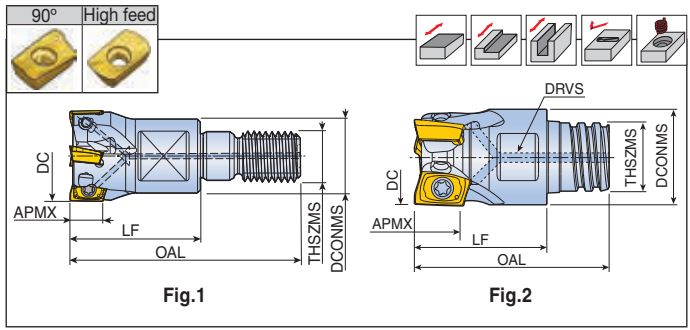

Designation		Dimension (mm)							Coolant hole	Fig.	Insert
		DC	DCONMS	LF	OAL	THSZMS	APMX	DRVS			
TE90AX 210-M06-06	2	10	9.7	17	31.5	M06	5.5	8	●	1	AXM(C)T 0602...
312-M06-06	3	12	11	17	31.5	M06	5.5	8	●	1	E264-E266
416-M08-06	4	16	13	23	40.5	M08	5.5	10	●	1	
520-M10-06	5	20	18	23	43	M10	5.5	15	●	1	
725-M12-06	7	25	21	27	49	M12	5.5	17	●	1	
832-M16-06	8	32	29	27	52	M16	5.5	25	●	1	
1040-M16-06	10	40	29	27	52	M16	5.5	25	●	1	
TE90AX 210-S06-06	2	10	9.6	15	21.3	S06	5.5	8	●	2	
312-S08-06	3	12	11.5	16	23.5	S08	5.5	10	●	2	
416-S10-06	4	16	15.2	20	31.3	S10	5.5	13	●	2	

- ▶ Matched with T-FLEXTEC holder(Fig.1) & MAXI-RUSH holder(Fig.2)
- ▶ Cutter body for 'AXMT 06' insert with corner radius more than 1.0mm should be modified accordingly body "RE"=Insert "RE"-0.1mm

Spare parts

Designation	Screw	Wrench			
	TE90AX-06	TS 180411/HG	TD 6P		

Cutting Condition E312-E315	Torque E318	Ramping Data E360-E366
--------------------------------	----------------	---------------------------

2S-TE90AP-09



End mills

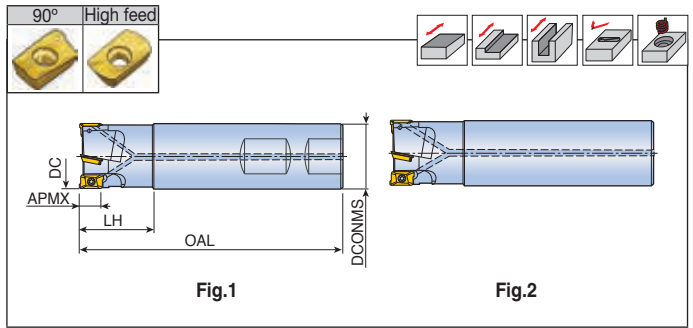

Designation	⊕	Dimension (mm)					Coolant hole	Fig.	Insert
		DC	DCONMS	OAL	LH	APMX			
2S-TE90AP 110-W10-09-C	1	10	10	80	25	8.8	●	1	APK(C)T 09T3... E259, E264
112-W12-09	1	12	12	80	25	8.8	x	1	
112-W16-09-C	1	12	16	80	26	8.8	●	1	
114-W12-09	1	14	12	80	25	8.8	x	1	
216-15-09-L	2	16	15	170	30	8.8	x	2	
216-W16-09-C	2	16	16	90	25	8.8	●	1	
216-16-09-L	2	16	16	145	30	8.8	x	2	
217-16-09-L	2	17	16	180	25	8.8	x	2	
218-W16-09-C	2	18	16	90	25	8.8	●	1	
220-19-09-L	2	20	19	170	25	8.8	x	2	
220-20-09-L	2	20	20	170	40	8.8	x	2	
320-W20-09-C	3	20	20	110	30	8.8	●	1	
221-20-09-L	2	21	20	200	25	8.8	x	2	
322-W20-09-C	3	22	20	110	30	8.8	●	1	
225-24-09-L	2	25	24	210	28	8.8	x	2	
225-25-09-L	2	25	25	210	40	8.8	x	2	
325-W20-09-C	3	25	20	110	30	8.8	●	1	
325-W25-09	3	25	25	110	30	8.8	x	1	
425-W20-09-C	4	25	20	110	30	8.8	●	1	
226-25-09-L	2	26	25	250	40	8.8	x	2	
430-W25-09-C	4	30	25	130	32	8.8	●	1	
232-32-09-L	2	32	32	250	65	8.8	x	2	
432-W25-09-C	4	32	25	130	32	8.8	●	1	
532-W25-09-C	5	32	25	130	32	8.8	●	1	
333-32-09-L	3	33	32	250	40	8.8	x	2	
240-32-09-L	2	40	32	250	32	8.8	x	2	
540-W32-09-C	5	40	32	130	32	8.8	●	1	
640-W32-09	6	40	32	130	32	8.8	x	1	

<p>Cutting Condition</p> <p>E312-E315</p>	<p>Torque</p> <p>E318</p>	<p>Ramping Data</p> <p>E360-E366</p>
---	---------------------------	--------------------------------------

2S-TE90AP-M-09



Modular heads

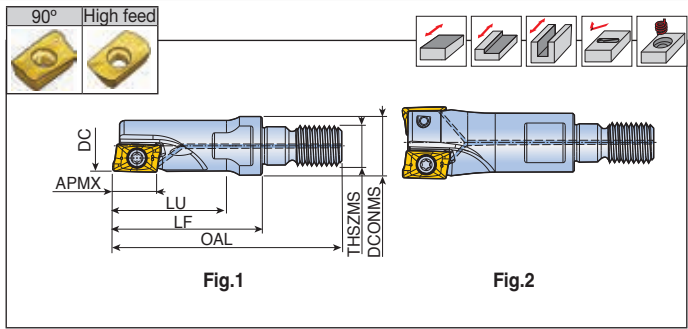

Designation	⌀	Dimension (mm)							Coolant hole	Fig.	Insert
		DC	DCONMS	LF	OAL	LU	THSZMS	APMX			
2S-TE90AP 110-M06-09	1	10	9.7	33	47.5	19	M06	8.8	●	1	APK(C)T 09T3... E259, E264
112-M08-09	1	12	13	33	50.5	25	M08	8.8	●	1	
216-M08-09	2	16	13	38	50.5	-	M08	8.8	●	2	
320-M10-09	3	20	18	38	58	-	M10	8.8	●	2	
325-M12-09	3	25	21	38	60	-	M12	8.8	●	2	
425-M12-09	4	25	21	38	60	-	M12	8.8	●	2	
432-M16-09	4	32	29	38	63	-	M16	8.8	●	2	
532-M16-09	5	32	29	38	63	-	M16	8.8	●	2	
540-M16-09	5	40	29	43	68	-	M16	8.8	●	2	
640-M16-09	6	40	29	43	68	-	M16	8.8	●	2	

- ▶ Matched with T-FLEXTEC holder
- ▶ Cutter body for 'APKT09' insert with corner radius more than 2.4mm should be modified accordingly
body "RE"=Insert "RE"-0.2mm

Spare parts

Designation	Screw	Wrench			
2S-TE90AP-09	TS 25055I/HG	TD 8			

 E312-E315	 E318	 E360-E366
---------------	----------	---------------

TE90AP-12



End mills

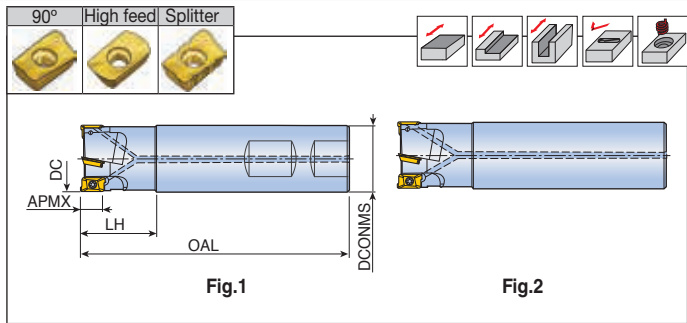

Designation	🌀	Dimension (mm)					Coolant hole	Fig.	Insert
		DC	DCONMS	OAL	LH	APMX			
TE90AP 116-W16-12-C	1	16	16	85	26	12.0	●	1	APK(C)T 1204....
218-W20-12-C	2	18	20	85	26	12.0	●	1	🔧 E260,E264
220-19-12-L	2	20	19	170	30	12.0	●	2	
220-W20-12-C	2	20	20	90	30	12.0	●	1	
220-W20-12-L-C	2	20	20	125	30	12.0	●	1	
220-20-12-L	2	20	20	170	30	12.0	●	2	
220-20-12-L200	2	20	20	200	30	12.0	●	2	
221-20-12-L200	2	21	20	200	30	12.0	●	2	
221-20-12-L250	2	21	20	250	30	12.0	●	2	
225-24-12-L	2	25	24	200	40	12.0	●	2	
225-W25-12-L-C	2	25	25	145	40	12.0	●	1	
225-25-12-L	2	25	25	210	40	12.0	●	2	
225-25-12-L200	2	25	25	200	40	12.0	●	2	
325-W25-12-C	3	25	25	100	40	12.0	●	1	
226-25-12-L200	2	26	25	200	40	12.0	●	2	
226-25-12-L250	2	26	25	250	40	12.0	●	2	
232-25-12-L	2	32	25	250	40	12.0	●	2	
332-W25-12-L-C	3	32	25	155	35	12.0	●	1	
332-W32-12-C	3	32	32	110	40	12.0	●	1	
332-32-12-L	3	32	32	250	40	12.0	●	2	
332-32-12-L150	3	32	32	150	40	12.0	●	2	
432-W25-12-C	4	32	25	100	40	12.0	●	1	
233-32-12-L200	2	33	32	200	40	12.0	●	2	
233-32-12-L250	2	33	32	250	40	12.0	●	2	
333-32-12-L200	3	33	32	200	40	12.0	●	2	
333-32-12-L250	3	33	32	250	40	12.0	●	2	
435-W25-12	4	35	25	100	40	12.0	●	1	
440-W32-12-C	4	40	32	115	45	12.0	●	1	
440-32-12-L	4	40	32	250	40	12.0	●	2	
540-W32-12-C	5	40	32	115	45	12.0	●	1	

Cutting Condition E312-E315	Torque E318	Ramping Data E360-E366
--------------------------------	----------------	---------------------------

TE90AP-M-12



Modular heads

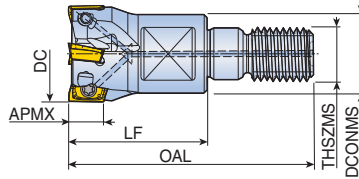
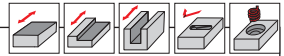

Designation	⊕	Dimension (mm)						Coolant hole	Insert
		DC	DCONMS	LF	OAL	THSZMS	APMX		
TE90AP 116-M08-12	1	16	13	35	52.5	M08	12.0	●	APK(C)T 1204...
220-M10-12	2	20	18	35	55	M10	12.0	●	⊕ E260, E264
325-M12-12	3	25	21	35	57	M12	12.0	●	
432-M16-12	4	32	29	43	68	M16	12.0	●	
540-M16-12	5	40	29	43	68	M16	12.0	●	
542-M16-12	5	42	29	43	68	M16	12.0	●	

- ▶ Matched with T-FLEXTEC holder
- ▶ Cutter body for 'APKT 12' insert with corner radius more than 1.6mm should be modified accordingly
body "RE"=Insert "RE"-0.5mm

Spare parts

Designation	Screw	Wrench			
TE90AP-12 (Ø16-Ø26)	TS 35A070I/HG	TD 10P			
TE90AP-12 (Ø32-)	TS 35A088I/HG	TD 10P			

 Cutting Condition E312-E315	 Torque E318	 Ramping Data E360-E366
------------------------------------	--------------------	-------------------------------

TE90AP-17



End mills

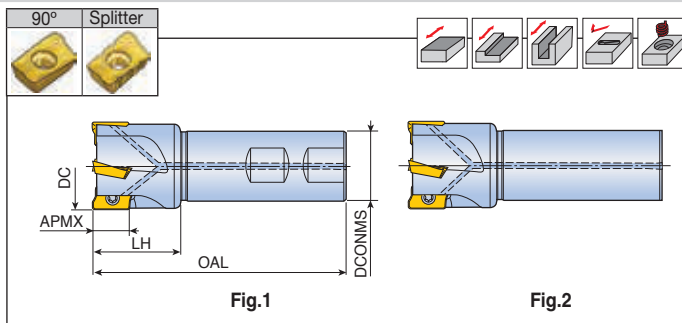

Designation	⊕	Dimension (mm)					Coolant hole	Fig.	Insert
		DC	DCONMS	OAL	LH	APMX			
TE90AP 120-W20-17-C	1	20	20	90	32	16.1	●	1	APK(C)T 1705... E261-E262
225-24-17-L	2	25	24	210	40	16.1	x	2	
225-W25-17-C	2	25	25	100	39	16.1	●	1	
225-25-17-L	2	25	25	210	40	16.1	x	2	
226-25-17-L200	2	26	25	200	40	16.1	●	2	
226-25-17-L250	2	26	25	250	40	16.1	●	2	
232-32-17-L	2	32	32	250	65	16.1	x	2	
233-32-17-L250	2	33	32	250	40	16.1	●	2	
233-32-17-L300	2	33	32	300	40	16.1	●	2	
332-W32-17-C	3	32	32	110	40	16.1	●	1	
332-32-17-L	3	32	32	200	65	16.1	x	2	
333-32-17-L200	3	33	32	200	55	16.1	●	2	
333-32-17-L250	3	33	32	250	55	16.1	●	2	
240-32-17-L	2	40	32	250	57	16.1	x	2	
340-W32-17	3	40	32	110	40	16.1	x	1	
340-32-17-L	3	40	32	200	54	16.1	x	2	
440-W32-17-C	4	40	32	115	45	16.1	●	1	
440-32-17-L	4	40	32	200	57	16.1	x	2	

► Cutter body for 'APKT 17' insert with corner radius more than 1.6mm should be modified accordingly
body "RE"=Insert "RE"-0.8mm

Spare parts

Designation	Screw	Wrench		
TE90AP-17 (Ø20-Ø25)	TS 40085I/HG	TD 15		
TE90AP-17 (Ø26-Ø63)	TS 40093I/HG	TD 15		

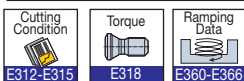

TE90AP-M-17



Modular heads

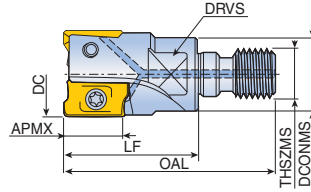
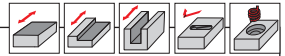

Designation		Dimension (mm)							Coolant hole	Insert
		DC	DCONMS	LF	OAL	THSZMS	APMX	DRVS		
TE90AP 120-M10-17	1	20	18	43	63	M10	16.1	15	●	APK(C)T 1705...
225-M12-17	2	25	21	43	65	M12	16.1	17	●	E261-E262
232-M16-17	2	32	29	43	68	M16	16.1	25	●	
332-M16-17	3	32	29	43	68	M16	16.1	25	●	
340-M16-17	3	40	29	43	68	M16	16.1	25	●	
440-M16-17	4	40	29	43	68	M16	16.1	25	●	

- ▶ Matched with T-FLEXTEC holder
- ▶ Cutter body for 'APKT 17' insert with corner radius more than 1.6mm should be modified accordingly
body "RE"=Insert "RE"-0.8mm

Spare parts

Designation	Screw	Wrench			
TE90AP-17 (Ø20-Ø25)	TS 40085I/HG	TD 15			
TE90AP-17 (Ø26-)	TS 40093I/HG	TD 15			

 E312-E315	 E318	 E360-E366
---------------	----------	---------------

2S-TE90AP-19



End mills

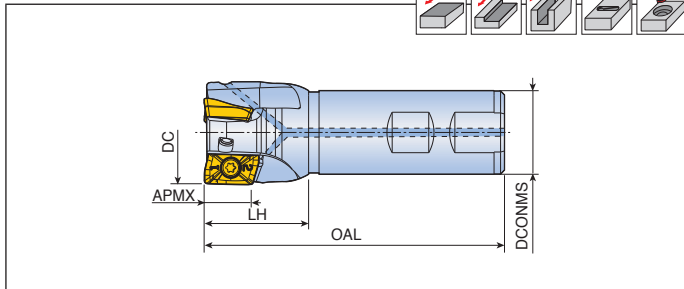
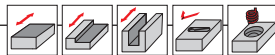

Designation	🌀	Dimension (mm)					Coolant hole	Insert
		DC	DCONMS	OAL	LH	APMX		
2S-TE90AP 340-W32-19	3	40	32	115	40	17.9	●	APKT 1907... E263

Spare parts

Designation	Screw	Wrench			
	2S-TE90AP-19	TS 501151	TD 20		



TE90AN-11/16



End mills

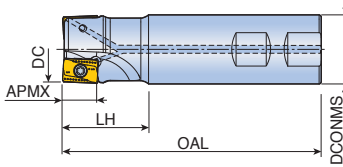
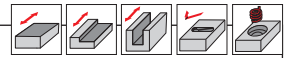

Fig.1

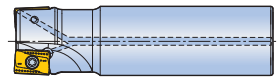

Fig.2



Designation		Dimension (mm)					Coolant hole	Fig.	Insert
		DC	DCONMS	OAL	LH	APMX			
TE90AN 225-24-11-L	2	25	24	200	40	11.0	●	2	ANM(H)X 1106... E258
225-W25-11	2	25	25	100	40	11.0	●	1	
225-25-11-L	2	25	25	200	40	11.0	●	2	
226-25-11-L	2	26	25	200	40	11.0	●	2	
332-W32-11	3	32	32	110	40	11.0	●	1	
332-32-11-L	3	32	32	200	40	11.0	●	2	
233-32-11-L	2	33	32	250	40	11.0	●	2	
333-32-11-L	3	33	32	200	40	11.0	●	2	
340-32-11-L	3	40	32	250	40	11.0	●	2	
440-W32-11	4	40	32	115	40	11.0	●	1	
440-32-11-L	4	40	32	200	40	11.0	●	2	
TE90AN 232-W32-16	2	32	32	110	30	15.0	●	1	ANM(H)X 1607... E258
232-32-16	2	32	32	150	45	15.0	●	2	
232-32-16-L250	2	32	32	250	40	15.0	●	2	
233-32-16-L200	2	33	32	200	55	15.0	●	2	
340-W32-16	3	40	32	115	35	15.0	●	1	
340-32-16	3	40	32	150	45	15.0	●	2	
340-32-16-L250	3	40	32	250	45	15.0	●	2	
450-32-16	4	50	32	150	50	15.0	●	2	

Spare parts

Designation	Screw	Wrench			
TE90AN-11	TS 35A088I/HG	TD 10P			
TE90AN-16	TS 40120I	TD 15			

 E312-E315	 E318	 E367
---------------	----------	----------

TE90AN-M-11/16



Modular heads

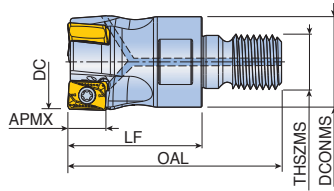
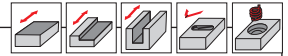
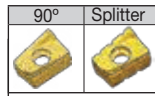

Designation		Dimension (mm)						Coolant hole	Insert
		DC	DCONMS	LF	OAL	THSZMS	APMX		
TE90AN 225-M12-11	2	25	21	35	57	M12	11.0	●	ANM(H)X 1106...
332-M16-11	3	32	29	43	68	M16	11.0	●	E258
440-M16-11	4	40	29	43	68	M16	11.0	●	
TE90AN 232-M16-16	2	32	29	43	68	M16	15.0	●	ANM(H)X 1607...
340-M16-16	3	40	29	43	68	M16	15.0	●	E258

► Matched with T-FLEXTEC holder

Spare parts

Designation	Screw	Wrench			
TE90AN-11	TS 35A088I/HG	TD 10P			
TE90AN-16	TS 40120I	TD 15			



E312-E315

E318

E367



4N TE90-04



End mills

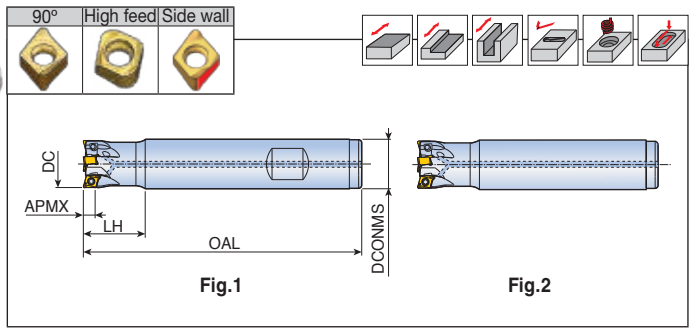

Designation		Dimension (mm)					Coolant hole	Fig.	Insert
		DC	DCONMS	OAL	LH	APMX			
4N TE90-108-08-04	1	8	8	80	17	3.5	●	2	4NKT 0402... E252-E253
210-10-04	2	10	10	80	17	3.5	●	2	
210-10-04-L55	2	10	10	55	12	3.5	●	2	
211-10-04	2	11	10	80	17	3.5	●	2	
212-12-04	2	12	12	80	18	3.5	●	2	
312-12-04	3	12	12	80	18	3.5	●	2	
312-12-04-L60	3	12	12	60	14	3.5	●	2	
313-12-04	3	13	12	90	20	3.5	●	2	
316-16-04	3	16	16	90	20	3.5	●	2	
416-W16-04	4	16	16	90	20	3.5	●	1	
416-W16-04-L68	4	16	16	68	18	3.5	●	1	
417-16-04	4	17	16	90	20	3.5	●	2	
420-20-04-L	4	20	20	160	25	3.5	●	2	
520-W20-04	5	20	20	105	25	3.5	●	1	
520-W20-04-L75	5	20	20	75	22	3.5	●	1	
725-W25-04	7	25	25	120	30	3.5	●	1	
832-W25-04	8	32	25	130	35	3.5	●	1	
1040-W32-04	10	40	32	140	40	3.5	●	1	

▶ Cutter body for '4NKT 040212R-HF' insert should be modified with body corner radius 1.2 mm

Spare parts

Designation	Screw	Wrench			
	4N TE90-04	TS 18041I/HG	TD 6P		

Cutting Condition E312-E315	Torque E318	Ramping Data E338-E359
--------------------------------	----------------	---------------------------

4N TE90-M(S)-04



Modular heads

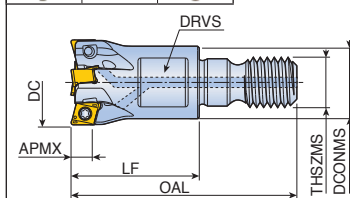
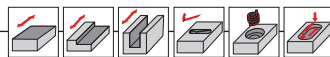

Fig.1

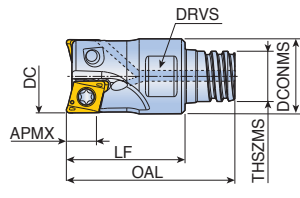

Fig.2



Designation	Z	Dimension (mm)							Coolant hole	Fig.	Insert
		DC	DCONMS	LF	OAL	THSZMS	APMX	DRVS			
4N TE90-210-M06-04	2	10	9.7	17	31.5	M06	3.5	8	●	1	4NKT 0402... E252-E253
211-M06-04	2	11	9.7	17	31.5	M06	3.5	8	●	1	
312-M06-04	3	12	11	17	31.5	M06	3.5	8	●	1	
313-M06-04	3	13	11	17	31.5	M06	3.5	8	●	1	
416-M08-04	4	16	13	23	40.5	M08	3.5	10	●	1	
417-M08-04	4	17	13	23	40.5	M08	3.5	10	●	1	
520-M10-04	5	20	18	23	43	M10	3.5	15	●	1	
725-M12-04	7	25	21	27	49	M12	3.5	17	●	1	
4N TE90-210-S06-04	2	10	9.6	15	21.3	S06	3.5	8	●	2	
312-S08-04	3	12	11.5	16	23.5	S08	3.5	10	●	2	
416-S10-04	4	16	15.2	20	31.3	S10	3.5	13	●	2	

- ▶ Cutter body for '4NKT 040212R-HF' insert should be modified with body corner radius 1.2 mm
- ▶ Matched with T-FLEXTEC holder(Fig.1) & MAXI-RUSH holder(Fig.2)

Spare parts

Designation	Screw	Wrench			
	4N TE90-04	TS 180411/HG	TD 6P		

Cutting Condition
E312-E315

Torque
E318

Ramping Data
E338-E359

4N TE90-06



End mills

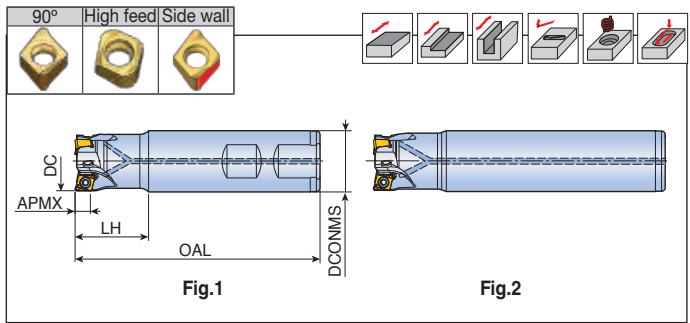

Designation	Flutes	Dimension (mm)					Coolant hole	Fig.	Insert
		DC	DCONMS	OAL	LH	APMX			
4N TE90-216-15-06-L150	2	16	15	150	25	6.0	●	2	4NK(H)T 0603..... E252-E253
216-W16-06	2	16	16	90	25	6.0	●	1	
216-16-06-L100	2	16	16	100	25	6.0	●	2	
216-16-06-L150	2	16	16	150	25	6.0	●	2	
217-16-06	2	17	16	90	25	6.0	●	2	
217-16-06-L200	2	17	16	200	25	6.0	●	2	
218-W16-06	2	18	16	90	25	6.0	●	1	
218-16-06-L150	2	18	16	150	25	6.0	●	2	
220-19-06-L160	2	20	19	160	25	6.0	●	2	
220-W20-06	2	20	20	90	25	6.0	●	1	
220-20-06-L110	2	20	20	110	25	6.0	●	2	
220-20-06-L160	2	20	20	160	25	6.0	●	2	
320-W20-06	3	20	20	90	25	6.0	●	1	
320-20-06-L110	3	20	20	110	25	6.0	●	2	
221-20-06-L200	2	21	20	200	25	6.0	●	2	
325-W25-06	3	25	25	100	30	6.0	●	1	
325-25-06-L120	3	25	25	120	30	6.0	●	2	
325-25-06-L200	3	25	25	200	30	6.0	●	2	
326-25-06-L200	3	26	25	200	30	6.0	●	2	
425-W25-06	4	25	25	100	30	6.0	●	1	
425-25-06-L120	4	25	25	120	30	6.0	●	2	
432-W32-06	4	32	32	110	35	6.0	●	1	
432-32-06-L130	4	32	32	130	35	6.0	●	2	
432-32-06-L210	4	32	32	210	35	6.0	●	2	
433-32-06-L220	4	33	32	220	35	6.0	●	2	
532-W32-06	5	32	32	110	35	6.0	●	1	
532-32-06-L130	5	32	32	130	35	6.0	●	2	
540-W32-06	5	40	32	110	40	6.0	●	1	
540-32-06-L150	5	40	32	150	40	6.0	●	2	
540-32-06-L250	5	40	32	250	40	6.0	●	2	
640-W32-06	6	40	32	110	35	6.0	●	1	
640-32-06-L150	6	40	32	150	35	6.0	●	2	

Cutting Condition
E312-E315

Torque
E318

Ramping Data
E338-E359

▶ Cutter body for '4NKT 060320R-HF' and '4NHT 060320R-F' inserts should be modified with body corner radius 2.0 mm

4N TE90-M(S)-06



Modular heads

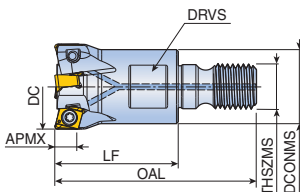
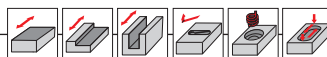

Fig.1

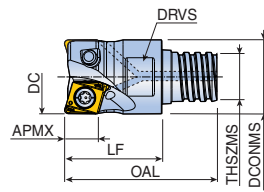

Fig.2



Designation		Dimension (mm)							Coolant hole	Fig.	Insert
		DC	DCONMS	LF	OAL	THSZMS	APMX	DRVS			
4N TE90- 216-M08-06	2	16	13	23	40.5	M08	6.0	10	●	1	4NK(H)T 0603... E252-E253
217-M08-06	2	17	13	23	40.5	M08	6.0	10	●	1	
220-M10-06	2	20	18	35	55	M10	6.0	15	●	1	
320-M10-06	3	20	18	35	55	M10	6.0	15	●	1	
321-M10-06	3	21	18	35	55	M10	6.0	15	●	1	
325-M12-06	3	25	21	35	57	M12	6.0	17	●	1	
425-M12-06	4	25	21	35	57	M12	6.0	17	●	1	
426-M12-06	4	26	21	35	57	M12	6.0	17	●	1	
432-M16-06	4	32	29	43	68	M16	6.0	25	●	1	
532-M16-06	5	32	29	43	68	M16	6.0	25	●	1	
533-M16-06	5	33	29	43	68	M16	6.0	25	●	1	
535-M16-06	5	35	29	43	68	M16	6.0	25	●	1	
540-M16-06	5	40	29	43	68	M16	6.0	25	●	1	
640-M16-06	6	40	29	43	68	M16	6.0	25	●	1	
642-M16-06	6	42	29	43	68	M16	6.0	25	●	1	
4N TE90- 216-S10-06	2	16	15.2	20	31.3	S10	6.0	8	●	2	

- ▶ Cutter body for '4NKT 060320R-HF' and '4NHT 060320R-F' inserts should be modified with body corner radius 2.0 mm
- ▶ Matched with T-FLEXTEC holder(Fig.1) & MAXI-RUSH holder(Fig.2)

Spare parts

Designation	Screw	Wrench			
4N TE90-06	TS 30B068/HG	TD 8			

 E312-E315	 E318	 E338-E359
---------------	----------	---------------

4N TE90-09/11/14



End mills

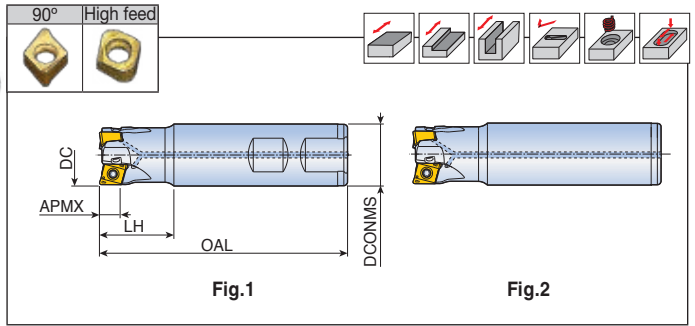

Designation	Flutes	Dimension (mm)					Coolant hole	Fig.	Insert
		DC	DCONMS	OAL	LH	APMX			
4N TE90-220-W20-09	2	20	20	100	30	8.0	●	1	4NK(H)T 0904.. E252-E253
220-20-09-L170	2	20	20	170	30	8.0	●	2	
225-W25-09	2	25	25	100	30	8.0	●	1	
225-25-09-L200	2	25	25	200	40	8.0	●	2	
325-W25-09	3	25	25	100	30	8.0	●	1	
325-25-09-L210	3	25	25	210	30	8.0	●	2	
226-25-09-L200	2	26	25	200	40	8.0	●	2	
332-W32-09	3	32	32	110	40	8.0	●	1	
332-32-09-L250	3	32	32	250	40	8.0	●	2	
333-32-09-L250	3	33	32	250	40	8.0	●	2	
432-W25-09	4	32	25	130	35	8.0	●	1	
432-25-09-L200	4	32	25	200	40	8.0	●	2	
432-W32-09	4	32	32	110	40	8.0	●	1	
440-W32-09	4	40	32	115	40	8.0	●	1	
440-32-09-L250	4	40	32	250	40	8.0	●	2	
540-W32-09	5	40	32	115	40	8.0	●	1	
4N TE90-225-W25-11	2	25	25	100	30	10.5	●	1	4NKT 1106.. E252-E253
225-25-11-L200	2	25	25	200	40	10.5	●	2	
332-W32-11	3	32	32	110	40	10.5	●	1	
440-W32-11	4	40	32	115	40	10.5	●	1	
440-32-11-L200	4	40	32	200	40	10.5	●	2	
4N TE90-232-W32-14	2	32	32	110	40	13.8	●	1	4NKT 1407.. E252-E253
232-32-14	2	32	32	150	45	13.8	●	2	
232-32-14-L250	2	32	32	250	40	13.8	●	2	
340-W32-14	3	40	32	115	40	13.8	●	1	
340-32-14	3	40	32	115	40	13.8	●	2	

Cutting Condition
E312-E315

Torque
E318

Ramping Data
E338-E359

- ▶ Cutter body for '4NKT 090432R-HF' insert should be modified with body corner radius 3.2mm
- ▶ Cutter body for '4NKT 110640R-HF' insert should be modified with body corner radius 4.0 mm
- ▶ Cutter body for '4NKT 140750R-HF' insert should be modified with body corner radius 5.0 mm

4N TE90-M-09/11/14



Modular heads

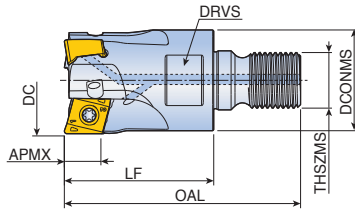
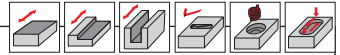

Designation	🌀	Dimension (mm)							Coolant hole	Insert
		DC	DCONMS	LF	OAL	THSZMS	APMX	DRVS		
4N TE90-220-M10-09	2	20	18	30	50	M10	8.0	15	●	4NK(H)T 0904...
325-M12-09	3	25	21	35	57	M12	8.0	17	●	🌀 E252-E253
432-M16-09	4	32	29	43	68	M16	8.0	25	●	
540-M16-09	5	40	29	43	68	M16	8.0	25	●	
4N TE90-225-M12-11	2	25	21	35	57	M12	10.5	17	●	4NKT 1106...
332-M16-11	3	32	29	43	68	M16	10.5	25	●	🌀 E252-E253
440-M16-11	4	40	29	43	68	M16	10.5	25	●	
4N TE90-232-M16-14	2	32	29	43	68	M16	13.8	25	●	4NKT 1407...
340-M16-14	3	40	29	43	68	M16	13.8	25	●	🌀 E252-E253

- ▶ Cutter body for '4NKT 090432R-HF' insert should be modified with body corner radius 3.2 mm
- ▶ Cutter body for '4NKT 110640R-HF' insert should be modified with body corner radius 4.0 mm
- ▶ Cutter body for '4NKT 140750R-HF' insert should be modified with body corner radius 5.0 mm
- ▶ Matched with T-FLEXTEC holder

Spare parts

Designation	Screw	Wrench	Wrench handle		
4N TE90-09	TS 35A088/HG	TBLD T10P-W6	THND 6W		
4N TE90-11	TS 40093/HG	TBLD T15-W6	THND 6W		
4N TE90-14	TS 50A121/HG	TBLD T20-W6	THND 6W		

Cutting Condition
E312-E315

Torque
E318

Ramping Data
E338-E359

8D-TE90-07

End mills

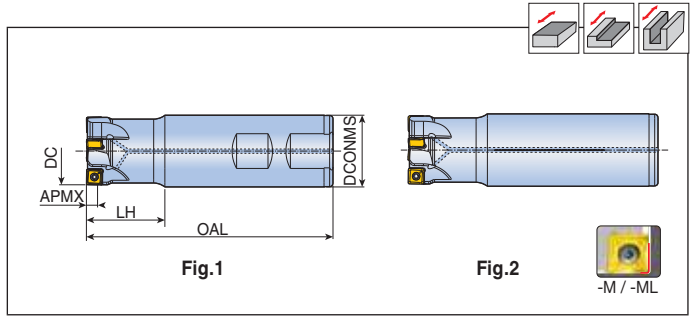

Designation	Z	Dimension (mm)					Coolant hole	Fig.	Insert
		DC	DCONMS	LH	OAL	APMX			
8D-TE90- 216-W16-07	2	16	16	20	90	5.0	●	1	SQKU 0703... E297
216-16-07-L110	2	16	16	20	110	5.0	●	2	
217-16-07-L110	2	17	16	20	110	5.0	●	2	
220-W20-07	2	20	20	25	90	5.0	●	1	
220-20-07-L160	2	20	20	25	160	5.0	●	2	
320-W20-07	3	20	20	25	90	5.0	●	1	
221-20-07-L160	2	21	20	25	160	5.0	●	2	
325-W25-07	3	25	25	30	100	5.0	●	1	
325-25-07-L160	3	25	25	30	160	5.0	●	2	
425-W25-07	4	25	25	30	100	5.0	●	1	
326-25-07-L160	3	26	25	30	160	5.0	●	2	
432-W32-07	4	32	32	35	110	5.0	●	1	
432-32-07-L200	4	32	32	35	200	5.0	●	2	
632-W32-07	6	32	32	35	110	5.0	●	1	
433-32-07-L200	4	33	32	35	200	5.0	●	2	
540-W32-07	5	40	32	40	110	5.0	●	1	
840-W32-07	8	40	32	40	110	5.0	●	1	

Spare parts

Designation	Screw	Wrench			
	8D-TE90-07	TS 25D060/HG-P	TD 7P		



8D-TE90-M-07



Modular heads

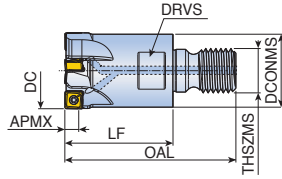
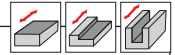

Designation		Dimension (mm)							Coolant hole	Insert
		DC	DCONMS	LF	OAL	THSZMS	APMX	DRVS		
8D-TE90-216-M08-07	2	16	14	23	40.5	M08	5.0	10	●	SQKU 0703...
320-M10-07	3	20	18	30	50	M10	5.0	15	●	E297
325-M12-07	3	25	22	35	57	M12	5.0	17	●	
432-M16-07	4	32	29	43	68	M16	5.0	25	●	
540-M16-07	5	40	29	43	68	M16	5.0	25	●	

► Matched with T-FLEXTEC holder

Spare parts

Designation	Screw	Wrench			
8D-TE90-M-07	TS 25D060/HG-P	TD 7P			



8D-TE90-10



End mills

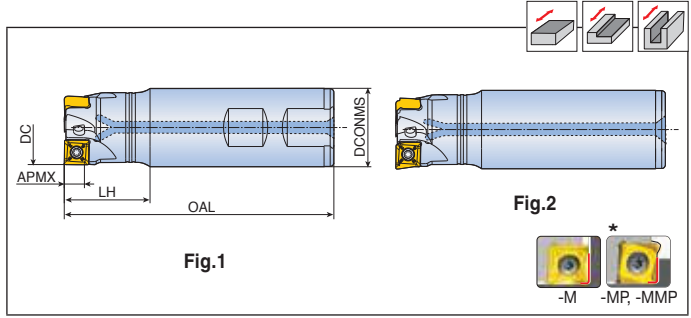

Designation	⊕	Dimension (mm)					Coolant hole	Fig.	Insert
		DC	DCONMS	OAL	LH	APMX			
8D-TE90-225-W25-10	2	25	25	100	30	7.0 ^{**}	●	1	SQK(H)U 1004... E297
225-25-10-L160	2	25	25	160	30	7.0 ^{**}	●	2	
332-W32-10	3	32	32	110	35	7.0 ^{**}	●	1	
332-32-07-L200	3	32	32	200	35	7.0 ^{**}	●	2	
440-W32-10	4	40	32	110	40	7.0 ^{**}	●	1	

▶ *:Multi-Step milling is not recommended over the APMX ▶ **:When applying SQHU insert, APMX is 6.5 mm.

Spare parts

Designation	Screw	Wrench			
	8D-TE90-10	TS 35A088I/HG	TD 10P		

Cutting Condition
E312-E315

Torque
E318

8D-TE90-M-10

Modular heads

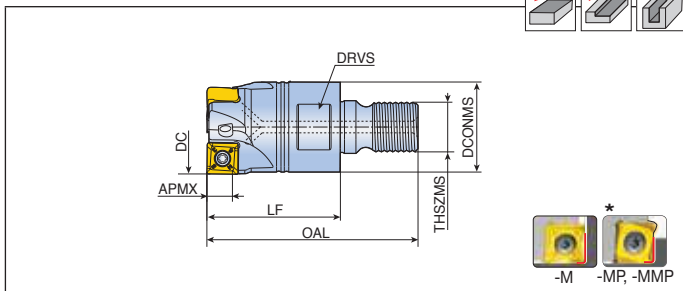

Designation	⌀	Dimension (mm)								Coolant hole	Insert
		DC	DCONMS	LF	OAL	THSZMS	APMX	DRVS			
8D-TE90-225-M12-10	2	25	22	35	57	M12	7.0**	17	●	SQK(H)U 1004...	
332-M16-10	3	32	29	43	68	M16	7.0**	25	●	E297	
440-M16-10	4	40	29	43	68	M16	7.0**	25	●		

▶ *:Multi-Step milling is not recommended over the APMX ▶ **:When applying SQHU insert, APMX is 6.5 mm.
▶ Matched with T-FLEXTEC holder

Spare parts

Designation	Screw	Wrench			
8D-TE90-M-10	TS 35A088/HG	TD 10P			

E312-E315

E318

TE90XEV-HSK63A-16



End mills for HSK toolholder

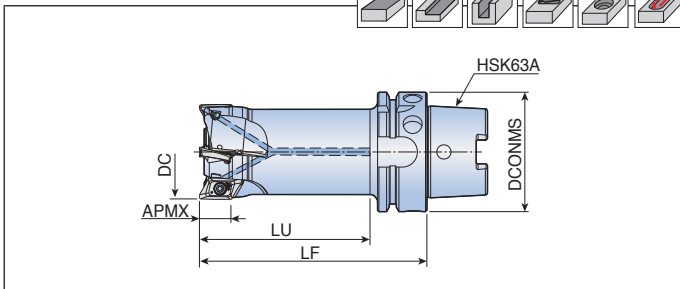
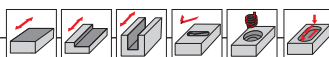

Designation		Dimension (mm)						Coolant hole	Max RPM	Insert
		DC	DCONMS	LF	LU	APMX				
TE90XEV 225-100-HSK63A-16	2	25	63	100	70	16	●	52,000	XEVT 1605... E305	
232-125-HSK63A-16	2	32	63	125	95	16	●	46,000		
332-90-HSK63A-16	3	32	63	90	60	16	●	46,000		
340-105-HSK63A-16	3	40	63	105	75	16	●	41,200		
450-105-HSK63A-16	4	50	63	105	75	16	●	36,800		
450-120-HSK63A-16	4	50	63	120	90	16	●	36,800		

► Cutter body for inserts with corner radii more than 3.2mm (XEVT 16) should be modified as follows:
body "RE"-insert "RE"-0.3mm

Spare parts

Designation	Screw	Wrench			
	TE90XEV-16 (Ø25)	TS 40085I/HG	T-T15		
TE90XEV-16 (Ø32-)	TS 40093I/HG	T-T15			

Cutting Condition
 E312-E315

Torque
 E318

Ramping Data
 E368-E372

TE90XEV-16/22



End mills & Modular heads

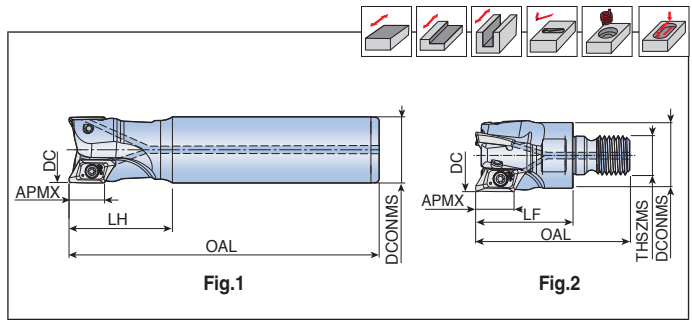

Designation		Dimension (mm)							Coolant hole	Fig.	Max RPM	Insert
		DC	DCONMS	OAL	THSZMS	LF	LH	APMX				
TE90XEV 225-25-16	2	25	25	125	-	-	55	16	●	1	52,000	XEVT 1605... 305
225-25-16-L170	2	25	25	170	-	-	70	16	●	1	52,000	
232-32-16	2	32	32	150	-	-	50	16	●	1	46,000	
232-32-16-L200	2	32	32	200	-	-	80	16	●	1	46,000	
332-32-16	3	32	32	150	-	-	50	16	●	1	46,000	
332-32-16-L200	3	32	32	200	-	-	80	16	●	1	46,000	
340-32-16	3	40	32	170	-	-	55	16	●	1	41,200	
340-32-16-L250	3	40	32	250	-	-	55	16	●	1	41,200	
TE90XEV 225-M12-16	2	25	21	65	M12	43	-	16	●	2	52,000	XEVT 2206... E305
232-M16-16	2	32	29	68	M16	43	-	16	●	2	46,000	
332-M16-16	3	32	29	68	M16	43	-	16	●	2	46,000	
340-M16-16	3	40	29	68	M16	43	-	16	●	2	41,200	
TE90XEV 232-32-22	2	32	32	160	-	-	100	21	●	1	37,500	
340-40-22	3	40	40	160	-	-	80	21	●	1	35,100	

- ▶ Matched with T-FLEXTEC holder(Fig.2)
- ▶ Cutter body for inserts with corner radii more than 3.2mm (XEVT 16) and 3.0mm (XEVT 22) should be modified as follows: body "RE"=insert "RE"-0.3mm

Spare parts

Designation	Screw	Wrench			
TE90XEV-16 (Ø25)	TS 40085I/HG	T-T 15			
TE90XEV-16 (Ø32)	TS 40093I/HG	T-T 15			
TE90XEV-22 (Ø32)	TS 50105I	T-T 20			
TE90XEV-22 (Ø40)	TS 50115I	T-T 20			

 Cutting Condition E312-E315	 Torque E318	 Ramping Data E368-E372
------------------------------------	--------------------	-------------------------------

End mills

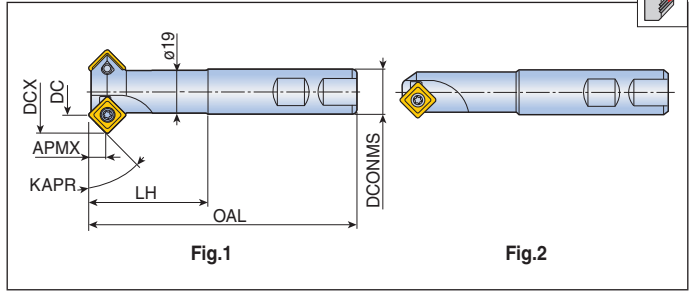

Designation		Dimension (mm)							Fig.	Application range(mm)	Insert
		KAPR	DCX	DC	DCNMS	OAL	LH	APMX			
TCF 15 D25-11	2	75°	30.5	25	20	120	40	10.1	1	Ø26.3-Ø30.0	SPMT(G) 1104...EM E295
30 D25-11	2	60°	35.5	25	20	120	40	8.9	1	Ø26.3-Ø34.0	
45 D07-11	1	45°	21.5	7	20	120	40	7.2	2	Ø8.3-Ø20.9	
45 D19-11	2	45°	33.4	19	20	120	40	7.2	1	Ø20.3-Ø32.9	
45 D25-11	3	45°	39.4	25	20	120	40	7.2	1	Ø26.3-Ø38.9	

Spare parts

Designation	Screw	Wrench			
	TCF-11	 TS 40093I	 TD 15		

 E312-E315	 E318
---------------	----------

End mills

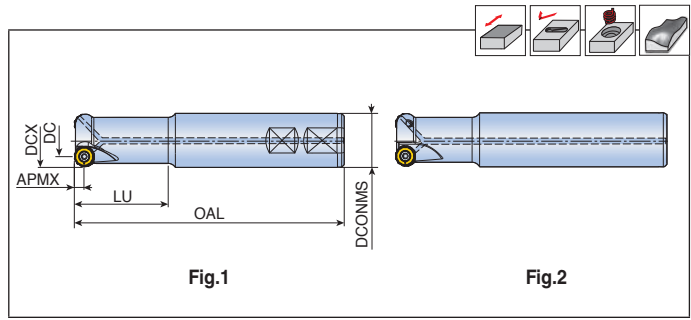

Designation		Dimension (mm)						Coolant hole	Fig.	Insert
		DCX	DC	DCONMS	OAL	LU	APMX			
TERNS 225-25-10-L160	2	25	15	25	160	60	5.0	●	2	RNMU 1004...
225-32-10-L250	2	25	15	32	250	40	5.0	●	2	
325-25-10-L160	3	25	15	25	160	60	5.0	●	2	
226-25-10-L200	2	26	16	25	200	80	5.0	●	2	
332-32-10-L180	3	32	22	32	180	70	5.0	●	2	
332-32-10-L250	3	32	22	32	250	100	5.0	●	2	
432-32-10-L180	4	32	22	32	180	70	5.0	●	2	
432-32-10-L250	4	32	22	32	250	100	5.0	●	2	
433-32-10-L200	4	33	23	32	200	80	5.0	●	2	
433-32-10-L250	4	33	23	32	250	100	5.0	●	2	
TERNS 232-32-12-L150	2	32	20	32	150	50	6.0	●	2	RNMU 1205...
232-32-12-L200	2	32	20	32	200	60	6.0	●	2	
232-32-12-L	2	32	20	32	250	50	6.0	●	2	
332-W32-12	3	32	20	32	160	60	6.0	●	1	
332-32-12-L200	3	32	20	32	200	70	6.0	●	2	
332-32-12-L250	3	32	20	32	250	60	6.0	●	2	
233-32-12-L200	2	33	21	32	200	50	6.0	●	2	
233-32-12-L250	2	33	21	32	250	50	6.0	●	2	
333-32-12-L200	3	33	21	32	200	70	6.0	●	2	
333-32-12-L250	3	33	21	32	250	60	6.0	●	2	
340-W32-12	3	40	28	32	160	50	6.0	●	1	
340-32-12-L250	3	40	28	32	250	50	6.0	●	2	
440-W32-12	4	40	28	32	160	50	6.0	●	1	
440-32-12-L250	4	40	28	32	250	60	6.0	●	2	
450-32-12-L200	4	50	38	32	200	70	6.0	●	2	
550-32-12-L250	5	50	38	32	250	60	6.0	●	2	
TERNS 240-W32-16-L160	2	40	24	32	160	50	6.0	●	1	RNMU 1606...
240-32-16-L180	2	40	24	32	180	70	8.0	●	2	
240-32-16-L250	2	40	24	32	250	100	8.0	●	2	
340-32-16-L180	3	40	24	32	180	70	8.0	●	2	
340-32-16-L250	3	40	24	32	250	100	8.0	●	2	

 Cutting Condition E312-E315	 Torque E318	 Ramping Data E386-E387
------------------------------------	--------------------	-------------------------------

TERNS-M



Modular heads

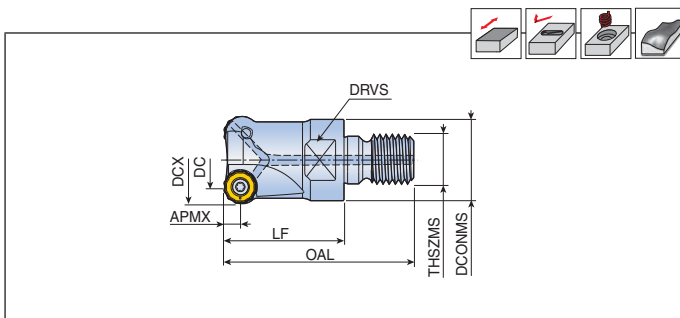

Designation		Dimension (mm)									Coolant hole	Insert
		DCGX	DC	DCONMS	LF	OAL	THSZMS	APMX	DRVS			
TERNS 225-M12-10	2	25	15	21	35	57	M12	5.0	17	●	RNMU 1004...	
325-M12-10	3	25	15	21	35	57	M12	5.0	17	●	E284	
432-M16-10	4	32	22	29	43	68	M16	5.0	25	●		
542-M16-10	5	42	32	29	43	68	M16	5.0	25	●		
TERNS 232-M16-12	2	32	20	29	43	68	M16	6.0	25	●	RNMU 1205...	
332-M16-12	3	32	20	29	43	68	M16	6.0	25	●	E284	
233-M16-12	2	33	21	29	43	68	M16	6.0	25	●		
333-M16-12	3	33	21	29	43	68	M16	6.0	25	●		
340-M16-12	3	40	28	29	43	68	M16	6.0	25	●		
440-M16-12	4	40	28	29	43	68	M16	6.0	25	●		
TERNS 240-M16-16	2	40	24	29	43	68	M16	8.0	25	●	RNMU 1606...	
340-M16-16	3	40	24	29	43	68	M16	8.0	25	●	E284	

▶ Matched with T-FLEXTEC holder

Spare parts

Designation	Screw	Wrench			
TERNS-10	TS 35085I/HG	TD 15	-		
TERNS-12	TS 40G110I	-	T-T15		
TERNS-16	TS 50A121I/HG	TD 20	-		

 E312-E315	 E318	 E386-E387
---------------	----------	---------------

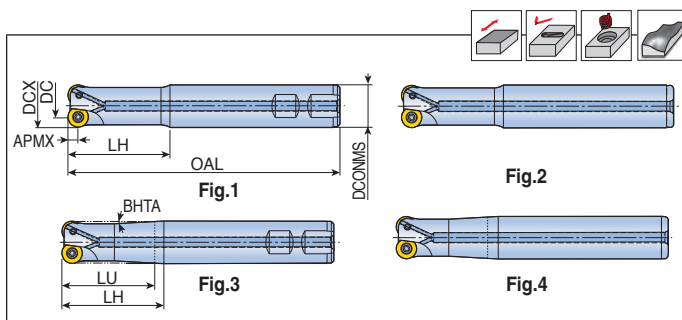

Designation	Z	Dimension (mm)								Coolant hole	Fig.	Insert
		DCX	DC	DCONMS	OAL	LU	LH	BHTA	APMX			
TERY 216-W20-08-L	2	16	8	20	110	45	55	4.1°	4.0	●	3	RYM(H)X 0803...
217-16-08-L130	2	17	9	16	130	-	30	-	4.0	●	2	E285-E286
218-16-08-L150	2	18	10	16	150	-	30	-	4.0	●	2	
320-W20-08	3	20	12	20	150	-	43	-	4.0	●	1	
320-20-08-L110	3	20	12	20	110	-	60	-	4.0	●	2	
321-20-08-L150	3	21	13	20	150	-	40	-	4.0	●	2	
425-W25-08	4	25	17	25	150	-	43	-	4.0	●	1	
426-25-08-L150	4	26	18	25	150	-	40	-	4.0	●	2	
532-W32-08	5	32	24	32	160	-	60	-	4.0	●	1	
TERY 220-W20-10	2	20	10	20	160	-	60	-	5.0	●	1	RYM(H)X 1004...
220-25-10-L	2	20	10	25	250	60	80	3.5°	5.0	●	4	E285-E286
221-20-10-L200	2	21	11	20	200	-	30	-	5.0	●	2	
225-32-10-L	2	25	15	32	250	53	80	5.0°	5.0	●	4	
225-W25-10	2	25	15	25	160	-	60	-	5.0	●	1	
325-W25-10	3	25	15	25	160	-	60	-	5.0	●	1	
226-25-10-L200	2	26	16	25	200	-	30	-	5.0	●	2	
326-25-10-L200	3	26	16	25	200	-	60	-	5.0	●	2	
432-W32-10	4	32	22	32	160	-	60	-	5.0	●	1	
TERY 225-W25-12	2	25	13	25	160	-	60	-	6.0	●	1	RYM(H)X 1205...
226-25-12-L200	2	26	14	25	200	-	60	-	6.0	●	2	E285-E286
232-32-12-L	2	32	20	32	250	-	50	-	6.0	●	2	
332-W32-12	3	32	20	32	160	-	64	-	6.0	●	1	
332-W32-12-S	3	32	20	32	105	-	35	-	6.0	●	1	
233-32-12-L250	2	33	21	32	250	-	40	-	6.0	●	2	
333-32-12-L200	3	33	21	32	200	-	60	-	6.0	●	2	
340-W32-12	3	40	28	32	160	-	50	-	6.0	●	1	
340-W32-12-S	3	40	28	32	105	-	35	-	6.0	●	1	
340-32-12-L250	3	40	28	32	250	-	50	-	6.0	●	2	
440-W32-12	4	40	28	32	150	-	35	-	6.0	●	1	
440-W32-12-S	4	40	28	32	105	-	35	-	6.0	●	1	
TERY 240-W32-16	2	40	24	32	160	-	50	-	8.0	●	1	RYM(H)X 1606...
340-32-16-L250	3	40	24	32	250	-	50	-	8.0	●	2	E285-E286
TERY 350-32-20	3	50	30	32	160	-	50	-	10.0	●	2	RYM(H)X 2007...
350-40-20	3	50	30	40	200	-	60	-	10.0	●	2	E285-E286

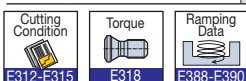

TERY-M-08/10



Modular heads

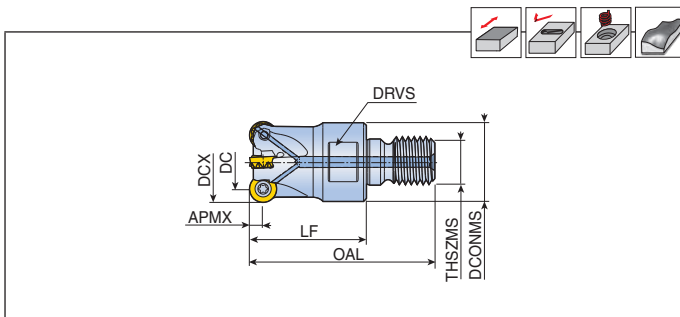

Designation		Dimension (mm)								Coolant hole	Insert
		DCX	DC	DCONMS	LF	OAL	THSZMS	APMX	DRVS		
TERY 216-M08-08	2	16	8	13	23	40.5	M08	4.0	10	●	RYM(H)X 0803... E285-E286
218-M08-08	2	18	10	13	23	40.5	M08	4.0	10	●	
220-M10-08	2	20	12	18	30	50	M10	4.0	15	●	
320-M10-08	3	20	12	18	30	50	M10	4.0	15	●	
425-M12-08	4	25	17	21	35	57	M12	4.0	17	●	
530-M16-08	5	30	22	29	43	68	M16	4.0	25	●	
532-M16-08	5	32	24	29	43	68	M16	4.0	25	●	
540-M16-08	5	40	32	29	43	68	M16	4.0	25	●	
640-M16-08	6	40	32	29	43	68	M16	4.0	25	●	
TERY 220-M10-10	2	20	10	18	30	50	M10	5.0	15	●	RYM(H)X 1004... E285-E286
225-M12-10	2	25	15	21	35	57	M12	5.0	17	●	
325-M12-10	3	25	15	21	35	57	M12	5.0	17	●	
430-M16-10	4	30	20	29	43	68	M16	5.0	25	●	
432-M16-10	4	32	22	29	43	68	M16	5.0	25	●	
435-M16-10	4	35	25	29	43	68	M16	5.0	25	●	
542-M16-10	5	42	32	29	43	68	M16	5.0	25	●	
642-M16-10	6	42	32	29	43	68	M16	5.0	25	●	

▶ Matched with T-FLEXTEC holder

Spare parts

Designation	Screw	Wrench			
	TERY-08	TS 30A060I/HG	TD 9		
TERY-10	TS 35070I/HG(UnderØ21), TS 35085I/HG	TD 15			
TERY-12	TS 40093I	TD 15			
TERY-16	TS 50115I	TD 20			

Cutting Condition E312-E315	Torque E318	Ramping Data E388-E390
--------------------------------	----------------	---------------------------

TERY-M-12/16



Modular heads

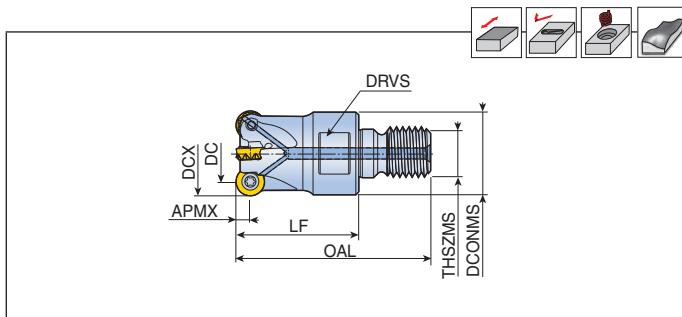

Designation		Dimension (mm)									Coolant hole	Insert
		DCX	DC	DCONMS	LF	OAL	THSZMS	APMX	DRVS	DCONMS		
TERY 225-M12-12	2	25	13	21	35	57	M12	6.0	17	●	RYM(H)X 1205... E285-E286	
232-M16-12	2	32	20	29	43	68	M16	6.0	25	●		
332-M16-12	3	32	20	29	43	68	M16	6.0	25	●		
335-M16-12	3	35	23	29	43	68	M16	6.0	25	●		
340-M16-12	3	40	28	29	43	68	M16	6.0	25	●		
440-M16-12	4	40	28	29	43	68	M16	6.0	25	●		
442-M16-12	4	42	30	29	43	68	M16	6.0	25	●		
TERY 232-M16-16	2	32	16	29	43	68	M16	8.0	25	●	RYM(H)X 1606... E285-E286	
240-M16-16	2	40	24	29	43	68	M16	8.0	25	●		
342-M16-16	3	42	26	29	43	68	M16	8.0	25	●		

► Matched with T-FLEXTEC holder

Spare parts

Designation	Screw	Wrench			
TERY-12	TS 40093I	TD 15			
TERY-16	TS 50115I	TD 20			

 Cutting Condition E312-E315	 Torque E318	 Ramping Data E388-E390
------------------------------------	--------------------	-------------------------------

End mills

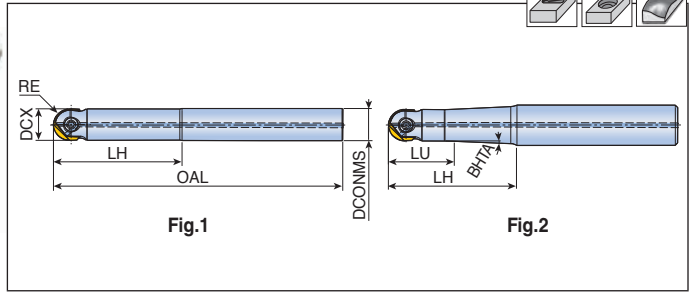

Designation	Dimension (mm)							Coolant hole	Fig.	Insert
	DCX	RE	DCONMS	OAL	LH	LU	BHTA			
TNF 060-10M	6	3	10	80	30	15	7.5°	●	2	NFB 060... NFR 060A...
060-30-L80	6	3	10	80	30	-	-	●	1	NFR 060A...
080-08S	8	4	8	90	20	-	-	●	1	NFB 080...
080-12S	8	4	12	100	20	10	9.5°	●	2	NFR 080A...
080-12M	8	4	12	130	50	10	3°	●	2	NFCB 080...
100-10S	10	5	10	90	30	-	-	●	1	NFB 100...
100-12S	10	5	12	110	25	15	5°	●	2	NFR 100A... NFR 110A...
100-16M	10	5	16	130	60	15	3.5°	●	2	NFCB 100...
120-12S	12	6	12	110	30	-	-	●	1	NFB 120...
120-12M	12	6	12	180	60	-	-	●	1	NFR 120A...
120-16M	12	6	16	140	60	25	2.4°	●	2	NFR 130A... NFL(C)B 120...
120-20L	12	6	20	180	80	40	5°	●	2	NFL(C)B 120...
160-16M	16	8	16	130	40	-	-	●	1	NFB 160...
160-16L	16	8	16	200	100	-	-	●	1	NFR 160A...
160-20M	16	8	20	160	60	25	2.5°	●	2	NFR 170A...
160-25L	16	8	25	220	100	55	5°	●	2	NFL(C)B 160...
200-20S	20	10	20	110	40	-	-	●	1	NFB 200...
200-20M	20	10	20	150	50	-	-	●	1	NFR 200A...
200-20L	20	10	20	220	70	-	-	●	1	NFR 210A... NFL(C)B 210...
200-25M	20	10	25	180	80	40	2.5°	●	2	NFL(C)B 210...
250-25L	20	10	25	220	110	45	1.5°	●	2	
250-25S	25	12.5	25	125	40	-	-	●	1	NFB 250...
250-25M	25	12.5	25	170	70	-	-	●	1	NFR 250A...
250-32M	25	12.5	32	200	90	32	3°	●	2	NFR 260A... NFL(C)B 250...
250-32L	25	12.5	32	250	130	40	1.5°	●	2	NFL(C)B 250...
300-32S	30	15	32	140	55	-	-	●	1	NFB 300...
300-32M	30	15	32	190	75	-	-	●	1	NFB 320...
300-32L	30	15	32	250	100	65	1°	●	2	NFR 300A...
300-32XL	30	15	32	300	150	-	-	●	1	NFR 320A... NFL(C)B 300...
300-32-L220	30	15	32	220	100	55	1°	●	2	NFL(C)B 300...
320-32L	32	16	32	250	60	-	-	●	1	NFB 320... NFR 320A...
										E278-E281



End mills-carbide shank

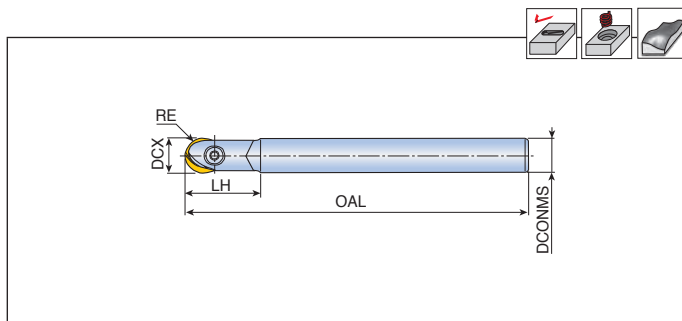

Designation	Dimension (mm)					Insert
	DCX	RE	DCONMS	OAL	LH	
TNF 060-06-CT-L60	6	3	6	60	15	NFB 060...
060-06-CT-L80	6	3	6	80	20	NFR 060A...
060-06-CT-L92	6	3	6	92	35	
060-06-CT-L120	6	3	6	120	65	
060-06-CT-L140	6	3	6	140	25	
080-08-CT-L100	8	4	8	100	30	NFB 080...
080-10-CT-L140	8	4	10	140	75	NFR 080A...
080-08-CT-L160	8	4	8	160	80	NFCB 080...
100-10-CT-L100	10	5	10	100	35	NFB 100...
100-10-CT-L140	10	5	10	140	75	NFR 100A...
100-10-CT-L200	10	5	10	200	70	NFR 110A...
100-10-CT-L220	10	5	10	220	140	NFCB 110...
120-12-CT-L120	12	6	12	120	50	NFB 120...
120-12-CT-L160-S	12	6	12	160	30	NFR 120A...
120-12-CT-L160	12	6	12	160	90	NFR 130A...
120-12-CT-L200	12	6	12	200	70	NFL(C)B 120...
120-12-CT-L220	12	6	12	220	150	
160-16-CT-L120	16	8	16	120	60	NFB 160...
160-16-CT-L160-S	16	8	16	160	70	NFR 160A...
160-16-CT-L160	16	8	16	160	80	NFR 170A...
160-16-CT-L200	16	8	16	200	70	NFL(C)B 160...
160-16-CT-L220	16	8	16	220	150	
200-20-CT-L200	20	10	20	200	70	NFB 200...
200-20-CT-L110	20	10	20	110	40	NFR 200A...
200-20-CT-L220	20	10	20	220	120	NFR 210A...
200-20-CT-L300	20	10	20	300	220	NFL(C)B 200...
250-25-CT-L200	25	12.5	25	200	70	NFB 250...
250-25-CT-L220-S	25	12.5	25	220	80	NFR 250A...
250-25-CT-L220	25	12.5	25	220	120	NFR 260A...
250-25-CT-L300	25	12.5	25	300	220	NFL(C)B 250...
300-32-CT-L200	30	15	32	200	70	NFB 300...
300-32-CT-L250-S	30	15	32	250	80	NFB 320...
300-32-CT-L250	30	15	32	250	150	NFR 300A...
300-32-CT-L350-S	30	15	32	350	80	NFR 320A...
300-32-CT-L350	30	15	32	350	230	NFL(C)B 300...
320-32-CT-L300	32	16	32	300	220	E278-E281
						NFB 320...
						NFR 320A...

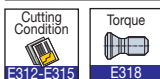

Modular heads

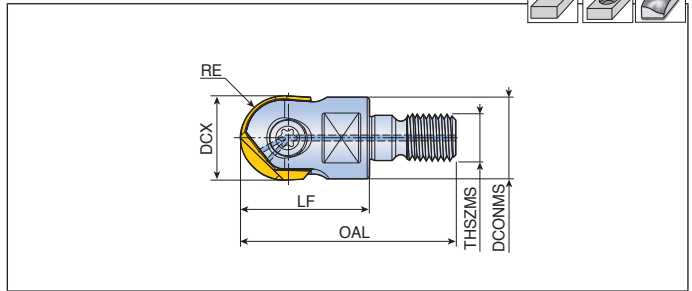

Designation	Dimension (mm)						Coolant hole	Insert
	DCX	RE	DCONMS	OAL	LF	THSZMS		
TNF 100-M06	10	5	9.7	34.5	20	M06	●	NFB 100... NFR 100A... NFR 110A... NFCB 100...
120-M06	12	6	11.5	37.5	23	M06	●	NFB 120... NFR 120A... NFR 130A...
120-M08	12	6	13	40.5	23	M08	●	NFL(C)B 120...
160-M08	16	8	13	47.5	30	M08	●	NFB 160... NFR 160A... NFR 170A... NFL(C)B 160...
200-M10	20	10	19	50	30	M10	●	NFB 200... NFR 200A... NFR 210A... NFL(C)B 200...
250-M12	25	12.5	24	57	35	M12	●	NFB 250... NFR 250A...
250-M16	25	12.5	29	68	43	M16	●	NFR 260A... NFL(C)B 250...
300-M16	30	15	29	68	43	M16	●	NFB 300... NFB 320... NFR 300A...NFR 320A... NFL(C)B 300...
320-M16	32	16	29.5	68	43	M16	●	NFB 320... NFR 320A... E278-E281

► Matched with T-FLEXTEC holder

Spare parts

Designation	Screw	Wrench			Wrench handle
TNF 060	TS 20F060A	TD 6	-	-	-
TNF 080	TS 25F080A	TD 8	-	-	-
TNF 100	TS 30F100A	TD 10	-	-	-
TNF 120	TS 40F120A	TD 15	-	-	-
TNF 160	TS 50F160A	-	T-T20	-	-
TNF 200	TS 60F200A	-	-	BLD T25/M7	SW6-T
TNF 250	TS 70F250A	-	-	BLD T25/M7	SW6-T
TNF 300, TNF 320	TS 80F300A	-	T-T30	-	-



End mills

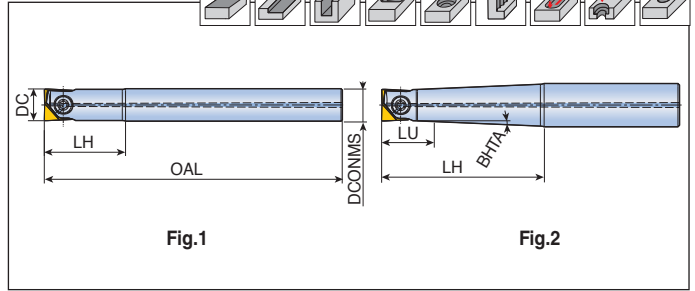
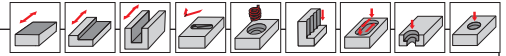

Fig.1

Fig.2

Designation	Dimension (mm)						Coolant hole	Fig.	Insert
	DC	DCONMS	OAL	LH	LU	BHTA			
TNFR 060-10M	6	10	80	30	15	9°	●	2	NFR 060A...
080-12S	8	12	100	22	10	9°	●	2	NFR 080A...
080-12M	8	12	130	50	10	2.8°	●	2	
100-12S	10	12	110	25	15	5°	●	2	NFR 100A...
100-16M	10	16	150	50	15	3.5°	●	2	NFR 110A...
120-12S	12	12	110	30	-	-	●	1	NFR 120A...
120-16M	12	16	160	60	18	2.5°	●	2	NFR 130A...
160-16S	16	16	130	50	-	-	●	1	NFR 160A...
160-16M	16	16	170	70	-	-	●	1	NFR 170A...
160-16L	16	16	200	100	-	-	●	1	
200-20S	20	20	140	60	-	-	●	1	NFR 200A...
200-20M	20	20	180	80	-	-	●	1	NFR 210A...
200-20L	20	20	250	120	-	-	●	1	
250-25S	25	25	150	70	-	-	●	1	NFR 250A...
250-25M	25	25	200	100	-	-	●	1	NFR 260A...
250-25L	25	25	250	120	-	-	●	1	
300-32S	30	32	140	55	-	-	●	1	NFR 300A
300-32M	30	32	190	75	-	-	●	1	NFR 320A
300-32L	30	32	250	100	65	1°	●	2	
320-32L	32	32	250	60	-	-	●	1	NFR 320A
									E280-E281

Spare parts

Designation	Screw	Wrench			Wrench handle
TNFR 060	TS 20F060A	TD 6	-	-	-
TNFR 080	TS 25F080A	TD 8	-	-	-
TNFR 100	TS 30F100A	TD 10	-	-	-
TNFR 120	TS 40F120A	TD 15	-	-	-
TNFR 160	TS 50F160A	-	T-T20	-	-
TNFR 200	TS 60F200A	-	-	BLD T25/M7	SW6-T
TNFR 250	TS 70F250A	-	-	BLD T25/M7	SW6-T
TNFR 300, TNFR 320	TS 80F300A	-	T-T30	-	-



TNFR-CT-L



End mills-carbide shank

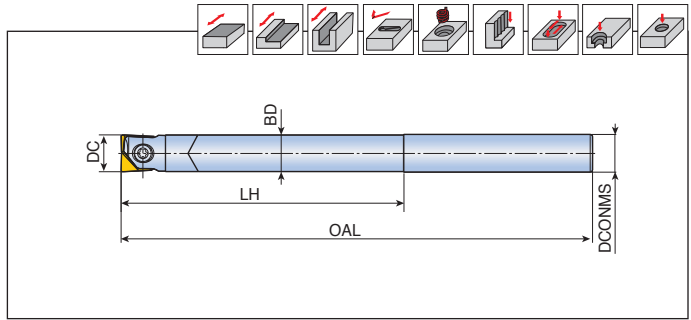

Designation	Dimension (mm)					Insert
	DC	DCONMS	BD	OAL	LH	
TNFR 060-06-CT-L60	6	6	5.8	60	15	NFR 060A...
060-06-CT-L80	6	6	5.8	80	20	
080-08-CT-L140	8	8	7.8	140	75	NFR 080A...
100-10-CT-L140	10	10	9.7	140	75	NFR 100A... NFR 110A...
120-12-CT-L160	12	12	11.7	160	95	NFR 120A... NFR 130A...
160-16-CT-L200	16	16	15.5	200	120	NFR 160A... NFR 170A...
200-20-CT-L250	20	20	19.5	250	160	NFR 200A... NFR 210A...
250-25-CT-L300	25	25	24.5	300	200	NFR 250A... NFR 260A...
300-32-CT-L350	30	32	29.5	350	230	NFR 300A... NFR 320A...
320-32-CT-L350	32	32	31.5	350	230	NFR 320A... E280-E281

Spare parts

Designation	Screw	Wrench			Wrench handle	
TNFR 060	TS 20F060A	TD 6	-	-	-	
TNFR 080	TS 25F080A	TD 8	-	-	-	
TNFR 100	TS 30F100A	TD 10	-	-	-	
TNFR 120	TS 40F120A	TD 15	-	-	-	
TNFR 160	TS 50F160A	-	T-T20	-	-	
TNFR 200	TS 60F200A	-	-	BLD T25/M7	SW6-T	
TNFR 250	TS 70F250A	-	-	BLD T25/M7	SW6-T	
TNFR 300, TNFR 320	TS 80F300A	-	T-T30	-	-	



Modular heads

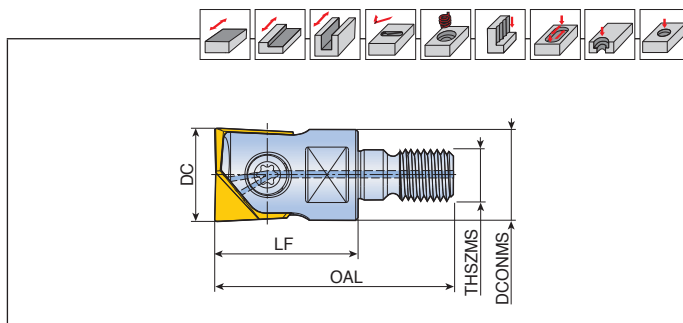

Designation	Dimension (mm)						Coolant hole	Insert
	DC	DCONMS	LF	OAL	THSZMS	DRVS		
TNFR 100-M06	10	9.7	20	34.5	M06	8	●	NFR 100A... NFR 110A...
120-M06	12	11.5	23	37.5	M06	8	●	NFR 120A...
120-M08	12	13	23	40.5	M08	10	●	NFR 130A...
160-M08	16	13	30	47.5	M08	10	●	NFR 160A... NFR 170A...
200-M10	20	19	30	50	M10	15	●	NFR 200A... NFR 210A...
250-M12	25	24	35	57	M12	17	●	NFR 250A... NFR 260A...
300-M16	30	29	43	68	M16	25	●	NFR 300A NFR 320A
320-M16	32	29.5	43	68	M16	25	●	NFR 320A E280-E281

► Matched with T-FLEXTEC holder

Spare parts

Designation	Screw	Wrench			Wrench handle
TNFR 060	TS 20F060A	TD 6	-	-	-
TNFR 080	TS 25F080A	TD 8	-	-	-
TNFR 100	TS 30F100A	TD 10	-	-	-
TNFR 120	TS 40F120A	TD 15	-	-	-
TNFR 160	TS 50F160A	-	T-T20	-	-
TNFR 200	TS 60F200A	-	-	BLD T25/M7	SW6-T
TNFR 250	TS 70F250A	-	-	BLD T25/M7	SW6-T
TNFR 300, TNFR 320	TS 80F300A	-	T-T30	-	-

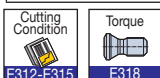

End mills

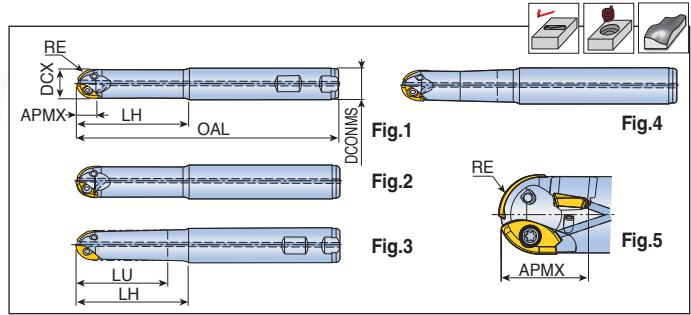

Designation	Dimension (mm)							Coolant hole	Fig.	Insert			
	DCX	RE	DCONMS	OAL	LU	LH	APMX			Ball	Periphery	Periphery	Periphery
2F 16-11-W20-L120	16	8	20	120	35.5	60	11.8	●	3	2FB160 E248	2	-	-
16-11-20-L130	16	8	20	130	45.9	60	11.8	●	4		2	-	-
16-11-20-L200	16	8	20	200	45.9	60	11.8	●	4		2	-	-
16-20-W20-L120-P	16	8	20	120	41.8	60	20.5	X	5		2	APKT 09T3	1
16-20-25-L200-P	16	8	25	200	43.4	65	20.5	X	5	2	E259	1	
20-13-W25-L105	20	10	25	105	-	45	13.6	●	1	2FB200 E248	2	-	-
20-13-W25-L150	20	10	25	150	45.7	65	13.6	●	3		2	-	-
20-13-20-L220	20	10	20	220	-	70	13.6	●	2		2	-	-
20-13-25-L160	20	10	25	160	58.4	75	13.6	●	4		2	-	-
20-13-25-L220	20	10	25	220	65.7	85	13.6	●	4	2FB250 E248	2	-	-
20-22-25-L125-P	20	10	25	125	45.7	65	22.3	●	5		2	APKT 09T3	1
20-22-25-L200-P	20	10	25	200	74.3	90	22.3	●	5		2	E259	1
20-22-32-L250-P	20	10	32	250	72.3	100	22.3	●	5		2	E259	1
25-17-W25-L150	25	12.5	25	150	-	60	17.7	●	1	2FB250 E248	2	-	-
25-17-32-L150	25	12.5	32	150	55.7	75	17.7	●	4		2	-	-
25-17-32-L200	25	12.5	32	200	61.6	85	17.7	●	4		2	-	-
25-17-32-L300	25	12.5	32	300	80	120	17.7	●	4		2	-	-
25-35-25-L200-P	25	12.5	25	200	-	87.5	35.1	●	5	2FB300 E248	2	-	-
25-35-32-L200-P	25	12.5	32	200	-	100	35.1	●	5		2	APKT 09T3	2
25-35-32-L250-P	25	12.5	32	250	-	110	35.1	●	5		2	E259	2
25-43-32-L300-P	25	12.5	32	300	-	120	43.7	●	5		2	-	3
30-20-W32-L180	30	15	32	180	-	86.1	20.0	●	1	2FB300 E248	2	-	-
30-20-30-L250	30	15	30	250	-	104.6	20.0	●	2		2	-	-
30-20-32-L200	30	15	32	200	-	86.1	20.0	●	2		2	-	-
30-20-32-L300	30	15	32	300	-	126.1	20.0	●	2		2	-	-
30-43-32-L160-P	30	15	32	160	-	66	43.7	●	5	2FB320 E248	2	-	-
30-43-32-L200-P	30	15	32	200	-	85.6	43.7	●	5		2	APKT 1204	2
30-43-32-L250-P	30	15	32	250	-	125.6	43.7	●	5		2	E260	2
30-51-32-L300-P	30	15	32	300	-	146	55.3	●	5		2	-	3
32-21-W32-L200	32	16	32	200	-	100	21.4	●	1	2FB320 E248	2	-	-
32-21-32-L180	32	16	32	180	-	100	21.4	●	2		2	-	-
32-21-32-L300	32	16	32	300	-	130	21.4	●	2		2	-	-
32-44-32-L160-P	32	16	32	160	-	66.4	44.7	●	5		2	-	2
32-44-32-L200-P	32	16	32	200	-	83.7	44.7	●	5	2FB320 E248	2	APKT 1204	2
32-44-32-L250-P	32	16	32	250	-	123.7	44.7	●	5		2	E260	2
32-44-32-L300-P	32	16	32	300	-	143.7	44.7	●	5		2	-	2



End mills

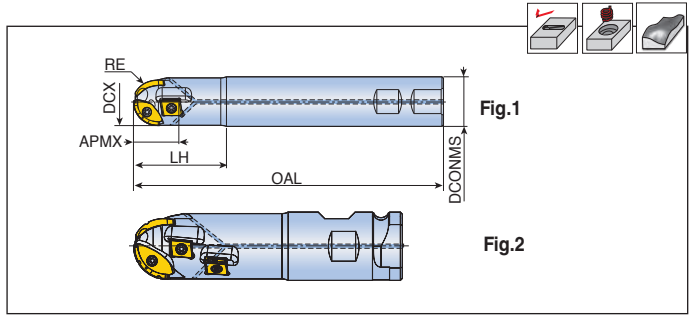

Designation	Dimension (mm)						Fig.	Insert					
	DCX	RE	DCONMS	OAL	LH	APMX		Ball1	Ball2	Periphery			
3F 32-39-W32-150	32	16	32	150	60	39	1	3FB320C-M	1	3FB320P-M	2	CNHX 131108T	2
32-39-W32-200	32	16	32	200	60	39	1	E249	1	E249	2	E272	2
32-39-W32-250	32	16	32	250	60	39	1		1		2		2
50-54-W40-150	50	25	40	150	70	54	1		1		2		2
50-80-W50-200	50	25	50	200	110	80	1	3FB500C-M	1		2	CNHX 160608T	4
50-80-W50-250	50	25	50	250	110	80	1	E249	1	3FB500P-M	2	E272	4
3F 50-68-CN50.8-200	50	25	50.8	200	115	68	2		1	E249	2		3
50-94-CN50.8-250	50	25	50.8	250	165	94	2		1		2		5

- ▶ When machining over 'APMX', please calculate Z=1
- ▶ Coolant through type

Spare parts

Designation	Screw	Wrench			
3F 32	TS 40093I	TD 15	-		
3F 50	TS 50115I	-	T-T20		

 E312-E315	 E318
---------------	----------

THFN-S



High feed modular heads

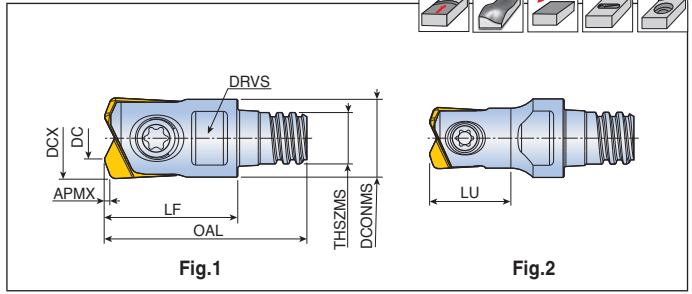

Designation		Dimension (mm)									Coolant hole	Fig.	Insert
		DCX	DC	DCONMS	LF	LU	OAL	THSZMS	APMX	DRVS			
THFN 060-S05	2	6	3	7.6	13	7.8	19.7	S05	0.3	5.5	x	2	HFN 060...
THFN 080-S05	2	8	4	7.6	13	-	19.7	S05	0.5	5.5	x	1	HFN 080... E274

► Matched with MAXI-RUSH holder

Spare parts

Designation	Screw	Wrench		Wrench handle	
THFN 060	TS 20F060A	TD 6	-	-	
THFN 080	TS 25F080A	-	TBLD T08-W4	THND 4W	

 Cutting Condition E312-E315	 Torque E318	 Ramping Data E376
------------------------------------	--------------------	--------------------------

TEPT-05/10



High feed end mills & modular heads

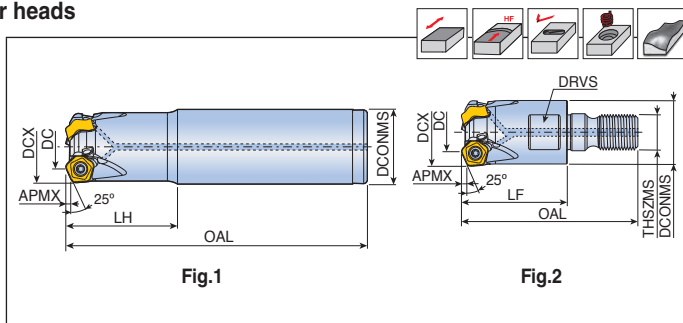

Designation		Dimension (mm)									Coolant hole	Fig.	Insert
		DCX	DC	DCONMS	LF	OAL	THSZMS	LH	DRVS	APMX			
TEPT 320-20-05-L150	3	20	11.9	20	-	150	-	50	-	1.5	●	1	PTKU 0503... E282
425-25-05-L150	4	25	16.8	25	-	150	-	50	-	1.5	●	1	
426-25-05-L200	4	26	17.8	25	-	200	-	30	-	1.5	●	1	
532-32-05-L200	5	32	23.8	32	-	200	-	50	-	1.5	●	1	
533-32-05-L200	5	33	24.8	32	-	200	-	30	-	1.5	●	1	
640-32-05-L200	6	40	31.8	32	-	200	-	30	-	1.5	●	1	
TEPT 320-M10-05	3	20	11.9	18	30	50	M10	-	15	1.5	●	2	PTKU 1006... E282
425-M12-05	4	25	16.8	21	35	57	M12	-	17	1.5	●	2	
532-M16-05	5	32	23.8	29	43	68	M16	-	25	1.5	●	2	
640-M16-05	6	40	31.8	29	43	68	M16	-	25	1.5	●	2	
TEPT 340-32-10-L200	3	40	23.5	32	-	200	-	40	-	3.0	●	1	PTKU 1006... E282
TEPT 340-M16-10	3	40	23.5	29	43	68	M16	-	25	3.0	●	2	

► Matched with T-FLEXTEC holder(Fig.2)

Spare parts

Designation	Screw	Wrench		Wrench handle	
TEPT-05	TS 25D060/HG-P	TD 7P	-	-	
TEPT-10	TS 50D130/HG-P	-	TBLD T20P-W6	THND 6W	

 Cutting Condition E312-E315	 Torque E318	 Ramping Data E374-E375
------------------------------------	--------------------	-------------------------------

TEBLV-06



End mills

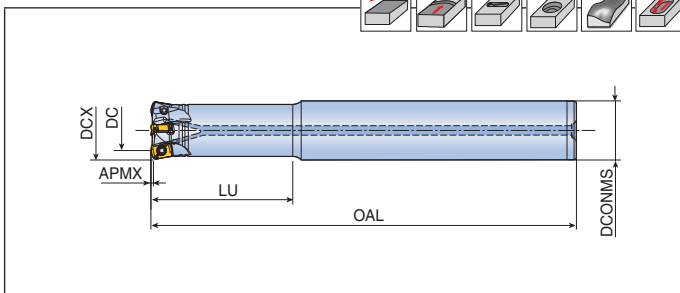
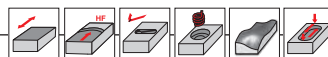

Designation		Dimension (mm)						Coolant hole	Insert
		DCX	DC	DCONMS	OAL	LU	APMX		
TEBLV 216-15-06-L150	2	16	9.1	15	150	40	0.7	●	BLMV 0603... E270
216-16-06-L100	2	16	9.1	16	100	30	0.7	●	
216-16-06-L150	2	16	9.1	16	150	40	0.7	●	
217-16-06-L100	2	17	10.1	16	100	30	0.7	●	
217-16-06-L150	2	17	10.1	16	150	40	0.7	●	
217-16-06-L200	2	17	10.1	16	200	20	0.7	●	
218-16-06-L150	2	18	11.2	16	150	25	0.7	●	
220-20-06-L200	2	20	12	20	200	80	1.0	●	
320-19-06-L180	3	20	12	19	180	80	1.0	●	
320-20-06-L130	3	20	12	20	130	50	1.0	●	
320-20-06-L160	3	20	12	20	160	80	1.0	●	
420-20-06-L130	4	20	12	20	130	50	1.0	●	
321-20-06-L150	3	21	13	20	150	20	1.0	●	
321-20-06-L200	3	21	13	20	200	20	1.0	●	
321-20-06-L250	3	21	13	20	250	20	1.0	●	
325-25-06-L220	3	25	17	25	220	50	1.0	●	
425-24-06-L180	4	25	17	24	180	60	1.0	●	
425-25-06-L140	4	25	17	25	140	60	1.0	●	
425-25-06-L180	4	25	17	25	180	60	1.0	●	
425-25-06-L250	4	25	17	25	250	40	1.0	●	
525-25-06-L140	5	25	17	25	140	60	1.0	●	
326-25-06-L200	3	26	18	25	200	30	1.0	●	

Spare parts

Designation	Screw	Wrench			
	TEBLV-06	TS 250641/HG-P	TD 8P		

Cutting Condition E312-E315	Torque E318	Ramping Data E377
--------------------------------	----------------	----------------------

TEBLV-06



End mills

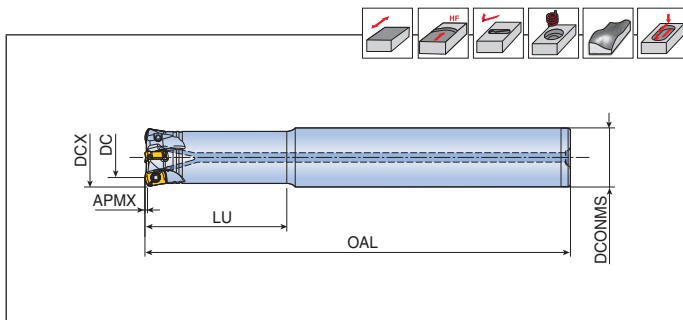

Designation		Dimension (mm)						Coolant hole	Insert
		DCX	DC	DCONMS	OAL	LU	APMX		
TEBLV 326-25-06-L250	3	26	18	25	250	30	1.0	●	BLMV 0603... E270
426-25-06-L150	4	26	18	25	150	30	1.0	●	
426-25-06-L200	4	26	18	25	200	30	1.0	●	
426-25-06-L250	4	26	18	25	250	30	1.0	●	
530-32-06-L150	5	30	22	32	150	70	1.0	●	
530-32-06-L200	5	30	22	32	200	120	1.0	●	
432-32-06-L150	4	32	24	32	150	70	1.0	●	
532-32-06-L150	5	32	24	32	150	70	1.0	●	
532-32-06-L200	5	32	24	32	200	120	1.0	●	
433-32-06-L220	4	33	25	32	220	40	1.0	●	
433-32-06-L300	4	33	25	32	300	50	1.0	●	
533-32-06-L150	5	33	25	32	150	30	1.0	●	
533-32-06-L200	5	33	25	32	200	40	1.0	●	
533-32-06-L250	5	33	25	32	250	40	1.0	●	
435-32-06-L200	4	35	27	32	200	50	1.0	●	
435-32-06-L300	4	35	27	32	300	50	1.0	●	
535-32-06-L200	5	35	27	32	200	50	1.0	●	
535-32-06-L300	5	35	27	32	300	50	1.0	●	
540-32-06-L220	5	40	32	32	220	40	1.0	●	
640-32-06-L150	6	40	32	32	150	40	1.0	●	
640-32-06-L220	6	40	32	32	220	40	1.0	●	
640-32-06-L250	6	40	32	32	250	40	1.0	●	

Spare parts

Designation	Screw	Wrench			
	TEBLV-06	TS 25064/HG-P	TD 8P		

Cutting Condition E312-E315	Torque E318	Ramping Data E377
--------------------------------	----------------	----------------------

TEBLV-M-06



Modular heads

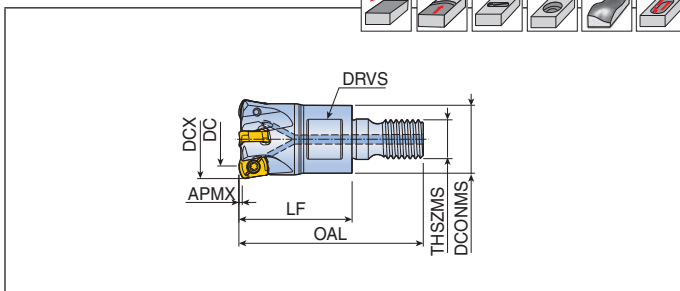
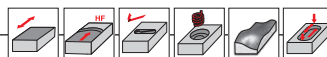

Designation	Z	Dimension (mm)									Coolant hole	Insert
		DCX	DC	DCONMS	LF	OAL	THSZMS	DRVS	APMX			
TEBLV 216-M08-06	2	16	9.1	13	25	42.5	M08	10	0.7	●	BLMV 0603... E270	
217-M08-06	2	17	10.1	13	25	42.5	M08	10	0.7	●		
218-M08-06	2	18	11.2	13	25	42.5	M08	10	0.7	●		
220-M10-06	2	20	12	18	30	50	M10	15	1.0	●		
320-M10-06	3	20	12	18	30	50	M10	15	1.0	●		
321-M10-06	3	21	13	18	30	50	M10	15	1.0	●		
322-M10-06	3	22	14	18	30	50	M10	15	1.0	●		
325-M12-06	3	25	17	21	35	57	M12	17	1.0	●		
425-M12-06	4	25	17	21	35	57	M12	17	1.0	●		
326-M12-06	3	26	18	21	35	57	M12	17	1.0	●		
426-M12-06	4	26	18	21	35	57	M12	17	1.0	●		
530-M16-06	5	30	22	29	40	65	M16	25	1.0	●		
432-M16-06	4	32	24	29	40	65	M16	25	1.0	●		
532-M16-06	5	32	24	29	40	65	M16	25	1.0	●		
433-M16-06	4	33	25	29	40	65	M16	25	1.0	●		
533-M16-06	5	33	25	29	40	65	M16	25	1.0	●		
435-M16-06	4	35	27	29	43	68	M16	25	1.0	●		
535-M16-06	5	35	27	29	43	68	M16	25	1.0	●		
640-M16-06	6	40	32	29	43	68	M16	25	1.0	●		
542-M16-06	5	42	34	29	43	68	M16	25	1.0	●		
642-M16-06	6	42	34	29	43	68	M16	25	1.0	●		

▶ Matched with T-FLEXTEC holder

Spare parts

Designation	Screw	Wrench			
	TEBLV-M-06	 TS 25064I/HG-P	 TD 8P		

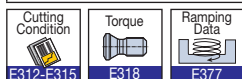

TEBL-04

High feed end mills

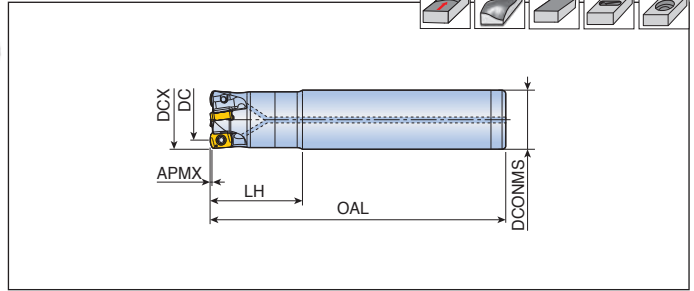

Designation	♻️	Dimension (mm)						Coolant hole	Insert
		DCX	DC	DCONMS	OAL	LH	APMX		
TEBL 108-08-04-L80	1	8	3.8	8	80	20	0.5	●	BLMP 0402... E268
210-10-04-L100	2	10	5.7	10	100	20	0.5	●	
211-10-04-L100	2	11	6.6	10	100	20	0.5	●	
312-12-04-L110	3	12	7.6	12	110	20	0.5	●	
313-12-04-L110	3	13	8.6	12	110	20	0.5	●	
416-16-04-L150	4	16	11.6	16	150	25	0.5	●	
417-16-04-L200	4	17	12.6	16	200	25	0.5	●	
520-20-04-L200	5	20	15.5	20	200	25	0.5	●	
521-20-04-L200	5	21	16.5	20	200	25	0.5	●	

Spare parts

Designation	Screw	Wrench			
	TEBL-04	TS 180411/HG	T 6P		

Cutting Condition E312-E315	Torque E318	Ramping Data E378-E381
--------------------------------	----------------	---------------------------

TEBL-M(S)-04



High feed modular heads

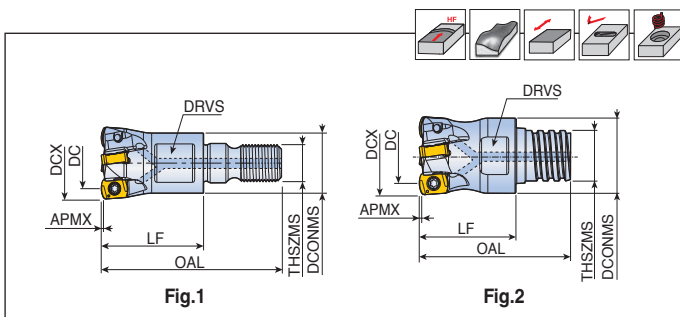

Designation		Dimension (mm)									Coolant hole	Fig.	Insert
		DCX	DC	DCONMS	LF	OAL	THSZMS	APMX	DRVS				
TEBL 210-M06-04	2	10	5.7	9.7	17	31.5	M06	0.5	8	●	1	BLMP 0402... E268	
211-M06-04	2	11	6.6	9.7	17	31.5	M06	0.5	8	●	1		
312-M06-04	3	12	7.6	11	17	31.5	M06	0.5	8	●	1		
313-M06-04	3	13	8.6	11	17	31.5	M06	0.5	8	●	1		
416-M08-04	4	16	11.6	13	23	40.5	M08	0.5	10	●	1		
417-M08-04	4	17	12.6	13	23	40.5	M08	0.5	10	●	1		
520-M10-04	5	20	15.5	18	23	43	M10	0.5	15	●	1		
725-M12-04	7	25	20.6	21	27	49	M12	0.5	17	●	1		
832-M16-04	8	32	27.5	29	27	52	M16	0.5	25	●	1		
TEBL 210-S06-04	2	10	5.6	9.6	15	21.3	S06	0.5	8	●	2		
312-S08-04	3	12	7.6	11.5	16	23.5	S08	0.5	10	●	2		
416-S10-04	4	16	11.6	15.2	20	31.3	S10	0.5	13	●	2		

▶ Matched with T-FLEXTEC holder(Fig.1) & MAXI-RUSH holder(Fig.2)

Spare parts

Designation	Screw	Wrench			
	TEBL-04	 TS 18041/HG	 T 6P		

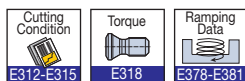

TEBL-06

High feed end mills

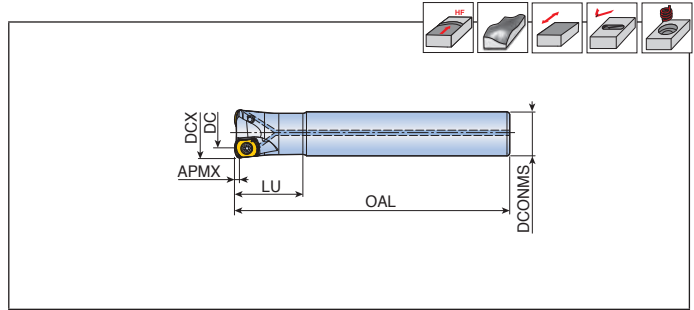

Designation		Dimension (mm)						Coolant hole	Insert
		DCX	DC	DCONMS	OAL	LU	APMX		
TEBL 216-15-06-L150	2	16	9.4	15	150	40	0.7	●	BLMP 0603... E268
216-16-06	2	16	9.4	16	150	40	0.7	●	
216-16-06-S	2	16	9.4	16	100	30	0.7	●	
217-16-06	2	17	10.1	16	150	40	0.7	●	
217-16-06-S	2	17	10.1	16	100	30	0.7	●	
217-16-06-L200	2	17	10.1	16	200	20	0.7	●	
218-16-06	2	18	11.1	16	150	25	0.7	●	
220-20-06-L200	2	20	12.4	20	200	80	1.0	●	
320-19-06-L180	3	20	12.4	19	180	80	1.0	●	
320-20-06	3	20	12.4	20	160	80	1.0	●	
320-20-06-S	3	20	12.4	20	130	50	1.0	●	
420-20-06-S	4	20	12.4	20	130	50	1.0	●	
321-20-06-S	3	21	13.4	20	150	20	1.0	●	
321-20-06-L200	3	21	13.4	20	200	20	1.0	●	
325-25-06-L220	3	25	17.3	25	220	50	1.0	●	
425-24-06-L180	4	25	17.3	24	180	60	1.0	●	
425-25-06	4	25	17.3	25	180	60	1.0	●	
425-25-06-S	4	25	17.3	25	140	60	1.0	●	
525-25-06-S	5	25	17.3	25	140	60	1.0	●	
425-25-06-L250	4	25	17.3	25	250	40	1.0	●	
326-25-06-L200	3	26	18.3	25	200	30	1.0	●	
326-25-06-L250	3	26	18.3	25	250	30	1.0	●	
426-25-06-S	4	26	18.3	25	150	30	1.0	●	
426-25-06-L200	4	26	18.3	25	200	30	1.0	●	
426-25-06-L250	4	26	18.3	25	250	30	1.0	●	
530-32-06-S	5	30	22.3	32	150	70	1.0	●	
530-32-06-L200	5	30	22.3	32	200	120	1.0	●	
432-32-06-S	4	32	24.3	32	150	70	1.0	●	
532-32-06-S	5	32	24.3	32	150	70	1.0	●	
532-32-06-L200	5	32	24.3	32	200	120	1.0	●	
433-32-06-L220	4	33	25.3	32	220	40	1.0	●	
433-32-06-L300	4	33	25.3	32	300	50	1.0	●	
533-32-06-S	5	33	25.3	32	150	30	1.0	●	
533-32-06-L200	5	33	25.3	32	200	40	1.0	●	
533-32-06-L250	5	33	25.3	32	250	40	1.0	●	

 Cutting Condition E312-E315	 Torque E318	 Ramping Data E378-E381
------------------------------------	--------------------	-------------------------------

TEBL-M-06

High feed modular heads

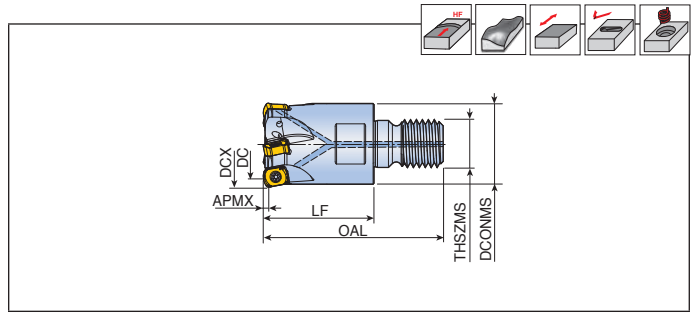

Designation		Dimension (mm)							Coolant hole	Insert
		DCX	DC	DCONMS	LF	OAL	THSZMS	APMX		
TEBL 216-M08-06	2	16	9.4	13	25	42.5	M08	0.7	●	BLMP 0603... E268
217-M08-06	2	17	10.1	13	25	42.5	M08	0.7	●	
218-M08-06	2	18	11.1	13	25	42.5	M08	0.7	●	
220-M10-06	2	20	12.4	18	30	50	M10	1.0	●	
320-M10-06	3	20	12.4	18	30	50	M10	1.0	●	
321-M10-06	3	21	13.4	18	30	50	M10	1.0	●	
322-M10-06	3	22	14.4	18	30	50	M10	1.0	●	
325-M12-06	3	25	17.3	21	35	57	M12	1.0	●	
425-M12-06	4	25	17.3	21	35	57	M12	1.0	●	
326-M12-06	3	26	18.3	21	35	57	M12	1.0	●	
426-M12-06	4	26	18.3	21	35	57	M12	1.0	●	
530-M16-06	5	30	22.3	29	40	65	M16	1.0	●	
432-M16-06	4	32	24.3	29	40	65	M16	1.0	●	
532-M16-06	5	32	24.3	29	40	65	M16	1.0	●	
433-M16-06	4	33	25.3	29	40	65	M16	1.0	●	
533-M16-06	5	33	25.3	29	40	65	M16	1.0	●	
435-M16-06	4	35	27.3	29	43	68	M16	1.0	●	
535-M16-06	5	35	27.3	29	43	68	M16	1.0	●	
640-M16-06	6	40	32.2	29	43	68	M16	1.0	●	
542-M16-06	5	42	34.2	29	43	68	M16	1.0	●	
642-M16-06	6	42	34.2	29	43	68	M16	1.0	●	

► Matched with T-FLEXTEC holder

Spare parts

Designation	Screw	Wrench			
TEBL-06	TS 250641/HG-P	TD 8P			

 Cutting Condition E312-E315	 Torque E318	 Ramping Data E378-E381
------------------------------------	--------------------	-------------------------------

TEBL-09



High feed end mills

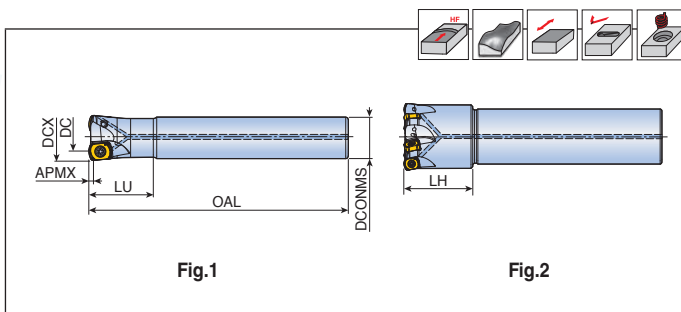

Designation	Flutes	Dimension (mm)							Coolant hole	Fig.	Insert
		DCX	DC	DCONMS	OAL	LU	LH	APMX			
TEBL 225-25-09-L150	2	25	14.7	25	150	70	-	1.5	●	1	BLMP 0904... E268
225-25-09-L200	2	25	14.7	25	200	100	-	1.5	●	1	
325-25-09-L150	3	25	14.7	25	150	70	-	1.5	●	1	
325-25-09-L200	3	25	14.7	25	200	110	-	1.5	●	1	
326-25-09-L150	3	26	15.7	25	150	30	-	1.5	●	1	
326-25-09-L220	3	26	15.7	25	220	30	-	1.5	●	1	
330-32-09-L160	3	30	19.6	32	160	70	-	1.5	●	1	
330-32-09-L220	3	30	19.6	32	220	120	-	1.5	●	1	
332-32-09-L160	3	32	21.6	32	160	70	-	1.5	●	1	
332-32-09-L220	3	32	21.6	32	220	120	-	1.5	●	1	
432-32-09-L160	4	32	21.6	32	160	70	-	1.5	●	1	
432-32-09-L220	4	32	21.6	32	220	120	-	1.5	●	1	
433-32-09-L180	4	33	22.6	32	180	30	-	1.5	●	1	
433-32-09-L250	4	33	22.6	32	250	30	-	1.5	●	1	
440-32-09-L180	4	40	29.6	32	180	-	40	1.5	●	2	
440-32-09-L250	4	40	29.6	32	250	-	40	1.5	●	2	
540-32-09-L180	5	40	29.6	32	180	-	40	1.5	●	2	
540-32-09-L250	5	40	29.6	32	250	-	40	1.5	●	2	

Spare parts

Designation	Screw	Wrench			
	TEBL-09	TS 35A088/HG	TD 10P		

Cutting Condition E312-E315	Torque E318	Ramping Data E378-E381
--------------------------------	----------------	---------------------------

TEBL-M-09

High feed modular heads

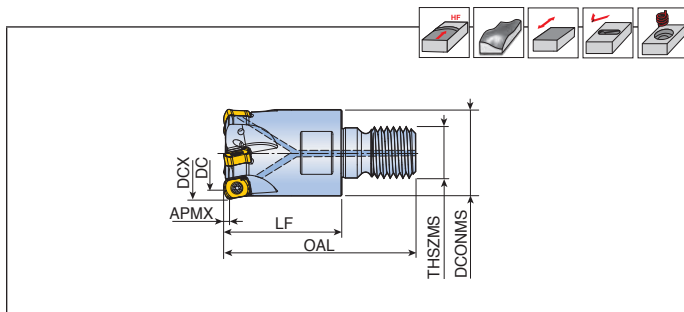

Designation		Dimension (mm)							Coolant hole	Insert
		DCX	DC	DCONMS	LF	OAL	THSZMS	APMX		
TEBL 225-M12-09	2	25	14.7	21	35	57	M12	1.5	●	BLMP 0904... E268
325-M12-09	3	25	14.7	21	35	57	M12	1.5	●	
326-M12-09	3	26	15.7	21	35	57	M12	1.5	●	
330-M16-09	3	30	19.6	29	43	68	M16	1.5	●	
332-M16-09	3	32	21.6	29	43	68	M16	1.5	●	
432-M16-09	4	32	21.6	29	43	68	M16	1.5	●	
433-M16-09	4	33	22.6	29	43	68	M16	1.5	●	
335-M16-09	3	35	24.6	29	43	68	M16	1.5	●	
435-M16-09	4	35	24.6	29	43	68	M16	1.5	●	
440-M16-09	4	40	29.6	29	43	68	M16	1.5	●	
540-M16-09	5	40	29.6	29	43	68	M16	1.5	●	
542-M16-09	5	42	31.6	29	43	68	M16	1.5	●	

► Matched with T-FLEXTEC holder

Spare parts

Designation	Screw	Wrench			
TEBL-09	TS 35A088I/HG	TD 10P			

 Cutting Condition E312-E315	 Torque E318	 Ramping Data E378-E381
------------------------------------	--------------------	-------------------------------

TEBL-11



High feed end mills & modular heads

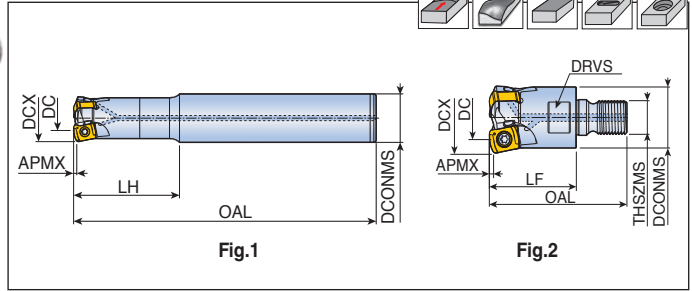

Designation	⌀	Dimension (mm)									Coolant hole	Fig.	Insert
		DCX	DC	DCONMS	OAL	THSZMS	LH	LF	APMX	DRVS			
TEBL 230-32-11-L150	2	30	14.7	32	150	-	70	-	2.0	-	●	1	BLMP 1105... E268
232-32-11-L150	2	32	16.6	32	150	-	70	-	2.0	-	●	1	
232-32-11-L200	2	32	16.6	32	200	-	70	-	2.0	-	●	1	
332-32-11-L200	3	32	16.6	32	200	-	70	-	2.0	-	●	1	
233-32-11-L200	2	33	17.6	32	200	-	40	-	2.0	-	●	1	
233-32-11-L250	2	33	17.6	32	250	-	50	-	2.0	-	●	1	
333-32-11-L250	3	33	17.6	32	250	-	50	-	2.0	-	●	1	
335-32-11-L200	3	35	19.5	32	200	-	40	-	2.0	-	●	1	
340-32-11-L150	3	40	24.4	32	150	-	40	-	2.0	-	●	1	
340-32-11-L200	3	40	24.4	32	200	-	40	-	2.0	-	●	1	
440-32-11-L200	4	40	24.4	32	200	-	40	-	2.0	-	●	1	
TEBL 230-M16-11	2	30	14.7	29	68	M16	-	43	2.0	25	●	2	
232-M16-11	2	32	16.6	29	68	M16	-	43	2.0	25	●	2	
233-M16-11	2	33	17.6	29	68	M16	-	43	2.0	25	●	2	
335-M16-11	3	35	19.5	29	68	M16	-	43	2.0	25	●	2	
340-M16-11	3	40	24.4	29	68	M16	-	43	2.0	25	●	2	
342-M16-11	3	42	26.4	29	68	M16	-	43	2.0	25	●	2	

► Matched with T-FLEXTEC holder(Fig.2)

Spare parts

Designation	Screw	Wrench	Wrench handle		
	TEBL-11	TS 50A1211/HG	TBLD T20-W6	THND 6W	

Cutting Condition E312-E315	Torque E318	Ramping Data E378-E381
--------------------------------	----------------	---------------------------

TEBL-13



High feed end mills & Modular heads

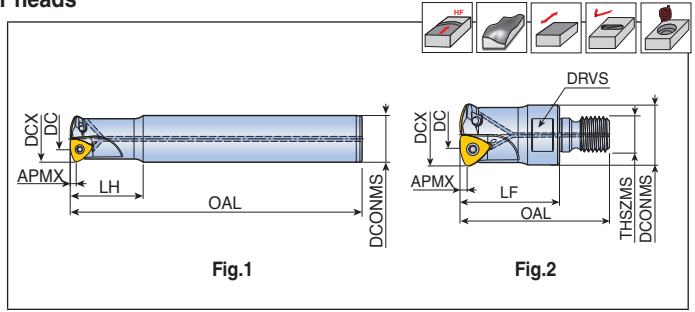
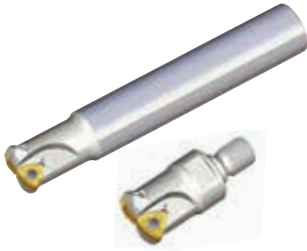

Designation	Flutes	Dimension (mm)										Coolant hole	Fig.	Insert
		DCX	DC	DCONMS	OAL	THSZMS	LH	LF	APMX	DRVS				
TEBL 232-32-13-L150	2	32	12.9	32	150	-	50	-	2.0	-	●	1	BLMP 1306... E269	
232-32-13-L200	2	32	12.9	32	200	-	80	-	2.0	-	●	1		
232-32-13-L	2	32	12.9	32	200	-	120	-	2.0	-	●	1		
233-32-13-L200	2	33	14.3	32	200	-	50	-	2.0	-	●	1		
233-32-13-L250	2	33	14.3	32	250	-	50	-	2.0	-	●	1		
235-32-13-L200	2	35	16.1	32	200	-	30	-	2.0	-	●	1		
240-42-13-XL	2	40	20.7	42	300	-	120	-	2.0	-	●	1		
340-32-13-L150	3	40	20.7	32	150	-	40	-	2.0	-	●	1		
340-32-13-L200	3	40	20.7	32	200	-	70	-	2.0	-	●	1		
340-42-13-S	3	40	20.7	42	150	-	70	-	2.0	-	●	1		
TEBL 232-M16-13	2	32	12.9	30	75	M16	-	50	2.0	25	●	2		
233-M16-13	2	33	14.3	30	75	M16	-	50	2.0	25	●	2		
235-M16-13	2	35	16.1	30	75	M16	-	50	2.0	25	●	2		
340-M16-13	3	40	20.7	30	75	M16	-	50	2.0	25	●	2		
342-M16-13	3	42	22.6	30	75	M16	-	50	2.0	25	●	2		

► Matched with T-FLEXTEC holder(Fig.2)

Spare parts

Designation	Screw	Wrench			
	TEBL-13	TS50B106I/HG	T-T20		

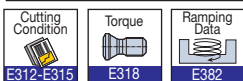

TESB-06/09

High feed end mills

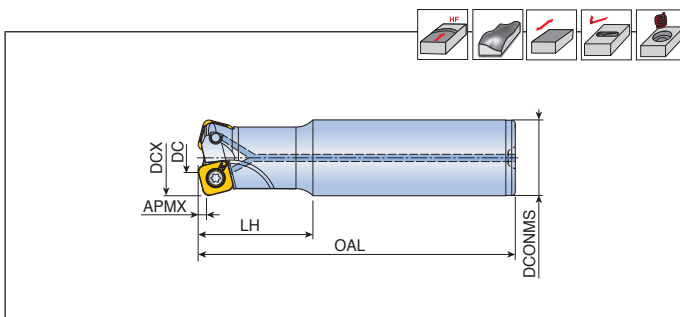

Designation	Flutes	Dimension (mm)						Coolant hole	Insert
		DCX	DC	DCONMS	OAL	LH	APMX		
TESB 216-16-06-L150	2	16	5.9	16	150	40	1.0	●	SBMT 0603... E287
217-16-06-L200	2	17	6.8	16	200	20	1.0	●	
320-20-06-L160	3	20	9.8	20	160	50	1.0	●	
420-20-06-L130	4	20	9.8	20	130	50	1.0	●	
321-20-06-L200	3	21	10.7	20	200	20	1.0	●	
425-25-06-L180	4	25	14.8	25	180	60	1.0	●	
525-25-06-L140	5	25	14.8	25	140	60	1.0	●	
532-32-06-L200	5	32	21.8	32	200	80	1.0	●	
TESB 225-25-09-L150	2	25	10.8	25	150	70	1.2	●	SBMT 0904... E287
225-25-09-L200	2	25	10.8	25	200	70	1.2	●	
325-25-09-L150	3	25	10.8	25	150	70	1.2	●	
325-25-09-L200	3	25	10.8	25	200	70	1.2	●	
226-25-09-L200	2	26	11.7	25	200	30	1.2	●	
226-25-09-L250	2	26	11.7	25	250	30	1.2	●	
326-25-09-L150	3	26	11.7	25	150	30	1.2	●	
326-25-09-L200	3	26	11.7	25	200	30	1.2	●	
326-25-09-L250	3	26	11.7	25	250	30	1.2	●	
330-32-09-L200	3	30	15.5	32	200	70	1.2	●	
332-32-09-L160	3	32	17.4	32	160	70	1.2	●	
332-32-09-L200	3	32	17.4	32	200	70	1.2	●	
332-32-09-L300	3	32	17.4	32	300	70	1.2	●	
432-32-09-L160	4	32	17.4	32	160	70	1.2	●	
432-32-09-L220	4	32	17.4	32	220	70	1.2	●	
233-32-09-L250	2	33	18.4	32	250	30	1.2	●	
333-32-09-L250	3	33	18.4	32	250	30	1.2	●	
333-32-09-L300	3	33	18.4	32	300	30	1.2	●	
433-32-09-L180	4	33	18.4	32	180	30	1.2	●	
433-32-09-L250	4	33	18.4	32	250	30	1.2	●	
335-32-09-L250	3	35	20.4	32	250	30	1.2	●	
440-32-09-L250	4	40	25.4	32	250	40	1.2	●	
440-32-09-L300	4	40	25.4	32	300	40	1.2	●	
540-32-09-L180	5	40	25.4	32	180	40	1.2	●	
540-32-09-L250	5	40	25.4	32	250	40	1.2	●	

Cutting Condition E312-E315	Torque E318	Ramping Data E383-E385
--------------------------------	----------------	---------------------------

TESB-13

High feed end mills

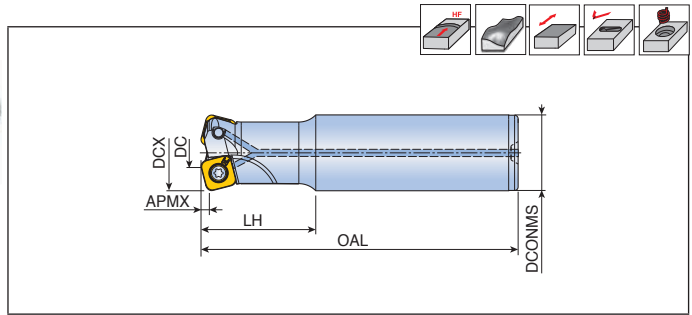
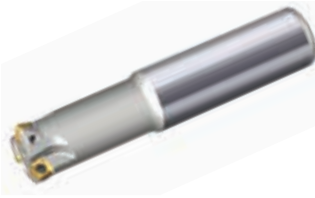

Designation		Dimension (mm)						Coolant hole	Insert
		DCX	DC	DCONMS	OAL	LH	APMX		
TESB 232-32-13-L150	2	32	11.6	32	150	50	2.0	●	SBMT 1306... E287
232-32-13-L200	2	32	11.6	32	200	80	2.0	●	
233-32-13-L200	2	33	12.6	32	200	30	2.0	●	
233-32-13-L250	2	33	12.6	32	250	50	2.0	●	
235-32-13-L200	2	35	14.6	32	200	30	2.0	●	
340-32-13-L150	3	40	19.5	32	150	30	2.0	●	
340-32-13-L200	3	40	19.5	32	200	30	2.0	●	
342-32-13-L200	3	42	21.5	32	200	30	2.0	●	

Spare parts

Designation	Screw	Wrench			
TESB-06	TS 250648I/HG-P	TD 8P	-		
TESB-09	TS 35A088I/HG	TD 10P	-		
TESB-13	TS 50115I	-	T-T20		

 Cutting Condition E312-E315	 Torque E318	 Ramping Data E383-E385
------------------------------------	--------------------	-------------------------------

High feed modular heads

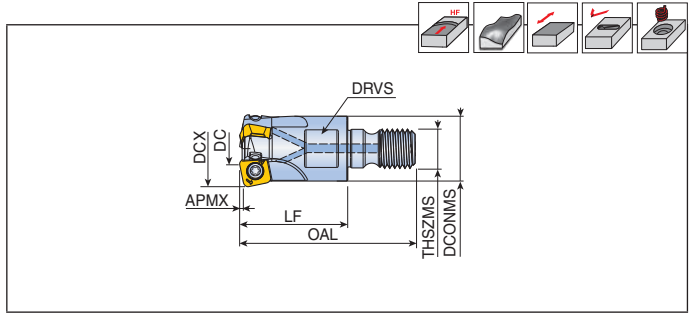

Designation		Dimension (mm)								Coolant hole	Insert
		DCX	DC	DCONMS	LF	OAL	THSZMS	APMX	DRVS		
TESB 216-M08-06	2	16	5.9	13	25	42.5	M08	1.0	10	●	SBMT 0603...
320-M10-06	3	20	9.8	18	30	50	M10	1.0	15	●	E287
425-M12-06	4	25	14.8	21	35	57	M12	1.0	17	●	
532-M16-06	5	32	21.8	29	40	65	M16	1.0	25	●	
TESB 225-M12-09	2	25	10.8	21	35	57	M12	1.2	17	●	SBMT 0904...
325-M12-09	3	25	10.8	21	35	57	M12	1.2	17	●	E287
332-M16-09	3	32	17.4	29	43	68	M16	1.2	25	●	
432-M16-09	4	32	17.4	29	43	68	M16	1.2	25	●	
435-M16-09	4	35	20.4	29	43	68	M16	1.2	25	●	
440-M16-09	4	40	25.4	29	43	68	M16	1.2	25	●	
540-M16-09	5	40	25.4	29	43	68	M16	1.2	25	●	
542-M16-09	5	42	27.4	29	43	68	M16	1.2	25	●	
TESB 232-M16-13	2	32	11.6	29	50	75	M16	2.0	25	●	SBMT 1306...
233-M16-13	2	33	12.6	29	50	75	M16	2.0	25	●	E287
340-M16-13	3	40	19.5	29	50	75	M16	2.0	25	●	
342-M16-13	3	42	21.5	29	50	75	M16	2.0	25	●	

► Matched with T-FLEXTEC holder

Spare parts

Designation	Screw	Wrench			
TESB-06	TS 250648I/HG-P	TD 8P	-		
TESB-09	TS 35A088I/HG	TD 10P	-		
TESB-13	TS 50115I	-	T-T20		

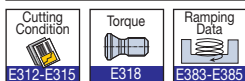

4T-TEF-05/09

Extended flute cutters

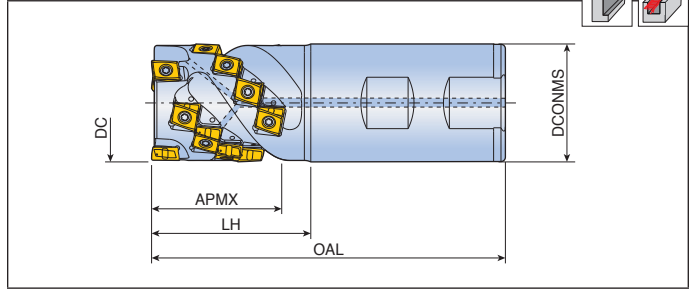

Designation		No. of insert	Dimension (mm)					Coolant hole	Insert
			DC	DCONMS	OAL	LH	APMX		
4T-TEF D16-15-W16-05	2	8	16	16	80	28	15	•	LPK(H)U 0502...
D20-23-W20-05	3	18	20	20	85	33	23	•	
D25-27-W25-05	4	28	25	25	95	35	27	•	
4T-TEF D25-36-W25-09	2	10	25	25	100	43	36	•	LPK(H)U
D32-36-W32-09	3	15	32	32	105	44	36	•	0904...
D32-43-W32-09	3	18	32	32	115	52	43	•	
D40-43-W40-09	3	18	40	40	125	54	43	•	
D40-51-W40-09	3	21	40	40	135	64	51	•	

Spare parts

Designation	Screw	Wrench		Wrench handle	
4T-TEF-05	TS 18049/HG-P	TD 6P	-	-	
4T-TEF-09	TS 30D082-P	-	TBLD T08P-W4	THND 4W	



4T-TES-14



Extended flute cutters

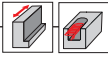
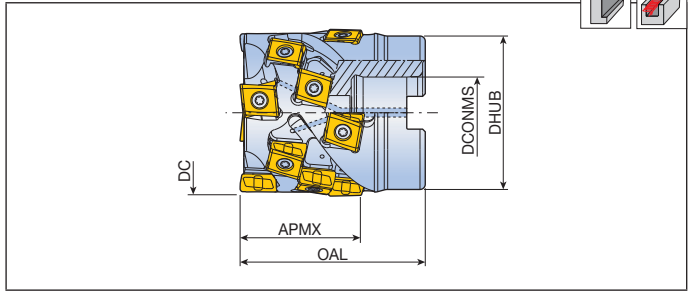

Designation		No. of insert	Dimension (mm)					Coolant hole	Kg	Mounting bolt	Insert	
			DC	DCONMS	DHUB	OAL	APMX					
4T-TES D50-34-22R-14		3	9	50	22	45	55	34	●	0.5	SH M10x40	LPKU 1407... E276
D50-45-22R-14		3	12	50	22	45	65	45	●	0.6	SH M10x50	
D63-45-27R-14		4	16	63	27	58	70	45	●	1.1	SH M12x50	
D63-56-27R-14		4	20	63	27	58	80	56	●	1.3	SH M12x60	
D80-56-32R-14		5	25	80	32	74	85	56	●	2.3	SH M16x60	
D100-56-40R-14		6	30	100	40	94	90	56	●	4.1	SH M20x60	

► Mounting bolt with coolant through hole is available on request (ordering example: SH M10x1.5x30-C)

Spare parts

Designation	Screw	Wrench	Wrench handle		
4T-TES-14	TS 40G110I	TBLD T15-W6	SW6-T		

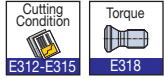

Base unit extended flute cutter

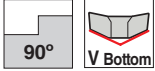
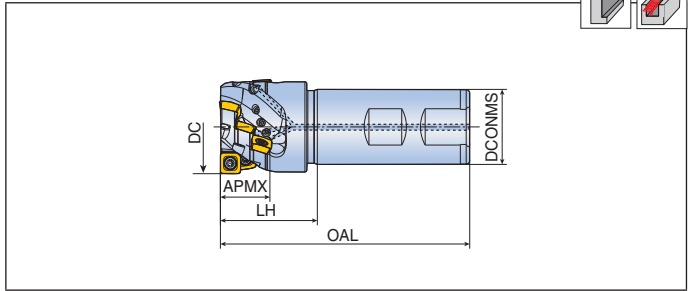
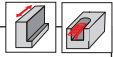

Designation	No. of inserts	Dimension (mm)				Coolant hole	Kg	Mounting bolt	Insert		
		DC	DCONMS	OAL	LH					APMX	
4S-TEF-D40B-21-W32-09V-3F	3	9	40	32	106.4	41.4	21	●	0.6	SH M8X45-C	SVKT 0938... E299

- ▶ Front head ordered separately
- ▶ Note: For bottom facing, both the front head and base unit must be connected.

Spare parts

Designation	Screw	Wrench	Wrench handle	Coolant Nozzle
4S-TEF-09V	TS 35A070I/HG	TBLD T10P-W6	SW6-T	SS 3003-06C

Assembly

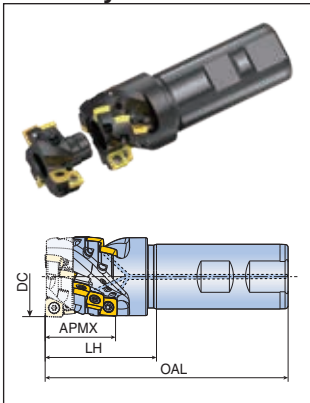

Designation	No. of inserts	Dimension (mm)				
		DC	OAL	LH	APMX	
Head 4S-TFP-D40-14-09V-3F	3	15	40	120	55	34
Base 4S-TEF-D40B-21-W32-09V-3F						



4S-TES-B-09V/11V

Base units for extended flute cutter

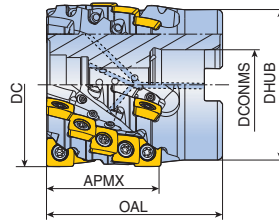
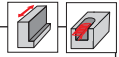

Designation	No. of insert	Dimension (mm)						Coolant hole	Arbor style	kg	Mounting bolt	Insert
		DC	DCONMS	DHUB	OAL	APMX						
4S-TES-D40B-20-16R-09V-3F	3	9	40	16	38	41.4	20	●	A	0.2	SH M8X45-C	SVKT 0938...
D50B-27-22R-09V-5F	5	20	50	22	45	49.4	27	●	A	0.4	LH M10X60-C	E299
D63B-34-27R-09V-6F	6	30	63	27	58	56.4	34	●	A	0.7	LH M12X70-C	SVK(H)T 1145...
4S-TES-D50B-34-22R-11V-4F	4	16	50	22	45	57.8	34	●	A	0.5	SH M10X60-C	E299
D63B-43-27R-11V-5F	5	25	63	27	58	67.8	43	●	A	1.0	SH M12X70-C	
D80B-59-32R-11V-6F	6	42	80	32	76	82.8	59	●	A	2.0	LH M16X80-C	

- ▶ Front head ordered separately
- ▶ Note: For bottom facing, both the front head and base unit must be connected.

Spare parts

Designation	Screw	Wrench	Wrench handle	Coolant Nozzle	
4S-TES-B-09V	TS 35A070I/HG	TBLD T10P-W6	SW6-T	SS 3003-06C	
4S-TES-B-11V	TS 40093I/HG	TBLD T15-W6	SW6-T	SS 3003-06C	

Assembly

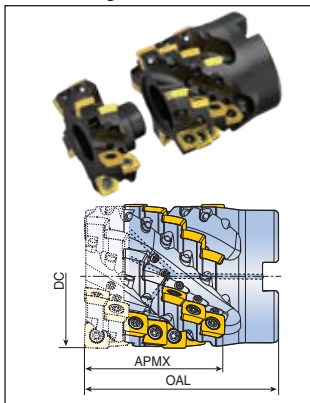

Designation	No. of insert	Dimension (mm)			
		DC	OAL	APMX	
Head 4S-TFP-D40-14-09V-3F	3	15	40	55	34
Base 4S-TES-D40B-20-16R-09V-3F					
Head 4S-TFP-D50-14-09V-5F	5	30	50	63	41
Base 4S-TES-D50B-27-22R-09V-5F					
Head 4S-TFP-D63-14-09V-6F	6	42	63	70	48
Base 4S-TES-D63B-34-27R-09V-6F					
Head 4S-TFP-D50-18-11V-4F	4	24	50	75	52
Base 4S-TES-D50B-34-22R-11V-4F					
Head 4S-TFP-D63-18-11V-5F	5	35	63	85	60
Base 4S-TES-D63B-43-27R-11V-5F					
Head 4S-TFP-D80-18-11V-6F	6	54	80	100	76
Base 4S-TES-D80B-59-32R-11V-6F					



TES-AN11/16



Extended flute cutters

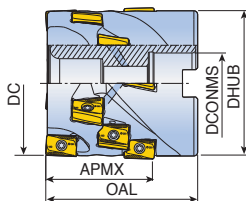
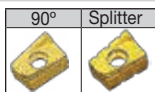

Designation		No. of insert	Dimension (mm)					Coolant hole	Kg	Mounting bolt	Insert	
			DC	DCONMS	DHUB	OAL	APMX					
TES D50-40-22R-AN11		3	12	50	22	45	60	40	●	0.6	SH M10x40	ANM(H)X 1106... E258
D50-40-22R-AN11-4F		4	16	50	22	45	60	40	●	0.6	SH M10x40	
D63-60-27R-AN11		4	24	63	27	60	80	60	●	1.3	SH M12x60	
D80-60-32R-AN11-4F		4	24	80	32	76	80	60	●	2.2	SH M16x60	
D80-60-32R-AN11		5	30	80	32	76	80	60	●	2.3	SH M16x60	
D80-60-32R-AN11-6F		6	36	80	32	76	80	60	●	2.4	SH M16x60	
TES D50-42-22R-AN16		2	6	50	22	47	65	42	●	0.7	SH M10x40	ANM(H)X 1607... E258
D63-42-27R-AN16		3	9	63	27	60.5	70	42	●	1.1	SH M12x50	
D63-42-27R-AN16-4F		4	12	63	27	60.5	70	42	●	1.0	SH M12x50	
D63-56-27R-AN16-2F		2	8	63	27	60.5	80	56	●	1.2	SH M12x50	
D63-56-27R-AN16		3	12	63	27	60.5	80	56	●	1.3	SH M12x50	
D63-56-27R-AN16-4F		4	16	63	27	60.5	80	56	●	1.2	SH M12x50	
D80-56-32R-AN16		4	16	80	32	76.5	80	56	●	2.2	SH M16x50	
D100-69-40R-AN16-4F		4	20	100	40	96.4	100	69	●	4.1	SH M20x60	
D100-69-40R-AN16		5	25	100	40	96.4	100	69	●	4.5	SH M20x60	
D100-69-40R-AN16-6F		6	30	100	40	96.4	100	69	●	4.0	SH M20x60	

► Mounting bolt with coolant through hole is available on request (ordering example: SH M10x1.5x30-C)

Spare parts

Designation	Screw	Wrench			
TES-AN11	TS 35A088I/HG	TD 10P	-		
TES-AN16	TS 40120I/HG	-	T-T15		



TEF-AP(AX)

Extended flute cutters

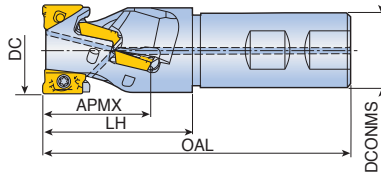
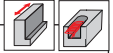

Designation		No. of insert	Dimension (mm)						Coolant hole	Insert
			DC	DCONMS	OAL	LH	APMX			
TEF D16-16-W16-AX06	2	6	16	16	80	28	16	x	AXM(C)T 0602...	
	3	12	20	20	85	33	21	●	E266	
	4	20	25	25	95	38	26	●		
2S-TEF D20-25-W20-AP09	1	3	20	20	110	38	26	●	APK(C)T 09T3...	
	2	10	25	25	115	48	42	●	E259	
	2	10	32	32	120	51	42	●		
TEF D25-34-W25-AP12	2	6	25	25	120	47	34	●	APK(C)T 1204...	
	2	8	32	32	120	58	45	●	E260	
	3	12	40	32	140	65	45	●		
TEF D32-30-W32-AP17	2	4	32	32	120	50	30	●	APK(C)T 1705...	
	2	6	40	32	140	65	44	●	E261-E262	

Spare parts

Designation	Screw	Wrench			
	TEF-AX06	TS 18041 I/HG	TD 6P		
2S-TEF-AP09	TS 25055I/HG	TD 8			
TEF-AP12 (Ø25)	TS 35A070I/HG	TD 10P			
TEF-AP12 (Ø32-)	TS 35A088I/HG	TD 10P			
TEF-AP17	TS 40093I/HG	TD 15			



TES-AP12/17

Extended flute cutters

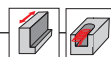
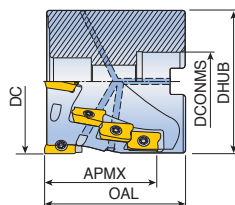

Designation		No. of insert	Dimension (mm)					Coolant hole	Kg	Mounting bolt	Insert	
			DC	DCONMS	DHUB	OAL	APMX					
TESD50-45-22R-AP12		4	16	50	22	47	65	45	●	0.6	SH M10x50	APK(C)T 1204... E260
D63-56-27R-AP12		5	25	63	27	60	75	56	●	1.2	SH M10x50	
TESD50-44-22-AP17		2	6	50	22	48.2	60	44	●	0.5	SH M10x40	APK(C)T 1705... E261-E262
D63-44-27-AP17		3	9	63	27	60.8	63	44	●	0.9	SH M12x40	
D63-44-27-AP17-4F		4	12	63	27	60.8	63	44	●	0.9	SH M12x40	
D80-58-32-AP17		4	16	80	32	78.4	75	58	●	1.9	SH M16x50	
D100-88-40-AP17-4F		4	24	100	40	97.4	110	88	●	4.4	SH M20x80	
D100-88-40-AP17		5	30	100	40	97.4	110	88	●	4.8	SH M20x80	

► Mounting bolt with coolant through hole is available on request (ordering example: SH M10x1.5x30-C)

Spare parts

Designation	Screw	Wrench			
TES-AP12	TS 35A088I/HG	TD 10P	-		
TES-AP17	TS 40093I/HG	-	T-T15		



Extended flute cutters

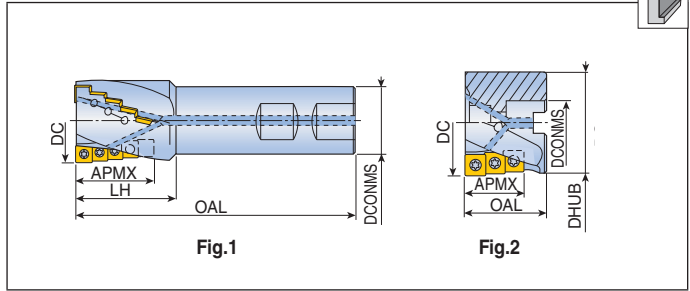

Designation	No. of insert	Dimension (mm)							Coolant hole	Fig.	Mounting bolt	Insert
		DC	DCONMS	DHUB	OAL	LH	APMX					
TEF D32-23-W32-09	2	6	32	32	-	120	40	23.8	●	1		SPMG(T) 090408-EM
D40-38-W32-11	2	8	40	32	-	130	60	38.9	●	1		SPMG(T)110408-EM
D50-48-W40-11	3	15	50	40	-	140	70	48.4	●	1		E295
D50-48-W42-11	3	15	50	42	-	140	70	48.4	●	1		E295
TES D50-29-22-11	3	9	50	22	47.3	52	-	29.0	●	2	SH M10x30	SPMG(T) 110408-EM
D63-35-27-11	4	16	63	27	60.5	55	-	35.0	●	2	SH M12x35	E295
D80-47-32-14	4	16	80	32	77.2	65	-	47.0	●	2	SH M16x40	SPMG(T)140508-EM
												E295

▶ Mounting bolt with coolant through hole is available on request (ordering example: SH M10x1.5x30-C)

Spare parts

Designation	Screw	Wrench			
TEF-SP09 (Ø32)	TS 35088I	TD 10	-		
TEF-SP11 (Ø40-Ø50)	TS 40093I	TD 15	-		
TES-SP11 (Ø50-Ø63)	TS 40093I	TD 15	-		
TES-SP14 (Ø80)	TS 50A121I/HG	-	T-T20		

 E312-E315	 E316-E317	 E318
---------------	---------------	----------

Slotting cutters: End mills

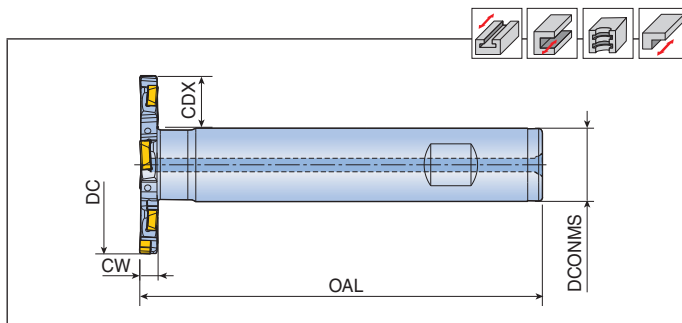

Designation	CW (mm)		Dimension (mm)				Coolant hole	Insert
			DC	DCONMS	OAL	CDX		
TSM D25-03-W12-SL18	3	1+1	25	12	90	6.5	●	SLOT 018...
D32-03-W16-SL18	3	2+2	32	16	90	8.0	●	E290
D40-03-W16-SL18	3	3+3	40	16	105	12.0	●	
D50-03-W20-SL18	3	4+4	50	20	110	15.0	●	
D63-03-W20-SL18	3	5+5	63	20	110	21.5	●	
TSM D25-04-W12-SL23	4	1+1	25	12	90	6.5	●	SLOT 023...
D32-04-W16-SL23	4	2+2	32	16	90	8.0	●	E290
D40-04-W16-SL23	4	3+3	40	16	105	12.0	●	
D50-04-W20-SL23	4	4+4	50	20	110	15.0	●	
D63-04-W20-SL23	4	5+5	63	20	110	21.5	●	
TSM D25-05-W12-SL28	5	1+1	25	12	90	6.5	●	SLOT 028...
D32-05-W16-SL28	5	2+2	32	16	90	8.0	●	E290
D40-05-W16-SL28	5	3+3	40	16	105	12.0	●	
D50-05-W20-SL28	5	4+4	50	20	110	15.0	●	
D63-05-W20-SL28	5	5+5	63	20	110	21.5	●	
TSM D25-06-W12-SL33	6	1+1	25	12	90	6.5	●	SLOT 033...
D32-06-W16-SL33	6	2+2	32	16	90	8.0	●	E290
D40-06-W16-SL33	6	3+3	40	16	105	12.0	●	
D50-06-W20-SL33	6	4+4	50	20	110	15.0	●	
D63-06-W20-SL33	6	5+5	63	20	110	21.5	●	

Spare parts

Designation	Screw	Wrench			
TSM-03-SL18	TS 25B024/HG	TD 7P	L-T7P		
TSM-04-SL23	TS 25B031/HG	TD 7P	L-T7P		
TSM-05-SL28	TS 25B042/HG	TD 7P	L-T7P		
TSM-06-SL33	TS 25B053/HG	TD 7P	L-T7P		



Slotting cutters: modular heads

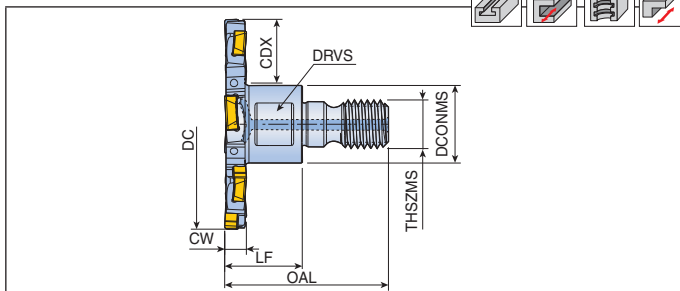

Designation	CW (mm)		Dimension (mm)								Coolant hole	Insert
			DC	DCONMS	LF	OAL	THSZMS	CDX	DRVS			
TSM D25-03-M08-SL18	3	1+1	25	13	18	35.5	M08	6	10	●	SLOT 018...	
D32-03-M08-SL18	3	2+2	32	13	18	35.5	M08	9	10	●	E290	
D40-03-M08-SL18	3	3+3	40	13	18	35.5	M08	13	10	●		
D50-03-M10-SL18	3	4+4	50	18	18	38	M10	15	15	●		
D63-03-M10-SL18	3	5+5	63	18	18	38	M10	22	15	●		
TSM D25-04-M08-SL23	4	1+1	25	13	18	35.5	M08	6	10	●	SLOT 023...	
D32-04-M08-SL23	4	2+2	32	13	18	35.5	M08	9	10	●	E290	
D40-04-M08-SL23	4	3+3	40	13	18	35.5	M08	13	10	●		
D50-04-M10-SL23	4	4+4	50	18	18	38	M10	15	15	●		
D63-04-M10-SL23	4	5+5	63	18	18	38	M10	22	15	●		
TSM D25-05-M08-SL28	5	1+1	25	13	18	35.5	M08	6	10	●	SLOT 028...	
D32-05-M08-SL28	5	2+2	32	13	18	35.5	M08	9	10	●	E290	
D40-05-M08-SL28	5	3+3	40	13	18	35.5	M08	13	10	●		
D50-05-M10-SL28	5	4+4	50	18	18	38	M10	15	15	●		
D63-05-M10-SL28	5	5+5	63	18	18	38	M10	22	15	●		
TSM D25-06-M08-SL33	6	1+1	25	13	18	35.5	M08	6	10	●	SLOT 033...	
D32-06-M08-SL33	6	2+2	32	13	18	35.5	M08	9	10	●	E290	
D40-06-M08-SL33	6	3+3	40	13	18	35.5	M08	13	10	●		
D50-06-M10-SL33	6	4+4	50	18	18	38	M10	15	15	●		
D63-06-M10-SL33	6	5+5	63	18	18	38	M10	22	15	●		

► Matched with T-FLEXTEC holder

Spare parts

Designation	Screw	Wrench			
TSM-03-SL18	TS 25B024I/HG	TD 7P	L-T7P		
TSM-04-SL23	TS 25B031I/HG	TD 7P	L-T7P		
TSM-05-SL28	TS 25B042I/HG	TD 7P	L-T7P		
TSM-06-SL33	TS 25B053I/HG	TD 7P	L-T7P		



Slotting cutters: Fixed pocket disk type

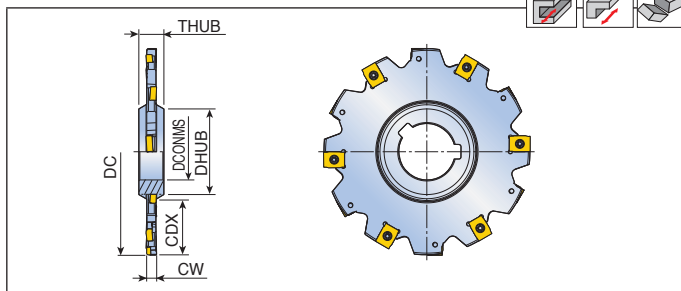
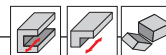

Designation	CW (mm)		Dimension (mm)					Kg	Insert
			DC	DCONMS	DHUB	OAL	CDX		
TSM 063FD-03-22N-Z018	3	4+4	63	22	34	8	12.0	0.1	ZNHT 018...
080FD-03-22N-Z018	3	5+5	80	22	34	8	20.5	0.1	E308
100FD-03-27N-Z018	3	6+6	100	27	41	12	26.0	0.2	
125FD-03-40N-Z018	3	7+7	125	40	55	12	31.5	0.3	
160FD-03-40N-Z018	3	9+9	160	40	55	12	49.0	0.4	
TSM 063FD-04-22N-Z023	4	4+4	63	22	34	8	12.0	0.1	ZNHT 023...
080FD-04-22N-Z023	4	5+5	80	22	34	8	21.0	0.1	E308
100FD-04-27N-Z023	4	6+6	100	27	41	12	27.0	0.2	
125FD-04-40N-Z023	4	7+7	125	40	55	12	32.0	0.4	
160FD-04-40N-Z023	4	9+9	160	40	55	12	50.0	0.6	
TSM 063FD-05-22N-Z028	5	4+4	63	22	34	8	13.0	0.1	ZNHT 028...
080FD-05-22N-Z028	5	5+5	80	22	34	8	21.0	0.2	E308
100FD-05-27N-Z028	5	6+6	100	27	41	12	27.0	0.3	
125FD-05-40N-Z028	5	7+7	125	40	55	12	33.0	0.4	
160FD-05-40N-Z028	5	9+9	160	40	55	12	50.0	0.7	
TSM 063FD-06-22N-Z033	6	4+4	63	22	34	8	13.0	0.1	ZNHT 033...
080FD-06-22N-Z033	6	5+5	80	22	34	8	21.5	0.2	E308
100FD-06-27N-Z033	6	6+6	100	27	41	12	27.0	0.3	
125FD-06-40N-Z033	6	7+7	125	40	55	12	33.0	0.5	
160FD-06-40N-Z033	6	9+9	160	40	55	12	50.0	0.8	
200FD-06-50N-Z033	6	10+10	200	50	69	12	63.0	1.2	
250FD-06-50N-Z033	6	12+12	250	50	69	12	88.0	2.0	
TSM 080FD-07-22N-Z038	7	4+4	80	22	34	12	20.0	0.2	ZNHT 038...
100FD-07-27N-Z038	7	5+5	100	27	41	12	26.5	0.3	E308
125FD-07-40N-Z038	7	6+6	125	40	55	12	32.0	0.5	
160FD-07-40N-Z038	7	8+8	160	40	55	12	49.5	0.8	
200FD-07-50N-Z038	7	9+9	200	50	69	12	62.5	1.3	
250FD-07-50N-Z038	7	12+12	250	50	69	12	87.5	1.9	



Slotting cutters: Fixed pocket disk type

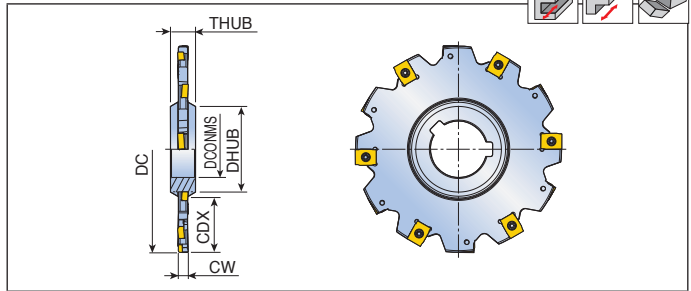
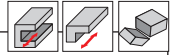

Designation	CW (mm)		Dimension (mm)					Kg	Insert
			DC	DCONMS	DHUB	OAL	CDX		
TSM 080FD-08-22N-Z043	8	4+4	80	22	34	12	20.5	0.2	ZNHT 043...
100FD-08-27N-Z043	8	5+5	100	27	41	12	27.0	0.3	E308
125FD-08-40N-Z043	8	6+6	125	40	55	12	32.5	0.5	
160FD-08-40N-Z043	8	8+8	160	40	55	12	50.0	0.9	
200FD-08-50N-Z043	8	9+9	200	50	69	12	63.0	1.4	
250FD-08-50N-Z043	8	12+12	250	50	69	12	88.0	2.3	
TSM 100FD-09-27N-Z048	9	5+5	100	27	41	12	27.5	0.4	ZNHT 048...
125FD-09-40N-Z048	9	6+6	125	40	55	12	33.0	0.6	E308
160FD-09-40N-Z048	9	8+8	160	40	55	12	50.5	1.0	
200FD-09-50N-Z048	9	9+9	200	50	69	12	63.5	1.6	
250FD-09-50N-Z048	9	12+12	250	50	69	12	88.5	2.6	
TSM 100FD-10-27N-Z053	10	5+5	100	27	41	12	28.0	0.4	ZNHT 053...
125FD-10-40N-Z053	10	6+6	125	40	55	12	33.5	0.6	E308
160FD-10-40N-Z053	10	8+8	160	40	55	12	51.0	1.3	
200FD-10-50N-Z053	10	9+9	200	50	69	12	64.0	2.0	
250FD-10-50N-Z053	10	12+12	250	50	69	12	89.0	3.2	

► Arbor: SCA, SEMC

Spare parts

Designation	Screw			Wrench		Designation	Screw		Wrench	
TSM-Z018	TS 25B024I/HG			TD 7P	L-T7P	TSM-Z038	TS 40K0535I		T-T15	L-T15
TSM-Z023	TS 25B031I/HG			TD 7P	L-T7P	TSM-Z043	TS 40K065I		T-T15	L-T15
TSM-Z028	TS 25B042I/HG			TD 7P	L-T7P	TSM-Z048	TS 40K075I		T-T15	L-T15
TSM-Z033	TS 25B053I/HG			TD 7P	L-T7P	TSM-Z053	TS 40K085I		T-T15	L-T15

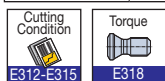

TSM FD-N-ZN08/11



Slotting cutters: Fixed pocket disk type

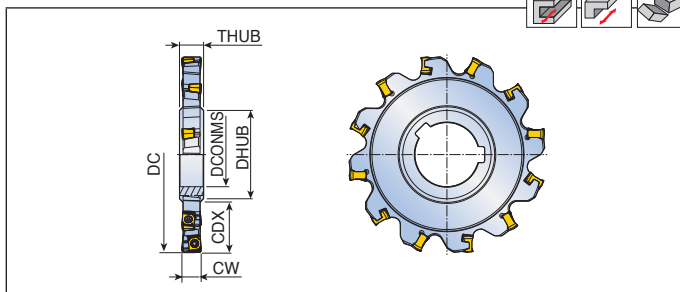
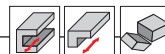

Designation	CW (mm)		Dimension (mm)						Insert
			DC	DCONMS	DHUB	OAL	CDX		
TSM 080FD-10-27N-ZN08	10.0	4+4	80	27	41	15	15.5	0.3	ZNHU 080...
100FD-10-27N-ZN08	10.0	5+5	100	27	41	15	25.5	0.5	E309
125FD-10-40N-ZN08	10.0	6+6	125	40	55	15	31.0	0.7	
080FD-12-27N-ZN08	12.0	4+4	80	27	41	15	16.5	0.3	
100FD-12-27N-ZN08	12.0	5+5	100	27	41	15	26.5	0.5	
125FD-12-40N-ZN08	12.0	6+6	125	40	55	15	32.0	0.8	
TSM 125FD-14-40N-ZN11	14.0	6+6	125	40	55	15	34.5	0.9	ZNHU 110...
125FD-17-40N-ZN11	17.0	6+6	125	40	55	18	34.5	1.1	E309
125FD-20-40N-ZN11	20.0	6+6	125	40	55	20	34.5	1.3	

▶ Arbor: SCA, SEMC

Spare parts

Designation	Screw	Wrench			
TSM FD-ZN08	TS 300851/HG	TD 9	-		
TSM FD-ZN11	TS 401201/HG	-	T-T15		

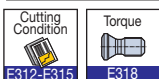

TSM FD-S/W-ZN08



Slotting cutters: Adjustable disk type

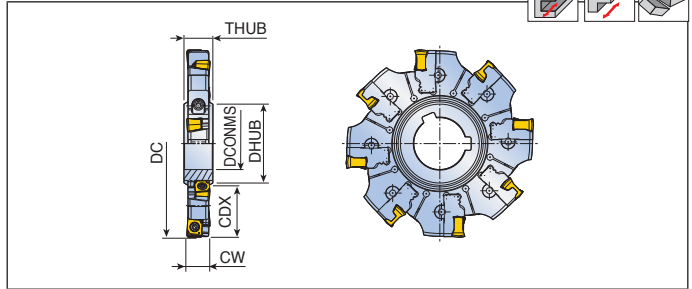
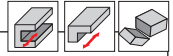

Designation	CW (mm)		Dimension (mm)						Insert
			DC	DCONMS	DHUB	OAL	CDX		
TSM 100FD-S-27N-ZN08	10-12	4+4	100	27	41	15	26.5	0.4	ZNHU 080... E309
125FD-S-40N-ZN08	10-12	5+5	125	40	55	15	31.5	0.7	
160FD-S-40N-ZN08	10-12	6+6	160	40	55	15	48.5	1.1	
200FD-S-50N-ZN08	10-12	8+8	200	50	69	15	61.5	1.8	
250FD-S-50N-ZN08	10-12	9+9	250	50	69	15	87.5	2.8	
100FD-W-27N-ZN08	12-14	4+4	100	27	41	15	27.0	0.5	
125FD-W-40N-ZN08	12-14	5+5	125	40	55	15	31.5	0.8	
160FD-W-40N-ZN08	12-14	6+6	160	40	55	15	49.5	1.3	
200FD-W-50N-ZN08	12-14	8+8	200	50	69	15	62.5	2.1	
250FD-W-50N-ZN08	12-14	9+9	250	50	69	15	87.5	3.4	

- ▶ Width of cut is set at the smallest unless a specific width is requested
- ▶ Arbor: SCA, SEMC

Spare parts

Designation	Right cartridge	Left cartridge	Wedge	Adjust screw	Insert screw
TSM FD-S/W-ZN08					
	TCT-SR-ZN08 TCT-WR-ZN08	TCT-SL-ZN08 TCT-WL-ZN08	WFZ 5	SA M8-6.0	TS 30085I/HG
	Wedge screw	Wrench	L-Wrench	Wedge Wrench	
	WS 5	TD 9	L-W 3	F-W 2.5	

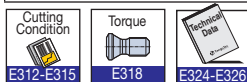

TSM FD-S/W-ZN11



Slotting cutters: Adjustable disk type

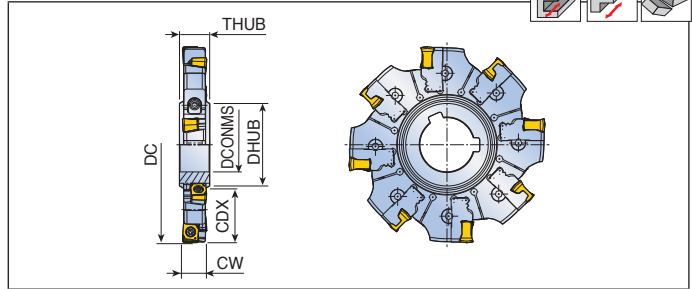
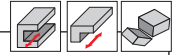

Designation	CW (mm)		Dimension (mm)					Kg	Insert
			DC	DCONMS	DHUB	OAL	CDX		
TSM 100FD-S-27N-ZN11	14-17	3+3	100	27	41	18	28.0	0.6	ZNHU 110... E309
125FD-S-40N-ZN11	14-17	4+4	125	40	55	18	31.0	1.0	
160FD-S-40N-ZN11	14-17	6+6	160	40	55	18	48.5	1.6	
200FD-S-50N-ZN11	14-17	7+7	200	50	69	18	61.5	2.6	
250FD-S-50N-ZN11	14-17	9+9	250	50	69	18	86.5	4.2	
100FD-W-27N-ZN11	17-20	3+3	100	27	41	22	28.0	0.8	
125FD-W-40N-ZN11	17-20	4+4	125	40	55	22	31.0	1.2	
160FD-W-40N-ZN11	17-20	6+6	160	40	55	22	48.5	2.0	
200FD-W-50N-ZN11	17-20	7+7	200	50	69	22	61.5	3.2	
250FD-W-50N-ZN11	17-20	9+9	250	50	69	22	86.5	5.2	
315FD-W-60N-ZN11	17-20	12+12	315	60	85	22	110.0	8.5	

- ▶ Width of cut is set at the smallest unless a specific width is requested
- ▶ Arbor: SCA, SEMC

Spare parts

Designation	Right cartridge	Left cartridge	Wedge	Adjust screw	Insert screw
TSM FD-S/W-ZN11					
	TCT-SR-ZN11 TCT-WR-ZN11	TCT-SL-ZN11 TCT-WL-ZN11	WFZ 6	SA M8-9.0	TS 40120I/HG
	Wedge screw	Wrench	L-Wrench	Wedge Wrench	
	 WS 6	 T-T15	 L-W 4	 T-W 3	

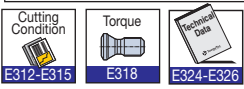

TSM FD-S/W-ZN14



Slotting cutters: Adjustable disk type

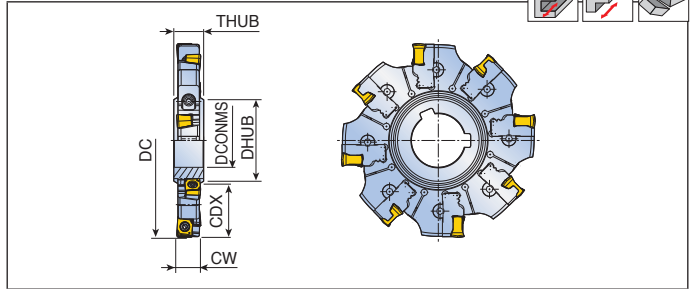
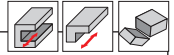

Designation	CW (mm)		Dimension (mm)						Insert
			DC	DCONMS	DHUB	OAL	CDX		
TSM 125FD-S-40N-ZN14	20-23	3+3	125	40	55	24.5	32.0	1.4	ZNHU 140... E309
160FD-S-40N-ZN14	20-23	5+5	160	40	55	24.5	49.0	2.4	
200FD-S-50N-ZN14	20-23	6+6	200	50	69	24.5	62.5	3.9	
250FD-S-50N-ZN14	20-23	8+8	250	50	69	24.5	87.0	6.3	
315FD-S-60N-ZN14	20-23	10+10	315	60	85	24.5	111.5	10.2	
125FD-W-40N-ZN14	23-26	3+3	125	40	55	27.5	32.0	1.6	
160FD-W-40N-ZN14	23-26	5+5	160	40	55	27.5	49.0	2.7	
200FD-W-50N-ZN14	23-26	6+6	200	50	69	27.5	62.5	4.3	
250FD-W-50N-ZN14	23-26	8+8	250	50	69	27.5	87.0	7.1	
315FD-W-60N-ZN14	23-26	10+10	315	60	85	27.5	111.5	11.6	

- ▶ Width of cut is set at the smallest unless a specific width is requested
- ▶ Arbor: SCA, SEMC

Spare parts

Designation	Right cartridge	Left cartridge	Wedge	Adjust screw	Insert screw
TSM FD-S/W-ZN14					
	TCT-SR-ZN14	TCT-SL-ZN14	WFZ 6	SA M8-9.0	TS 40120/HG
	Wedge screw	Wrench	L-Wrench	Wedge Wrench	
	WS 6	T-T15	L-W 4	T-W 3	

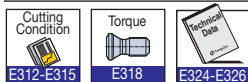

Slotting cutters: Fixed pocket flange type

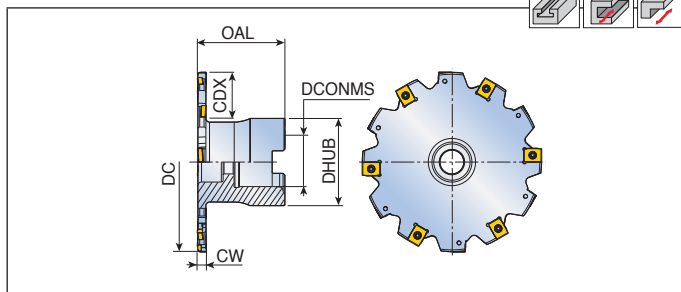
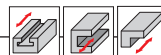

Designation	CW (mm)		Dimension (mm)					Arbor style	Kg	Mounting bolt	Insert
			DC	DCONMS	DHUB	OAL	CDX				
TSM 080FF-03-22R-Z018	3	5+5	80	22	40	50	20.0	A	0.4	SH M10x35	ZNHT 018...
100FF-03-27R-Z018	3	6+6	100	27	48	50	26.0	A	0.6	SH M12x35	ZNHT 023...
080FF-04-22R-Z023	4	5+5	80	22	40	50	20.0	A	0.4	SH M10x35	
100FF-04-27R-Z023	4	6+6	100	27	48	50	26.0	A	0.6	SH M12x35	ZNHT 028...
080FF-05-22R-Z028	5	5+5	80	22	40	50	20.0	A	0.5	SH M10x35	
100FF-05-27R-Z028	5	6+6	100	27	48	50	26.0	A	0.7	SH M12x35	ZNHT 033...
080FF-06-22R-Z033	6	5+5	80	22	40	50	20.0	A	0.5	SH M10x35	
100FF-06-27R-Z033	6	6+6	100	27	48	50	26.0	A	0.7	SH M12x35	
125FF-06-40R-Z033	6	7+7	125	40	70	50	25.0	B	1.1	-	
160FF-06-40R-Z033	6	9+9	160	40	70	50	43.0	B	1.4	-	ZNHT 038...
080FF-07-22R-Z038	7	4+4	80	22	40	50	20.0	A	0.5	SH M10x40	
100FF-07-27R-Z038	7	5+5	100	27	48	50	25.5	A	0.7	SH M12x35	
125FF-07-40R-Z038	7	6+6	125	40	70	50	24.5	B	1.1	-	
160FF-07-40R-Z038	7	8+8	160	40	70	50	42.0	B	1.4	-	ZNHT 043...
080FF-08-22R-Z043	8	4+4	80	22	40	50	20.0	A	0.5	SH M10x35	
100FF-08-27R-Z043	8	5+5	100	27	48	50	25.5	A	0.8	SH M12x35	
125FF-08-40R-Z043	8	6+6	125	40	70	50	24.5	B	1.2	-	
160FF-08-40R-Z043	8	8+8	160	40	70	50	42.0	B	1.5	-	ZNHT 048...
100FF-09-27R-Z048	9	5+5	100	27	48	50	26.0	A	0.7	SH M12x35	
125FF-09-40R-Z048	9	6+6	125	40	70	50	24.5	B	1.2	-	
160FF-09-40R-Z048	9	8+8	160	40	70	50	42.0	B	1.6	-	
100FF-10-27R-Z053	10	5+5	100	27	48	50	26.0	A	0.8	SH M12x35	ZNHT 053...
125FF-10-40R-Z053	10	6+6	125	40	70	50	24.5	B	1.4	-	
160FF-10-40R-Z053	10	8+8	160	40	70	50	42.0	B	1.7	-	

Spare parts

Designation	Screw			Wrench			Designation	Screw			Wrench		
TSM-Z018	TS 25B0241/HG			TD 7P		L-T7P	TSM-Z038	TS 40K0535I			T-T15		L-T15
TSM-Z023	TS 25B0311/HG			TD 7P		L-T7P	TSM-Z043	TS 40K065I			T-T15		L-T15
TSM-Z028	TS 25B0421/HG			TD 7P		L-T7P	TSM-Z048	TS 40K075I			T-T15		L-T15
TSM-Z033	TS 25B0531/HG			TD 7P		L-T7P	TSM-Z053	TS 40K085I			T-T15		L-T15



Slotting cutters: Fixed pocket flange type

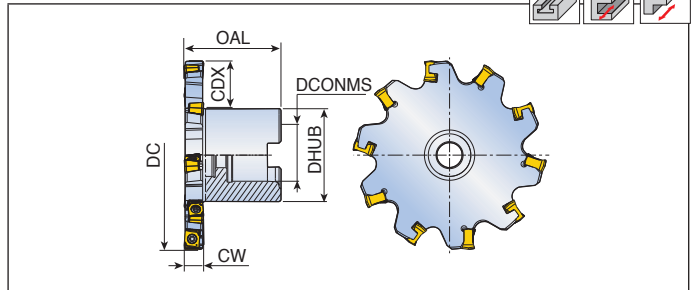
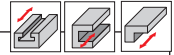

Designation	CW (mm)		Dimension (mm)					Arbor style	Kg	Mounting bolt	Insert
			DC	DCONMS	DHUB	OAL	CDX				
TSM 063FF-10-22R-ZN08	10.0	3+3	63	22	40	50	15	A	0.4	SH M10x35	ZNHU 080... E309
080FF-10-22R-ZN08	10.0	4+4	80	22	40	50	24	A	0.5	SH M10x35	
100FF-10-27R-ZN08	10.0	5+5	100	27	48	50	26	A	0.8	SH M12x35	
125FF-10-32R-ZN08	10.0	6+6	125	32	58	50	34	B	1.1	-	
063FF-12-22R-ZN08	12.0	3+3	63	22	40	50	15	A	0.4	SH M10x35	
080FF-12-22R-ZN08	12.0	4+4	80	22	40	50	24	A	0.5	SH M10x35	
100FF-12-27R-ZN08	12.0	5+5	100	27	48	50	26	A	0.9	SH M12x35	ZNHU 110... E309
125FF-12-32R-ZN08	12.0	6+6	125	32	58	50	34	B	1.2	-	
TSM 063FF-14-22R-ZN11	14.0	3+3	63	22	40	50	15	A	0.4	SH M10x35	
080FF-14-22R-ZN11	14.0	4+4	80	22	40	50	24	A	0.5	SH M10x35	
100FF-14-27R-ZN11	14.0	5+5	100	27	48	50	26	A	1.0	SH M12x35	
125FF-14-32R-ZN11	14.0	6+6	125	32	58	50	34	B	1.3	-	
160FF-14-40R-ZN11	14.0	6+6	160	40	70	50	43	B	2.5	-	
080FF-17-22R-ZN11	17.0	4+4	80	22	40	50	24	A	0.6	SH M10x35	
100FF-17-27R-ZN11	17.0	5+5	100	27	48	50	26	A	1.0	SH M12x35	
125FF-17-32R-ZN11	17.0	6+6	125	32	58	50	34	B	1.5	-	
080FF-20-22R-ZN11	20.0	4+4	80	22	40	50	24	A	0.7	SH M10x35	
100FF-20-27R-ZN11	20.0	5+5	100	27	48	50	26	A	1.1	SH M12x35	
125FF-20-32R-ZN11	20.0	6+6	125	32	58	50	34	B	1.6	-	

Spare parts

Designation	Screw	Wrench			
TSM FF-ZN08	TS 30085I/HG	TD 9	-		
TSM FF-ZN11	TS 40120I/HG	-	T-T15		

 E312-E315	 E316-E317	 E318
---------------	---------------	----------

TSM FF-S/W-ZN08



Slotting cutters: Adjustable flange type

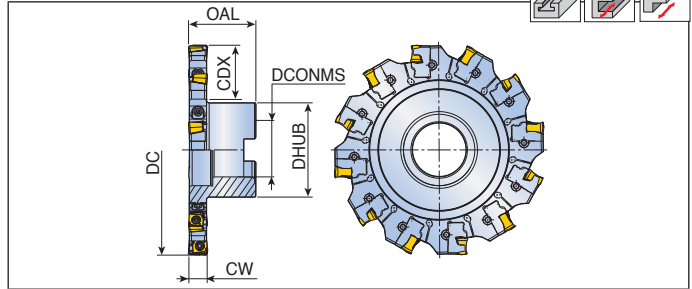
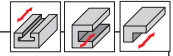

Designation	CW (mm)		Dimension (mm)					Arbor style	Kg	Mounting bolt	Insert
			DC	DCONMS	DHUB	OAL	CDX				
TSM 100FF-S-27R-ZN08	10-12	4+4	100	27	48	50	25	A	0.8	SH M12x35	ZNHU 080...
125FF-S-32R-ZN08	10-12	5+5	125	32	58	50	31.5	B	1.1	-	E309
160FF-S-40R-ZN08	10-12	6+6	160	40	70	50	43	B	1.8	-	
200FF-S-40R-ZN08	10-12	8+8	200	40	90	50	53	C	2.9	-	
100FF-W-27R-ZN08	12-14	4+4	100	27	48	50	25	A	0.9	SH M12x35	
125FF-W-32R-ZN08	12-14	5+5	125	32	58	50	31.5	B	1.2	-	
160FF-W-40R-ZN08	12-14	6+6	160	40	70	50	43	B	2.0	-	
200FF-W-40R-ZN08	12-14	8+8	200	40	90	50	53	C	3.2	-	

► Width of cut is set at the smallest unless a specific width is requested

Spare parts

Designation	Right cartridge	Left cartridge	Wedge	Adjust screw	Insert screw
TSM FF-S/W-ZN08					
	TCT-SR-ZN08 TCT-WR-ZN08	TCT-SL-ZN08 TCT-WL-ZN08	WFZ 5	SA M8-6.0	TS 30085/HG
	Wedge screw	Wrench	L-Wrench	Wedge Wrench	
	WS 5	TD 9	L-W 3	F-W 2.5	



TSM FF-S/W-ZN11



Slotting cutters: Adjustable flange type

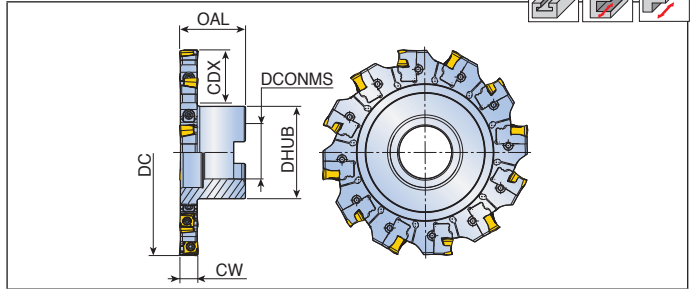
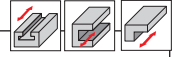

Designation	CW (mm)		Dimension (mm)					Arbor style	Kg	Mounting bolt	Insert
			DC	DCONMS	DHUB	OAL	CDX				
TSM 100FF-S-27R-ZN11	14-17	3+3	100	27	48	50	25.0	A	0.9	SH M12x35	ZNHU 110... E309
125FF-S-32R-ZN11	14-17	4+4	125	32	58	50	31.5	B	1.3	-	
160FF-S-40R-ZN11	14-17	6+6	160	40	70	50	43.0	B	2.2	-	
200FF-S-40R-ZN11	14-17	7+7	200	40	90	50	53.0	C	3.9	-	
250FF-S-60R-ZN11	14-17	9+9	250	60	130	50	55.0	C	6.2	-	
315FF-S-60R-ZN11	14-17	12+12	315	60	130	50	90.0	C	8.9	-	
100FF-W-27R-ZN11	17-20	3+3	100	27	48	50	25.0	A	1.0	SH M12x35	
125FF-W-32R-ZN11	17-20	4+4	125	32	58	50	31.5	B	1.5	-	
160FF-W-40R-ZN11	17-20	6+6	160	40	70	50	43.0	B	2.2	-	
200FF-W-40R-ZN11	17-20	7+7	200	40	90	50	53.0	C	4.1	-	
250FF-W-60R-ZN11	17-20	9+9	250	60	130	50	55.0	C	6.9	-	
315FF-W-60R-ZN11	17-20	12+12	315	60	130	50	90.0	C	10.2	-	

▶ Width of cut is set at the smallest unless a specific width is requested

Spare parts

Designation	Right cartridge	Left cartridge	Wedge	Adjust screw	Insert screw
TSM FD-S/W-ZN11					
	TCT-SR-ZN11	TCT-SL-ZN11	WFZ 6	SA M8-9.0	TS 40120/HG
	TCT-WR-ZN11	TCT-WL-ZN11			
	Wedge screw	Wrench	L-Wrench	Wedge Wrench	
WS 6	T-T15	L-W 4	T-W 3		

 E312-E315	 E316-E317	 E318	 E324-E326
---------------	---------------	----------	---------------

TSM FF-S/W-ZN14



Slotting cutters: Adjustable flange type

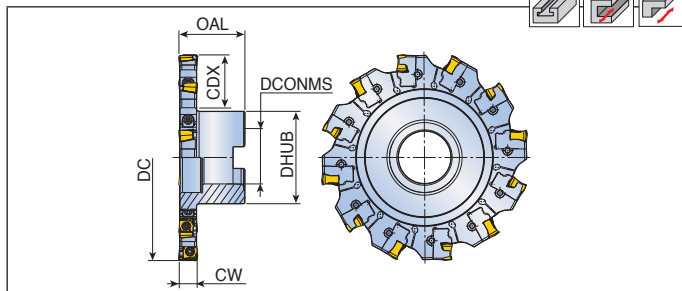
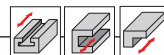

Designation	CW (mm)		Dimension (mm)					Arbor style	Kg	Insert
			DC	DCONMS	DHUB	OAL	CDX			
TSM 125FF-S-32R-ZN14	20-23	3+3	125	32	58	50	32.5	B	2.6	ZNHU 140... E309
160FF-S-40R-ZN14	20-23	5+5	160	40	70	50	43.0	B	2.8	
200FF-S-40R-ZN14	20-23	6+6	200	40	90	50	53.0	C	4.6	
250FF-S-60R-ZN14	20-23	8+8	250	60	130	50	58.0	C	7.2	
315FF-S-60R-ZN14	20-23	10+10	315	60	130	50	90.0	C	11.3	
125FF-W-32R-ZN14	23-26	3+3	125	32	58	50	32.5	B	1.8	
160FF-W-40R-ZN14	23-26	5+5	160	40	70	50	43.0	B	3.0	
200FF-W-40R-ZN14	23-26	6+6	200	40	90	50	53.0	C	5.0	
250FF-W-60R-ZN14	23-26	8+8	250	60	130	50	58.0	C	7.5	
315FF-W-60R-ZN14	23-26	10+10	315	60	130	50	90.0	C	12.2	

► Width of cut is set at the smallest unless a specific width is requested

Spare parts

Designation	Right cartridge	Left cartridge	Wedge	Adjust screw	Insert screw
TSM FD-S/W-ZN14					
	TCT-SR-ZN14	TCT-SL-ZN14	WFZ 6	SA M8-9.0	TS 40120I/HG
	Wedge screw	Wrench	L-Wrench	Wedge Wrench	
	WS 6	T-T15	L-W 4	T-W 3	



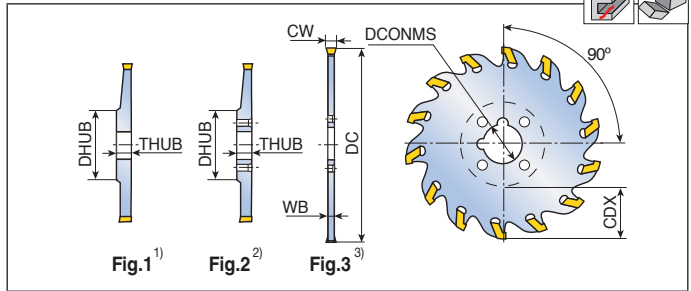

Designation	CW (mm)		Dimension (mm)						Fig.	Insert seat size	Insert
			DC	DCONMS	DHUB	WB	THUB	CDX			
TSC 75 1.6 22A	1.6	8	75	22.0	39	1.24	2.4	17	1	1	TIMC TIMJ TIPV E300-E301
100 1.6 22A	1.6	10	100	22.0	39	1.24	2.4	30	1	1	
125 1.6 27A	1.6	12	125	27.0	64	1.24	2.4	30	1	1	
75 2 22A	2.0-2.3	8	75	22.0	39	1.6	2.4	17	1	2	
100 2 22A	2.0-2.3	10	100	22.0	39	1.6	2.4	30	1	2	
125 2 27A	2.0-2.3	12	125	27.0	64	1.6	2.4	30	1	2	
100 2.4 22K	2.3-2.5	10	100	22.0	46	1.9	2.4	26	2	2	
125 2.4 32K	2.3-2.5	12	125	32.0	55	1.9	2.4	34	2	2	
160 2.4 32K	2.3-2.5	16	160	32.0	55	1.9	2.4	52	2	2	
100 3 22K	2.8-3.58	6	100	22.0	-	2.4	-	26	3	4	
125 3 32K	2.8-3.53	8	125	32.0	-	2.4	-	34	3	4	
160 3 40K	2.8-3.53	10	160	40.0	-	2.4	-	39	3	4	
100 4 22K	3.54-4.52	6	100	22.0	-	3.2	-	27	3	4	
125 4 32K	3.54-4.52	8	125	32.0	-	3.2	-	34	3	4	
160 4 40K	3.54-4.52	10	160	40.0	-	3.2	-	39	3	4	

- ▶ ¹⁾ Arbor type, ²⁾ Drive shank, ³⁾ Drive flange+Drive shank
- ▶ Extractor(ESG 0.5 or ESG 1) supplied with each cutter
- ▶ Flange set and shank should be ordered separately

Spare parts

Designation	Drive flange set	Drive shank			
TSC-2.4-22K	-	TW32-40			
TSC-2.4-32K	-	T32-55			
TSC-22K	TR22-46	TW32-40			
TSC-32K	TR32-55	T32-55			
TSC-40K	TR40-80	T40-80			



4T-TSM-W-05



Slotting Cutters: End mills

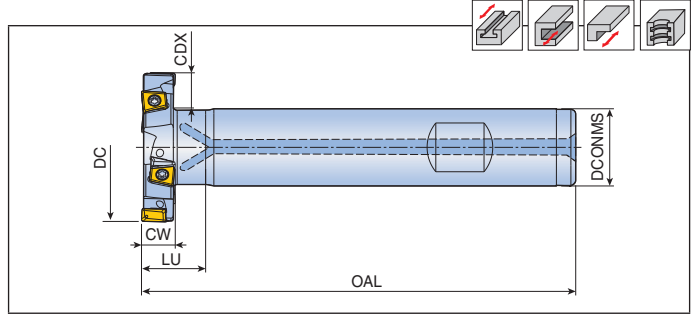

Designation	CW (mm)		Dimension (mm)					Coolant hole	Insert
			DC	DCONMS	OAL	LU	CDX		
4T-TSM-D16-07-W12-05	7	1+1	16	12	90	12	3	●	LXHU 05
D20-07-W12-05	7	2+2	20	12	90	13	4	●	E277
D25-07-W12-05	7	2+2	25	12	90	13	6.5	●	
D32-07-W16-05	7	3+3	32	16	90	13	8	●	
D40-07-W16-05	7	4+4	40	16	105	13	12	●	

Spare parts

Designation	Screw	Wrench			
	4T-TSM-W-05	TS 18049/HG-P	TD 6P		

Cutting Condition E312-E315	Torque E318
--------------------------------	----------------

4T-TSM-TR-05



Interchangeable Slotting Cutters

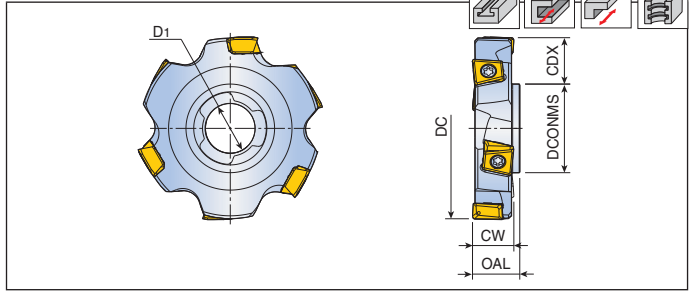

Designation	CW (mm)		Dimension (mm)					Coolant hole	Insert
			DC	DCONMS	D1	CDX	OAL		
4T-TSM-D23-07-TR13-05	7	2+2	23	13	7.5	4.5	8	x	LXHU 05
D25-07-TR13-05	7	2+2	25	13	7.5	5.5	8	x	E277
D32-07-TR15-05	7	3+3	32	15	8.4	8	8	x	
D40-07-TR17-05	7	4+4	40	17	9.8	11	10	x	

Spare parts

Designation	Screw	Wrench			
4T-TSM	TS 18049/HG-P	TD 6P			

E241, E243

E312-E315

E318

E324-E326

4T-TE90-TR-05



Interchangeable Milling Cutters

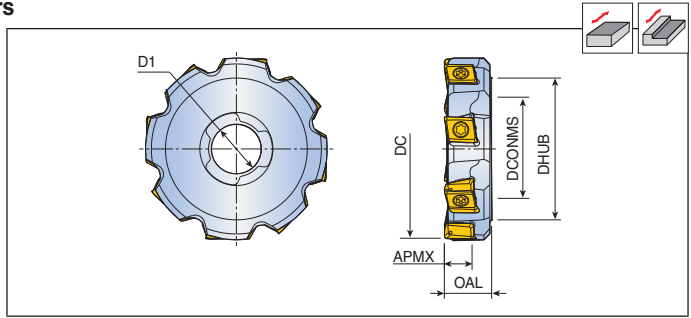

Designation		Dimension (mm)						Coolant hole	Insert
		DC	DCONMS	D1	DHUB	OAL	APMX		
4T-TE90-625-TR15-05	6	25	15	8.4	19	8	4.6	x	LPK(H)U 05 E276
832-TR15-05	8	32	15	8.4	24	8	4.6	x	
1040-TR17-05	10	40	17	9.8	31	10	4.6	x	

Spare parts

Designation	Screw	Wrench			
4T-TE90-TR-05	TS 18049/HG-P	TD 6P			

E242, E243

E312-E315

E318

TR-T-W55



Interchangeable solid carbide threading heads - 55° partial profile

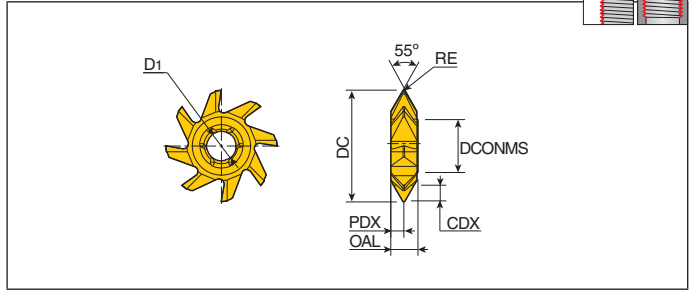

Designation	TPI	Dimension (mm)									Grade
		DC	DMIN	PDX	RE	D1	CDX	OAL	ZEFP	DCONMS	
TR13-T-24.7-W55-3T	5-3	24.7	36	2.2	0.5	7.5	3.5	7.7	6	13	●
15-T-31.7-W55-4T	6-4	31.7	46	3.7	0.5	8.4	4.7	7.7	8	15	●
17-T-39.7-W55-3T	4-3	39.7	57	4.5	0.8	9.8	6.2	9.5	10	17	●

- ▶ TPI: Threads per inch
- ▶ ZEFP: Peripheral effective cutting edge count

●: Standard items

TR-T-M60



Interchangeable solid carbide threading heads - 60° partial profile

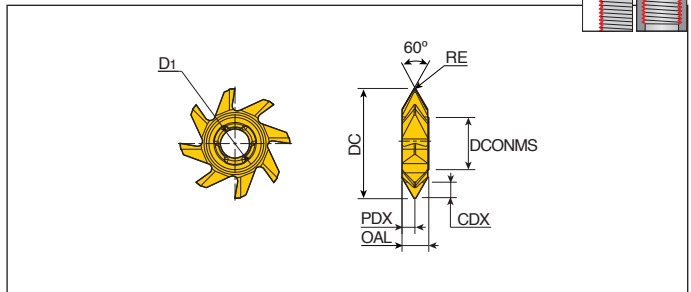

Designation	TP (mm)	TPI	Dimension (mm)									Grade
			DC	DMIN	PDX	RE	D1	CDX	OAL	ZEFP	DCONMS	
TR13-T-24.7-M60-5P	3-5	5-3	24.7	36	2.2	0.2	7.5	3.5	7.7	6	13	●
15-T-31.7-M60-6P	4-6	6-4	31.7	46	3.7	0.3	8.4	4.7	7.7	8	15	●
17-T-39.7-M60-8P	6-8	4-3	39.7	57	4.5	0.4	9.8	6.2	9.5	10	17	●

- ▶ TP: Threads pitch, TPI: Threads per inch
- ▶ ZEFP: Peripheral effective cutting edge count

●: Standard items



E312-E315 E241, E243

TR-F-C



Facing holders

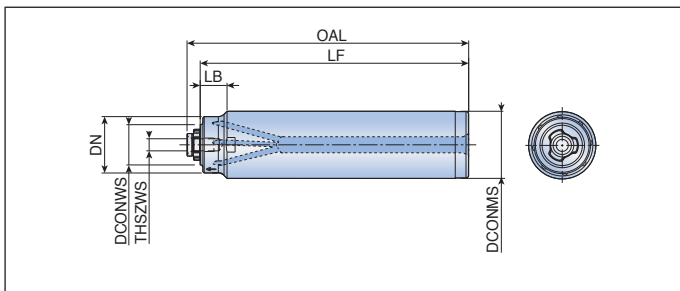

Designation	Dimension (mm)							Coolant hole	Carbide head
	DCONMS	DCONWS	LB	LF	OAL	THSZWS	DN		
TR13-20-L100-F-C	20	13	10.0	100	104.35	M4x0.5	16	●	TR-F, 4T-TE90-TR E237, E239
13-25-L100-F-C	25	13	12.5	100	104.35	M4x0.5	16	●	
15-25-L100-F-C	25	15	10.0	100	104.90	M5x0.5	21	●	
15-32-L110-F-C	32	15	13.5	110	114.90	M5x0.5	21	●	
17-32-L140-F-C	32	17	10.0	140	146.00	M6x0.5	28	●	
17-42-L140-F-C	42	17	15.0	140	146.00	M6x0.5	28	●	

Spare parts

Designation	Screw	Wrench	Wrench handle		
TR13	TS 40T098/HG-P	BLD IP15/S7	SW6-T		
TR15	TS 50T110/HG-P	BLD IP20/S7	SW6-T		
TR17	SR M6x0.5-SP1719-IP25-H	BLD IP20/S7	SW6-T		

ER Collet adapter

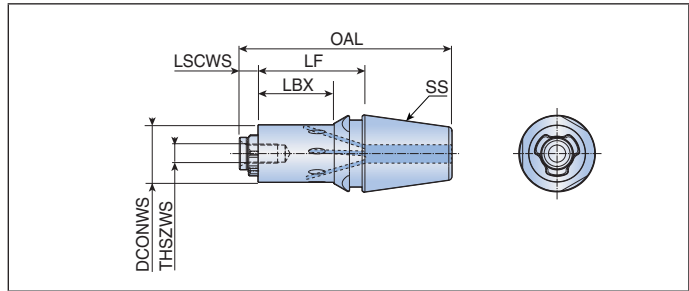

Designation	Dimension (mm)							Kg	Coolant hole	Head
	SS	DCONWS	LBX	LF	OAL	THSZWS	LSCWS			
TR 13 ER20-H20-C	ER20	13	20	28.6	55.4	M4x0.5	4.4	0.07	●	TR-S/F/T, 4T-TSM, 4T-TE90-TR E236-E240
15 ER20-H20-C	ER20	15	20	28.6	55.9	M5x0.5	4.9	0.08	●	
13 ER25-H20-C	ER25	13	20	29.1	58.4	M4x0.5	4.4	0.10	●	
15 ER25-H20-C	ER25	15	20	29.1	58.9	M5x0.5	4.9	0.11	●	
17 ER25-H20-C	ER25	17	20	29.1	60.0	M6x0.5	6.0	0.12	●	
13 ER32-H20-C	ER32	13	20	30.1	64.4	M4x0.5	4.4	0.16	●	
15 ER32-H20-C	ER32	15	20	30.1	64.9	M5x0.5	4.9	0.16	●	
17 ER32-H20-C	ER32	17	20	30.1	66.0	M6x0.5	6.0	0.17	●	
17 ER40-H20-C	ER40	17	20	32.2	72.0	M6x0.5	6.0	0.29	●	

Spare parts

Designation	Screw	Wrench	Wrench handle		
TR13	TS 40T098/HG-P	BLD IP15/S7	SW6-T		
TR15	TS 50T110/HG-P	BLD IP20/S7	SW6-T		
TR17	SR M6x0.5- SP1719-IP25-H	BLD IP25/S7	SW6-T		



Milling Inserts

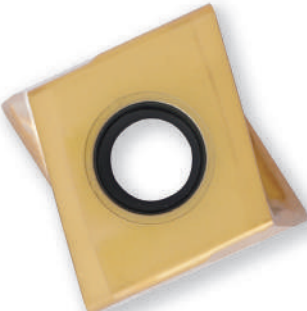

Insert Designation System



1 Shape

											Special
A	B	C	H	L	O	P	R	S	T	W	X

2 Clearance angle

B	C	D	E	F	G	N	P
5°	7°	15°	20°	25°	30°	0°	11°

3 Tolerance

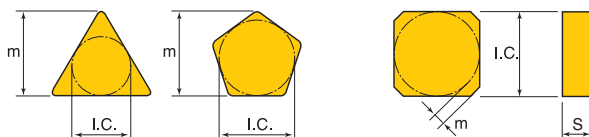

Class	Tolerance (mm)			I.C. Dimension (mm)					
	m	S	I.C.	6.35	9.52	12.70	15.87	19.05	25.40
A	±0.005	±0.025	±0.025	•	•	•	•	•	•
E	±0.025	±0.025	±0.025	•	•	•	•	•	•
F	±0.005	±0.025	±0.013	•	•	•	•	•	•
G	±0.025	±0.130	±0.025	•	•	•	•	•	•
H	±0.013	±0.025	±0.013	•	•	•	•	•	•
K	±0.013	±0.025	±0.05	•	•				
			±0.08			•			
			±0.10				•	•	
			±0.13						•
M	±0.130	±0.130	±0.05	•	•				
			±0.08			•			
			±0.10				•	•	
			±0.13						•

4 Chipformer and clamp type

								Special
A	F	G	M	N	R	T	W	X

Insert Designation System



5 Cutting edge length(mm)

I.C(mm)	C	R,S	T	H	O
5.56					
6.35	06	06	11		
7.94	08		13		
9.52	09	09	16		
12.70	12	12	22	05	05
15.87	16	15	27	09	
25.40	25	25			

6 Thickness(mm)

01	1.59
02	2.38
03	3.18
T3	3.97
04	4.76
05	5.56
06	6.35
07	7.94
09	9.52

7 Corner radius(mm)

02R	0.2
04R	0.4
05R	0.5
08R	0.8
10R	1.0
12R	1.2
15R	1.5
16R	1.6
24R	2.4
32R	3.2
40R	4.0

7 Parallel land

A=45° D=60°
E=75° F=85°
P=90° Z=Special

Entering angle

B= 5° F=25°
C= 7° G=30°
D=15° N= 0°
E=20° P=11°
Z=Special

Clearance angle of wiper

8 Edge condition

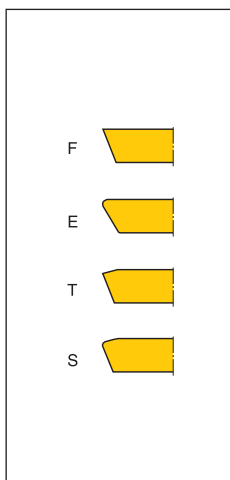

9 Hand of tool

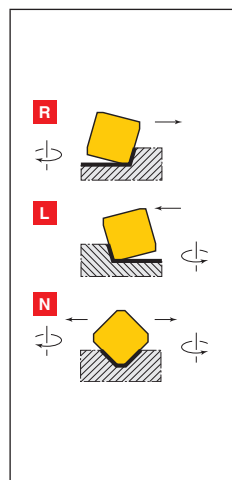

10 Manufacturer's option

AL	Aluminum
WC	Wiper crown
MR	Medium rough
M	Medium
L	Light
ML	Medium light
E□□	Economical

2FB



Inserts

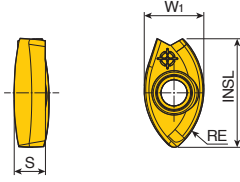

Size	Dimension (mm)					
	INSL	W1	S	APMX	RE	
160	12.4	6.8	3.7	8.0	8.0	
200	14.9	8.2	4.8	10.0	10.0	
250	18.9	10.2	5.9	12.5	12.5	
300	22.1	11.8	6.8	15.0	15.0	
320	23.9	12.8	7.5	16.0	16.0	



Insert	Designation	Recommended machining conditions		Coated							Uncoated			
		ap (mm)	Feed (mm/tooth)	TT9080	TT9030	TT8080	TT8020	TT8525B	TT7080	TT7515	TT6080	TT2510	K10	
	2FB 160-M	2.0-6.5	0.30-0.07	•		•	•	•						
	200-M	3.0-8.0	0.35-0.08	•		•	•	•			•			
	250-M	3.5-10.0	0.35-0.08	•		•	•				•			
	300-M	4.0-12.5	0.40-0.08	•		•	•				•			
	320-M	4.5-13.0	0.40-0.08	•		•	•				•			
	2FB 160-ML	2.0-6.5	0.28-0.05	•		•	•							
	200-ML	3.0-8.0	0.32-0.07	•		•	•							
	250-ML	3.5-10.0	0.32-0.07	•		•								

•: Standard items



3FB

Inserts

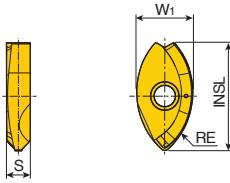

Size	Dimension (mm)					
	INSL	W1	S	APMX	RE	
320C-M	23	12.0	5.2	16	16	
500C-M	36	18.6	7.0	25	25	
320P-M	21	9.9	5.2	16	16	
500P-M	32.9	15.3	7.0	25	25	



Insert	Designation	Recommended machining conditions		Coated							Uncoated			
				TT9080	TT9030	TT8080	TT8020	TT8525B	TT7080	TT7515	TT6080	TT2510	K10	
		ap (mm)	Feed (mm/tooth)											
	3FB 320C-M	4.5-13.0	0.15-0.08	●		●								
	500C-M	7.5-20.0	0.30-0.15	●		●	●				●			
	3FB 320P-M	4.5-13.0	0.15-0.08	●		●					●			
	500P-M	7.5-20.0	0.30-0.08	●		●					●			

●: Standard items



Inserts

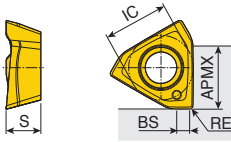

Size	Dimension (mm)				
	IC	S	APMX	BS	RE
04	3.9	2.1	3.5	0.5-0.7	0.2-0.4
06	5.3	2.8	4.7	0.6-1.2	0.2-0.8
10	6.9	4.0	7.0	0.5-1.3	0.4-1.6
15	10.7	5.0	11.0	0.5-2.0	0.4-2.4
19	13.5	6.0	15.0	0.5-2.0	0.4-3.2

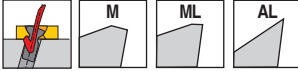

Insert	Designation	Recommended machining conditions		Cermert		Coated							Uncoated		
		ap (mm)	Feed (mm/tooth)	CT7000	TT9080	TT8080	TT8020	TT8525B	TT7080	TT7515	TT6080	TT3535	TT3520	TT2510	K10
	3PKT 040202R-M	0.5-3.0	0.08-0.04		●	●									
	040204R-M	0.5-3.0	0.08-0.04		●	●									
	060302R-M	1.0-4.0	0.10-0.04		●	●	●							●	
	060304R-M	1.0-4.0	0.10-0.04		●	●	●			●				●	
	060308R-M	1.0-4.0	0.10-0.04		●	●	●			●				●	
	100404R-M	2.0-6.0	0.12-0.05		●	●	●		●	●	●			●	
	100408R-M	2.0-6.0	0.12-0.05		●	●	●		●	●	●			●	
	100416R-M	2.0-6.0	0.12-0.05		●									●	
	150508R-M	3.0-9.0	0.17-0.07		●	●	●	●	●	●				●	
	150516R-M	3.0-9.0	0.17-0.07		●				●					●	
	150524R-M	3.0-12.0	0.17-0.07		●									●	
	190608R-M	4.5-12.0	0.22-0.09		●	●	●	●	●	●	●			●	
	190616R-M	4.5-12.0	0.22-0.09		●	●	●		●					●	
190624R-M	4.5-12.0	0.22-0.09		●									●		
190632R-M	4.5-12.0	0.22-0.09		●									●		
	3PHT 100404R-M	2.0-6.0	0.12-0.05	●	●										
	100408R-M	2.0-6.0	0.12-0.05	●	●										
	150504R-M	3.0-9.0	0.17-0.07		●										
	150508R-M	3.0-9.0	0.17-0.07	●	●						●				
	150516R-M	3.0-9.0	0.17-0.07	●	●										
	190608R-M	4.5-12.0	0.22-0.09	●	●										
	3PKT 100404R-ML	2.0-6.0	0.10-0.04		●	●	●			●	●				
	100408R-ML	2.0-6.0	0.10-0.04		●	●	●				●				
	150508R-ML	3.0-9.0	0.12-0.05		●	●	●			●	●	●			
	190608R-ML	4.5-12.0	0.14-0.06		●	●	●			●					
	3PHT 100408R-ML	2.0-6.0	0.10-0.04		●	●									
	150508R-ML	3.0-9.0	0.12-0.05		●	●									
	3PHT 060304R-AL	1.0-4.0	0.22-0.07											●	
	100404R-AL	2.0-6.0	0.40-0.10											●	
	100408R-AL	2.0-6.0	0.40-0.10											●	
	150504R-AL	3.0-9.0	0.50-0.10											●	
	150508R-AL	3.0-9.0	0.50-0.10											●	
	190604R-AL	4.5-12.0	0.50-0.15											●	
	190608R-AL	4.5-12.0	0.50-0.15											●	

●: Standard items



3PKT-SM



Splitter Inserts

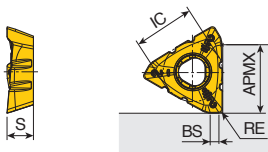

Size	Dimension (mm)					
	IC	S	APMX	BS	RE	
15	10.7	5.0	11.0	1.6	0.8	
19	13.5	6.0	15.0	2.0	0.8	



Insert	Designation	Recommended machining conditions		Cermet	Coated								Uncoated	
		ap (mm)	Feed (mm/tooth)		CT7000	TT9080	TT8080	TT8020	TT8525B	TT7080	TT7515	TT6080	TT2510	K10
	3PKT 150508-SM2	3.0-9.0	0.17-0.07		●	●		●		●				
	190608-SM2	4.5-12.0	0.22-0.09		●	●		●		●				
	3PKT 150508-SM3	3.0-9.0	0.17-0.07		●	●		●		●				
	190608-SM3	4.5-12.0	0.22-0.09		●	●		●		●				

●: Standard items



Inserts

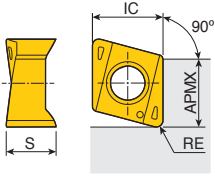

4NKT M/ML

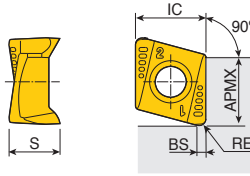

PNR-M

4NHT ML / AL

Size	Dimension (mm)				
	IC	S	APMX	BS	RE
04	4.0	3.1	3.5	-	0.2-0.8
06	6.6	4.2-5.0	5.8-6.2	0.6-1.0	0.4-2.0
09	8.6	5.7-6.3	8.0	0.8-1.2	0.4-1.6
11	10.7	8.1	9.9-10.5	1.0	0.8
14	14.0	9.2-9.4	13.5-13.8	1.25	0.8



Insert	Designation	Recommended machining conditions		Coated							Uncoated			
		ap (mm)	Feed (mm/tooth)	TT9080	TT8080	TT8020	TT8525B	TT7080	TT7515	TT6080	TT3535	TT2510	K10	
	4NKT 040202R-M	0.5-3.0	0.08-0.04	●	●									
	040204R-M	1.0-3.0	0.12-0.06	●	●				●					
	040208R-M	1.0-3.0	0.12-0.06	●	●				●					
	060304R-M	0.5-5.0	0.15-0.07	●	●				●					
	060308R-M	1.0-5.0	0.15-0.07	●	●		●		●			●		
	060312R-M	1.0-5.0	0.15-0.07	●	●				●			●		
	060316R-M	2.0-4.5	0.15-0.07	●	●				●			●		
	060320R-M	2.0-4.5	0.15-0.07	●	●				●					
	090408R-M	2.5-7.0	0.15-0.07	●	●		●		●			●		
	090416R-M	2.5-7.0	0.15-0.07	●	●				●					
	110608R-M	3.5-10.0	0.18-0.09	●	●		●		●					
	110616R-M	2.5-9.5	0.18-0.09	●										
	110624R-M	2.5-9.5	0.18-0.09	●										
140708R-M	4.0-12.0	0.18-0.09	●	●		●	●		●					
	4NKT 110608 PNR-M	3.5-10.0	0.18-0.09	●	●		●							
	140708 PNR-M	4.0-12.0	0.18-0.09	●	●		●							
	4NKT 060304R-ML	0.5-5.0	0.12-0.05	●	●				●					
	060308R-ML	1.0-5.0	0.12-0.05	●	●				●	●				
	060312R-ML	1.0-5.0	0.12-0.05	●	●				●					
	060316R-ML	2.0-4.5	0.12-0.05	●	●				●					
	060320R-ML	2.0-4.5	0.12-0.05	●	●				●					
	090408R-ML	2.5-7.0	0.10-0.05	●	●									
	4NHT 060304R-ML	0.5-5.0	0.13-0.05	●	●				●					
	060308R-ML	1.0-5.0	0.13-0.05	●	●				●					
	090404R-ML	2.5-7.0	0.12-0.05	●										
	090408R-ML	2.5-7.0	0.12-0.05	●	●									
	4NHT 060304R-AL	1.0-5.0	0.40-0.10											●
	060308R-AL	1.0-5.0	0.40-0.10											●
	090404R-AL	2.5-7.0	0.50-0.10											●
	090408R-AL	2.5-7.0	0.50-0.10											●
	110608R-AL	3.5-10.0	0.50-0.10											●
140708R-AL	4.0-12.0	0.50-0.10											●	

●: Standard items



4NHT-F



Inserts

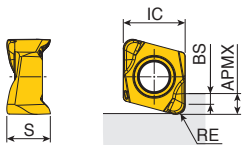

Size	Dimension (mm)					
	IC	S	APMX	BS	RE	
04-05R	4.0	3.1	2.2	1.7	0.5	
04-10R	4.0	3.0	2.0	1.0	1.0	
06-05R	6.6	4.9	2.3	1.8	0.5	
06-10R	6.6	4.7	2.1	1.1	1.0	
06-15R	6.6	4.5	3.3	1.8	1.5	
06-20R	6.6	4.3	3.0	1.1	2.0	



Insert	Designation	Recommended machining conditions		Coated							Uncoated			
		ap (mm)	Feed (mm/tooth)	TT9080	TT8080	TT8020	TT8525B	TT7080	TT7515	TT6080	TT2510		K10	
	4NHT 040205R-F	0.2-2.0	0.30-0.07								●			
	040210R-F	0.2-1.8	0.30-0.07								●			
	060305R-F	0.2-2.0	0.30-0.07	●							●			
	060310R-F	0.2-1.8	0.30-0.07	●							●			
	060315R-F	0.2-3.0	0.30-0.07	●							●			
	060320R-F	0.2-2.7	0.30-0.07	●							●			

●: Standard items



4NKT-HF



High feed inserts

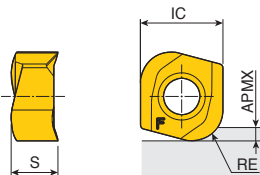

Size	Dimension (mm)				
	IC	S	APMX	RE	
04-HF	4.0	2.65	0.5	1.2	
06-HF	6.6	3.85	1.0	2.0	
09-HF	8.6	4.76	1.5	3.2	
11-HF	10.7	6.56	2.0	4.0	
14-HF	14.0	7.34	3.0	5.0	

Insert	Designation	Recommended machining conditions		Coated							Uncoated		
		ap (mm)	Feed (mm/tooth)	TT9080	TT8080	TT8525B	TT7515	TT7080	TT6080	TT2510		K10	
	4NKT 040212R-HF	0.2-0.4	0.60-0.10	●							●		
	060320R-HF	0.2-0.6	0.80-0.20	●	●	●					●		
	090432R-HF	0.3-0.8	1.00-0.20	●		●					●		
	110640R-HF	0.3-1.2	1.20-0.30	●		●							
	140750R-HF	0.3-1.5	1.50-0.30	●		●							

●: Standard items



Inserts

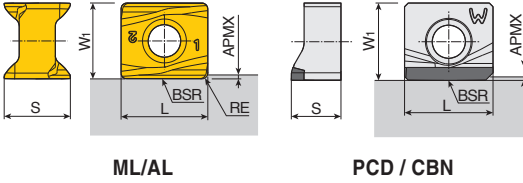

Size	Dimension (mm)					
	L	W1	S	APMX	RE	BSR
12-ML/AL	12	10.5	9.08	0.5	0.8	1000
12-PCD	12	10.5	6.74	0.5	-	1000
12-CBN	12	10.63	6.71	0.5	-	1000



Insert	Designation	Recommended machining conditions		Material					PCD	CBN
		ap (mm)	Feed (mm/tooth)	CT7000	Coated		Uncoated	TD1010		
	4WHU 1207-ML	0.25-0.5	0.20-0.10		●	●	●			
	4WHU 1207-ML	0.25-0.5	0.20-0.10	●						
	4WHU 1207-AL	0.25-0.5	0.20-0.10				●			
	4WHU 1207-PCD	0.25-0.5	0.20-0.10					●		
	4WHU 1207-CBN	0.25-0.5	0.20-0.10							●

●: Standard items



Inserts

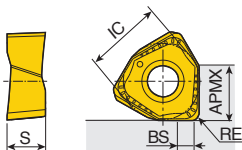

Size	Dimension (mm)						
	IC	S	APMX	BS	RE		
06	9.26	4.76	6.2	12-2.4	0.4-1.6		
09	13.05	6.70	9.2	12-2.2	0.4-1.6		



Insert	Designation	Recommended machining conditions		Coated							Uncoated			
		ap (mm)	Feed (mm/tooth)	TT9080	TT8080	TT8020	TT8525B	TT7080	TT7515	TT6080	TT3535	TT2510	K10	
	6NGU 060404R-M	1.5-5.0	0.15-0.08	●	●			●		●		●		
	060405R-M	1.5-5.0	0.15-0.08	●										
	060408R-M	1.5-5.0	0.15-0.08	●	●	●	●	●		●		●		
	060410R-M	1.5-5.0	0.15-0.08	●						●				
	060416R-M	1.5-5.0	0.15-0.08	●	●			●				●		
	090504R-M	2.5-7.5	0.20-0.10	●	●			●		●		●		
	090508R-M	2.5-7.5	0.20-0.10	●	●	●	●	●	●	●		●		
	6NGU 060404R-ML	1.5-5.0	0.10-0.05	●	●					●				
	060405R-ML	1.5-5.0	0.10-0.05	●										
	060408R-ML	1.5-5.0	0.10-0.05	●	●	●		●		●	●			
	060416R-ML	1.5-5.0	0.10-0.05	●	●					●				
	090504R-ML	2.5-7.5	0.10-0.05	●	●					●		●		
	090508R-ML	2.5-7.5	0.10-0.05	●	●	●		●		●		●		
	090516R-ML	2.5-7.5	0.10-0.05	●	●					●				
	6NGU 060404R-AL	1.5-5.0	0.40-0.10											●
	060408R-AL	1.5-5.0	0.40-0.10											●
	090504R-AL	2.5-7.5	0.40-0.10											●
	090508R-AL	2.5-7.5	0.40-0.10											●

●: Standard items



Inserts

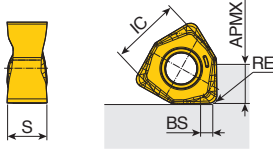

Size	Dimension (mm)					
	IC	S	APMX	BS	RE	
04	7	3.9	4.1	0.85-1.25	0.4-0.8	



Insert	Designation	Recommended machining conditions		Coated							Uncoated		
		ap (mm)	Feed (mm/tooth)	TT9080	TT8080	TT8020	TT8525B	TT7080	TT7515	TT6080	TT2510	K10	
	6NKU 040304R-M	1.0-3.0	0.10-0.05	●	●					●	●		
	040308R-M	1.0-3.0	0.10-0.05	●	●					●	●		



●: Standard items

6RBE

Inserts

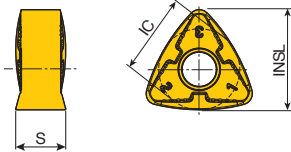

Size	Dimension (mm)					
	IC	S	INSL			
6RBE 50	13	8	16			



Insert	Designation	Recommended machining conditions		Coated							Uncoated			
		ap (mm)	Feed (mm/tooth)	TT9080	TT9030	TT8080	TT8020	TT8525B	TT7080	TT7515	TT6080	TT2510	K10	
	6RBE 50-M	1.0-5.0	0.80-0.10	●		●	●	●			●	●		



●: Standard items

Inserts

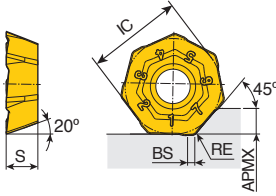

Size	Dimension (mm)					
	IC	S	APMX	BS	RE	
06	12.8	4.2	3.2	1.0	0.8	

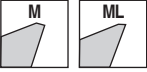

Insert	Designation	Recommended machining conditions		Coated							Uncoated	
		ap (mm)	Feed (mm/tooth)	TT9080	TT8080	TT8020	TT8525B	TT7080	TT7515	TT6080	TT2510	K10
	7EMT 0604 AETR-M	1.0-2.5	0.15-0.06	●	●			●		●		
	7EMT 0604 AETR-ML	1.0-2.5	0.15-0.06	●	●					●		



●: Standard items

ANHX 1607 ANR-M

Inserts

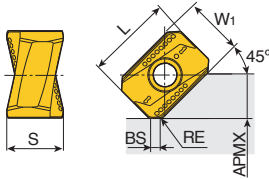

Size	Dimension (mm)					
	L	W1	S	APMX	BS	RE
16	16	11	10.4	8.4	1.6	1.0



Insert	Designation	Recommended machining conditions		Coated							Uncoated	
		ap (mm)	Feed (mm/tooth)	TT9080	TT9030	TT8080	TT8020	TT8525B	TT7080	TT7515	TT6080	K10
	ANHX 1607 ANR-M	2.5-7.0	0.30-0.15	●		●		●	●	●		



▶ Use only for 45° cutter

●: Standard items

Inserts

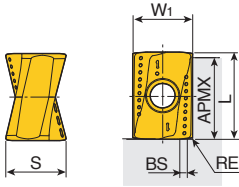

Size	Dimension (mm)					
	L	W ₁	S	APMX	BS	RE
11	12	9.2	8.5	11	0.7-1.5	0.4-1.6
16	16	11.0	10.4-10.9	15	0.6-1.7	0.4-2.4



Insert	Designation	Recommended machining conditions		Coated								Uncoated		
		ap (mm)	Feed (mm/tooth)	TT9080	TT9030	TT8080	TT8020	TT8525B	TT7080	TT7515	TT6080	TT2510	K10	
	ANMX 110608R-M	3.0-9.0	0.20-0.10	●		●								
	160708R-M	4.5-12.0	0.20-0.10	●		●								
	ANHX 110604R-M	3.0-9.0	0.15-0.08	●		●				●	●			
	110608R-M	3.0-9.0	0.15-0.08	●		●	●		●	●	●	●		
	110616R-M	3.0-9.0	0.15-0.08	●		●								
	160704R-M	4.5-12.0	0.20-0.10	●	●				●		●	●		
	160708R-M	4.5-12.0	0.20-0.10	●	●	●	●	●	●	●	●	●		
	160716R-M	4.5-12.0	0.20-0.10	●		●			●		●	●		
	160720R-M	4.5-12.0	0.20-0.10						●					
160724R-M	4.5-12.0	0.20-0.10						●		●	●			
	ANHX 110608R-ML	3.0-9.0	0.15-0.08	●		●								
	160708R-ML	4.5-12.0	0.12-0.06			●	●							
	ANHX 160708R-MR	4.5-12.0	0.25-0.13			●								
	ANHX 110604R-AL	3.0-9.0	0.40-0.10										●	
	110608R-AL	3.0-9.0	0.40-0.10										●	
	160704R-AL	4.5-12.0	0.40-0.10										●	
	160708R-AL	4.5-12.0	0.40-0.10										●	
	ANHX 110608R-SM	3.0-9.0	0.15-0.08	●		●	●			●				
	160708R-SM	4.5-12.0	0.20-0.10	●		●				●				

●: Standard items



APK(C)T 09



Inserts

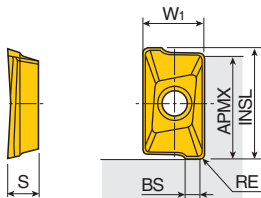

Size	Dimension (mm)					
	INSL	W1	S	APMX	BS	RE
09	9.7-10.6	6.20	3.8	8.8	0.5-1.79	0.4-3.2
09T3 PER	9.8-9.9	6.20	3.8	8.8	0-1.14	0.4



Insert	Designation	Recommended machining conditions		Material											
		ap (mm)	Feed (mm/tooth)	Cermet		Coated								Uncoated	
				CT7000	TT9080	TT9030	TT8080	TT8020	TT8525B	TT7080	TT7515	TT6080	TT2510	K10	
	APKT 09T3 PER-EM	2.5-7.5	0.10-0.05	●	●	●	●	●	●	●		●	●	●	
	09T305R-EM	2.5-7.5	0.10-0.05					●							
	09T308R-EM	2.5-7.5	0.10-0.05		●	●	●	●		●		●	●		
	09T316R-EM	2.5-7.5	0.10-0.05		●	●	●	●		●		●	●		
	09T320R-EM	2.5-7.5	0.10-0.05		●		●							●	
	09T332R-EM	2.5-7.5	0.10-0.05		●		●							●	
	09T3 PER-M	2.5-7.5	0.10-0.05					●		●			●	●	
	APCT 09T3 PER-ML	3.0-7.5	0.10-0.05		●		●	●		●		●			
	APCT 09T3 PER-AL	2.5-7.5	0.35-0.05											●	

●: Standard items



APK(C)T 12



Inserts

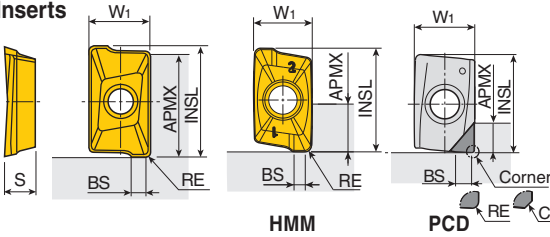

Size	Dimension (mm)					
	INSL	W1	S	APMX	BS	RE(ch)
12	13.0-14.6	8.3	4.5-4.9	11.8-12.5	0.9-2.1	0.4-4.0
1204 PER	13.4-14.6	8.3	4.5-4.9	11.8-12.5	0.9-2.1	0.8
1204-HMM	14.6	8.3	4.7	6.5	16	0.8
12...R-PCD	13.3	8.2	4.5	3.5	2	0.4
12...C-PCD	13.3	8.2	4.5	3.5	2.1	(0.25)

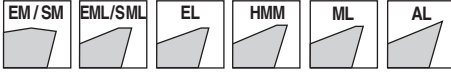

Insert	Designation	Recommended machining conditions		PCD	Coated								Uncoated	
		ap (mm)	Feed (mm/tooth)		TD1030	TT9080	TT9030	TT8080	TT8020	TT8525B	TT7080	TT7515		TT6080
	APKT 1204 PER-EM	3.5-10.0	0.14-0.07		●	●	●	●	●	●	●	●	●	
	120404R-EM	3.5-10.0	0.14-0.07			●		●		●		●	●	
	120416R-EM	3.5-10.0	0.14-0.07		●	●	●	●	●			●	●	
	120424R-EM	3.5-10.0	0.14-0.07			●	●	●					●	
	120430R-EM	3.5-10.0	0.14-0.07		●	●	●	●	●			●	●	
	120432R-EM	3.5-10.0	0.14-0.07			●		●				●	●	
	120440R-EM	3.5-10.0	0.14-0.07		●	●							●	
	APKT 1204 PER-SM	3.5-10.0	0.14-0.07		●	●			●		●			
	APKT 1204 PER-SML	3.5-10.5	0.14-0.06		●	●								
	APKT 1204 PER-EML	3.5-10.0	0.08-0.04		●	●								
	APKT 1204 PER-EL	3.5-10.0	0.05-0.03		●	●	●	●						
	APKT 1204 PER-HMM	3.5-6.5	0.12-0.05		●									
	APCT 120430R-ML	3.5-10.0	0.08-0.04		●	●								
	120432R-ML	3.5-10.0	0.08-0.04		●	●								
	120440R-ML	3.5-9.5	0.08-0.04		●	●								
	APCT 1204 PER-AL	3.5-10.0	0.50-0.10											●
	120404R-AL	3.5-10.0	0.50-0.10											●
	120416R-AL	3.5-10.0	0.50-0.10											●
	APCT 120404R-PCD35	0.2-3.0	0.30-0.05	●										
	1204C025-PCD35	0.2-3.0	0.30-0.05	●										



●: Standard items

Inserts

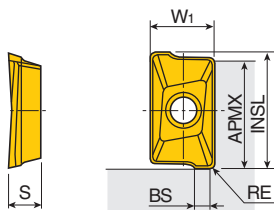

Size	Dimension (mm)					
	INSL	W1	S	APMX	BS	RE
17-ML	18.5	10.8	5.55	16.1	2.07	0.8
17-AL	18.3-18.5	10.8	5.62	16.1	1.55-2.56	0.8-3.0
17-SAL	18.5	10.8	5.62	16.1	2.56	0.8



Insert	Designation	Recommended machining conditions		Coated							Uncoated			
		ap (mm)	Feed (mm/tooth)	TT9080	TT9030	TT8080	TT8020	TT8525B	TT7080	TT7515	TT6080	TT2510	K10	
	APCT 1705 PER-ML	4.5-13.0	0.12-0.06	●		●								
	APCT 1705 PER-AL	4.5-13.0	0.50-0.10										●	
	170530R-AL	4.5-13.0	0.50-0.10										●	
	APCT 1705 PER-SAL	4.5-13.0	0.50-0.10										●	



●: Standard items

Inserts

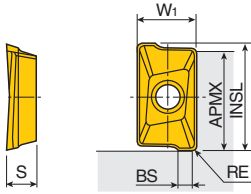

Size	Dimension (mm)					
	INSL	W1	S	APMX	BS	RE
17	16.8-18.5	10.7	5.56	15-16	0.9-3.17	0.4-6.4
17 PER	18.5-18.9	10.7	5.56-6.5	16	0.9-3.17	0.8



Insert	Designation	Recommended machining conditions		Coated								Uncoated		
		ap (mm)	Feed (mm/tooth)	TT9080	TT9030	TT8080	TT8020	TT8525B	TT7080	TT7515	TT6080	TT2510	K10	
	APKT 1705 PER-EM	4.5-13.0	0.18-0.09	●	●	●	●	●	●	●	●	●	●	
	170504R-EM	4.5-13.0	0.18-0.09	●		●	●		●	●	●		●	
	170510R-EM	4.5-13.0	0.17-0.09	●	●	●		●	●	●	●			
	170516R-EM	4.5-13.0	0.17-0.09	●	●	●	●	●	●	●	●			
	170524R-EM	4.5-13.0	0.17-0.09	●	●	●	●	●	●	●	●			
	170530R-EM	4.5-13.0	0.17-0.09	●	●	●	●	●		●	●			
	170532R-EM	4.5-13.0	0.17-0.09	●	●	●	●	●		●	●			
	170535R-EM	4.5-13.0	0.17-0.09	●	●					●	●			
	170540R-EM	4.5-13.0	0.20-0.10	●	●		●				●			
	170548R-EM	4.5-13.0	0.17-0.09	●	●	●	●	●	●	●	●			
	170550R-EM	4.5-13.0	0.20-0.10		●		●				●			
170564R-EM	4.5-13.0	0.18-0.09	●	●	●	●	●		●	●				
	APKT 1705 PER-M	4.5-13.0	0.18-0.09				●		●	●	●		●	
	170516R-M	4.5-13.0	0.20-0.10				●							
	170532R-M	4.5-13.0	0.20-0.10				●		●	●	●			
	170548R-M	4.5-13.0	0.20-0.10				●							
	APKT 1705 PER-SM	4.5-13.0	0.17-0.09	●		●		●		●				
	APKT 1705 PER-SML	4.5-14.5	0.17-0.06	●		●								
	APKT 1705 PER-EML	4.5-13.0	0.14-0.07	●		●		●						
	APKT 1705 PER-EL	4.5-13.0	0.10-0.05	●	●	●	●	●						

●: Standard items



Inserts

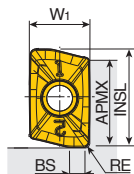

Size	Dimension (mm)					
	INSL	W1	S	APMX	BS	RE
19	21	13	7.35	17.9	2.0	1.2



Insert	Designation	Recommended machining conditions		Coated								Uncoated		
		ap (mm)	Feed (mm/tooth)	TT9080	TT9030	TT8080	TT8020	TT8525B	TT7080	TT7515	TT6080	TT2510	K10	
	APKT 190712R-M	5.0-15.0	0.20-0.07	●		●		●	●		●	●		
	APKT 190712R-MR	5.0-15.0	0.25-0.10	●		●		●	●		●			
	APKT 190712R-ML	5.0-15.0	0.20-0.08	●						●				



●: Standard items

APKT/AXMT-HF

High feed inserts

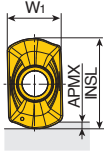

Size	Dimension (mm)							
	INSL	W ₁	S	APMX				
06	6.7	4.04	2.6	0.5				
09	10.7	5.94	3.9	1.0				
12	14.2	8.0	5.0	1.2				

Insert	Designation	Recommended machining conditions		Coated								Uncoated		
		a _p (mm)	Feed (mm/tooth)	TT9080	TT9030	TT8080	TT8020	TT8525B	TT7080	TT7515	TT6080	TT2510	K10	
	AXMT 0602R-HF	0.2-0.5	0.70-0.30	●		●								
	APKT 09T3R-HF	0.1-1.0	0.80-0.30	●		●						●		
	1204R-HF	0.2-1.0	0.80-0.10	●		●						●		

●: Standard items



Inserts

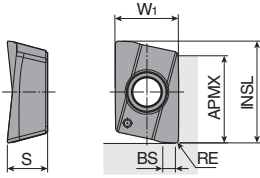

Size	Dimension (mm)					
	INSL	W1	S	APMX	BS	RE
06	6.5	4.2	2.6	5.5	0.6-1.0	0-0.4



Insert	Designation	Recommended machining conditions		Coated							Uncoated		
		ap (mm)	Feed (mm/tooth)	TT9080	TT9030	TT8080	TT8020	TT8525B	TT7080	TT7515	TT6080	TT5525	K10
	AXCT 060200R-L	0.1-5.0	0.08-0.03										
	060202R-L	0.2-5.0	0.10-0.03								•		
	060204R-L	0.3-5.0	0.10-0.03								•		
												•	

• Standard items



Inserts

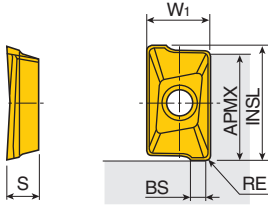

Size	Dimension (mm)					
	INSL	W1	S	APMX	BS	RE
06-EM	6.7	4.15	2.6	5.5	0-0.76	0.2-2.0
06-AL	6.7	4.20	2.6	5.5	0.23-0.83	0.2-0.8



Insert	Designation	Recommended machining conditions		Coated							Uncoated			
		ap (mm)	Feed (mm/tooth)	TT9080	TT9030	TT8080	TT8020	TT8525B	TT7080	TT7515	TT6080	TT5525	TT2510	K10
	AXMT 0602 PER-EM	1.5-5.0	0.08-0.04	●	●	●	●						●	
	060204R-EM	1.5-5.0	0.13-0.07	●	●	●	●			●			●	
	060208R-EM	1.5-5.0	0.13-0.07	●	●	●	●			●			●	
	060216R-EM	1.5-5.0	0.13-0.07	●	●	●	●						●	
	060220R-EM	1.5-5.0	0.13-0.07	●		●								
	AXCT 060202R-AL	1.5-5.0	0.20-0.10											●
	060204R-AL	1.5-5.0	0.20-0.10											●
	060208R-AL	1.5-5.0	0.20-0.10											●



● Standard items

AVK(C)T 10

Inserts

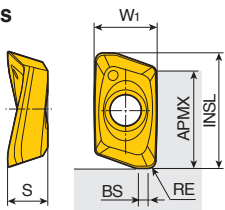

M / EL / AL

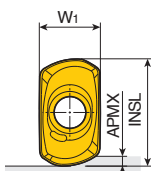

HF (High Feed)

Size	Dimension (mm)					
	INSL	W1	S	APMX	BS	RE
10-M/EL	11.5-12.4	6.8	4.1-4.3	9.6-10	0-1.0	0.8-3.2
10-HF	11.6	6.6	4.4	1.0	-	-
10-AL	11.3-12.5	6.7-6.8	4.0-4.5	9.5-10.1	0-1.2	0.4-3.2



Insert	Designation	Recommended machining conditions		Coated							Uncoated			
		ap (mm)	Feed (mm/tooth)	TT 9080	TT 9030	TT 8080	TT 8020	TT 8525B	TT 7080	TT 7515	TT 6080	TT 3535	K10	
	AVKT 1004 PER-M	2.5-8.0	0.12-0.06	●		●			●	●				
	100416R-M	2.5-8.0	0.12-0.06	●										
	100432R-M	2.5-8.0	0.12-0.06	●										
	AVKT 1004 PER-EL	2.5-8.0	0.06-0.03			●					●			
	100416R-EL	2.5-8.0	0.06-0.03			●					●			
	100432R-EL	2.5-8.0	0.06-0.03			●					●			
	AVKT 1004R-HF	0.1-1.0	0.80-0.30	●	●						●			
	AVCT 100404R-AL	2.5-8.0	0.50-0.10										●	
	1004 PER-AL	2.5-8.0	0.50-0.10										●	
	100416R-AL	2.5-8.0	0.50-0.10										●	
	100420R-AL	2.5-8.0	0.50-0.10										●	
	100430R-AL	2.5-8.0	0.50-0.10										●	
	100432R-AL	2.5-8.0	0.50-0.10										●	

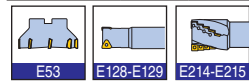

●: Standard items

High feed inserts

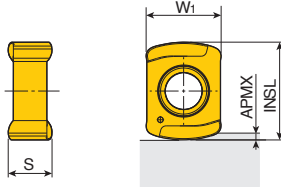

Size	Dimension (mm)				
	INSL	W1	S	APMX	
04	6.0	4.2	2.5	0.5	
06	9.0	6.39	3.73	1.0	
09	11.9	9.20	4.79	1.5	
11	14.6	11.2	6.54	2.0	



Insert	Designation	Recommended machining conditions		Coated								Uncoated			
		ap (mm)	Feed (mm/tooth)	TT9080	TT8080	TT8020	TT8525B	TT7080	TT7515	TT6080	TT2510			K10	
	BLMP 0402R-M	0.1-0.5	1.50-0.20	•	•						•				
	0603R-M	0.1-1.0	2.50-0.30	•	•	•	•				•	•			
	0904R-M	0.1-1.5	3.50-0.30	•	•	•	•		•	•	•				
	1105R-M	0.3-2.0	4.00-0.30	•	•	•	•				•				
	BLMP 0603R-MM	0.1-1.0	2.00-0.20	•	•	•					•				
	0904R-MM	0.1-1.5	3.00-0.20	•	•	•					•				
	BLMP 0402R-ML	0.1-0.5	0.80-0.10	•	•										
	0603R-ML	0.1-1.0	0.80-0.10	•	•	•									
	0904R-ML	0.1-1.5	0.80-0.30	•	•	•									
	1105R-ML	0.3-2.0	0.40-0.30	•	•										

•: Standard items





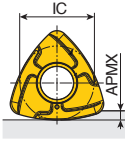
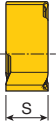

BLMP 13

High feed inserts

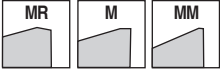

Size	Dimension (mm)			
	IC	S	APMX	
13	12.3	7	2.0	



Insert	Designation	Recommended machining conditions		Coated							Uncoated		
		ap (mm)	Feed (mm/tooth)	TT9080	TT8080	TT8020	TT8525B	TT7080	TT7515	TT6080	TT2510		
	BLMP 1306R-M	0.5-2.0	4.50-0.40	●	●	●	●	●	●	●	●	K10	
	BLMP 1306R-MM	0.5-2.0	4.50-0.40	●	●	●	●				●		
	BLMP 1306R-MR	0.5-2.0	4.50-0.40	●	●	●	●	●	●	●			

●: Standard items



BLMV 06



High feed inserts

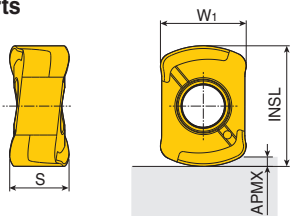

Size	Dimension (mm)				
	INSL	W1	S	APMX	
06	9	6.4	4.43	1.0	



Insert	Designation	Recommended machining conditions		Coated								Uncoated		
		ap (mm)	Feed (mm/tooth)	TT9080	TT9030	TT8080	TT8020	TT8525B	TT7080	TT3535	TT3520	TT2510	K10	
	BLMV 0603R-M	0.1-1.0	2.50-0.35	•		•		•				•		
	BLMV 0603R-ML	0.1-1.0	0.80-0.12	•		•				•	•			
	BLMV 0603R-MM	0.1-1.0	2.00-0.25	•		•				•	•	•		

•: Standard items



BNGX 06/09

High feed inserts

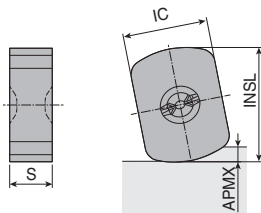

Size	Dimension (mm)					
	INSL	IC	S	APMX		
06	8	6	3	1.0		
09	12	9	5	1.5		

Insert	Designation	Recommended machining conditions		Ceramic							Coated		Uncoated	
		ap (mm)	Feed (mm/tooth)	TC3030	TC3020	TT9080	TT9030	TT8080	TT8020	TT8525B	TT7080	TT7515	TT6080	K10
	BNGX 0603 CH-E04	0.4-0.8	0.30-0.10	●										
	0904 CH-E04	0.5-1.0	0.35-0.15	●										



▶ E04: Honing 0.04-0.05mm

●: Standard items

BNGX 12

High feed inserts

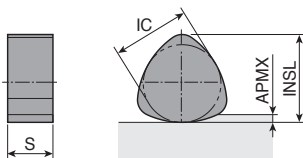

Size	Dimension (mm)					
	INSL	IC	S	APMX		
12	13.6	12	7	2.5		

Insert	Designation	Recommended machining conditions		Ceramic							Coated		Uncoated	
		ap (mm)	Feed (mm/tooth)	TC3030	TC3020	TT9080	TT9030	TT8080	TT8020	TT8525B	TT7080	TT7515	TT6080	K10
	BNGX 1207-E04	1.0-2.0	0.35-0.15	●										



▶ E04: Honing 0.04-0.05mm

●: Standard items

Inserts

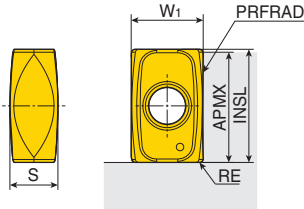

Size	Dimension (mm)					
	W1	S	APMX	INSL	RE	PRFRAD
06	4.2	2.8	6.4	6.6	0.2	20
12	7	4.56	12.2	12.4	0.2	30

Insert	Designation	Recommended machining conditions		Coated						Uncoated			
		ap (mm)	Feed (mm/tooth)	TT9080	TT9030	TT8080	TT8020	TT8525B	TT7080	TT7515	TT5515	TT2510	K10
	BRHU 06R2002-L	-	0.15-0.08										
	12R3002-L	-	0.20-0.08							●			
										●			



●: Standard items

CNHX



Inserts

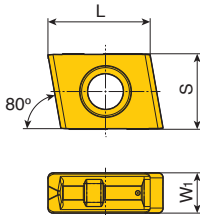

Size	Dimension (mm)			
	L	S	W1	
13	12.7	11	5.4	
16	16.0	12	6.4	

Insert	Designation	Recommended machining conditions		Coated						Uncoated		
		ap (mm)	Feed (mm/tooth)	TT9080	TT9030	TT8080	TT8020	TT8525B	TT7080	TT7515	TT6080	K10
	CNHX 131108T	1.2-5.5	0.55-0.17					●				
	160608T	1.2-5.5	0.60-0.20					●				



●: Standard items

Inserts

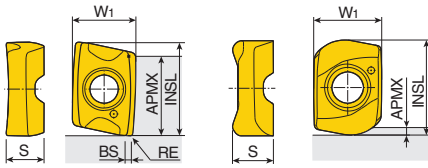

M / L / AL

HF (High Feed)

Size	Dimension (mm)					
	INSL	W1	S	APMX	BS	RE
05-M	6.2-6.3	4.2	2.6	5.0	0.3	0.2-0.4
05-L/AL	6.3	4.1	2.6	5.0	0.3	0.2
05-HF	5.6	4.1	2.5	0.5	-	-



Insert	Designation	Recommended machining conditions		Coated								Uncoated		
		ap (mm)	Feed (mm/tooth)	TT9080	TT9030	TT8080	TT8020	TT8525	TT7080	TT7515	TT6080	TT5525	TT2510	UF10
	CVKT 0502PNR-M	0.5-4.0	0.08-0.04	●		●								
	050204R-M	0.5-4.0	0.08-0.04	●	●							●		
	CVHT 0502PNR-L	0.5-4.0	0.07-0.03	●	●						●			
	CVHT 0502PNR-AL	0.5-4.0	0.20-0.07										●	
	CVKT 0502R-HF	0.2-0.4	0.70-0.30	●	●							●		

●: Standard items



High feed inserts

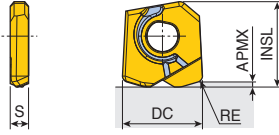

Size	Dimension (mm)					
	INSL	DC	S	APMX	RE	
06	5.9	6	1.6	0.3	0.5	
08	8.4	8	1.8	0.5	0.6	

Insert	Designation	Recommended machining conditions		Coated								Uncoated	
		ap (mm)	Feed (mm/tooth)	TT9080	TT9030	TT8080	TT8020	TT8525B	TT7080	TT7515	TT6080	TT5515	K10
	HFN 060-M	0.1-0.2	0.50-0.30										
	080-M	0.2-0.3	0.50-0.30									•	
												•	

•: Standard items



E181-E182

HXK(H)U

Inserts

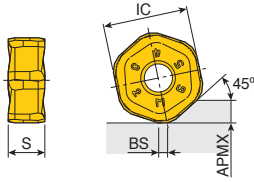

Size	Dimension (mm)			
	IC	S	APMX	BS
06-MM	14	6.8	3.0	1.3
06-M/ML	14	6.8	3.0	1.0
10-MM	19.05	8.3	5.0	1.6
10-M/HR/ML	19.05	8.3	5.0	1.0

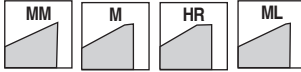

Insert	Designation	Recommended machining conditions		Coated							Uncoated	
		ap (mm)	Feed (mm/tooth)	TT9080	TT9030	TT8080	TT8020	TT8525B	TT7080	TT7515	TT6080	K10
	HXHU 0605 ANR-MM	1.0-3.0	0.25-0.10	●						●		
	1007 ANR-MM	2.0-5.0	0.30-0.10	●						●		
	HXKU 0605 ANR-M	1.0-3.0	0.35-0.10	●				●		●		
	1007 ANR-M	2.0-5.0	0.45-0.10	●				●		●		
	HXKU 1007 ANR-HR	2.0-5.0	0.60-0.10	●				●	●			
	HXKU 0605 ANR-ML	1.0-3.0	0.25-0.10	●	●							
	1007 ANR-ML	2.0-5.0	0.30-0.10	●	●							

●: Standard items



Inserts

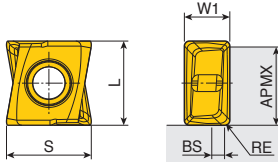

Size	Dimension (mm)					
	L	W1	S	APMX	BS	RE
05	5	2.7	5.0-5.2	4.6	-	0.4
09	9	4.5	8.3-8.6	8.3	0.6	0.4-1.6
14	13.5	6.7	13.5	12.5	0.9	0.8

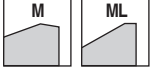

Insert	Designation	Recommended machining conditions		Coated								Uncoated		
		ap (mm)	Feed (mm/tooth)	TT9080	TT9030	TT8080	TT8020	TT8525B	TT7080	TT7515	TT6080	TT5525	K10	
	LPKU 050204 PNR-M	1.0-3.5	0.08-0.04	●		●					●			
	090404 PNR-M	2.5-6.0	0.15-0.06	●		●	●				●			
	090408 PNR-M	2.5-6.0	0.15-0.06	●		●					●			
	090416 PNR-M	3.5-10.0	0.20-0.10	●		●					●			
	140708 PNR-M	3.5-10.0	0.20-0.10	●		●	●				●			
	LPHU 050200 PNR-ML	0.1-3.5	0.08-0.03									●		
	050202 PNR-ML	0.2-3.5	0.10-0.03									●		
	050204 PNR-ML	0.3-3.5	0.10-0.03	●		●					●	●		
	LPHU 090404 PNR-M	2.5-6.0	0.15-0.06			●						●		

●: Standard items



Inserts

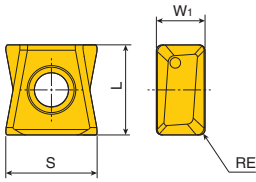

Size	Dimension (mm)					
	L	W1	S	APMX	BS	RE
05	5	2.7	5.0	-	-	0.4



Insert	Designation	Recommended machining conditions		Coated								Uncoated		
		ap (mm)	Feed (mm/tooth)	TT9080	TT9030	TT8080	TT8020	TT8525B	TT7080	TT7515	TT6080	TT5525	K10	
	LXHU 05-04-ML	-	0.08-0.04	●		●								

●: Standard items



Inserts

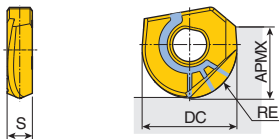

Size	Dimension (mm)					
	DC	S	APMX	RE		
060	6	2.0	4.5-4.8	3.0		
080	8	2.2	6.6-6.9	4.0		
100	10	2.7	8.0-8.2	5.0		
120	12	3.2	9.6-9.7	6.0		
160	16	4.2	12.3-12.7	8.0		
200	20	5.2	14.4-14.7	10.0		
250	25	6.2	16.8-17.4	12.5		
300	30	7.2	18.6-19.2	15.0		
320	32	7.2	18.4-19.2	16.0		

Insert	Designation	Recommended machining conditions		Coated							Uncoated			
		ap (mm)	Feed (mm/tooth)	TT9080	TT8080	TT8525B	TT7080	TT7515	TT6080	TT5525	TT5515	TT2510	K10	
 Straight cutting edge	NFB 060-FM	0.05-0.2	0.15-0.05							●				
	080-FM	0.05-0.3	0.20-0.05							● ●				
	100-FM	0.05-0.3	0.20-0.05							● ●				
	120-FM	0.05-0.5	0.30-0.08							● ● ●				
	160-FM	0.05-0.5	0.30-0.08							● ● ●				
	200-FM	0.10-1.0	0.30-0.08							● ●				
	250-FM	0.15-1.0	0.40-0.08							● ●				
	300-FM	0.15-1.0	0.40-0.08							● ●				
	320-FM	0.15-1.0	0.40-0.08						● ●					
 Helical cutting edge	NFB 060-SM	0.80-2.5	0.20-0.05							● ● ●				
	080-SM	1.20-3.2	0.25-0.05							● ● ● ●				
	100-SM	1.50-4.0	0.25-0.05							● ● ● ●				
	120-SM	1.80-4.8	0.35-0.08							● ● ● ●				
	160-SM	2.40-6.4	0.35-0.08							● ● ● ●				
	200-SM	3.00-8.0	0.35-0.08							● ● ● ●				
	250-SM	3.75-10.0	0.45-0.08							● ● ● ●				
	300-SM	4.50-12.0	0.45-0.08							● ● ● ●				
		320-SM	4.80-12.8	0.45-0.08							● ● ● ●			

●: Standard items



Inserts

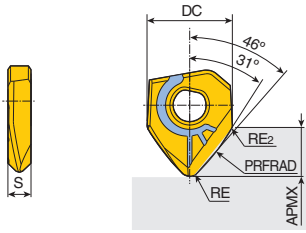

Size	Dimension (mm)					
	DC	S	APMX	RE	PRFRAD	RE ₂
080	8	2.2	4.3	1.0	20	0.6
100	10	2.7	5.4	1.2	25	0.8
120	12	3.2	6.4	1.5	30	1.0
160	16	4.2	8.5	2.0	40	1.3
200	20	5.2	10.7	2.5	50	1.6
250	25	6.2	13.5	3.0	62.5	2.0
300	30	7.2	16.3	3.5	75	2.4

Insert	Designation	Recommended machining conditions		Coated							Uncoated		
		ap (mm)	Feed (mm/tooth)	TT9080	TT9030	TT8080	TT8020	TT8525B	TT7080	TT7515	TT6080	TT5515	K10
	NFCB 080-R20	-	0.12-0.05								●		
	100-R25	-	0.12-0.05								●		
	120-R30	-	0.15-0.08								●		
	160-R40	-	0.15-0.08								●		
	200-R50	-	0.15-0.08								●		
	250-R62.5	-	0.15-0.08								●		
300-R75	-	0.20-0.08								●			

●: Standard items

NFLB

Inserts

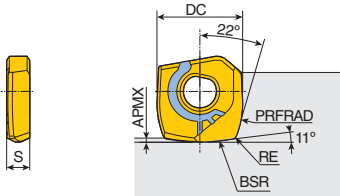

Size	Dimension (mm)						
	DC	S	APMX	RE	BSR	PRFRAD	
120	12	3.2	0.4	0.7	24	12	
160	16	4.2	0.6	0.8	32	16	
200	20	5.2	0.7	1	40	20	
250	25	6.2	0.9	1.3	50	25	
300	30	7.2	1.1	1.5	60	30	

Insert	Designation	Recommended machining conditions		Coated							Uncoated		
		ap (mm)	Feed (mm/tooth)	TT9080	TT9030	TT8080	TT8020	TT8525B	TT7080	TT7515	TT6080	TT5515	K10
	NFLB 120-L24-B12	-	0.15-0.08								●		
	160-L32-B16	-	0.15-0.08								●		
	200-L40-B20	-	0.15-0.08								●		
	250-L50-B25	-	0.15-0.08								●		
	300-L60-B30	-	0.20-0.08								●		

●: Standard items



E168-E170

Inserts

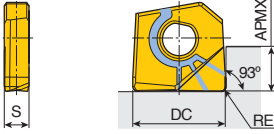

Size	Dimension (mm)				
	DC	S	APMX	RE	
060	6	2.0	2.5	0.3-1.0	
080	8	2.2	3.4	0.3-1.0	
100	10	2.7	4.0	0.3-2.0	
110	11	2.7	4.4	0.3-2.0	
120	12	3.2	5.0	0.3-2.0	
130	13	3.2	5.4	0.3-2.0	
160	16	4.2	6.9	0.3-3.0	
170	17	4.2	7.4	1.0-2.0	

Insert	Designation	Recommended machining conditions		Coated							Uncoated			
		ap (mm)	Feed (mm/tooth)	TT9080	TT8080	TT8525B	TT7080	TT7515	TT6080	TT5525	TT5515	TT2510	K10	
	NFR 060A-R03	0.05-0.15	0.10-0.05											
	060A-R05	0.10-0.15	0.10-0.05											
	060A-R10	0.10-0.15	0.10-0.05											
	080A-R03	0.05-0.2	0.12-0.05											
	080A-R05	0.05-0.2	0.12-0.05											
	080A-R06	0.05-0.2	0.12-0.05											
	080A-R10	0.05-0.2	0.12-0.05											
	100A-R03	0.05-0.3	0.12-0.05											
	100A-R05	0.05-0.3	0.12-0.05											
	100A-R08	0.05-0.3	0.12-0.05											
	100A-R10	0.05-0.3	0.12-0.05											
	100A-R15	0.05-0.3	0.12-0.05											
	100A-R20	0.05-0.3	0.12-0.05											
	110A-R10	0.05-0.3	0.12-0.05											
	110A-R20	0.05-0.3	0.12-0.05											
	120A-R03	0.07-0.3	0.15-0.08											
	120A-R05	0.07-0.3	0.15-0.08											
	120A-R10	0.07-0.3	0.15-0.08											
	120A-R15	0.07-0.3	0.15-0.08											
	120A-R20	0.07-0.3	0.15-0.08											
	130A-R10	0.07-0.3	0.15-0.08											
	130A-R20	0.07-0.3	0.15-0.08											
	160A-R03	0.08-0.5	0.15-0.08											
	160A-R05	0.08-0.5	0.15-0.08											
	160A-R10	0.08-0.5	0.15-0.08											
	160A-R13	0.08-0.5	0.15-0.08											
	160A-R15	0.08-0.5	0.15-0.08											
	160A-R20	0.08-0.5	0.15-0.08											
160A-R30	0.08-0.5	0.15-0.08												
170A-R10	0.08-0.5	0.15-0.08												
170A-R20	0.08-0.5	0.15-0.08												

●: Standard items



Inserts

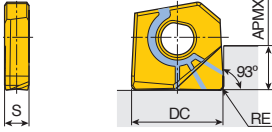

Size	Dimension (mm)				
	DC	S	APMX	RE	
200	20	5.2	8.79.2	0.3-3.0	
210	21	5.2	9.2	1.0-2.0	
250	25	6.2	10.6	0.3-3.0	
260	26	6.2	11	1.0-2.0	
300	30	7.1	12.7	1.0-2.0	
320	32	7.1	13.6	1.0-2.0	

Insert	Designation	Recommended machining conditions		Coated							Uncoated			
		ap (mm)	Feed (mm/tooth)	TT9080	TT8080	TT8525B	TT7080	TT7515	TT6080	TT5525	TT5515	TT2510	K10	
	NFR 200A-R03	0.1-0.7	0.15-0.08							●	●	●		
	200A-R05	0.1-0.7	0.15-0.08							●	●	●		
	200A-R10	0.1-0.7	0.15-0.08							●	●	●		
	200A-R15	0.1-0.7	0.15-0.08							●	●	●		
	200A-R16	0.1-0.7	0.15-0.08							●	●	●		
	200A-R20	0.1-0.7	0.15-0.08							●	●	●		
	200A-R30	0.1-0.7	0.15-0.08							●	●	●		
	210A-R10	0.1-0.7	0.15-0.08							●	●	●		
	210A-R20	0.1-0.7	0.15-0.08							●	●	●		
	250A-R03	0.1-1.0	0.15-0.08							●	●	●		
	250A-R05	0.1-1.0	0.15-0.08							●	●	●		
	250A-R10	0.1-1.0	0.15-0.08							●	●	●		
	250A-R15	0.1-1.0	0.15-0.08							●	●	●		
	250A-R20	0.1-1.0	0.15-0.08							●	●	●		
	250A-R30	0.1-1.0	0.15-0.08							●	●	●		
	260A-R10	0.1-1.0	0.15-0.08							●	●	●		
	260A-R20	0.1-1.0	0.15-0.08							●	●	●		
	300A-R05	0.1-1.0	0.20-0.08							●	●	●		
	300A-R10	0.1-1.0	0.20-0.08								●	●		
	300A-R20	0.1-1.0	0.20-0.08								●	●		
320A-R10	0.1-1.0	0.20-0.08							●	●	●			
320A-R20	0.1-1.0	0.20-0.08								●	●			

●: Standard items



Inserts

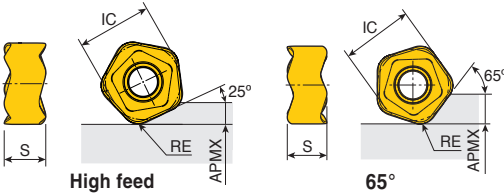

Size	Dimension (mm)				
	IC	S	APMX	RE	
05(HF)	7.1	3.8	1.5	1.5	
05(65°)	7.1	3.8	3.3	1.5	
10(HF)	14.2	7.7	3.0	3.0	
10(65°)	14.2	7.7	6.5	3.0	

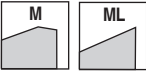

Insert	Designation	Recommended machining conditions		Coated								Uncoated			
		ap (mm)	Feed (mm/tooth)	TT9080	TT9030	TT8080	TT8020	TT8525B	TT7080	TT7515	TT6080	TT3535	TT2510	K10	
	PTKU 0503R-M (High feed)	0.2-1.5	1.20-0.20	●		●							●		
	1006R-M (High feed)	0.3-2.0	2.00-0.30	●		●	●						●		
	0503R-M (65°)	1.0-3.0	0.20-0.07	●		●							●		
	1006R-M (65°)	1.5-5.0	0.25-0.10	●		●	●						●		
	PTKU 0503R-ML (High feed)	0.2-1.5	1.00-0.20	●		●							●		
	1006R-ML (High feed)	0.3-2.0	1.20-0.30	●		●							●		
	0503R-ML (65°)	1.0-3.0	0.20-0.07	●		●							●		
	1006R-ML (65°)	1.5-5.0	0.25-0.10	●		●							●		

●: Standard items



RNGN 12-FL



Inserts

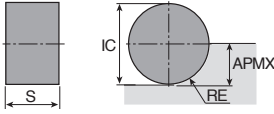

Size	Dimension (mm)				
	RE	IC	S	APMX	
12	6.35	12.7	7.94	6.3	

Insert	Designation	Recommended machining conditions		Ceramic		Coated						Uncoated		
		ap (mm)	Feed (mm/tooth)	TC3020	TC3030	TT8080	TT8020	TT8525B	TT7080	TT7515	TT6080	TT2510	K10	
	RNGN 1207 FL-E	0.5-3.0	0.25-0.10	●	●									
	1207 FL-E04	0.5-3.0	0.25-0.10	●	●									
	1207 FL-T6	0.5-3.0	0.25-0.10	●	●									



●: Standard items

RPGN 09/12-FL



Inserts

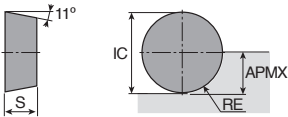

Size	Dimension (mm)				
	RE	IC	S	APMX	
09	4.76	9.52	3.18	4.7	
12	6.35	12.7	4.76	6.3	

Insert	Designation	Recommended machining conditions		Ceramic		Coated						Uncoated		
		ap (mm)	Feed (mm/tooth)	TC3020	TC3030	TT8080	TT8020	TT8525B	TT7080	TT7515	TT6080	TT2510	K10	
	RPGN 0903 FL-E04	0.5-1.5	0.15-0.07	●	●									
	1204 FL-E	0.5-2.0	0.20-0.07	●	●									
	1204 FL-E04	0.5-2.0	0.20-0.07	●	●									
	1204 FL-T6	0.5-2.0	0.20-0.07	●	●									



●: Standard items

Inserts

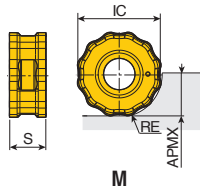
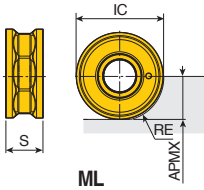

Size	Dimension (mm)				
	RE	IC	S	APMX	
10	5	10	4.5	5.0	
12	6	12	5.0	6.0	
16	8	16	6.3	8.0	

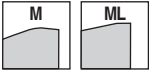

Insert	Designation	Recommended machining conditions		Coated							Uncoated			
		ap (mm)	Feed (mm/tooth)	TT9080	TT9030	TT8080	TT8020	TT8525B	TT7080	TT7515	TT6080	TT2510	K10	
	RNMU1004-ML	1.5-4.0	0.30-0.05	•		•	•	•						
	1205-ML	1.5-5.0	0.35-0.05	•		•	•	•						
	1606-ML	2.0-6.5	0.40-0.05	•		•	•	•						
	RNMU1004S-M	1.5-4.0	0.35-0.05	•		•	•	•						
	1205S-M	1.5-5.0	0.40-0.05	•		•	•	•						
	1606S-M	2.0-6.5	0.45-0.05	•		•	•	•						

•: Standard items



Inserts

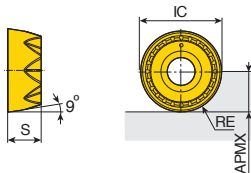

Size	Dimension (mm)				
	RE	IC	S	APMX	
08	4	8	3.2	4.0	
10	5	10	4.0	5.0	
12	6	12	4.8	6.0	
16	8	16	6.1	8.0	
20	10	20	7.0	10.0	



Insert	Designation	Recommended machining conditions		Coated								Uncoated		
		ap (mm)	Feed (mm/tooth)	TT9080	TT9030	TT8080	TT8020	TT8525B	TT7080	TT7515	TT6080	TT2510	K10	
	RYMX 0803-M	1.0-3.5	0.25-0.05	●		●		●	●		●	●		
	1004-M	1.5-4.0	0.30-0.10	●		●	●	●	●		●	●		
	1205-M	1.5-5.0	0.50-0.10	●		●	●	●	●		●	●		
	1205-6M	1.5-5.0	0.50-0.10	●								●		
	1606-M	2.0-6.5	0.50-0.10	●		●	●	●	●		●	●		
	1606-7M	2.0-6.5	0.50-0.10	●								●		
	2007-M	3.0-8.0	0.50-0.10	●		●	●	●	●		●	●		
	RYMX 0803-MM	1.0-3.5	0.30-0.07	●		●	●							
	1004-MM	1.5-4.0	0.35-0.07	●		●	●							
	1205-MM	1.5-5.0	0.40-0.10	●		●	●	●						
	1205-6MM	1.5-5.0	0.40-0.10	●								●		
	1606-MM	2.0-6.5	0.45-0.10	●		●	●					●		
	1606-7MM	2.0-6.5	0.45-0.10	●		●	●					●		
	RYHX 1205-MM	3.0-8.0	0.40-0.10	●			●							
	RYMX 0803-ML	1.0-3.5	0.25-0.05	●		●	●	●						
	1004-ML	1.5-4.0	0.30-0.05	●		●	●	●						
	1205-ML	1.5-5.0	0.35-0.05	●		●	●	●						
	1205-6ML	1.5-5.0	0.35-0.05	●		●								
	1606-ML	2.0-6.5	0.40-0.05	●		●	●	●						
	1606-7ML	2.0-6.5	0.40-0.05	●										
	2007-ML	3.0-8.0	0.50-0.10	●		●	●	●	●					
	RYHX 0803-ML	1.0-3.5	0.25-0.05	●		●	●							
	1004-ML	1.5-4.0	0.30-0.05	●		●	●							
	RYMX 0803-MLL	1.0-3.5	0.25-0.05			●	●							
	1004-MLL	1.5-4.0	0.30-0.05	●		●	●							
	1205-MLL	1.5-5.0	0.35-0.05	●		●	●							
	RYHX 0803-MLL	1.0-3.5	0.25-0.05			●	●							
	1004-MLL	1.5-4.0	0.30-0.05			●								
	1205-MLL	1.5-5.0	0.35-0.05	●		●	●							

●: Standard items



Inserts

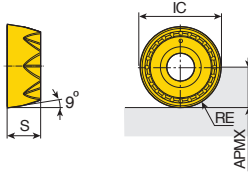

Size	Dimension (mm)						
	RE	IC	S	APMX			
08	4	8	3.2	4.0			
10	5	10	4.0	5.0			
12	6	12	4.8	6.0			
16	8	16	6.1	8.0			
20	10	20	7.0	10.0			

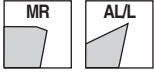

Insert	Designation	Recommended machining conditions		Coated							Uncoated			
		ap (mm)	Feed (mm/tooth)	TT9080	TT9030	TT8080	TT8020	TT8525B	TT7080	TT7515	TT6080	TT2510	K10	
	RYMX 0803-MR	1.0-3.5	0.30-0.05	●				● ●		● ●				
	1004-MR	1.5-4.0	0.35-0.05	●		●			●		●			
	1205-MR	1.5-5.0	0.35-0.05	●		●			●		● ●			
	1606-MR	2.0-6.5	0.40-0.05	●				● ●		● ●				
	2007-MR	3.0-8.0	0.45-0.10	●				●		● ●				
	RYHX 0803-MR	1.5-4.0	0.30-0.05	●							●			
	1004-MR	1.5-5.0	0.35-0.05	●						● ●				
	1205-MR	2.0-6.5	0.35-0.05	●						● ●				
	RYHX 0803-AL	1.0-3.5	0.80-0.10									●		
	1004-AL	1.5-4.0	0.80-0.10									●		
	1205-AL	1.5-5.0	0.80-0.10									●		
	1606-AL	2.0-6.5	0.80-0.10									●		
	RYHX 0803-L	1.0-3.5	0.25-0.05			●								
	1004-L	1.5-4.0	0.30-0.05	●		● ●								
	1205-L	1.5-5.0	0.35-0.05	●		● ●								

●: Standard items



Inserts

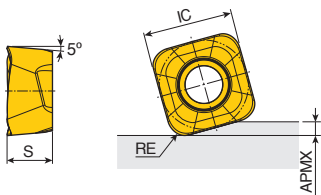

Size	Dimension (mm)				
	IC	S	APMX	RE	
06	6.3	3.16	1.0	1.0	
09	9.0	4.0	1.2	1.5	
13	13.1	6.7	2.0	2.5	

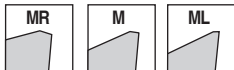

Insert	Designation	Recommended machining conditions		Coated							Uncoated		
		ap (mm)	Feed (mm/tooth)	TT9080	TT8080	TT8020	TT8525B	TT7080	TT7515	TT6080	TT2510		
	SBMT 060310R-M	0.1-1.0	1.50-0.20	●	●								
	090415R-M	0.1-1.2	2.00-0.20	●	●	●	●	●		●	●		
	130625R-M	0.5-2.0	2.00-0.42	●	●	●	●	●		●	●		
	SBMT 060310R-ML	0.1-1.0	1.20-0.10	●	●								
	090415R-ML	0.1-1.2	1.50-0.10	●	●								
	130625R-ML	0.5-2.0	2.00-0.42	●	●								
	SBMT 090415R-MR	0.1-1.2	2.50-0.30	●			●				●		
	130625R-MR	0.5-2.0	2.00-0.42	●							●		



●: Standard items

Inserts

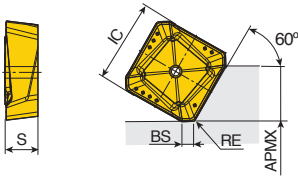

Size	Dimension (mm)					
	IC	S	APMX	BS	RE	
21-HE	20.8	7	13	2	1.5	
27-HE	26.8	8.95	18	2	2	



Insert	Designation	Recommended machining conditions		Coated						Uncoated			
		ap (mm)	Feed (mm/tooth)	TT9080	TT9030	TT8080	TT8020	TT8525B	TT7080	TT7515	TT6080	K10	
	SCKN 2107 DDTR-HE	3.5-10.5	0.25-0.13					●	●	●			
	2708 DDTR-HE	5.0-14.5	0.30-0.15					●					



●: Standard items

SDKN 12/15

Inserts

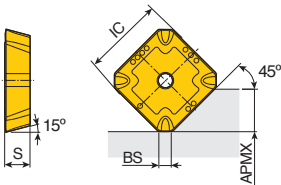

Size	Dimension (mm)					
	IC	S	APMX	BS		
12	12.7	3.18	6.5	2.00		
15	15.875	4.76	8.7	1.89		

Insert	Designation	Recommended machining conditions		Coated						Uncoated			
		ap (mm)	Feed (mm/tooth)	TT9080	TT9030	TT8080	TT8020	TT8525B	TT7080	TT7515	TT6080	K10	
	SDKN 1203 MT-HPN	1.5-6.0	0.25-0.10						●				
	1504 MT-HPN	1.5-8.0	0.25-0.10						●				



●: Standard items

Inserts

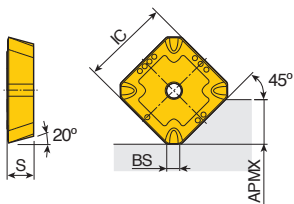

Size	Dimension (mm)				
	IC	S	APMX	BS	
12	12.7	3.18	6.5	2.08	
15	15.875	4.76	8.7	2.06	

Insert	Designation	Recommended machining conditions		Coated							Uncoated	
		ap (mm)	Feed (mm/tooth)	TT9080	TT9030	TT8080	TT8020	TT8525B	TT7080	TT7515	TT6080	K10
	SEKN 1203 AFTN-HPN	1.5-6.0	0.25-0.10					●				
	1504 AFTN-HPN	1.5-8.0	0.25-0.10					●				



●: Standard items

SEKX 21

Inserts

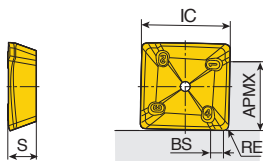

Size	Dimension (mm)					
	IC	S	APMX	BS	RE	
21	21.85	7	17	2	1.2	

Insert	Designation	Recommended machining conditions		Coated							Uncoated	
		ap (mm)	Feed (mm/tooth)	TT9080	TT9030	TT8080	TT8020	TT8525B	TT7080	TT7515	TT6080	K10
	SEKX 2107 PETR-M	5.5-13.0	0.22-0.10					●		●		



●: Standard items

SLOT



Inserts

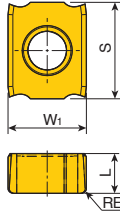

Size	Dimension (mm)						
	S	W ₁	L	RE			
018	8	6.5	1.8	0.4			
023	8	6.5	2.3	0.4			
028	8	6.5	2.8	0.4			
033	8	6.5	3.3	0.4			

Insert	Designation	Recommended machining conditions		Coated							Uncoated		
		ap (mm)	Feed (mm/tooth)	TT9080	TT9030	TT8080	TT8020	TT8525B	TT7080	TT7515	TT6080	K10	
	SLOT 018-04	-	0.08-0.05	●		●				●			
	023-04	-	0.08-0.05	●		●				●			
	028-04	-	0.08-0.05	●		●				●			
	033-04	-	0.10-0.06	●		●				●			

●: Standard items



SNEX(T) 12

Inserts

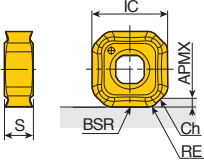

P-W

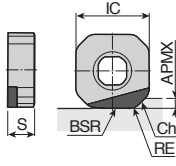

CBN

Size	Dimension (mm)					
	IC	S	APMX	RE	BSR	Ch
1204 P-W	12.7	4.76	1.0	2.0	450	2.5
1204-W	12.7	4.76	1.0	2.0	800	-
1205-W	12.7	5.56	1.0	2.0	450	2.5
1204R-CBN	12.7	4.76	1.0	0.8	250	1.5

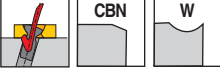

Insert	Designation	Recommended machining conditions		Ct3000	Cermet	CBN	Coated						Uncoated	
		ap (mm)	Feed (mm/tooth)				TT9080	TT9030	TT7515	TT6080	TT2510	K10		
	SNEX 1204 P-W	0.3-0.8	0.15-0.07			TB7015		TT9080	TT9030	TT7515	TT6080	TT2510	K10	
	SNEX 1204-W	0.3-0.8	0.15-0.07											
	SNEX 1205-W	0.3-0.8	0.15-0.07	•				•			•			
	SNEX 1204R-CBN	0.3-0.8	0.12-0.08			•								

• Standard items



SNG(M)X 13



Inserts

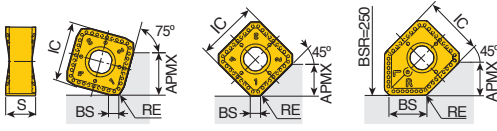

ENTN / XTN

AN(T)N / XTN

W

Size	Dimension (mm)					
	IC	S	APMX	BS	RE	
13 ENTN-M	13.5	7.0	9.5	2.2	0.4	
13 ANTN-M/ML/AL	13.5	6.8	7.0	2.2	0.4	
13 ANTR-MP	13.5	6.8	6.0	2.2	0.4	
13 ANTN-W	13.5	6.8	7.0	7.5	1.2	
13 XTN(75°)	13.5	6.8	9.6	1.4	0.4	
13 XTN(45°)	13.5	6.8	6.35	1.4	0.4	



Insert	Designation	Recommended machining conditions		Coated							Uncoated		
		ap (mm)	Feed (mm/tooth)	TT9080	TT9030	TT8080	TT8020	TT8525B	TT7080	TT7515	TT6080	TT2510	K10
	SNGX 1306 ENTN-M	2.5-8.0	0.20-0.10	•		•		•	•	•			
	SNMX 1306 ENTN-M	2.5-8.0	0.20-0.10	•		•		•	•	•			
	SNGX 1306 ANTN-M	2.0-6.0	0.20-0.10	•		•		•		•			
	1306 ANTN-ML	2.0-6.0	0.25-0.13	•		•				•			
	SNMX 1306 ANTN-M	2.0-6.0	0.20-0.10	•		•		•	•	•	•		
	SNGX 1306 ANN-AL	2.0-6.0	0.35-0.10									•	
	SNMX 1306 ANTR-MP	2.0-6.0	0.20-0.10	•		•				•			
	SNMX 1306 XTN	2.5-6.5	0.20-0.10	•	•			•	•	•	•		
	SNGX 1306 ANTN-W	0.2-1.0	0.20-0.10	•						•			

•: Standard items



Inserts

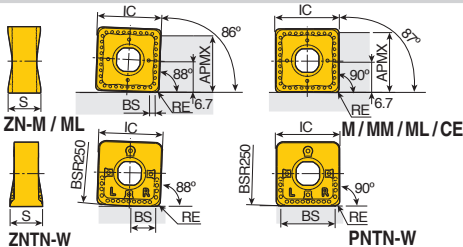

Size	Dimension (mm)					
	IC	S	APMX	BS	RE	
13	13.5	6.8-7.0	10-12	1.2-5.3	0.4-1.6	
13-W	13.5	6.8	10-12	11.5	1.0	

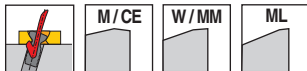

Insert	Designation	Recommended machining conditions		Ceramic										
		ap (mm)	Feed (mm/tooth)	Coated										
				AS10	TT9080	TT9030	TT8080	TT8525B	TT7080	TT7515	TT6080	TT2510	K10	
	SNGX 1306 ZN-M	3.5-10.0	0.20-0.10		●		●		●	●	●			
	SNGX 1306 ZN-ML	3.5-10.0	0.25-0.13				●					●		
	1306C08 ZN-M	3.5-10.0	0.20-0.10		●					●	●			
	130608-MM	3.5-10.0	0.15-0.08				●							
	130612-MM	3.5-10.0	0.15-0.08										●	
	130616-MM	3.5-10.0	0.15-0.08				●		●					
	130608-ML	3.5-10.0	0.25-0.13									●	●	
	130612-ML	3.5-10.0	0.25-0.13									●		
	SNGX 130608-M	3.5-10.0	0.20-0.10		●				●	●	●			
	130612-M	3.5-10.0	0.20-0.10		●						●	●		
	130616-M	3.5-10.0	0.20-0.10		●		●	●	●	●	●			
	130620-M	3.5-10.0	0.20-0.10		●				●	●	●			
	SNGX 130608-CE	3.5-10.0	0.25-0.13	●										
	SNGX 1306 ZNTN-W	0.2-1.0	0.20-0.10		●							●		
	1306 PNTN-W	0.2-1.0	0.20-0.10		●							●		



●: Standard items

SNM(H)X 16



Inserts

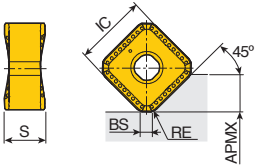

Size	Dimension (mm)					
	IC	S	APMX	BS	RE	
SNMX 16	16.7	7.8	8.8	2.4	0.8	
SNHX 16	16.7	6.4	8.8	2.4	0.8	

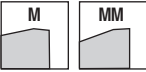

Insert	Designation	Recommended machining conditions		Coated								Uncoated	
		ap (mm)	Feed (mm/tooth)	TT9080	TT9030	TT8080	TT8020	TT8525B	TT7080	TT7515	TT6080	K10	
	SNMX 1607 ANT-N-M	2.5-7.5	0.25-0.13	•		•		•	•		•		
	SNHX 1606 ANN-MM	2.5-7.5	0.20-0.10						•		•		

•: Standard items



Inserts

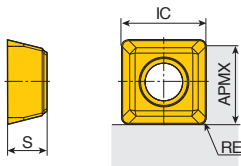

Size	Dimension (mm)				
	IC	S	APMX	RE	
06	6.16	2.56	5.6	0.4	
09	9.8	4.3	9.0	0.8	
11	11.5	4.8	10.7	0.8	
14	14.2	5.2	13.4	0.8	



Insert	Designation	Recommended machining conditions		Cermet	Coated							Uncoated		
		ap (mm)	Feed (mm/tooth)		CT7000	TT9080	TT9030	TT8080	TT8020	TT8525B	TT7080	TT7515	TT6080	K10
	SPMG 090404-EM	2.5-7.5	0.15-0.08						•					
	090408-EM	2.5-7.5	0.15-0.08		•			•		•				
	110408-EM	3.0-8.5	0.16-0.09		•	•	•	•		•		•		
	140508-EM	4.0-11.0	0.18-0.10		•		•	•		•		•		
	SPMT 090408-EM	2.5-7.5	0.15-0.08			•		•		•				
	110408-EM	3.0-8.5	0.16-0.09		•	•	•	•		•		•		
	140508-EM	4.0-11.0	0.18-0.10		•		•	•	•	•		•		
	XOMT 060204	1.5-4.5	0.06-0.03				•	•						

• Standard items



Inserts

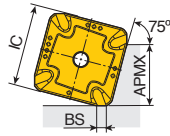
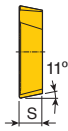

Size	Dimension (mm)							
	IC	S	APMX	BS				
12	12.7	3.18	9.5	1.2-1.6				
15	15.875	4.76	12.5	1.4-1.6				

Insert	Designation	Recommended machining conditions		Coated							Uncoated		
		ap (mm)	Feed (mm/tooth)	TT9080	TT9030	TT8080	TT8020	TT8525B	TT7080	TT7515	TT6080		K10
	SPKN 1203 EDTR-HPN	1.5-7.0	0.25-0.10						●				
	1504 EDTR-HPN	1.5-10.0	0.25-0.10						●				
	SPKN 1203 EDR-HPN	1.5-7.0	0.25-0.10				●			●			
	1504 EDR-HPN	1.5-10.0	0.25-0.10				●			●			

●: Standard items



Inserts

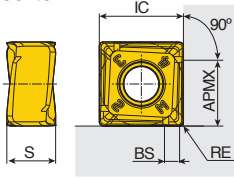

M / ML

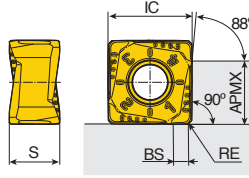

MP / MMP

Size	Dimension (mm)					
	IC	S	APMX	BS	RE	
07	7	4.16	5.0	0.9	0.8	
10-M	10	5.8	7.0	1.1	0.8	
10-MP	10	6	7.0	1.1	0.8	
10-MMP	10	6	6.5	1.1	0.8	
12-MP	12.2	8.06	8.5	1.1	0.8	
12-MMP	12.2	8.06	8.0	1.1	0.8	



Insert	Designation	Recommended machining conditions		Coated								Uncoated			
		ap (mm)	Feed (mm/tooth)	TT9080	TT9030	TT8080	TT8020	TT8525B	TT7080	TT7515	TT6080	TT2510	K10		
	SQKU 070308 PNR-M	1.0-4.0	0.20-0.10	●		●						●	●		
	100408 PNR-M	1.5-5.5	0.20-0.10	●		●						●	●		
	SQKU 070308 PNR-ML	1.0-4.0	0.20-0.10	●		●						●			
	SQKU 100408 PNR-MP	1.5-5.5	0.20-0.10	●								●	●		
	120608 PNR-MP	2.0-6.5	0.25-0.15	●				●				●	●		
	SQHU 100408 PNR-MMP	1.5-5.5	0.25-0.10	●								●			
	120608 PNR-MMP	2.0-6.5	0.25-0.15	●								●			



● Standard items

Inserts

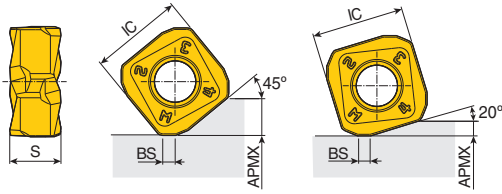

Size	Dimension (mm)					
	IC	S	APMX	BS		
11(45°)	11.2	6.3	4.2	1.9		
11(20°)	11.2	6.3	1.8	1		
14(45°)	14.5	7.8	6	2		
14(20°)	14.5	7.8	2.5	1.6		



Insert	Designation	Recommended machining conditions		Coated								Uncoated	
		ap (mm)	Feed (mm/tooth)	TT9080	TT9030	TT8080	TT8020	TT8525B	TT7080	TT7515	TT6080		K10
	SQKU 1105 ANR-M(45°)	1.0-4.0	0.25-0.10	●				●		●			
	1105 ANR-M(20°)	0.2-1.5	1.50-0.30	●				●		●			
	1406 ANR-M(45°)	2.0-6.0	0.30-0.10	●				●		●			
	1406 ANR-M(20°)	0.3-2.0	2.30-0.40	●				●		●			

●: Standard items



Inserts

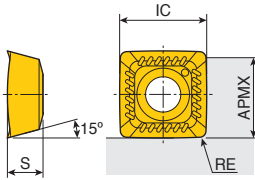

Size	Dimension (mm)					
	IC	S	APMX	RE		
093808	9	3.75	7.5	0.8		
093816	9	3.75	7	1.6		
114508	11	4.5	10	0.8		
114516	11	4.5	9	1.6		



Insert	Designation	Recommended machining conditions		Coated								Uncoated		
		ap (mm)	Feed (mm/tooth)	TT9080	TT9030	TT8080	TT8020	TT8525B	TT7080	TT7515	TT6080	TT3535	K10	
	SVKT 093808-M	7.5	0.15-0.04	●	●									
	114508-M	10.0	0.15-0.04	●	●						●			
	SVKT 093808-ML	7.5	0.15-0.04	●	●							●		
	093816-ML	7.0	0.15-0.04	●	●							●		
	114508-ML	10.0	0.15-0.04	●	●							●		
	114516-ML	9.0	0.15-0.04	●	●							●		
	SVKT 093808-L	7.5	0.12-0.03	●	●									
	093816-L	7.0	0.12-0.03	●	●									
	114508-L	10.0	0.12-0.03	●	●									
	SVHT 114508-L	10.0	0.12-0.03	●	●									

●: Standard items



TIMC/J

Slotting inserts

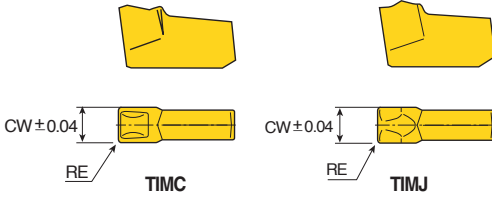

Size	Dimension (mm)			
	Seat size	CW	RE	
1.6	1	1.6	0.16	
2	2	2.2	0.20	
2.4	2	2.4	0.20	
3	4	3.1	0.20	
4	4	4.1	0.25	
4.8	4	4.8	0.28	

Insert	Designation	Recommended machining conditions		Coated							Uncoated		
		ap (mm)	Feed (mm/tooth)	TT9080	TT9030	TT8080	TT8020	TT7220	TT7080	TT6030	TT5100	K10	
	TIMC 1.6	-	0.12-0.04	●									●
	2	-	0.13-0.05	●									●
	2.4	-	0.15-0.06	●									
	3	-	0.18-0.06	●						●	●		
	4	-	0.20-0.08	●				●	●				
	TIMJ 2	-	0.12-0.04										
	2.4	-	0.13-0.05							●			●
	3	-	0.15-0.05								●		●
	4	-	0.18-0.05									●	●
	4.8	-	0.18-0.05					●		●			●

●: Standard items



E234

TIPV

Slotting inserts

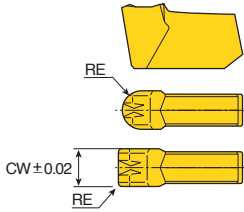

Size	Dimension (mm)			
	Seat size	CW	RE	
TIPV...E ...	3, 4	3.0-4.5	0.4-2.0	
TIPV 1.85-2.15	2	1.85-2.15	0.1-0.2	
TIPV 2.65-4.15	3, 4	2.65-4.15	0.15-0.20	

Insert	Designation	Recommended machining conditions		Coated							Uncoated			
		ap (mm)	Feed (mm/tooth)	TT9080	TT9030	TT8080	TT8020	TT7220	TT7080	TT6030	TT5100			K10
	TIPV 3.00E 0.40	-	0.18-0.06							●	●			
	4.00E 0.40	-	0.20-0.08								●			
	4.50E 0.40	-	0.20-0.08											
	3.00E 1.50	-	0.18-0.06							●	●			
	4.00E 2.00	-	0.20-0.08							●	●		●	
	1.85 0.10	-	0.13-0.05							●	●			
	2.00 0.20	-	0.13-0.05							●	●			
	2.15 0.15	-	0.13-0.05							●	●		●	
	2.65 0.15	-	0.18-0.06								●			
	3.00 0.20	-	0.18-0.06								●		●	
	3.18 0.20	-	0.18-0.06									●	●	
	4.00 0.20	-	0.20-0.08								●			
	4.15 0.15	-	0.20-0.08								●			

●: Standard items



Inserts

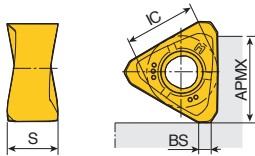

Size	Dimension (mm)					
	IC	S	APMX	BS		
18	11.65	8	13	1.4		
22	12.7	8	15	2.2		



Insert	Designation	Recommended machining conditions		Coated							Uncoated		
		ap (mm)	Feed (mm/tooth)	TT9080	TT9030	TT8080	TT8020	TT8525B	TT7080	TT7515	TT6080	TT2510	K10
	TNMX 1806 PNTR-M	1.0-11.0	0.15-0.07	●		●		●	●	●	●		
	TNMX 1806 PNTR-SMR2	2.7-11.0	0.20-0.10	●		●		●		●			
	TNMX 1806 PNTR-SMR3	2.7-11.0	0.20-0.10	●		●		●		●			
	TNGX 2207 PNTN	1.0-13.0	0.20-0.10	●		●		●	●	●			
	TNMX 2207 PNTN	1.0-13.0	0.20-0.10	●		●		●	●	●	●		

●: Standard items



Inserts

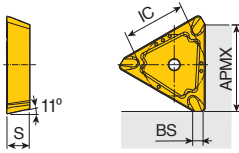

Size	Dimension (mm)				
	IC	S	APMX	BS	
22	12.7	4.76	176	1.7-1.8	

Insert	Designation	Recommended machining conditions		Coated							Uncoated		
		ap (mm)	Feed (mm/tooth)	TT9080	TT9030	TT8080	TT8020	TT8525B	TT7080	TT7515	TT6080	K10	
	TPKN 2204 PDTR-HPN	1.5-13.0	0.25-0.10					•					
	TPKN 2204 PDR-HPN	1.5-13.0	0.25-0.10				•			•			

• Standard items



Inserts

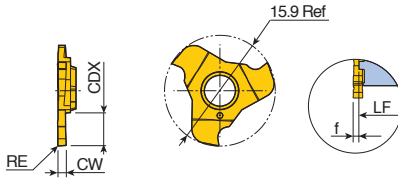

Size	Dimension (mm)			Size	Dimension (mm)		
	CW	RE	CDX		CW	RE	CDX
1.2	1.2	0.05	4.6	3.0	3.0	0.20	4.8
1.4	1.4	0.10	4.8	3.25	3.25	0.15	4.8
1.5	1.5	0.10	4.8	4.0	4.0	0.20	4.8
1.7	1.7	0.10	4.8	4.25	4.25	0.15	4.8
1.95	1.95	0.15	4.8	5.0	5.0	0.20	4.8
2.0	2.0	0.20	4.8	5.25	5.25	0.15	4.8
2.25	2.25	0.15	4.8	6.0	6.0	0.20	4.8
2.75	2.75	0.15	4.8				

Insert	Designation	Recommended machining conditions		f (mm)	Coated								Uncoated				
		CW (mm)	Feed (mm/tooth)		TT9080	TT9030	TT8080	TT8020	TT8525B	TT7080	TT7515	TT6080			K10		
	TS16-1.2-R0.05	1.20	0.08-0.02	0.45		●											
	1.4-R0.1	1.40	0.10-0.02	0.45		●											
	1.5-R0.1	1.50	0.12-0.03	0.45		●											
	1.7-R0.1	1.70	0.12-0.03	0.45		●											
	1.95-R0.15	1.95	0.15-0.04	0.45		●											
	2.0-R0.2	2.00	0.15-0.04	0.45		●											
	2.25-R0.15	2.25	0.15-0.04	0.65		●											
	2.75-R0.15	2.75	0.20-0.04	1.35		●											
	3.0-R0.2	3.00	0.20-0.04	1.35		●											
	3.25-R0.15	3.25	0.20-0.04	1.35		●											
	4.0-R0.2	4.00	0.25-0.05	2.36		●											
	4.25-R0.15	4.25	0.25-0.05	0.96		●											
	5.0-R0.2	5.00	0.30-0.05	2.15		●											
5.25-R0.15	5.25	0.30-0.05	2.15		●												
6.0-R0.2	6.00	0.30-0.05	3.15		●												

●: Standard items



XEVT 16/22-AL



Inserts

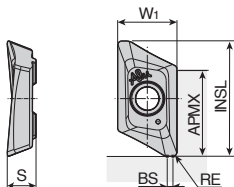

Size	Dimension (mm)					
	INSL	W1	S	APMX	BS	RE
16	18.3-22.2	11.2	5.1-5.5	14-16	0.6-1.5	0.4-5.0
22	22.4-28	13.6	6.8-7.4	18.5-21	1.2-1.7	0.5-6.4

Insert	Designation	Recommended machining conditions		Coated							Uncoated		
		ap (mm)	Feed (mm/tooth)	TT9080	TT9030	TT8080	TT8020	TT8525B	TT7080	TT7515	TT6080	K10	
	XEVT 160504R-AL	3.5-12.0	0.4-0.1									●	
	160508R-AL	3.5-12.0	0.4-0.1									●	
	160512R-AL	3.5-12.0	0.4-0.1									●	
	160516R-AL	3.5-12.0	0.4-0.1									●	
	160520R-AL	3.5-12.0	0.4-0.1									●	
	160524R-AL	3.5-12.0	0.4-0.1									●	
	160530R-AL	3.5-12.0	0.4-0.1									●	
	160532R-AL	3.5-12.0	0.4-0.1									●	
	160540R-AL	3.5-12.0	0.4-0.1									●	
	160550R-AL	3.5-12.0	0.4-0.1									●	
	220605R-AL	3.5-18.0	0.6-0.1									●	
	220608R-AL	3.5-18.0	0.6-0.1									●	
	220616R-AL	3.5-18.0	0.6-0.1									●	
	220620R-AL	3.5-18.0	0.6-0.1									●	
	220630R-AL	3.5-18.0	0.6-0.1									●	
	220632R-AL	3.5-18.0	0.6-0.1									●	
	220640R-AL	3.5-18.0	0.6-0.1									●	
	220650R-AL	3.5-18.0	0.6-0.1									●	
	220664R-AL	3.5-18.0	0.6-0.1									●	

●: Standard items



Inserts

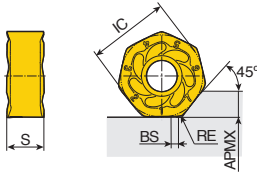

Size	Dimension (mm)				
	IC	S	APMX	BS	RE
06(M, MM, ML)	13.7	6.2	3.5	1.0	1.0
06-MT	13.7	6.0	4.2	-	0.8
06-MLW	13.7	6.2	3.5	1.5	0.2



Insert	Designation	Recommended machining conditions		Material									
		ap (mm)	Feed (mm/tooth)	Ceramic	Coated						Uncoated		
				AS10	TT9080	TT9030	TT8080	TT8525B	TT7080	TT7515	TT6080	TT2510	K10
	XNMU 0605 ANR-M	1.0-3.0	0.20-0.10		●				●		●		
	XNHU 0605 ANN-MM	1.0-3.5	0.20-0.10		●					●	●	●	
	XNHU 0605 ANN-ML	1.0-3.5	0.20-0.10		●		●				●		
	XNMU 060508-MT	1.0-4.2	0.30-0.10				●						
	XNHU 0605 ANR-MLW	0.3-1.0	0.15-0.08				●						

●: Standard items



XNM(H)U 09

Inserts

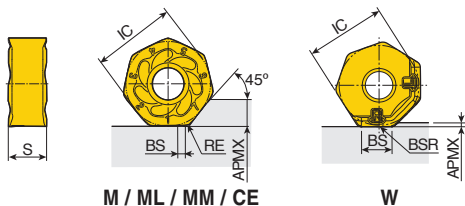

M / ML / MM / CE

W

Size	Dimension (mm)					
	IC	S	APMX	BS	RE	BSR
09	18.5	6.35-7.4	5.0	1.0	1.0	-
09-W	18.5	6.35	1.0	7.1	-	250



Insert	Designation	Recommended machining conditions		Material									
		ap (mm)	Feed (mm/tooth)	Ceramic		Coated						Uncoated	
				AS10	TT9080	TT8080	TT8525B	TT7080	TT7515	TT6080	TT2510	K10	
	XNMU 0906 ANTR-M	1.5-4.0	0.20-0.10	•	•	•	•	•	•	•	•	•	•
	XNMU 0906 ANTN-ML	1.5-4.0	0.25-0.13		•	•	•	•					
	XNHU 0906 ANTN-ML	1.5-4.0	0.25-0.13		•					•			
	XNHU 0906 ANTN-MM	1.5-4.0	0.25-0.13		•	•		•	•	•			
	XNHU 0906 ANTN-CE	1.5-4.0	0.25-0.135	•									
	XNHU 0906 ANTN-W	0.1-1.0	0.20-0.10							•			

• Standard items



E84-E86

Inserts

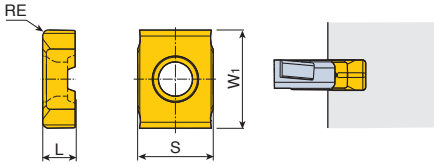

Size	Dimension (mm)				
	W ₁	S	L	RE	
018	10	7.5	1.8	0.2-0.8	
023	10	7.5	2.3	0.2-0.8	
028	10	7.5	2.8	0.2-0.8	
033	10	7.5	3.3	0.2-0.8	
038	13	10	3.8	0.4-0.8	
043	13	10	4.3	0.4-0.8	
048	13	10	4.8	0.4-0.8	
053	13	10	5.3	0.4-0.8	



Insert	Designation	Recommended machining conditions		Coated							Uncoated		
		ap (mm)	Feed (mm/tooth)	TT9080	TT9030	TT8080	TT8020	TT8525B	TT7080	TT7515	TT6080	K10	
	ZNHT 018-04	-	0.08-0.05	●		●					●		
	018-08	-	0.08-0.05	●	●								
	023-04	-	0.08-0.05	●	●					●			
	023-08	-	0.08-0.05	●	●								
	028-04	-	0.10-0.15	●	●					●			
	028-08	-	0.10-0.15	●	●								
	033-04	-	0.12-0.05	●	●					●			
	033-08	-	0.12-0.05	●	●								
	038-04	-	0.12-0.05	●	●					●			
	038-08	-	0.12-0.05	●	●					●			
	043-04	-	0.15-0.05	●	●					●			
	043-08	-	0.15-0.05	●	●					●			
	048-04	-	0.15-0.05	●	●					●			
	048-08	-	0.15-0.05	●	●					●			
	053-04	-	0.15-0.05	●	●					●			
053-08	-	0.15-0.05	●	●					●				
	ZNHT 018-04-ML	-	0.08-0.05		●					●			
	023-04-ML	-	0.08-0.05		●					●			
	028-04-ML	-	0.08-0.05			●				●			
	033-04-ML	-	0.12-0.05			●				●			
	038-04-ML	-	0.12-0.05			●				●			
	043-04-ML	-	0.12-0.05			●				●			
	048-04-ML	-	0.12-0.05			●				●			
	053-04-ML	-	0.12-0.05			●				●			
	ZNHT 018-02-AL	-	0.35-0.10									●	
	023-02-AL	-	0.35-0.10									●	
	028-02-AL	-	0.35-0.10									●	
	033-02-AL	-	0.35-0.10									●	
	038-04-AL	-	0.35-0.10									●	
	043-04-AL	-	0.35-0.10									●	
	048-04-AL	-	0.35-0.10									●	
	053-04-AL	-	0.35-0.10									●	

●: Standard items



Inserts

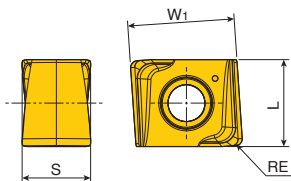

Size	Dimension (mm)				
	L	W ₁	S	RE	
080	7.6	10.7	6.36-6.49	0.8	
110	10.6	13.0	8.38-8.42	0.8	
140	14	13.0	9.59-9.65	0.8	

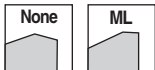

Insert	Designation	Recommended machining conditions		Coated							Uncoated		
		ap (mm)	Feed (mm/tooth)	TT9080	TT9030	TT8080	TT8020	TT8525B	TT7080	TT7515	TT6080		K10
	ZNHU 080-08	-	0.16-0.08	•		•			•	•			
	110-08	-	0.20-0.10	•		•			•	•			
	140-08	-	0.21-0.11	•		•			•	•			
	ZNHU 080-08-ML	-	0.010-0.05	•		•				•			
	110-08-ML	-	0.12-0.06	•		•				•			
	140-08-ML	-	0.12-0.06	•		•							



• Standard items

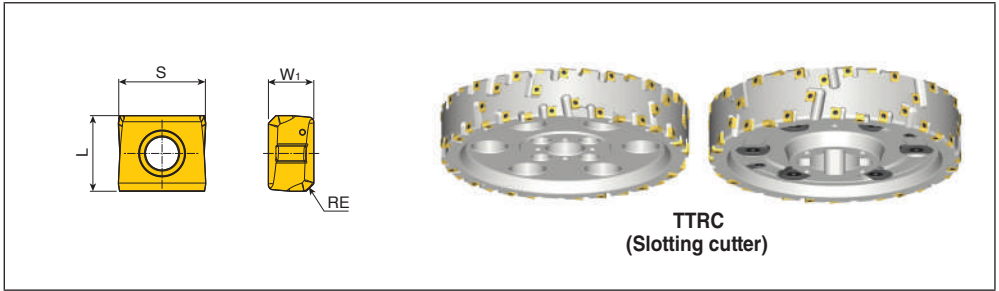

Tailor-made Insert

Tangential inserts



Insert	Designation	Dimension (mm)			
		L	S	W ₁	RE
	LNC 1060-C	10.0	11.5	6.0	chamfer
	LNC 137020-L	13.6	11.6	6.7	2.0
	LNCX 136508 PNR-ML	13.0	10.6	6.5	0.8





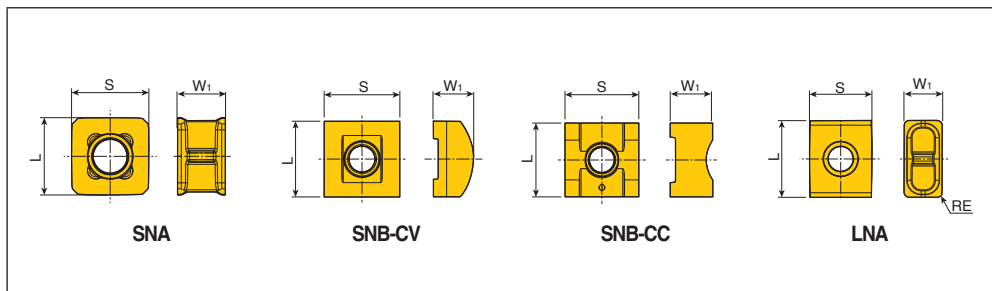

Insert	Designation	Dimension (mm)			
		L	S	W ₁	RE
	PMIN 120905-M	12.0	9.7	5.4	2.0
	PMIN 130907-M	13.5	9.7	7.0	2.0
	PMIN 150907-M	15.0	9.9	7.0	2.0
	PMIN 180907-M	18.0	9.7	7.0	2.0

Tailor-made Insert

Tangential inserts



Insert	Designation	Dimension (mm)			
		L	S	W ₁	RE
	SNA 1065-M	10.5	10.5	6.5	-
	SNA 1370-M	13.0	13.0	7.0	-
	SNA 1680-M	16.0	16.0	8.0	-
	SNB 1375-CV	13.0	13.0	7.5	-
	SNB 1685-CV	16.0	16.0	8.5	-
	SNB 1375-CC	13.0	13.0	7.5	-
	SNB 1685-CC	16.0	16.0	8.5	-
	LNA 137008-M	13.5	10.0	6.7	0.8
	LNA 168008-M	16.5	14.0	8.0	0.8

- ▶ CV: Convex, CC: Concave
- ▶ Various corner radii are available for SNB insert



TRMT
(Form profile cutter)



Recommended Cutting Conditions

Machining data for MAXI-SPEED

ISO	Material		Hardness HB	Vc(m/min)	Feed (mm/tooth)		
	Material	AISI/SAE/ASTM			TR13	TR15	TR17
P	Non-alloy steel	1020	130-180	120-200	0.04-0.12	0.05-0.15	0.06-0.15
	Low alloy steel	4030	260-300	200-300	0.04-0.12	0.05-0.15	0.06-0.15
	Low alloy steel	3135	HRC 35-40	80-120	0.02-0.06	0.03-0.12	0.04-0.12
	High alloy steel	H13	200-220	100-150	0.03-0.07	0.04-0.12	0.04-0.12
M	Martensitic stainless steel	420	200	100-150	0.02-0.06	0.04-0.12	0.04-0.12
	Austenitic stainless steel	304L	200	80-120	0.02-0.06	0.03-0.10	0.03-0.12
K	Gray cast iron	Class 40	250	150-200	0.04-0.12	0.05-0.20	0.05-0.20
	Malleable cast iron	Class 65 45 12	200	130-180	0.04-0.10	0.05-0.18	0.05-0.18
S	High temp. alloys	Inconel 718	HRC 36-40	20-30	0.015-0.10	0.02-0.12	0.02-0.12
		AMS R56400	HRC40-45	30-40	0.015-0.06	0.02-0.12	0.02-0.12

► For more information of material groups, see the materials & grades "material conversion table".

■ Steel
 ■ Stainless steel
 ■ Cast iron
 ■ Nonferrous
 ■ High temp. alloys
 ■ Hardened steel

Recommended Cutting Conditions

Machining data for CBN grade

ISO	Material	D.O.C. (mm)	Grade		
			TB7015		
			Cutting speed Vc(m/min)	Feed (mm/tooth)	Cutting edge
P	Bearing steel	< 2	180 - 220	0.05 - 0.25	Chamfer
	Ferrous powder metal	< 2	150 - 300	0.1 - 0.15	Chamfer
K	Grey cast iron HB 200 - 280	< 0.5	500 - 1500	0.1 - 0.3	Chamfer hone
		0.5 - 2.0	500 - 1100	0.1 - 0.25	Chamfer
	Compared graphite iron (CGI)	< 0.5	400 - 600	0.1 - 0.2	Hone
S	Co based > 35 HRC	0.5 - 2.0	150 - 200	0.05 - 0.15	Chamfer
	Ni based > 35 HRC		120 - 150	0.05 - 0.15	Chamfer
	Fe based > 35 HRC		60 - 120	0.05 - 0.15	Chamfer
	Cr based > 35 HRC		50 - 75	0.05 - 0.15	Chamfer
H	Hardened steels > 45 HRC	< 0.5	80 - 180	0.1 - 0.25	Chamfer
	Hardened cast iron	< 2	80 - 200	0.1 - 0.15	Chamfer

► For more information of material groups, see the materials & grades "material conversion table".

■ Steel
 ■ Stainless steel
 ■ Cast iron
 ■ Nonferrous
 ■ High temp. alloys
 ■ Hardened steel

Recommended Cutting Conditions

Machining data

Cutting Speed: Vc(m/min)

ISO	Material	Condition	Tensile strength (N/mm ²)	Hardness HB	Material No.	Uncoated				
						K10	TT9080	TT9030	TT7080	TT8525B
P	Non-alloy steel, cast steel, free cutting steel	< 0.25%C Annealed	420	125	1		220-370	190-310	250-410	160-270
		>= 0.25%C Annealed	650	190	2		180-310	160-260	200-380	140-210
		< 0.55%C Quenched and tempered	850	250	3		115-195	105-185	140-230	90-160
		>= 0.55%C Annealed	750	220	4		130-210	120-200	160-250	100-170
		Quenched and tempered	1000	300	5		115-175	95-160	135-195	80-140
	Low alloy steel and cast steel (less than 5% of alloying elements)	Annealed	600	200	6		175-265	160-250	190-290	140-200
			930	275	7		130-215	120-200	150-240	90-160
		Quenched and tempered	1000	300	8		105-185	95-175	135-225	70-150
			1200	350	9		95-160	80-150	120-190	60-110
	High alloy steel, cast steel and tool steel	Annealed	680	200	10		85-155	75-135	100-150	60-90
Quenched and tempered		1100	325	11		75-135	65-120	90-140	50-90	
M	Stainless steel and cast steel	Ferritic / martensitic	680	200	12		115-270	100-250		
		Martensitic	820	240	13		100-230	80-200		
		Austenitic	600	180	14		120-275	110-260		
K	Gray cast iron (GG)	Ferritic		160	15		130-300			
		Pearlitic		250	16		120-280			
	Cast iron nodular (GGG)	Ferritic		180	17		110-220			
		Pearlitic		260	18		100-200			
Malleable cast iron	Ferritic		130	19		150-250				
	Pearlitic		230	20		100-250				
N	Aluminum - wrought alloy	Not cureable		60	21	550-700				
		Cured		100	22	600-750				
	Aluminum-cast, alloyed	<=12% Si Not cureable		75	23	800-900				
		Cured		90	24	650-800				
		>12% Si High temp.		130	25	250-320				
	Copper alloys	>1% Pb Free cutting		110	26	300-400				
		Brass		90	27	300-400				
	Non-metallic	Electrolitic copper		100	28	210-280				
		Duroplastics, fiber plastics		70 Shore D	29	150-250				
		Graphite								
S	High temp. alloys	Fe based	Annealed		200	31		40-80		
			Cured		280	32		30-60		
		Ni or Co based	Annealed		250	33		35-70		
			Cured		350	34		30-60		
			Cast		320	35		35-65		
	Titanium, Ti alloys	Pure	Rm 400	190	36		90-130			
Alpha+beta alloys, hardened	Rm 1050	310	37		35-70					
H	Hardened steel	Hardened		55HRC	38		40-75	40-60		
		Hardened		60HRC	39		30-55	30-55		
	Chilled cast iron	Cast		400	40		70-105	60-100		
Cast iron nodular	Hardened		55HRC	41		50-65	40-60			

► For more information of material groups, see the materials & grades "material conversion table".

■ Steel
 ■ Stainless steel
 ■ Cast iron
 ■ Nonferrous
 ■ High temp. alloys
 ■ Hardened steel

Recommended Cutting Conditions

Machining data

Cutting Speed: Vc(m/min)

Coated									Diamond Coated	Ceramic				Cermet
TT8080	TT8020	TT6080	TT7515	TT3535	TT3525	TT2510	TT5515	TT5525	TTD620	AS10	AS20	TC3020	TC3030	CT7000
170-250	150-210						260-280	150-210						270-510
130-220	120-200						200-230	120-200						230-450
90-170	70-140						160-220	70-140						150-370
100-190	90-150						160-220	90-150						210-430
70-160	60-130						140-180	60-130						150-280
150-220	130-170						160-220	130-170						150-285
110-190	70-150						120-180	70-150						100-190
80-160	60-110						130-180	60-110						90-170
70-120	50-100						140-180	50-100						80-130
70-110	50-80						130-180	60-100						100-170
60-100	40-80						70-120	60-120						80-120
90-200	75-170			130-240	130-240		80-150	75-170						
70-160	60-130			120-240	120-240		60-140	60-130						
100-210	80-180			100-200	100-200		60-120	80-180						
		180-350	200-390				250-430	80-260		400-900				
		140-280	160-300				190-270	130-240		250-600				
		115-230	130-250					150-270		350-800				
		100-200	110-210					90-270		250-600				
		190-310	210-330					150-270		360-540				
		120-260	130-280					140-240		300-440				
									250-350					
									500-900					
30-65				40-70	40-70		20-40	30-55			500-900			
20-45				40-65	40-70		20-30	20-45			500-900			
25-50				30-70	30-70		20-30	25-50			500-900	600-1200	600-1200	
20-40				30-55	30-55		20-30	20-40			500-900	600-1200	600-1200	
20-45				35-70	35-70		30-70	20-45			500-900	600-1200	600-1200	
60-100				70-120	70-120		30-70	50-90			500-900			
25-55				40-75	40-75		30-70	25-55			500-900			
		60-90					70-180							
		50-90					50-130							
		60-100					60-120	60-80						
		60-80					70-95	30-50						

Mounting Reference

Arbor style

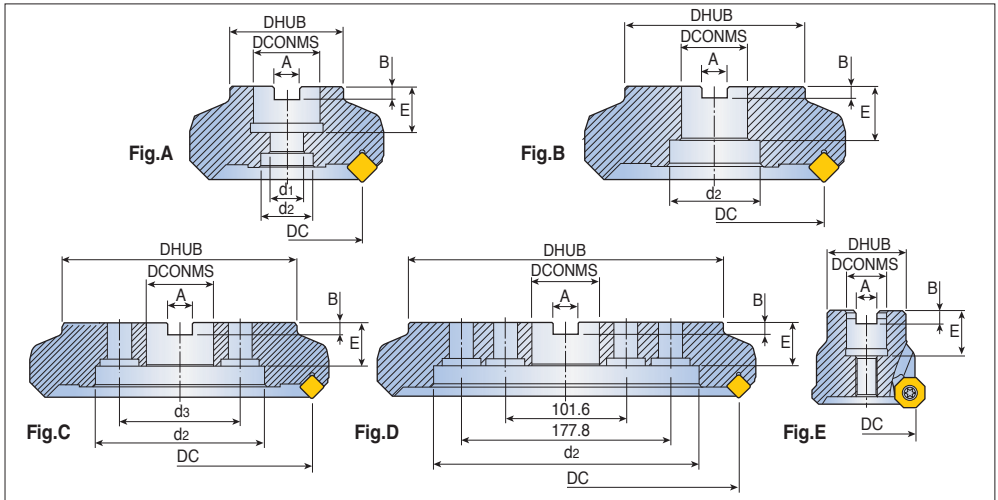

Dimension (mm)										Fig.	Arbor
DC	DCONMS	A	B	E	DHUB		d1	d2	d3		
					For mold & die	For general					
32	16	8.4	5.6	20	30	-	-	-	-	E	SEM16
32	16	8.4	5.6	20	30	-	9	13.5	-	A	SEM16
40	16	8.4	5.6	20	38	-	9	13.5	-	A	SEM16
40	22	10.4	6.3	22	38	-	11	17	-	A	SEM22
50	22	10.4	6.3	22	40	45	11	17	-	A	SEM22
63	22	10.4	6.3	22	47	-	11	17	-	A	SEM22
80	25.4	9.526	6	26	-	70	13	20	-	A	FMA25.4
80	27	12.4	7	28	58	70	13	22	-	A	SEM27
100	31.75	12.7	8	32	-	80	18	26	-	A	FMA31.75
100	31.75	12.7	8	32	-	80	-	46	-	B	FMA31.75
100	32	14.4	8	26	66	85	18	26	-	A	SEM32
100	32	14.4	8	26	66	85	-	46	-	B	SEM32
125	38.1	15.875	10	38	80	-	-	56	-	B	FMA38.1
125	40	16.4	9	32	85	-	22	32	-	A	SEM40
125	40	16.4	9	32	85	-	-	56	-	B	SEM40
160	40	16.4	9	32	110	-	-	90	66.7	C	FM40
160	50.8	19.05	11	38	100	-	-	72	-	B	FMA50.8
200	47.625	25.4	14	38	130	-	-	132	101.6	C	FMA47.625
200	60	25.7	14	40	130	-	-	132	101.6	C	FM60
250	47.625	25.4	14	38	160	-	-	150	101.6	C	FMA47.625
250	60	25.7	14	40	160	-	-	150	101.6	C	FM60
315	47.625	25.4	14	38	220	-	-	224	-	D	-
315	60	25.7	14	40	220	-	-	220	-	D	-

► For Face Mill arbors, please refer to TaeguTec tooling system(part G)

Mounting Reference

Mounting bolt

SH type

Designation	Dimension (mm)					Cutter size
	D	L	L ₁	T	E	
SH M8x1.25x25(-C)	13	33	8	8	6	32,40
SH M8x1.25x30(-C)	13	38	8	8	6	32,40
SH M8x1.25x35(-C)	13	43	8	8	6	32,40
SH M10x1.5x30(-C)	16	40	10	10	8	50, 63
SH M12x1.75x35(-C)	18	47	12	12	10	80
SH M16x2x35(-C)	24	51	16	16	14	100
SH M20x2.5x40(-C)	30	60	20	20	17	125

► "-C": Bolt with hole for internal coolant

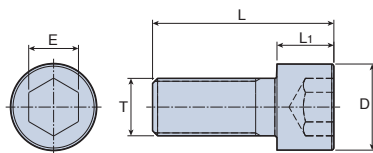

SH

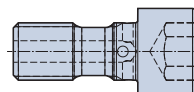

SH-C

LH type

Description	Dimension (mm)					Cutter size
	D	L	L ₁	T	E	
LH M10x1.5x25(-C)	16	31.5	6.5	10	8	50, 63
LH M12x1.75x30(-C)	18	36.9	6.9	12	8	80
LH M16x2x35(-C)	24	45	10	16	12	100

► "-C": Bolt with hole for internal coolant

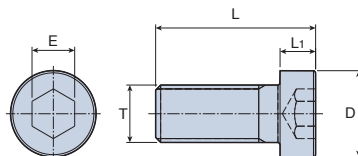

LH

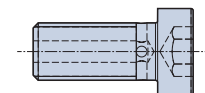

LH-C

KTB, TCS type

Description	Dimension (mm)					
	L	L ₁	L ₂	T ₁	T ₂	E
KTB 32B	30	10	10	M8X1.0	M8X1.25	4
TCS10-40	40	10	15	M10X1.25	M10X1.5	5

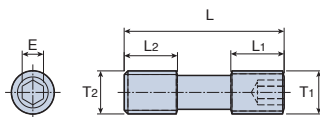

KTB, TSC

► Recommended clamping torque for each screw

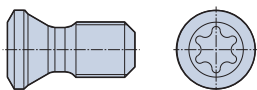

Fig.1

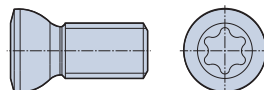
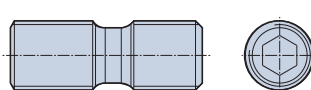
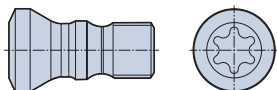

Fig.2

Designation	Thread	Length	Torx	Tightening Torque	Fig.
TS 18033/HG-P	M1.8	3.3	Torx Plus 6	0.5 Nm	1
TS 18041/HG	M1.8	4.09	Torx Plus 6	0.5 Nm	1
TS 18041/SG-P	M1.8	4.09	Torx Plus 6	0.5 Nm	1
TS 200431/HG-P	M2	4.3	Torx Plus 6	0.6 Nm	1
TS 22046I	M2.2	4.6	Torx 7	0.9 Nm	1
TS 220521/HG	M2.2	5.2	Torx 7	0.9 Nm	1
TS 250551/HG	M2.5	5.5	Torx 8	1.2 Nm	1
TS 250751/HG	M2.5	7.5	Torx 8	1.2 Nm	1
TS 25064I	M2.5	6.4	Torx 8	1.2 Nm	1
TS 250641/HG-P	M2.5	6.4	Torx Plus 8	1.2 Nm	1
TS 25B0241/HG	M2.5	2.6	Torx Plus 7	0.9 Nm	1
TS 25B0311/HG	M2.5	3.3	Torx Plus 7	0.9 Nm	1
TS 25B0421/HG	M2.5	4.35	Torx Plus 7	0.9 Nm	1
TS 25B0531/HG	M2.5	5.45	Torx Plus 7	0.9 Nm	1
TS 25C0651/HG	M2.5	6.5	Torx 8	1.2 Nm	2
TS 300851/HG	M3	8.5	Torx 9	2.0 Nm	1
TS 30A0601/HG	M3	6	Torx 9	2.0 Nm	1
TS 30B0681/HG	M3	6.8	Torx 8	1.2 Nm	1
TS 30D082-P	M3	8.2	Torx Plus 8	1.2 Nm	1
TS 350701/HG	M3.5	7	Torx 15	3.0 Nm	1
TS 350851/HG	M3.5	8.75	Torx 15	3.0 Nm	1
TS 35088I	M3.5	8.75	Torx 10	2.0 Nm	1
TS 35A0701/HG	M3.5	7	Torx Plus 10	2.0 Nm	1
TS 35A0881/HG	M3.5	8.75	Torx Plus 10	2.0 Nm	1
TS 35C110I	M3.5	11	Torx 15	3.0 Nm	2
TS 400851/HG	M4	8.5	Torx 15	3.5 Nm	1

Designation	Thread	Length	Torx	Tightening Torque	Fig.
TS 40093I	M4	9.3	Torx 15	3.5 Nm	1
TS 400931/HG	M4	9.3	Torx 15	3.5 Nm	1
TS 40097I	M4	9.7	Torx 15	3.5 Nm	1
TS 40120I	M4	12	Torx 15	3.5 Nm	1
TS 401201/HG	M4	12	Torx 15	3.5 Nm	1
TS 40A100I	M4	10	Torx 15	3.5 Nm	1
TS 40A115I	M4	11.5	Torx 15	3.5 Nm	1
TS 40B100I	M4	10	Torx 15	3.5 Nm	2
TS 40G110I	M4	11	Torx 15	3.5 Nm	1
TS 40M100/HG	M4	10	Torx 15	3.5 Nm	2
TS 40K535I	M4	5.35	Torx 15	3.5 Nm	1
TS 40K065I	M4	6.5	Torx 15	3.5 Nm	1
TS 40K075I	M4	7.5	Torx 15	3.5 Nm	1
TS 40K085I	M4	8.5	Torx 15	3.5 Nm	1
TS 45120I	M4.5	12	Torx 20	5.0 Nm	2
TS 50105I	M5	10.5	Torx 20	5.0 Nm	1
TS 50115I	M5	11.5	Torx 20	5.0 Nm	1
TS 50A140I	M5	14	Torx 20	5.0 Nm	1
TS 50A1211/HG	M5	12.1	Torx 20	5.0 Nm	1
TS 50B1061/HG	M5	10.6	Torx 20	5.0 Nm	1
TS 50C1301/HG	M5	13	Torx 20	5.0 Nm	2
TS 50D130/HG-P	M5	13	Torx Plus 20	5.0 Nm	1
TS 60A130I	M6	13.5	Torx 25	6.0 Nm	2
TS 60A165I	M6	16.5	Torx 25	6.0 Nm	2
TS 60170I	M6	17	Torx 25	6.0 Nm	1



Designation	Thread	Length	Torx	Tightening Torque
TS 20F060A	M2	5	Torx 6	0.7 Nm
TS 25F080A	M2.5	6.9	Torx 8	1.1 Nm
TS 30F100A	M3	8.3	Torx 10	2.0 Nm
TS 40F120A	M4	10.6	Torx 15	4.0 Nm
TS 50F160A	M5	13.9	Torx 20	5.0 Nm
TS 60F200A	M6	16.7	Torx 25	6.0 Nm
TS 70F250A	M7	21	Torx 25	7.0 Nm
TS 80F300A	M8	25	Torx 30	8.0 Nm

Designation	Thread	Length	Torx	Tightening Torque
WS 4	M4	12.5	Hexa 2.0mm	1.5 Nm
WS 5	M5	14	Hexa 2.5mm	3.3 Nm
WS 6	M6	15	Hexa 3mm	5 Nm
WS 8	M8	21	Hexa 4mm	7 Nm

► Quick change cutter adapter

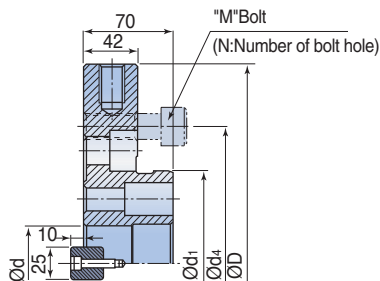
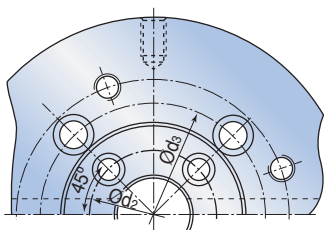
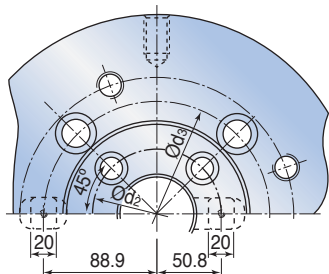

Fig.1

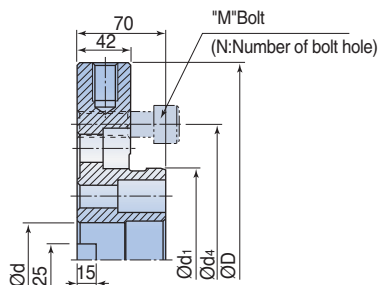

Fig.2

Designation	Dimension (mm)							M	N	Weight (Kg)
	D	d	d ₁	d ₂	d ₃	d ₄				
QA 08 K/M	198	47.625	63.5	101.6	-	114.3	M16x40	4	10	
QA 10 K/M	248	60	133.35	101.6	-	177.8	M16x50	4	15	
QA 12 K/M	313	60	146.05	101.6	177.8	215.9	M20x50	4	19.7	
QA 14 K/M	353	60	215.9	101.6	177.8	260.4	M20x50	6	24	
QA 16 K/M	398	60	254.0	101.6	177.8	304.8	M20x50	6	29	

► K: Adapter with setting key (Fig.1)

M: Adapter without setting key (Fig.2)

► How to use splitter

- 3 splitting grooves on one cutting edge and 2 splitting grooves on the opposite side

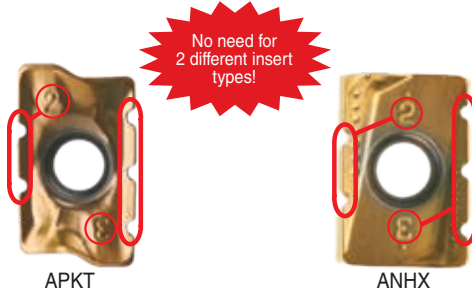

- Full proof configuration-inserts have metal color appearance only on the 3 groove side for simplified mounting



Notice: When insert mounting, ensure they are mounted in a staggered formation i.e. 1st tooth-2 groove side; 2nd tooth-3 groove side and repeat action for the remaining teeth

- Both cutting edges split chip to small pieces for cutting load reduction and create complete cutting edge when combined.

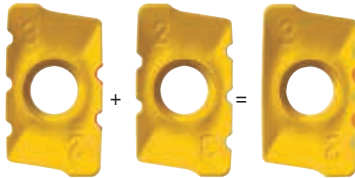

- For optimum machining efficiency, use even numbered flute type cutters

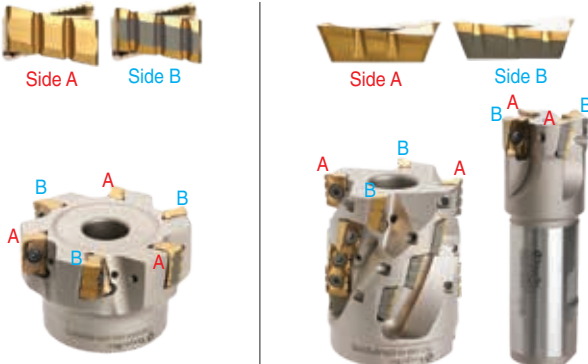

Also applicable to odd numbered flute type cutters

- The splitter inserts effective in axial depth of cuts $\geq d_1$

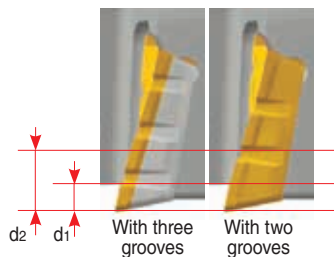

Depth of cut	APKT 17	APKT 12
d ₁	3mm	2.4mm
d ₂	6.5mm	5.2mm

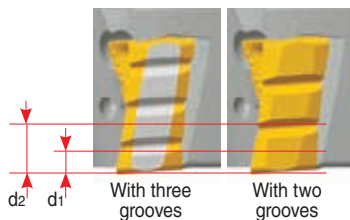

Depth of cut	ANHX 16
d ₁	2.5mm
d ₂	6mm

▶ Setting instructions

Height gauge

Insert

Insert screw

Adjust wedge

Wedge screw

T-Wrench



1 Move the adjust wedge to its bottom-most position by rotating the wedge screw clockwise.



*Please avoid using too much force.

2 Mount new cutting edge of insert. Make sure that the insert pocket is thoroughly cleaned before mounting insert.



*Please fix the insert screw completely as readjustment is not expected once it is done.

3 Measure the Runout of the cutter when all inserts are mounted and select the highest insert as a reference.



*Please ensure that insert edge does not get damaged during setting. Use optimum dial pressure only.

4 Set the height of cutter, raising the reference insert by turning the wedge screw counter clockwise.



*Increase height by 0.01mm at least from the highest insert.

5 Adjust axial Runout of the remaining inserts with the same process as used with the reference insert.



*Please note that max adjustment height should not exceed 0.1mm(.004")

5 Adjust Runout in the range of 0.005mm rotating the wrench gradually.



5 If it is beyond the acceptable range, please reset it with the order of **1 - 2 - 5**



6 Runout adjustment is completed.(you don't have to clamp the insert screw anymore once it is fixed.)

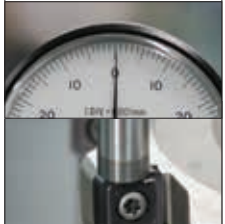

► Gauge user guide

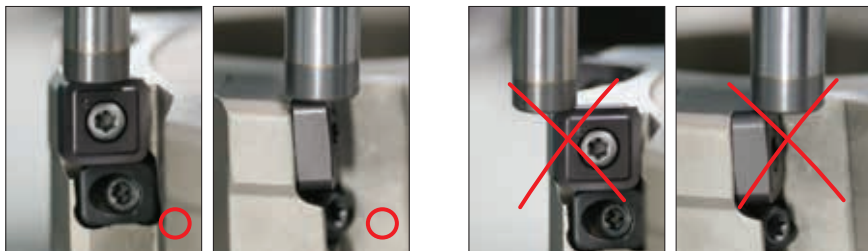

► Special precautions

- While loading a new insert corner, ensure that the adjust wedge is in the bottom-most position
 Bottom out the adjust wedge completely before unclamping the insert from cutter
- Clean the insert and pocket thoroughly before mounting fresh insert /corner
- While assembling adjust wedge onto cutter body, please ensure that the adjust wedge is tightened until it reaches the bottom

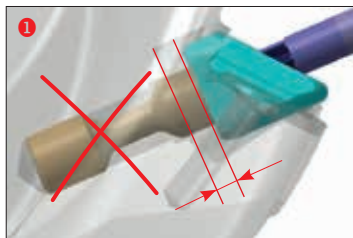

▶ TOPSLOT component names

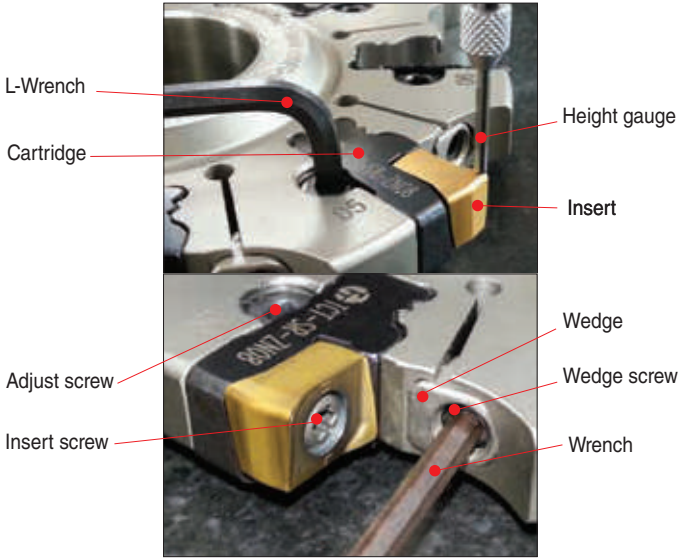

▶ TOPSLOT setup instructions

■ Disk type



B=Cutting width (Target width)
 H=Cutter height (Datum)
 A=Width of cutter body
 X=Distance between insert and cutter body

■ Flange type



▶ Setting procedure

■ Disk type

- 1 Index unused inserts firmly onto the cartridge.



- 2 Unfasten the wedge screw 1 turn counter-clockwise.



- 3 After fastening the wedge around 80%, adjust the cartridge to the desired "X" value after setting the datum zero point.



- 4 Follow the same method about other cartridges. (the same as opposite side)

- 5 After setting all cartridges, sequentially fasten the wedge 100% over two or three times.

- When adjusting cartridge to the "X" value, set the location of cartridge higher than "X" value and then adjust the cartridge to the "X" value.
- Clockwise rotation : cartridge descends.
- Counter-clockwise rotation : cartridge ascends.

■ Flange type

- 1 For setting of bottom face, repeat disk type steps 1-4. (The datum is bottom plane of flange type cutter.)



- 2 For top face set-up, the use of setting plate is mandatory and the height gauge must be reset to '0' for each insert.



- 3 Put the cutter bottom face on the setting plate and unfasten wedge screw 1 turn counter-clockwise



- 4 After fastening the wedge around 80%, adjust the cartridge to the desired (A+X) value.



- 5 Follow the same method about other cartridges.

- 6 After setting all cartridges, sequentially fasten the wedge 100% over two or three times.

- When adjusting cartridge to the "X" value, set the location of cartridge higher than "X" value and then adjust the cartridge to the "X" value.
- Clockwise rotation: cartridge descends.
- Counter-clockwise rotation: cartridge ascends.

▶ Setting notice

■ Important set-up points

- All adjustments must be done on a plane, flat surface.
- For improved accuracy, remove any foreign substances from the insert and insert pocket surfaces before clamping.
- During reassembly wedges and wedge screws, you must apply lubricant of the friction surface. (Fig.1)
- "X" value must be equal for both top and bottom faces when adjusting the width of slot. (Fig.2)
- Width of cut must be adjusted within the range of the laser marked on the cutter. (Fig.3)
Ex) WIDTH 12-13 / WIDTH 20-23
- When adjusting cartridge to the "X" value, set the location of cartridge higher than "X" value and then adjust the cartridge to the "X" value.



Fig.1 Lubricant



Fig.2 "X" setting



Fig.3 WIDTH

► Narrow width slotting cutters



- Metric cutting diameters:
75mm, 100mm, 125mm, 160mm, 250mm
- Cutting width ranges: 1.6mm - 6.35mm
- Geometry: Positive Rake
- Applications: Slotting and sawing
- Materials: Carbon steels, alloy steels, stainless steels, cast iron, aluminum and exotics

■ Features / Benefits of slotting cutters

- Narrow width applications to 1.6mm
- Simple easy-to-mount inserts
- Secure insert retention self-positioning insert stopper for repeatability
- Drive flange mounting for extra stability
- Minimal radial runout
- Efficient chip evacuation
- Reduced cutting forces
- Improved tool life
- Economical

► Recommended feed rates for - TSC slotting cutters

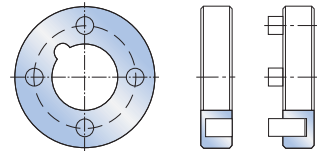
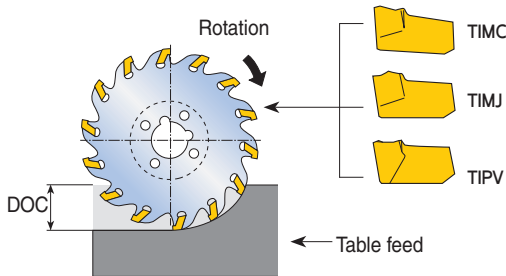

Drive flange set
recommended for
style 2 cutters

► Recommended feed rates (Based on insert width)

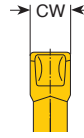
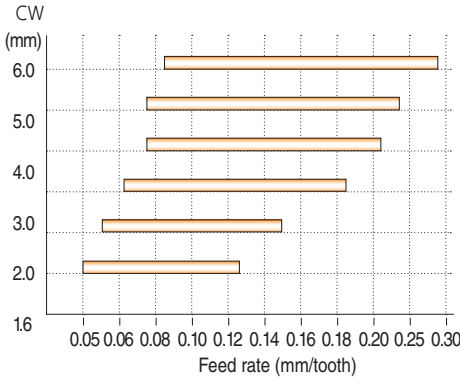

Feed rates are for radial
D.O.C. => 1/4 the cutter diameter
For radial DOC < 1/4 the cutter diameter
increase feed rates by the following %

DOC/Cutter diameter	1/4	1/6	1/8	1/10	1/20
Increase feed rate by ->	0%	15%	30%	45%	45%

■ Cutter entry

Climb milling enters the workpiece with a thick chip and exits with a thin chip. Honed inserts are recommended.

Conventional milling enters the workpiece with a thin chip and exits with a thick chip.

Sharp inserts are recommended. Climb milling should be used whenever possible, especially when replacing high speed steel slotting cutters. On machines with backlash eliminators, climb milling is preferred.

■ Cutter mounting

The use of drive flange sets are recommended to prevent denting of arbor drive keys and to provide added stability during increased metal removal rates.

■ Insert mounting

Manually place insert in pocket and seat in place by using a wooden or plastic hammer.

This will ensure self positioning for insert repeatability and minimal radial runout.

Pockets must be clean and free of debris prior to installation.

Ramping Data

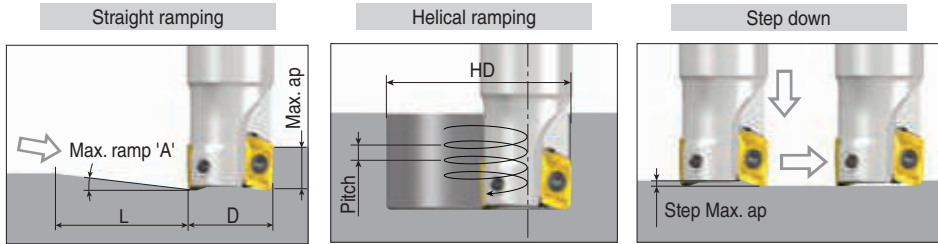

AVKT 10

(unit: mm)

Cutter dia. (D)	Straight ramp down			Helical ramp down			Step down
	Max. ramp (A°)	Max. ap	Min. length (L)	Min. dia. (HD)	Max. dia. (HD)	Max. pitch/rev.	Max. ap
Ø16	10.9	10	52	20		2.4	1.7
					32	9.7	
Ø18	8.3	10	69	24		2.7	2.2
					36	8.2	
Ø20	6.5	10	88	28		2.9	2.1
					40	7.2	
Ø25	4.3	10	133	38		3.1	2.3
					50	5.9	
Ø32	2.9	10	198	52		3.2	2.0
					64	5.1	
Ø40	2.1	10	273	68		3.2	2.2
					80	4.6	
Ø50	1.6	10	358	88		3.3	2.4
					100	4.4	
Ø63	1.2	10	478	114		3.4	2.1
					126	4.1	

Ramping Data

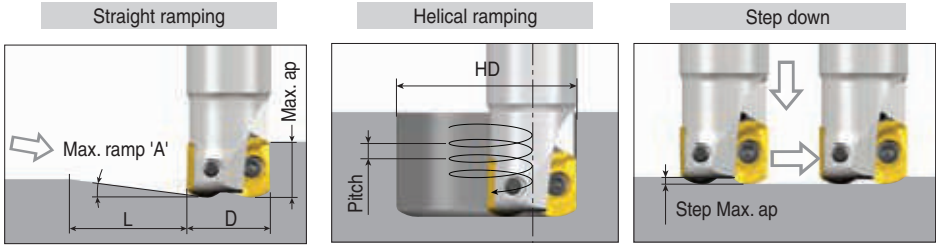

AVKT 1004R-HF

(unit: mm)

Cutter dia. (D)	Straight ramp down			Helical ramp down			Step down
	Max. ramp (A°)	Max. ap	Min. length (L)	Min. dia. (HD)	Max. dia. (HD)	Max. pitch/rev.	Max. ap
Ø16	7.6	10	75	20.5		1.9	0.8
					32	6.7	
Ø18	5.5	10	104	24.5		2.0	1.0
					36	5.4	
Ø20	4.2	10	136	28.5		2.0	1.2
					40	4.6	
Ø25	2.6	10	220	38.5		1.9	1.3
					50	3.6	
Ø32	1.7	10	337	52.5		1.9	1.4
					64	3.0	
Ø40	1.2	10	478	68.5		1.9	1.4
					80	2.6	
Ø50	0.9	10	637	88.5		1.9	1.4
					100	2.5	
Ø63	0.7	10	819	114.5		2.0	1.4
					126	2.4	

Programming technical data

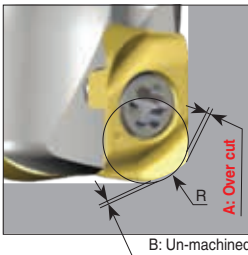

	R Program	A Over cut	B Un machined
AVKT 1004R-HF	1.7	0	0.49
	1.9	0	0.43
	2.0	0.01	0.40
	2.5	0.13	0.24
	3.0	0.30	0.11

Yellow background: Recommended program 'R'

Ramping Data

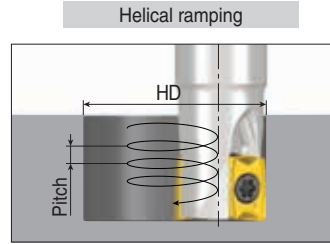
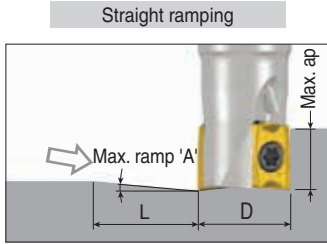

CVK(H)T 05: R0.2

(unit: mm)

Cutter dia.(D)	Straight ramp down			Helical ramp down		
	Max. ramp (A°)	Max. ap	Min. length (L)	Min. dia.(HD)	Max. dia.(HD)	Max. pitch/rev.
Ø6	2.5	5.0	112	8		0.2
					12	0.7
Ø8	2.1	5.0	136	12		0.4
					16	0.8
Ø9	1.7	5.0	164	14		0.4
					18	0.7
Ø10	1.7	5.0	169	16		0.5
					20	0.8
Ø11	1.3	5.0	212	18		0.4
					22	0.7
Ø12	1.3	5.0	220	20		0.5
					24	0.7
Ø13	1.1	5.0	249	22		0.5
					26	0.7
Ø14	1.0	5.0	273	24		0.5
					28	0.7
Ø16	0.9	5	302	28		0.5
					32	0.7
Ø20	0.7	5	382	36		0.6
					40	0.7

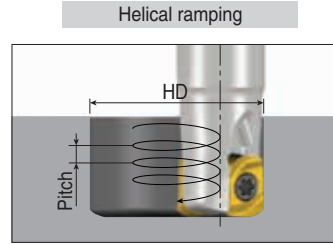
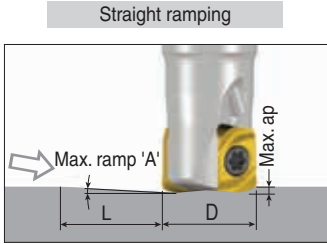

CVKT 05-HF

(unit: mm)

Cutter dia.(D)	Straight ramp down			Helical ramp down		
	Max. ramp (A°)	Max. ap	Min. length (L)	Min. dia.(HD)	Max. dia.(HD)	Max. pitch/rev.
Ø6	0.20	0.5	143	8		0.0
					12	0.1
Ø8	0.45	0.5	64	12		0.1
					16	0.2
Ø9	0.55	0.5	52	14		0.1
					18	0.2
Ø10	0.30	0.5	96	16		0.1
					20	0.1
Ø11	0.35	0.5	82	18		0.1
					22	0.2
Ø12	0.70	0.5	41	20		0.3
					24	0.4
Ø13	0.75	0.5	38	22		0.3
					26	0.5
Ø14	0.85	0.5	34	24		0.4
					28	0.5
Ø16	0.65	0.5	44	28		0.4
					32	0.5
Ø20	0.50	0.5	57	36		0.4
					40	0.5

Programming technical data

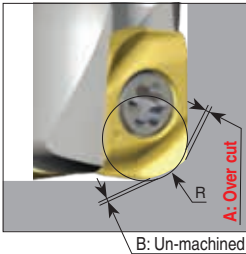

	R Program	A Over cut	B Un-machined
CVKT 05-HF	0.8	0	0.21
	0.9	0	0.18
	1.0	0.02	0.14

Yellow background: Recommended program 'R'

Ramping Data

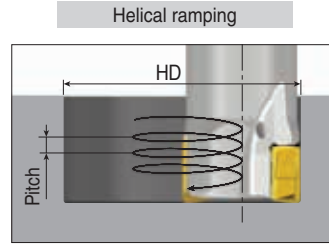
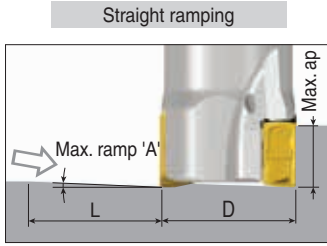

LPK(H)U 05

(unit: mm)

Cutter dia.(D)	Straight ramp down			Helical ramp down		
	Max. ramp (A°)	Max. ap	Min. length (L)	Min. dia.(HD)	Max. dia.(HD)	Max. pitch/rev.
Ø10	1.8	4.6	142	16.8		0.6
					20	0.9
Ø11	1.6	4.6	160	18.8		0.6
					22	0.8
Ø12	1.5	4.6	176	20.8		0.6
					24	0.8
Ø13	1.3	4.6	195	22.8		0.6
					26	0.8
Ø16	1.0	4.6	251	28.8		0.6
					32	0.8
Ø20	0.8	4.6	330	36.8		0.6
					40	0.7
Ø25	0.6	4.6	439	46.8		0.6
					50	0.7
Ø32	0.4	4.6	586	60.8		0.6
					64	0.7

LPK(H)U 09

(unit: mm)

Cutter dia.(D)	Straight ramp down			Helical ramp down		
	Max. ramp (A°)	Max. ap	Min. length (L)	Min. dia.(HD)	Max. dia.(HD)	Max. pitch/rev.
Ø20	1.4	8.3	328	33		1.0
					40	1.5
Ø25	1.1	8.3	432	43		1.0
					50	1.5
Ø32	0.8	8.3	594	57		1.1
					64	1.4
Ø40	0.6	8.3	793	73		1.0
					80	1.3
Ø50	0.4	8.3	1057	93		1.0
					100	1.2
Ø63	0.3	8.3	1359	119		1.0
					126	1.2

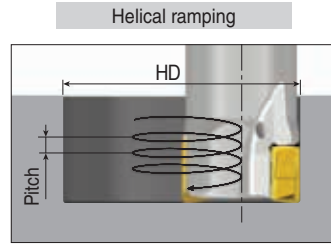
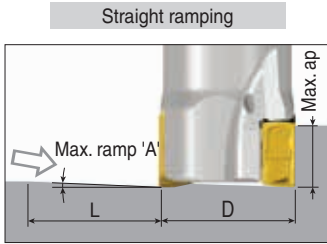

LPKU 14

(unit: mm)

Cutter dia.(D)	Straight ramp down			Helical ramp down		
	Max. ramp (A°)	Max. ap	Min. length (L)	Min. dia.(HD)	Max. dia.(HD)	Max. pitch/rev.
Ø40	0.9	12.5	754	69		1.5
					80	2.0
Ø50	0.7	12.5	1023	89		1.5
					100	1.9
Ø63	0.5	12.5	1302	115		1.5
					126	1.9
Ø80	0.4	12.5	1790	149		1.5
					160	1.7
Ø100	0.3	12.5	2387	189		1.4
					200	1.6
Ø125	0.2	12.5	2865	239		1.5
					250	1.7
Ø160	0.2	12.5	3581	309		1.6
					320	1.7
Ø200	0.1	12.5	4775	389		1.5
					400	1.6

Ramping Data

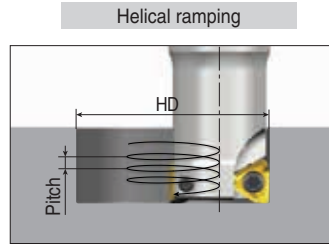
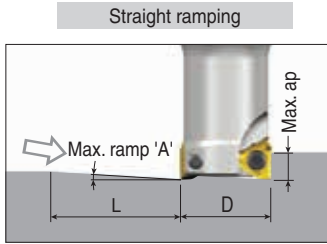

3PKT 04

(unit: mm)

Cutter dia.(D)	Straight ramp down			Helical ramp down		
	Max. ramp (A°)	Max. ap	Min. length (L)	Min. dia.(HD)	Max. dia.(HD)	Max. pitch/rev.
Ø8	2.1	3.5	95	13.2		0.6
					16	0.9
Ø10	2.2	3.5	91	17.2		0.8
					20	1.2
Ø11	3.6	3.5	56	19.2		1.6
					22	2.1
Ø12	3.3	3.5	61	21.2		1.6
					24	2.1
Ø13	2.5	3.5	80	23.2		1.4
					26	1.7
Ø14	2.2	3.5	91	25.2		1.3
					28	1.6
Ø16	1.6	3.5	125	29.2		1.1
					32	1.4

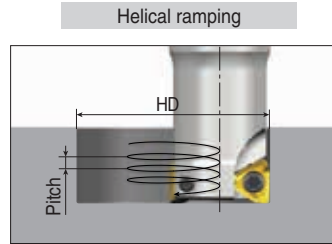
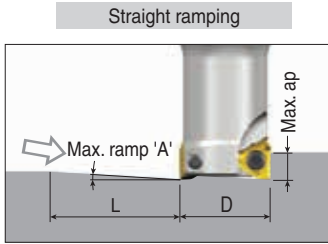

3PK(H)T 06

(unit: mm)

Cutter dia.(D)	Straight ramp down			Helical ramp down		
	Max. ramp (A°)	Max. ap	Min. length (L)	Min. dia.(HD)	Max. dia.(HD)	Max. pitch/rev.
Ø12	3.7	4.7	73	19.5	24	1.3
						2.1
Ø14	2.8	4.7	96	23.5	28	1.2
						1.8
Ø16	2.3	4.7	117	27.5	32	1.2
						1.7
Ø17	2.0	4.7	135	29.5	34	1.2
						1.6
Ø18	2.0	4.7	135	31.5	36	1.3
						1.7
Ø20	1.6	4.7	168	35.5	40	1.2
						1.5
Ø21	1.5	4.7	180	37.5	42	1.2
						1.5
Ø22	1.5	4.7	180	39.5	44	1.2
						1.5
Ø25	1.5	4.7	180	45.5	50	1.4
						1.7
Ø30	1.2	4.7	224	55.5	60	1.4
						1.7
Ø32	1.2	4.7	224	59.5	64	1.5
						1.8
Ø35	1.0	4.7	269	65.5	70	1.4
						1.6
Ø40	0.7	4.7	385	75.5	80	1.2
						1.3

3PK(H)T 10

(unit: mm)

Cutter dia.(D)	Straight ramp down			Helical ramp down		
	Max. ramp (A°)	Max. ap	Min. length (L)	Min. dia.(HD)	Max. dia.(HD)	Max. pitch/rev.
Ø16	7.0	7.0	57	24.7	32	2.8
						5.2
Ø20	3.3	7.0	121	33.9	40	2.1
						3.1
Ø21	3.2	7.0	125	35.9	42	2.2
						3.1
Ø22	3.2	7.0	125	37.9	44	2.4
						3.3
Ø25	2.8	7.0	143	43.5	50	2.4
						3.3
Ø26	2.6	7.0	154	45.9	52	2.4
						3.1
Ø30	2.0	7.0	201	53.9	60	2.2
						2.8
Ø32	1.8	7.0	223	57.5	64	2.1
						2.7
Ø33	1.7	7.0	236	59.9	66	2.1
						2.6
Ø40	1.3	7.0	309	73.7	80	2.0
						2.4
Ø50	1.0	7.0	401	93.7	100	2.0
						2.3
Ø63	0.8	7.0	502	119.7		2.1
						2.3

Ramping Data

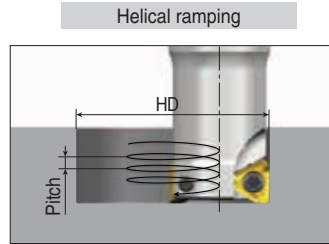
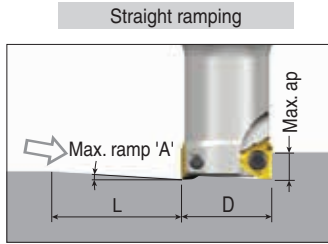

3PK(H)T 15

(unit: mm)

Cutter dia.(D)	Straight ramp down			Helical ramp down		
	Max. ramp (A°)	Max. ap	Min. length (L)	Min. dia.(HD)	Max. dia.(HD)	Max. pitch/rev.
Ø32	3.2	11.0	197	53.5	64	3.2
						4.8
Ø33	3.1	11.0	203	55.5	66	3.3
						4.8
Ø35	3.1	11.0	203	59.5	70	3.5
						5.1
Ø40	2.0	11.0	315	70.1	80	2.8
						3.7
Ø50	1.5	11.0	420	90.1	100	2.8
						3.5
Ø63	1.1	11.0	573	116.1	126	2.7
						3.2
Ø80	0.8	11.0	788	150.3	160	2.6
						3.0
Ø100	0.6	11.0	1051	190.5	200	2.5
						2.8
Ø125	0.5	11.0	1261	240.3	250	2.7
						2.9
Ø160	0.3	11.0	2102	310.3	320	2.1
						2.2
Ø200	0.2	11.0	3153	390.3	400	1.8
						1.9

3PK(H)T 19

(unit: mm)

Cutter dia.(D)	Straight ramp down			Helical ramp down		
	Max. ramp (A°)	Max. ap	Min. length (L)	Min. dia.(HD)	Max. dia.(HD)	Max. pitch/rev.
Ø40	3.6	15.0	239	66.7	80	4.5
						6.7
Ø50	2.2	15.0	391	87.9	100	3.9
						5.1
Ø63	1.7	15.0	506	113.9	126	4
						5
Ø80	1.3	15.0	661	147.9	160	4.1
						4.8
Ø100	1.0	15.0	860	187.9	200	4.1
						4.7
Ø125	0.8	15.0	1075	237.9	250	4.2
						4.7
Ø160	0.6	15.0	1433	307.9	320	4.1
						4.5
Ø200	0.4	15.0	2150	387.9	400	3.5
						3.7
Ø250	0.3	15.0	2866	487.9	500	3.3
						3.5

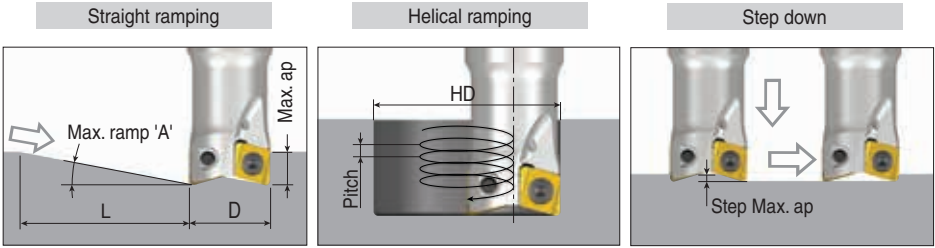

4NKT 04: R0.2

(unit: mm)

Cutter dia.(D)	Straight ramp down			Helical ramp down			Step down
	Max. ramp (A°)	Max. ap	Min. length (L)	Min. dia.(HD)	Max. dia.(HD)	Max. pitch/rev.	Max. ap
Ø8	4.2	3.5	48	9.9	16	0.4	0.4
						3.1	
Ø10	4.6	3.5	44	13.9	20	0.8	0.6
						2.1	
Ø11	5.2	3.5	38	15.9	22	1.2	0.7
						2.7	
Ø12	4.8	3.5	42	17.9	24	1.3	0.8
						2.7	
Ø13	5.1	3.5	39	19.9	26	1.6	0.8
						3.1	
Ø16	4.4	3.5	46	25.9	32	2.0	1.0
						3.3	
Ø20	3.3	3.5	61	33.9	40	2.1	1.0
						3.1	
Ø25	2.5	3.5	80	43.9	50	2.2	1.0
						2.9	
Ø32	1.9	3.5	106	57.9	64	2.3	1.0
						2.8	
Ø40	1.4	3.5	138	73.9	80	2.3	1.0
						2.7	

4NKT 04: R0.4

(unit: mm)

Cutter dia.(D)	Straight ramp down			Helical ramp down			Step down
	Max. ramp (A°)	Max. ap	Min. length (L)	Min. dia.(HD)	Max. dia.(HD)	Max. pitch/rev.	Max. ap
Ø8	3.7	3.5	54	9.9	16	0.3	0.4
						2.8	
Ø10	4.2	3.5	48	13.9	20	0.8	0.5
						2.0	
Ø11	4.8	3.5	42	15.9	22	1.1	0.6
						2.5	
Ø12	4.5	3.5	44	17.9	24	1.2	0.7
						2.5	
Ø13	4.7	3.5	43	19.9	26	1.5	0.8
						2.9	
Ø16	4.1	3.5	49	25.9	32	1.9	0.9
						3.1	
Ø20	3.1	3.5	65	33.9	40	2.0	0.9
						2.9	
Ø25	2.3	3.5	85	43.9	50	2.1	0.9
						2.7	
Ø32	1.7	3.5	115	57.9	64	2.1	0.9
						2.6	
Ø40	1.3	3.5	149	73.9	80	2.1	0.9
						2.5	

Ramping Data

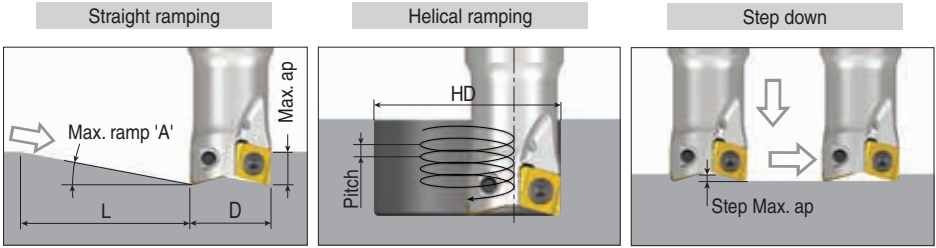

4NKT 04: R0.8

(unit: mm)

Cutter dia.(D)	Straight ramp down			Helical ramp down			Step down
	Max. ramp (A°)	Max. ap	Min. length (L)	Min. dia.(HD)	Max. dia.(HD)	Max. pitch/rev.	Max. ap
Ø8	2.2	3.5	91	9.9		0.2	0.2
					16	1.6	
Ø10	3.0	3.5	67	13.9		0.5	0.4
					20	1.4	
Ø11	3.7	3.5	54	15.9		0.8	0.5
					22	1.9	
Ø12	3.5	3.5	57	17.9		1.0	0.5
					24	2.0	
Ø13	3.9	3.5	51	19.9		1.3	0.6
					26	2.4	
Ø16	3.5	3.5	57	25.9		1.6	0.7
					32	2.6	
Ø20	2.6	3.5	77	33.9		1.7	0.7
					40	2.4	
Ø25	1.9	3.5	103	43.9		1.7	0.7
					50	2.3	
Ø32	1.5	3.5	134	57.9		1.8	0.7
					64	2.2	
Ø40	1.1	3.5	174	73.9		1.8	0.7
					80	2.1	

Ramping Data

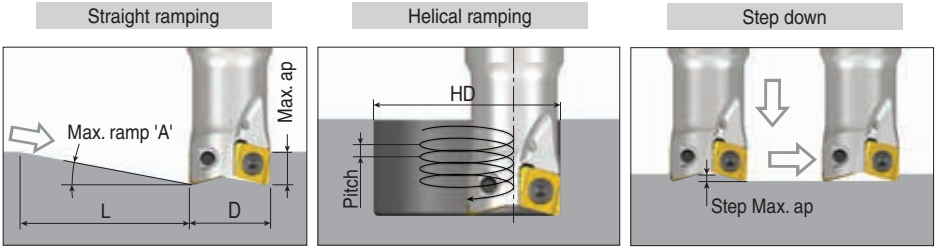

4NKT 06: R0.4

(unit: mm)

Cutter dia.(D)	Straight ramp down			Helical ramp down			Step down
	Max. ramp (A°)	Max. ap	Min. length (L)	Min. dia.(HD)	Max. dia.(HD)	Max. pitch/rev.	Max. ap
Ø16	4.3	6.0	80	21.5		1.1	0.9
					32	3.2	
Ø17	4.3	6.0	80	23.5		1.3	1.0
					34	3.4	
Ø18	4.7	6.0	73	25.5		1.6	1.1
					36	3.9	
Ø20	4.9	6.0	70	29.5		2.2	1.3
					40	4.6	
Ø21	5.0	6.0	69	31.5		2.5	1.4
					42	4.9	
Ø25	4.9	6.0	70	39.5		3.3	1.6
					50	5.7	
Ø26	4.6	6.0	75	41.5		3.3	1.6
					52	5.6	
Ø32	3.5	6.0	98	53.5		3.5	1.7
					64	5.2	
Ø33	3.4	6.0	101	55.5		3.6	1.7
					66	5.2	
Ø35	3.1	6.0	111	59.5		3.5	1.7
					70	5.1	
Ø36	3.0	6.0	115	61.5		3.6	1.7
					72	5.0	
Ø38	2.8	6.0	123	65.5		3.6	1.7
					76	5.0	
Ø40	2.6	6.0	130	69.5		3.6	1.7
					80	4.9	
Ø43	2.4	6.0	143	75.5		3.6	1.7
					86	4.8	
Ø50	2.0	6.0	168	89.5		3.8	1.7
					100	4.8	
Ø63	1.6	6.0	215	115.5		3.9	1.7
					126	4.7	

Ramping Data

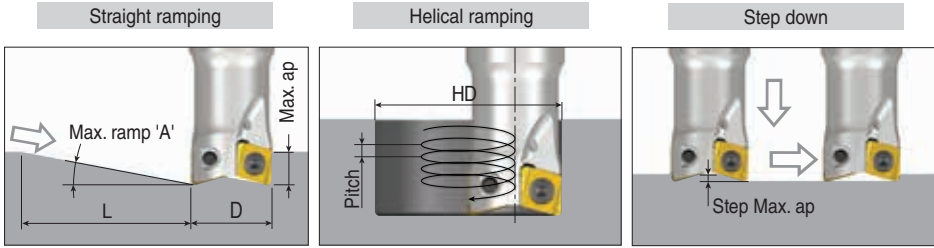

4NKT 06: R0.8

(unit: mm)

Cutter dia.(D)	Straight ramp down			Helical ramp down			Step down
	Max. ramp (A°)	Max. ap	Min. length (L)	Min. dia.(HD)	Max. dia.(HD)	Max. pitch/rev.	Max. ap
Ø16	3.7	6.0	93	21.5	0.9	0.8	
				32	2.8		
Ø17	3.8	6.0	90	23.5	1.2	0.8	
				34	3.0		
Ø18	4.2	6.0	82	25.5	1.5	1.0	
				36	3.5		
Ø20	4.4	6.0	78	29.5	2.0	1.1	
				40	4.1		
Ø21	4.6	6.0	75	31.5	2.3	1.2	
				42	4.5		
Ø25	4.6	6.0	75	39.5	3.1	1.5	
				50	5.4		
Ø26	4.3	6.0	80	41.5	3.1	1.5	
				52	5.2		
Ø32	3.2	6.0	107	53.5	3.2	1.5	
				64	4.8		
Ø33	3.1	6.0	111	55.5	3.3	1.5	
				66	4.8		
Ø35	2.8	6.0	121	59.5	3.3	1.5	
				70	4.6		
Ø36	2.7	6.0	125	61.5	3.3	1.5	
				72	4.6		
Ø38	2.5	6.0	135	65.5	3.3	1.5	
				76	4.5		
Ø40	2.4	6.0	140	69.5	3.4	1.5	
				80	4.6		
Ø43	2.2	6.0	153	75.5	3.4	1.5	
				86	4.5		
Ø50	1.9	6.0	181	89.5	3.5	1.5	
				100	4.4		
Ø63	1.4	6.0	237	115.5	3.5	1.6	
				126	4.3		

Straight ramping

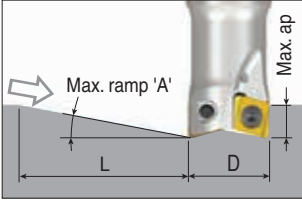

Helical ramping

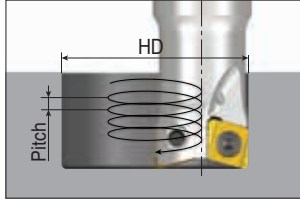

Step down

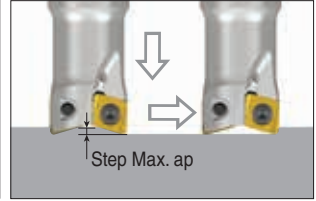

4NKT 06: R1.2

(unit: mm)

Cutter dia.(D)	Straight ramp down			Helical ramp down			Step down
	Max. ramp (A°)	Max. ap	Min. length (L)	Min. dia.(HD)	Max. dia.(HD)	Max. pitch/rev.	Max. ap
Ø16	3.0	6.0	115	21.5		0.8	0.5
					32	2.2	
Ø17	3.2	6.0	107	23.5		1.0	0.7
					34	2.5	
Ø18	3.6	6.0	95	25.5		1.3	0.8
					36	3.0	
Ø20	3.9	6.0	88	29.5		1.7	1.0
					40	3.6	
Ø21	4.1	6.0	84	31.5		2.0	1.1
					42	4.0	
Ø25	4.2	6.0	82	39.5		2.8	1.3
					50	4.9	
Ø26	3.9	6.0	88	41.5		2.8	1.3
					52	4.7	
Ø32	2.9	6.0	119	53.5		2.9	1.4
					64	4.3	
Ø33	2.8	6.0	123	55.5		2.9	1.4
					66	4.3	
Ø35	2.6	6.0	132	59.5		3.0	1.4
					70	4.2	
Ø36	2.5	6.0	137	61.5		3.0	1.4
					72	4.2	
Ø38	2.3	6.0	146	65.5		3.0	1.4
					76	4.2	
Ø40	2.2	6.0	156	69.5		3.0	1.4
					80	4.1	
Ø43	2.0	6.0	168	75.5		3.1	1.4
					86	4.1	
Ø50	1.7	6.0	202	89.5		3.1	1.4
					100	4.0	
Ø63	1.3	6.0	265	115.5		3.2	1.4
					126	3.8	

Ramping Data

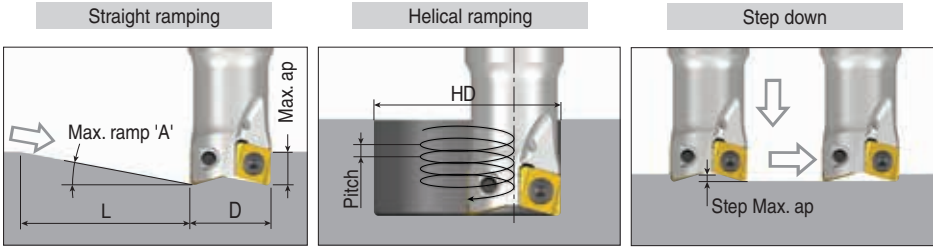

4NKT 06: R1.6

(unit: mm)

Cutter dia.(D)	Straight ramp down			Helical ramp down			Step down
	Max. ramp (A°)	Max. ap	Min. length (L)	Min. dia.(HD)	Max. dia.(HD)	Max. pitch/rev.	Max. ap
Ø16	2.2	6.0	156	21.5		0.6	0.4
					32	1.6	
Ø17	2.4	6.0	143	23.5		0.7	0.5
					34	1.9	
Ø18	2.8	6.0	123	25.5		1.0	0.6
					36	2.3	
Ø20	3.2	6.0	107	29.5		1.4	0.8
					40	3.0	
Ø21	3.4	6.0	101	31.5		1.7	0.9
					42	3.3	
Ø25	3.7	6.0	93	39.5		2.5	1.1
					50	4.3	
Ø26	3.4	6.0	101	41.5		2.5	1.1
					52	4.1	
Ø32	2.5	6.0	135	53.5		2.6	1.2
					64	3.8	
Ø33	2.4	6.0	140	55.5		2.6	1.2
					66	3.8	
Ø35	2.3	6.0	149	59.5		2.6	1.2
					70	3.8	
Ø36	2.2	6.0	156	61.5		2.6	1.2
					72	3.7	
Ø38	2.0	6.0	168	65.5		2.6	1.2
					76	3.6	
Ø40	1.9	6.0	176	69.5		2.7	1.2
					80	3.6	
Ø43	1.8	6.0	191	75.5		2.7	1.2
					86	3.6	
Ø50	1.5	6.0	229	89.5		2.8	1.2
					100	3.5	
Ø63	1.1	6.0	299	115.5		2.8	1.2
					126	3.4	

Ramping Data

Straight ramping

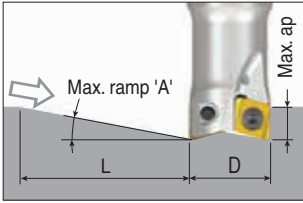

Helical ramping

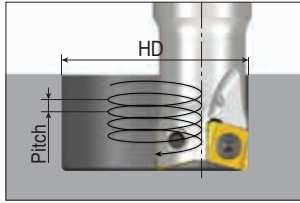

Step down

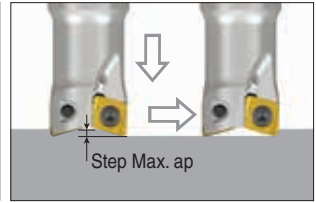

4NKT 06: R2.0

(unit: mm)

Cutter dia.(D)	Straight ramp down			Helical ramp down			Step down
	Max. ramp (A°)	Max. ap	Min. length (L)	Min. dia.(HD)	Max. dia.(HD)	Max. pitch/rev.	Max. ap
Ø16	1.6	6.0	215	21.5		0.4	0.3
					32	1.2	
Ø17	1.8	6.0	191	23.5		0.5	0.3
					34	1.4	
Ø18	2.3	6.0	149	25.5		0.8	0.5
					36	1.9	
Ø20	2.7	6.0	125	29.5		1.2	0.6
					40	2.6	
Ø21	3.0	6.0	115	31.5		1.5	0.7
					42	2.9	
Ø25	3.3	6.0	104	39.5		2.2	1.0
					50	3.8	
Ø26	3.1	6.0	111	41.5		2.2	1.0
					52	3.8	
Ø32	2.3	6.0	149	53.5		2.3	1.0
					64	3.4	
Ø33	2.2	6.0	156	55.5		2.3	1.0
					66	3.4	
Ø35	2.0	6.0	168	59.5		2.3	1.0
					70	3.3	
Ø36	2.0	6.0	172	61.5		2.4	1.0
					72	3.4	
Ø38	1.8	6.0	186	65.5		2.4	1.0
					76	3.3	
Ø40	1.7	6.0	196	69.5		2.4	1.0
					80	3.3	
Ø43	1.3	6.0	265	75.5		2.0	1.0
					86	2.6	
Ø50	1.3	6.0	255	89.5		2.5	1.0
					100	3.1	
Ø63	1.0	6.0	328	115.5		2.6	1.0
					126	3.1	

Ramping Data

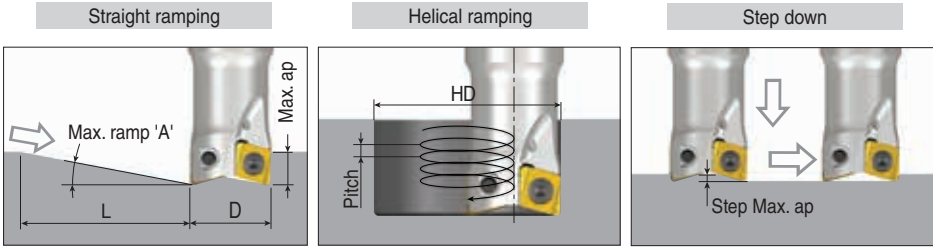

4NHT 04: R0.5-F

(unit: mm)

Cutter dia.(D)	Straight ramp down			Helical ramp down			Step down
	Max. ramp (A°)	Max. ap	Min. length (L)	Min. dia.(HD)	Max. dia.(HD)	Max. pitch/rev.	Max. ap
Ø8	3.4	2.2	37	9.9	16	0.3	0.3
						1.3	
Ø10	4.0	2.2	31	13.9	20	0.7	0.5
						1.9	
Ø11	4.6	2.2	27	15.9	22	1.1	0.6
						2.4	
Ø12	4.3	2.2	29	17.9	24	1.2	0.7
						2.4	
Ø13	4.6	2.2	27	19.9	26	1.5	0.8
						2.8	
Ø16	3.9	2.2	32	25.9	32	1.8	0.9
						2.9	
Ø20	2.9	2.2	43	33.9	40	1.9	0.9
						2.7	
Ø25	2.2	2.2	57	43.9	50	1.9	0.9
						2.6	
Ø32	1.6	2.2	76	57.9	64	2.0	0.9
						2.5	
Ø40	1.3	2.2	97	73.9	80	2.1	0.9
						2.4	

4NHT 04: R1.0-F

(unit: mm)

Cutter dia.(D)	Straight ramp down			Helical ramp down			Step down
	Max. ramp (A°)	Max. ap	Min. length (L)	Min. dia.(HD)	Max. dia.(HD)	Max. pitch/rev.	Max. ap
Ø8	1.5	2.0	74	9.9	16	0.1	0.1
						0.6	
Ø10	2.5	2.0	45	13.9	20	0.5	0.3
						1.2	
Ø11	3.3	2.0	35	15.9	22	0.8	0.4
						1.7	
Ø12	3.1	2.0	37	17.9	24	0.9	0.5
						1.7	
Ø13	3.5	2.0	33	19.9	26	1.1	0.5
						2.1	
Ø16	3.0	2.0	38	25.9	32	1.4	0.6
						2.2	
Ø20	2.2	2.0	51	33.9	40	1.5	0.7
						2.1	
Ø25	1.7	2.0	65	43.9	50	1.5	0.7
						2.0	
Ø32	1.3	2.0	88	57.9	64	1.6	0.7
						1.9	
Ø40	1.0	2.0	115	73.9	80	1.6	0.7
						1.9	

Ramping Data

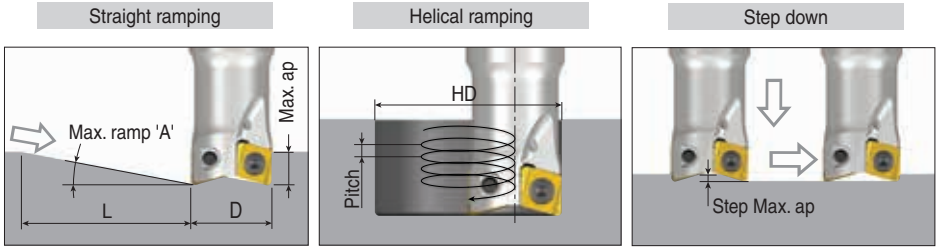

4NHT 06: R0.4

(unit: mm)

Cutter dia.(D)	Straight ramp down			Helical ramp down			Step down
	Max. ramp (A°)	Max. ap	Min. length (L)	Min. dia.(HD)	Max. dia.(HD)	Max. pitch/rev.	Max. ap
Ø16	2.9	6.0	119	21.5	32	0.7	0.6
						2.2	
Ø17	3.0	6.0	115	23.5	34	0.9	0.6
						2.4	
Ø18	3.4	6.0	101	25.5	36	1.2	0.8
						2.9	
Ø20	3.8	6.0	90	29.5	40	1.7	0.9
						3.5	
Ø21	4.0	6.0	86	31.5	42	2.0	1.0
						3.9	
Ø25	4.1	6.0	84	39.5	50	2.8	1.3
						4.8	
Ø26	3.8	6.0	90	41.5	52	2.7	1.3
						4.6	
Ø32	2.8	6.0	123	53.5	64	2.8	1.3
						4.2	
Ø33	2.7	6.0	127	55.5	66	2.8	1.3
						4.2	
Ø35	2.5	6.0	135	59.5	70	2.9	1.3
						4.2	
Ø36	2.4	6.0	140	61.5	72	2.9	1.3
						4.1	
Ø38	2.3	6.0	149	65.5	76	2.9	1.3
						4.1	
Ø40	2.1	6.0	160	69.5	80	3.0	1.3
						4.0	
Ø43	1.9	6.0	176	75.5	86	3.0	1.3
						3.9	
Ø50	1.6	6.0	208	89.5	100	3.0	1.3
						3.8	
Ø63	1.2	6.0	275	115.5	126	3.1	1.3
						3.7	

Ramping Data

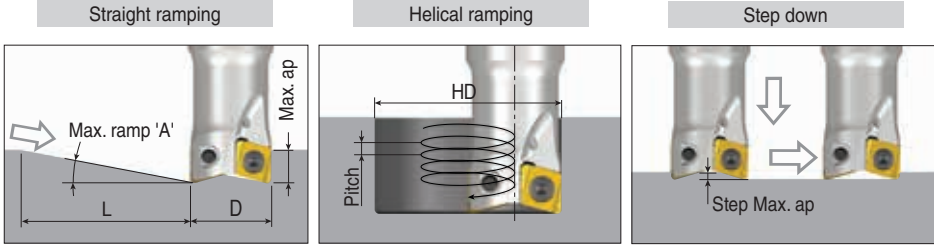

4NHT 06: R0.8

(unit: mm)

Cutter dia.(D)	Straight ramp down			Helical ramp down			Step down
	Max. ramp (A°)	Max. ap	Min. length (L)	Min. dia.(HD)	Max. dia.(HD)	Max. pitch/rev.	Max. ap
Ø16	2.9	6.0	119	21.5		0.7	0.6
					32	2.2	
Ø17	3.0	6.0	115	23.5		0.9	0.6
					34	2.4	
Ø18	3.5	6.0	98	25.5		1.2	0.8
					36	2.9	
Ø20	3.8	6.0	90	29.5		1.7	0.9
					40	3.5	
Ø21	4.0	6.0	86	31.5		2.0	1.0
					42	3.9	
Ø25	4.1	6.0	84	39.5		2.8	1.3
					50	4.8	
Ø26	3.8	6.0	90	41.5		2.7	1.3
					52	4.6	
Ø32	2.8	6.0	123	53.5		2.8	1.3
					64	4.2	
Ø33	2.7	6.0	127	55.5		2.8	1.3
					66	4.2	
Ø35	2.5	6.0	135	59.5		2.9	1.3
					70	4.2	
Ø36	2.4	6.0	140	61.5		2.9	1.3
					72	4.1	
Ø38	2.3	6.0	149	65.5		2.9	1.3
					76	4.1	
Ø40	2.1	6.0	160	69.5		3.0	1.3
					80	4.0	
Ø43	1.9	6.0	176	75.5		3.0	1.3
					86	3.9	
Ø50	1.6	6.0	208	89.5		3.0	1.3
					100	3.8	
Ø63	1.25	6.0	275	115.5		3.1	1.3
					126	3.7	

Ramping Data

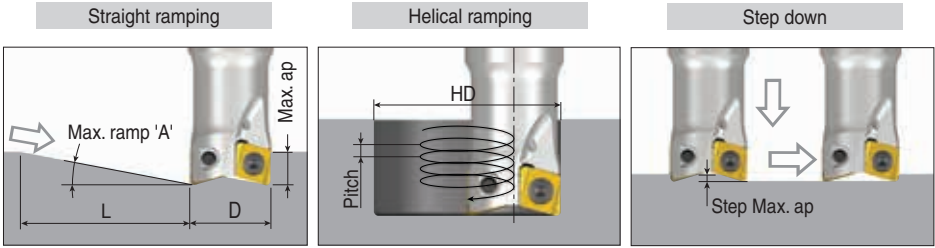

4NHT 06: R0.5-F

(unit: mm)

Cutter dia.(D)	Straight ramp down			Helical ramp down			Step down
	Max. ramp (A°)	Max. ap	Min. length (L)	Min. dia.(HD)	Max. dia.(HD)	Max. pitch/rev.	Max. ap
Ø16	3.5	2.3	38	21.5		0.9	0.8
					32	2.6	
Ø17	3.6	2.3	37	23.5		1.1	0.8
					34	2.9	
Ø18	4.0	2.3	33	25.5		1.4	1.0
					36	3.4	
Ø20	4.3	2.3	31	29.5		1.9	1.2
					40	4.0	
Ø21	4.4	2.3	30	31.5		2.2	1.2
					42	4.3	
Ø25	4.9	2.3	27	39.5		3.3	1.6
					50	5.7	
Ø26	4.6	2.3	29	41.5		3.3	1.6
					52	5.6	
Ø32	3.5	2.3	38	53.5		3.5	1.6
					64	5.2	
Ø33	3.3	2.3	40	55.5		3.5	1.6
					66	5.1	
Ø35	3.1	2.3	42	59.5		3.5	1.6
					70	5.1	
Ø36	3.0	2.3	44	61.5		3.6	1.6
					72	5.0	
Ø38	2.8	2.3	47	65.5		3.6	1.7
					76	5.0	
Ø40	2.6	2.3	51	69.5		3.6	1.7
					80	4.8	
Ø43	2.4	2.3	55	75.5		3.6	1.7
					86	4.8	
Ø50	2.0	2.3	64	89.5		3.8	1.7
					100	4.8	
Ø63	1.7	2.3	78	115.5		4.2	1.7
					126	5.0	

Ramping Data

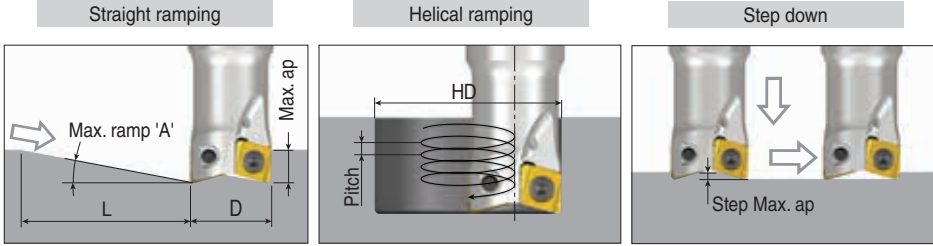

4NHT 06: R0.8-F

(unit: mm)

Cutter dia.(D)	Straight ramp down			Helical ramp down			Step down
	Max. ramp (A°)	Max. ap	Min. length (L)	Min. dia.(HD)	Max. dia.(HD)	Max. pitch/rev.	Max. ap
Ø16	3.1	1.9	35	21.5		0.8	0.7
					32	2.3	
Ø17	3.2	1.9	34	23.5		1.0	0.7
					34	2.5	
Ø18	3.6	1.9	30	25.5		1.3	0.9
					36	3.0	
Ø20	3.9	1.9	28	29.5		1.7	1.0
					40	3.6	
Ø21	4.1	1.9	27	31.5		2.0	1.1
					42	4.0	
Ø25	4.6	1.9	24	39.5		3.1	1.5
					50	5.4	
Ø26	4.4	1.9	25	41.5		3.2	1.5
					52	5.3	
Ø32	3.3	1.9	33	53.5		3.3	1.5
					64	4.9	
Ø33	3.1	1.9	35	55.5		3.3	1.5
					66	4.8	
Ø35	2.9	1.9	38	59.5		3.3	1.5
					70	4.7	
Ø36	2.8	1.9	39	61.5		3.3	1.5
					72	4.7	
Ø38	2.6	1.9	41	65.5		3.4	1.5
					76	4.7	
Ø40	2.4	1.9	44	69.5		3.4	1.5
					80	4.6	
Ø43	2.2	1.9	48	75.5		3.4	1.5
					86	4.5	
Ø50	1.9	1.9	57	89.5		3.5	1.6
					100	4.4	
Ø63	1.4	1.9	75	115.5		3.5	1.6
					126	4.3	

Ramping Data

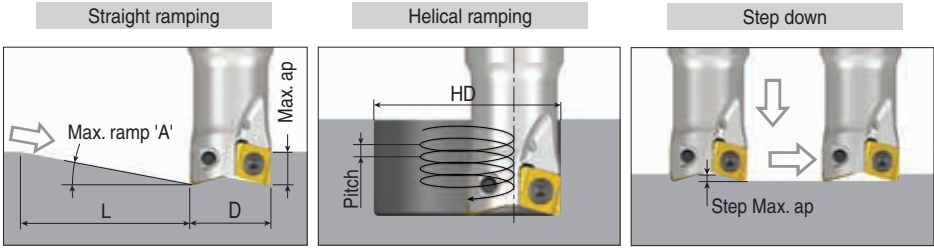

4NHT 06: R1.0-F

(unit: mm)

Cutter dia.(D)	Straight ramp down			Helical ramp down			Step down
	Max. ramp (A°)	Max. ap	Min. length (L)	Min. dia.(HD)	Max. dia.(HD)	Max. pitch/rev.	Max. ap
Ø16	2.7	2.1	44	21.5	32	0.7	0.6
						2.1	
Ø17	2.9	2.1	41	23.5	34	0.9	0.7
						2.3	
Ø18	3.3	2.1	36	25.5	36	1.2	0.8
						2.8	
Ø20	3.6	2.1	33	29.5	40	1.6	1.0
						3.4	
Ø21	3.8	2.1	32	31.5	42	1.9	1.0
						3.7	
Ø25	4.4	2.1	27	39.5	50	3.0	1.4
						5.1	
Ø26	4.2	2.1	29	41.5	52	3.0	1.4
						5.1	
Ø32	3.1	2.1	39	53.5	64	3.1	1.4
						4.6	
Ø33	3.0	2.1	40	55.5	66	3.1	1.4
						4.6	
Ø35	2.8	2.1	43	59.5	70	3.2	1.4
						4.6	
Ø36	2.6	2.1	45	61.5	72	3.1	1.4
						4.4	
Ø38	2.5	2.1	48	65.5	76	3.2	1.5
						4.4	
Ø40	2.3	2.1	51	69.5	80	3.2	1.5
						4.4	
Ø43	2.1	2.1	56	75.5	86	3.3	1.5
						4.3	
Ø50	1.8	2.1	67	89.5	100	3.3	1.5
						4.2	
Ø63	1.4	2.1	86	115.5	126	3.4	1.5
						4.1	

Ramping Data

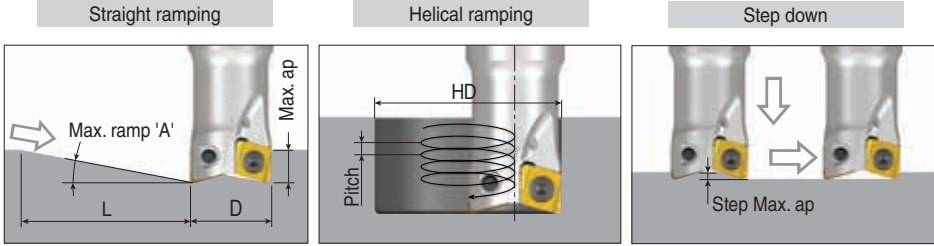

4NHT 06: R1.5-F

(unit: mm)

Cutter dia.(D)	Straight ramp down			Helical ramp down			Step down
	Max. ramp (A°)	Max. ap	Min. length (L)	Min. dia.(HD)	Max. dia.(HD)	Max. pitch/rev.	Max. ap
Ø16	1.9	3.3	97	21.5		0.5	0.4
					32	1.5	
Ø17	2.1	3.3	88	23.5		0.7	0.5
					34	1.7	
Ø18	2.6	3.3	73	25.5		0.9	0.6
					36	2.2	
Ø20	3.0	3.3	63	29.5		1.3	0.8
					40	2.8	
Ø21	3.2	3.3	59	31.5		1.6	0.9
					42	3.1	
Ø25	3.9	3.3	48	39.5		2.6	1.2
					50	4.5	
Ø26	3.7	3.3	51	41.5		2.7	1.2
					52	4.5	
Ø32	2.7	3.3	70	53.5		2.7	1.2
					64	4.0	
Ø33	2.6	3.3	71	55.5		2.8	1.2
					66	4.1	
Ø35	2.4	3.3	77	59.5		2.8	1.3
					70	4.0	
Ø36	2.3	3.3	80	61.5		2.8	1.3
					72	3.9	
Ø38	2.2	3.3	86	65.5		2.8	1.3
					76	3.9	
Ø40	2.1	3.3	90	69.5		2.9	1.3
					80	3.9	
Ø43	1.9	3.3	100	75.5		2.9	1.3
					86	3.8	
Ø50	1.6	3.3	118	89.5		2.9	1.3
					100	3.7	
Ø63	1.2	3.3	151	115.5		3.1	1.3
					126	3.7	

Ramping Data

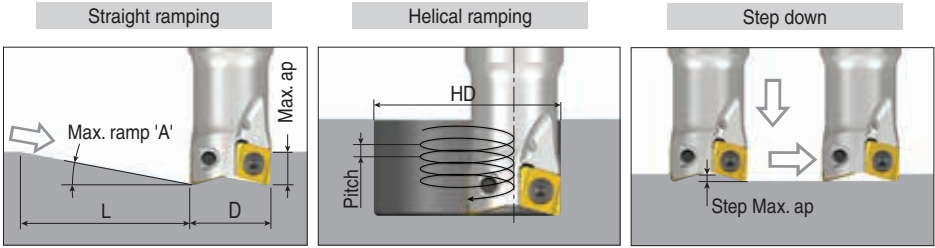

4NHT 06: R2.0-F

(unit: mm)

Cutter dia.(D)	Straight ramp down			Helical ramp down			Step down
	Max. ramp (A°)	Max. ap	Min. length (L)	Min. dia.(HD)	Max. dia.(HD)	Max. pitch/rev.	Max. ap
Ø16	0.8	2.1	142	21.5		0.2	0.1
					32	0.6	
Ø17	1.1	2.1	109	23.5		0.3	0.2
					34	0.9	
Ø18	1.6	2.1	75	25.5		0.6	0.3
					36	1.3	
Ø20	2.1	2.1	57	29.5		0.9	0.5
					40	2.0	
Ø21	2.3	2.1	51	31.5		1.1	0.6
					42	2.3	
Ø25	3.2	2.1	38	39.5		2.2	0.9
					50	3.7	
Ø26	3.0	2.1	40	41.5		2.2	1.0
					52	3.6	
Ø32	2.2	2.1	53	53.5		2.3	1.0
					64	3.4	
Ø33	2.1	2.1	56	55.5		2.3	1.0
					66	3.3	
Ø35	2.0	2.1	60	59.5		2.3	1.0
					70	3.3	
Ø36	1.9	2.1	62	61.5		2.3	1.0
					72	3.3	
Ø38	1.8	2.1	67	65.5		2.3	1.0
					76	3.2	
Ø40	1.7	2.1	71	69.5		2.3	1.0
					80	3.2	
Ø43	1.5	2.1	78	75.5		2.3	1.0
					86	3.1	
Ø50	1.3	2.1	93	89.5		2.4	1.0
					100	3.0	
Ø63	1.0	2.1	120	115.5		2.4	1.0
					126	2.9	

Ramping Data

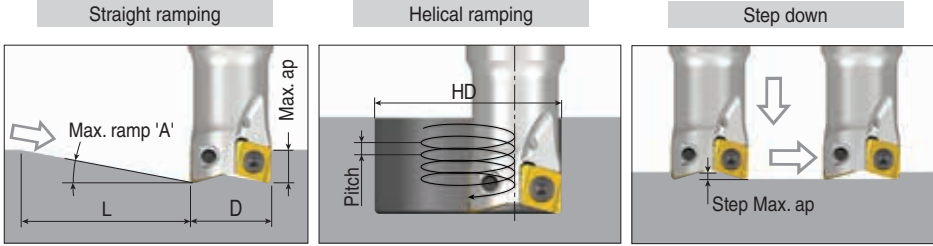

4NKT 09: R0.8

(unit: mm)

Cutter dia.(D)	Straight ramp down			Helical ramp down			Step down
	Max. ramp (A°)	Max. ap	Min. length (L)	Min. dia.(HD)	Max. dia.(HD)	Max. pitch/rev.	Max. ap
Ø20	3.7	8.0	124	25.5		0.9	1.0
					40	3.5	
Ø25	4.9	8.0	93	35.5		2.4	1.6
					50	5.7	
Ø32	4.9	8.0	93	49.5		4.0	2.1
					64	7.3	
Ø40	3.6	8.0	127	65.5		4.3	2.1
					80	6.7	
Ø50	2.7	8.0	170	85.5		4.5	2.1
					100	6.3	
Ø63	2.0	8.0	224	111.5		4.6	2.1
					126	6.0	
Ø80	1.5	8.0	296	145.5		4.7	2.1
					160	5.8	

4NKT 09: R1.6

(unit: mm)

Cutter dia.(D)	Straight ramp down			Helical ramp down			Step down
	Max. ramp (A°)	Max. ap	Min. length (L)	Min. dia.(HD)	Max. dia.(HD)	Max. pitch/rev.	Max. ap
Ø20	2.7	8.0	167	25.5		0.7	0.7
					40	2.6	
Ø25	4.1	8.0	112	35.5		2.0	1.3
					50	4.8	
Ø32	4.4	8.0	104	49.5		3.6	1.8
					64	6.6	
Ø40	3.1	8.0	148	65.5		3.7	1.8
					80	5.8	
Ø50	2.3	8.0	195	85.5		3.9	1.8
					100	5.5	
Ø63	1.8	8.0	255	111.5		4.1	1.8
					126	5.3	
Ø80	1.3	8.0	340	145.5		4.1	1.8
					160	5.0	

Ramping Data

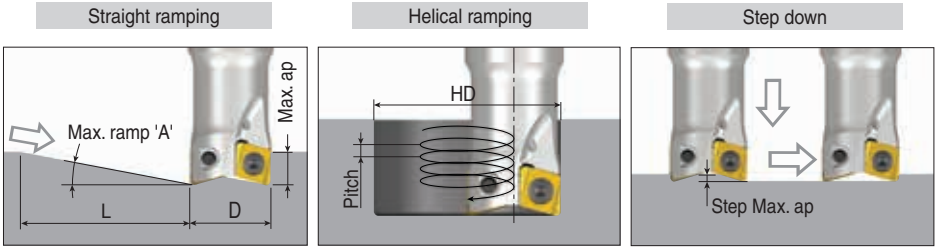

4NHT 09: R0.4

(unit: mm)

Cutter dia.(D)	Straight ramp down			Helical ramp down			Step down
	Max. ramp (A°)	Max. ap	Min. length (L)	Min. dia.(HD)	Max. dia.(HD)	Max. pitch/rev.	Max. ap
Ø20	2.9	8.0	155	25.5	40	0.8	0.8
						2.7	
Ø25	4.3	8.0	106	35.5	50	2.1	1.3
						5.0	
Ø32	4.5	8.0	102	49.5	64	3.7	1.8
						6.7	
Ø40	3.2	8.0	143	65.5	80	3.8	1.8
						6.0	
Ø50	2.4	8.0	191	85.5	100	4.0	1.8
						5.6	
Ø63	1.8	8.0	255	111.5	126	4.1	1.8
						5.3	
Ø80	1.3	8.0	340	145.5	160	4.1	1.8
						5.0	

4NHT 09: R0.8

(unit: mm)

Cutter dia.(D)	Straight ramp down			Helical ramp down			Step down
	Max. ramp (A°)	Max. ap	Min. length (L)	Min. dia.(HD)	Max. dia.(HD)	Max. pitch/rev.	Max. ap
Ø20	2.9	8.0	155	25.5	40	0.8	0.8
						2.7	
Ø25	4.3	8.0	106	35.5	50	2.1	1.3
						5.0	
Ø32	4.5	8.0	102	49.5	64	3.7	1.8
						6.7	
Ø40	3.2	8.0	143	65.5	80	3.8	1.8
						6.0	
Ø50	2.4	8.0	191	85.5	100	4.0	1.8
						5.6	
Ø63	1.8	8.0	255	111.5	126	4.1	1.8
						5.3	
Ø80	1.3	8.0	340	145.5	160	4.1	1.8
						5.0	

Ramping Data

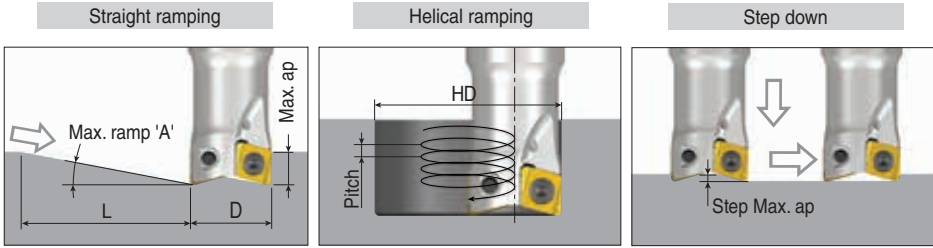

4NKT 11: R0.8

(unit: mm)

Cutter dia.(D)	Straight ramp down			Helical ramp down			Step down
	Max. ramp (A°)	Max. ap	Min. length (L)	Min. dia.(HD)	Max. dia.(HD)	Max. pitch/rev.	Max. ap
Ø25	5.1	10.3	115	31.5	1.5	1.7	
				50	6.0		
Ø32	5.3	10.3	111	45.5	3.3	2.4	
				64	7.9		
Ø40	5.0	10.3	118	61.5	5.0	2.7	
				80	9.3		
Ø50	3.7	10.3	159	81.5	5.4	2.7	
				100	8.6		
Ø63	2.7	10.3	219	107.5	5.6	2.7	
				126	7.9		
Ø80	2.0	10.3	288	141.5	5.9	2.7	
				160	7.6		

4NKT 14: R0.8

(unit: mm)

Cutter dia.(D)	Straight ramp down			Helical ramp down			Step down
	Max. ramp (A°)	Max. ap	Min. length (L)	Min. dia.(HD)	Max. dia.(HD)	Max. pitch/rev.	Max. ap
Ø32	5.2	13.5	148	39.5	1.8	2.3	
				64	7.8		
Ø40	5.2	13.5	148	55.5	3.8	3.0	
				80	9.7		
Ø50	5.5	13.5	140	75.5	6.6	3.3	
				100	12.8		
Ø63	4.0	13.5	193	101.5	7.2	3.3	
				126	11.8		
Ø80	2.9	13.5	267	135.5	7.5	3.3	
				160	10.8		

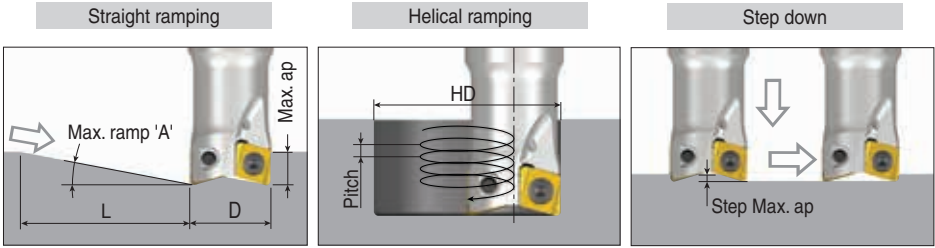

4NKT 11 PNR: R0.8

(unit: mm)

Cutter dia.(D)	Straight ramp down			Helical ramp down			Step down
	Max. ramp (A°)	Max. ap	Min. length (L)	Min. dia.(HD)	Max. dia.(HD)	Max. pitch/rev.	Max. ap
Ø25	4.0	10.3	147	31.5		1.2	1.1
					50	4.7	
Ø32	4.3	10.3	135	45.5		2.7	1.0
					64	6.5	
Ø40	4.5	10.3	131	61.5		4.5	0.9
					80	8.4	
Ø50	3.2	10.3	184	81.5		4.7	0.9
					100	7.5	
Ø63	2.4	10.3	246	107.5		5.0	0.9
					126	7.0	
Ø80	1.8	10.3	328	141.5		5.2	0.9
					160	6.7	

4NKT 14 PNR: R0.8

(unit: mm)

Cutter dia.(D)	Straight ramp down			Helical ramp down			Step down
	Max. ramp (A°)	Max. ap	Min. length (L)	Min. dia.(HD)	Max. dia.(HD)	Max. pitch/rev.	Max. ap
Ø32	4.1	13.5	188	39.5		1.4	1.1
					64	6.1	
Ø40	4.3	13.5	180	55.5		3.1	0.9
					80	8.0	
Ø50	4.7	13.5	163	75.5		5.7	0.9
					100	11.1	
Ø63	3.5	13.5	221	101.5		6.3	0.9
					126	10.3	
Ø80	2.6	13.5	297	135.5		6.7	0.9
					160	9.7	

Ramping Data

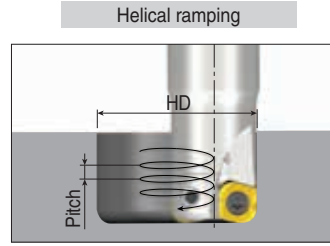
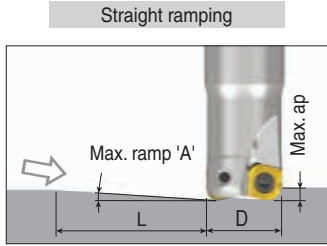

4NKT 04-HF: R1.2

(unit: mm)

Cutter dia.(D)	Straight ramp down			Helical ramp down		
	Max. ramp (A°)	Max. ap	Min. length (L)	Min. dia.(HD)	Max. dia.(HD)	Max. pitch/rev.
Ø8	0.1	0.5	191	9.9		0.0
					16	0.1
Ø10	0.8	0.5	34	13.9		0.2
					20	0.4
Ø11	1.6	0.5	18	15.9		0.4
					22	0.5
Ø12	1.6	0.5	18	17.9		0.4
					24	0.5
Ø13	2.0	0.5	14	19.9		0.5
					26	0.5
Ø16	1.9	0.5	15	25.9		0.5
					32	0.5
Ø20	2.3	0.5	12	33.9		0.5
					40	0.5
Ø25	1.7	0.5	16	43.9		0.5
					50	0.5
Ø32	1.3	0.5	22	57.9		0.5
					64	0.5
Ø40	1.0	0.5	29	73.9		0.5
					80	0.5

4NKT 06-HF: R2.0

(unit: mm)

Cutter dia.(D)	Straight ramp down			Helical ramp down		
	Max. ramp (A°)	Max. ap	Min. length (L)	Min. dia.(HD)	Max. dia.(HD)	Max. pitch/rev.
Ø16	0.6	1.0	88	21.4		0.2
					32	0.5
Ø17	0.7	1.0	76	23.4		0.2
					34	0.6
Ø18	1.1	1.0	50	25.4		0.4
					36	1.0
Ø20	1.7	1.0	34	29.4		0.7
					40	1.0
Ø21	1.9	1.0	29	31.4		0.9
					42	1.0
Ø25	2.3	1.0	24	39.4		1.0
					50	1.0
Ø26	3.2	1.0	18	41.4		1.0
					52	1.0
Ø32	2.4	1.0	24	53.4		1.0
					64	1.0
Ø40	1.8	1.0	32	69.4		1.0
					80	1.0
Ø50	1.4	1.0	41	89.4		1.0
					100	1.0
Ø63	1.1	1.0	52	115.4		1.0
					126	1.0

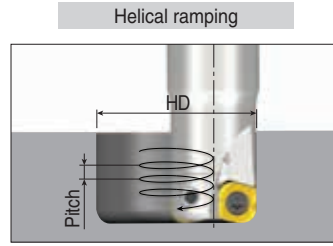
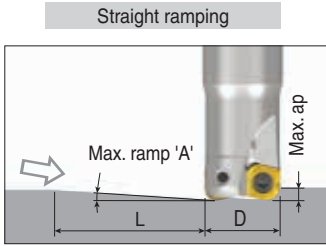

4NKT 09-HF: R3.2

(unit: mm)

Cutter dia.(D)	Straight ramp down			Helical ramp down		
	Max. ramp (A°)	Max. ap	Min. length (L)	Min. dia.(HD)	Max. dia.(HD)	Max. pitch/rev.
Ø20	0.3	1.5	287	25		0.1
					40	0.3
Ø25	1.2	1.5	69	35		0.6
					50	1.5
Ø32	2.4	1.5	35	49		1.5
					64	1.5
Ø40	2.3	1.5	37	65		1.5
					80	1.5
Ø50	1.7	1.5	49	85		1.5
					100	1.5
Ø63	1.3	1.5	66	111		1.5
					126	1.5
Ø80	1.0	1.5	86	145		1.5
					160	1.5

4NKT 11-HF: R4.0

(unit: mm)

Cutter dia.(D)	Straight ramp down			Helical ramp down		
	Max. ramp (A°)	Max. ap	Min. length (L)	Min. dia.(HD)	Max. dia.(HD)	Max. pitch/rev.
Ø25	0.8	2.0	143	31		0.2
					50	0.9
Ø32	2.0	2.0	57	45		1.2
					64	2.0
Ø40	3.4	2.0	34	61		2.0
					80	2.0
Ø50	2.4	2.0	48	81		2.0
					100	2.0
Ø63	1.8	2.0	64	107		2.0
					126	2.0
Ø80	1.3	2.0	85	141		2.0
					160	2.0

Ramping Data

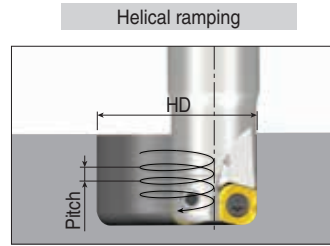
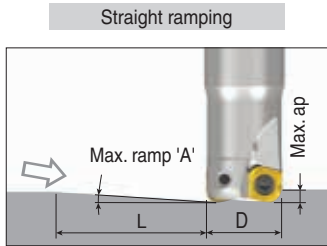

4NKT 14-HF: R5.0

(unit: mm)

Cutter dia. (D)	Straight ramp down			Helical ramp down		
	Max. ramp (A°)	Max. ap	Min. length (L)	Min. dia. (HD)	Max. dia. (HD)	Max. pitch/rev.
Ø32	1.0	3.0	172	39	64	0.3
						1.5
Ø40	1.8	3.0	96	55	80	1.3
						3.0
Ø50	3.9	3.0	44	75	100	3.0
						3.0
Ø63	2.7	3.0	64	101	126	3.0
						3.0
Ø80	1.9	3.0	88	135	160	3.0
						3.0

Programming technical data

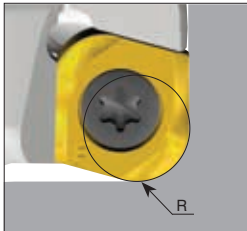

	R Program	A Over cut	B Un-machined
4NKT 040212R-HF	1.2	0	0
4NKT 060320R-HF	2.0	0	0
4NKT 090432R-HF	3.2	0	0
4NKT 110640R-HF	4.0	0	0
4NKT 140750R-HF	5.0	0	0

Ramping Data

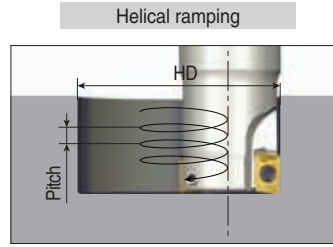
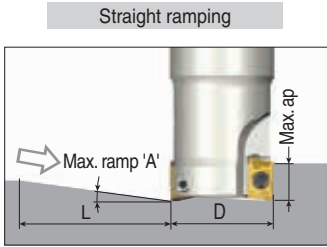

AXMT 06

(unit: mm)

Cutter dia.(D)	Straight ramp down			Helical ramp down		
	Max. ramp (A°)	Max. ap	Min. length (L)	Min. dia.(HD)	Max. dia.(HD)	Max. pitch/rev.
Ø8	1.0	5.0	287	9	16	0.0
						0.4
Ø10	8.0	5.0	36	13	20	1.1
						3.7
Ø11	6.0	5.0	48	15	22	1.1
						3.1
Ø12	6.0	5.0	48	17	24	1.4
						3.4
Ø13	5.5	5.0	52	19	26	1.5
						3.3
Ø14	4.8	5.0	60	21	28	1.6
						3.1
Ø15	4.3	5.0	67	23	30	1.6
						3.0
Ø16	4.0	5.0	72	25	32	1.7
						3.0
Ø17	3.5	5.0	82	27	34	1.6
						2.8
Ø18	5.0	5.0	57	29	36	2.6
						4.2
Ø19	4.8	5.0	60	31	38	2.7
						4.3
Ø20	4.0	5.0	72	33	40	2.4
						3.7
Ø21	3.5	5.0	82	35	42	2.3
						3.4
Ø25	3.0	5.0	95	43	50	2.5
						3.5
Ø32	2.0	5.0	143	57	64	2.3
						3.0
Ø40	1.5	5.0	191	73	80	2.3
						2.8

Ramping Data

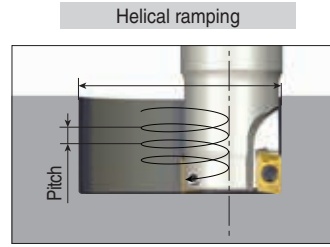
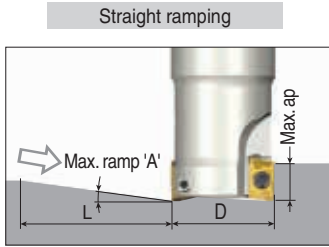

APKT 09

(unit: mm)

Cutter dia.(D)	Straight ramp down			Helical ramp down		
	Max. ramp (A°)	Max. ap	Min. length (L)	Min. dia.(HD)	Max. dia.(HD)	Max. pitch/rev.
Ø10	7.5	9.0	68	14		1.4
					20	3.5
Ø12	7.3	9.0	70	16		1.4
					24	4.1
Ø14	6.0	9.0	86	18		1.1
					28	3.9
Ø16	4.9	9.0	105	21.08		1.2
					32	3.7
Ø17	4.4	9.0	117	23.08		1.2
					34	3.5
Ø18	4.0	9.0	129	25.08		1.3
					36	3.4
Ø20	3.4	9.0	152	29.08		1.4
					40	3.2
Ø21	3.1	9.0	166	31.08		1.5
					42	3.0
Ø22	2.8	9.0	184	33.08		1.4
					44	2.9
Ø25	1.8	9.0	287	39.08		1.2
					50	2.1
Ø26	2.0	9.0	258	41.08		1.4
					52	2.4
Ø30	2.2	9.0	234	49.08		2.0
					60	3.1
Ø32	2.0	9.0	258	53.08		2.0
					64	3.0
Ø33	1.7	9.0	303	55.08		1.7
					66	2.6
Ø40	1.5	9.0	344	69.08		2.0
					80	2.8
Ø50	1.1	9.0	469	89.08		2.0
					100	2.6
Ø63	0.8	9.0	645	115.08		1.9
					126	2.3
Ø80	0.5	9.0	1032	149.08		1.6
					160	1.9

Ramping Data

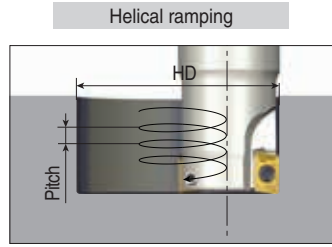
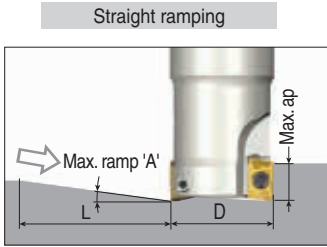

APKT 12

(unit: mm)

Cutter dia.(D)	Straight ramp down			Helical ramp down		
	Max. ramp (A°)	Max. ap	Min. length (L)	Min. dia.(HD)	Max. dia.(HD)	Max. pitch/rev.
Ø16	12.5	12.0	54	17.5		0.5
					32	9.5
Ø18	9.7	12.0	70	20.9		1.3
					36	8.2
Ø20	6.8	12.0	101	24.9		1.6
					40	6.4
Ø21	6.2	12.0	111	26.9		1.7
					42	6.1
Ø25	8.0	12.0	85	34.9		3.7
					50	9.4
Ø26	7.5	12.0	91	36.9		3.8
					52	9.1
Ø32	5.0	12.0	137	48.9		3.9
					64	7.5
Ø33	4.6	12.0	149	50.9		3.8
					66	7.1
Ø40	3.5	12.0	196	64.9		4.1
					80	6.5
Ø50	2.5	12.0	275	84.9		4.8
					100	5.8
Ø63	1.7	12.0	405	110.9		4.5
					126	5.0
Ø80	1.3	12.0	529	144.9		4.6
					160	4.8

Ramping Data

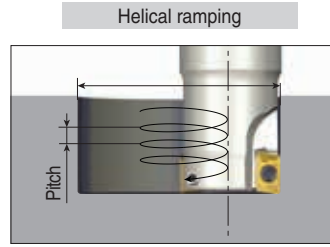
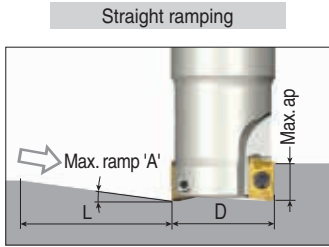

APKT 17

(unit: mm)

Cutter dia.(D)	Straight ramp down			Helical ramp down		
	Max. ramp (A°)	Max. ap	Min. length (L)	Min. dia.(HD)	Max. dia.(HD)	Max. pitch/rev.
Ø20	8.0	16.1	115	22	40	0.7
						7.5
Ø25	5.0	16.1	184	30.6	50	1.3
						5.8
Ø26	4.0	16.1	230	32.6	52	1.2
						4.9
Ø32	9.0	16.1	102	44.6	64	5.3
						13.5
Ø33	9.0	16.1	102	46.6	66	5.7
						13.9
Ø40	5.0	16.1	184	60.6	80	4.8
						9.3
Ø50	4.4	16.1	209	80.6	100	6.3
						10.3
Ø63	3.2	16.1	288	106.6	126	6.5
						9.4
Ø80	2.3	16.1	401	140.6	160	6.5
						8.6
Ø100	1.8	16.1	513	180.6	200	6.8
						8.4
Ø125	1.4	16.1	659	230.6	250	6.9
						8.1
Ø160	1.0	16.1	923	300.6	320	6.5
						7.5
Ø200	0.7	16.1	1318	380.6	400	5.9
						6.5

APKT 19

(unit: mm)

Cutter dia.(D)	Straight ramp down			Helical ramp down		
	Max. ramp (A°)	Max. ap	Min. length (L)	Min. dia.(HD)	Max. dia.(HD)	Max. pitch/rev.
Ø40	6.0	17.5	167	56	80	4.5
						11.2
Ø50	4.0	17.5	250	76	100	4.9
						9.3
Ø63	2.9	17.5	346	102	126	5.3
						8.5
Ø80	2.1	17.5	477	136	160	5.5
						7.8
Ø100	1.6	17.5	627	176	200	5.7
						7.5
Ø125	1.2	17.5	736	226	250	5.6
						7.0
Ø160	0.9	17.5	1115	296	320	5.7
						6.7
Ø200	0.7	17.5	1433	376	400	5.7
						6.5

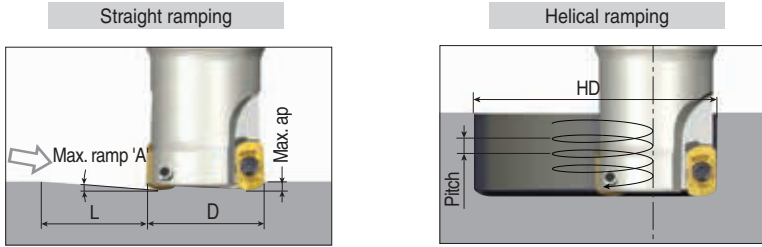

AXMT 0602R-HF

(unit: mm)

Cutter dia.(D)	Straight ramp down			Helical ramp down		
	Max. ramp (A°)	Max. ap	Min. length (L)	Min. dia.(HD)	Max. dia.(HD)	Max. pitch/rev.
Ø8	0.3	0.5	96	14	16	0.1
						0.1
Ø10	0.5	0.5	57	14	20	0.2
						0.3
Ø11	1.0	0.5	29	18	22	0.5
						0.5
Ø12	2.3	0.5	12	18	24	0.5
						0.5
Ø13	4.5	0.5	6	18	26	0.5
						0.5
Ø14	3.5	0.5	8	18	28	0.5
						0.5
Ø15	3.0	0.5	10	26	30	0.5
						0.5
Ø16	2.8	0.5	10	26	32	0.5
						0.5
Ø17	2.5	0.5	11	26	34	0.5
						0.5
Ø18	2.3	0.5	12	26	36	0.5
						0.5
Ø19	2.2	0.5	13	26	38	0.5
						0.5
Ø20	1.9	0.5	15	34	40	0.5
						0.5
Ø21	1.7	0.5	17	34	42	0.5
						0.5
Ø25	1.4	0.5	20	44	50	0.5
						0.5
Ø32	1.0	0.5	29	58	64	0.5
						0.5
Ø40	0.7	0.5	41	74	80	0.5
						0.5

Programming technical data

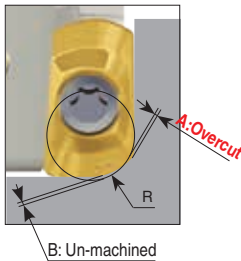

	R Program	A Over cut	B Un-machined
AXMT 0602R-HF	0.9	0	0.22
	1.0	0.01	0.19
	1.5	0.16	0.05
	2.0	0.35	0
APKT 09T3R-HF	1.5	0	0.47
	1.7	0	0.29
	2.0	0.04	0.3
	2.5	0.18	0.15
APKT 1204R-HF	3.0	0.36	0.04
	2	0	0.57
	2.5	0.07	0.42
	3	0.21	0.28
	3.5	0.39	0.15
	4	0.58	0.06

Yellow background: Recommended program 'R'

Ramping Data

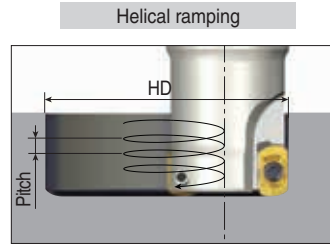
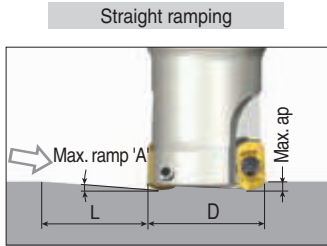

APKT 09T3R-HF

(unit: mm)

Cutter dia.(D)	Straight ramp down			Helical ramp down		
	Max. ramp (A°)	Max. ap	Min. length (L)	Min. dia.(HD)	Max. dia.(HD)	Max. pitch/rev.
Ø16	3.8	1.0	15	22	32	1.0
						1.0
Ø17	3.5	1.0	16	24	34	1.0
						1.0
Ø18	3.4	1.0	17	26	36	1.0
						1.0
Ø20	3.0	1.0	19	30	40	1.0
						1.0
Ø21	2.3	1.0	25	32	42	1.0
						1.0
Ø22	2.0	1.0	29	34	44	1.0
						1.0
Ø25	2.1	1.0	27	40	50	1.0
						1.0
Ø26	2.0	1.0	29	42	52	1.0
						1.0
Ø30	1.8	1.0	32	50	60	1.0
						1.0
Ø32	1.6	1.0	36	54	64	1.0
						1.0
Ø33	1.5	1.0	38	56	66	1.0
						1.0
Ø40	1.2	1.0	48	70	80	1.0
						1.0
Ø50	0.9	1.0	64	90	100	1.0
						1.0
Ø63	0.5	1.0	115	116	126	1.0
						1.0
Ø80	0.4	1.0	143	150	160	1.0
						1.0

Ramping Data

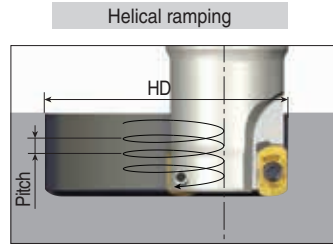
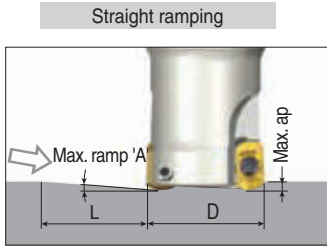

APKT 1204R-HF

(unit: mm)

Cutter dia.(D)	Straight ramp down			Helical ramp down		
	Max. ramp (A°)	Max. ap	Min. length (L)	Min. dia.(HD)	Max. dia.(HD)	Max. pitch/rev.
Ø16	3.8	1.2	18	21		0.8
					32	1.2
Ø18	4.0	1.2	17	24		1.1
					36	1.2
Ø20	4.0	1.2	17	27		1.2
					40	1.2
Ø21	3.5	1.2	20	29		1.2
					42	1.2
Ø25	2.5	1.2	27	37		1.2
					50	1.2
Ø26	2.3	1.2	30	39		1.2
					52	1.2
Ø32	1.7	1.2	40	51		1.2
					64	1.2
Ø33	1.7	1.2	40	53		1.2
					66	1.2
Ø40	1.5	1.2	46	67		1.2
					80	1.2
Ø50	1.1	1.2	63	86		1.2
					100	1.2
Ø63	1.0	1.2	69	112		1.2
					126	1.2
Ø80	0.8	1.2	86	146		1.2
					160	1.2

Ramping Data

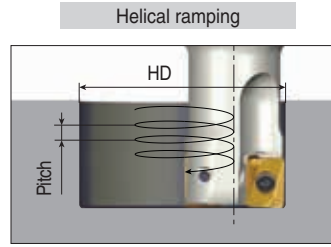
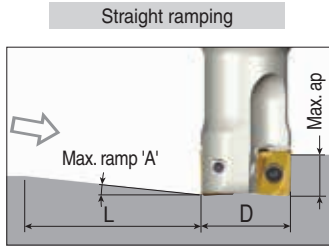

ANH(M)X 11

(unit: mm)

Cutter dia.(D)	Straight ramp down			Helical ramp down		
	Max. ramp (A°)	Max. ap	Min. length (L)	Min. dia.(HD)	Max. dia.(HD)	Max. pitch/rev.
Ø25	1.5	11.0	420	30	50	0.3
						1.7
Ø26	1.4	11.0	450	32	52	0.4
						1.7
Ø32	1.1	11.0	573	44	64	0.6
						1.6
Ø33	1.0	11.0	631	46	66	0.6
						1.5
Ø40	0.8	11.0	788	60	80	0.7
						1.5
Ø50	0.6	11.0	1051	80	100	0.8
						1.4
Ø63	0.4	11.0	1576	106	126	0.8
						1.2
Ø80	0.3	11.0	2102	140	160	0.8
						1.1
Ø100	0.2	11.0	3153	180	200	0.7
						0.9
Ø125	0.2	11.0	3153	230	250	1.0
						1.2

ANH(M)X 16

(unit: mm)

Cutter dia.(D)	Straight ramp down			Helical ramp down		
	Max. ramp (A°)	Max. ap	Min. length (L)	Min. dia.(HD)	Max. dia.(HD)	Max. pitch/rev.
Ø32	1.2	15.0	716	44	64	0.7
						1.8
Ø33	1.0	15.0	560	46	66	0.6
						1.5
Ø40	0.9	15.0	955	60	80	0.8
						1.7
Ø50	0.8	15.0	1075	80	100	1.1
						1.9
Ø63	0.6	15.0	1433	106	126	1.2
						1.8
Ø80	0.45	15.0	1911	140	160	1.3
						1.7
Ø100	0.35	15.0	2457	180	200	1.3
						1.6
Ø125	0.25	15.0	3439	230	250	1.2
						1.5
Ø160	0.15	15.0	5732	300	320	1.0
						1.1
Ø200	0.1	15.0	8599	380	400	0.8
						0.9

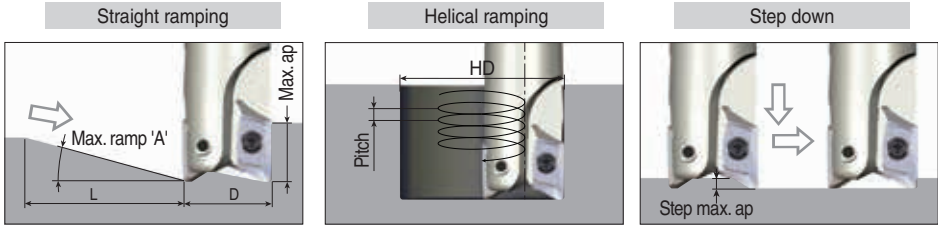

XEVT 16: 0.4R-1.6R

(unit: mm)

Cutter dia.(D)	Straight ramp down			Helical ramp down			Step down
	Max. ramp (A°)	Max. ap	Min. length (L)	Min. dia.(HD)	Max. dia.(HD)	Max. pitch/rev.	Max. ap
Ø25	20.5	16	43	29.1	50	4.1	4
						13.6	4
Ø32	17.5	16	51	43.1	64	9.3	4
						13.6	4
Ø40	11.0	16	82	59.1	80	9.9	4
						13.6	4
Ø50	8.5	16	107	79.1	100	11.6	4
						13.6	4
Ø63	5.5	16	166	105.1	126	10.8	4
						13.6	4
Ø80	4.3	16	213	139.1	160	11.9	4
						13.6	4
Ø100	3.3	16	278	179.1	200	12.2	4
						13.6	4
Ø125	2.5	16	367	229.1	250	12.1	4
						13.6	4
Ø160	1.9	16	483	299.1	320	12.3	4
						13.6	4
Ø200	1.5	16	611	379.1	400	12.5	4
						13.6	4

XEVT 16: 2.0R-2.4R

(unit: mm)

Cutter dia.(D)	Straight ramp down			Helical ramp down			Step down
	Max. ramp (A°)	Max. ap	Min. length (L)	Min. dia.(HD)	Max. dia.(HD)	Max. pitch/rev.	Max. ap
Ø25	19.5	15.5	44	29.1	50	3.9	3.5
						13.2	3.5
Ø32	16.5	15.5	52	43.1	64	8.8	3.5
						13.2	3.5
Ø40	10.5	15.5	84	59.1	80	9.4	3.5
						13.2	3.5
Ø50	8.0	15.5	110	79.1	100	10.9	3.5
						13.2	3.5
Ø63	5.0	15.5	177	105.1	126	9.8	3.5
						13.2	3.5
Ø80	3.9	15.5	227	139.1	160	10.7	3.5
						13.2	3.5
Ø100	3.0	15.5	296	179.1	200	11.1	3.5
						13.2	3.5
Ø125	2.3	15.5	386	229.1	250	11.2	3.5
						13.2	3.5
Ø160	1.7	15.5	523	299.1	320	11.0	3.5
						12.7	3.5
Ø200	1.3	15.5	683	379.1	400	10.8	3.5
						12.1	3.5

Ramping Data

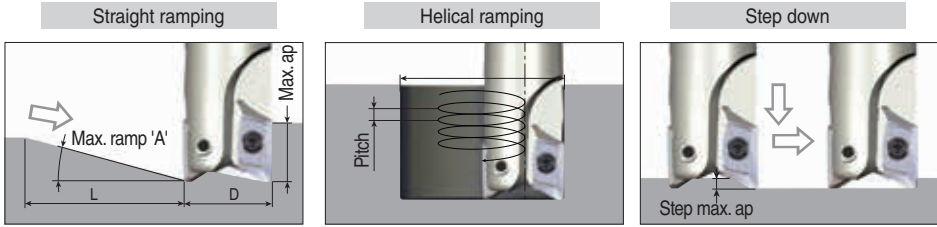

XEVT 16: 3.0R-3.2R

(unit: mm)

Cutter dia.(D)	Straight ramp down			Helical ramp down			Step down
	Max. ramp (A°)	Max. ap	Min. length (L)	Min. dia.(HD)	Max. dia.(HD)	Max. pitch/rev.	Max. ap
Ø25	18.5	14.5	43	29.1	50	3.7	2.8
				43.1		12.3	2.8
Ø32	16.0	14.5	51	43.1	64	8.5	2.8
				59.1		12.3	2.8
Ø40	9.5	14.5	87	59.1	80	8.5	2.8
				79.1		12.3	2.8
Ø50	7.0	14.5	118	79.1	100	9.5	2.8
				105.1		12.3	2.8
Ø63	5.0	14.5	166	105.1	126	9.8	2.8
				139.1		12.3	2.8
Ø80	3.7	14.5	224	139.1	160	10.2	2.8
				179.1		12.3	2.8
Ø100	2.8	14.5	297	179.1	200	10.3	2.8
				229.1		12.3	2.8
Ø125	2.1	14.5	396	229.1	250	10.2	2.8
				299.1		12.2	2.8
Ø160	1.5	14.5	554	299.1	320	9.7	2.8
				379.1		11.2	2.8
Ø200	1.2	14.5	693	379.1	400	10.0	2.8
				400		11.2	2.8

XEVT 16: 4.0R-5.0R

(unit: mm)

Cutter dia.(D)	Straight ramp down			Helical ramp down			Step down
	Max. ramp (A°)	Max. ap	Min. length (L)	Min. dia.(HD)	Max. dia.(HD)	Max. pitch/rev.	Max. ap
Ø25	17.5	14.5	46	29.1	50	3.4	2.5
				43.1		12.3	2.5
Ø32	15.0	14.5	54	43.1	64	7.9	2.5
				59.1		12.3	2.5
Ø40	8.5	14.5	97	59.1	80	7.6	2.5
				79.1		12.3	2.5
Ø50	6.5	14.5	127	79.1	100	8.8	2.5
				105.1		12.3	2.5
Ø63	4.5	14.5	184	105.1	126	8.8	2.5
				139.1		12.3	2.5
Ø80	3.3	14.5	252	139.1	160	9.1	2.5
				179.1		12.3	2.5
Ø100	2.4	14.5	346	179.1	200	8.8	2.5
				229.1		11.2	2.5
Ø125	1.8	14.5	462	229.1	250	8.7	2.5
				299.1		10.5	2.5
Ø160	1.4	14.5	594	299.1	320	9.1	2.5
				379.1		10.4	2.5
Ø200	1.1	14.5	756	379.1	400	9.2	2.5
				400		10.2	2.5

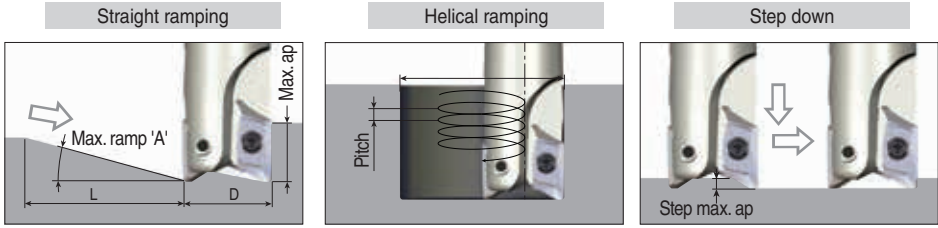

XEVT 22: 0.5R-0.8R

(unit: mm)

Cutter dia.(D)	Straight ramp down			Helical ramp down			Step down
	Max. ramp (A°)	Max. ap	Min. length (L)	Min. dia.(HD)	Max. dia.(HD)	Max. pitch/rev.	Max. ap
Ø32	21.0	21.2	55	38.5	64	6.7	5.5
						18.0	5.5
Ø40	14.0	21.0	84	54.5	80	9.6	5.5
						17.9	5.5
Ø50	9.5	21.0	126	74.5	100	10.9	5.5
						17.9	5.5
Ø63	7.0	21.0	171	100.5	126	12.3	5.5
						17.9	5.5
Ø80	5.0	20.9	239	134.5	160	12.7	5.5
						17.8	5.5
Ø100	3.7	20.9	323	174.5	200	12.9	5.5
						17.3	5.5
Ø125	2.6	20.9	460	224.5	250	12.1	5.5
						15.1	5.5
Ø200	1.6	20.9	749	374.5	400	13.0	5.5
						14.9	5.5

XEVT 22: 1.6R-2.0R

(unit: mm)

Cutter dia.(D)	Straight ramp down			Helical ramp down			Step down
	Max. ramp (A°)	Max. ap	Min. length (L)	Min. dia.(HD)	Max. dia.(HD)	Max. pitch/rev.	Max. ap
Ø32	20.5	21.0	56	38.5	64	6.5	5.0
						17.9	5.0
Ø40	13.5	20.9	87	54.5	80	9.3	5.0
						17.8	5.0
Ø50	9.5	20.9	125	74.5	100	10.9	5.0
						17.8	5.0
Ø63	6.7	20.9	178	100.5	126	11.8	5.0
						17.8	5.0
Ø80	4.7	20.8	253	134.5	160	12.0	5.0
						17.5	5.0
Ø100	3.5	20.8	340	174.5	200	12.2	5.0
						16.3	5.0
Ø125	2.5	20.8	477	224.5	250	11.6	5.0
						14.6	5.0
Ø200	1.5	20.8	795	374.5	400	12.2	5.0
						14.0	5.0

Ramping Data

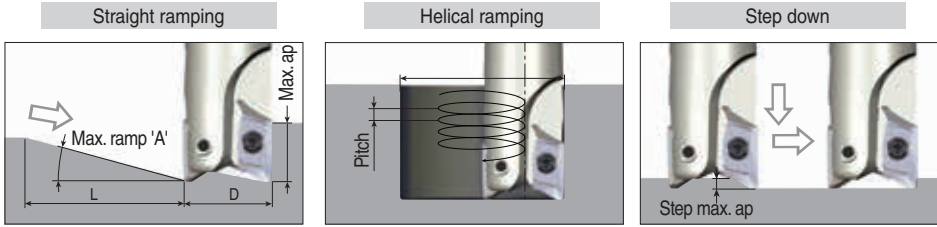

XEVT 22: 3.0R-4.0R

(unit: mm)

Cutter dia.(D)	Straight ramp down			Helical ramp down			Step down
	Max. ramp (A°)	Max. ap	Min. length (L)	Min. dia.(HD)	Max. dia.(HD)	Max. pitch/rev.	Max. ap
Ø32	20.0	20.0	55	38.5	64	6.3	4.0
				54.5		17.0	4.0
Ø40	12.3	19.9	91	74.5	80	8.4	4.0
				100.5		16.9	4.0
Ø50	8.5	19.9	133	134.5	100	9.8	4.0
				160		16.9	4.0
Ø63	5.5	19.9	207	174.5	126	9.6	4.0
				200		16.2	4.0
Ø80	4.0	19.8	283	224.5	160	10.2	4.0
				250		14.9	4.0
Ø100	3.0	19.8	378	374.5	200	10.4	4.0
				400		14.0	4.0
Ø125	2.0	19.8	567	400	250	9.3	4.0
				400		11.6	4.0
Ø200	1.0	19.8	1135	400	400	8.1	4.0
				400		9.3	4.0

XEVT 22: 5.0R

(unit: mm)

Cutter dia.(D)	Straight ramp down			Helical ramp down			Step down
	Max. ramp (A°)	Max. ap	Min. length (L)	Min. dia.(HD)	Max. dia.(HD)	Max. pitch/rev.	Max. ap
Ø32	19.0	19.5	57	38.5	64	6.0	3.5
				54.5		16.6	3.5
Ø40	11.4	19.4	96	74.5	80	7.8	3.5
				100.5		16.5	3.5
Ø50	7.5	19.4	147	134.5	100	8.6	3.5
				160		16.5	3.5
Ø63	5.0	19.4	222	174.5	126	8.8	3.5
				200		14.7	3.5
Ø80	3.5	19.3	316	224.5	160	8.9	3.5
				250		13.1	3.5
Ø100	2.5	19.3	442	374.5	200	8.7	3.5
				400		11.6	3.5
Ø125	1.7	19.3	651	400	250	7.9	3.5
				400		9.9	3.5
Ø200	0.8	19.3	1383	400	400	6.5	3.5
				400		7.4	3.5

Straight ramping

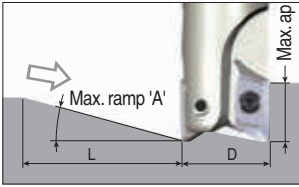

Helical ramping

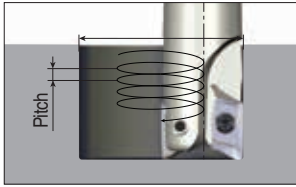

Step down

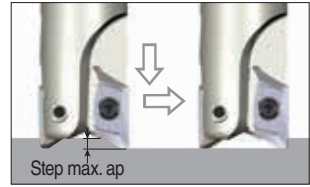

XEVT 22: 6.4R

(unit: mm)

Cutter dia.(D)	Straight ramp down			Helical ramp down			Step down
	Max. ramp (A°)	Max. ap	Min. length (L)	Min. dia.(HD)	Max. dia.(HD)	Max. pitch/rev.	Max. ap
Ø32	18.0	18.8	58	38.5	64	5.6	3.0
						16.0	3.0
Ø40	10.0	18.7	106	54.5	80	6.8	3.0
						15.9	3.0
Ø50	6.5	18.7	164	74.5	100	7.4	3.0
						15.2	3.0
Ø63	4.5	18.7	238	100.5	126	7.9	3.0
						13.2	3.0
Ø80	3.0	18.6	355	134.5	160	7.6	3.0
						11.2	3.0
Ø100	2.0	18.6	533	174.5	200	6.9	3.0
						9.3	3.0
Ø125	1.5	18.6	711	224.5	250	7.0	3.0
						8.7	3.0
Ø200	0.7	18.6	1523	374.5	400	5.7	3.0
						6.5	3.0

Ramping Data

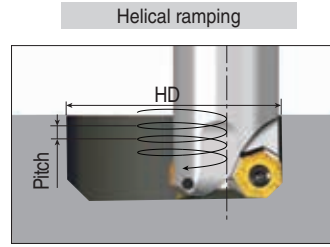
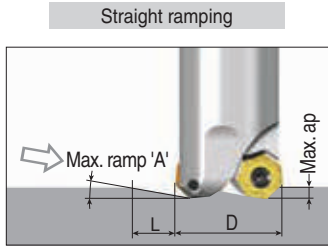

7EMT 06

(unit: mm)

Cutter dia.(D)	Straight ramp down			Helical ramp down		
	Max. ramp (A°)	Max. ap	Min. length (L)	Min. dia.(HD)	Max. dia.(HD)	Max. pitch/rev.
Ø32	29	3.2	6	45.5	64	3.2
				61.5		3.2
Ø40	15.5	3.2	12	81.5	100	3.2
				107.5		3.2
Ø50	9.5	3.2	19	141.5	160	3.2
				181.5		3.2
Ø63	5.5	3.2	33	231.5	250	3.2
				250		3.2
Ø80	4.0	3.2	46	250	250	3.2
				250		3.2
Ø100	3.0	3.2	61	250	250	3.2
				250		3.2
Ø125	2.0	2.3	66	250	250	3.2
				250		3.2

Programming technical data

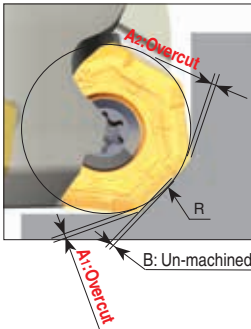

	R Program	A Over cut		B Un-machined
		A1	A2	B
7EMT 06	3	0	0	1.77
	4,5	0	0	1.51
	5	0.03	0.02	0.94
	6	0.21	0.19	0.53

Yellow background: Recommended program 'R'

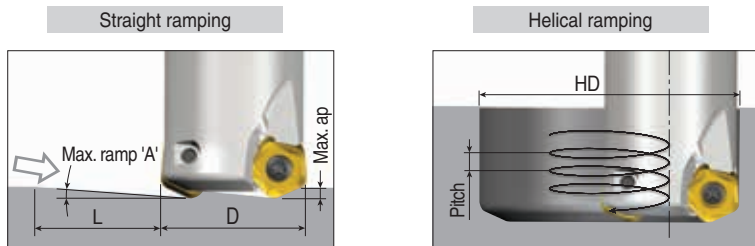

PTKU 05

(unit: mm)

Cutter dia.(D)	Straight ramp down			Helical ramp down		
	Max. ramp (A°)	Max. ap	Min. length (L)	Min. dia.(HD)	Max. dia.(HD)	Max. pitch/rev.
Ø20	1.3	1.5	66	33		0.7
					40	0.9
Ø25	1.1	1.5	78	43		0.8
					50	1.0
Ø26	1.0	1.5	86	45		0.8
					52	0.9
Ø32	1.0	1.5	86	57		1.0
					64	1.1
Ø33	1.0	1.5	86	59		1.0
					66	1.2
Ø40	0.8	1.5	101	73		1.1
					80	1.2
Ø50	0.7	1.5	123	93		1.1
					100	1.2
Ø52	0.7	1.5	123	97		1.2
					104	1.3
Ø63	0.6	1.5	132	119		1.3
					126	1.4
Ø66	0.6	1.5	143	125		1.3
					132	1.4

Programming technical data

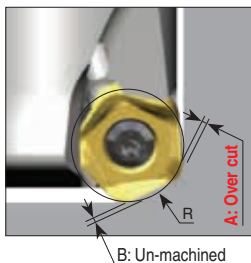

	R Program	A Over cut	B Un-machined
PTKU 05	2.5	0.00	0.83
	2.7	0.00	0.76
	3.0	0.04	0.66

: Recommended program 'R'

Ramping Data

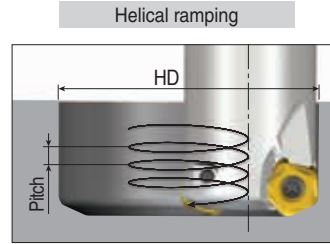
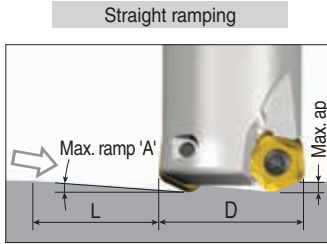

PTKU 10

(unit: mm)

Cutter dia. (D)	Straight ramp down			Helical ramp down		
	Max. ramp (A°)	Max. ap	Min. length (L)	Min. dia. (HD)	Max. dia. (HD)	Max. pitch/rev.
Ø40	1.5	3.0	111	63		1.7
					80	2.2
Ø50	1.9	3.0	88	83		2.8
					100	3.0
Ø63	1.7	3.0	101	109		3.0
					126	3.0
Ø66	2.2	3.0	78	115		3.0
					132	3.0
Ø80	1.5	3.0	115	143		3.0
					160	3.0
Ø100	1.1	3.0	150	183		3.0
					200	3.0
Ø125	0.8	3.0	202	233		3.0
					250	3.0
Ø160	0.6	3.0	265	303		3.0
					320	3.0
Ø200	0.5	3.0	344	383		3.0
					400	3.0

Programming technical data

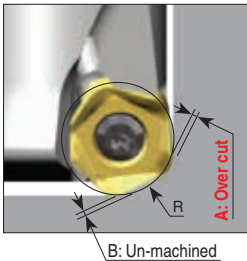

	R Program	A Over cut	B Un-machined
PTKU 10	5.5	0.00	1.45
	6.0	0.09	1.28
	6.5	0.21	1.11

5.5: Recommended program 'R'

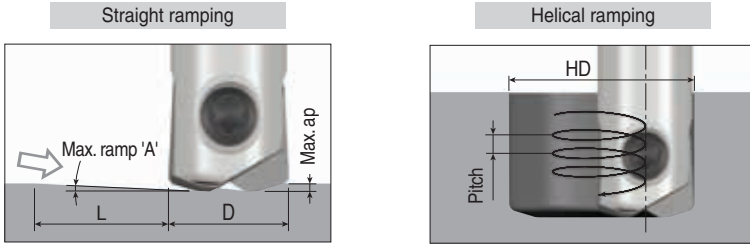

HFN

(unit: mm)

Cutter dia.(D)	Straight ramp down			Helical ramp down		
	Max. ramp (A°)	Max. ap	Min. length (L)	Min. dia.(HD)	Max. dia.(HD)	Max. pitch/rev.
Ø6	2.0	0.3	9	9.6	11	0.3
						0.3
Ø8	2.5	0.5	11	12		0.5
					15	0.5

Programming technical data

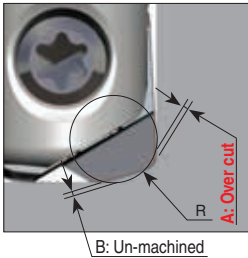

	R Program	A Over cut	B Un-machined
HFN 060	0.8	0.00	0.21
	1.0	0.03	0.16
HFN 080	0.8	0.00	0.38
	1.0	0.00	0.32
	1.2	0.02	0.27

Yellow background: Recommended program 'R'

Ramping Data

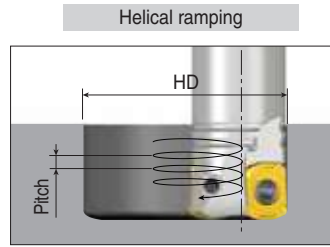
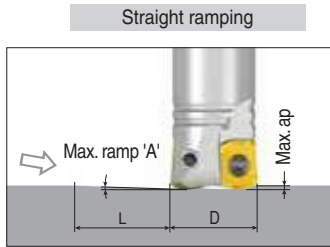

BLMV 06

(unit: mm)

Cutter dia. (D)	Straight ramp down			Helical ramp down		
	Max. ramp (A°)	Max. ap	Min. length (L)	Min. dia. (HD)	Max. dia. (HD)	Max. pitch/rev.
Ø16	5.1	0.7	8	27	32	0.7
				29		0.7
Ø17	4.5	0.7	9	31	36	0.7
				34		1.0
Ø18	4.4	0.7	10	34	40	1.0
				35		1.0
Ø20	2.5	1.0	23	39	44	1.0
				43		1.0
Ø21	2.3	1.0	25	45	50	1.0
				55		1.0
Ø22	2.7	1.0	22	57	60	1.0
				59		1.0
Ø25	2.5	1.0	23	63	70	1.0
				73		1.0
Ø26	2.2	1.0	26	79	84	1.0
				93		1.0
Ø30	1.6	1.0	35	97	104	1.0
				119		1.0
Ø32	1.4	1.0	40	127	132	1.0
						1.0
Ø33	1.3	1.0	43			1.0
						1.0
Ø35	1.2	1.0	46			1.0
						1.0
Ø40	1.0	1.0	55			1.0
						1.0
Ø42	1.0	1.0	58			1.0
						1.0
Ø50	0.8	1.0	72			1.0
						1.0
Ø52	0.8	1.0	77			1.0
						1.0
Ø63	0.6	1.0	96			1.0
						1.0
Ø66	0.6	1.0	96			1.0
						1.0

Programming technical data

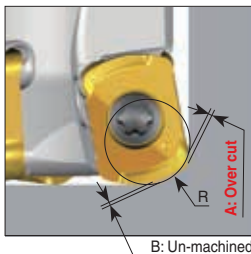

	R Program	A Over cut	B Un-machined
BLMV 06 (Ø16, Ø17)	1.5	0	0.36
	2.0	0.09	0.22
	2.5	0.27	0.10
BLMV 06 (Ø20~)	1.5	0	0.58
	2.0	0	0.41
	2.5	0.12	0.26
	3.0	0.29	0.12

■: Recommended program 'R'

Ramping Data

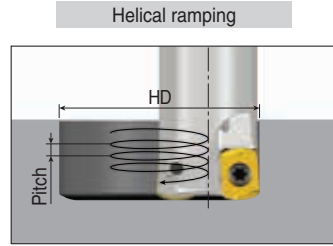
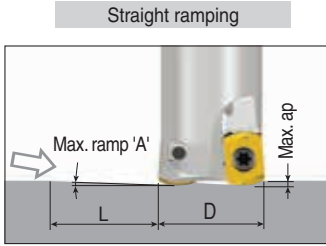

BLMP 04

(unit: mm)

Cutter dia.(D)	Straight ramp down			Helical ramp down		
	Max. ramp (A°)	Max. ap	Min. length (L)	Min. dia.(HD)	Max. dia.(HD)	Max. pitch/rev.
Ø8	0.4	0.5	72	12.6		0.1
					16	0.1
Ø10	0.6	0.5	44	16.6		0.2
					20	0.2
Ø11	0.7	0.5	38	18.6		0.2
					22	0.3
Ø12	1.0	0.5	29	20.6		0.4
					24	0.4
Ø13	1.1	0.5	25	22.6		0.5
					26	0.5
Ø16	1.0	0.5	29	28.6		0.5
					32	0.5
Ø17	1.1	0.5	26	30.6		0.5
					34	0.5
Ø20	1.0	0.5	27	36.6		0.5
					40	0.5
Ø21	0.7	0.5	38	38.6		0.5
					42	0.5
Ø25	0.7	0.5	38	46.6		0.5
					50	0.5
Ø32	0.6	0.5	48	60.6		0.5
					64	0.5

Programming technical data

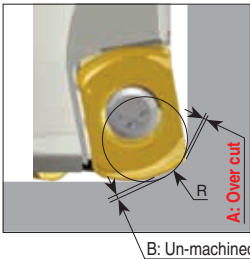

	R Program	A Over cut	B Un-machined
BLMP 04	0.8	0.00	0.28
	0.9	0.00	0.25
	1.0	0.08	0.22

0.9 : Recommended program 'R'

Ramping Data

Straight ramping

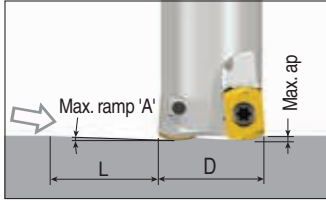

Helical ramping

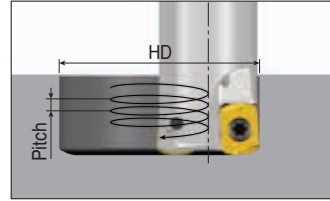

BLMP 06

(unit: mm)

Cutter dia.(D)	Straight ramp down			Helical ramp down		
	Max. ramp (A°)	Max. ap	Min. length (L)	Min. dia.(HD)	Max. dia.(HD)	Max. pitch/rev.
Ø16	2.0	0.7	13	23		0.7
					32	0.7
Ø17	2.0	0.7	15	25		0.7
					34	0.7
Ø18	2.3	0.7	16	27		0.7
					36	0.7
Ø20	1.5	1.0	38	31		0.8
					40	1.0
Ø21	1.5	1.0	38	33		0.8
					42	1.0
Ø22	1.5	1.0	38	35		1.0
					44	1.0
Ø25	1.3	1.0	41	41		1.0
					50	1.0
Ø26	1.2	1.0	44	43		1.0
					52	1.0
Ø30	1.0	1.0	52	51		1.0
					60	1.0
Ø32	0.9	1.0	57	55		1.0
					64	1.0
Ø33	0.9	1.0	57	57		1.0
					66	1.0
Ø35	0.8	1.0	57	61		1.0
					70	1.0
Ø40	0.7	1.0	64	71		1.0
					80	1.0
Ø42	0.7	1.0	72	75		1.0
					84	1.0
Ø50	0.6	1.0	96	91		1.0
					100	1.0
Ø52	0.6	1.0	96	95		1.0
					104	1.0
Ø63	0.5	1.0	115	117		1.0
					126	1.0
Ø66	0.5	1.0	115	123		1.0
					132	1.0

Programming technical data

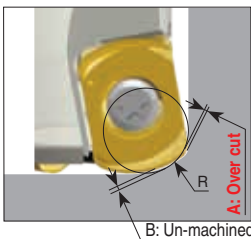

	R Program	A Over cut	B Un-machined
BLMP 06 (Ø16, Ø17, Ø18)	1.5	0	0.35
	2.0	0.1	0.22
	2.5	0.27	0.1
BLMP 06 (Ø20-)	2.0	0	0.42
	2.5	0.12	0.26
	3.0	0.29	0.17

Yellow background: Recommended program 'R'

Ramping Data

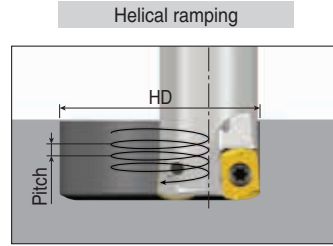
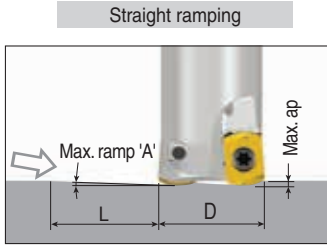

BLMP 09

(unit: mm)

Cutter dia.(D)	Straight ramp down			Helical ramp down		
	Max. ramp (A°)	Max. ap	Min. length (L)	Min. dia.(HD)	Max. dia.(HD)	Max. pitch/rev.
Ø25	2.2	1.5	39	42	50	1.5
Ø26	2.2	1.5	39	44	52	1.5
Ø30	2.0	1.5	43	52	60	1.5
Ø32	2.0	1.5	43	56	64	1.5
Ø33	2.0	1.5	43	58	66	1.5
Ø35	2.0	1.5	43	60	70	1.5
Ø40	1.5	1.5	57	72	80	1.5
Ø42	1.5	1.5	57	76	84	1.5
Ø50	1.0	1.5	86	92	100	1.5
Ø52	1.0	1.5	86	96	104	1.5
Ø63	0.9	1.5	96	118	126	1.5
Ø66	0.9	1.5	96	124	132	1.5
Ø80	0.8	1.5	107	152	160	1.5
Ø100	0.7	1.5	123	192	200	1.5
Ø125	0.4	1.5	215	240	250	1.5

Programming technical data

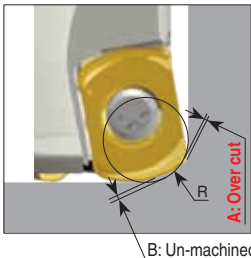

	R Program	A Over cut	B Un-machined
BLMP 09	2.5	0	0.61
	3.0	0.09	0.45
	3.5	0.24	0.30
	4.0	0.41	0.17
	3.0	0.36	0.04

■ : Recommended program 'R'

Ramping Data

Straight ramping

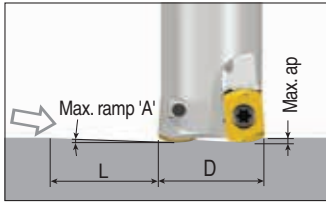

Helical ramping

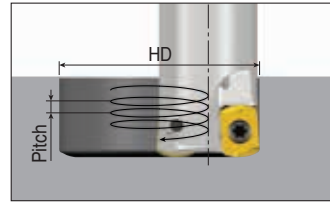

BLMP 11

(unit: mm)

Cutter dia.(D)	Straight ramp down			Helical ramp down		
	Max. ramp (A°)	Max. ap	Min. length (L)	Min. dia.(HD)	Max. dia.(HD)	Max. pitch/rev.
Ø30	0.50	2.0	229	41	60	0.3
						0.7
Ø32	0.50	2.0	229	45	64	0.3
						0.7
Ø33	0.45	2.0	255	47	66	0.3
						0.7
Ø35	0.50	2.0	229	51	70	0.4
						0.8
Ø40	0.55	2.0	208	61	80	0.5
						1.0
Ø42	0.50	2.0	229	65	84	0.5
						1.0
Ø50	0.50	2.0	229	81	100	0.7
						1.2
Ø52	0.45	2.0	255	85	104	0.7
						1.1
Ø63	0.45	2.0	255	107	126	0.9
						1.3
Ø66	0.40	2.0	287	113	132	0.9
						1.2
Ø80	0.35	2.0	328	141	160	1.0
						1.3
Ø100	0.30	2.0	382	181	200	1.1
						1.4
Ø125	0.25	2.0	459	231	250	1.2
						1.5
Ø160	0.20	2.0	573	301	320	1.3
						1.5
Ø200	0.15	2.0	764	381	400	1.3
						1.4

Programming technical data

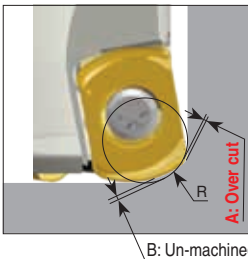

	R Program	A Over cut	B Un-machined
BLMP 11	2.4	0.00	1.09
	3.0	0.00	0.90
	3.2	0.18	0.85

■ : Recommended program 'R'

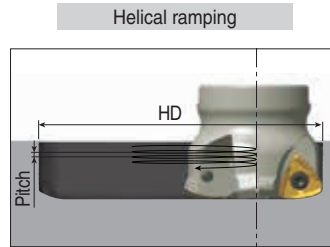
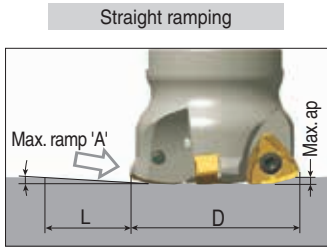

BLMP 13

(unit: mm)

Cutter dia.(D)	Straight ramp down			Helical ramp down		
	Max. ramp (A°)	Max. ap	Min. length (L)	Min. dia.(HD)	Max. dia.(HD)	Max. pitch/rev.
Ø32	0.8	2.0	143	50		0.7
					64	0.9
Ø33	1.1	2.0	104	52		1.0
					66	1.3
Ø35	1.1	2.0	104	56		1.1
					70	1.3
Ø40	1.2	2.0	96	66		1.4
					80	1.7
Ø42	1.1	2.0	104	70		1.3
					84	1.6
Ø50	0.8	2.0	143	86		1.2
					100	1.4
Ø52	0.8	2.0	143	90		1.3
					104	1.5
Ø63	0.6	2.0	191	112		1.2
					126	1.3
Ø66	0.6	2.0	191	118		1.2
					132	1.4
Ø80	0.5	2.0	229	146		1.3
					160	1.4
Ø100	0.4	2.0	287	186		1.3
					200	1.4
Ø125	0.3	2.0	382	236		1.2
					250	1.3
Ø160	0.3	2.0	382	306		1.6
					320	1.7
Ø200	0.2	2.0	573	386		1.3
					400	1.4
Ø250	0.2	2.0	573	486		1.7
					500	1.7

Programming technical data

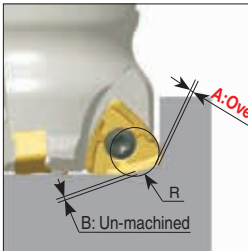

BLMP 13	R Program	A Over cut	B Un-machined
	3.0	0	1.31
3.5	0	1.17	
4.0	0.04	1.03	
4.5	0.15	0.89	
5.0	0.3	0.76	

 : Recommended program 'R'

Ramping Data



Straight ramping

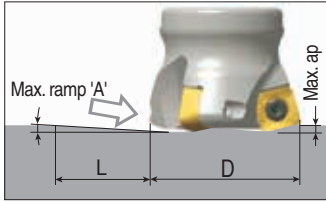

Helical ramping

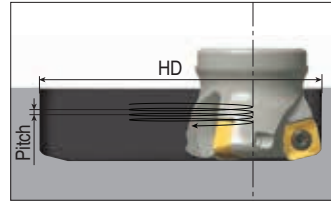

SBMT 06

(unit: mm)

Cutter dia.(D)	Straight ramp down			Helical ramp down		
	Max. ramp (A°)	Max. ap	Min. length (L)	Min. dia.(HD)	Max. dia.(HD)	Max. pitch/rev.
Ø16	2.2	1.0	25.5	22.8	32	0.7
						1.0
Ø17	2.4	1.0	23.4	24.8	34	0.9
						1.0
Ø20	3.2	1.0	17.9	30.8	40	1.0
						1.0
Ø21	3.1	1.0	18.5	32.8	42	1.0
						1.0
Ø25	2.4	1.0	23.4	40.8	50	1.0
						1.0
Ø32	1.8	1.0	31.8	54.8	64	1.0
						1.0
Ø40	1.3	1.0	42.5	70.8	80	1.0
						1.0
Ø50	1.0	1.0	57.3	90.8	100	1.0
						1.0
Ø63	0.7	1.0	76.4	116.8	126	1.0
						1.0

Programming technical data

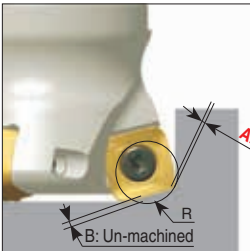

	R Program	A Over cut	B Un-machined
SBMT 06	1.8	0	0.81
	2.0	0	0.77
	2.2	0.01	0.73

Yellow background :Recommended program 'R'

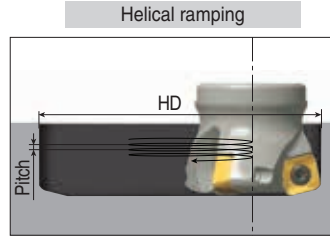
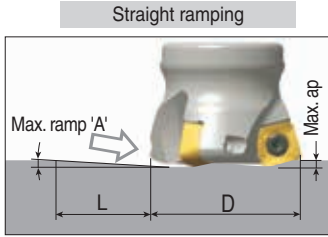

SBMT 09

(unit: mm)

Cutter dia.(D)	Straight ramp down			Helical ramp down		
	Max. ramp (A°)	Max. ap	Min. length (L)	Min. dia.(HD)	Max. dia.(HD)	Max. pitch/rev.
Ø25	1.6	1.2	43	36	50	1
						1.2
Ø26	1.7	1.2	40	38	52	1.1
						1.2
Ø30	3.1	1.2	22	46	60	1.2
						1.2
Ø32	3.9	1.2	18	50	64	1.2
						1.2
Ø33	3.7	1.2	19	52	66	1.2
						1.2
Ø35	3.4	1.2	18	56	70	1.2
						1.2
Ø40	2.8	1.2	25	66	80	1.2
						1.2
Ø42	2.6	1.2	26	70	84	1.2
						1.2
Ø50	2.0	1.2	34	86	100	1.2
						1.2
Ø52	1.9	1.2	38	90	104	1.2
						1.2
Ø63	1.5	1.2	43	112	126	1.2
						1.2
Ø66	1.1	1.2	63	118	132	1.2
						1.2
Ø80	1.2	1.2	63	146	160	1.2
						1.2

Programming technical data

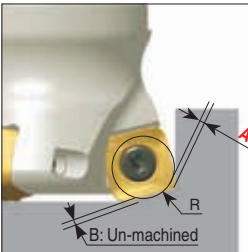

	R Program	A Over cut	B Un-machined
SBMT 09	3.5	0.1	0.81
	3	0	0.9
	2.5	0	0.98
	2	0	1.1

■ : Recommended program 'R'

Ramping Data

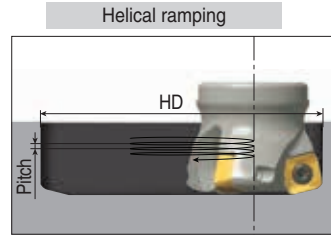
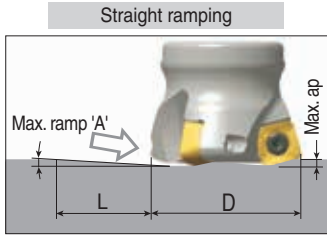

SBMT 13

(unit: mm)

Cutter dia.(D)	Straight ramp down			Helical ramp down		
	Max. ramp (A°)	Max. ap	Min. length (L)	Min. dia.(HD)	Max. dia.(HD)	Max. pitch/rev.
Ø32	7.0	2.0	16	47	64	2.0
						2.0
Ø33	6.9	2.0	17	49	66	2.0
						2.0
Ø35	6.4	2.0	18	53	70	2.0
						2.0
Ø40	5.3	2.0	22	63	80	2.0
						2.0
Ø42	4.4	2.0	26	67	84	2.0
						2.0
Ø50	4.3	2.0	27	83	100	2.0
						2.0
Ø52	4.0	2.0	29	87	104	2.0
						2.0
Ø63	2.9	2.0	40	109	126	2.0
						2.0
Ø80	2.0	2.0	57	143	160	2.0
						2.0
Ø100	1.5	2.0	76	183	200	2.0
						2.0
Ø125	1.1	2.0	104	233	250	2.0
						2.0
Ø160	0.8	2.0	104	303	320	2.0
						2.0
Ø200	0.6	2.0	127	383	400	2.0
						2.0
Ø250	0.5	2.0	164	483	500	2.0
						2.0

Programming technical data

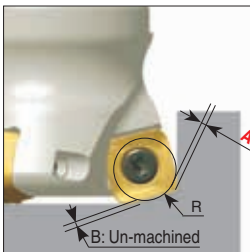

	R Program	A Over cut	B Un-machined
SBMT 13	4.0	0	1.62
	4.5	0	1.51
	5.0	0.04	1.4
	5.5	0.14	1.29
	6.0	0.28	1.18

■ :Recommended program 'R'

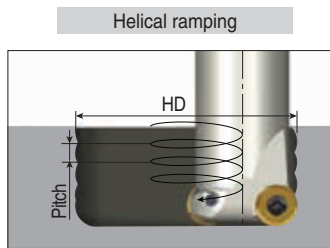
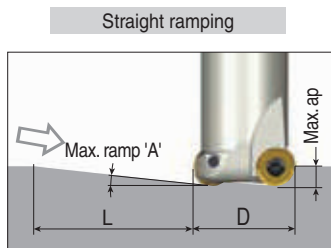

RNMU 10

(unit: mm)

Cutter dia.(D)	Straight ramp down			Helical ramp down		
	Max. ramp (A°)	Max. ap	Min. length (L)	Min. dia.(HD)	Max. dia.(HD)	Max. pitch/rev.
Ø25	1.1	5.0	261	33		0.4
					50	1.3
Ø26	1.1	5.0	261	35		0.5
					52	1.3
Ø32	0.9	5.0	318	47		0.6
					64	1.3
Ø33	0.9	5.0	318	49		0.7
					66	1.4
Ø40	0.9	5.0	318	63		1.0
					80	1.7
Ø42	0.9	5.0	318	67		1.0
					84	1.8
Ø50	0.7	5.0	409	83		1.1
					100	1.6
Ø52	0.8	5.0	358	87		1.3
					104	1.9

RNMU 12

(unit: mm)

Cutter dia.(D)	Straight ramp down			Helical ramp down		
	Max. ramp (A°)	Max. ap	Min. length (L)	Min. dia.(HD)	Max. dia.(HD)	Max. pitch/rev.
Ø32	1.4	6.0	246	42		0.7
					64	2.1
Ø33	1.4	6.0	246	44		0.7
					66	2.2
Ø40	1.3	6.0	265	58		1.1
					80	2.4
Ø50	1.0	6.0	344	78		1.3
					100	2.3
Ø52	1.0	6.0	344	82		1.4
					104	2.4
Ø63	1.0	6.0	344	104		1.9
					126	2.9
Ø66	1.0	6.0	344	110		2.0
					132	3.1
Ø80	0.9	6.0	382	138		2.4
					160	3.4
Ø100	0.7	6.0	491	178		2.5
					200	3.3

Ramping Data

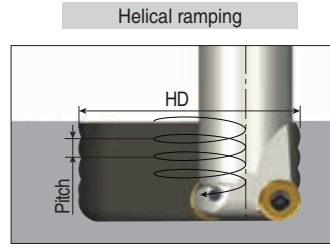
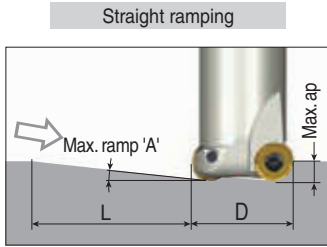

RNMU 16

(unit: mm)

Cutter dia.(D)	Straight ramp down			Helical ramp down		
	Max. ramp (A°)	Max. ap	Min. length (L)	Min. dia.(HD)	Max. dia.(HD)	Max. pitch/rev.
Ø40	1.4	8.0	328	52	80	0.8
						2.6
Ø42	1.4	8.0	328	56	84	0.9
						2.7
Ø50	1.3	8.0	353	72	100	1.3
						3.0
Ø52	1.0	8.0	459	76	104	1.1
						2.4
Ø63	1.0	8.0	459	98	126	1.6
						2.9
Ø66	1.0	8.0	459	104	132	1.8
						3.1
Ø80	1.0	8.0	459	132	160	2.4
						3.7
Ø100	0.9	8.0	510	172	200	3.0
						4.2
Ø125	0.9	8.0	510	222	250	4.1
						5.2

Ramping Data

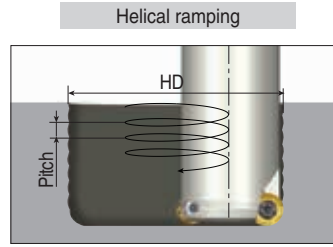
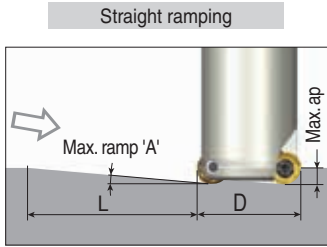

RYM(H)X-08

(unit: mm)

Cutter dia.(D)	Straight ramp down			Helical ramp down		
	Max. ramp (A°)	Max. ap	Min. length (L)	Min. dia.(HD)	Max. dia.(HD)	Max. pitch/rev.
Ø16	2.5	4.0	92	18	32	0.2
						1.9
Ø17	2.5	4.0	92	20	34	0.3
						2.0
Ø18	2.5	4.0	92	22	36	0.5
						2.1
Ø20	4.0	4.0	57	26	40	1.1
						3.4
Ø21	4.0	4.0	57	28	42	1.3
						3.4
Ø25	4.0	4.0	57	36	50	2.1
						3.4
Ø26	4.0	4.0	57	38	52	2.2
						3.4
Ø32	4.0	4.0	57	50	64	3.4
						3.4
Ø40	7.0	4.0	33	66	80	3.4
						3.4

RYMX-10

(unit: mm)

Cutter dia.(D)	Straight ramp down			Helical ramp down		
	Max. ramp (A°)	Max. ap	Min. length (L)	Min. dia.(HD)	Max. dia.(HD)	Max. pitch/rev.
Ø20	4.5	5.0	64	22	40	0.4
						4.2
Ø21	4.5	5.0	64	24	42	0.6
						4.4
Ø25	5.0	5.0	57	32	50	1.6
						4.3
Ø26	5.0	5.0	57	34	52	1.9
						4.3
Ø32	5.0	5.0	57	46	64	3.3
						4.3
Ø35	5.0	5.0	57	52	70	4.0
						4.3
Ø40	5.0	5.0	57	62	80	4.3
						4.3
Ø42	5.0	5.0	57	66	84	4.3
						4.3
Ø50	6.5	5.0	44	82	100	4.3
						4.3
Ø52	6.0	5.0	48	86	104	4.3
						4.3
Ø66	4.5	5.0	64	114	132	4.3
						4.3

Ramping Data

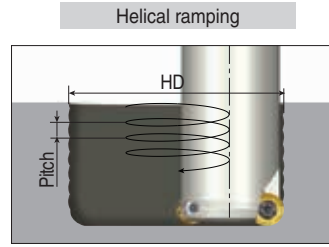
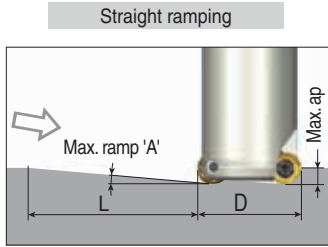

RYMX-12

(unit: mm)

Cutter dia.(D)	Straight ramp down			Helical ramp down		
	Max. ramp (A°)	Max. ap	Min. length (L)	Min. dia.(HD)	Max. dia.(HD)	Max. pitch/rev.
Ø25	6.0	6.0	57	28	50	0.8
						5.1
Ø26	6.0	6.0	57	30	52	1.1
						5.1
Ø32	12.0	6.0	28	42	64	5.1
						5.1
Ø33	12.0	6.0	28	44	66	5.1
						5.1
Ø35	12.0	6.0	28	48	70	5.1
						5.1
Ø40	10.0	6.0	34	58	80	5.1
						5.1
Ø42	12.0	6.0	28	62	84	5.1
						5.1
Ø50	9.0	6.0	38	78	100	5.1
						5.1
Ø52	8.0	6.0	43	82	104	5.1
						5.1
Ø55	8.0	6.0	43	88	110	5.1
						5.1
Ø63	7.0	6.0	49	104	126	5.1
						5.1
Ø66	6.5	6.0	53	110	132	5.1
						5.1
Ø80	4.5	6.0	76	138	160	5.1
						5.1
Ø100	3.5	6.0	98	178	200	5.1
						5.1
Ø125	2.5	6.0	137	228	250	5.1
						5.1

Ramping Data

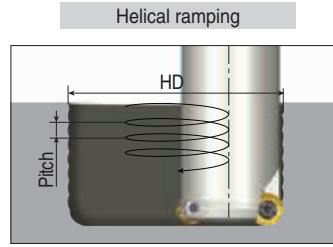
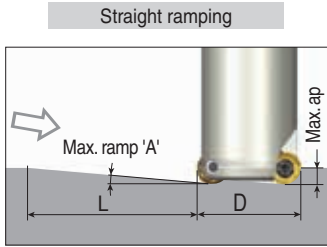

RYMX-16

(unit: mm)

Cutter dia.(D)	Straight ramp down			Helical ramp down		
	Max. ramp (A°)	Max. ap	Min. length (L)	Min. dia.(HD)	Max. dia.(HD)	Max. pitch/rev.
Ø32	8.0	8.0	57	34		0.7
					64	6.8
Ø40	9.5	8.0	48	50		4.5
					80	6.8
Ø42	9.0	8.0	51	54		5.1
					84	6.8
Ø50	9.0	8.0	51	70		6.8
					100	6.8
Ø52	9.0	8.0	51	74		6.8
					104	6.8
Ø63	8.5	8.0	54	96		6.8
					126	6.8
Ø66	8.5	8.0	54	102		6.8
					132	6.8
Ø80	6.0	8.0	76	130		6.8
					160	6.8
Ø100	5.0	8.0	91	170		6.8
					200	6.8
Ø125	3.5	8.0	131	220		6.8
					250	6.8
Ø160	3.5	8.0	131	290		6.8
					320	6.8

RYMX-20

(unit: mm)

Cutter dia.(D)	Straight ramp down			Helical ramp down		
	Max. ramp (A°)	Max. ap	Min. length (L)	Min. dia.(HD)	Max. dia.(HD)	Max. pitch/rev.
Ø50	8.0	10.0	71	62		4.5
					100	8.5
Ø63	12.5	10.0	45	88		8.5
					126	8.5
Ø80	8.5	10.0	67	122		8.5
					160	8.5
Ø100	6.5	10.0	88	162		8.5
					200	8.5
Ø125	4.5	10.0	127	212		8.5
					250	8.5
Ø160	4.0	10.0	143	282		8.5
					320	8.5
Ø200	2.5	10.0	229	362		8.5
					400	8.5
Ø250	2.4	10.0	239	462		8.5
					500	8.5

Ramping Data

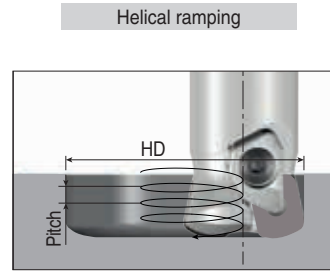
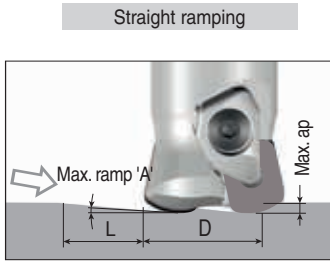

BNGX 06

(unit: mm)

Cutter dia. (D)	Straight ramp down			Helical ramp down		
	Max. ramp (A°)	Max. ap	Min. length (L)	Min. dia. (HD)	Max. dia. (HD)	Max. pitch/rev.
Ø16	0.5	1.0	115	25.6	32	0.2
						0.4
Ø20	0.5	1.0	115	33.4	40	0.3
						0.5
Ø25	0.4	1.0	144	43.4	50	0.4
						0.5
Ø32	0.3	1.0	191	57.3	64	0.4
						0.6

BNGX 09

(unit: mm)

Cutter dia. (D)	Straight ramp down			Helical ramp down		
	Max. ramp (A°)	Max. ap	Min. length (L)	Min. dia. (HD)	Max. dia. (HD)	Max. pitch/rev.
Ø25	1.2	1.5	55	39	50	0.9
						1.1
Ø32	0.6	1.5	132	53	64	0.6
						0.7
Ø40	0.6	1.5	143	69	80	0.7
						0.8
Ø50	0.5	1.5	156	89	100	0.9
						1.0

Programming technical data

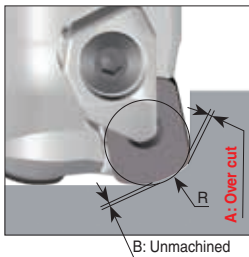

	R Program	A Over cut	B Un-machined
BNGX 06	1.5	0.00	0.60
	2.0	0.00	0.42
	2.5	0.10	0.27
BNGX 09	3.0	0.00	0.61
	3.4	0.00	0.46
	3.5	0.01	0.43
	4.0	0.12	0.26

■ : Recommended program 'R'

Straight ramping

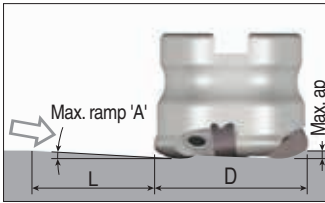

Helical ramping

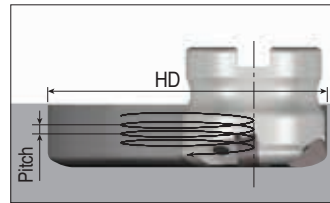

BNGX 12

(unit: mm)

Cutter dia.(D)	Straight ramp down			Helical ramp down		
	Max. ramp (A°)	Max. ap	Min. length (L)	Min. dia.(HD)	Max. dia.(HD)	Max. pitch/rev.
Ø50	0.6	2.5	239	84		1.1
					100	1.0
Ø63	0.5	2.5	287	110		1.1
					126	1.1
Ø80	0.4	2.5	318	144		1.3
					160	1.3

Programming technical data

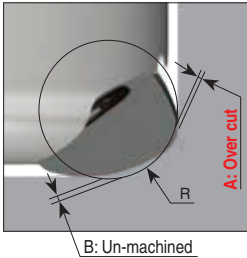

	R Program	A Over cut	B Un-machined
BNGX 12	4.0	0.00	1.18
	4.5	0.00	1.00
	5.0	0.03	0.84

Yellow background : Recommended program 'R'

SOLID END MILLS



SOLID END MILLS



contents

MAXI-RUSH Line

Tool Selection Guide	F4
Grades	F14
MAXI-RUSH	
End Mill Heads	F17
Slotting Heads	F41
Holders	F45
Spare Parts	F55
Recommended Cutting Conditions	F56

Guide to Icons



➤ Flutes



➤ Helix Angle



➤ Cutting Condition Page



➤ Ball Nose



➤ Corner Radius



➤ Wave Cutting Edge



➤ Head Page



➤ Wrench















Solid End Mill Line













Designation System	F58
End Mills	
HARD-MILL	F60
SLIK-SOLID	F61
APEX-MILL	F63
STAR-MILL	F68
ALU-MILL	F74
CERAMIC-SFEED	F75
DIA-MILL	F77
Recommended Cutting Conditions	F84

Tool Selection Guide



Modular solid carbide end mill heads

	MXEE-03	MXEE(D)-04	MXEE-03	MXEE-104	MXES-R	MXEE-R																																																																								
Series																																																																														
Type	Flat	Radius	Radius	Chamfer/Radius	Radius	Chamfer																																																																								
Flute																																																																														
Grades	TT5523	TT5523	TT5523	TT5523	TT5523	TT5523																																																																								
Material	<table border="1"><tr><td>P</td><td>M</td><td>K</td><td>N</td><td>S</td><td>H</td></tr><tr><td>●</td><td>○</td><td>●</td><td>○</td><td>○</td><td>○</td></tr></table>	P	M	K	N	S	H	●	○	●	○	○	○	<table border="1"><tr><td>P</td><td>M</td><td>K</td><td>N</td><td>S</td><td>H</td></tr><tr><td>●</td><td>○</td><td>●</td><td>○</td><td>○</td><td>○</td></tr></table>	P	M	K	N	S	H	●	○	●	○	○	○	<table border="1"><tr><td>P</td><td>M</td><td>K</td><td>N</td><td>S</td><td>H</td></tr><tr><td>●</td><td>○</td><td>●</td><td>○</td><td>○</td><td>○</td></tr></table>	P	M	K	N	S	H	●	○	●	○	○	○	<table border="1"><tr><td>P</td><td>M</td><td>K</td><td>N</td><td>S</td><td>H</td></tr><tr><td>●</td><td>○</td><td>●</td><td>○</td><td>○</td><td>○</td></tr></table>	P	M	K	N	S	H	●	○	●	○	○	○	<table border="1"><tr><td>P</td><td>M</td><td>K</td><td>N</td><td>S</td><td>H</td></tr><tr><td>●</td><td>○</td><td>●</td><td>○</td><td>○</td><td>○</td></tr></table>	P	M	K	N	S	H	●	○	●	○	○	○	<table border="1"><tr><td>P</td><td>M</td><td>K</td><td>N</td><td>S</td><td>H</td></tr><tr><td>●</td><td>○</td><td>●</td><td>○</td><td>○</td><td>○</td></tr></table>	P	M	K	N	S	H	●	○	●	○	○	○
P	M	K	N	S	H																																																																									
●	○	●	○	○	○																																																																									
P	M	K	N	S	H																																																																									
●	○	●	○	○	○																																																																									
P	M	K	N	S	H																																																																									
●	○	●	○	○	○																																																																									
P	M	K	N	S	H																																																																									
●	○	●	○	○	○																																																																									
P	M	K	N	S	H																																																																									
●	○	●	○	○	○																																																																									
P	M	K	N	S	H																																																																									
●	○	●	○	○	○																																																																									
Diameter range (mm)	Ø8-Ø12	Ø5-Ø20	Ø7.7-Ø19.7	Ø8-Ø25	Ø8-Ø25	Ø8-Ø25																																																																								
Pages	F17	F18	F20	F20	F21	F22																																																																								













	MXEE-R-1.5D	MXEE-C04	MXEE-A02	MXEE-A03	MXEE-RA03	MXEE(D)-06																																																																								
Series																																																																														
Type	Radius	Chamfer	Radius	Radius	Radius	Radius																																																																								
Flute																																																																														
Grades	TT5523	TT5523	UF10/TTA101	UF10/TTA101	UF10	TT5523																																																																								
Material	<table border="1"><tr><td>P</td><td>M</td><td>K</td><td>N</td><td>S</td><td>H</td></tr><tr><td>●</td><td>○</td><td>●</td><td>○</td><td>○</td><td>○</td></tr></table>	P	M	K	N	S	H	●	○	●	○	○	○	<table border="1"><tr><td>P</td><td>M</td><td>K</td><td>N</td><td>S</td><td>H</td></tr><tr><td>●</td><td>○</td><td>●</td><td>○</td><td>○</td><td>○</td></tr></table>	P	M	K	N	S	H	●	○	●	○	○	○	<table border="1"><tr><td>P</td><td>M</td><td>K</td><td>N</td><td>S</td><td>H</td></tr><tr><td></td><td></td><td></td><td>●</td><td></td><td></td></tr></table>	P	M	K	N	S	H				●			<table border="1"><tr><td>P</td><td>M</td><td>K</td><td>N</td><td>S</td><td>H</td></tr><tr><td></td><td></td><td></td><td>●</td><td></td><td></td></tr></table>	P	M	K	N	S	H				●			<table border="1"><tr><td>P</td><td>M</td><td>K</td><td>N</td><td>S</td><td>H</td></tr><tr><td></td><td></td><td></td><td>●</td><td></td><td></td></tr></table>	P	M	K	N	S	H				●			<table border="1"><tr><td>P</td><td>M</td><td>K</td><td>N</td><td>S</td><td>H</td></tr><tr><td>●</td><td>○</td><td>●</td><td>○</td><td>○</td><td>○</td></tr></table>	P	M	K	N	S	H	●	○	●	○	○	○
P	M	K	N	S	H																																																																									
●	○	●	○	○	○																																																																									
P	M	K	N	S	H																																																																									
●	○	●	○	○	○																																																																									
P	M	K	N	S	H																																																																									
			●																																																																											
P	M	K	N	S	H																																																																									
			●																																																																											
P	M	K	N	S	H																																																																									
			●																																																																											
P	M	K	N	S	H																																																																									
●	○	●	○	○	○																																																																									
Diameter range (mm)	Ø8-Ø20	Ø8-Ø25	Ø10-Ø12	Ø8-Ø20	Ø8-Ø20	Ø8-Ø12																																																																								
Pages	F22	F23	F23	F24	F24	F25																																																																								













● Recommended, ○ Suitable

Tool Selection Guide



Modular solid carbide end mill heads

	<u>MXED-08/10</u>	<u>MXED-107/109-1.5D</u>	<u>MXRB-02</u>	<u>MXRD-06</u>	<u>MXFX-02</u>	<u>MXFX-04/06</u>																																																																								
Series																																																																														
Type	Radius	Radius	Radius	Radius	Ball	Radius																																																																								
Flute																																																																														
Grades	TT5523	TT5523	TT5523	TT5523	TT5523	TT5513/TT5523																																																																								
Material	<table border="1"><tr><td>P</td><td>M</td><td>K</td><td>N</td><td>S</td><td>H</td></tr><tr><td>●</td><td>○</td><td>●</td><td>○</td><td>○</td><td>○</td></tr></table>	P	M	K	N	S	H	●	○	●	○	○	○	<table border="1"><tr><td>P</td><td>M</td><td>K</td><td>N</td><td>S</td><td>H</td></tr><tr><td>●</td><td>○</td><td>●</td><td>○</td><td>○</td><td>○</td></tr></table>	P	M	K	N	S	H	●	○	●	○	○	○	<table border="1"><tr><td>P</td><td>M</td><td>K</td><td>N</td><td>S</td><td>H</td></tr><tr><td>●</td><td>○</td><td>●</td><td>○</td><td>○</td><td>○</td></tr></table>	P	M	K	N	S	H	●	○	●	○	○	○	<table border="1"><tr><td>P</td><td>M</td><td>K</td><td>N</td><td>S</td><td>H</td></tr><tr><td>●</td><td>○</td><td>●</td><td>○</td><td>○</td><td>○</td></tr></table>	P	M	K	N	S	H	●	○	●	○	○	○	<table border="1"><tr><td>P</td><td>M</td><td>K</td><td>N</td><td>S</td><td>H</td></tr><tr><td>●</td><td>○</td><td>●</td><td>○</td><td>○</td><td>○</td></tr></table>	P	M	K	N	S	H	●	○	●	○	○	○	<table border="1"><tr><td>P</td><td>M</td><td>K</td><td>N</td><td>S</td><td>H</td></tr><tr><td>●</td><td>○</td><td>●</td><td>○</td><td>○</td><td>○</td></tr></table>	P	M	K	N	S	H	●	○	●	○	○	○
P	M	K	N	S	H																																																																									
●	○	●	○	○	○																																																																									
P	M	K	N	S	H																																																																									
●	○	●	○	○	○																																																																									
P	M	K	N	S	H																																																																									
●	○	●	○	○	○																																																																									
P	M	K	N	S	H																																																																									
●	○	●	○	○	○																																																																									
P	M	K	N	S	H																																																																									
●	○	●	○	○	○																																																																									
P	M	K	N	S	H																																																																									
●	○	●	○	○	○																																																																									
Diameter range (mm)	Ø16-Ø25	Ø10-Ø20	Ø20	Ø8-Ø16	Ø10-Ø20	Ø8-Ø25																																																																								
Pages	F25	F26	F26	F27	F27	F28																																																																								













	<u>MXBD-BG-02</u>	<u>MXBD(E)-BG-04</u>	<u>MXBE-BH-04</u>	<u>MXBB-SG-02</u>	<u>MXBE-BGA02</u>	<u>MXCP-02</u>																																																																																				
Series																																																																																										
Type	Ball	Ball	Ball	Ball (Spherical)	Ball	Chamfer																																																																																				
Flute																																																																																										
Grades	TT5523	TT5523	TT5513	TT5523	UF10/TTA101	TT5523																																																																																				
Material	<table border="1"><tr><td>P</td><td>M</td><td>K</td><td>N</td><td>S</td><td>H</td></tr><tr><td>●</td><td>○</td><td>●</td><td>○</td><td>○</td><td>○</td></tr></table>	P	M	K	N	S	H	●	○	●	○	○	○	<table border="1"><tr><td>P</td><td>M</td><td>K</td><td>N</td><td>S</td><td>H</td></tr><tr><td>●</td><td>○</td><td>●</td><td>○</td><td>○</td><td>○</td></tr></table>	P	M	K	N	S	H	●	○	●	○	○	○	<table border="1"><tr><td>P</td><td>M</td><td>K</td><td>N</td><td>S</td><td>H</td></tr><tr><td>●</td><td>○</td><td>●</td><td>○</td><td>○</td><td>○</td></tr></table>	P	M	K	N	S	H	●	○	●	○	○	○	<table border="1"><tr><td>P</td><td>M</td><td>K</td><td>N</td><td>S</td><td>H</td></tr><tr><td>●</td><td>○</td><td>●</td><td>○</td><td>○</td><td>○</td></tr></table>	P	M	K	N	S	H	●	○	●	○	○	○	<table border="1"><tr><td>P</td><td>M</td><td>K</td><td>N</td><td>S</td><td>H</td></tr><tr><td>○</td><td>○</td><td>○</td><td>○</td><td>○</td><td>○</td></tr><tr><td>○</td><td>○</td><td>○</td><td>○</td><td>○</td><td>○</td></tr></table>	P	M	K	N	S	H	○	○	○	○	○	○	○	○	○	○	○	○	<table border="1"><tr><td>P</td><td>M</td><td>K</td><td>N</td><td>S</td><td>H</td></tr><tr><td>○</td><td>○</td><td>○</td><td>○</td><td>○</td><td>○</td></tr><tr><td>○</td><td>○</td><td>○</td><td>○</td><td>○</td><td>○</td></tr></table>	P	M	K	N	S	H	○	○	○	○	○	○	○	○	○	○	○	○
P	M	K	N	S	H																																																																																					
●	○	●	○	○	○																																																																																					
P	M	K	N	S	H																																																																																					
●	○	●	○	○	○																																																																																					
P	M	K	N	S	H																																																																																					
●	○	●	○	○	○																																																																																					
P	M	K	N	S	H																																																																																					
●	○	●	○	○	○																																																																																					
P	M	K	N	S	H																																																																																					
○	○	○	○	○	○																																																																																					
○	○	○	○	○	○																																																																																					
P	M	K	N	S	H																																																																																					
○	○	○	○	○	○																																																																																					
○	○	○	○	○	○																																																																																					
Diameter range (mm)	Ø8-Ø16	Ø6-Ø25	Ø8-Ø20	Ø8-Ø25	Ø8-Ø20	Ø8-Ø16.5																																																																																				
Pages	F28	F29	F29	F30	F30	F31																																																																																				











● Recommended, ○ Suitable

Tool Selection Guide



Modular solid carbide end mill heads

	MXCA-04/06	MXCW-02	MXCR-02	MXCS-04	MXDP-02	MXGC-02																																																																								
Series																																																																														
Type	Chamfer	Chamfer	Concave	Chamfer	Center drill	Counter Boring																																																																								
Flute																																																																														
Grades	TT5523	TT5523	TT5523	TT5523	TT5523	TT5523																																																																								
Material	<table border="1"><tr><td>P</td><td>M</td><td>K</td><td>N</td><td>S</td><td>H</td></tr><tr><td>●</td><td>○</td><td>●</td><td>○</td><td>○</td><td>○</td></tr></table>	P	M	K	N	S	H	●	○	●	○	○	○	<table border="1"><tr><td>P</td><td>M</td><td>K</td><td>N</td><td>S</td><td>H</td></tr><tr><td>●</td><td>○</td><td>●</td><td>○</td><td>○</td><td>○</td></tr></table>	P	M	K	N	S	H	●	○	●	○	○	○	<table border="1"><tr><td>P</td><td>M</td><td>K</td><td>N</td><td>S</td><td>H</td></tr><tr><td>●</td><td>○</td><td>●</td><td>○</td><td>○</td><td>○</td></tr></table>	P	M	K	N	S	H	●	○	●	○	○	○	<table border="1"><tr><td>P</td><td>M</td><td>K</td><td>N</td><td>S</td><td>H</td></tr><tr><td>●</td><td>○</td><td>●</td><td>○</td><td>○</td><td>○</td></tr></table>	P	M	K	N	S	H	●	○	●	○	○	○	<table border="1"><tr><td>P</td><td>M</td><td>K</td><td>N</td><td>S</td><td>H</td></tr><tr><td>●</td><td>○</td><td>●</td><td>○</td><td>○</td><td>○</td></tr></table>	P	M	K	N	S	H	●	○	●	○	○	○	<table border="1"><tr><td>P</td><td>M</td><td>K</td><td>N</td><td>S</td><td>H</td></tr><tr><td>●</td><td>○</td><td>●</td><td>○</td><td>○</td><td>○</td></tr></table>	P	M	K	N	S	H	●	○	●	○	○	○
P	M	K	N	S	H																																																																									
●	○	●	○	○	○																																																																									
P	M	K	N	S	H																																																																									
●	○	●	○	○	○																																																																									
P	M	K	N	S	H																																																																									
●	○	●	○	○	○																																																																									
P	M	K	N	S	H																																																																									
●	○	●	○	○	○																																																																									
P	M	K	N	S	H																																																																									
●	○	●	○	○	○																																																																									
P	M	K	N	S	H																																																																									
●	○	●	○	○	○																																																																									
Diameter range (mm)	Ø10-Ø20	Ø9.8-Ø15.7	Ø8-Ø20	Ø7.7	Ø1.07-Ø6.41	Ø8-Ø16																																																																								
Pages	F32	F32	F33	F34	F34	F35																																																																								









	MXDS-02	MXEG-01	MXDG-04	MXCSL	MXCSO																																																												
Series																																																																	
Type	Drill & Chamfer	Engraving	Grooving	Lens Shape	Oval Shape																																																												
Flute																																																																	
Grades	TT5523	TT5523	TT5523	TT5523	TT5523																																																												
Material	<table border="1"><tr><td>P</td><td>M</td><td>K</td><td>N</td><td>S</td><td>H</td></tr><tr><td>●</td><td>○</td><td>●</td><td>○</td><td>○</td><td>○</td></tr></table>	P	M	K	N	S	H	●	○	●	○	○	○	<table border="1"><tr><td>P</td><td>M</td><td>K</td><td>N</td><td>S</td><td>H</td></tr><tr><td>●</td><td>○</td><td>●</td><td>○</td><td>○</td><td>○</td></tr></table>	P	M	K	N	S	H	●	○	●	○	○	○	<table border="1"><tr><td>P</td><td>M</td><td>K</td><td>N</td><td>S</td><td>H</td></tr><tr><td>●</td><td>○</td><td>●</td><td>○</td><td>○</td><td>○</td></tr></table>	P	M	K	N	S	H	●	○	●	○	○	○	<table border="1"><tr><td>P</td><td>M</td><td>K</td><td>N</td><td>S</td><td>H</td></tr><tr><td>●</td><td>○</td><td>●</td><td>○</td><td>○</td><td>○</td></tr></table>	P	M	K	N	S	H	●	○	●	○	○	○	<table border="1"><tr><td>P</td><td>M</td><td>K</td><td>N</td><td>S</td><td>H</td></tr><tr><td>●</td><td>○</td><td>●</td><td>○</td><td>○</td><td>○</td></tr></table>	P	M	K	N	S	H	●	○	●	○	○	○
P	M	K	N	S	H																																																												
●	○	●	○	○	○																																																												
P	M	K	N	S	H																																																												
●	○	●	○	○	○																																																												
P	M	K	N	S	H																																																												
●	○	●	○	○	○																																																												
P	M	K	N	S	H																																																												
●	○	●	○	○	○																																																												
P	M	K	N	S	H																																																												
●	○	●	○	○	○																																																												
Diameter range (mm)	Ø6-Ø16	Ø6-Ø8	Ø15.5-Ø24.5	Ø8-Ø16	Ø8-Ø16																																																												
Pages	F35	F36	F36	F37	F37																																																												

● Recommended, ○ Suitable











Tool Selection Guide



Modular solid carbide end mill heads

	MXFM-106	TTRD-A60	TTRD-W55	TDT-06																																																	
Series																																																					
Type	Milling	Thread	Thread	Dovetail																																																	
Flute																																																					
Grades	TT5523	TT5543	TT5543	TT5523																																																	
Material	<table border="1"><tr><td>P</td><td>M</td><td>K</td><td>N</td><td>S</td><td>H</td></tr><tr><td>●</td><td>○</td><td>●</td><td>○</td><td>○</td><td>○</td></tr></table>	P	M	K	N	S	H	●	○	●	○	○	○	<table border="1"><tr><td>P</td><td>M</td><td>K</td><td>N</td><td>S</td><td>H</td></tr><tr><td>●</td><td>○</td><td>●</td><td>○</td><td>○</td><td>○</td></tr></table>	P	M	K	N	S	H	●	○	●	○	○	○	<table border="1"><tr><td>P</td><td>M</td><td>K</td><td>N</td><td>S</td><td>H</td></tr><tr><td>●</td><td>○</td><td>●</td><td>○</td><td>○</td><td>○</td></tr></table>	P	M	K	N	S	H	●	○	●	○	○	○	<table border="1"><tr><td>P</td><td>M</td><td>K</td><td>N</td><td>S</td><td>H</td></tr><tr><td>●</td><td>○</td><td>●</td><td>○</td><td>○</td><td>○</td></tr></table>	P	M	K	N	S	H	●	○	●	○	○	○	
P	M	K	N	S	H																																																
●	○	●	○	○	○																																																
P	M	K	N	S	H																																																
●	○	●	○	○	○																																																
P	M	K	N	S	H																																																
●	○	●	○	○	○																																																
P	M	K	N	S	H																																																
●	○	●	○	○	○																																																
Diameter range (mm)	Ø10-Ø25	Ø15.7-Ø21.7	Ø21.7	Ø27.7																																																	
Pages	F38	F39	F39	F40																																																	

Modular solid carbide slotting heads





	TST-3	TST-4/6	TST-A45	TTB-04	TTB-06																																																												
Series																																																																	
Type	Slot	Slot	Slot Chamfer	Slot	Slot																																																												
Flute																																																																	
Grades	TT5543	TT5523/TT5543	TT5523/TT5543	TT5523	TT5523/TT5543																																																												
Material	<table border="1"><tr><td>P</td><td>M</td><td>K</td><td>N</td><td>S</td><td>H</td></tr><tr><td>●</td><td>○</td><td>○</td><td>○</td><td>○</td><td>○</td></tr></table>	P	M	K	N	S	H	●	○	○	○	○	○	<table border="1"><tr><td>P</td><td>M</td><td>K</td><td>N</td><td>S</td><td>H</td></tr><tr><td>●</td><td>○</td><td>●</td><td>○</td><td>○</td><td>○</td></tr></table>	P	M	K	N	S	H	●	○	●	○	○	○	<table border="1"><tr><td>P</td><td>M</td><td>K</td><td>N</td><td>S</td><td>H</td></tr><tr><td>●</td><td>○</td><td>●</td><td>○</td><td>○</td><td>○</td></tr></table>	P	M	K	N	S	H	●	○	●	○	○	○	<table border="1"><tr><td>P</td><td>M</td><td>K</td><td>N</td><td>S</td><td>H</td></tr><tr><td>●</td><td>○</td><td>●</td><td>○</td><td>○</td><td>○</td></tr></table>	P	M	K	N	S	H	●	○	●	○	○	○	<table border="1"><tr><td>P</td><td>M</td><td>K</td><td>N</td><td>S</td><td>H</td></tr><tr><td>●</td><td>○</td><td>○</td><td>○</td><td>○</td><td>○</td></tr></table>	P	M	K	N	S	H	●	○	○	○	○	○
P	M	K	N	S	H																																																												
●	○	○	○	○	○																																																												
P	M	K	N	S	H																																																												
●	○	●	○	○	○																																																												
P	M	K	N	S	H																																																												
●	○	●	○	○	○																																																												
P	M	K	N	S	H																																																												
●	○	●	○	○	○																																																												
P	M	K	N	S	H																																																												
●	○	○	○	○	○																																																												
Diameter range (mm)	Ø15.7-Ø17.7	Ø21.7-Ø27.7	Ø17.7-Ø27.7	Ø7.7	Ø10.5-Ø25																																																												
Width of cut (mm)	1.5-3.17	0.76-10	3.4-9.8	1-2	1.58-8																																																												
Pages	F41	F42	F43	F43	F44																																																												

● Recommended, ○ Suitable

Tool Selection Guide



Holders for MAXI-RUSH head



	<u>MXSSD</u>	<u>MXSSD-S</u>	<u>MXSSD-C</u>	<u>MXSSD-W-A</u>	<u>MXTSD-S</u>
Series					
Shank Type	Short	Step neck	Step neck	Step neck	Taper neck
Shank material	Steel/Carbide	Steel	Carbide	Tungsten	Steel
Internal coolant	X	●/X	●/X	●	X
Connection size	S04-S15	S05-S15	S05-S15	S06-S12	S04-S15
Shank range (mm)	Ø6-Ø32	Ø8-Ø25	Ø8-Ø25	Ø10-Ø20	Ø8-Ø32
Pages	F45	F46	F47	F48	F49

	<u>MXTSD-C</u>	<u>MXTSD-W-A</u>	<u>MXSTD-S</u>	<u>MXSC-C</u>	
Series					
Shank Type	Taper neck	Taper neck	Straight	Straight	
Shank material	Carbide	Tungsten	Steel	Carbide	
Internal coolant	X	●	X	●/X	
Connection size	S05-S15	S06	S04-S10	S06, S08	
Shank range (mm)	Ø12-Ø32	Ø12-Ø16	Ø6-Ø16	Ø10-Ø12	
Pages	F50	F51	F52	F52	

Tool Selection Guide













Adaptor for MAXI-RUSH head

	MXAD-M	MXER				
Series						
Shank Type	T-FLEXTEC	ER Collet				
Shank material	Steel	Steel				
Internal coolant	X	X				
Connection size	S08	S04-S08				
Shank range (mm)	M8 - M12	ER11 - ER25				
Pages	F53	F54				

Tool Selection Guide

Solid end mill

Series	<i>HARDMILL</i>	<i>SLIKSOLID</i>			<i>APEXMILL</i>																																																																																																																																																																																																								
	HSB 2CBN	UHP 4	UHP 4...R	SCSL	SCSO																																																																																																																																																																																																								
Type	CBN Ball	Flat	Radius	Lens Shape	Oval Shape																																																																																																																																																																																																								
Flute																																																																																																																																																																																																													
Length	Long neck	Medium	Medium	Medium	Medium																																																																																																																																																																																																								
Grades	TB7015	TT5520	TT5520	TT5515	TT5515																																																																																																																																																																																																								
Application	Finishing	General	General	Finishing	Finishing																																																																																																																																																																																																								
Material	<table border="1"><tr><td>P</td><td>M</td><td>K</td><td>N</td><td>S</td><td>H</td><td></td><td></td><td></td><td></td><td></td><td></td><td></td><td></td><td></td><td></td><td></td><td></td><td></td><td></td></tr><tr><td></td><td></td><td></td><td></td><td></td><td>●</td><td>●</td><td></td><td></td><td></td><td></td><td></td><td></td><td></td><td></td><td></td><td></td><td></td><td></td><td></td></tr></table>	P	M	K	N	S	H																				●	●														<table border="1"><tr><td>P</td><td>M</td><td>K</td><td>N</td><td>S</td><td>H</td><td></td><td></td><td></td><td></td><td></td><td></td><td></td><td></td><td></td><td></td><td></td><td></td><td></td><td></td></tr><tr><td></td><td></td><td></td><td></td><td></td><td>●</td><td></td><td></td><td></td><td></td><td></td><td></td><td></td><td></td><td></td><td></td><td></td><td></td><td></td><td></td></tr></table>	P	M	K	N	S	H																				●															<table border="1"><tr><td>P</td><td>M</td><td>K</td><td>N</td><td>S</td><td>H</td><td></td><td></td><td></td><td></td><td></td><td></td><td></td><td></td><td></td><td></td><td></td><td></td><td></td><td></td></tr><tr><td></td><td></td><td></td><td></td><td></td><td>●</td><td>●</td><td></td><td></td><td></td><td></td><td></td><td></td><td></td><td></td><td></td><td></td><td></td><td></td><td></td></tr></table>	P	M	K	N	S	H																				●	●														<table border="1"><tr><td>P</td><td>M</td><td>K</td><td>N</td><td>S</td><td>H</td><td></td><td></td><td></td><td></td><td></td><td></td><td></td><td></td><td></td><td></td><td></td><td></td><td></td><td></td></tr><tr><td></td><td></td><td></td><td></td><td></td><td>●</td><td>●</td><td></td><td></td><td></td><td></td><td></td><td></td><td></td><td></td><td></td><td></td><td></td><td></td><td></td></tr></table>	P	M	K	N	S	H																				●	●														<table border="1"><tr><td>P</td><td>M</td><td>K</td><td>N</td><td>S</td><td>H</td><td></td><td></td><td></td><td></td><td></td><td></td><td></td><td></td><td></td><td></td><td></td><td></td><td></td><td></td></tr><tr><td></td><td></td><td></td><td></td><td></td><td>●</td><td>●</td><td></td><td></td><td></td><td></td><td></td><td></td><td></td><td></td><td></td><td></td><td></td><td></td><td></td></tr></table>	P	M	K	N	S	H																				●	●													
P	M	K	N	S	H																																																																																																																																																																																																								
					●	●																																																																																																																																																																																																							
P	M	K	N	S	H																																																																																																																																																																																																								
					●																																																																																																																																																																																																								
P	M	K	N	S	H																																																																																																																																																																																																								
					●	●																																																																																																																																																																																																							
P	M	K	N	S	H																																																																																																																																																																																																								
					●	●																																																																																																																																																																																																							
P	M	K	N	S	H																																																																																																																																																																																																								
					●	●																																																																																																																																																																																																							
Range	Ø0.4-Ø4	Ø2-Ø25	Ø3-Ø20	Ø8-Ø12	Ø8-Ø12																																																																																																																																																																																																								
Pages	F60	F61	F62	F63	F63																																																																																																																																																																																																								



Series	<i>APEXMILL</i>																																																																																																																																																																																																												
	SCST	HCEM 5	HFM 2	HFM 4	CFM 4...M																																																																																																																																																																																																								
Type	Oval shape	Chamfer 45°	Flat	Flat	Chamfer																																																																																																																																																																																																								
Flute																																																																																																																																																																																																													
Length	Medium	Medium	Medium	Medium	Medium																																																																																																																																																																																																								
Grades	TT5515	TT5525	TT5515	TT5515	TT5525																																																																																																																																																																																																								
Application	Finishing	General	*H.F.M	*H.F.M	General																																																																																																																																																																																																								
Material	<table border="1"><tr><td>P</td><td>M</td><td>K</td><td>N</td><td>S</td><td>H</td><td></td><td></td><td></td><td></td><td></td><td></td><td></td><td></td><td></td><td></td><td></td><td></td><td></td><td></td></tr><tr><td>●</td><td>●</td><td></td><td></td><td></td><td></td><td></td><td></td><td></td><td></td><td></td><td></td><td></td><td></td><td></td><td></td><td></td><td></td><td></td><td></td></tr></table>	P	M	K	N	S	H															●	●																			<table border="1"><tr><td>P</td><td>M</td><td>K</td><td>N</td><td>S</td><td>H</td><td></td><td></td><td></td><td></td><td></td><td></td><td></td><td></td><td></td><td></td><td></td><td></td><td></td><td></td></tr><tr><td>●</td><td>○</td><td>●</td><td></td><td></td><td></td><td>○</td><td></td><td></td><td></td><td></td><td></td><td></td><td></td><td></td><td></td><td></td><td></td><td></td><td></td></tr></table>	P	M	K	N	S	H															●	○	●				○														<table border="1"><tr><td>P</td><td>M</td><td>K</td><td>N</td><td>S</td><td>H</td><td></td><td></td><td></td><td></td><td></td><td></td><td></td><td></td><td></td><td></td><td></td><td></td><td></td><td></td></tr><tr><td>●</td><td></td><td>●</td><td></td><td></td><td></td><td>○</td><td></td><td></td><td></td><td></td><td></td><td></td><td></td><td></td><td></td><td></td><td></td><td></td><td></td></tr></table>	P	M	K	N	S	H															●		●				○														<table border="1"><tr><td>P</td><td>M</td><td>K</td><td>N</td><td>S</td><td>H</td><td></td><td></td><td></td><td></td><td></td><td></td><td></td><td></td><td></td><td></td><td></td><td></td><td></td><td></td></tr><tr><td>●</td><td></td><td>●</td><td></td><td></td><td></td><td>○</td><td></td><td></td><td></td><td></td><td></td><td></td><td></td><td></td><td></td><td></td><td></td><td></td><td></td></tr></table>	P	M	K	N	S	H															●		●				○														<table border="1"><tr><td>P</td><td>M</td><td>K</td><td>N</td><td>S</td><td>H</td><td></td><td></td><td></td><td></td><td></td><td></td><td></td><td></td><td></td><td></td><td></td><td></td><td></td><td></td></tr><tr><td>●</td><td>●</td><td>○</td><td></td><td></td><td></td><td>●</td><td></td><td></td><td></td><td></td><td></td><td></td><td></td><td></td><td></td><td></td><td></td><td></td><td></td></tr></table>	P	M	K	N	S	H															●	●	○				●													
P	M	K	N	S	H																																																																																																																																																																																																								
●	●																																																																																																																																																																																																												
P	M	K	N	S	H																																																																																																																																																																																																								
●	○	●				○																																																																																																																																																																																																							
P	M	K	N	S	H																																																																																																																																																																																																								
●		●				○																																																																																																																																																																																																							
P	M	K	N	S	H																																																																																																																																																																																																								
●		●				○																																																																																																																																																																																																							
P	M	K	N	S	H																																																																																																																																																																																																								
●	●	○				●																																																																																																																																																																																																							
Range	Ø8-Ø12	Ø8-Ø16	Ø4-Ø12	Ø6-Ø12	Ø6-Ø25																																																																																																																																																																																																								
Pages	F64	F65	F66	F66	F67																																																																																																																																																																																																								

* H.F.M: High Feed Machining

● Recommended, ○ Suitable

Tool Selection Guide

Solid end mill













Series	APEX MILL		STAR MILL																																																														
	FSM 4...M	SBT 3...U	SBT 4...U	SED 4																																																													
				SED 4...U	SED 4...UL																																																												
Type	Chamfer	Ball	Ball	Flat	Flat																																																												
Flute																																																																	
Length	Medium	Medium	Medium	Medium	Long																																																												
Grades	TT5525	TT5515	TT5515	TT5515	TT5515																																																												
Application	Roughing+Finishing	Difficult-to-cut	Difficult-to-cut	Difficult-to-cut	Difficult-to-cut																																																												
Material	<table border="1"><tr><th>P</th><th>M</th><th>K</th><th>N</th><th>S</th><th>H</th></tr><tr><td>●</td><td>○</td><td></td><td></td><td></td><td></td></tr></table>	P	M	K	N	S	H	●	○					<table border="1"><tr><th>P</th><th>M</th><th>K</th><th>N</th><th>S</th><th>H</th></tr><tr><td>○</td><td>●</td><td></td><td></td><td></td><td>●</td></tr></table>	P	M	K	N	S	H	○	●				●	<table border="1"><tr><th>P</th><th>M</th><th>K</th><th>N</th><th>S</th><th>H</th></tr><tr><td>○</td><td>●</td><td></td><td></td><td></td><td>●</td></tr></table>	P	M	K	N	S	H	○	●				●	<table border="1"><tr><th>P</th><th>M</th><th>K</th><th>N</th><th>S</th><th>H</th></tr><tr><td>○</td><td>●</td><td></td><td></td><td></td><td>●</td></tr></table>	P	M	K	N	S	H	○	●				●	<table border="1"><tr><th>P</th><th>M</th><th>K</th><th>N</th><th>S</th><th>H</th></tr><tr><td>○</td><td>●</td><td></td><td></td><td></td><td>●</td></tr></table>	P	M	K	N	S	H	○	●				●
P	M	K	N	S	H																																																												
●	○																																																																
P	M	K	N	S	H																																																												
○	●				●																																																												
P	M	K	N	S	H																																																												
○	●				●																																																												
P	M	K	N	S	H																																																												
○	●				●																																																												
P	M	K	N	S	H																																																												
○	●				●																																																												
Range	Ø6-Ø25	Ø4-Ø12	Ø4-Ø12	Ø3-Ø20	Ø3-Ø12																																																												
Pages	F67	F68	F68	F69	F69																																																												

Series	STAR MILL																																																																
	SED 4		SED 7		SER																																																												
	SED 4...-R	SED 4...-C	SED 7	SED 7...N																																																													
Type	Radius	Chamfer	Radius	Radius	Splitter																																																												
Flute																																																																	
Length	Medium	Medium	Medium	Medium	Medium																																																												
Grades	TT5515	TT5515	TT5515	TT5515	TT5525																																																												
Application	Difficult-to-cut	Difficult-to-cut	Difficult-to-cut	Difficult-to-cut	Difficult-to-cut																																																												
Material	<table border="1"><tr><th>P</th><th>M</th><th>K</th><th>N</th><th>S</th><th>H</th></tr><tr><td>○</td><td>●</td><td></td><td></td><td></td><td>●</td></tr></table>	P	M	K	N	S	H	○	●				●	<table border="1"><tr><th>P</th><th>M</th><th>K</th><th>N</th><th>S</th><th>H</th></tr><tr><td>○</td><td>●</td><td></td><td></td><td></td><td>●</td></tr></table>	P	M	K	N	S	H	○	●				●	<table border="1"><tr><th>P</th><th>M</th><th>K</th><th>N</th><th>S</th><th>H</th></tr><tr><td>○</td><td>●</td><td></td><td></td><td></td><td>●</td></tr></table>	P	M	K	N	S	H	○	●				●	<table border="1"><tr><th>P</th><th>M</th><th>K</th><th>N</th><th>S</th><th>H</th></tr><tr><td>○</td><td>●</td><td></td><td></td><td></td><td>●</td></tr></table>	P	M	K	N	S	H	○	●				●	<table border="1"><tr><th>P</th><th>M</th><th>K</th><th>N</th><th>S</th><th>H</th></tr><tr><td>○</td><td>●</td><td></td><td></td><td></td><td>●</td></tr></table>	P	M	K	N	S	H	○	●				●
P	M	K	N	S	H																																																												
○	●				●																																																												
P	M	K	N	S	H																																																												
○	●				●																																																												
P	M	K	N	S	H																																																												
○	●				●																																																												
P	M	K	N	S	H																																																												
○	●				●																																																												
P	M	K	N	S	H																																																												
○	●				●																																																												
Range	Ø2-Ø16	Ø4-Ø12	Ø6-Ø20	Ø6-Ø20	Ø3-Ø20																																																												
Pages	F70	F71	F71	F72	F73																																																												

● Recommended, ○ Suitable

Tool Selection Guide













Solid end mill

Series	ALUMILL			CERAMIC SPEED																																																																										
	AWE 3			CRF 4	CRF 6	CRH 4																																																																								
	AWE 3	AWE 3...ML	AWE 3...ML-R																																																																											
																																																																														
Type	Wave Flat	Wave Flat	Wave Radius	Radius	Radius	Radius																																																																								
Flute																																																																														
Length	Medium	Long	Long	Medium	Medium	Medium																																																																								
Grades	UF10	UF10	UF10	TC3030	TC3030	TC3030																																																																								
Application	Aluminum	Aluminum	Aluminum	*H.S.M	*H.S.M	*H.F.M																																																																								
Material	<table border="1"><tr><td>P</td><td>M</td><td>K</td><td>N</td><td>S</td><td>H</td></tr><tr><td></td><td></td><td></td><td>●</td><td></td><td></td></tr></table>	P	M	K	N	S	H				●			<table border="1"><tr><td>P</td><td>M</td><td>K</td><td>N</td><td>S</td><td>H</td></tr><tr><td></td><td></td><td></td><td>●</td><td></td><td></td></tr></table>	P	M	K	N	S	H				●			<table border="1"><tr><td>P</td><td>M</td><td>K</td><td>N</td><td>S</td><td>H</td></tr><tr><td></td><td></td><td></td><td>●</td><td></td><td></td></tr></table>	P	M	K	N	S	H				●			<table border="1"><tr><td>P</td><td>M</td><td>K</td><td>N</td><td>S</td><td>H</td></tr><tr><td></td><td></td><td></td><td>●</td><td></td><td></td></tr></table>	P	M	K	N	S	H				●			<table border="1"><tr><td>P</td><td>M</td><td>K</td><td>N</td><td>S</td><td>H</td></tr><tr><td></td><td></td><td></td><td>●</td><td></td><td></td></tr></table>	P	M	K	N	S	H				●			<table border="1"><tr><td>P</td><td>M</td><td>K</td><td>N</td><td>S</td><td>H</td></tr><tr><td></td><td></td><td></td><td>●</td><td></td><td></td></tr></table>	P	M	K	N	S	H				●		
P	M	K	N	S	H																																																																									
			●																																																																											
P	M	K	N	S	H																																																																									
			●																																																																											
P	M	K	N	S	H																																																																									
			●																																																																											
P	M	K	N	S	H																																																																									
			●																																																																											
P	M	K	N	S	H																																																																									
			●																																																																											
P	M	K	N	S	H																																																																									
			●																																																																											
Range	Ø6-Ø20	Ø6-Ø20	Ø6-Ø12	Ø6-Ø16	Ø6-Ø16	Ø6-Ø16																																																																								
Pages	F74	F74	F75	F75	F76	F76																																																																								

▶ *H.S.M: High Speed Machining









▶ *H.F.M: High Feed Machining

● Recommended, ○ Suitable

Series	DIA MILL					
	DMB 2	DEB 2		DMR 2	DER 3	
		DEB 2...S	DEB 2...L		DER 3...S	DER 3...L
						
Type	Ball	Ball	Ball	Radius	Radius	Radius
Flute						
Length	Miniature	Short	Long	Medium	Short	Long
Grades	TTD620	TTD620	TTD620	TTD620	TTD620	TTD620
Application	Graphite	Graphite	Graphite	Graphite	Graphite	Graphite
Material	Graphite	Graphite	Graphite	Graphite	Graphite	Graphite
Range	Ø0.6-Ø2	Ø3-Ø12	Ø3-Ø12	Ø0.6-Ø2	Ø3-Ø12	Ø4-Ø12
Pages	F77	F77	F78	F78	F79	F79

Tool Selection Guide

Solid end mill

Series					
	 RRFE	 RCFE	 RCME	 RCDE	 RCOM
Type	Flat	Flat	Flat	Chamfer	Flat
Flute					
Length					
Grades	TTD610	TTD610	TTD610	TTD610	TTD610
Application	Roughing	Roughing	Medium	Drilling + Medium	Finishing
Material	Composite material	Composite material	Composite material	Composite material	Composite material
Range	Ø4-Ø12	Ø4-Ø12	Ø4-Ø12	Ø4-Ø12	Ø6-Ø12
Pages	F80	F80	F81	F81	F82

Series					
	 RDCF				
Type	Flat				
Flute					
Length					
Grades	TTD610				
Application	Finishing				
Material	Composite material				
Range	Ø4-Ø12				
Pages	F82				

Grades

MAXI-RUSH grades

Grades	ISO	Characteristics & applications
TT5513 PVD coated	<div style="display: flex; flex-direction: column; gap: 5px;"> <div style="display: flex; justify-content: space-between;">P10 — P30</div> <div style="display: flex; justify-content: space-between;">K10 — K30</div> </div>	<ul style="list-style-type: none"> • Excellent abrasion resistant with ultra-fine substrate and optimum toughness • Improved anti-chipping and Anti-abrasion PVD AlTiN coated layer • Suitable for mold steels and pre hardened steels
TT5523 PVD coated	<div style="display: flex; flex-direction: column; gap: 5px;"> <div style="display: flex; justify-content: space-between;">P20 — P40</div> <div style="display: flex; justify-content: space-between;">M20 — M40</div> <div style="display: flex; justify-content: space-between;">S20 — S40</div> </div>	<ul style="list-style-type: none"> • High speed milling of steel, stainless steel and high-temp alloy
TT5543 PVD coated	<div style="display: flex; flex-direction: column; gap: 5px;"> <div style="display: flex; justify-content: space-between;">P30 — P50</div> <div style="display: flex; justify-content: space-between;">M30 — M50</div> <div style="display: flex; justify-content: space-between;">S30 — S50</div> </div>	<ul style="list-style-type: none"> • Interrupted and rough machining of steel, stainless steel and high-temp alloy
UF10 Uncoated	<div style="display: flex; flex-direction: column; gap: 5px;"> <div style="display: flex; justify-content: space-between;">P25 — P35</div> <div style="display: flex; justify-content: space-between;">M25 — M35</div> <div style="display: flex; justify-content: space-between;">N25 — N35</div> </div>	<ul style="list-style-type: none"> • General machining of steel, aluminum alloys, non-ferrous materials • Submicron substrate
TTA101 PVD coated	<div style="display: flex; flex-direction: column; gap: 5px;"> <div style="display: flex; justify-content: space-between;">P25 — P35</div> <div style="display: flex; justify-content: space-between;">M25 — M35</div> <div style="display: flex; justify-content: space-between;">N25 — N35</div> </div>	<ul style="list-style-type: none"> • Thin coating (less than 0.5µm) • Sharp edges even after coating • Low friction coefficient: minimizes built-up edges and promotes smooth chip evacuation • Hard coating (above HV 5000) • Oxidation resistance at high temperatures

Grades

Solid end mill grades

Grades	ISO	Characteristics & applications
TT5505 PVD coated	P05 – P25 H05 – H25	<ul style="list-style-type: none"> • High wear and oxidation resistance that delivers exceptional productivity levels • Hardened steel, pre-hardened steel (Hardness < 65 HRC) • High speed machining
TT5515 PVD coated	P10 – P30 M15 – M30 K10 – K30 S10 – S30 H10 – H30	<ul style="list-style-type: none"> • An ultra wear resistant high performance grade covering all ISO ranges • Alloy steel, pre-hardened steel, stainless steel, high-temp alloy (45 < HRC < 55) • Medium to high speed machining
TT5520 PVD coated	P10 – P30 K10 – K30	<ul style="list-style-type: none"> • Anti-abrasion and chipping resistant PVD coated layer • Single direction crystal aligned AlCrN layer <ul style="list-style-type: none"> - Excellent abrasion resistance with sub-micron substrate - Anti-abrasion and oxidation resistant PVD AlCrN coated layer
TT5525 PVD coated	P20 – P40 M20 – M40 S20 – S40	<ul style="list-style-type: none"> • Optimally balanced with wear resistant and anti-chipping properties • General machining of carbon steel, alloy steel, stainless steel, high-temp alloy (< 40 HRC) • Low to medium speed machining
TTD620 Diamond coated	Graphite	<ul style="list-style-type: none"> • High hardness and excellent wear resistance • Machining of graphite
TTD610 Diamond coated	Composite material	<ul style="list-style-type: none"> • Advanced nano diamond coating provides longer tool life and stability of machining • Excellent abrasive wear resistance (Hardness: more Hv 8000) • Machining of composite material
UF10N UF10 Uncoated	P25 – P35 M25 – M35 N25 – N35	<ul style="list-style-type: none"> • General machining of steel, aluminum alloys, non-ferrous materials • Submicron substrate
TC3030 Ceramic	S25 – S35	<ul style="list-style-type: none"> • SiAlON ceramic grade • High speed machining of nickel based super alloys

Selection guide for solid end mill grades

Cutting speed

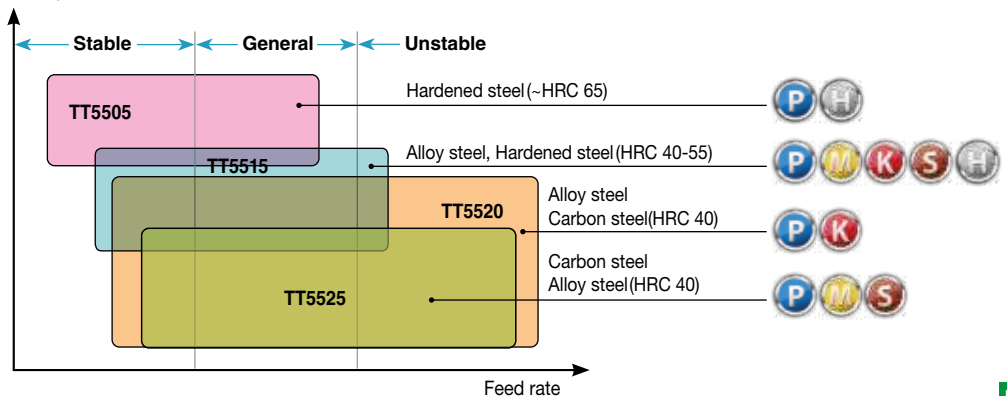

MAXI-RUSH Line



MXEE-03



3 flute, for general purpose

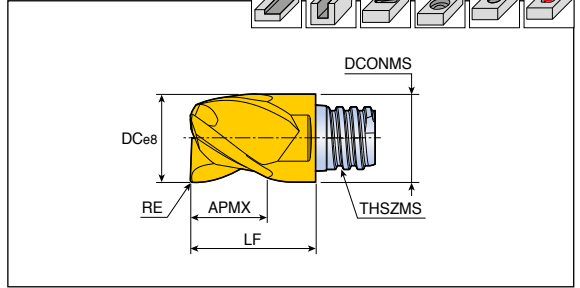
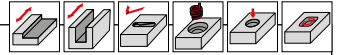

3	H•A 45°	Cutting Condition F56 F55	
----------	--------------------	------------------------------	--

Designation	Feed (mm/tooth)	Dimension (mm)						Grade TT5523
		DC	RE	APMX	LF	THSZMS	DCONMS	
MXEE 080L05R00-03S05	0.03-0.09	8	-	5	10.0	S05	7.7	●
100L07R00-03S06	0.03-0.10	10	-	7	13.0	S06	9.7	●
120L09R00-03S08	0.04-0.11	12	-	9	16.5	S08	11.7	●

► Wrench should be ordered separately ●: Standard items

MXEE(D)-04



4 flute, for general purpose

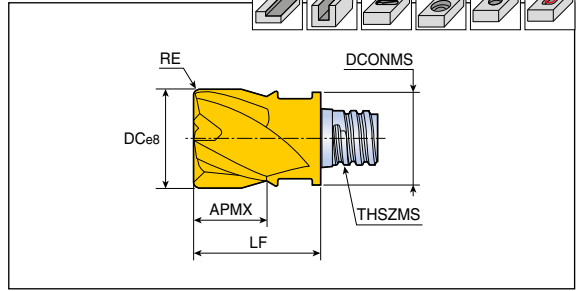
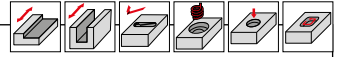

Designation	Feed (mm/tooth)	Dimension (mm)							Grade TT5523
		DC	RE	FHA	APMX	LF	THSZMS	DCONMS	
MXEE 050L04R05-04S04	0.02-0.06	5	0.5	45	4	8.5	S04	6.0	●
MXEE 050L07R00-04S05	0.02-0.06	5	-	45	7	15.0	S05	8.0	●
MXEE 060L04R05-04S04	0.02-0.04	6	0.5	45	4	8.5	S04	5.8	●
MXEE 060L05R00-04S05	0.03-0.04	6	-	45	5	10.0	S05	8.0	●
MXED 080L05R05-04S05	0.03-0.09	8	0.5	30	5	10.0	S05	7.7	●
MXED 080L05R10-04S05	0.03-0.09	8	1.0	30	5	10.0	S05	7.7	●
MXED 080L05R15-04S05	0.03-0.09	8	1.5	30	5	10.0	S05	7.7	●
MXED 080L09R05-04S05	0.03-0.09	8	0.5	30	9	15.0	S05	7.7	●
MXEE 080L05R00-04S05	0.03-0.09	8	-	45	5	10.0	S05	7.7	●
MXEE 080L05R05-04S05	0.03-0.09	8	0.5	45	5	10.0	S05	7.7	●
MXEE 080L05R10-04S05	0.03-0.09	8	1.0	45	5	10.0	S05	7.7	●
MXEE 080L09R00-04S05	0.03-0.09	8	-	45	9	15.0	S05	7.7	●
MXED 100L07R05-04S06	0.03-0.10	10	0.5	30	7	13.0	S06	9.6	●
MXED 100L07R10-04S06	0.03-0.10	10	1.0	30	7	13.0	S06	9.6	●
MXEE 100L07R00-04S06	0.03-0.10	10	-	45	7	13.0	S06	9.6	●
MXEE 100L07R05-04S06	0.03-0.10	10	0.5	45	7	13.0	S06	9.6	●
MXEE 100L07R10-04S06	0.03-0.10	10	1.0	45	7	13.0	S06	9.6	●
MXEE 100L12R00-04S06	0.03-0.10	10	-	45	12	19.0	S06	9.6	●
MXED 120L09R05-04S08	0.04-0.11	12	0.5	30	9	16.5	S08	11.7	●
MXED 120L09R10-04S08	0.04-0.11	12	1.0	30	9	16.5	S08	11.7	●
MXEE 120L09R00-04S08	0.04-0.11	12	-	45	9	16.5	S08	11.7	●
MXEE 120L09R05-04S08	0.04-0.11	12	0.5	45	9	16.5	S08	11.7	●
MXEE 120L09R10-04S08	0.04-0.11	12	1.0	45	9	16.5	S08	11.7	●
MXEE 120L14R00-04S08	0.04-0.11	12	-	45	14	23.0	S08	11.7	●
MXED 160L12R05-04S10	0.05-0.13	16	0.5	30	12	20.5	S10	15.3	●
MXED 160L12R10-04S10	0.05-0.13	16	1.0	30	12	20.5	S10	15.3	●
MXED 160L12R15-04S10	0.05-0.13	16	1.5	30	12	20.5	S10	15.3	●
MXED 160L12R20-04S10	0.05-0.13	16	2.0	30	12	20.5	S10	15.3	●
MXED 160L12R30-04S10	0.05-0.13	16	3.0	30	12	20.5	S10	15.3	●
MXED 160L12R40-04S10	0.05-0.13	16	4.0	30	12	20.5	S10	15.3	●
MXEE 160L12R00-04S10	0.05-0.13	16	-	45	12	20.5	S10	15.3	●
MXEE 160L12R05-04S10	0.05-0.13	16	0.5	45	12	20.5	S10	15.3	●
MXEE 160L12R10-04S10	0.05-0.13	16	1.0	45	12	20.5	S10	15.3	●
MXEE 160L12R15-04S10	0.05-0.13	16	1.5	45	12	20.5	S10	15.3	●
MXEE 160L12R20-04S10	0.05-0.13	16	2.0	45	12	20.5	S10	15.3	●

- ▶ Wrench should be ordered separately
- ▶ FHA: Flute helix angle

●: Standard items

MXEE(D)-04

4 flute, for general purpose

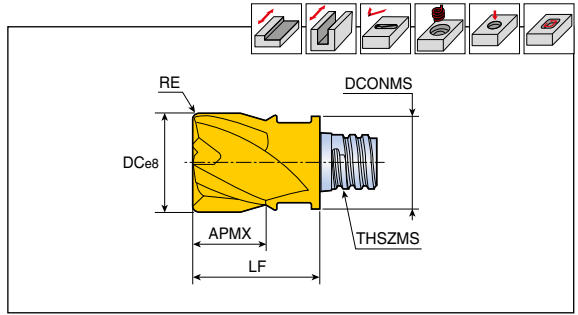

Designation	Feed (mm/tooth)	Dimension (mm)								Grade TT5523
		DC	RE	FHA	APMX	LF	THSZMS	DCONMS		
MXEE 160L12R30-04S10	0.05-0.13	16	3.0	45	12	20.5	S10	15.3	●	
MXEE 160L12R40-04S10	0.05-0.13	16	4.0	45	12	20.5	S10	15.3	●	
MXED 200L15R05-04S12	0.05-0.13	20	0.5	30	15	25.5	S12	18.3	●	
MXED 200L15R10-04S12	0.05-0.13	20	1.0	30	15	25.5	S12	18.3	●	
MXED 200L15R20-04S12	0.05-0.13	20	2.0	30	15	25.5	S12	18.3	●	
MXED 200L15R30-04S12	0.05-0.13	20	3.0	30	15	25.5	S12	18.3	●	
MXEE 200L15R00-04S12	0.05-0.13	20	-	45	15	25.5	S12	18.3	●	

- ▶ Wrench should be ordered separately
- ▶ FHA: Flute helix angle
- : Standard items

MXEE-03

3 flute, for keyways

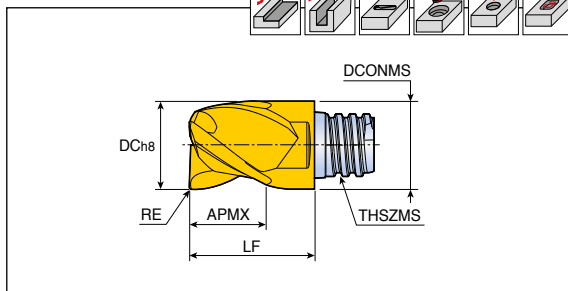
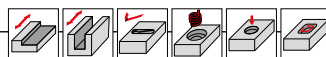

Designation	Feed (mm/tooth)	Dimension (mm)						Grade
		DC	RE	APMX	LF	THSZMS	DCONMS	
MXEE 077L04R02-03S05	0.03-0.08	7.7	0.2	4	10.0	S05	7.7	●
097L05R03-03S06	0.03-0.09	9.7	0.3	5	13.0	S06	9.7	●
117L07R03-03S08	0.03-0.10	11.7	0.3	7	16.5	S08	11.7	●
157L08R03-03S10	0.04-0.12	15.7	0.3	8	20.5	S10	15.3	●
197L12R04-03S12	0.05-0.13	19.7	0.4	12	25.5	S12	18.3	●

► Wrench should be ordered separately

●: Standard items

MXEE-104

4 flute, unequal spacing of cutting edges (vibration free)

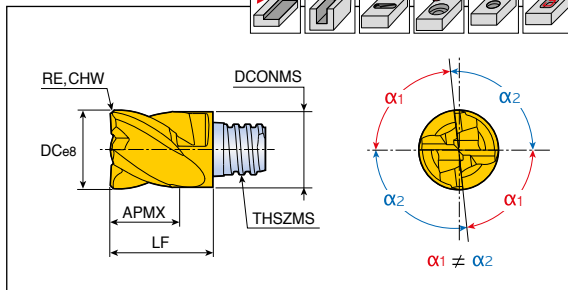
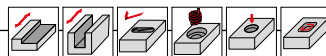

Designation	Feed (mm/tooth)	Dimension (mm)							Grade
		DC	RE	CHW	APMX	LF	THSZMS	DCONMS	
MXEE 080L05C30I04S05	0.03-0.09	8	-	0.3	5	10.0	S05	7.7	●
100L07C40I04S06	0.03-0.10	10	-	0.4	7	13.0	S06	9.7	●
120L09C50I04S08	0.04-0.11	12	-	0.5	9	16.5	S08	11.7	●
160L12C60I04S10	0.05-0.13	16	-	0.6	12	20.5	S10	15.3	●
200L15C60I04S12	0.05-0.17	20	-	0.6	15	25.5	S12	18.3	●
250L22C60I04S15	0.06-0.17	25	-	0.6	22	37.0	S15	23.9	●
250L22R00I04S15	0.06-0.17	25	-	-	22	37.0	S15	23.9	●
250L22R05I04S15	0.06-0.17	25	0.5	-	22	37.0	S15	23.9	●
250L22R10I04S15	0.06-0.17	25	1.0	-	22	37.0	S15	23.9	●
250L22R20I04S15	0.06-0.17	25	2.0	-	22	37.0	S15	23.9	●
250L22R30I04S15	0.06-0.17	25	3.0	-	22	37.0	S15	23.9	●

► Wrench should be ordered separately

●: Standard items

MXES-R



4 flute, unequal space & variable helix cutting edges

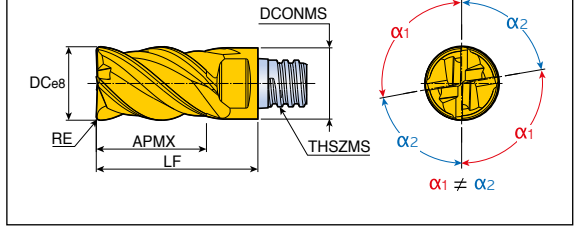
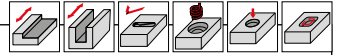

4	H-A 45°	Cutting Condition F56	F55
---	---------	-----------------------	-----

Designation	Feed (mm/tooth)	Dimension (mm)						Grade
		DC	RE	APMX	LF	THSZMS	DCONMS	TT5523
MXES 080H05R05I04S05	0.03-0.09	8	0.5	5	10.0	S05	7.7	●
080H12R05I04S05	0.03-0.08	8	0.5	12	18.0	S05	7.7	●
100H07R05I04S06	0.03-0.10	10	0.5	7	13.0	S06	9.7	●
100H15R05I04S06	0.03-0.09	10	0.5	15	22.0	S06	9.7	●
120H09R05I04S08	0.04-0.11	12	0.5	9	16.5	S08	11.7	●
120H18R05I04S08	0.04-0.10	12	0.5	18	27.0	S08	11.7	●
160H12R05I04S10	0.05-0.13	16	0.5	12	20.5	S10	15.3	●
160H24R05I04S10	0.04-0.10	16	0.5	24	33.5	S10	15.3	●
200H15R05I04S12	0.05-0.17	20	0.5	15	25.5	S12	18.5	●
200H30R05I04S12	0.05-0.11	20	0.5	30	41.0	S12	18.5	●
250H22R05I04S15	0.06-0.17	25	0.5	22	37.0	S15	23.9	●
250H37R05I04S15	0.05-0.12	25	0.5	37	52.5	S15	23.9	●

Wrench should be ordered separately ●: Standard items



MXEE-R



4-6 flute, for roughing

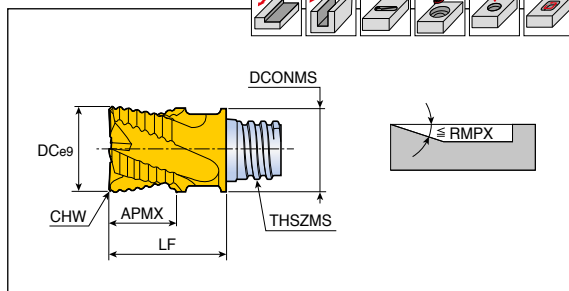
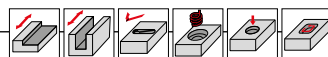

Designation	Feed (mm/tooth)	Dimension (mm)								Grade
		DC	NOF	CHW	APMX	LF	THSZMS	DCONMS	RMPX	
MXEE 080L05C25R04S05	0.03-0.08	8	4	0.25	5	10.0	S05	7.7	5	●
100L07C30R04S06	0.03-0.09	10	4	0.30	7	13.0	S06	9.7	5	●
120L09C35R04S08	0.04-0.10	12	4	0.35	9	16.5	S08	11.7	5	●
160L12C40R05S10	0.04-0.10	16	5	0.40	12	20.5	S10	15.3	5	●
200L15C40R06S12	0.05-0.11	20	6	0.40	15	25.5	S12	18.3	3	●
250L22C50R06S15	0.05-0.11	25	6	0.50	22	37.0	S15	23.9	3	●

- ▶ Wrench should be ordered separately
- ▶ NOF: Number of flutes
- ▶ RMPX: Ramping angle maximum

●: Standard items

MXEE-R-1.5D



4-6 flute, for roughing with 1.5D flute length

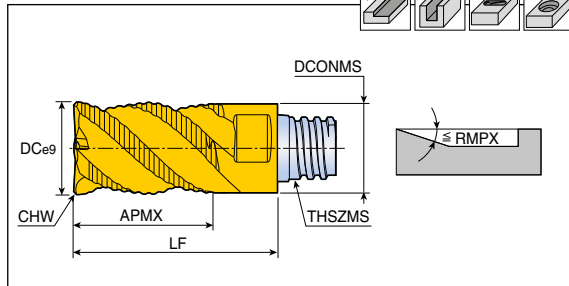
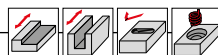

Designation	Feed (mm/tooth)	Dimension (mm)								Grade
		DC	NOF	CHW	APMX	LF	THSZMS	DCONMS	RMPX	
MXEE 080L12C25R04S05	0.03-0.08	8	4	0.25	12	18.0	S05	7.7	5	●
100L15C30R04S06	0.03-0.09	10	4	0.30	15	22.0	S06	9.6	5	●
120L18C35R04S08	0.04-0.10	12	4	0.35	18	27.0	S08	11.7	5	●
160L24C40R05S10	0.04-0.10	16	5	0.40	24	33.5	S10	15.3	5	●
200L30C40R06S12	0.05-0.11	20	6	0.40	30	41.0	S12	18.5	3	●

- ▶ Wrench should be ordered separately
- ▶ NOF: Number of flutes
- ▶ RMPX: Ramping angle maximum

●: Standard items

MXEE-C04



4 flute, combined edges for roughing & finishing

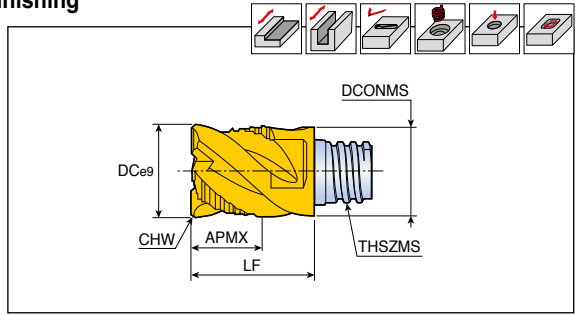

Designation	Feed (mm/tooth)	Dimension (mm)						Grade	
		DC	CHW	APMX	LF	THSZMS	DCONMS	TT5523	
MXEE 080L05C30C04S05	0.03-0.08	8	0.3	5	10.0	S05	7.7	●	
100L07C30C04S06	0.03-0.09	10	0.3	7	13.0	S06	9.7	●	
120L09C40C04S08	0.04-0.10	12	0.4	9	16.5	S08	11.7	●	
160L12C60C04S10	0.05-0.11	16	0.6	12	20.5	S10	15.3	●	
200L15C60C04S12	0.05-0.11	20	0.6	15	25.5	S12	18.3	●	
250L22C60C04S15	0.05-0.11	25	0.6	22	37.0	S15	23.9	●	

► Wrench should be ordered separately

●: Standard items

MXEE-A02



2 flute, for aluminum machining

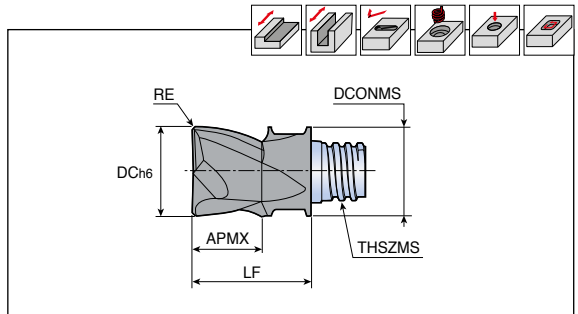

Designation	Feed (mm/tooth)	Dimension (mm)						Grade	
		DC	RE	APMX	LF	THSZMS	DCONMS	UF10	TTA101
MXEE 100L07R05A02S06	0.03-0.10	10	0.5	7	13.0	S06	9.7	●	●
100L07R10A02S06	0.03-0.10	10	1.0	7	13.0	S06	9.7	●	●
120L09R05A02S08	0.04-0.11	12	0.5	9	16.5	S08	11.7	●	●

► Wrench should be ordered separately

●: Standard items

MXEE-A03

3 flute, for aluminum machining

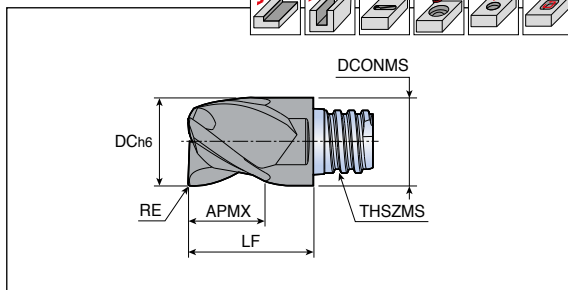
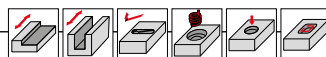

Designation	Feed (mm/tooth)	Dimension (mm)						Grade	
		DC	RE	APMX	LF	THSZMS	DCONMS	UF10	TTA101
MXEE 080L05R05A03S05	0.03-0.09	8	0.5	5	10.0	S05	7.7	●	●
100L06R05A03S06	0.03-0.10	10	0.5	6	13.0	S06	9.7	●	●
100L06R10A03S06	0.03-0.10	10	1.0	6	13.0	S06	9.7	●	●
120L08R05A03S08	0.04-0.11	12	0.5	8	16.5	S08	11.7	●	●
120L08R10A03S08	0.04-0.11	12	1.0	8	16.5	S08	11.7	●	●
160L10R00A03S10	0.05-0.13	16	-	10	20.5	S10	15.3	●	●
160L10R10A03S10	0.05-0.13	16	1.0	10	20.5	S10	15.3	●	●
160L10R20A03S10	0.05-0.13	16	2.0	10	20.5	S10	15.3	●	●
200L12R05A03S12	0.05-0.13	20	0.5	12	25.5	S12	18.3	●	●
200L12R10A03S12	0.05-0.13	20	1.0	12	25.5	S12	18.3	●	●
200L12R20A03S12	0.05-0.13	20	2.0	12	25.5	S12	18.3	●	●

► Wrench should be ordered separately

● Standard items

MXEE-RA03

3 flute, for roughing with aluminum machining

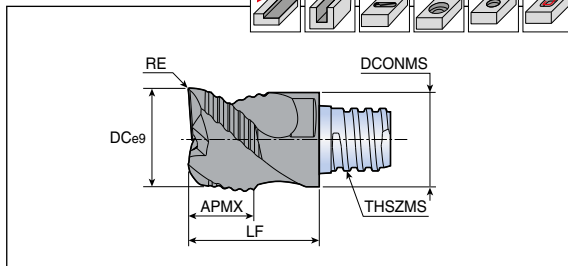
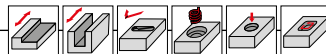

Designation	Feed (mm/tooth)	Dimension (mm)						Grade
		DC	RE	APMX	LF	THSZMS	DCONMS	UF10
MXEE 080L05R02RA03S05	0.03-0.15	8	0.2	5	10.0	S05	7.7	●
100L06R02RA03S06	0.05-0.20	10	0.2	6	13.0	S06	9.6	●
120L08R02RA03S08	0.07-0.22	12	0.2	8	16.5	S08	11.7	●
160L10R02RA03S10	0.07-0.25	16	0.2	10	20.5	S10	15.3	●
200L12R02RA03S12	0.07-0.25	20	0.2	12	25.5	S12	18.5	●

► Wrench should be ordered separately

● Standard items

MXEE(D)-06



6 flute, for difficult-to-cut material machining without central edge

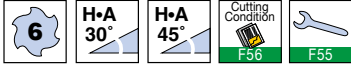
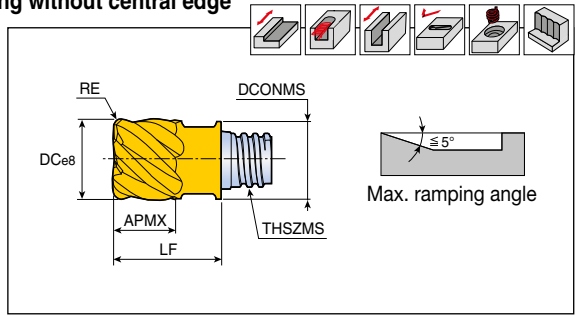

Designation	Feed (mm/tooth)	Dimension (mm)							Grade
		DC	RE	FHA	APMX	LF	THSZMS	DCONMS	
MXEE 080L05R05-06S05	0.03-0.10	8	0.5	45	5	10.0	S05	7.7	●
MXEE 080L05R10-06S05	0.03-0.10	8	1.0	45	5	10.0	S05	7.7	●
MXED 100L07R05-06S06	0.03-0.10	10	0.5	30	7	13.0	S06	9.7	●
MXED 100L07R10-06S06	0.03-0.10	10	1.0	30	7	13.0	S06	9.7	●
MXEE 100L07R05-06S06	0.04-0.10	10	0.5	45	7	13.0	S06	9.7	●
MXEE 100L07R10-06S06	0.04-0.10	10	1.0	45	7	13.0	S06	9.7	●
MXEE 100L07R15-06S06	0.03-0.10	10	1.5	45	7	13.0	S06	9.7	●
MXED 120L09R05-06S08	0.04-0.11	12	0.5	30	9	16.5	S08	11.7	●
MXEE 120L09R00-06S08	0.04-0.11	12	-	45	9	16.5	S08	11.7	●
MXEE 120L09R10-06S08	0.04-0.11	12	1.0	45	9	16.5	S08	11.7	●
MXEE 120L09R15-06S08	0.04-0.11	12	1.5	45	9	16.5	S08	11.7	●

- ▶ Wrench should be ordered separately
- ▶ FHA: Flute Helix Angle

●: Standard items

MXED-08/10



8, 10 flute, for difficult-to-cut material machining without central edge

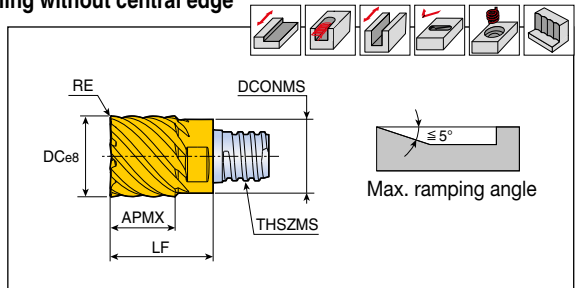

Designation	Feed (mm/tooth)	Dimension (mm)							Grade
		DC	NOF	RE	APMX	LF	THSZMS	DCONMS	
MXED 160L12R05-08S10	0.05-0.13	16	8	0.5	12	20.5	S10	15.3	●
160L12R10-08S10	0.05-0.13	16	8	1.0	12	20.5	S10	15.3	●
160L12R20-08S10	0.05-0.13	16	8	2.0	12	20.5	S10	15.3	●
200L15R10-10S12	0.05-0.13	20	10	1.0	15	25.5	S12	18.3	●
200L15R20-10S12	0.05-0.13	20	10	2.0	15	25.5	S12	18.3	●
250L22R10-10S15	0.05-0.13	25	10	1.0	22	37.0	S15	23.9	●
250L22R20-10S15	0.05-0.13	25	10	2.0	22	37.0	S15	23.9	●

- ▶ Wrench should be ordered separately
- ▶ NOF: Number of flutes

●: Standard items

MXED-I07/I09-1.5D



Long cutting edge 1.5D & 7,9 flutes & variable helix, pitch

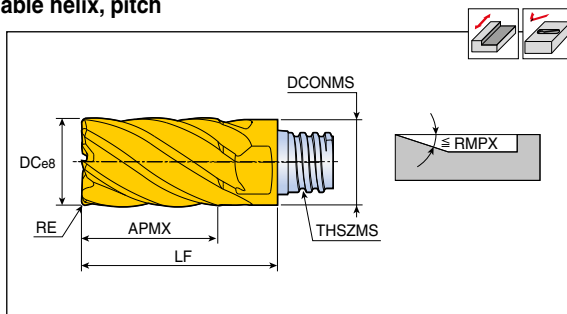

Designation	Feed (mm/tooth)	Dimension (mm)									Grade
		DC	NOF	RE	APMX	LF	THSZMS	DCONMS	RMPX	TT5523	
MXED 100L15R05I07S06	0.04-0.10	10	7	0.5	15	22.0	S06	9.6	3	●	
120L18R05I07S08	0.04-0.10	12	7	0.5	18	27.0	S08	11.7	3	●	
160L24R08I09S10	0.05-0.10	16	9	0.8	24	33.5	S10	15.3	1	●	
200L30R10I09S12	0.05-0.10	20	9	1.0	30	41.0	S12	18.5	1	●	

- ▶ Wrench should be ordered separately
- ▶ NOF: Number of flutes
- ▶ RMPX: Ramping angle maximum

●: Standard items

MXRB-02



2 flute, 7° back taper flute

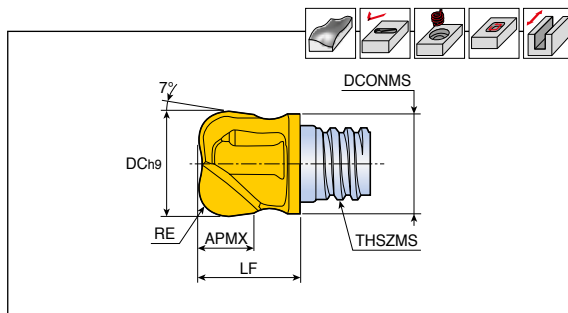

Designation	Feed (mm/tooth)	Dimension (mm)							Grade
		DC	RE	APMX	LF	THSZMS	DCONMS	TT5523	
MXRB 200L11R50-02S12	0.05-0.15	20	5.0	11.3	17.3	S12	18.3	●	

- ▶ Wrench should be ordered separately

●: Standard items

MXRD-06



6 flute, 7° back taper sided ground flute

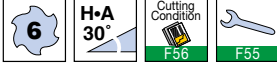
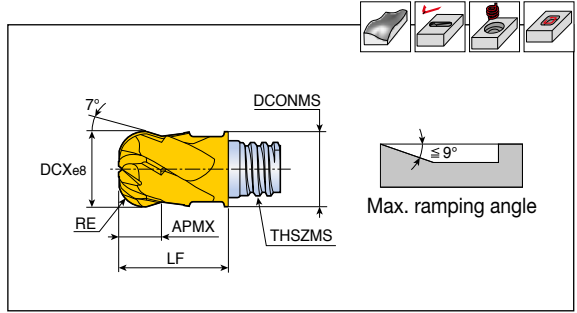

Designation	Dimension (mm)						Grade
	DCX	RE	APMX	LF	THSZMS	DCONMS	
MXRD 080L04R20-06S05	8	2.0	4	10.0	S05	7.7	●
100L05R30-06S06	10	3.0	5	13.0	S06	9.7	●
120L07R40-06S08	12	4.0	7	16.5	S08	11.7	●
160L09R50-06S10	16	5.0	9	20.5	S10	15.3	●

► Wrench should be ordered separately

●: Standard items

MXFX-02



2 flute, for high feed milling

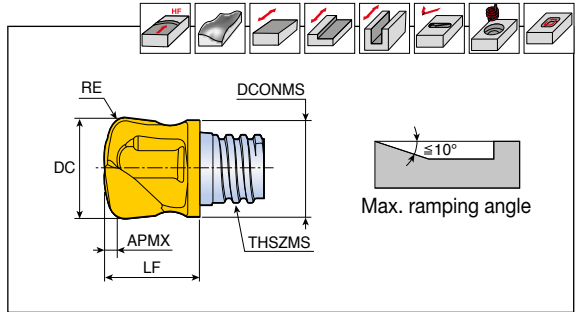

Designation	Feed (mm/tooth)	Dimension (mm)						Grade
		DC	RE	APMX	LF	THSZMS	DCONMS	
MXFX 100L0.6R20-02S06	0.30-0.60	10	2.0	0.6	12.5	S06	9.6	●
120L1.0R25-02S08	0.50-1.00	12	2.5	0.68	11.1	S08	11.5	●
160L1.1R30-02S10	0.55-1.10	16	3.0	1.1	20.0	S10	15.2	●
200L1.5R34-02S12	0.75-1.50	20	3.4	1.5	17.4	S12	18.3	●

► Wrench should be ordered separately

●: Standard items

MXFX-04/06



4,6 flute, for high feed machining and small D.O.C

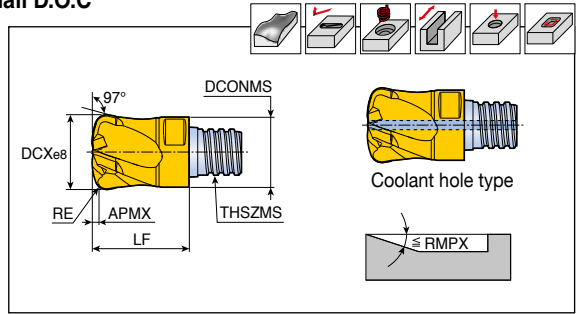

Designation	Feed (mm/tooth)	Dimension (mm)									Coolant hole	Grade	
		DC	NOF	RE	APMX	LF	THSZMS	DCONMS	RMPX	TT5513		TT5523	
MXFX 080L0.4R16-04S05	0.12-0.48	8	4	1.62	0.4	10.0	S05	7.5	5	x	●		
100L0.5R20-04S06	0.16-0.57	10	4	2.01	0.5	13.0	S06	9.5	5	x	●		
100L0.4R10-06S06C	0.16-0.47	10	6	1.00	0.45	10.0	S06	9.5	3	●	●		
120L0.6R18-04S08C	0.16-0.67	12	4	1.80	0.6	16.5	S08	11.5	5	●		●	
120L0.6R24-04S08	0.16-0.67	12	4	2.47	0.6	16.5	S08	11.5	5	x	●		
120L0.6R12-06S08C	0.16-0.54	12	6	1.20	0.65	12.0	S08	11.5	3	●	●		
160L0.8R22-04S10C	0.20-0.75	16	4	2.20	0.8	20.5	S10	15.4	5	●		●	
160L0.8R32-04S10	0.20-0.75	16	4	3.25	0.8	20.5	S10	15.4	5	x	●		
200L1.0R40-04S12	0.20-0.90	20	4	4.02	1.0	25.5	S12	18.45	5	x	●		
250L1.2R31-06S15	0.25-1.00	25	6	3.10	1.2	25.0	S15	23.9	5	x	●		

- ▶ Wrench should be ordered separately
- ▶ NOF: Number of flutes
- ▶ RMPX: Ramping angle maximum

●: Standard items

MXBD-BG-02



2 flute, for high precision machining

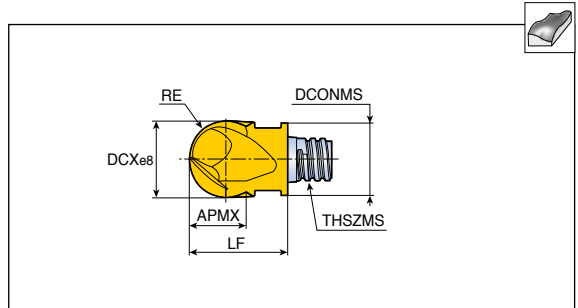

Designation	Dimension (mm)						Grade
	DCX	RE	APMX	LF	THSZMS	DCONMS	TT5523
MXBD 080L05-BG-02S05	8	3.98 ⁽¹⁾	5	10.0	S05	7.7	●
100L07-BG-02S06	10	4.98 ⁽¹⁾	7	13.0	S06	9.7	●
120L09-BG-02S08	12	5.98 ⁽²⁾	9	16.5	S08	11.7	●
160L09-BG-02S10	16	7.98 ⁽²⁾	9	20.5	S10	15.3	●

- ▶ Wrench should be ordered separately
- ▶ RE Tolerance: ⁽¹⁾± 0.01, ⁽²⁾± 0.012

●: Standard items

MXBD(E)-BG-04



4 flute, for high precision machining

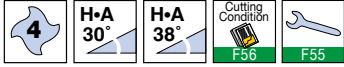
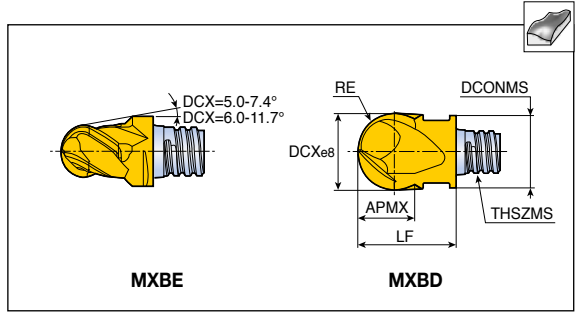

Designation	Dimension (mm)							Grade
	DCX	RE	FHA	APMX	LF	THSZMS	DCONMS	
MXBE 050L07-BG-04S05	5	2.49 ⁽¹⁾	38	7.0	15.0	S05	8.0	●
060L04-BG-04S04	6	2.99 ⁽¹⁾	38	4.0	8.5	S04	5.8	●
060L05-BG-04S05	6	2.99 ⁽¹⁾	38	5.5	10.0	S05	8.0	●
MXBD 080L05-BG-04S05	8	3.98 ⁽¹⁾	30	5.0	10.0	S05	7.7	●
100L07-BG-04S06	10	4.98 ⁽¹⁾	30	7.0	13.0	S06	9.7	●
120L09-BG-04S08	12	5.98 ⁽²⁾	30	9.0	16.5	S08	11.7	●
160L12-BG-04S10	16	7.98 ⁽²⁾	30	12.0	20.5	S10	15.3	●
200L15-BG-04S12	20	9.97 ⁽²⁾	30	15.0	25.5	S12	18.3	●
250L22-BG-04S15	25	12.47 ⁽³⁾	30	22.0	37.0	S15	23.9	●

- ▶ Wrench should be ordered separately
- ▶ RE Tolerance: ⁽¹⁾± 0.01, ⁽²⁾± 0.012, ⁽³⁾± 0.02
- ▶ FHA: Flute helix angle

●: Standard items

MXBE-BH-04



4 flute, for high productivity on hard material

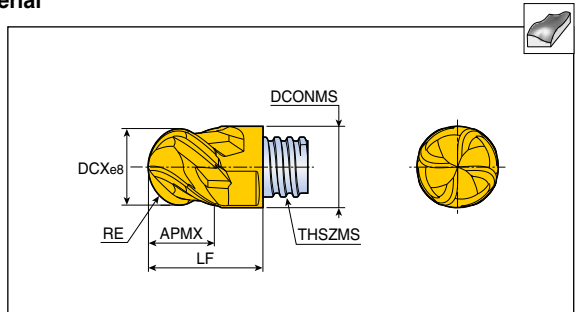

Designation	Dimension (mm)						Grade
	DCX	RE	APMX	LF	THSZMS	DCONMS	
MXBE 080L05-BH-04S05	8	3.98 ⁽¹⁾	5.4	10.0	S05	7.7	●
100L07-BH-04S06	10	4.98 ⁽¹⁾	7.4	13.0	S06	9.6	●
120L09-BH-04S08	12	5.98 ⁽²⁾	9.3	16.5	S08	11.7	●
160L12-BH-04S10	16	7.98 ⁽²⁾	12.4	20.5	S10	15.3	●
200L16-BH-04S12	20	9.97 ⁽²⁾	16.0	25.5	S12	18.5	●

- ▶ Wrench should be ordered separately
- ▶ RE Tolerance: ⁽¹⁾± 0.01, ⁽²⁾± 0.012

●: Standard items

MXBB-SG-02



2 flute, spherical designed edge

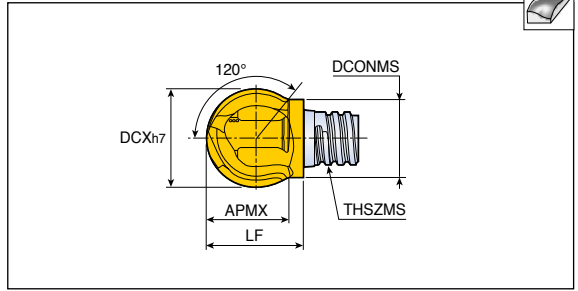

Designation	Dimension (mm)					Key	Grade TT5523
	DCX	APMX	LF	THSZMS	DCONMS		
MXBB 080L05-SG-02S04	8	5	8.2	S04	5.8	MX KEY-S04	●
100L07-SG-02S05	10	7	10.0	S05	7.6	MX KEY-S05	●
120L09-SG-02S06	12	9	11.6	S06	9.5	MX KEY-S08	●
160L12-SG-02S08	16	12	15.4	S08	12.2	MX KEY-S10	●
200L15-SG-02S10	20	15	18.4	S10	15.2	MX KEY-S10	●
250L18-SG-02S12	25	18	23.2	S12	18.3	MX KEY-S12	●

► Wrench should be ordered separately

● Standard items

MXBE-BGA02



2 flute, for high precision aluminum machining

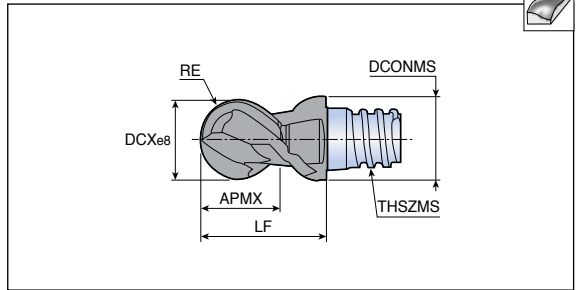

Designation	Dimension (mm)						Grade	
	DCX	RE	APMX	LF	THSZMS	DCONMS	UF10	TTA101
MXBE 080L05-BGA02S05	8	3.98 ⁽¹⁾	5	10.0	S05	7.7	●	●
100L07-BGA02S06	10	4.98 ⁽¹⁾	7	13.0	S06	9.7	●	●
120L09-BGA02S08	12	5.98 ⁽²⁾	9	16.5	S08	11.7	●	●
160L12-BGA02S10	16	7.98 ⁽²⁾	12	20.5	S10	15.3	●	●
200L15-BGA02S12	20	9.97 ⁽²⁾	15	25.5	S12	18.3	●	●

► Wrench should be ordered separately

● Standard items

► RE Tolerance: ⁽¹⁾± 0.01, ⁽²⁾± 0.012

MXCP-02



2 flute, for spot drilling, chamfering and countersinking

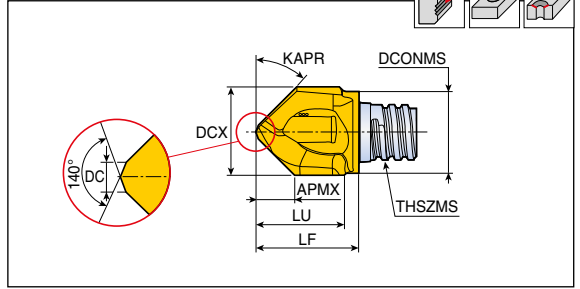
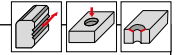

Designation	Dimension (mm)									Grade
	KAPR	DCX	DCXTOL	DC	APMX	LU	LF	THSZMS	DCONMS	
MXCP 100L09A30-02S06	30	10.0	h10	1.5	7.5	8.5	11.75	S06	9.5	●
120L12A30-02S08	30	12.0	h10	1.5	9.2	11.0	15.4	S08	11.5	●
160L15A30-02S10	30	16.0	h10	2.5	12	16.0	20.2	S10	15.2	●
MXCP 080L07A45-02S05	45	8.0	z9	1.0	3.7	7.5	9.75	S05	7.6	●
083L07A45-02S05	45	8.3	z9	1.0	3.8	7.5	10.0	S05	7.6	●
100L09A45-02S06	45	10.0	z9	1.5	4.4	9.5	11.75	S06	9.5	●
104L09A45-02S06	45	10.4	z9	1.5	4.6	9.5	11.75	S06	9.5	●
120L12A45-02S08	45	12.0	z9	1.5	5.4	11.5	15.4	S08	11.5	●
124L12A45-02S08	45	12.4	z9	1.5	5.6	11.5	15.4	S08	11.5	●
160L15A45-02S10	45	16.0	z9	1.5	7.1	15.0	18.8	S10	15.2	●
165L15A45-02S10	45	16.5	z9	1.5	7.1	15.0	18.8	S10	15.2	●
MXCP 100L09A60-02S06	60	10.0	h10	1.5	2.7	9.5	12.7	S06	9.5	●
120L12A60-02S08	60	12.0	h10	1.5	3.3	11.5	15.2	S08	11.5	●
160L15A60-02S10	60	16.0	h10	1.5	4.4	16.0	19.9	S10	15.2	●

▶ Wrench should be ordered separately

●: Standard items



MXCA-04 / 06



4, 6 flute, chamfering and countersinking without central edge

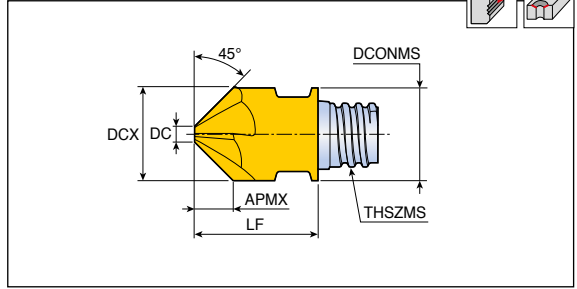

Designation	Dimension (mm)							Grade
	DCX	DC	NOF	APMX	LF	THSZMS	DCONMS	
MXCA 100L04A45-04S06	10.0	1.95	4	4.0	13.0	S06	10.0	●
120L05A45-04S08	12.0	1.95	4	5.0	16.5	S08	12.0	●
127L05A45-04S08	12.7	1.98	4	5.3	16.5	S08	12.7	●
160L06A45-06S10	16.0	3.0	6	6.5	20.3	S10	16.0	●
200L07A45-06S12	20.0	5.0	6	7.5	25.5	S12	20.0	●

- ▶ Wrench should be ordered separately
- ▶ NOF: Number of flutes

●: Standard items

MXCW-02



2 flute, for double chamfering

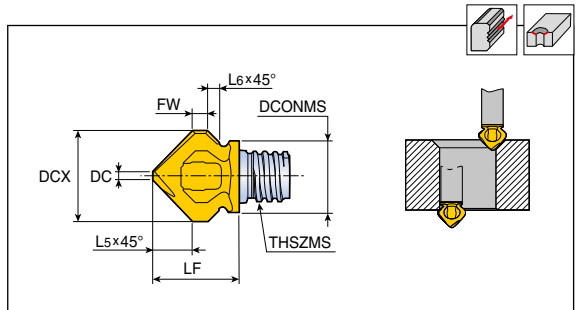

Designation	Dimension (mm)								Key	Grade
	DCX	DC	L5	LF	FW	L6	THSZMS	DCONMS		
MXCW 098L04A45-02S05	9.8	1.2	4.3	10.8	2.5	1.2	S05	7.6	MX KEY-S06	●
118L05A45-02S06	11.8	1.2	5.3	11.2	2.0	1.2	S06	9.3	MX KEY-S08	●
157L07A45-02S08	15.7	1.5	7.1	14.0	2.0	1.2	S08	11.5	MX KEY-S10	●

- ▶ Wrench should be ordered separately

●: Standard items

MXCR-02



2 flute, for concave radius milling

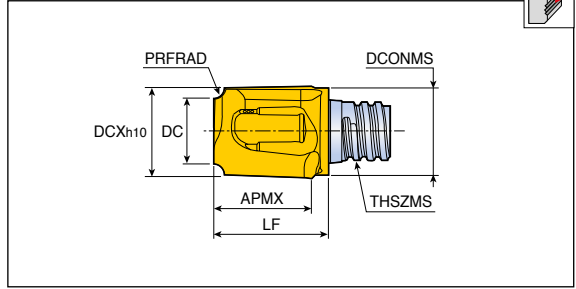

Designation	Feed (mm/tooth)	Dimension (mm)							Grade
		DCX	DC	PRFRAD	APMX	LF	THSZMS	DCONMS	
MXCR 080L07R10-02S05	0.03-0.08	8.0	5.8	1.0	7.5	10.5	S05	7.6	●
100L09R16-02S06	0.04-0.09	10.0	6.8	1.6	9.5	12.5	S06	9.5	●
100L09R25-02S06	0.04-0.09	10.0	5.1	2.5	9.5	12.5	S06	9.5	●
127L12R30-02S08	0.04-0.11	12.7	6.5	3.0	12.0	15.6	S08	12.2	●
127L12R40-02S08	0.04-0.11	12.7	4.7	4.0	12.0	15.6	S08	12.2	●
160L15R50-02S10	0.04-0.13	16.0	6.2	5.0	15.0	19.1	S10	15.2	●
200L07R60-02S12	0.05-0.15	20.0	8.0	6.0	7.0	17.4	S12	18.3	●

► Wrench should be ordered separately
 ► PRFRAD: Profile radius

●: Standard items

MXCS-04



4 flute, for chamfering

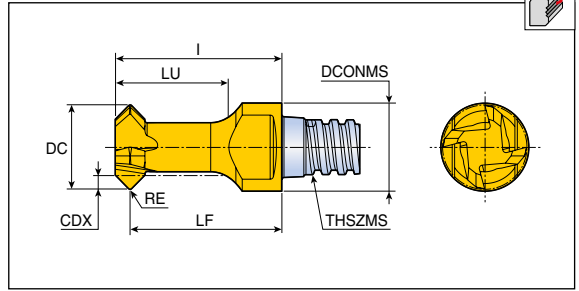

Designation	Dimension (mm)								Grade
	DC	CDX	RE	LF	LU	I	THSZMS	DCONMS	TT5523
MXCS 077L10A45-04S05	7.7	1.2	0.2	13.9	10.2	15.2	S05	8.0	●

► Wrench should be ordered separately

●: Standard items

MXDP-02



2 flute, for center drilling

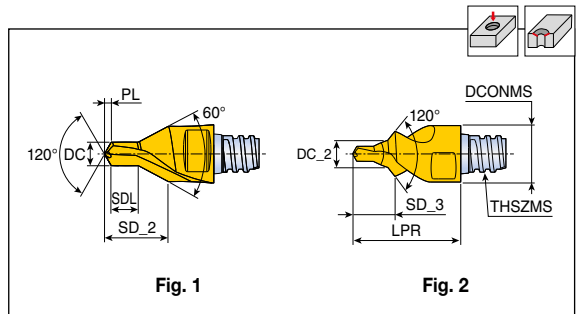

Designation	Dimension (mm)										Grade
	DC	DC ₂	SDL	SD ₂	SD ₃	LPR	THSZMS	DCONMS	PL	Fig	TT5523
MXDP 107L01A30-02S04	1.07	-	1.32	4.14	-	10.0	S04	6.0	0.28	1	●
165L02A30-02S04	1.65	-	1.97	4.45	-	10.0	S04	6.0	0.43	1	●
207L02A30-02S04	2.07	-	2.36	6.37	-	10.0	S04	6.0	0.54	1	●
328L04A30-02S05	3.28	-	3.75	8.76	-	15.0	S05	8.0	0.85	1	●
412L05A30-02S06	4.12	-	4.83	11.05	-	19.0	S06	10.0	1.07	1	●
513L07A30-02S08	5.13	-	5.88	13.23	-	23.0	S08	12.0	1.32	1	●
646L08A30-02S10	6.46	-	7.25	17.18	-	28.0	S10	16.0	1.65	1	●
MXDP 324L04B30-02S08	3.24	6.77	3.55	7.40	8.94	23.0	S08	12.0	0.83	2	●
509L06B30-02S12	5.09	10.69	5.56	11.70	14.17	25.5	S12	18.5	1.33	2	●
641L08B30-02S12	6.41	13.29	6.95	14.50	16.58	25.5	S12	20.0	1.68	2	●

► Wrench should be ordered separately

●: Standard items

► SDL: Step diameter length

MXGC-02

2 flute, for drilling and milling

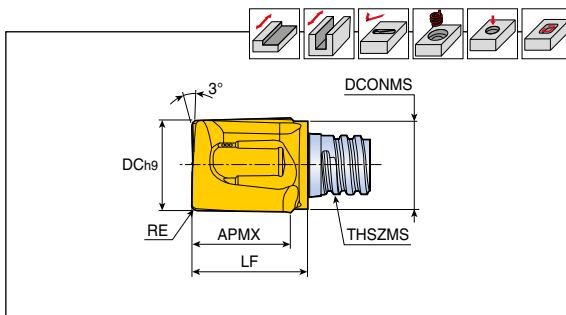

Designation	Feed (mm/tooth)	Dimension (mm)						Grade TT5523
		DC	RE	APMX	LF	THSZMS	DCONMS	
MXGC 08L08R04-02S05	0.03-0.09	8	0.4	7.7	10.0	S05	7.6	●
08L08R10-02S05	0.03-0.09	8	1.0	7.7	10.0	S05	7.6	●
100L09R04-02S05	0.03-0.10	10	0.4	9.0	12.4	S06	9.5	●
100L09R20-02S06	0.03-0.10	10	2.0	9.0	12.4	S06	9.5	●
120L10R04-02S08	0.04-0.11	12	0.4	10.0	14.2	S08	11.5	●
120L10R10-02S08	0.04-0.11	12	1.0	10.0	14.2	S08	11.5	●
120L10R20-02S08	0.04-0.11	12	2.0	10.0	14.2	S08	11.5	●
160L15R04-02S10	0.05-0.13	16	0.4	14.9	19.0	S10	15.2	●

► Wrench should be ordered separately

●: Standard items

MXDS-02

2 flute, for spot drill & chamfer

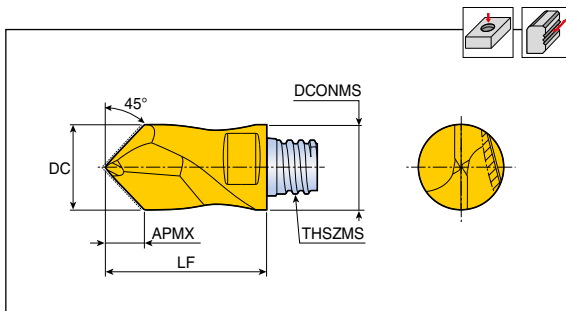

Designation	Dimension (mm)					Grade TT5523
	DC	APMX	LF	THSZMS	DCONMS	
MXDS 060A45-02S04	6	2.7	11.0	S04	5.7	●
080A45-02S05	8	3.7	15.0	S05	7.7	●
100A45-02S06	10	4.4	19.0	S06	9.7	●
120A45-02S08	12	5.4	23.0	S08	11.7	●
160A45-02S10	16	7.1	28.0	S10	15.3	●

► Wrench should be ordered separately

●: Standard items

MXEG-01



Single flute, for engraving

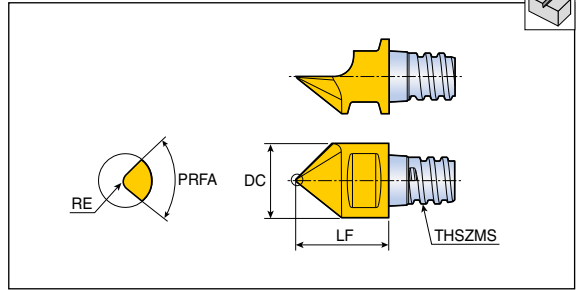

Designation	Dimension (mm)					Grade
	DC	RE	PRFA	LF	THSZMS	TT5523
MXEG 060A60-01S04	6	0.2	60	8.5	S04	●
080A30-01S05	8	0.2	30	10.0	S05	●
080A45-01S05	8	0.2	45	10.0	S05	●
080A60-01S05	8	0.2	60	10.0	S05	●
080A90-01S05	8	0.2	90	10.0	S05	●

► Wrench should be ordered separately

●: Standard items

MXDG-04



4 flute, internal grooving for heat exchanger tube sheets

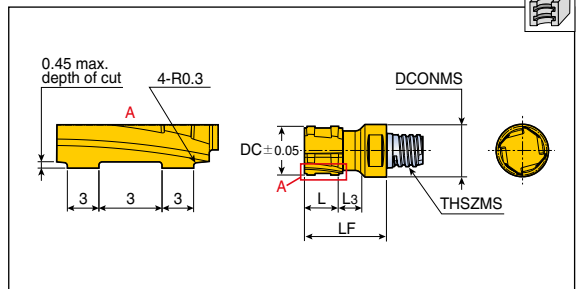

Designation	Dimension (mm)							Key	Grade
	DC	L	L ₃	LF	THSZMS	DCONMS	D _{MIN}		TT5523
MXDG 155-04S10-8238	15.5	14.2	17.8	33.7	S10	16.0	15.88	MX KEY-S08	●
185-04S12-8239	18.5	14.5	18.3	34.5	S12	18.5	19.05	MX KEY-S10	●
245-04S15-8240	24.5	14.4	11.0	37.2	S15	23.8	25.40	MX KEY-S15	●

► Wrench should be ordered separately

●: Standard items

MXCSL



4 flute, lens shape for 5-axis profiling

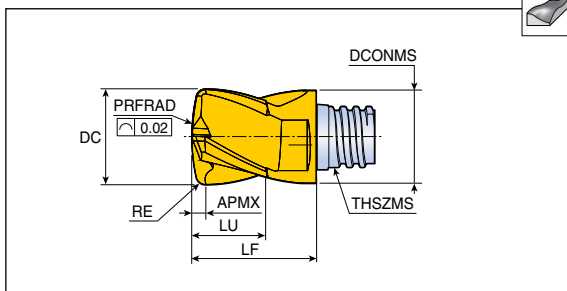

Designation	Feed (mm/tooth)	Dimension (mm)									Grade
		DC	PRFRAD	RE	APMX	LU	LF	THSZMS	DCONMS	TT5523	
MXCSL 4080R016-S05	0.02-0.08	8	16	0.5	0.9	5.5	10.0	S05	8	●	
4100R020-S06	0.03-0.09	10	20	1.0	1.4	7.5	13.0	S06	10	●	
4120R024-S08	0.03-0.10	12	24	1.0	1.6	9.0	16.5	S08	12	●	
4160R032-S10	0.04-0.12	16	32	1.0	1.8	12.0	20.5	S10	16	●	

- ▶ Wrench should be ordered separately
- ▶ PRFRAD: Profile radius

●: Standard items

MXCSO



4 flute, oval shape for 5-axis profiling

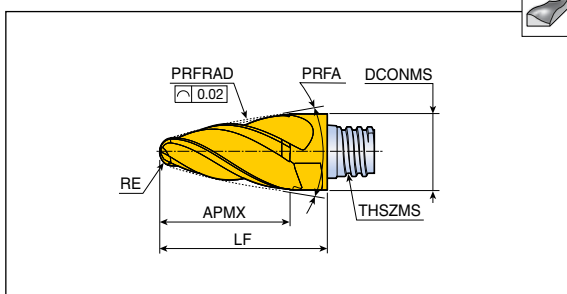

Designation	Feed (mm/tooth)	Dimension (mm)							Grade
		PRFRAD	RE	APMX	LF	PRFA	THSZMS	DCONMS	
MXCSO 4080R080-S05	0.02-0.08	80	1.5	14.2	18.0	24	S05	8	●
4100R085-S06	0.03-0.09	85	2.0	16.5	22.0	24	S06	10	●
4120R075-S08	0.03-0.10	75	2.0	21.3	27.0	24	S08	12	●
4160R075-S10	0.04-0.12	75	3.0	27.0	33.4	24	S10	16	●

- ▶ Wrench should be ordered separately
- ▶ PRFRAD: Profile radius

●: Standard items

MXFM-106

6 flute, for face milling

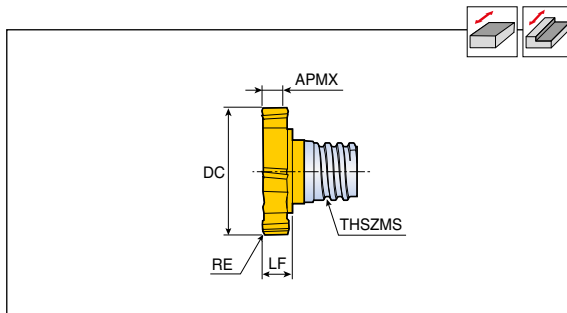

Designation	Feed (mm/tooth)	Dimension (mm)					Torx	Grade
		DC	RE	APMX	LF	THSZMS		
MXFM 100L036R02I06S05	0.04-0.10	10	0.2	3.6	4.4	S05	T20	●
120L036R02I06S05	0.04-0.10	12	0.2	3.6	4.4	S05	T20	●
160L048R04I06S06	0.05-0.10	16	0.4	4.8	5.6	S06	T25	●
200L060R04I06S08	0.05-0.10	20	0.4	6.0	6.8	S08	T40	●
250L075R04I06S10	0.05-0.10	25	0.4	7.5	8.4	S10	T50	●

► Wrench should be ordered separately ● Standard items

TTRD-A60

3, 4 flute, ISO threading

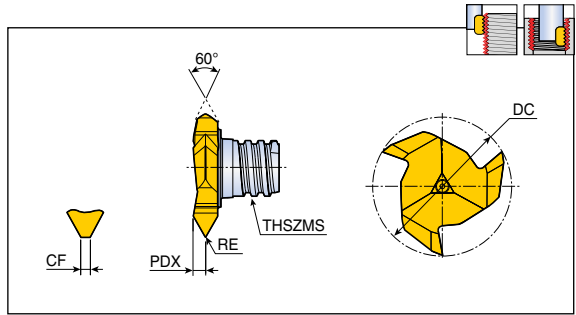

Designation	TP	Dimension (mm)								Grade
		DC	NOF	PDX	RE	CF	RANGE	THSZMS	TT5543	
TTRD 16A60-0.5P-3S06	0.5-2.0	15.7	3	1.4	-	0.05	M20	S06	●	
16A60-1.5P-3S06	1.5-2.0	15.7	3	1.4	0.05	-	M22	S06	●	
22A60-3.0P-4S08	3.0-4.5	21.7	4	2.4	0.20	-	M36	S08	●	

- ▶ Wrench should be ordered separately
- ▶ NOF: Number of flutes
- ▶ TP: Threads pitch

●: Standard items

TTRD-W55

4 flute, BSW threading

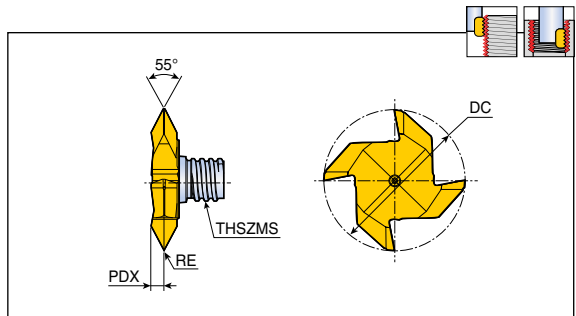

Designation	TPI	Dimension (mm)					Grade
		DC	PDX	RE	RANGE	THSZMS	
TTRD 22W55-14P-4S08	14-11	21.7	2.0	0.2	3/4	S08	●

- ▶ Wrench should be ordered separately
- ▶ TPI: Threads per inch

●: Standard items

TDT-06



6 flute, dovetail

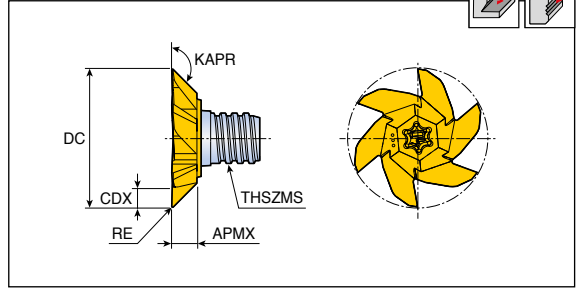
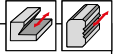

Designation	Dimension (mm)						Torx	Grade
	DC	KAPR	CDX	APMX	RE	THSZMS		
TDT 277A45R02-06S10	27.7	135	4.0	5.05	0.2	S10	T40	●
277A60R02-06S10	27.7	120	4.0	7.75	0.2	S10	T40	●
277A75R02-06S10	27.7	105	2.2	10.15	0.2	S10	T40	●

► Wrench should be ordered separately ● Standard items

TST-3



3 flute, for slotting

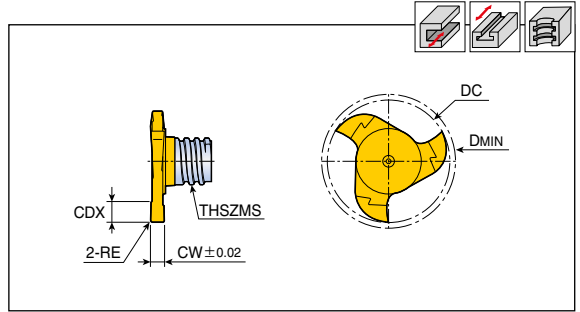

Designation	Feed (mm/tooth)	Dimension (mm)						Grade
		DC	CW	CDX	RE	THSZMS	DMIN	
TST 157W1.50R010-3S06	0.03-0.12	15.7	1.5	2.8	0.1	S06	16	●
157W1.57R020-3S06	0.03-0.12	15.7	1.57	2.8	0.2	S06	16	●
157W2.0R020-3S06	0.03-0.12	15.7	2.0	2.8	0.2	S06	16	●
157W2.50R020-3S06	0.03-0.12	15.7	2.5	2.8	0.2	S06	16	●
157W3.0R020-3S06	0.03-0.13	15.7	3.0	2.8	0.2	S06	16	●
157W3.17R020-3S06	0.03-0.15	15.7	3.17	2.8	0.2	S06	16	●
177W1.20R005-3S06	0.03-0.12	17.7	1.2 ⁽¹⁾	3.8	0.05	S06	18	●
177W1.40R005-3S06	0.03-0.12	17.7	1.4 ⁽¹⁾	3.8	0.05	S06	18	●
177W1.50R010-3S06	0.03-0.12	17.7	1.5	3.8	0.1	S06	18	●
177W1.57R020-3S06	0.03-0.12	17.7	1.57	3.8	0.2	S06	18	●
177W1.70R005-3S06	0.03-0.12	17.7	1.7 ⁽¹⁾	3.8	0.05	S06	18	●
177W2.0R020-3S06	0.03-0.12	17.7	2.0	3.8	0.2	S06	18	●
177W2.20R110-3S06	0.03-0.12	17.7	2.2	3.8	1.1	S06	18	●
177W2.50R020-3S06	0.03-0.12	17.7	2.5	3.8	0.2	S06	18	●
177W3.0R020-3S06	0.03-0.13	17.7	3.0	3.8	0.2	S06	18	●
177W3.17R020-3S06	0.03-0.15	17.7	3.17	3.8	0.2	S06	18	●

► Wrench should be ordered separately ●: Standard items
 ► ⁽¹⁾ CW for circle clips according to DIN 471/472

TST-4/6

4, 6 flute, for slotting

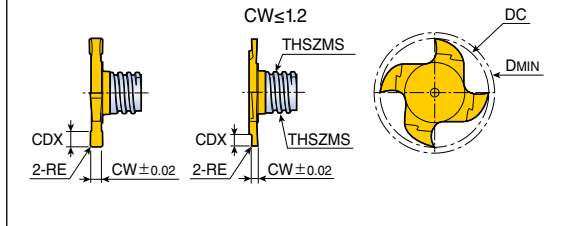
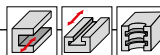

Designation	Feed (mm/tooth)	Dimension (mm)									Grade	
		DC	NOF	CW	CDX	RE	THSZMS	DMIN	Torx	TT5523	TT5543	
TST 217W0.76R000-4S08	0.03-0.10	21.7	4	0.76 ⁽¹⁾	1.5	-	S08	22	-		●	
217W0.96R000-4S08	0.03-0.10	21.7	4	0.96 ⁽¹⁾	1.9	-	S08	22	-		●	
217W1.0R005-4S08	0.03-0.10	21.7	4	1.0	2.0	0.05	S08	22	-		●	
217W1.20R005-4S08	0.03-0.12	21.7	4	1.2 ⁽¹⁾	4.5	0.05	S08	22	-		●	
217W1.40R005-4S08	0.03-0.12	21.7	4	1.4 ⁽¹⁾	4.5	0.05	S08	22	-		●	
217W1.57R000-4S08	0.03-0.12	21.7	4	1.57	4.5	-	S08	22	-		●	
217W1.70R010-4S08	0.03-0.12	21.7	4	1.7 ⁽¹⁾	4.5	0.1	S08	22	-		●	
217W1.95R020-4S08	0.03-0.12	21.7	4	1.95 ⁽¹⁾	4.5	0.2	S08	22	-		●	
217W2.0R020-4S08	0.03-0.12	21.7	4	2.0	4.5	0.2	S08	22	-		●	
217W2.25R020-4S08	0.03-0.12	21.7	4	2.25 ⁽¹⁾	4.5	0.2	S08	22	-		●	
217W2.39R020-4S08	0.03-0.12	21.7	4	2.39	4.5	0.2	S08	22	-		●	
217W2.50R020-4S08	0.03-0.12	21.7	4	2.5	4.5	0.2	S08	22	-		●	
217W2.75R020-4S08	0.03-0.13	21.7	4	2.75 ⁽¹⁾	4.5	0.2	S08	22	-		●	
217W3.0R020-4S08	0.03-0.13	21.7	4	3.0	4.5	0.2	S08	22	-		●	
217W3.17R020-4S08	0.03-0.15	21.7	4	3.17	4.5	0.2	S08	22	-		●	
217W3.25R020-4S08	0.03-0.15	21.7	4	3.25 ⁽¹⁾	4.5	0.2	S08	22	-		●	
217W4.0R020-4S08	0.03-0.15	21.7	4	4.0	4.5	0.2	S08	22	-		●	
217W4.25R020-4S08	0.03-0.15	21.7	4	4.25 ⁽¹⁾	4.5	0.2	S08	22	-		●	
217W4.75R020-4S08	0.03-0.15	21.7	4	4.75	4.5	0.2	S08	22	-		●	
217W5.25R020-4S08	0.03-0.17	21.7	4	5.25 ⁽¹⁾	4.5	0.2	S08	22	-		●	
217W6.0R300-4S08	0.03-0.17	21.7	4	6.0	4.5	3	S08	22	-	●		
277W2.50R020-6S10	0.03-0.12	27.7	6	2.5	6.0	0.2	S10	28	T40		●	
277W5.25R020-6S10	0.03-0.17	27.7	6	5.25	6.0	0.2	S10	28	T40		●	
277W10R020-6S10	0.03-0.17	27.7	6	10.0	6.0	0.2	S10	28	T40		●	

- ▶ Wrench should be ordered separately
- ▶ NOF: Number of flutes
- ▶ ⁽¹⁾ CW for circle clips according to DIN 471/472
- : Standard items

TST-A45



3-6 flute, for chamfering

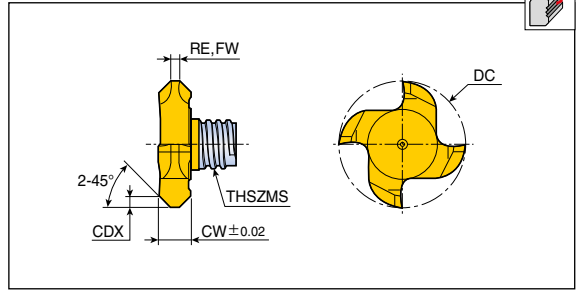

Designation	Feed (mm/tooth)	Dimension (mm)							Grade	
		DC	NOF	CW	CDX	RE	FW	THSZMS	TT5523	TT5543
TST 177L01.40A45-3S06	0.03-0.15	17.7	3	3.4	1.4	0.1	-	S06		●
217L01.70A45-4S08	0.03-0.17	21.7	4	5.5	1.7	-	1.5	S08		●
277L04.00A45-6S10	0.03-0.17	27.7	6	9.8	4.0	-	0.5	S10	●	

- ▶ Wrench should be ordered separately
- ▶ NOF: Number of flutes
- ▶ FW: Flat width

●: Standard items

TTB-04



4 flute, for slotting

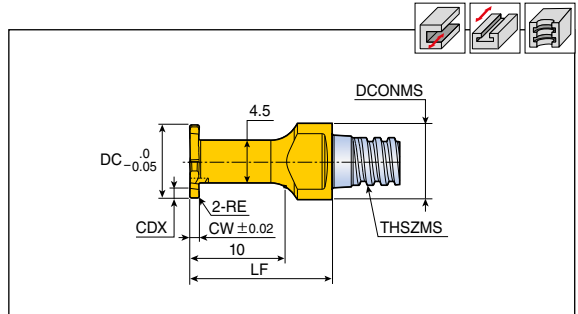

Designation	Feed (mm/tooth)	Dimension (mm)							Grade	
		DC	CW	CDX	RE	LF	THSZMS	DCONMS	TT5523	TT5543
TTB 077W1.0R02-04S05	0.02-0.08	7.7	1.0	1.2	0.2	15	S05	8.0		●
077W1.5R02-04S05	0.02-0.08	7.7	1.5	1.2	0.2	15	S05	8.0		●
077W2.0R02-04S05	0.02-0.08	7.7	2.0	1.2	0.2	15	S05	8.0		●

- ▶ Wrench should be ordered separately

●: Standard items

TTB-06



6 flute, for slotting

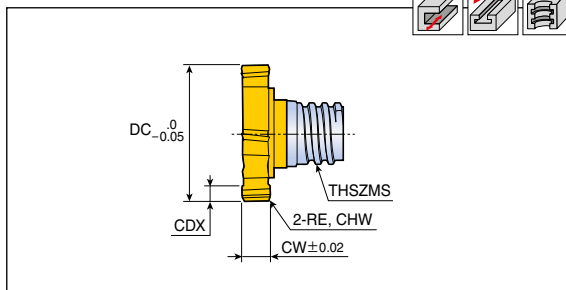
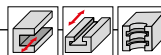

Designation	Feed (mm/tooth)	Dimension (mm)							Grade	
		DC	CW	CDX	CHW	RE	THSZMS	Torx	TT5523	TT5543
TTB 105W2.0R04-06S04	0.02-0.10	10.5	2.0	2.0	-	0.4	S04	T15		●
127W1.58C15-06S05	0.03-0.12	12.7	1.58	2.25	0.15	-	S05	T20	●	
127W1.98C15-06S05	0.03-0.12	12.7	1.98	2.25	0.15	-	S05	T20	●	
135W2.0C15-06S05	0.03-0.12	13.5	2.0	2.65	0.15	-	S05	T20		●
135W3.0R04-06S05	0.03-0.13	13.5	3.0	2.65	-	0.4	S05	T20		●
135W4.0R04-06S05	0.03-0.15	13.5	4.0	2.65	-	0.4	S05	T20		●
160W2.0R04-06S06	0.03-0.12	16.0	2.0	2.9	-	0.4	S06	T20		●
160W3.0R04-06S06	0.03-0.13	16.0	3.0	2.9	-	0.4	S06	T25		●
160W4.0R04-06S06	0.03-0.15	16.0	4.0	2.9	-	0.4	S06	T25		●
165W2.0R04-06S06	0.03-0.12	16.5	2.0	3.15	-	0.4	S06	T20		●
165W3.0R04-06S06	0.03-0.13	16.5	3.0	3.15	-	0.4	S06	T25		●
165W4.0R04-06S06	0.03-0.15	16.5	4.0	3.15	-	0.4	S06	T25		●
195W4.0R04-06S08	0.03-0.15	19.5	4.0	3.45	-	0.4	S08	T30		●
195W5.0R04-06S08	0.03-0.15	19.5	5.0	3.45	-	0.4	S08	T30		●
195W6.0R04-06S08	0.03-0.17	19.5	6.0	3.45	-	0.4	S08	T30		●
225W5.0R04-06S08	0.03-0.15	22.5	5.0	4.95	-	0.4	S08	T40		●
225W6.0R04-06S08	0.03-0.17	22.5	6.0	4.95	-	0.4	S08	T40		●
225W8.0R04-06S08	0.03-0.17	22.5	8.0	4.95	-	0.4	S08	T40		●
250W6.0R04-06S08	0.03-0.17	25.0	6.0	5.9	-	0.4	S08	T50		●
250W8.0R04-06S08	0.03-0.17	25.0	8.0	5.9	-	0.4	S08	T50		●
250W5.0R04-06S10	0.03-0.15	25.0	5.0	4.3	-	0.4	S10	T50		●
250W6.0R04-06S10	0.03-0.17	25.0	6.0	4.3	-	0.4	S10	T50		●
250W8.0R04-06S10	0.03-0.17	25.0	8.0	4.3	-	0.4	S10	T50		●

► Wrench should be ordered separately

●: Standard items

MXSSD



High rigidity shank

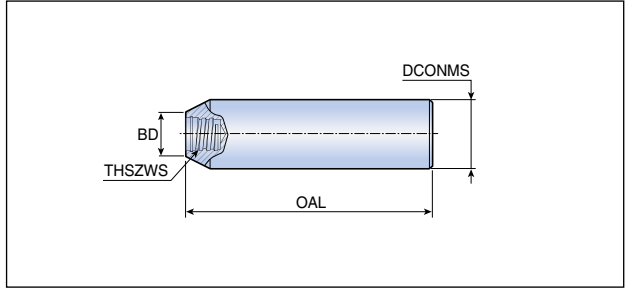

Designation	Dimension (mm)				Shank material
	THSZWS	DCONMS	BD	OAL	
MXSSD 06L050S04-S	S04	6	5.8	50	Steel
06L060S04-C	S04	6	5.8	60	Carbide
08L050S04-S	S04	8	5.8	50	Steel
08L060S04-C	S04	8	5.8	60	Carbide
10L055S05-S	S05	10	7.6	55	Steel
12L065S06-S	S06	12	9.6	65	Steel
16L065S08-S	S08	16	11.6	65	Steel
20L070S10-S	S10	20	15.3	70	Steel
25L075S12-S	S12	25	18.3	75	Steel
32L100S15-S	S15	32	23.9	100	Steel

► THSZWS: Connection thread size

MXSSD-S



Steel shanks with step neck & internal coolant hole

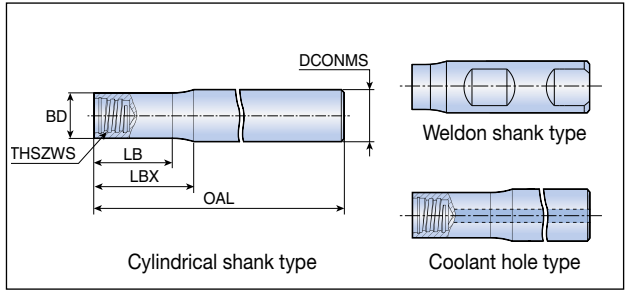

Designation	Dimension (mm)						Coolant hole	Shank type	Shank material
	THSZWS	DCONMS	BD	OAL	LB	LBX			
MXSSD 08L060S05-S	S05	8	7.6	60	12.8	15	x	Cylindrical	Steel
10L075S06-S	S06	10	9.6	75	17.7	20	x	Cylindrical	Steel
10L075S06-S-A	S06	10	9.6	75	10.6	12	●	Cylindrical	Steel
12L055W05-S	S05	12	7.6	55	-	3.8	x	Weldon	Steel
12L090S08-S	S08	12	11.5	90	13.6	16	x	Cylindrical	Steel
12L090S08-S-A	S08	12	11.5	90	13.6	16	●	Cylindrical	Steel
12L090LS08-S-A	S08	12	11.5	90	37	42	●	Cylindrical	Steel
16L065W06-S	S06	16	9.6	65	-	6	x	Weldon	Steel
16L065W08-S	S08	16	11.5	65	-	4	x	Weldon	Steel
16L100S10-S	S10	16	15.2	100	18	20	x	Cylindrical	Steel
16L100S10-S-A	S10	16	15.2	100	18	20	●	Cylindrical	Steel
16L100LS10-S-A	S10	16	15.2	100	38	42	●	Cylindrical	Steel
20L070W10-S	S10	20	15.2	70	-	4	x	Weldon	Steel
20L120S12-S	S12	20	18.3	120	20.5	25	x	Cylindrical	Steel
25L075W12-S	S12	25	18.3	75	-	6	x	Weldon	Steel
25L135S15-S	S15	25	23.9	135	33	35	x	Cylindrical	Steel

► THSZWS: Connection thread size

Carbide shanks with step neck & internal coolant hole

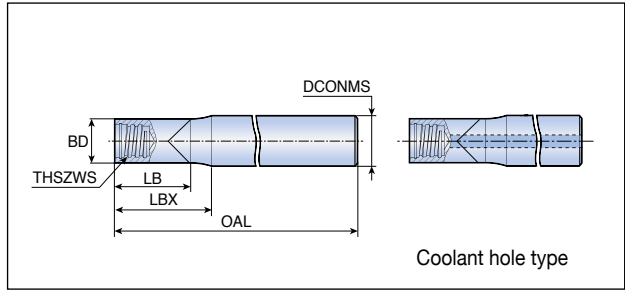

Designation	Dimension (mm)						Coolant hole	Shank material
	THSZWS	DCONMS	BD	OAL	LB	LBX		
MXSSD 08L070S05-C	S05	8	7.6	70	19	20	x	Carbide
08L090S05-C	S05	8	7.6	90	39	40	x	Carbide
08L110S05-C	S05	8	7.6	110	59	60	x	Carbide
10L070S06-C	S06	10	9.6	70	18.5	20	x	Carbide
10L090S06-C	S06	10	9.6	90	38.5	40	x	Carbide
10L110S06-C	S06	10	9.6	110	58.5	60	x	Carbide
10L150S06-C	S06	10	9.6	150	98.5	100	x	Carbide
12L070S08-C	S08	12	11.5	70	17	20	x	Carbide
12L070S08-C-A	S08	12	11.5	70	17	20	●	Carbide
12L090S08-C	S08	12	11.5	90	37	40	x	Carbide
12L090LS08-C-A	S08	12	11.5	90	37	40	●	Carbide
12L110S08-C	S08	12	11.5	110	57	60	x	Carbide
12L110S08-C-A	S08	12	11.5	110	57	60	●	Carbide
12L130S08-C	S08	12	11.5	130	77	80	x	Carbide
12L130S08-C-A	S08	12	11.5	130	77	80	●	Carbide
16L090S10-C	S10	16	15.2	90	38	40	x	Carbide
16L090S10-C-A	S10	16	15.2	90	38	40	●	Carbide
16L110S10-C	S10	16	15.2	110	58	60	x	Carbide
16L110S10-C-A	S10	16	15.2	110	58	60	●	Carbide
16L130S10-C	S10	16	15.2	130	78	80	x	Carbide
16L130S10-C-A	S10	16	15.2	130	78	80	●	Carbide
16L150S10-C	S10	16	15.2	150	98	100	x	Carbide
20L090S12-C	S12	20	18.3	90	37	40	x	Carbide
20L130S12-C	S12	20	18.3	130	77	80	x	Carbide
20L200S12-C	S12	20	18.3	200	117	120	x	Carbide
25L120S15-C	S15	25	23.9	120	58	60	x	Carbide
25L170S15-C	S15	25	23.9	170	98	100	x	Carbide
25L250S15-C	S15	25	23.9	250	148	150	x	Carbide

► THSZWS: Connection thread size

Tungsten shanks with step neck & internal coolant hole

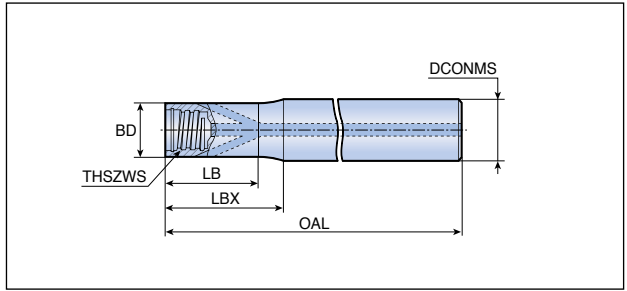

Designation	Dimension (mm)						Shank material
	THSZWS	DCONMS	BD	OAL	LB	LBX	
MXSSD 10L070S06-W-A	S06	10	9.6	70	19	20	Tungsten
10L090S06-W-A	S06	10	9.6	90	39	40	Tungsten
10L110S06-W-A	S06	10	9.6	110	59	60	Tungsten
12L070S08-W-A	S08	12	11.5	70	19	20	Tungsten
12L090S08-W-A	S08	12	11.5	90	39	40	Tungsten
12L110S08-W-A	S08	12	11.5	110	59	60	Tungsten
12L130S08-W-A	S08	12	11.5	130	79	80	Tungsten
16L070S10-W-A	S10	16	15.2	70	18.5	20	Tungsten
16L090S10-W-A	S10	16	15.2	90	36.5	40	Tungsten
16L110S10-W-A	S10	16	15.2	110	58.5	60	Tungsten
16L130S10-W-A	S10	16	15.2	130	78.5	80	Tungsten
20L090S12-W-A	S12	20	18.3	90	37	40	Tungsten
20L130S12-W-A	S12	20	18.3	130	77	80	Tungsten

► THSZWS: Connection thread size

MXTSD-C



Carbide shanks with taper neck

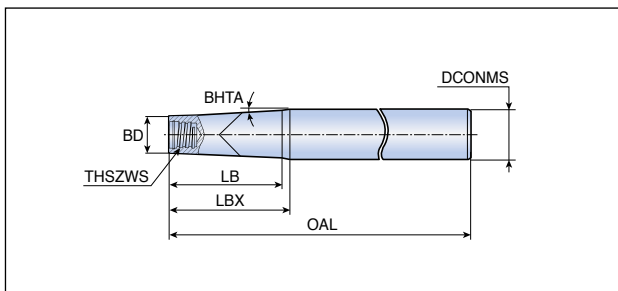

Designation	Dimension (mm)							Shank material
	THSZWS	DCONMS	BD	OAL	BHTA	LB	LBX	
MXTSD 12L110S05-C	S05	12	7.6	110	1°	58.0	60	Carbide
12L130S05-C	S05	12	7.6	130	1°	79.0	80	Carbide
16L130S08-C	S08	16	11.5	130	1°	78.8	80	Carbide
16L150S05-C	S05	16	7.6	150	1°	96.0	100	Carbide
16L150S06-C	S06	16	9.6	150	1°	98.0	100	Carbide
16L150S08-C	S08	16	11.5	150	1°	-	100	Carbide
16L170S06-C	S06	16	9.6	170	1°	119.0	120	Carbide
20L170S08-C	S08	20	11.5	170	1°	117.0	120	Carbide
20L170S10-C	S10	20	15.2	170	1°	-	120	Carbide
20L190S10-C	S10	20	15.2	190	1°	-	140	Carbide
20L210S10-C	S10	20	15.2	210	1°	-	160	Carbide
25L180S12-C	S12	25	18.3	180	1°	-	120	Carbide
25L250S12-C	S12	25	18.3	250	1°	-	140	Carbide
32L250S15-C	S15	32	23.9	250	1°	-	150	Carbide
32L300S15-C	S15	32	23.9	300	1°	-	200	Carbide

► THSZWS: Connection thread size

Tungsten shanks with taper neck & internal coolant hole

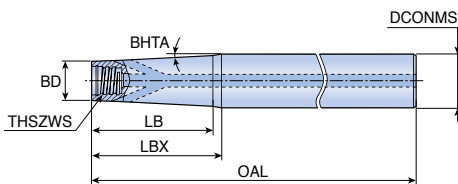

Designation	Dimension (mm)							Shank material
	THSZWS	DCONMS	BD	OAL	BHTA	LB	LBX	
MXTSD 12L110S06-W-A	S06	12	9.6	110	1°	59	60	Tungsten
16L170S06-W-A	S06	16	9.6	170	1°	116	120	Tungsten

▶ THSZWS: Connection thread size

MXSTD-S



Straight steel shanks

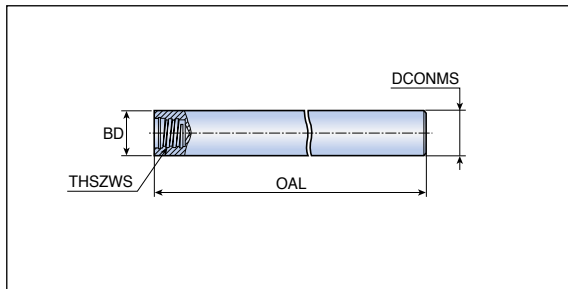

Designation	Dimension (mm)				Shank material
	THSZWS	DCONMS	BD	OAL	
MXSTD 06L070S04-S	S04	6	6	70	Steel
08L050S05-S	S05	8	8	50	Steel
08L070S05-S	S05	8	8	70	Steel
10L050S06-S	S06	10	10	50	Steel
10L080S06-S	S06	10	10	80	Steel
12L090S08-S	S08	12	12	90	Steel
16L100S10-S	S10	16	16	100	Steel

► THSZWS: Connection thread size

MXSC-C



Straight carbide shanks

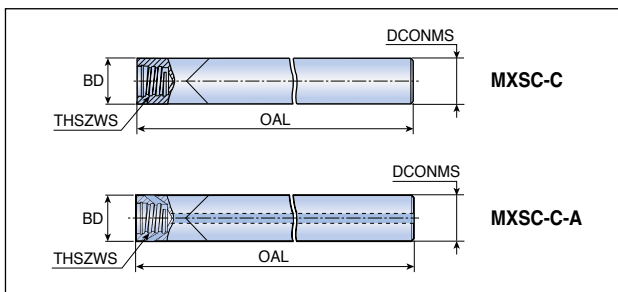

Designation	Dimension (mm)				Coolant hole	Shank material
	THSZWS	DCONMS	BD	OAL		
MXSC 100L100S06-C	S06	10	10	100	x	Carbide
120L100S08-C-A	S08	12	12	100	●	Carbide

► THSZWS: Connection thread size

MXAD-M

Adapters for T-FLEXTEC

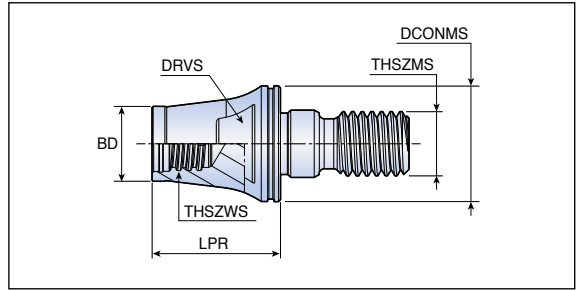

Designation	Dimension (mm)						Shank material
	THSZWS	THSZMS	DCONMS	BD	LPR	DRVS	
MXAD 130L016S08-S-M8	S08	M8	13	11.7	16	11	Steel
130L025S08-S-M8	S08	M8	13	11.7	25	11	Steel
180L020S08-S-M10	S08	M10	18	11.7	20	13	Steel
180L025S08-S-M10	S08	M10	18	11.7	25	11	Steel
210L020S08-S-M12	S08	M12	21	11.7	20	13	Steel
210L025S08-S-M12	S08	M12	21	11.7	25	13	Steel

- ▶ THSZWS: Connection thread size
- ▶ DRVS: Clamping wrench size

ER collet chucks conversion adaptor with MAXI-RUSH

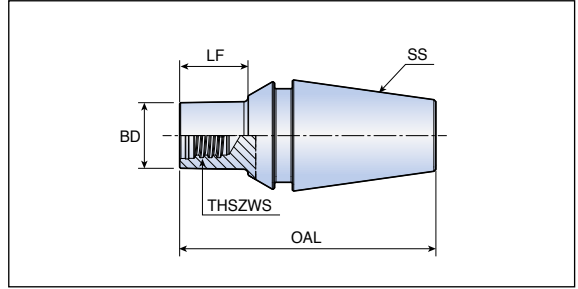

Designation	Dimension (mm)					Shank material
	SS	THSZWS	BD	LF	OAL	
MXER 11AL006S04-S	ER11	S04	5.8	6	24.0	Steel
11CL006S05-S	ER11	S05	7.92	6	24.0	Steel
11CL020S05-S	ER11	S05	7.92	20	38.0	Steel
16CL012S05-S	ER16	S05	7.92	12	39.5	Steel
16CL020S05-S	ER16	S05	7.92	20	47.5	Steel
16CL010S06-S	ER16	S06	9.92	10	37.5	Steel
16CL020S06-S	ER16	S06	9.92	20	47.5	Steel
16CL006S08-S	ER16	S08	11.6	6	33.5	Steel
16CL020S08-S	ER16	S08	11.6	20	47.5	Steel
25CL004S08-S	ER25	S08	11.6	4	38.0	Steel
25CL010S08-S	ER25	S08	11.6	10	44.5	Steel

► THSZWS: Connection thread size

Wrench

Appearance	Designation	Connection thread size	Torque (N.m)	Head
	MX KEY-S05	S04, S05	7	Square Ball Round Drilling Chamfering Counter boring
	MX KEY-S06	S06	10	
	MX KEY-S08	S08	15	
	MX KEY-S10	S10	28	
	MX KEY-S12	S12	28	
	MX KEY-S15	S15	40	
	MX SKEY-S06	S06	10	TST, TTRD
	MX SKEY-S08	S08	15	
	MX SKEY-T40L	S08	15	MXFM TDT TTB TST-6S10
		S10	28	
	MX SKEY-T20	S05	7	
		S06	10	
	MX SKEY-T25	S06	10	
	MX SKEY-T30L	S08	15	
	MX SKEY-T50L	S08	15	
S10		28		

► Wrench should be ordered separately

Torque wrench

Appearance	Designation	Connection	Head designation	Torque (N.m)
Handle	TORQUE WRENCH 5-50Nm 9x12	-	-	-
Open wrench for cylindrical head	MX WRENCH 6-05	S04, S05	MXED, MXEE MXES, MXRD MXBE, MXDP MXCA	7
	MX WRENCH 8-06	S06		10
	MX WRENCH 10-08	S08		15
	MX WRENCH 13-10	S10		28
	MX WRENCH 16-12	S12		28
	MX WRENCH 20-15	S15		40
Open wrench for 2 flutes head	MX WRENCH 4E-05	S05	MXRB, MXFX MXBB, MXCP MXGC, MXCW MXCR	7
	MX WRENCH 5E-06	S06		10
	MX WRENCH 7E-08	S08		15
	MX WRENCH 8E-10	S10		28
	MX WRENCH 9E-12	S12		28
90° adapter for torx bit	INSERT TOOL 9x12mm	-	-	-
Torx bit socket	BIT SOCKET T20 DRIVE	S04, S05, S06	TTB TST277	7, 10
	BIT SOCKET T25 DRIVE	S06		10
	BIT SOCKET T30 DRIVE	S08		15
	BIT SOCKET T40 DRIVE	S08, S10		15, 28
	BIT SOCKET T50 DRIVE	S08, S10		15, 28

► Wrench should be ordered separately

Recommended Cutting Conditions



Machining data for MAXI-RUSH

fz for Square & Round heads

(mm/tooth)

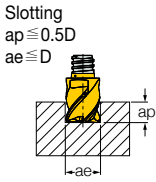

Side Milling
 $ae \leq 0.5D$
 (1) $ap \equiv D$
 (2) $ap \leq 0.05D$

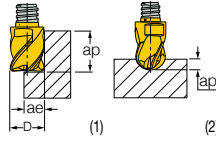

D (mm)	fz (mm/tooth)	D (mm)	fz (mm/tooth)
6	0.027-0.05	6	0.027-0.06
8	0.032-0.07	8	0.032-0.08
10	0.034-0.08	10	0.034-0.09
12	0.036-0.10	12	0.036-0.11
16	0.050-0.12	16	0.05 - 0.13
20	0.052-0.14	20	0.052-0.15
25	0.062-0.15	25	0.062-0.17

fz for Slotting heads

(mm/tooth)

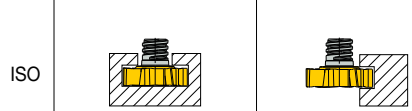

P	0.025-0.12	0.035-0.15
M	0.025-0.10	0.025-0.12
K	0.025-0.15	0.035-0.17
Thread Size	Key	Clamping Torque (N.m)
S04, S05	MX KEY-S05	7
S06	MX KEY-S06	10
S08	MX KEY-S08	15
S10	MX KEY-S10	28
S12	MX KEY-S12	28
S15	MX KEY-S15	40

Recommended Cutting Speed

ISO	Material No.	Hardness HB	Vc m/min
P	1	125	220-240
	2	190	170-200
	3-6	200	140-160
	7-8	300	110-130
	9-11	200	100-130
M	12-13	240	90-150
	14	180	70-100
K	15	180	70-240
	16	260	110-220
	17	170	130-250
	19	130	130-230
	20	230	100-200
N	21-24	90	600-700
S	33-35	350	10-20
	36-37	-	30-50
H	38	HRC55	30-40
	39	HRC60	25-30

High feed milling - MXFX Only

ISO	Material No.	Depth of cut (ap)	Width of cut (ae)	fz (mm/tooth) vs. Tool Diameter D(mm)						
				Ø8	Ø10	Ø12	Ø16	Ø20	Ø25	
P	1	0.045xD	0.7xD	0.50	0.60	0.70	0.80	0.95	1.05	
	2	0.045xD	0.7xD	0.50	0.60	0.70	0.80	0.95	1.05	
	3	0.045xD	0.7xD	0.50	0.60	0.70	0.80	0.95	1.05	
	4	0.045xD	0.7xD	0.50	0.60	0.70	0.80	0.95	1.05	
	5	0.045xD	0.7xD	0.45	0.55	0.60	0.70	0.80	0.90	
	6	0.045xD	0.7xD	0.35	0.45	0.50	0.60	0.70	0.80	
	7	0.045xD	0.7xD	0.35	0.45	0.50	0.60	0.70	0.80	
	8	0.045xD	0.7xD	0.35	0.40	0.45	0.55	0.65	0.75	
	9	0.045xD	0.7xD	0.35	0.40	0.45	0.55	0.65	0.75	
	10	0.04xD	0.6xD	0.30	0.35	0.40	0.50	0.6	0.70	
	11	0.04xD	0.6xD	0.30	0.35	0.40	0.45	0.55	0.65	
M	12-14	0.04xD	0.6xD	0.35	0.40	0.45	0.55	0.65	0.75	
K	15-16	Apmax	0.7xD	0.50	0.55	0.65	0.75	0.85	0.95	
	17-20	Apmax	0.7xD	0.40	0.50	0.55	0.65	0.75	0.85	
H	38.1	0.035xD	0.45xD	0.25	0.30	0.35	0.45	0.50	0.60	
	38.2	0.03xD	0.3xD	0.20	0.25	0.35	0.40	0.50	0.55	
	39	0.02xD	0.25xD	0.15	0.20	0.20	0.25	0.25	0.30	

Solid End Mill Line



Designation System

SLIKSOLID

UHP 4 100 x 25 x 72 R0.5

1

2

3

4

5

6

1 End mill type

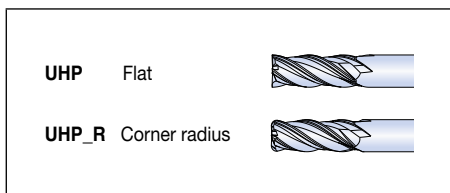

2 No. of flute

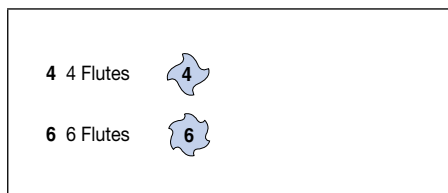

3 Cutting diameter

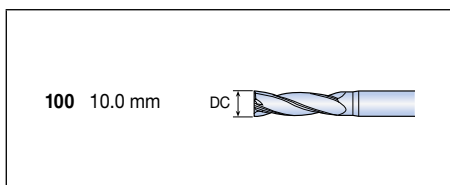

4 Length of cut

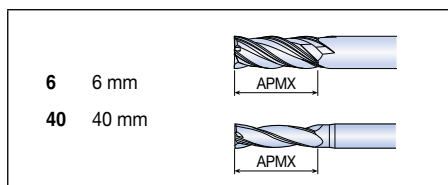

5 Tool length

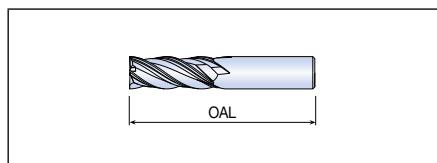

6 Corner radius

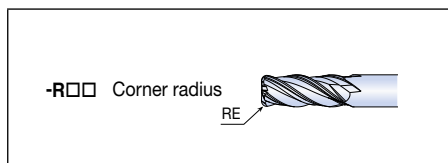

Designation System

HARDMILL

APEXMILL

STARMILL

ALUMILL

DIAMILL

SBE

1

2

2

010





3

S -



4

5/5*

1 End mill type

HSB/SBT/DEB	Ball nose	
SED	Flat	
DER	Corner radius	
SCSO/SCST	Taper	



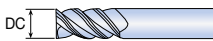

2 No. of flute

2 2 Flutes	
4 4 Flutes	
6 6 Flutes	

3 Cutting diameter

010	1.0 mm	
100	10.0 mm	

4 Overall length

S	Short length	
M	Medium length	
L	Long length	
XL	Extra long length	

5 Others

-□	Shank diameter
-R□□	Corner radius

5* Length of cut

SCSO / SCST type	
24	24 mm

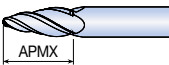

HSB 2CBN



2 flute CBN ball

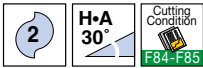
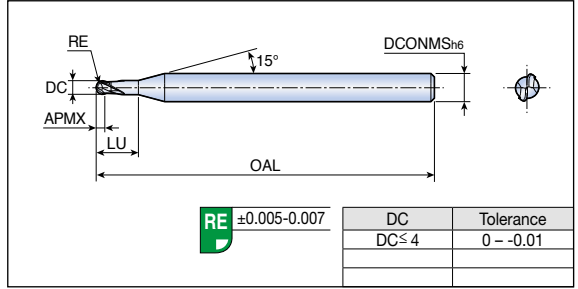

Designation	Feed (mm/tooth)	Dimension (mm)						Grade TB7015
		DC	RE	OAL	APMX	LU	DCONMS	
HSB 2CBN 2004-1.5	0.007-0.009	0.4	0.2	48	0.3	1.5	4	●
2004-6.0	0.007-0.009	0.4	0.2	48	0.3	6.0	4	●
2006-1.5	0.013-0.014	0.6	0.3	48	0.5	1.5	4	●
2008-4.0	0.013-0.018	0.8	0.4	48	0.5	4.0	4	●
2010-2.5	0.022-0.028	1.0	0.5	48	0.7	2.5	4	●
2010-4.0	0.022-0.028	1.0	0.5	48	0.7	4.0	4	●
2010-6.0	0.022-0.028	1.0	0.5	48	0.7	6.0	4	●
2015-6.0	0.023-0.028	1.5	0.75	48	1.0	6.0	4	●
2020-4.0	0.032-0.040	2.0	1.0	50	1.2	4.0	4	●
2040-8.0	0.035-0.040	4.0	2.0	66	2.4	8.0	6	●

● Standard items

UHP 4

4 flute medium flat

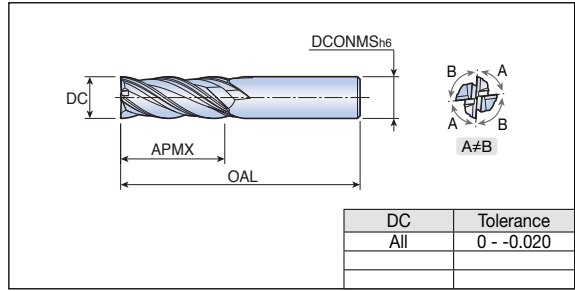

Designation	Feed (mm/tooth)	Dimension (mm)				Grades
		DC	OAL	APMX	DCONMS	TT5520
UHP 4020X6X42	0.010-0.015	2	42	6	6	●
4030X10X57	0.010-0.020	3	57	10	6	●
4040X12X57	0.010-0.035	4	57	12	6	●
4040X20X70	0.010-0.025	4	70	20	6	●
4050X14X57	0.015-0.040	5	57	14	6	●
4060X16X57	0.020-0.060	6	57	16	6	●
4060X25X80	0.020-0.050	6	80	25	6	●
4070X20X63	0.020-0.070	7	63	20	8	●
4080X20X63	0.020-0.080	8	63	20	8	●
4080X35X90	0.020-0.060	8	90	35	8	●
4090X25X72	0.025-0.090	9	72	25	10	●
4100X25X72	0.025-0.100	10	72	25	10	●
4100X45X100	0.025-0.080	10	100	45	10	●
4110X30X83	0.030-0.110	11	83	30	12	●
4120X30X83	0.030-0.130	12	83	30	12	●
4120X55X110	0.030-0.100	12	110	55	12	●
4140X40X92	0.030-0.120	14	92	40	16	●
4160X40X92	0.040-0.140	16	92	40	16	●
4160X70X125	0.040-0.100	16	125	70	16	●
4180X45X110	0.040-0.140	18	110	45	20	●
4200X45X110	0.050-0.140	20	110	45	20	●
4200X75X150	0.050-0.120	20	150	75	20	●
4250X65X140	0.060-0.140	25	140	65	25	●

●: Standard items

UHP 4...R

4 flute medium corner radius

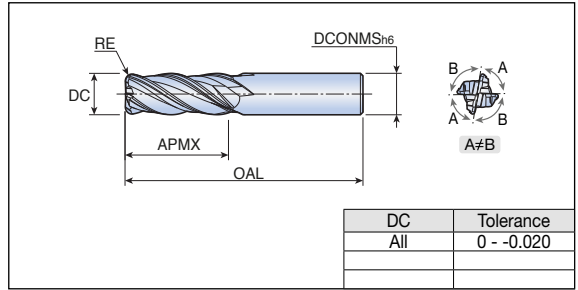

Designation	Feed (mm/tooth)	Dimension (mm)					Grades TT5520
		DC	RE	OAL	APMX	DCONMS	
UHP 4030X10X57R0.3	0.010-0.020	3	0.3	57	10	6	●
4030X10X57R0.5	0.010-0.020	3	0.5	57	10	6	●
4040X12X57R0.3	0.010-0.035	4	0.3	57	12	6	●
4040X12X57R0.5	0.010-0.035	4	0.5	57	12	6	●
4040X12X57R1.0	0.010-0.035	4	1.0	57	12	6	●
4050X14X57R0.3	0.015-0.040	5	0.3	57	14	6	●
4060X16X57R0.5	0.020-0.060	6	0.5	57	16	6	●
4060X16X57R1.0	0.020-0.060	6	1.0	57	16	6	●
4080X20X63R0.5	0.020-0.080	8	0.5	63	20	8	●
4080X20X63R1.0	0.020-0.080	8	1.0	63	20	8	●
4080X20X63R2.0	0.020-0.080	8	2.0	63	20	8	●
4100X25X72R0.5	0.025-0.100	10	0.5	72	25	10	●
4100X25X72R1.0	0.025-0.100	10	1.0	72	25	10	●
4100X25X72R2.0	0.025-0.100	10	2.0	72	25	10	●
4100X25X72R3.0	0.025-0.100	10	3.0	72	25	10	●
4120X30X83R0.5	0.030-0.130	12	0.5	83	30	12	●
4120X30X83R1.0	0.030-0.130	12	1.0	83	30	12	●
4120X30X83R2.0	0.030-0.130	12	2.0	83	30	12	●
4120X30X83R3.0	0.030-0.130	12	3.0	83	30	12	●
4160X40X92R0.5	0.040-0.140	16	0.5	92	40	16	●
4160X40X92R1.0	0.040-0.140	16	1.0	92	40	16	●
4160X40X92R3.0	0.040-0.140	16	3.0	92	40	16	●
4200X45X110R0.5	0.050-0.140	20	0.5	110	45	20	●
4200X45X110R3.0	0.050-0.140	20	3.0	110	45	20	●

● Standard items

4, 6 flute, lens shape for 5-axis profiling

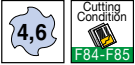
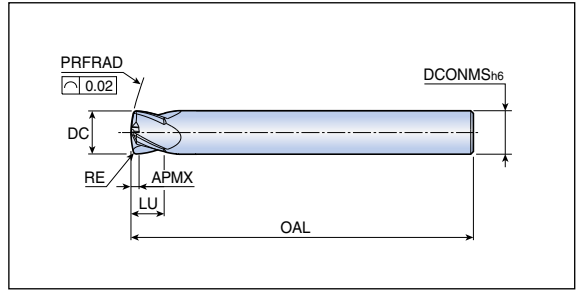

Designation	Feed (mm/tooth)	Dimension (mm)								Grade
		DC	NOF	PRFRAD	RE	APMX	LU	DCONMS	OAL	
SCSL 4080R015X05	0.02-0.08	8	4	15	0.75	1.1	5.0	8	63	●
6100R020X07	0.03-0.09	10	6	20	1.0	1.4	7.0	10	72	●
6120R025X09	0.03-0.10	12	6	25	1.0	1.5	9.0	12	83	●

► PRFRAD: Profile radius

●: Standard items

SCSO

4 flute, oval shape for 5-axis profiling

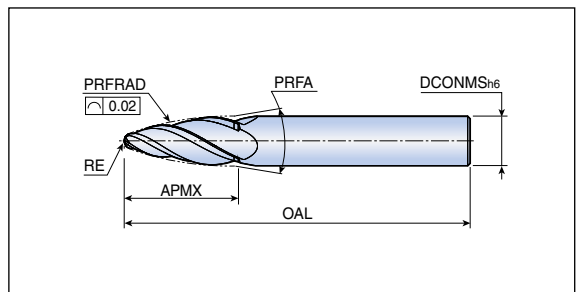

Designation	Feed (mm/tooth)	Dimension (mm)					Grade	
		PRFRAD	RE	APMX	PRFA	DCONMS		
SCSO 4080R090X24	0.02-0.08	90	1.0	24.8	14.9	8	63	●
4100R085X26	0.03-0.09	85	2.0	26.6	15.5	10	72	●
4120R080X27	0.03-0.10	80	2.0	27.1	18.4	12	83	●

► PRFRAD: Profile radius

●: Standard items

4 flute, tapered oval shape for 5-axis profiling

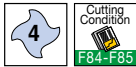
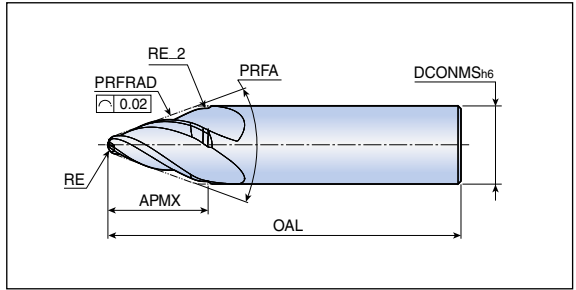

Designation	Feed (mm/tooth)	Dimension (mm)							Grade TT5515
		PRFRAD	RE	RE_2	APMX	PRFA	DCONMS	OAL	
SCST 4080R250A40X10	0.02-0.08	250	1.0	4.0	10.0	40	8	63	●
4100R250A40X11	0.03-0.09	250	2.0	5.0	11.0	40	10	63	●
4120R250A40X12	0.03-0.10	250	3.0	6.0	12.0	40	12	63	●

► PRFRAD: Profile radius

●: Standard items

5 flute, 45° chamfering

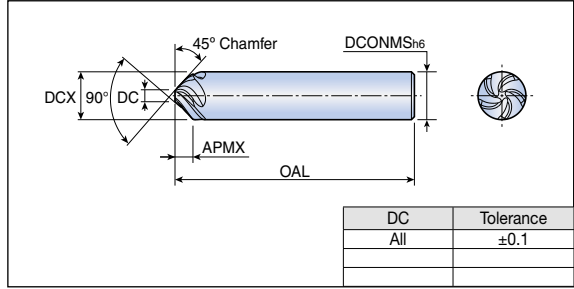

Designation	Feed (mm/tooth)	Dimension (mm)					Grade
		DCX	DC	OAL	APMX	DCONMS	
HCEM 5080	0.02-0.06	8	2	63	3.0	8	●
5100	0.03-0.07	10	2.5	72	3.8	10	●
5120	0.03-0.08	12	3	83	4.5	12	●
5160	0.04-0.10	16	4	92	6.0	16	●

●: Standard items

HFM 2

2 flute high feed flat

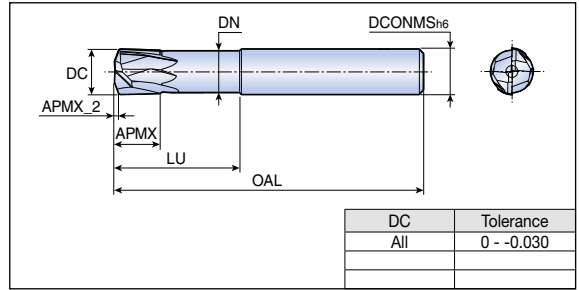

• High Feed Machining (H.F.M)

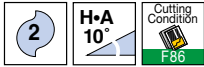

Designation	Feed (mm/tooth)	Dimension (mm)							Grade
		DC	OAL	APMX	APMX_2*	LU	DN	DCONMS	
HFM 2040	0.2-0.4	4	47	4	0.3	10	3.9	6	●
2060	0.3-0.6	6	52	6	0.5	16	5.5	6	●
2080	0.4-0.7	8	60	8	0.75	22	7.3	8	●
2100	0.5-0.9	10	68	10	1.0	28	9.2	10	●
2120	0.5-1.0	12	76	12	1.1	33	11.0	12	●

▶ *: Maximum D.O.C for high feed milling

●: Standard items

HFM 4

4 flute high feed flat

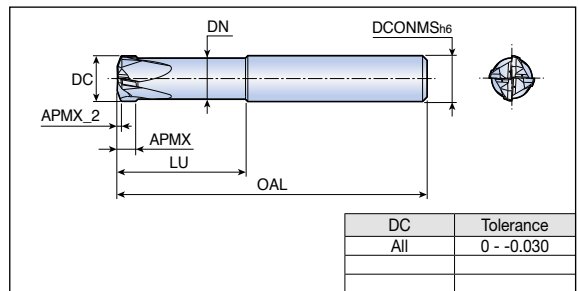

• High Feed Machining (H.F.M)



Designation	Feed (mm/tooth)	Dimension (mm)							Grade
		DC	OAL	APMX	APMX_2*	LU	DN	DCONMS	
HFM 4060	0.3-0.5	6	52	2.5	0.5	16	5.4	6	●
4080	0.3-0.6	8	60	3.5	0.7	24	7.2	8	●
4100	0.4-0.8	10	68	4.0	0.75	28	9.2	10	●
4120	0.4-1.0	12	76	5.0	1.05	33	11.0	12	●

▶ *: Maximum D.O.C for high feed milling

●: Standard items

CFM 4...M



4 flute corner chamfer

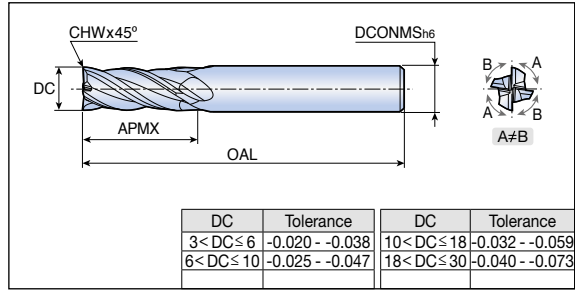

- Vibration free mill



Designation	Feed (mm/tooth)	Dimension (mm)					Grade TT5525
		DC	CHW	OAL	APMX	DCONMS	
CFM 4060M	0.03-0.07	6	0.25	57	14	6	●
4080M	0.03-0.08	8	0.3	63	18	8	●
4100M	0.03-0.10	10	0.4	72	22	10	●
4120M	0.04-0.11	12	0.5	83	26	12	●
4160M	0.05-0.13	16	0.6	100	34	16	●
4200M	0.05-0.17	20	0.6	110	42	20	●
4250M	0.06-0.20	25	0.6	121	52	25	●

- : Standard items

FSM 4...M



4 flute medium corner chamfer

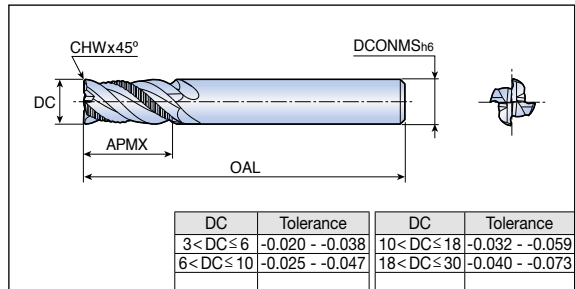

- MULTIMILL (Rough + Finish)

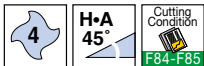

Designation	Feed (mm/tooth)	Dimension (mm)					Grade TT5525
		DC	CHW	OAL	APMX	DCONMS	
FSM 4060M	0.03-0.06	6	0.25	57	14	6	●
4080M	0.03-0.08	8	0.3	63	18	8	●
4100M	0.03-0.09	10	0.3	72	22	10	●
4120M	0.04-0.11	12	0.4	83	26	12	●
4140M	0.04-0.11	14	0.4	83	30	14	●
4160M	0.05-0.11	16	0.6	92	34	16	●
4200M	0.05-0.11	20	0.6	104	42	20	●
4250M	0.06-0.11	25	0.6	121	52	25	●

- : Standard items

SBT 3...U



3 flute medium ball



- Excellent chatter damping due to unequal spacing of cutting edges

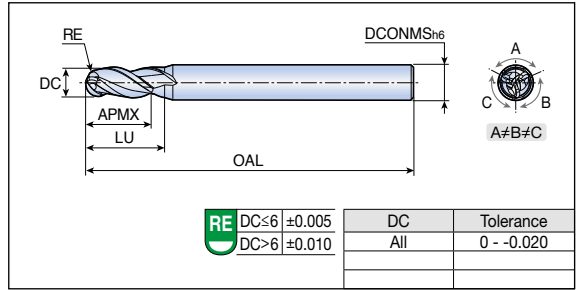
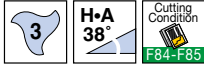

Designation	Dimension (mm)						Grade
	DC	RE	OAL	APMX	LU	DCONMS	
SBT 3040U	4	2	70	8	10	6	●
3060U	6	3	80	12	-	6	●
3080U	8	4	90	16	-	8	●
3100U	10	5	100	20	-	10	●
3120U	12	6	110	25	-	12	●

● Standard items

SBT 4...U



4 flute medium ball



- Excellent chatter damping due to unequal spacing of cutting edges

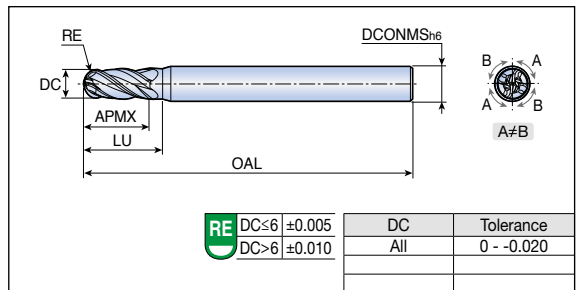

Designation	Dimension (mm)						Grade
	DC	RE	OAL	APMX	LU	DCONMS	
SBT 4040U	4	2	70	8	10	6	●
4060U	6	3	80	12	-	6	●
4080U	8	4	90	16	-	8	●
4100U	10	5	100	20	-	10	●
4120U	12	6	110	25	-	12	●

● Standard items

SED 4...U



4 flute medium flat



- Excellent chatter damping credit to unequal spacing of cutting edges

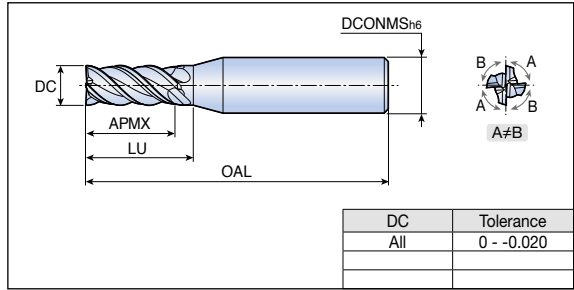

Designation	Feed (mm/tooth)	Dimension (mm)					Grade TT5515
		DC	OAL	APMX	LU	DCONMS	
SED 4030U	0.015-0.030	3	57	10	12	6	●
4040U	0.020-0.040	4	57	12	14	6	●
4050U	0.020-0.040	5	57	15	16	6	●
4060U	0.025-0.070	6	57	15	-	6	●
4080U	0.030-0.090	8	70	25	-	8	●
4100U	0.030-0.100	10	72	25	-	10	●
4120U	0.035-0.110	12	83	30	-	12	●
4160U	0.050-0.130	16	100	42	-	16	●
4200U	0.050-0.170	20	104	48	-	20	●

●: Standard items

SED 4...UL



4 flute long flat



- Excellent chatter damping credit to unequal spacing of cutting edges

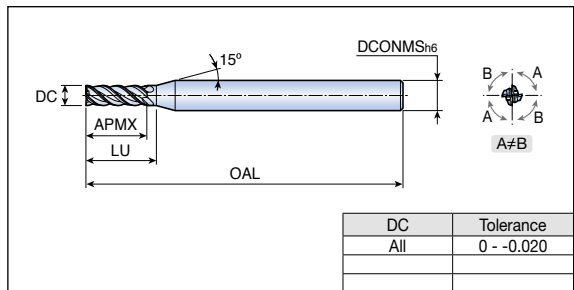

Designation	Feed (mm/tooth)	Dimension (mm)					Grade TT5515
		DC	OAL	APMX	LU	DCONMS	
SED 4030UL	0.015-0.030	3	63	10	12	6	●
4040UL	0.020-0.040	4	63	12	14	6	●
4060UL	0.025-0.070	6	65	20	-	6	●
4080UL	0.030-0.090	8	83	30	-	8	●
4100UL	0.030-0.100	10	83	35	-	10	●
4120UL	0.035-0.110	12	92	40	-	12	●

●: Standard items

SED 4...-R



4 flute medium corner radius



- Excellent chatter damping credit to unequal spacing of cutting edges

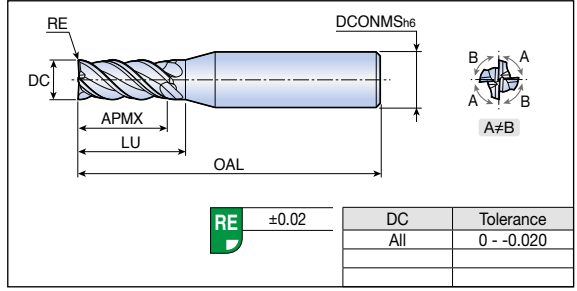

Designation	Feed (mm/tooth)	Dimension (mm)						Grade
		DC	RE	OAL	APMX	LU	DCONMS	
SED 4020U-R0.1	0.010-0.020	2	0.1	42	6	8	6	●
4030U-R0.2	0.015-0.030	3	0.2	57	10	12	6	●
4040U-R0.1	0.020-0.040	4	0.1	57	12	14	6	●
4040U-R0.2	0.020-0.040	4	0.2	57	12	14	6	●
4040U-R0.5	0.020-0.040	4	0.5	57	12	14	6	●
4050U-R0.15	0.020-0.040	5	0.15	57	15	16	6	●
4050U-R0.2	0.020-0.040	5	0.2	57	15	16	6	●
4060U-R0.2	0.025-0.070	6	0.2	57	15	-	6	●
4060U-R0.3	0.025-0.070	6	0.3	57	15	-	6	●
4060U-R0.5	0.025-0.070	6	0.5	57	15	-	6	●
4080U-R0.2	0.030-0.090	8	0.2	70	25	-	8	●
4080U-R0.3	0.030-0.090	8	0.3	70	25	-	8	●
4080U-R0.5	0.030-0.090	8	0.5	70	25	-	8	●
4100U-R0.2	0.030-0.100	10	0.2	72	25	-	10	●
4100U-R0.3	0.030-0.100	10	0.3	72	25	-	10	●
4100U-R0.5	0.030-0.100	10	0.5	72	25	-	10	●
4100U-R1.0	0.030-0.100	10	1.0	72	25	-	10	●
4120U-R0.3	0.035-0.110	12	0.3	83	30	-	12	●
4120U-R0.5	0.035-0.110	12	0.5	83	30	-	12	●
4120U-R1.0	0.035-0.110	12	1.0	83	30	-	12	●
4160U-R0.5	0.050-0.130	16	0.5	100	42	-	16	●
4160U-R1.0	0.050-0.130	16	1.0	100	42	-	16	●
4160U-R2.0	0.050-0.130	16	2.0	100	42	-	16	●
4160U-R3.0	0.050-0.130	16	3.0	100	42	-	16	●

● Standard items

SED 4...-C



4 flute medium corner chamfer

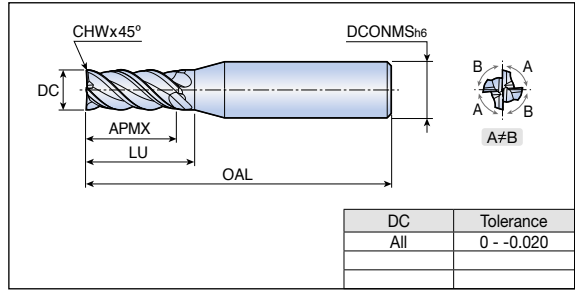

- Excellent chatter damping credit to unequal spacing of cutting edges

	H•A 45°	 F84-F85
--	-------------------	-------------

Designation	Feed (mm/tooth)	Dimension (mm)						Grade
		DC	CHW	OAL	APMX	LU	DCONMS	
SED 4040U-C0.1	0.020-0.040	4	0.1	57	12	14	6	●
4060U-C0.2	0.030-0.060	6	0.2	57	15	-	6	●
4080U-C0.3	0.030-0.090	8	0.3	70	25	-	8	●
4100U-C0.3	0.030-0.100	10	0.3	72	25	-	10	●
4120U-C0.4	0.035-0.110	12	0.4	83	30	-	12	●

- Standard items

SED 7



7 flute medium corner radius

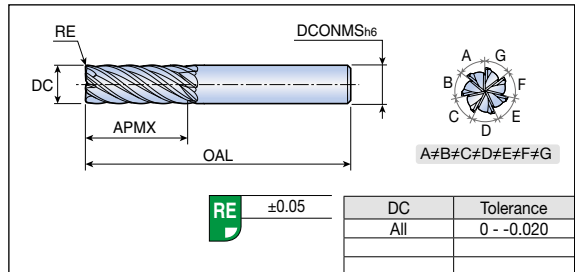

- Excellent chatter damping credit to unequal spacing of cutting edges
- For trochoidal operation

	H•A 38°	 F84-F85
--	-------------------	-------------

Designation	Feed (mm/tooth)	Dimension (mm)					Grade
		DC	RE	OAL	APMX	DCONMS	
SED 7060	0.02-0.04	6	0.5	57	15	6	●
7060-4D	0.02-0.04	6	0.5	70	24	6	●
7080	0.02-0.05	8	0.5	70	25	8	●
7080-4D	0.02-0.05	8	0.5	90	32	8	●
7100	0.03-0.07	10	0.5	72	25	10	●
7100-4D	0.03-0.07	10	0.5	100	40	10	●
7120	0.03-0.09	12	0.5	83	30	12	●
7120-4D	0.03-0.09	12	0.5	110	48	12	●
7140	0.04-0.10	14	0.5	90	35	14	●
7160	0.04-0.11	16	0.5	100	42	16	●
7160-4D	0.04-0.11	16	0.5	125	64	16	●
7200	0.05-0.12	20	0.5	104	48	20	●
7200-4D	0.05-0.12	20	0.5	150	80	20	●

▶ 4D: 4xD depth of cut

- Standard items

SED 7...N



7 flute medium corner radius with chip splitters



- Excellent chatter damping credit to unequal spacing of cutting edges with chip splitters
- For trochoidal operation

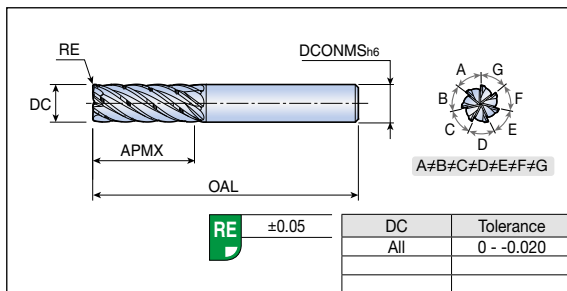

Designation	Feed (mm/tooth)	Dimension (mm)					Grade
		DC	RE	OAL	APMX	DCONMS	
SED 7060-N	0.02-0.04	6	0.5	57	15	6	●
7060-4D-N	0.02-0.04	6	0.5	70	24	6	●
7080-N	0.02-0.05	8	0.5	70	25	8	●
7080-4D-N	0.02-0.05	8	0.5	90	32	8	●
7100-N	0.03-0.07	10	0.5	72	25	10	●
7100-4D-N	0.03-0.07	10	0.5	100	40	10	●
7120-N	0.03-0.09	12	0.5	83	30	12	●
7120-4D-N	0.03-0.09	12	0.5	110	48	12	●
7160-N	0.04-0.11	16	0.5	100	42	16	●
7160-4D-N	0.04-0.11	16	0.5	125	64	16	●
7200-N	0.05-0.12	20	0.5	104	48	20	●
7200-4D-N	0.05-0.12	20	0.5	150	80	20	●

► N: Chip splitter type

●: Standard items

3-5 flute chip splitter type



- Excellent chatter damping credit to unequal spacing of cutting edges

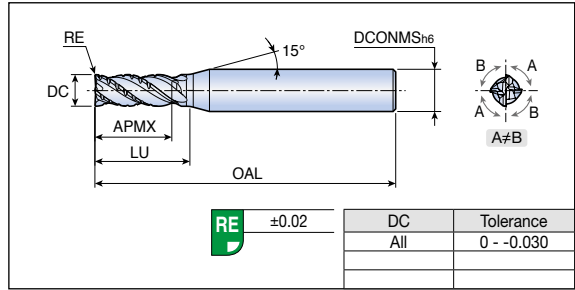

Designation	Feed (mm/tooth)	Dimension (mm)							Grade
		DC	NOF	RE	OAL	APMX	LU	DCONMS	TT5525
SER 3030M 020	0.010-0.030	3	3	0.2	52	8	10	6	●
3040M 020	0.020-0.040	4	3	0.2	52	10	12	6	●
4050M 020	0.020-0.040	5	4	0.2	57	13	18	6	●
4060M 020	0.025-0.070	6	4	0.2	57	13	-	6	●
4060M 050	0.025-0.070	6	4	0.5	57	13	-	6	●
4070M 020	0.025-0.070	7	4	0.2	63	18	25	8	●
4080M 020	0.030-0.090	8	4	0.2	63	19	-	8	●
4080M 100	0.030-0.090	8	4	1.0	63	19	-	8	●
4090M 030	0.030-0.090	9	4	0.3	72	20	30	10	●
4100M 030	0.030-0.100	10	4	0.3	72	22	-	10	●
4100M 100	0.030-0.100	10	4	1.0	72	22	-	10	●
4110M 030	0.030-0.100	11	4	0.3	83	25	35	12	●
4120M 030	0.035-0.110	12	4	0.3	83	26	-	12	●
4120M 100	0.035-0.110	12	4	1.0	83	26	-	12	●
5140M 050	0.035-0.110	14	5	0.5	92	28	40	16	●
5160M 050	0.050-0.130	16	5	0.5	92	32	-	16	●
5160M 150	0.050-0.130	16	5	1.5	92	32	-	16	●
5180M 050	0.050-0.130	18	5	0.5	110	38	55	20	●
5180M 200	0.050-0.130	18	5	2.0	110	38	55	20	●
5200M 050	0.050-0.170	20	5	0.5	110	38	-	20	●
5200M 200	0.050-0.170	20	5	2.0	110	38	-	20	●

► NOF: Number of flutes ●: Standard items

AWE 3



3 flute wave flat

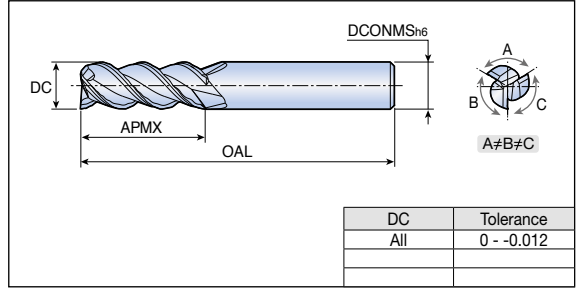

• Wave cutting edge



Designation	Feed (mm/tooth)	Dimension (mm)				Grade
		DC	OAL	APMX	DCONMS	
AWE 3060	0.03-0.07	6	52	14	6	●
3080	0.03-0.09	8	60	14	8	●
3100	0.03-0.10	10	68	19	10	●
3120	0.03-0.12	12	76	22	12	●
3140	0.05-0.14	14	85	24	14	●
3160	0.05-0.14	16	90	30	16	●
3180	0.05-0.15	18	110	34	18	●
3200	0.05-0.15	20	110	38	20	●

●: Standard items

AWE 3...ML



3 flute wave long flat

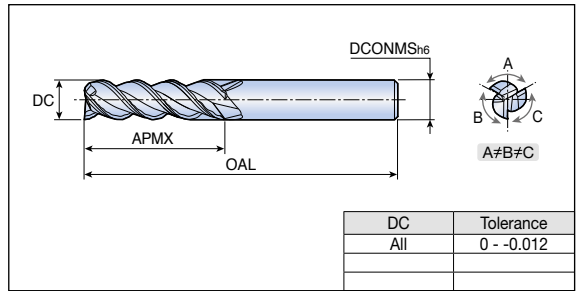

• Wave cutting edge

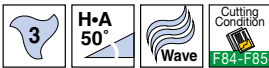

Designation	Feed (mm/tooth)	Dimension (mm)				Grade
		DC	OAL	APMX	DCONMS	
AWE 3060ML	0.03-0.07	6	65	20	6	●
3080ML	0.03-0.09	8	75	20	8	●
3100ML	0.03-0.10	10	80	25	10	●
3120ML	0.03-0.12	12	95	30	12	●
3140ML	0.03-0.12	14	110	35	14	●
3160ML	0.05-0.14	16	110	40	16	●
3180ML	0.05-0.15	18	125	45	18	●
3200ML	0.05-0.15	20	125	45	20	●

●: Standard items

AWE 3...ML-R



3 flute wave long corner radius

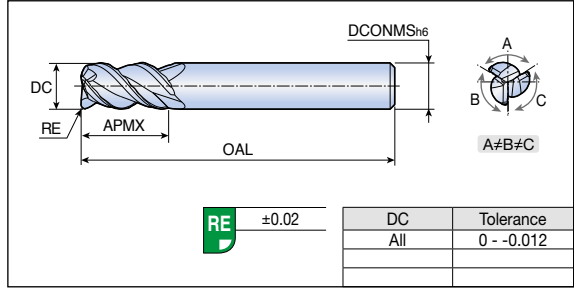

- Wave cutting edge



Designation	Feed (mm/tooth)	Dimension (mm)				Grade UF10
		DC	OAL	APMX	DCONMS	
AWE 3060ML-R0.5	0.03-0.07	6	65	20	6	●
3080ML-R0.5	0.03-0.09	8	75	20	8	●
3100ML-R1.0	0.03-0.10	10	80	25	10	●
3120ML-R1.0	0.03-0.12	12	95	30	12	●

- : Standard items

CRF 4



4 flute, Ceramic end mills

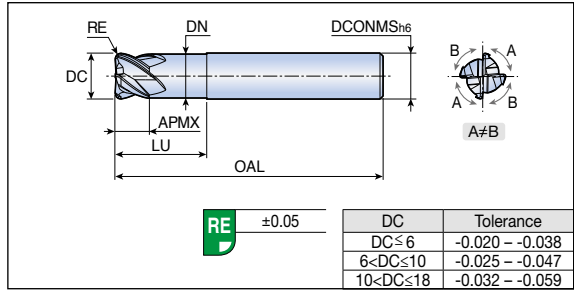

Designation	Feed (mm/tooth)	Dimension (mm)							Grade TC3030
		DC	RE	OAL	APMX	LU	DN	DCONMS	
CRF 4060 050 120	0.02-0.03	6	0.5	50	4.5	12	5.8	6	●
4080 100 160	0.02-0.03	8	1.0	57	6.0	16	7.7	8	●
4100 100 200	0.02-0.04	10	1.0	63	7.5	20	9.6	10	●
4120 150 240	0.03-0.05	12	1.5	70	9.0	24	11.5	12	●
4160 200 320	0.03-0.05	16	2.0	83	12.0	32	15.5	16	●

- : Standard items

CRF 6



6 flute, Ceramic end mills

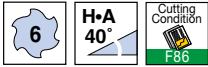
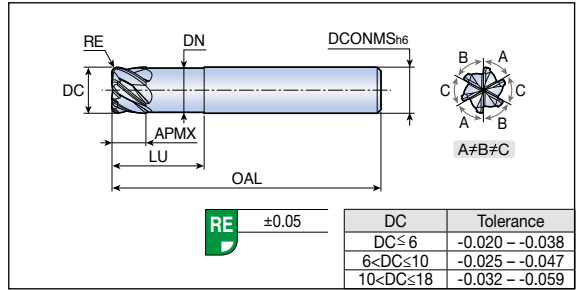

Designation	Feed (mm/tooth)	Dimension (mm)							Grade
		DC	RE	OAL	APMX	LU	DN	DCONMS	
CRF 6060 050 120	0.02-0.03	6	0.5	50	4.5	12	5.8	6	●
6080 100 160	0.02-0.03	8	1.0	57	6.0	16	7.7	8	●
6100 100 200	0.02-0.04	10	1.0	63	7.5	20	9.6	10	●
6120 150 240	0.03-0.05	12	1.5	70	9.0	24	11.5	12	●
6160 200 320	0.03-0.05	16	2.0	83	12.0	32	15.5	16	●

●: Standard items

CRH 4



4 flute, Ceramic end mills for high feed milling

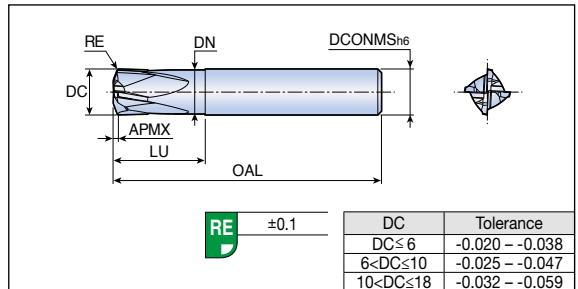

Designation	Feed (mm/tooth)	Dimension (mm)							Grade
		DC	RE	OAL	APMX	LU	DN	DCONMS	
CRH 4060	0.1-0.15	6	0.7	50	0.55	12	5.8	6	●
4080	0.1-0.2	8	0.9	57	0.75	16	7.7	8	●
4100	0.1-0.2	10	1.0	63	0.85	20	9.6	10	●
4120	0.1-0.3	12	1.4	70	1.15	24	11.5	12	●
4160	0.1-0.3	16	1.8	83	1.55	32	15.5	16	●

► RE: Program corner R

●: Standard items

DMB 2



2 flute miniature ball

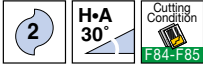
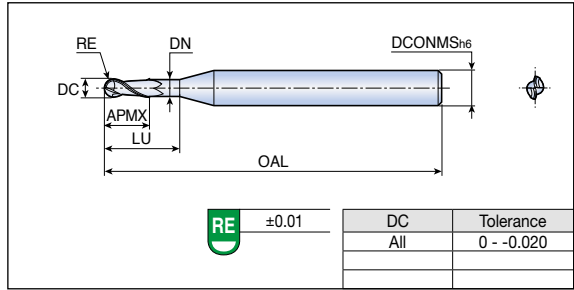

Designation	Dimension (mm)							Grade
	DC	RE	OAL	APMX	LU	DN	DCONMS	
DMB 2006-0.6x3.0	0.6	0.3	40	0.6	3.0	0.55	3	●
2010-1.0x5.0	1.0	0.5	40	1.0	5.0	0.95	3	●
2010-1.0x8.5	1.0	0.5	40	1.0	8.5	0.95	3	●
2015-1.5x7.5	1.5	0.75	50	1.5	7.5	1.4	3	●
2015-1.5x12.0	1.5	0.75	50	1.5	12.0	1.4	3	●
2020-2.2x10.0	2.0	1.0	60	2.2	10.0	1.9	3	●
2020-2.2x16.0	2.0	1.0	60	2.2	16.0	1.9	3	●

●: Standard items

DEB 2...S



2 flute short ball

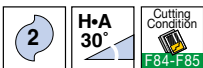
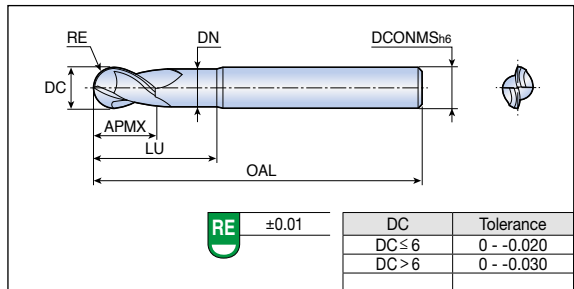

Designation	Dimension (mm)							Grade
	DC	RE	OAL	APMX	LU	DN	DCONMS	
DEB 2030S	3	1.5	60	4.5	6.5	2.8	6	●
2040S	4	2.0	65	6.0	8.0	3.7	6	●
2060S	6	3.0	75	9.0	12.0	5.6	6	●
2120S	12	6.0	90	18.0	36.0	11.4	12	●

●: Standard items

DEB 2...L



2 flute long neck ball

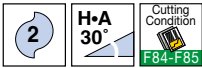
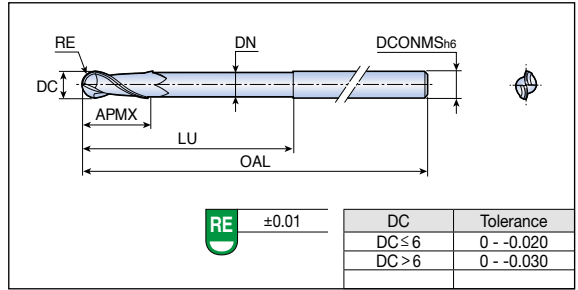

Designation	Dimension (mm)							Grade
	DC	RE	OAL	APMX	LU	DN	DCONMS	
DEB 2030L-4	3	1.5	80	15	25	2.9	4	●
2040L-4	4	2.0	80	20	30	3.9	4	●
2050L	5	2.5	100	30	50	4.9	6	●
2060L	6	3.0	100	30	50	5.5	6	●
2080L	8	4.0	110	40	60	7.5	8	●
2120L	12	6.0	130	55	75	11.5	12	●

● Standard items

DMR 2



2 flute miniature corner radius

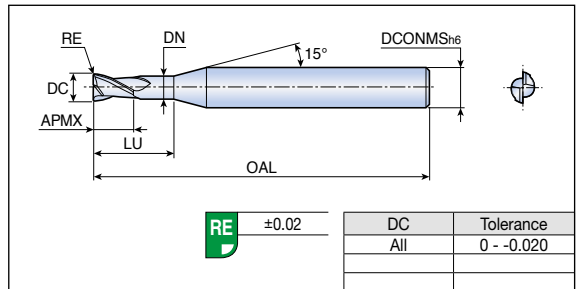

Designation	Feed (mm/tooth)	Dimension (mm)							Grade
		DC	RE	OAL	APMX	LU	DN	DCONMS	
DMR 2006-0.9x3.0	0.006-0.010	0.6	0.05	40	0.9	3.0	0.55	3	●
2008-1.2x4.0	0.008-0.015	0.8	0.05	40	1.2	4.0	0.75	3	●
2010-1.5x5.0	0.010-0.020	1.0	0.1	40	1.5	5.0	0.95	3	●
2010-1.5x8.5	0.010-0.020	1.0	0.1	40	1.5	8.5	0.95	3	●
2012-1.8x6.0	0.010-0.025	1.2	0.1	50	1.8	6.0	1.15	3	●
2015-2.2x7.5	0.015-0.035	1.5	0.15	50	2.2	7.5	1.4	3	●
2015-2.2x12.0	0.015-0.030	1.5	0.15	50	2.2	12.0	1.4	3	●
2020-2.2x10.0	0.015-0.040	2.0	0.15	60	2.2	10.0	1.9	3	●
2020-2.2x16.0	0.015-0.035	2.0	0.15	60	2.2	16.0	1.9	3	●

● Standard items

DER 3...S



3 flute short corner radius

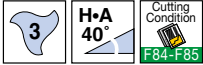
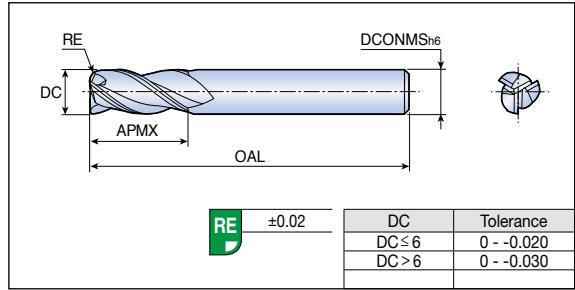

Designation	Feed (mm/tooth)	Dimension (mm)					Grade
		DC	RE	OAL	APMX	DCONMS	
DER 3030S-3	0.025-0.050	3	0.15	40	12	3	●
3040S-4	0.040-0.060	4	0.2	50	14	4	●
3050S-5	0.050-0.080	5	0.3	50	16	5	●
3060S	0.060-0.090	6	0.3	65	20	6	●
3080S	0.070-0.100	8	0.5	65	20	8	●
3100S	0.080-0.130	10	0.5	75	25	10	●
3120S	0.100-0.150	12	0.5	75	25	12	●

●: Standard items

DER 3...L



3 flute long corner radius

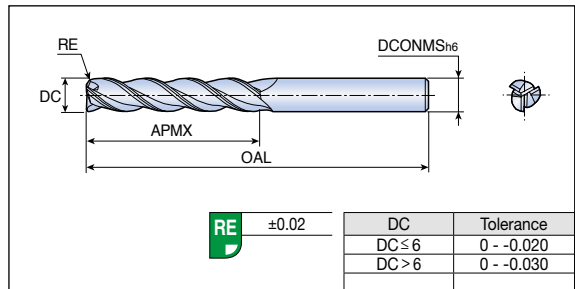

Designation	Feed (mm/tooth)	Dimension (mm)					Grade
		DC	RE	OAL	APMX	DCONMS	
DER 3040L-4	0.03-0.05	4	0.2	60	30	4	●
3050L-5	0.04-0.07	5	0.3	70	35	5	●
3060L	0.05-0.08	6	0.3	100	40	6	●
3080L	0.06-0.09	8	0.5	100	40	8	●
3100L	0.07-0.12	10	0.5	100	40	10	●
3120L	0.09-0.14	12	0.5	100	45	12	●

●: Standard items

Roughing for composite material (Chip splitter)

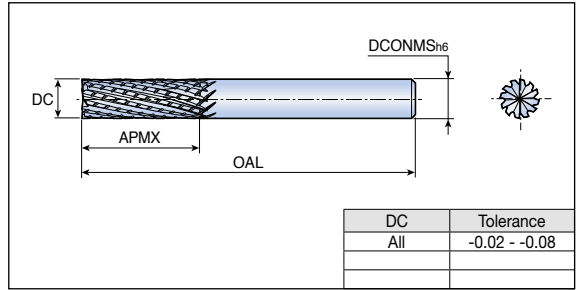

Designation	Feed (mm/tooth)	Dimension (mm)					Grade TTD610
		DC	NOF	OAL	APMX	DCONMS	
RRFE 040	0.01-0.02	4	6	50	12	4	●
060	0.01-0.02	6	8	65	18	6	●
080	0.01-0.03	8	10	75	24	8	●
100	0.02-0.04	10	12	85	30	10	●
120	0.02-0.05	12	12	100	36	12	●

► NOF: Number of flutes

●: Standard items

RCFE

Roughing for composite material (Multi-flute)

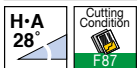
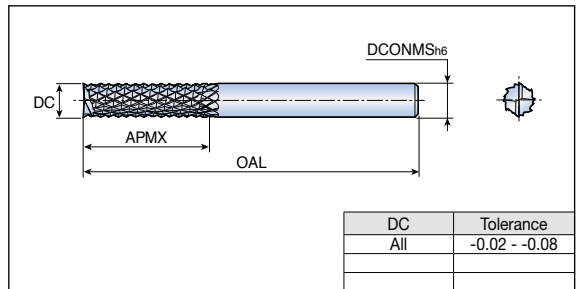

Designation	Feed (mm/rev)	Dimension (mm)				Grade TTD610
		DC	OAL	APMX	DCONMS	
RCFE 040	0.03-0.06	4	50	12	4	●
060	0.07-0.15	6	65	18	6	●
080	0.10-0.20	8	75	24	8	●
100	0.15-0.30	10	85	30	10	●
120	0.20-0.40	12	100	36	12	●

●: Standard items

RCME



Medium to finishing for composite materials (Multi-flute)

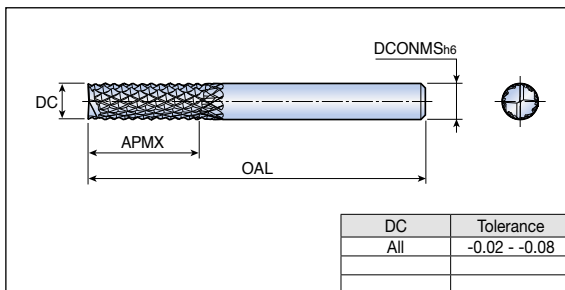

Designation	Feed (mm/rev)	Dimension (mm)				Grade
		DC	OAL	APMX	DCONMS	TTD610
RCME 040	0.03-0.06	4	50	12	4	●
060	0.07-0.15	6	65	18	6	●
080	0.10-0.20	8	75	24	8	●
100	0.15-0.30	10	85	30	10	●
120	0.20-0.40	12	100	36	12	●

●: Standard items

RCDE



Medium to finishing for composite materials (Cutting edge for drilling + multi-flute)

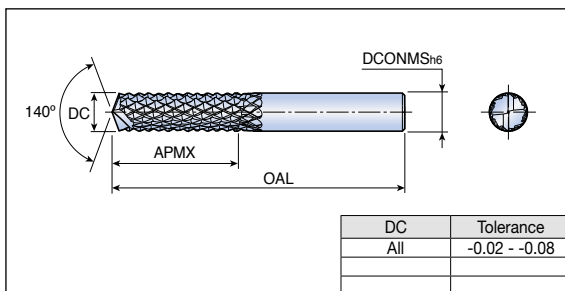

Designation	Feed (mm/rev)	Dimension (mm)				Grade
		DC	OAL	APMX	DCONMS	TTD610
RCDE 040	0.03-0.06	4	50	12	4	●
060	0.07-0.15	6	65	18	6	●
080	0.10-0.20	8	75	24	8	●
100	0.15-0.30	10	85	30	10	●
120	0.20-0.40	12	100	36	12	●

●: Standard items

4 and 6 flute for finishing of composite materials (Left and right hand helix type)

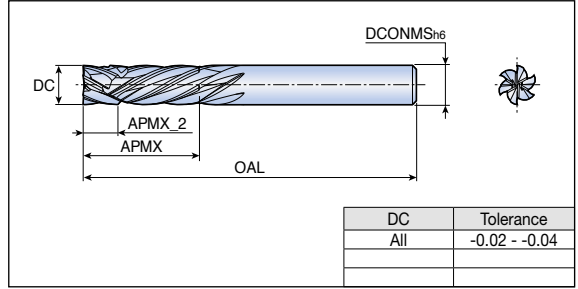

DC	Tolerance
All	-0.02 - -0.04

	H-A 30°	Cutting Condition F8
--	-------------------	-------------------------

Designation	Feed (mm/tooth)	Dimension (mm)						Grade
		DC	NOF	OAL	APMX	APMX_2	DCONMS	
RCOM 4060	0.02-0.04	6	4	65	18	6.7	6	●
4080	0.02-0.05	8	4	75	24	9.2	8	●
6100	0.03-0.06	10	6	85	30	7.9	10	●
6120	0.04-0.08	12	6	100	36	9.2	12	●

- ▶ NOF: Number of flutes
 - ▶ Notice: For best machining performance, the end mill's intersection point(APMX_2) should be positioned at the center of the workpiece thickness.
- : Standard items

Recommended Cutting Conditions

Machining data for solid end mill

ISO	Material	Condition	Tensile strength (N/mm ²)	Hardness HB	Material No.	
P	Non-alloy steel, cast steel, free cutting steel	<0.25%C	Annealed	420	125	1
		>=0.25%C	Annealed	650	190	2
		<0.55%C	Quenched and tempered	850	250	3
		>=0.55%C	Annealed	750	220	4
			Quenched and tempered	1000	300	5
	Low alloy steel and cast steel (less than 5% of alloying elements)		Annealed	600	200	6
				930	275	7
			Quenched and tempered	1000	300	8
				1200	350	9
	High alloy steel, cast steel and tool steel		Annealed	680	200	10
			Quenched and tempered	1100	325	11
M	Stainless steel and cast steel	Ferritic / martensitic	680	200	12	
		Martensitic	820	240	13	
		Austenitic	600	180	14	
K	Gray cast iron (GG)	Ferritic		160	15	
		Pearlitic		250	16	
	Cast iron nodular (GGG)	Ferritic		180	17	
		Pearlitic		260	18	
	Malleable cast iron	Ferritic		130	19	
	Pearlitic		230	20		
N	Aluminum - Wrought alloy	Not cureable		60	21	
		Cured		100	22	
	Aluminum-cast, alloyed	<=12% Si	Not cureable		75	23
			Cured		90	24
		>12% Si	High temp.		130	25
	Copper alloys	>1% Pb	Free cutting		110	26
			Brass		90	27
			Electrolytic copper		100	28
	Non-metallic		Duroplastics, graphite		70 Shore D	29
			Hard rubber		55 Shore D	30
S	High temp. alloys	Fe based	Annealed		200	31
			Cured		280	32
		Ni or Co based	Annealed		250	33
			Cured		350	34
	Titanium, Ti alloys		Cast		320	35
			Pure	Rm 400	190	36
H	Hardened steel		Alpha+beta alloys cured	Rm 1050	310	37
			Hardened		55HRC	38
	Chilled cast iron	Cast	Hardened		60HRC	39
			Cast		400	40
Cast iron nodular	Hardened		55HRC	41		

► For more information of material groups, see the materials & grades "material conversion table"

■ Steel
 ■ Stainless steel
 ■ Cast iron
 ■ Nonferrous
 ■ High temp. alloys
 ■ Hardened steel

Recommended Cutting Conditions

Machining data for solid end mill

Cutting speed Vc(m/min)								
CBN	Coated						Uncoated	Ceramic
TB7015	TT5505	TT5515	TT5520/TT5513	TT5525/TT5523	TT5543	TTA101	UF10N/UF10	TC3030
	260-300	260-280	210-270	210-220	170-200		140-200	
	200-250	200-230	160-220	160-180	140-170		120-160	
	160-230	160-220	130-200	130-180	120-150		100-150	
	160-230	160-220	130-200	130-180	100-140		100-140	
	140-200	140-180	110-160	110-140	90-130		90-130	
	160-230	160-220	130-200	130-180	100-150		110-150	
	120-200	120-180	100-160	100-140	90-130		80-130	
	140-200	130-180	100-160	100-140	90-130		90-130	
	140-200	140-180	110-160	110-140	90-130		100-130	
	140-200	130-180	100-160	100-140	90-130		90-130	
	80-150	70-120	60-110	60-100	50-90		50-80	
		80-160	60-140	60-130	50-110		60-110	
		60-150	50-130	50-120	40-100		40-100	
		60-120	50-110	50-100	40-80		40-80	
	100-300	80-260	60-240	60-210	50-180		60-180	
	130-280	130-240	100-220	100-190	100-170		90-170	
	150-280	150-270	120-240	120-220	110-200		100-200	
	90-280	90-270	70-240	70-220	110-200		60-200	
	150-280	150-270	120-240	120-220	110-200		100-200	
	140-250	140-240	110-220	110-190	100-180		100-170	
						800-900	800-900	
						700-800	700-800	
						800-900	800-900	
						750-850	750-850	
						400-450	400-450	
						500-550	500-550	
						500-550	500-550	
						350-380	350-380	
	20-40	20-40	20-30	20-30	20-30		10-20	
	20-30	20-30	20-30	20-30	20-30		10-20	
	20-30	20-30	20-30	20-30	20-30		20-50	300-1000
	20-30	20-30	20-30	20-30	20-30		20-50	300-1000
	30-80	30-70	20-60	20-60	20-60		20-50	300-1000
		30-70	20-60	20-60	20-60		20-30	
		30-70	20-60	20-60	20-60		20-30	
100-210	30-60						40-60	
90-200	30-40						20-30	
120-200	70-90	60-80	40-70				65-75	
120-200	30-60	30-50	20-40				40-45	

Recommended Cutting Conditions



Machining data for ceramic end mill

CRF 4 teeth & 6 teeth

(Unit: mm)

Diameter	Cutting speed (m/min)	Feed (mm/tooth)	Shouldering, profiling		Slotting
			ap	ae	ae
Ø6	300-1000	0.02-0.03	-0.6xD	-0.1xD	-0.05xD
Ø8	300-1000	0.02-0.03	-0.6xD	-0.1xD	-0.05xD
Ø10	300-1000	0.02-0.04	-0.6xD	-0.1xD	-0.05xD
Ø12	300-1000	0.03-0.05	-0.6xD	-0.1xD	-0.05xD
Ø16	300-1000	0.03-0.05	-0.6xD	-0.1xD	-0.05xD

▶ ae must not exceed a maximum 1 mm

ap: axial direction DOC ae: radial direction DOC

▶ Apply a 30% reduction in feed during slotting, ramping (less 2.5°)

CRH 4 teeth

(Unit: mm)

Diameter	Cutting speed (m/min)	Feed (mm/tooth)	Shouldering, profiling	
			ap	ae
Ø6	300-1000	0.1-0.15	-0.05xD	-0.6xD
Ø8	300-1000	0.1-0.2	-0.05xD	-0.6xD
Ø10	300-1000	0.1-0.2	-0.05xD	-0.6xD
Ø12	300-1000	0.1-0.3	-0.05xD	-0.6xD
Ø16	300-1000	0.1-0.3	-0.05xD	-0.6xD

▶ ae must not exceed a maximum 1 mm

ap: axial direction DOC ae: radial direction DOC

▶ Apply a 30% reduction in feed during ramping (less 2.5°)

Programming tip - CRH

Diameter (CRH 4 teeth)	R (Program)	A Un-machined material thickness
Ø6	0.7	0.35
Ø8	0.9	0.47
Ø10	1.0	0.50
Ø12	1.4	0.70
Ø16	1.8	0.95

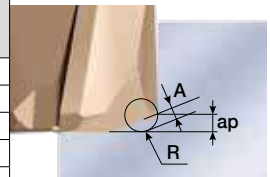

Programming tip - HFM 2 / HFM 4

Designation	Diameter	R (Program)	A (Un-machined)	ap (Max)
HFM 2040	Ø4	0.38	0.25	0.3
HFM 2060	Ø6	0.65	0.43	0.5
HFM 2080	Ø8	0.87	0.57	0.75
HFM 2010	Ø10	1.09	0.71	1
HFM 2012	Ø12	1.3	0.86	1.1
HFM 4060	Ø6	0.59	0.38	0.5
HFM 4080	Ø8	0.78	0.51	0.7
HFM 4010	Ø10	0.85	0.55	0.75
HFM 4012	Ø12	1.17	0.77	1.05

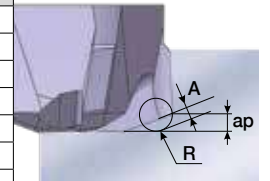

Recommended Cutting Conditions



Machining data for composite material

Grade: TTD610

Material		Cutting Speed Vc(m/min)					
		RRFE		RCFE		RCDE	
		Shouldering	Slotting	Shouldering	Slotting	Shouldering	Slotting
CFRP	CFRP	100-300	50-120	100-300	50-120	80-250	50-120
	Honeycomb	150-250	100-200	150-250	100-200	120-200	100-200
GFRP	GFRP	50-150	30-70	50-150	30-70	50-130	30-70
	Honeycomb	150-250	100-200	150-250	100-200	120-200	100-200

Material		Cutting Speed Vc(m/min)					
		RCME		RCOM		RDCF	
		Shouldering	Slotting	Shouldering	Slotting	Shouldering	Slotting
CFRP	CFRP	80-250	50-120	50-200	50-120	100-300	50-120
	Honeycomb	120-200	100-200	-	-	-	-
GFRP	GFRP	50-130	30-70	50-100	30-70	50-150	30-70
	Honeycomb	120-200	100-200	-	-	-	-

Material		RCDE & H-Drill					
		Drilling					
		Cutting speed Vc (m/min)	Drill diameter (mm) vs. Feed (mm/rev)				
Ø3.0-Ø6.0	Ø6.1-Ø8.0		Ø8.1-Ø10.0	Ø10.1-Ø12.7			
CFRP	50-150	0.02-0.07	0.03-0.08	0.03-0.08	0.04-0.10		
GFRP	40-120	0.02-0.07	0.03-0.08	0.03-0.08	0.04-0.10		



TOOLING SYSTEM



TOOLING SYSTEM



contents

Tool Selection Guide	G4
DIN69871	G8
HSK	G31
BT MAS	G57
DIN2080	G88
C-ADAPTER	G99
Straight & Morse Taper Shank	G112
Typhoon Spindle	G129
Collet	G140
Accessories	G166
Technical Data	G180

Guide to Icons



➤ Run-out



➤ Surface Hardness

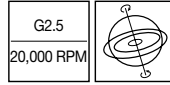

➤ Balance Grade



➤ Taper Shank Grade



➤ Surface Finish Grade



➤ Technical Data Page



➤ ER Collet Page



➤ TSK Collet Page



➤ Straight Collet Page



➤ Pull Stud Page



➤ Preset Screw Page

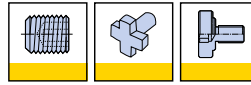

➤ Lock Screw Page



➤ ER-SRK Page



➤ Nut Page



➤ Tap Adapter Page



➤ Cooling Tube Page



➤ Tube Wrench Page

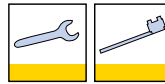

➤ Wrench Page



➤ Driving Ring Page



➤ Induction Heating Unit Page



➤ Thermal Heating Unit Page



Tool Selection Guide

Tooling system

Milling chuck

- DIN69871 G15
- HSK G39
- BT MAS-403 G65
- DIN2080 G91



Collet (NCSR) G156-G158



ST shank G113-G117



Collet (ER) G142-G150



GTIN collet G163-G164



Collet chuck

- DIN69871 G10-G12
- HSK G33-G37
- BT MAS-403 G59-G62
- DIN2080 G90
- C-ADAPTER G101-G102
- ST shank G113-G117
- MT shank G128



Collet (ER) G142-G150



T-SHRINK Collet G159-G161



T-FLEX collet G162



GTIN collet G163-G164

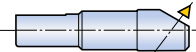
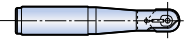
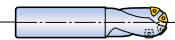

TSK collet chuck

- DIN69871 G13
- HSK G38
- BT MAS-403 G63



TSK collet G151-G153



TSHRINK chuck

- DIN69871 G19
- HSK G42-G43
- BT MAS-403 G70-G71
- C-ADAPTER G109



- DIN69871 G20
- HSK G44-G45
- BT MAS-403 G72-G73
- ST shank G125



THYCHUCK chuck

- DIN69871 G21
- HSK G46-G47
- BT MAS-403 G74-G75



THC collet G154-G155



Tool Selection Guide

Tooling system

End mill holder

- DIN69871 G16-G18
- HSK G40-G41
- BT MAS-403 G66-G69
- DIN2080 G92
- C-ADAPTER G103-G105

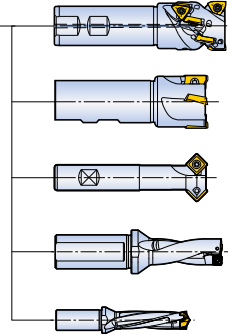

Face mill / Shell end mill arbor

- DIN69871 G22-G23, G25
- HSK G48-G50, G52
- BT MAS-403 G77-G81, G83
- DIN2080 G93-G94
- C-ADAPTER G106, G108

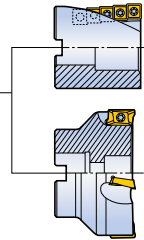

Combi face mill / Combi shell end mill arbor

- DIN69871 G24
- HSK G51
- BT MAS-403 G82
- DIN2080 G95
- C-ADAPTER G107

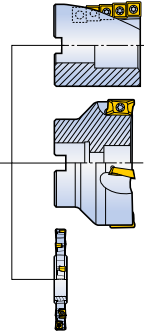

Slotting cutter arbor

- DIN69871 G26
- BT MAS-403 G76



Centering plug

- DIN2080 G98



Tool Selection Guide

Tooling system

Adapter

- DIN69871 G29
- BT MAS-403 G85



Morse taper adapter

- DIN69871 G27-G28
- HSK G53
- BT MAS-403 G84-G85
- DIN2080 G96-G97



Drill chuck arbor

- DIN69871 G29
- BT MAS-403 G86
- DIN2080 G98

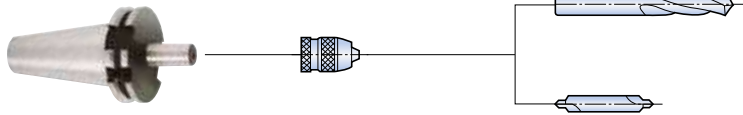

Tap chuck (GTI)

- DIN69871 G14
- BT MAS-403 G64

- GTI ER collet chuck G126

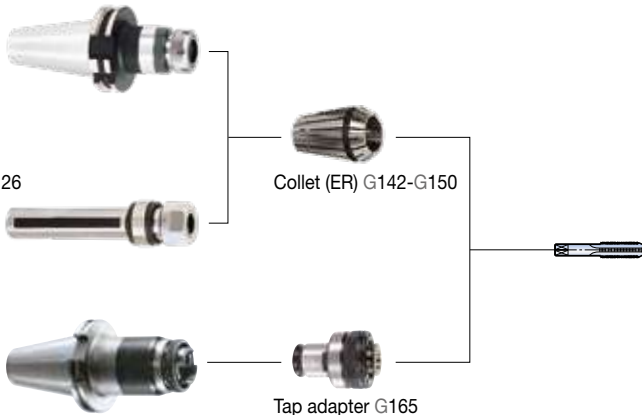

Collet (ER) G142-G150

Tap adapter G165

Tool Selection Guide

Tooling system

GFI floating reamer chuck (GFI)

- ST shank G127



T-FLEXTEC

- DIN69871 G30
- HSK G54-G55
- BT MAS-403 G87
- C-ADAPTER G110
- ST shank G118-G121



Blank

- HSK G56
- C-ADAPTER G111



GREEN Typhoon

- ER shank G130
- BT MAS-403 G131
- HSK G132
- C-ADAPTER G133
- ST shank G134

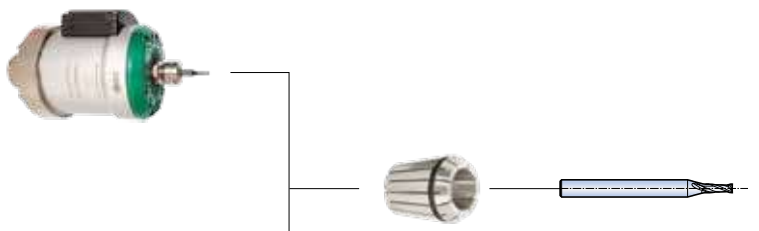

HPC Typhoon

- ER shank G135
- BT MAS-403 G136
- HSK G137
- ST shank G138



DIN69871



DIN69871 Form A/AD/B/ADB

Standard toolholder

Type "A"

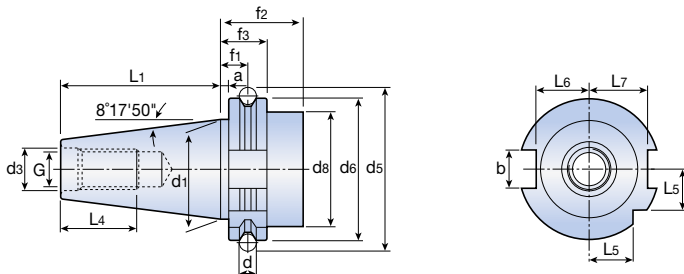

Type "AD"

Coolant hole

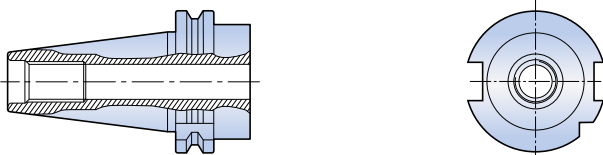

Type "B"

Coolant through flange

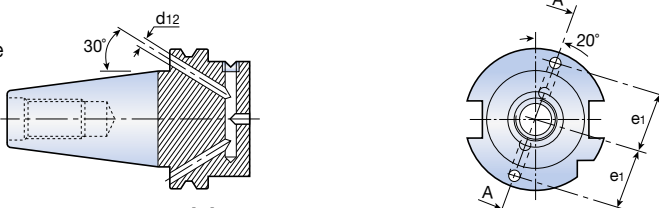

A-A

Type "ADB"

Coolant hole or coolant through flange

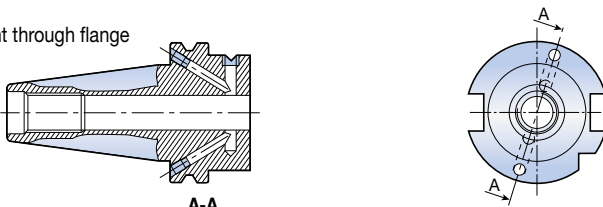

A-A

Shank	a ±0.1	b (H12)	d	d1	G	d3 (H7)	d5 ±0.05	d6	d8max	f1 ±0.1
30	3.2	16.1	7	31.75	M12	13	59.30	50.00	45	11.1
40	3.2	16.1	7	44.45	M16	17	72.30	63.55	50	11.1
50	3.2	25.7	7	69.85	M24	25	107.25	97.50	80	11.1

Shank	f2min	f3 -0.1	L1 -0.3	L4min	L5 -0.3	L6 -0.4	L7 -0.4	e1 ±0.1	d12	Taper AT3
30	35	19.1	47.80	24	15.0	16.4	19.0	21	4	0.002
40	35	19.1	68.40	32	18.5	22.8	25.0	27	4	0.003
50	35	19.1	101.75	47	30.0	35.5	37.7	42	6	0.004

- ▶ For non-stock items: Supply condition is subject to availability
If not available in stock then MOQ (Minimum order qty) will be applicable

DIN69871-ER

ER collet chucks

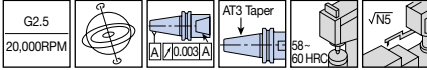
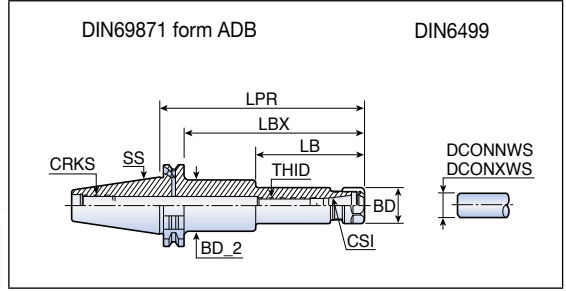

Designation	Dimension (mm)											
	SS	CSI	DCONNWS	DCONXWS	BD	BD_2	LPR	LBX	LB	CRKS	THID	
DIN69871 30 ER 16x63⁽¹⁾	30	ER16	0.5	10.0	28	-	63	43.9	28	M12	M10	
DIN69871 40 ER 16x63	40	ER16	0.5	10.0	28	-	63	43.9	-	M16	M10	
ER 16x100	40	ER16	0.5	10.0	28	-	100	80.9	-	M16	M10	
ER 16x160⁽¹⁾	40	ER16	0.5	10.0	28	40	160	140.9	85	M16	M10	
ER 20x63	40	ER20	1.0	13.0	34	-	63	43.9	-	M16	M12	
ER 20x100	40	ER20	1.0	13.0	34	-	100	80.9	-	M16	M12	
ER 20x160⁽¹⁾	40	ER20	1.0	13.0	34	44	160	140.9	19	M16	M12	
DIN69871 50 ER 16x100⁽¹⁾	50	ER16	0.5	10.0	28	-	100	80.9	-	M24	M10	
ER 16x160⁽¹⁾	50	ER16	0.5	10.0	28	40	160	140.9	85	M24	M10	
ER 16x200⁽¹⁾	50	ER16	0.5	10.0	28	40	200	180.9	110	M24	M10	
ER 20x100⁽¹⁾	50	ER20	1.0	13.0	34	-	100	80.9	-	M24	M12	
ER 20x160⁽¹⁾	50	ER20	1.0	13.0	34	45	160	140.9	86	M24	M12	

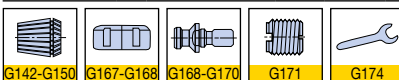

► Add B for coolant through flange
 ► ⁽¹⁾ Balance to G6.3 at 12,000RPM

DIN69871-ER

ER collet chucks

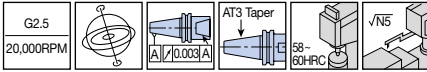
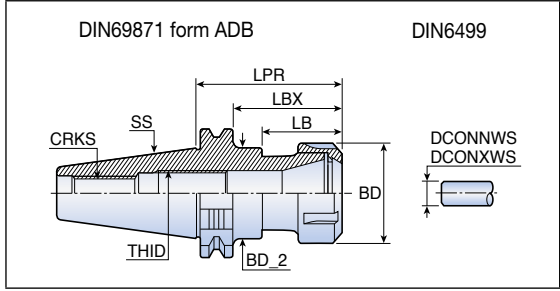

Designation	Dimension (mm)											
	SS	CSI	DCONNWS	DCONXWS	BD	BD_2	LPR	LBX	LB	CRKS	THID	
DIN69871 40 ER 25x65	40	ER25	1.0	16.0	42	32.4	65	45.9	28.0	M16	M16x2	
ER 25x100	40	ER25	1.0	16.0	42	-	100	80.9	-	M16	M16x2	
ER 25x150	40	ER25	1.0	16.0	42	-	150	130.9	-	M16	M16x2	
ER 32x65	40	ER32	2.0	20.0	50	40.4	65	45.9	32.0	M16	M22x1.5	
ER 32x100	40	ER32	2.0	20.0	50	49.0	100	80.9	35.0	M16	M22x1.5	
ER 32x150	40	ER32	2.0	20.0	50	49.0	150	130.9	35.0	M16	M22x1.5	
ER 40x70	40	ER40	3.0	26.0	63	50.4	70	50.9	32.0	M16	M28x1.5	
ER 40x100	40	ER40	3.0	26.0	63	50.4	100	80.9	32.0	M16	M28x1.5	
DIN69871 50 ER 25x100⁽¹⁾	50	ER25	1.0	16.0	42	-	100	80.9	-	M24	M16x2	
ER 25x150⁽¹⁾	50	ER25	1.0	16.0	42	50.0	150	130.9	80.9	M24	M16x2	
ER 25x200⁽¹⁾	50	ER25	1.0	16.0	42	55.0	200	180.9	85.0	M24	M16x2	
ER 32x100⁽¹⁾	50	ER32	2.0	20.0	50	-	100	80.9	-	M24	M22x1.5	
ER 32x150⁽¹⁾	50	ER32	2.0	20.0	50	-	150	130.9	-	M24	M22x1.5	
ER 32x200⁽¹⁾	50	ER32	2.0	20.0	50	-	200	180.9	-	M24	M22x1.5	
ER 40x100⁽¹⁾	50	ER40	3.0	26.0	63	-	100	80.9	-	M24	M28x1.5	
ER 40x150⁽¹⁾	50	ER40	3.0	26.0	63	-	150	130.9	-	M24	M28x1.5	
ER 40x200⁽¹⁾	50	ER40	3.0	26.0	63	-	200	180.9	-	M24	M28x1.5	
ER 50x100⁽¹⁾	50	ER50	10.0	34.0	78	-	100	80.9	-	M24	M36x1.5	
ER 50x150⁽¹⁾	50	ER50	10.0	34.0	78	-	150	130.9	-	M24	M36x1.5	

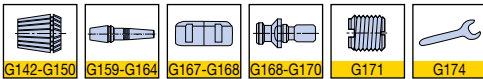

- Add B for coolant through flange
- ⁽¹⁾ Balance to G6.3 at 12,000RPM

DIN69871-ER-SHORT



Short ER collet chucks

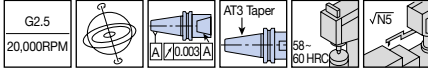
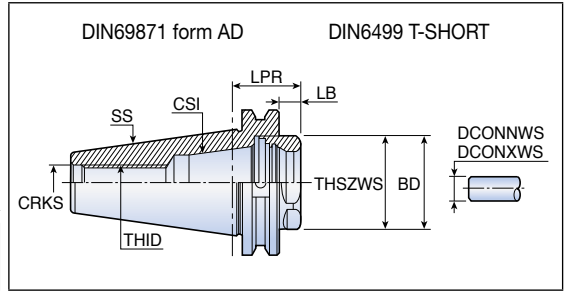

Designation	Dimension (mm)									
	SS	CSI	DCONNWS	DCONXWS	BD	LPR	LB	CRKS	THSZWS	THID
DIN69871 40 ER32 SHORT	40	ER32	2.0	20.0	40	25.1	6.0	M16	M40x1.5	-
DIN69871 50 ER32 SHORT	50	ER32	2.0	20.0	40	28.6	9.5	M24	M40x1.5	M22x1.5
ER40 SHORT	50	ER40	3.0	26.0	50	28.6	9.5	M24	M50x1.5	M28x1.5

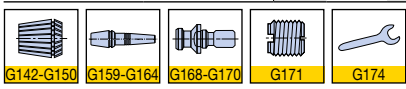

- ▶ Add B for coolant through flange
- ▶ ⁽¹⁾ Balance to G6.3 at 12,000RPM

DIN69871-TSK

TSK collet chucks

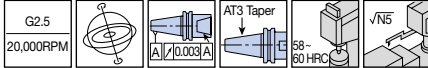
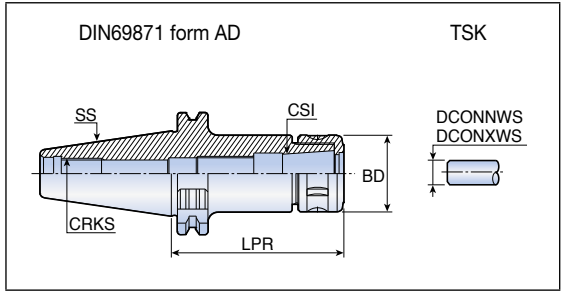

Designation	Dimension (mm)							
	SS	CSI	DCONNWS	DCONXWS	BD	LPR	CRKS	
DIN69871 40	TSK 6-90	40	TSK6	1.5	6.0	19.5	90	M16
	TSK 6-120	40	TSK6	1.5	6.0	19.5	120	M16
	TSK 10-90	40	TSK10	1.5	10.0	27.5	90	M16
	TSK 10-120	40	TSK10	1.5	10.0	27.5	120	M16
	TSK 16-90	40	TSK16	2.5	16.0	40.0	90	M16
	TSK 16-120	40	TSK16	2.5	16.0	40.0	120	M16
	TSK 25-90	40	TSK25	7.5	25.0	55.0	90	M16
	TSK 25-120	40	TSK25	7.5	25.0	55.0	120	M16
DIN69871 50	TSK 6-120⁽¹⁾	50	TSK6	1.5	6.0	19.5	120	M24
	TSK 6-165⁽¹⁾	50	TSK6	1.5	6.0	19.5	165	M24
	TSK 6-195⁽¹⁾	50	TSK6	1.5	6.0	19.5	195	M24
	TSK 10-120⁽¹⁾	50	TSK10	1.5	10.0	27.5	120	M24
	TSK 10-165⁽¹⁾	50	TSK10	1.5	10.0	27.5	165	M24
	TSK 10-195⁽¹⁾	50	TSK10	1.5	10.0	27.5	195	M24
	TSK 16-120⁽¹⁾	50	TSK16	2.5	16.0	40.0	120	M24
	TSK 16-165⁽¹⁾	50	TSK16	2.5	16.0	40.0	165	M24
	TSK 16-195⁽¹⁾	50	TSK16	2.5	16.0	40.0	195	M24
	TSK 25-120⁽¹⁾	50	TSK25	7.5	25.0	55.0	120	M24
	TSK 25-165⁽¹⁾	50	TSK25	7.5	25.0	55.0	165	M24
	TSK 25-195⁽¹⁾	50	TSK25	7.5	25.0	55.0	195	M24

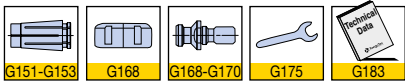

► Add B for coolant through flange
 ► ⁽¹⁾ Balance to G6.3 at 12,000RPM

GTI DIN69871-ER

GTI tap attachments

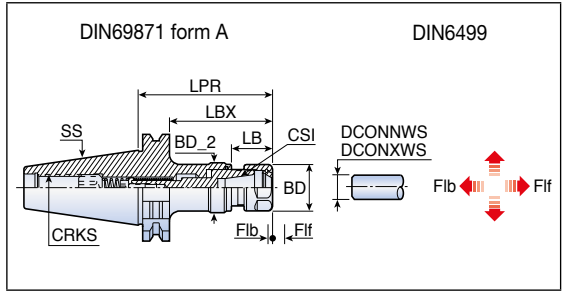
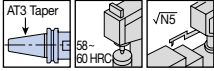

Designation	Dimension (mm)													
	SS	CSI	Tap _{min}	Tap _{max}	DCONNWS	DCONXWS	BD_2	BD	LPR	LBX	LB	Flb	Fif	CRKS
GTI DIN69871 40 ER 16	40	ER16	M3	M10	0.5	10.0	29.5	28	81.2	62.1	24.6	3	8	M16
ER 32	40	ER32	M6	M20	2.0	20.0	56.5	50	112.6	93.5	33.0	4	9	M16
ER 40	40	ER40	M6	M28	3.0	26.0	56.5	63	130.6	111.5	51.0	4	9	M16
GTI DIN69871 50 ER 16	50	ER16	M3	M10	0.5	10.0	29.5	28	106.8	87.7	24.6	3	8	M24
ER 32	50	ER32	M6	M20	2.0	20.0	56.5	50	115.3	96.2	33.0	4	9	M24
ER 40	50	ER40	M6	M28	3.0	26.0	56.5	63	133.3	114.2	51.0	4	9	M24

DIN69871-TC

Tap holders

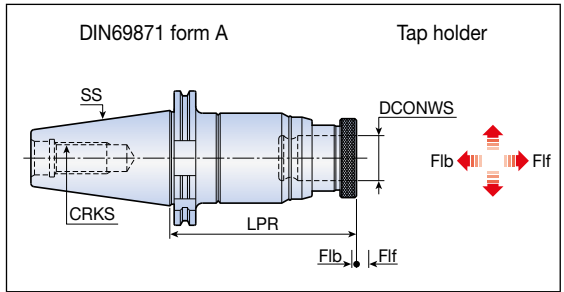
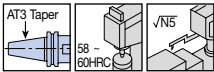

Designation	Dimension (mm)									
	SS	Tap _{min}	Tap _{max}	DCONWS	LPR	Flb	Fif	Tap adapter	CRKS	
DIN69871 40 TC 12-90	40	M3	M12	19	90	6.5	12	TA1	M16	
TC 22-142	40	M6	M24	31	142	14.5	13	TA2	M16	
DIN69871 50 TC 12-130	50	M3	M12	19	130	6.5	12	TA1	M24	
TC 22-142	50	M6	M24	31	142	14.5	13	TA2	M24	
TC 38-190	50	M18	M38	48	190	20.0	20	TA3	M24	

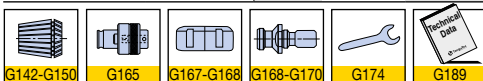

► Torque control system

DIN69871-NTMC

Milling chucks

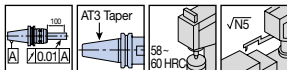
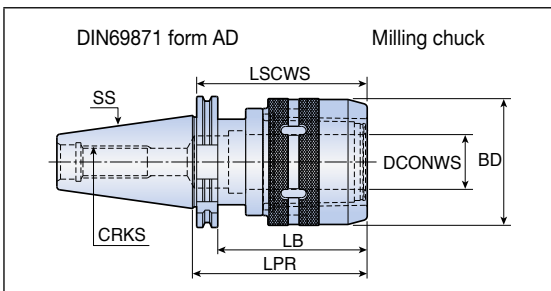

Designation	Dimension (mm)						
	SS	DCONWS	BD	LPR	LB	LSCWS	CRKS
DIN69871 40 NTMC 20-90	40	20	53	90	70.9	82	M16
	NTMC 20-105	40	20	53	105	85.9	M16
	NTMC 32-95	40	32	72	95	75.9	M16
	NTMC 32-105	40	32	72	105	85.9	M16
	NTMC 32-120	40	32	72	120	100.9	M16
DIN69871 50 NTMC 20-105	50	20	53	105	85.9	105	M24
	NTMC 32-105	50	32	74	105	85.9	M24
	NTMC 32-135	50	32	74	135	115.9	M24
	NTMC 32-165	50	32	74	165	145.9	M24
	NTMC 42-105	50	42	94	105	85.9	M24
	NTMC 42-135	50	42	94	135	115.9	M24

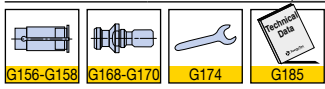

DIN69871-EM

Short end mill holders

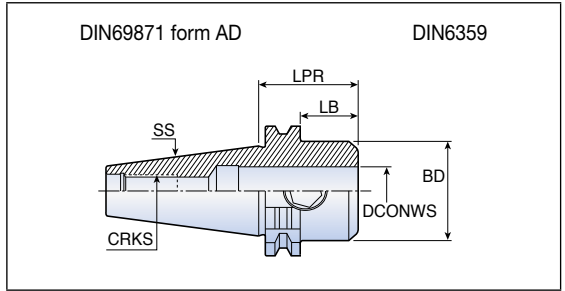
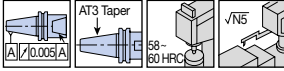

Designation	Dimension (mm)					
	SS	DCONWS	BD	LPR	LB	CRKS
DIN69871 40 EM 10x45	40	10	35	45	25.9	M16
EM 12x45	40	12	42	45	25.9	M16
EM 14x45	40	14	44	45	25.9	M16
EM 16x45	40	16	48	45	25.9	M16
EM 18x45	40	18	49	45	25.9	M16
EM 20x45	40	20	49	45	25.9	M16
EM 25x45	40	25	49	45	25.9	M16

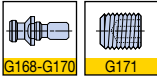

► Add B for coolant through flange

DIN69871-EM

End mill holders

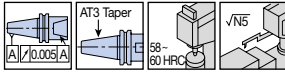
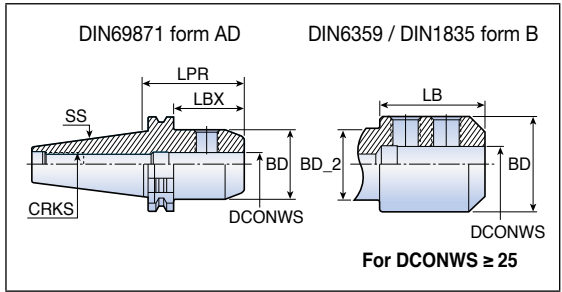

Designation	Dimension (mm)							
	SS	DCONWS	BD	BD_2	LPR	LBX	LB	CRKS
DIN69871 30 EM 6x50	30	6	25	-	50	30.9	-	M12
EM 8x50	30	8	28	-	50	30.9	-	M12
EM 10x50	30	10	35	-	50	30.9	-	M12
EM 14x63	30	14	44	-	63	43.9	-	M12
EM 16x63	30	16	48	-	63	43.9	-	M12
EM 18x72	30	18	50	-	72	52.9	-	M12
EM 20x72	30	20	52	-	72	52.9	-	M12
DIN69871 40 EM 6x50	40	6	25	-	50	30.9	-	M16
EM 8x50	40	8	28	-	50	30.9	-	M16
EM 10x50	40	10	35	-	50	30.9	-	M16
EM 12x50	40	12	42	-	50	30.9	-	M16
EM 14x63	40	14	44	-	63	43.9	-	M16
EM 16x63	40	16	48	-	63	43.9	-	M16
EM 18x63	40	18	50	-	63	43.9	-	M16
EM 20x63	40	20	52	-	63	43.9	-	M16
EM 25x100	40	25	65	49.0	100	80.9	65	M16
EM 32x100	40	32	71	49.0	100	80.9	65	M16
DIN69871 50 EM 6x63	50	6	25	-	63	43.9	-	M24
EM 8x63	50	8	28	-	63	43.9	-	M24
EM 10x63	50	10	35	-	63	43.9	-	M24
EM 12x63	50	12	42	-	63	43.9	-	M24
EM 14x63	50	14	44	-	63	43.9	-	M24
EM 16x63	50	16	48	-	63	43.9	-	M24
EM 18x63	50	18	50	-	63	43.9	-	M24
EM 20x63	50	20	52	-	63	43.9	-	M24
EM 25x80	50	25	65	-	80	60.9	-	M24
EM 32x100	50	32	72	-	100	80.9	-	M24
EM 40x100	50	40	90	79.9	100	80.9	43	M24
EM 50x125	50	50	98	79.9	125	105.9	90	M24

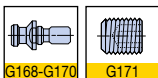

► Add B for coolant through flange except DIN69871 30

DIN69871-EM-E

End mill holders - Whistle notch

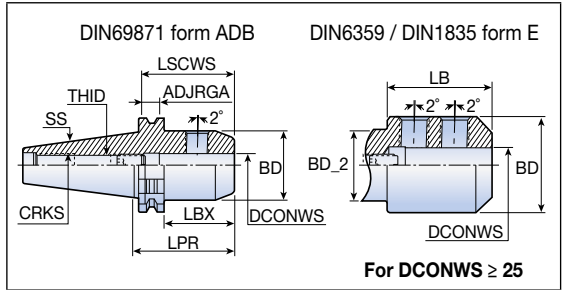
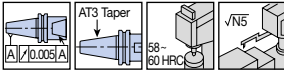

Designation	Dimension (mm)										
	SS	d2	BD	BD_2	LPR	LBX	LB	ADJRGA	LSCWS	CRKS	THID
DIN69871 40 EM 8x50E	40	8	28	-	50	30.9	-	10	45	M16	M6
EM 10x50E	40	10	35	-	50	30.9	-	10	49	M16	M8
EM 12x50E	40	12	42	-	50	30.9	-	10	54	M16	M10
EM 16x63E	40	16	48	-	63	43.9	-	10	57	M16	M12
EM 18x63E	40	18	50	-	63	43.9	-	10	57	M16	M12
EM 20x63E	40	20	52	-	63	43.9	-	10	59	M16	M16
EM 25x100E	40	25	64	49	100	80.9	65	10	64	M16	M20x1.5
EM 32x100E	40	32	71	49	100	80.9	65	10	68	M16	M20x1.5
DIN69871 50 EM 12x63E	50	12	42	-	63	43.9	-	10	54	M24	M10
EM 14x63E	50	14	44	-	63	43.9	-	10	54	M24	M10
EM 16x63E	50	16	48	-	63	43.9	-	10	57	M24	M12
EM 20x63E	50	20	52	-	63	43.9	-	10	59	M24	M16
EM 25x80E	50	25	65	-	80	60.9	-	10	64	M24	M20x1.5
EM 32x100E	50	32	72	-	100	80.9	-	10	68	M24	M20x1.5
EM 40x100E	50	40	90	79	100	80.9	43	10	78	M24	M20x1.5

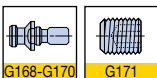

▶ The adjustment screw has an internal coolant hole
 ▶ Add B for coolant through the flange

DIN69871-SRKIN



Thermal shrinking chucks

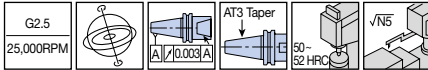
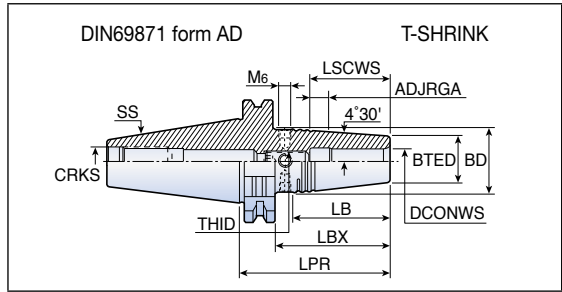

Designation	Dimension (mm)										
	SS	DCONWS	BTED	BD	LPR	LBX	LB	ADJRGA	LSCWS	CRKS	THID
DIN69871 40 SRKIN 6x80	40	6	21	27	80	60.9	38.0	11	36	M16	M5
SRKIN 8x80	40	8	21	27	80	60.9	38.0	11	36	M16	M6
SRKIN 10x80	40	10	24	32	80	60.9	50.5	11	42	M16	M8
SRKIN 12x80	40	12	24	32	80	60.9	50.5	16	47	M16	M10
SRKIN 14x80	40	14	27	34	80	60.9	44.2	11	47	M16	M10
SRKIN 16x80	40	16	27	34	80	60.9	44.2	11	50	M16	M12
SRKIN 18x80	40	18	33	42	80	60.9	57.0	11	50	M16	M12
SRKIN 20x80	40	20	33	42	80	60.9	57.0	11	52	M16	M16
SRKIN 25x100	40	25	44	53	100	80.9	57.0	11	58	M16	M16
DIN69871 50 SRKIN 6x80⁽¹⁾	50	6	21	27	80	60.9	38.0	11	36	M24	M5
SRKIN 8x80⁽¹⁾	50	8	21	27	80	60.9	38.0	11	36	M24	M6
SRKIN 10x80⁽¹⁾	50	10	24	32	80	60.9	51.0	11	42	M24	M8
SRKIN 12x80⁽¹⁾	50	12	24	32	80	60.9	51.0	16	47	M24	M10
SRKIN 14x80⁽¹⁾	50	14	27	34	80	60.9	45.0	11	47	M24	M10
SRKIN 16x80⁽¹⁾	50	16	27	34	80	60.9	45.0	11	50	M24	M10
SRKIN 18x80⁽¹⁾	50	18	33	42	80	60.9	57.0	11	50	M24	M12
SRKIN 20x80⁽¹⁾	50	20	33	42	80	60.9	57.0	11	52	M24	M12
SRKIN 25x100⁽¹⁾	50	25	44	53	100	80.9	57.0	11	58	M24	M16
SRKIN 32x100⁽¹⁾	50	32	44	53	100	80.9	57.0	11	58	M24	M16

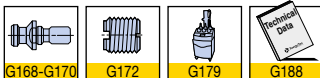

► Only use inductive heating device for T-SHRINK holders
 ► Add B for coolant through flange
 ► ⁽¹⁾ Balance to G2.5 at 20,000RPM

DIN69871-SRK



Thermal shrinking chucks

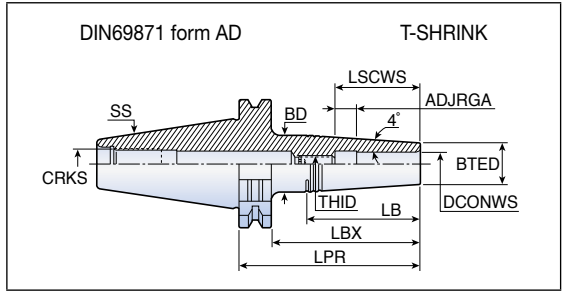

G2.5 25,000RPM			AT3 Taper		50-82 HRC	
-------------------	--	--	-----------	--	-----------	--

Designation	Dimension (mm)											
	SS	DCONWS	BTED	BD	LPR	LBX	LB	ADJRGA	LSCWS	CRKS	THID	
DIN69871 40 SRK 3x50	40	3	10	15	69.1	50	35.5	6	16	M16	M6	
SRK 3x85	40	3	10	19	104.1	85	64.1	6	16	M16	M6	
SRK 4x50	40	4	10	15	69.1	50	35.5	6	18	M16	M6	
SRK 4x85	40	4	10	19	104.1	85	64.1	6	18	M16	M6	
SRK 5x50	40	5	10	15	69.1	50	35.5	6	21	M16	M6	
SRK 5x85	40	5	10	19	104.1	85	64.1	6	18	M16	M6	
SRK 6x50	40	6	11	16	69.1	50	35.5	6	24	M16	M8	
SRK 6x85	40	6	11	20	104.1	85	64.1	6	24	M16	M8	
SRK 8x50	40	8	14	20	69.1	50	42.5	6	31	M16	M10	
SRK 8x85	40	8	14	23	104.1	85	63.9	6	31	M16	M10	
SRK 10x50	40	10	16	22	69.1	50	42.4	6	36	M16	M12	
SRK 10x85	40	10	16	24.5	104.1	85	60.3	6	36	M16	M12	
SRK 12x50	40	12	20	26	69.1	50	42.3	10	42	M16	M10	
SRK 12x85	40	12	20	28	104.1	85	56.6	10	42	M16	M10	

G168-G170	G179	G188
-----------	------	------

► Add B for coolant through the flange

DIN69871-THC



Hydraulic chucks

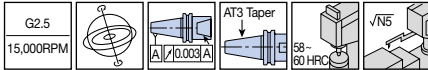
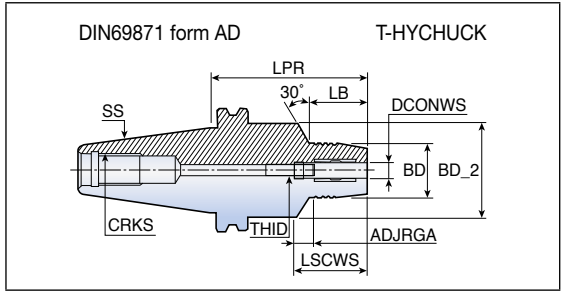

Designation	Dimension (mm)										
	SS	DCONWS	BD	BD_2	LPR	LB	ADJRGA	LSCWS	THID	CRKS	
DIN69871 40	THC 6-65	40	6	28	50	65	23	10	37.5	M5	M16
	THC 8-65	40	8	30	50	65	23	10	37.5	M6	M16
	THC 10-95	40	10	32	50	95	44	10	42.5	M8x1	M16
	THC 12-95	40	12	34	50	95	44	10	47.5	M10x1	M16
	THC 14-95	40	14	36	50	95	47	10	47.5	M10x1	M16
	THC 16-95	40	16	38	50	95	48	10	52.5	M10x1	M16
	THC 18-95	40	18	41	50	95	47	10	52.5	M10x1	M16
	THC 20-95	40	20	43	50	95	48	10	52.5	M10x1	M16
DIN69871 50	THC 12-90⁽¹⁾	50	12	34	50	90	44	10	47.5	M10x1	M24
	THC 16-90⁽¹⁾	50	16	38	50	90	48	10	52.5	M10x1	M24
	THC 20-120⁽¹⁾	50	20	43	50	120	48	10	52.5	M10x1	M24
	THC 20-150⁽¹⁾	50	20	43	50	150	48	10	52.5	M10x1	M24
	THC 25-135⁽¹⁾	50	25	53	-	135	-	10	61.0	M10x1	M24
	THC 32-135⁽¹⁾	50	32	63	-	135	-	10	65.0	M16x1	M24
	THC 32-150⁽¹⁾	50	32	63	-	150	-	10	65.0	M16x1	M24

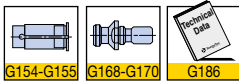

► Add B for coolant through flange
 ► ⁽¹⁾ Balance to G2.5 at 10,000RPM

DIN69871-SEM

Face mill arbors

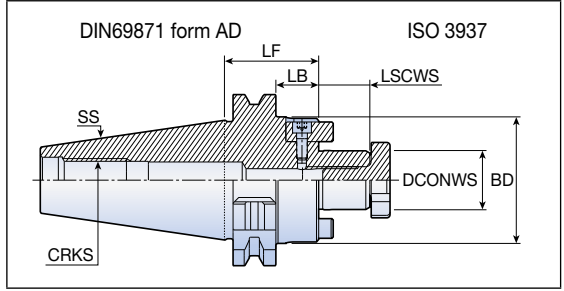
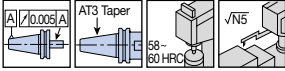

Designation	Dimension (mm)						
	SS	DCONWS	BD	LF	LB	LSCWS	CRKS
DIN69871 30 SEM 16x35	30	16	38	35	15.9	17	M12
SEM 22x50	30	22	47	50	30.9	19	M12
SEM 27x50	30	27	58	50	30.9	21	M12
DIN69871 40 SEM 16x35	40	16	38	35	15.9	17	M16
SEM 22x35	40	22	47	35	15.9	19	M16
SEM 27x60	40	27	58	60	40.9	21	M16
SEM 32x60	40	32	66	60	40.9	24	M16
SEM 40x60	40	40	82	60	40.9	27	M16
DIN69871 50 SEM 16x35	50	16	38	35	15.9	17	M24
SEM 22x35	50	22	47	35	15.9	19	M24
SEM 22x50x200	50	22	50	200	180.9	19	M24
SEM 27x35	50	27	58	35	15.9	21	M24
SEM 32x35	50	32	66	35	15.9	24	M24
SEM 32x78x370	50	40	78	370	350.9	24	M24
SEM 40x50	50	40	82	50	30.9	27	M24
SEM 50x60	50	50	95	60	40.9	30	M24



► Wrench not included

DIN69871-SEM-C

Face mill arbors with coolant hole

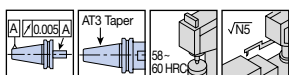
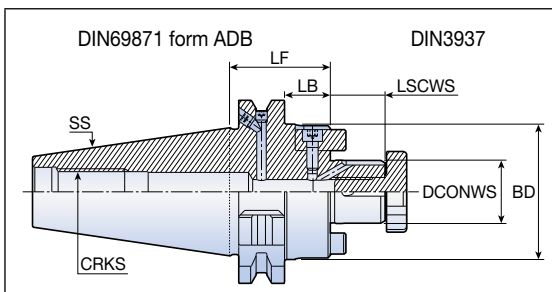

Designation	Dimension (mm)						
	SS	DCONWS	BD	LF	LB	LSCWS	CRKS
DIN69871 40 SEM 16x35C	40	16	38	35	15.9	17	M16
SEM 16x100C	40	16	38	100	80.9	17	M16
SEM 22x35C	40	22	47	35	15.9	19	M16
SEM 22x100C	40	22	47	100	80.9	19	M16
SEM 27x60C	40	27	58	60	40.9	21	M16
SEM 27x100C	40	27	58	100	80.9	21	M16
SEM 32x60C	40	32	66	60	40.9	24	M16
DIN69871 50 SEM 16x35TC	50	16	38	35	15.9	17	M24
SEM 16x100C	50	16	38	100	80.9	17	M24
SEM 22x35C	50	22	47	35	15.9	19	M24
SEM 22x100C	50	22	47	100	80.9	19	M24
SEM 27x35C	50	27	58	35	15.9	21	M24
SEM 27x100C	50	27	58	100	80.9	21	M24
SEM 32x35C	50	32	66	35	15.9	24	M24
SEM 32x100C	50	32	66	100	80.9	24	M24
DIN69871 50 SEM 22x48x200C	50	22	48	200	181.0	19	M24
SEM 22x61x300C	50	22	61	300	281.0	19	M24
SEM 27x61x300C	50	27	61	300	281.0	21	M24
SEM 32x78x370C	50	32	78	370	351.0	24	M24



► If the "B type" option is required, the plug screw must be removed from the flange cooling hole (Use a 2mm hex key)
► Wrench not included

DIN69871-SEMC

Combi shell end mill arbors

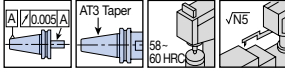
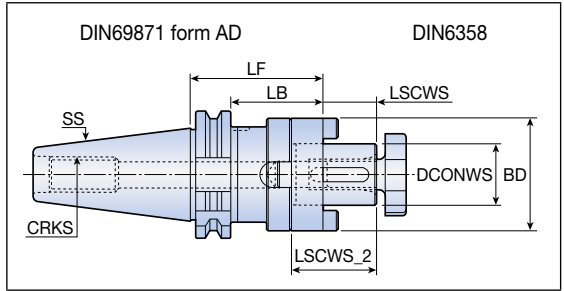

Designation	Dimension (mm)								
	SS	DCONWS	BD	LF	LB	LSCWS	LSCWS_2	CRKS	
DIN69871 30 SEMC 16x50	30	16	32	50	30.9	17	27	M12	
SEMC 22x50	30	22	40	50	30.9	19	31	M12	
DIN69871 40 SEMC 16x55	40	16	32	55	35.9	17	27	M16	
SEMC 16x100	40	16	32	100	80.9	17	27	M16	
SEMC 22x55	40	22	40	55	35.9	19	31	M16	
SEMC 22x100	40	22	40	100	80.9	19	31	M16	
SEMC 27x55	40	27	48	55	35.9	21	33	M16	
SEMC 27x100	40	27	48	100	80.9	21	33	M16	
SEMC 32x60	40	32	58	60	45.9	24	38	M16	
SEMC 32x100	40	32	58	100	80.9	24	38	M16	
SEMC 40x60	40	40	70	60	40.9	27	41	M16	
DIN69871 50 SEMC 16x55	50	16	32	55	35.9	17	27	M24	
SEMC 16x100	50	16	32	100	80.9	17	27	M24	
SEMC 22x55	50	22	40	55	35.9	19	31	M24	
SEMC 22x100	50	22	40	100	80.9	19	31	M24	
SEMC 27x55	50	27	48	55	35.9	21	33	M24	
SEMC 27x100	50	27	48	100	80.9	21	33	M24	
SEMC 32x55	50	32	58	55	35.9	24	38	M24	
SEMC 32x100	50	32	58	100	80.9	24	38	M24	
SEMC 40x55	50	40	70	55	35.9	27	41	M24	
SEMC 40x100	50	40	70	10	80.9	27	41	M24	
SEMC 50x70	50	50	90	70	50.9	30	46	M24	

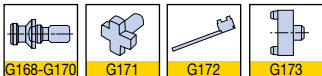

► Wrench not included

DIN69871 -FM

Face mill arbors

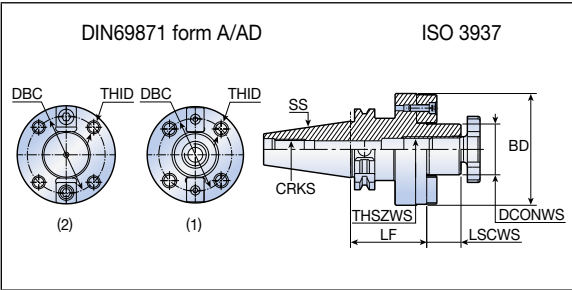
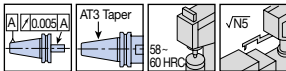

Designation	Dimension (mm)								
	SS	DCONWS	BD	DBC	LF	LSCWS	CRKS	THID	THSZWS
DIN69871 40 FM 40⁽¹⁾	40	40	88	66.7	60	27	M16	M12	M20
DIN69871 50 FM 40⁽¹⁾	50	40	88	66.7	70	27	M24	M12	M20
FM 60⁽²⁾	50	60	128	101.6	70	40	M24	M16	-



- ▶ 4 pcs of mounting screws are included
- ▶ (1) Form AD
- ▶ (2) Form A

DIN69871-SCA

Slotting cutter arbors

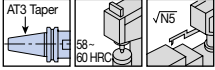
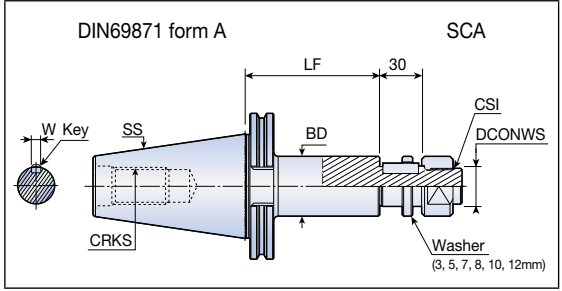

Designation	Dimension (mm)							
	SS	DCONWS	BD	LF	W	CRKS	CSI	
DIN69871 40 SCA-22-75	40	22	34	75	6	M16	M20x1.5	
	SCA-22-120	40	22	34	120	6	M16	M20x1.5
	SCA-27-75	40	27	40	75	7	M16	M24x2.0
	SCA-27-120	40	27	40	120	7	M16	M24x2.0
	SCA-32-90	40	32	46	90	8	M16	M32x2.0
DIN69871 50	SCA-22-135	50	22	34	135	6	M24	M20x1.5
	SCA-27-90	50	27	40	90	7	M24	M24x2.0
	SCA-27-135	50	27	40	135	7	M24	M24x2.0
	SCA-32-90	50	32	46	90	8	M24	M36x3.0
	SCA-32-135	50	32	46	135	8	M24	M36x3.0
	SCA-40-90	50	40	55	90	10	M24	M36x3.0
	SCA-40-135	50	40	55	135	10	M24	M36x3.0
	SCA-50-90	50	50	68	90	12	M24	M42x3.0



► Washers & key are included (Each 3, 5, 7, 8, 10, 12mm)

G168-G170

DIN69871-MT

Morse taper adapters

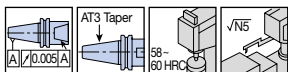
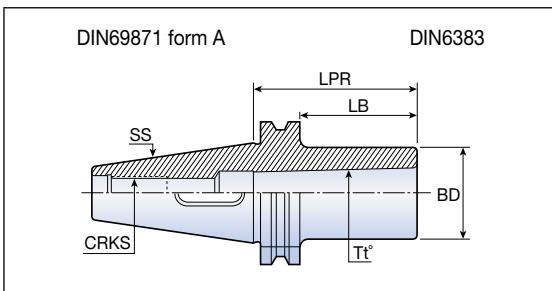

Designation	Dimension (mm)					
	SS	Tt°	BD	LPR	LB	CRKS
DIN69871 40 MT 1x50	40	MT1	25	50	30.9	M16
MT 2x50	40	MT2	32	50	30.9	M16
MT 3x70	40	MT3	40	70	50.9	M16
MT 4x95	40	MT4	48	95	75.9	M16
DIN69871 50 MT 1x45	50	MT1	25	45	25.9	M24
MT 2x60	50	MT2	32	60	40.9	M24
MT 3x65	50	MT3	40	65	45.9	M24
MT 4x95	50	MT4	48	95	75.9	M24
MT 5x105	50	MT5	63	105	85.9	M24



DIN69871-MT-DRW

Morse taper draw bar adapters

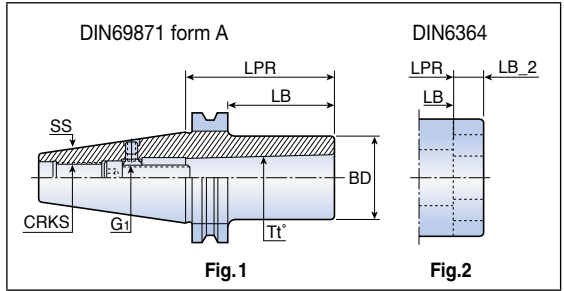
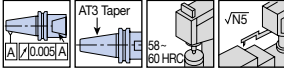

Designation	Dimension (mm)									Fig.
	SS	Tt°	BD	LPR	LB	LB_2	CRKS	G1		
DIN69871 40 MT1 DRW	40	MT1	25	50	30.9	-	M16	M6	1	
MT2 DRW	40	MT2	32	50	30.9	-	M16	M10	1	
MT3 DRW	40	MT3	40	70	50.9	-	M16	M12	1	
MT4 DRW⁽¹⁾	40	MT4	63	110	90.9	15	M16	M16	2	
DIN69871 50 MT1 DRW	50	MT1	25	45	25.9	-	M24	M6	1	
MT2 DRW	50	MT2	32	60	40.9	-	M24	M10	1	
MT3 DRW	50	MT3	40	65	45.9	-	M24	M12	1	
MT4 DRW⁽¹⁾	50	MT4	63	85	65.9	15	M24	M16	2	
MT5 DRW⁽¹⁾	50	MT5	78	118	98.9	18	M24	M20	2	

⁽¹⁾ DIN2201



G168-G170

DIN69871-AD

Adapters

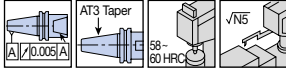
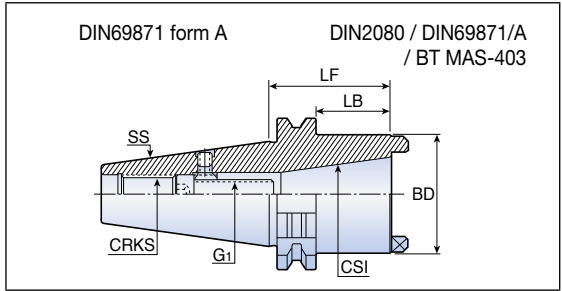

Designation	Dimension (mm)						
	SS	CSI	BD	LF	LB	CRKS	G1
DIN69871 50 AD BT/SK 40	50	BT/SK 40	66	70	50.9	M24	M16

DIN69871-DC

Drill chuck arbors - Jacobs taper arbors

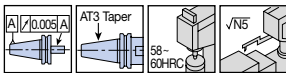
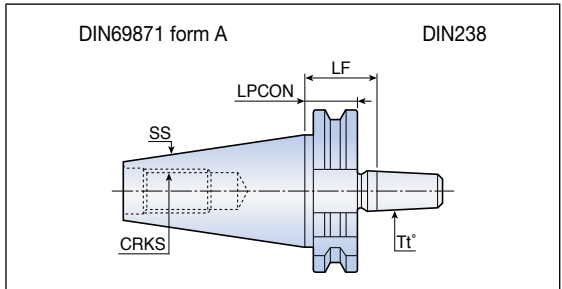

Designation	Dimension (mm)				
	SS	Tt°	LF	LPCON	CRKS
DIN69871 40 DC B12x26	40	B12	26	19.1	M16
DC B16x26	40	B16	26	19.1	M16
DC B18x26	40	B18	26	19.1	M16
DIN69871 50 DC B16x26	50	B16	26	19.1	M24
DC B18x26	50	B16	26	19.1	M24



► Drill chuck not included

G168-G170

T-FLEXTEC holders

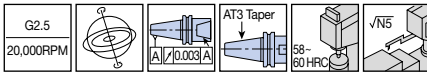
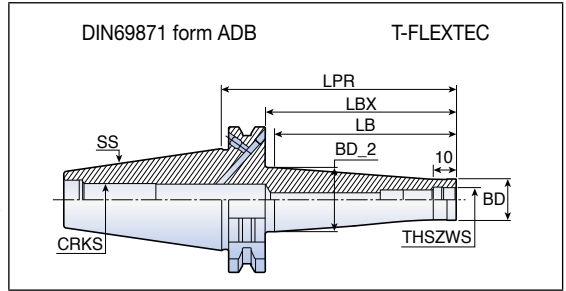

Designation	Dimension (mm)							
	SS	THSZWS	BD	BD_2	LPR	LBX	LB	CRKS
DIN69871 40 ODP 6x58	40	M06	9.8	13.0	58	38.9	32	M16
ODP 6x98	40	M06	9.8	23.0	98	78.9	74	M16
ODP 8x58	40	M08	13.1	15.0	58	38.9	32	M16
ODP 8x98	40	M08	13.1	23.0	98	78.9	74	M16
ODP 10x58	40	M10	18.0	20.0	58	38.9	32	M16
ODP 10x98	40	M10	18.0	28.0	98	78.9	74	M16
ODP 12x58	40	M12	21.0	24.0	58	38.9	32	M16
ODP 12x98	40	M12	21.0	31.0	98	78.9	74	M16
ODP 16x58	40	M16	29.0	28.6	58	38.9	32	M16
ODP 16x98	40	M16	29.0	34.0	98	78.9	74	M16
DIN69871 50 ODP 12x78⁽¹⁾	50	M12	23.0	30.0	78	58.9	50	M24
ODP 12x128⁽¹⁾	50	M12	23.0	40.0	128	108.9	100	M24
ODP 12x178⁽¹⁾	50	M12	23.0	40.0	178	158.9	150	M24
ODP 12x228⁽¹⁾	50	M12	23.0	46.0	228	208.9	200	M24
ODP 16x78⁽¹⁾	50	M16	29.0	34.0	78	58.9	50	M24
ODP 16x128⁽¹⁾	50	M16	29.0	40.0	128	108.9	100	M24
ODP 16x178⁽¹⁾	50	M16	29.0	55.0	178	158.9	150	M24
ODP 16x228⁽¹⁾	50	M16	29.0	55.0	228	208.9	200	M24



 ▶ If the “B type” option is required, the plug screw must be removed from the flange cooling hole (Use a 2mm hex key)
 ▶ ⁽¹⁾ Balance to G6.3 at 12,000RPM

HSK

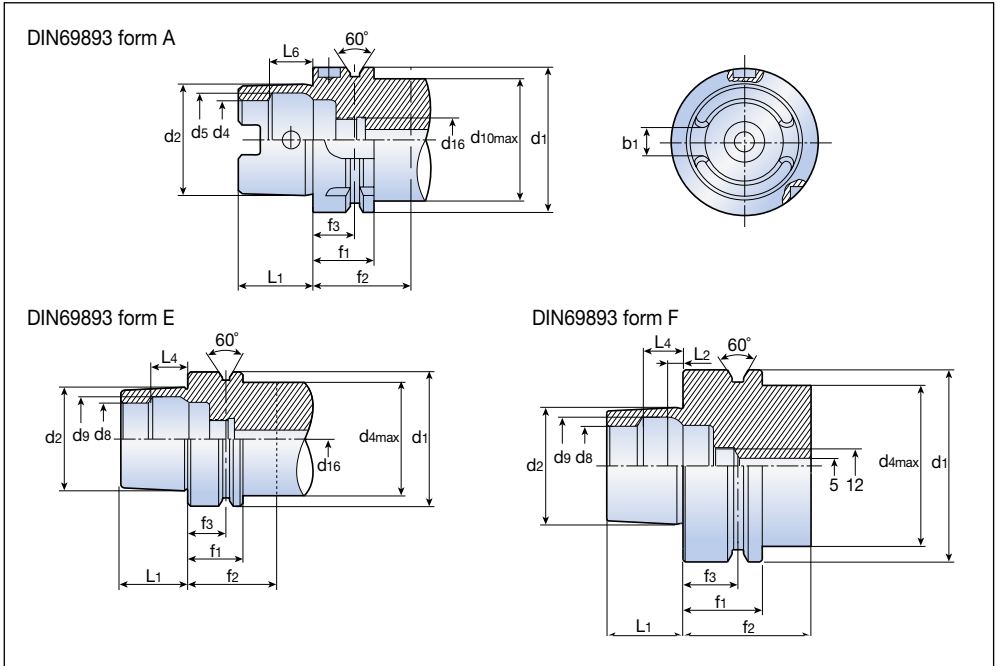

DIN69893 Form A/E/F

Standard toolholder



DIN69893 form A

HSK-A	d1 h10	d2	d4 H10	d5 H11	d10max	d16	L1 -0.2	L6 JS10	b1 ±0.04	f1 -0.1	f2min	f3 ±0.1
40	40	30	21	25.5	34	M12x1	20	11.42	8.05	20	35	16
50	50	38	26	32.0	42	M16x1	25	14.13	10.54	26	42	18
63	63	48	34	40.0	53	M18x1	32	18.13	12.54(12.42)	26	42	18
80	80	60	42	50.0	67	M20x1.5	40	22.85	16.04	26	42	18
100	100	75	53	63.0	85	M24x1.5	50	28.56	20.02 (19.9)	29	45	20

DIN69893 form E

HSK-E	d1 h10	d2	d4max	d8 H10	d9 H11	d16	L1 -0.2	L4 JS10	f1 -0.1	f2min	f3 ±0.1
32	32	24	26	17	19.0	M10x1	16	8.92	20	35	16
40	40	30	34	21	25.5	M12x1	20	11.42	20	35	16
50	50	38	42	26	32.0	M16x1	25	14.13	26	42	18
63	63	48	53	34	40.0	M18x1	32	18.13	26	42	18

DIN69893 form F

HSK-F	d1 h10	d2	d4max	d8 H10	d9 H11	L1 -0.2	L2	L4 JS10	f1 -0.1	f2min	f3 ±0.1
63	63	38	53	26	32	25	5.0	14.13	26	42	18

► Without crosshole

► For non-stock items: Supply condition is subject to availability

If not available in stock then MOQ (Minimum order qty) will be applicable

HSK A-ER

ER collet chucks

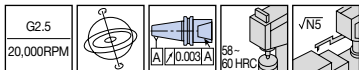
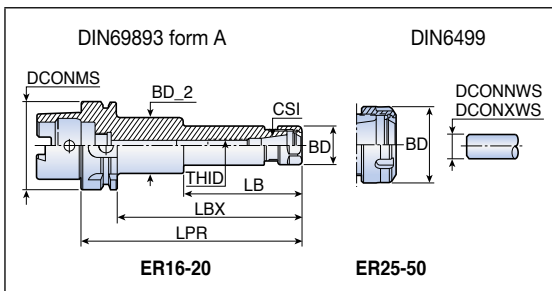

Designation	Dimension (mm)									
	DCONMS	CSI	DCONNWS	DCONXWS	BD	BD_2	LPR	LBX	LB	THID
HSK A 40 ER 16x60	40	ER16	0.5	10.0	28	-	60	40	-	-
ER 16x80	40	ER16	0.5	10.0	28	-	80	60	-	M10
ER 25x60	40	ER25	1.0	16.0	42	32.4	60	40	28.0	-
ER 25x80	40	ER25	1.0	16.0	42	32.4	80	60	28.0	M18x1.5
ER 25x100	40	ER25	1.0	16.0	42	32.4	100	80	28.0	M16
ER 32x100	40	ER32	2.0	20.0	50	40.4	100	80	31.0	M22x1.5
HSK A 50 ER 16x100	50	ER16	0.5	10.0	28	-	100	74	-	M10
ER 20x100	50	ER20	1.0	13.0	34	-	100	74	-	M12
ER 25x80	50	ER25	1.0	16.0	42	32.4	80	54	28.0	M8
ER 25x100	50	ER25	1.0	16.0	42	41.8	100	74	28.5	M16
ER 32x100	50	ER32	2.0	20.0	50	40.4	100	74	31.0	M22x1.5
HSK A 63 ER 16x100	63	ER16	0.5	10.0	28	-	100	74	-	M10
ER 16x120	63	ER16	0.5	10.0	28	-	120	94	-	M10
ER 16x160	63	ER16	0.5	10.0	28	40.0	160	134	85.6	M10
ER 20x100	63	ER20	1.0	13.0	34	-	100	74	-	M12
ER 20x120	63	ER20	1.0	13.0	34	-	120	94	-	M12
ER 20x160	63	ER20	1.0	13.0	34	45.0	160	134	85.0	M12
ER 25x80	63	ER25	1.0	16.0	42	-	80	54	-	M8
ER 25x100	63	ER25	1.0	16.0	42	-	100	74	-	M16
ER 25x120	63	ER25	1.0	16.0	42	-	120	94	-	M16
ER 25x160	63	ER25	1.0	16.0	42	-	160	134	-	M16
ER 32x80	63	ER32	2.0	20.0	50	40.4	80	54	31.0	-
ER 32x100	63	ER32	2.0	20.0	50	-	100	74	-	M22x1.5
ER 32x120	63	ER32	2.0	20.0	50	-	120	94	-	M22x1.5
ER 32x160	63	ER32	2.0	20.0	50	-	160	134	-	M22x1.5
ER 40x80	63	ER40	3.0	26.0	63	50.4	80	54	34.0	-
ER 40x100	63	ER40	3.0	26.0	63	50.4	100	74	34.0	M28x1.5
ER 40x120	63	ER40	3.0	26.0	63	50.4	120	94	34.0	M28x1.5

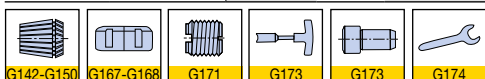

HSK A-ER

ER collet chucks

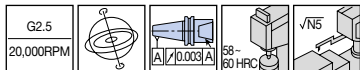
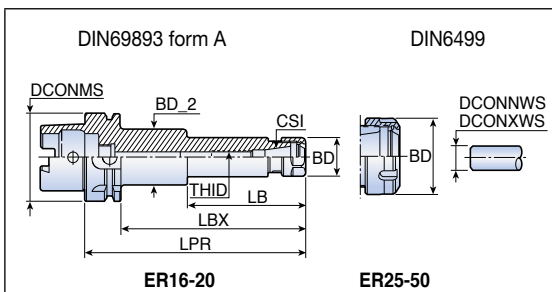

Designation	Dimension (mm)									
	DCONMS	CSI	DCONWS	DCONXWS	BD	BD_2	LPR	LBX	LB	THID
HSK A 100 ER 16x100 ⁽¹⁾	100	ER16	0.5	10.0	28	-	100	71	-	M10
ER 16x160 ⁽¹⁾	100	ER16	0.5	10.0	28	40	160	131	85	M10
ER 20x100 ⁽¹⁾	100	ER20	1.0	13.0	34	-	100	71	-	M12
ER 20x160 ⁽¹⁾	100	ER20	1.0	13.0	34	50	160	131	85	M12
ER 25x100 ⁽¹⁾	100	ER25	1.0	16.0	42	-	100	71	-	M16
ER 25x120 ⁽¹⁾	100	ER25	1.0	16.0	42	-	120	91	-	M16
ER 25x160 ⁽¹⁾	100	ER25	1.0	16.0	42	-	160	134	-	M16
ER 32x100 ⁽¹⁾	100	ER32	2.0	20.0	50	-	100	71	-	M22x1.5
ER 32x120 ⁽¹⁾	100	ER32	2.0	20.0	50	-	120	91	-	M22x1.5
ER 32x160 ⁽¹⁾	100	ER32	2.0	20.0	50	-	160	131	-	M22x1.5
ER 40x100 ⁽¹⁾	100	ER40	3.0	26.0	63	-	100	71	-	M28x1.5
ER 40x120 ⁽¹⁾	100	ER40	3.0	26.0	63	-	120	91	-	M28x1.5
ER 40x160 ⁽¹⁾	100	ER40	3.0	26.0	63	-	160	131	-	M28x1.5
ER 50x100 ⁽¹⁾	100	ER50	10.0	34.0	78	-	100	71	-	M22x1.5

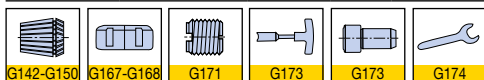

►⁽¹⁾ Balance to G6.3 at 12,000RPM

HSK E-ER

ER collet chucks

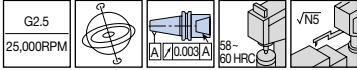
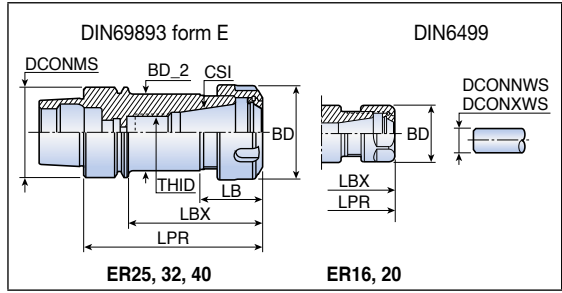

Designation	Dimension (mm)										
	DCONMS	CSI	DCONNWS	DCONXWS	BD	BD_2	LPR	LBX	LB	THID	
HSK E 32 ER 16x60	32	ER16	0.5	10.0	28	22.4	60	40	21.5	-	
ER 20x60	32	ER20	1.0	13.0	34	25.4	60	40	26.0	-	
ER 25x65	32	ER25	1.0	16.0	42	25.8	65	45	30.0	-	
HSK E 40 ER 16x60	40	ER16	0.5	10.0	28	-	60	40	-	-	
ER 16x80	40	ER16	0.5	10.0	28	-	80	60	-	M10	
ER 20x80	40	ER20	1.0	13.0	34	-	80	60	-	M12	
ER 25x80	40	ER25	1.0	16.0	42	34.0	80	60	28.0	M18x1.5	
ER 32x80	40	ER32	2.0	20.0	50	40.1	-	60	31.0	M22x1.5	
HSK E 50 ER 16x80	50	ER16	0.5	10.0	28	-	80	54	-	M10	
ER 16x100	50	ER16	0.5	10.0	28	-	100	74	-	M10	
ER 16x100 M⁽¹⁾	50	ER16	0.5	10.0	22	-	100	74	-	M10	
ER 20x80	50	ER20	1.0	13.0	34	-	80	54	-	M12	
ER 25x80	50	ER25	1.0	16.0	42	32.4	80	54	28.0	M16	
ER 32x80	50	ER32	2.0	20.0	50	40.4	80	54	31.0	-	
ER 32x100	50	ER32	2.0	20.0	50	40.4	100	74	31.0	M22x1.5	
HSK E 63 ER 16x80	63	ER16	0.5	10.0	28	-	80	54	-	M10	
ER 16x100	63	ER16	0.5	10.0	28	-	100	74	-	M10	
ER 20x75	63	ER20	1.0	13.0	34	-	75	49	-	-	
ER 32x100	63	ER32	2.0	20.0	50	-	100	75	-	M22x1.5	

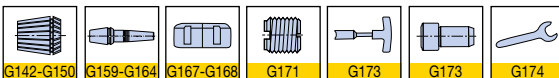

▶ ⁽¹⁾ Equipped with nut ER16 MINI

HSK A-ER-M

ER mini collet chucks

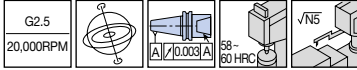
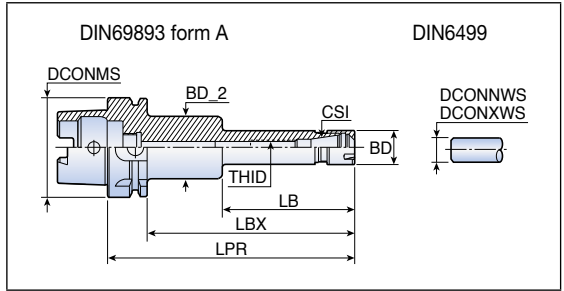

Designation	Dimension (mm)										
	DCONMS	CSI	DCONNWS	DCONXWS	BD	BD_2	LPR	LBX	LB	THID	
HSK A 50	ER 16x100 M	50	ER16	0.5	10.0	22	-	100	74	-	M10
	ER 20x100 M	50	ER20	1.0	13.0	28	-	100	74	-	M12
HSK A 63	ER 16x100 M	63	ER16	0.5	10.0	22	-	100	74	-	M10
	ER 16x120 M	63	ER16	0.5	10.0	22	40	120	94	78	M10
	ER 16x160 M	63	ER16	0.5	10.0	22	40	160	134	85	M10
	ER 20x100 M	63	ER20	1.0	13.0	28	-	100	74	-	M12
	ER 20x120 M	63	ER20	1.0	13.0	28	-	120	94	-	M12
	ER 20x160 M	63	ER20	1.0	13.0	28	45	160	134	85	M12
HSK A 100	ER 16x100 M⁽¹⁾	100	ER16	0.5	10.0	22	-	100	71	-	M10
	ER 16x160 M⁽¹⁾	100	ER16	0.5	10.0	22	40	160	131	85	M10
	ER 20x100 M⁽¹⁾	100	ER20	1.0	13.0	28	-	100	71	-	M12
	ER 20x160 M⁽¹⁾	100	ER20	1.0	13.0	28	45	160	131	85	M12

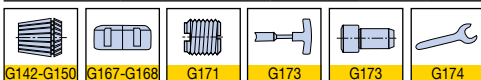

►⁽¹⁾ Balance to G6.3 at 12,000RPM

HSK FM-ER

ER collet chucks

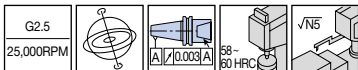
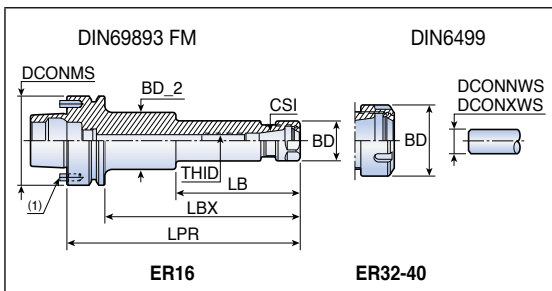

Designation	Dimension (mm)									
	DCONMS	CSI	DCONNWS	DCONXWS	BD	BD_2	LPR	LBX	LB	THID
HSK FM 63 ER 16x80	63	ER16	0.5	10.0	28	-	80	54	-	M10
ER 16x100	63	ER16	0.5	10.0	28	-	100	74	-	M10
ER 16x120	63	ER16	0.5	10.0	28	-	120	94	-	M10
ER 16x160	63	ER16	0.5	10.0	28	40	160	134	85.6	M10
ER 32x80	63	ER32	2.0	20.0	50	-	80	54	-	-
ER 32x100	63	ER32	2.0	20.0	50	-	100	74	-	M22x1.5
ER 40x80	63	ER40	3.0	26.0	63	50	80	54	32.0	-
ER 40x100	63	ER40	3.0	26.0	63	50	100	74	32.0	M28x1.5

► ⁽¹⁾ The driving pins can be removed to turn the toolholder into a standard HSK F 63 type

HSK A-ER-SHORT



Short ER collet chucks

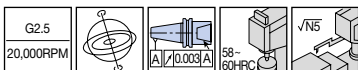
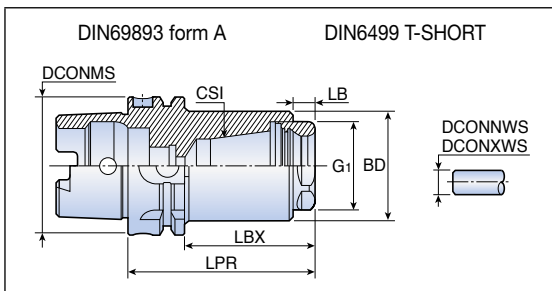

Designation	Dimension (mm)								
	DCONMS	CSI	DCONNWS	DCONXWS	BD	LPR	LBX	LB	G1
HSK A 63 ER 32 SHORT	63	ER32	2.0	20.0	50	81.0	55.0	9.5	M40x1.5
HSK A 100 ER 32 SHORT	100	ER32	2.0	20.0	50	89.5	60.5	9.5	M40x1.5
ER 40 SHORT	100	ER40	3.0	26.0	70	104.5	75.5	9.5	M50x1.5



► ⁽¹⁾ Equipped with nut ER16 MINI

HSK A-TSK

TSK collet chucks

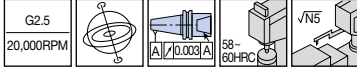
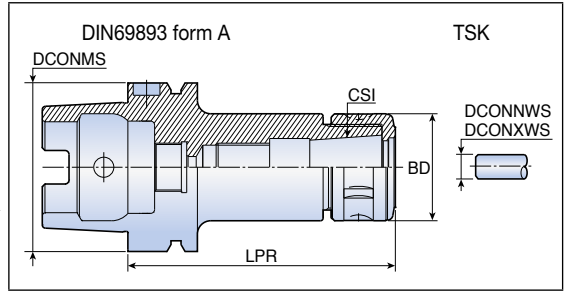

Designation	Dimension (mm)					
	DCONMS	CSI	DCONNWS	DCONXWS	BD	LPR
HSK A 50 TSK 6-80	50	TSK6	1.5	6.0	19.5	80
	50	TSK10	1.5	10.0	27.5	90
	50	TSK16	2.5	16.0	40.0	100
HSK A 63 TSK 6-80	63	TSK6	1.5	6.0	19.5	80
	63	TSK10	1.5	10.0	27.5	90
	63	TSK16	2.5	16.0	40.0	100
	63	TSK25	7.5	25.0	55.0	120
HSK A 100 TSK 6-80	100	TSK6	1.5	6.0	19.5	80
	100	TSK10	1.5	10.0	27.5	90
	100	TSK16	2.5	16.0	40.0	100
	100	TSK25	7.5	25.0	55.0	120

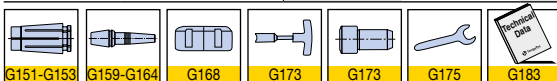

HSK A-NTMC

Milling chucks

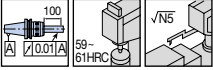
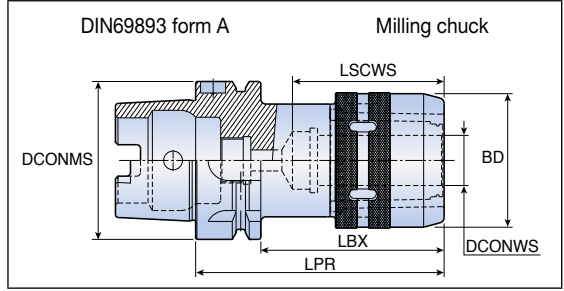

Designation	Dimension (mm)					
	DCONMS	DCONWS	BD	LPR	LBX	LSCWS
HSK A 63 NTMC 20-105	63	20	53	105	79	76
NTMC 25-120	63	25	62	105	79	77
NTMC 32-130	63	32	72	130	104	100
HSK A 100 NTMC 20-110	100	20	53	105	76	77
NTMC 25-130	100	25	62	135	106	80
NTMC 32-135	100	32	74	135	106	102
NTMC 42-135	100	42	94	135	106	112

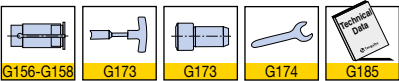

HSK A-EM

End mill holders

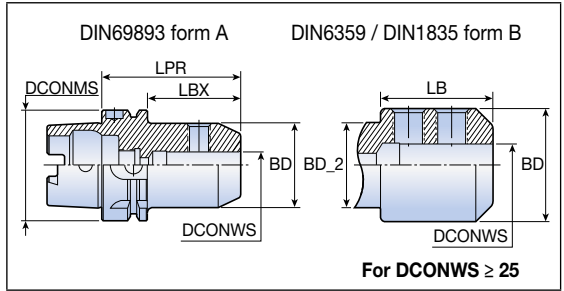
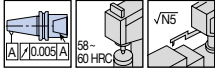

Designation	Dimension (mm)							
	DCONMS	DCONWS	BD	BD_2	LPR	LBX	LB	
HSK A 50	EM 8x65	50	8	28	-	65	39	-
	EM 16x80	50	16	48	-	80	54	-
	EM 20x80	50	20	52	-	80	54	-
HSK A 63	EM 6x65	63	6	25	-	65	39	-
	EM 8x65	63	8	28	-	65	39	-
	EM 10x65	63	10	35	-	65	39	-
	EM 12x80	63	12	42	-	80	54	-
	EM 14x80	63	14	44	-	80	54	-
	EM 16x80	63	16	48	-	80	54	-
	EM 18x80	63	18	50	-	80	54	-
	EM 20x80	63	20	52	-	80	54	-
	EM 25x110	63	25	65	52	110	84	65.5
	EM 32x110	63	32	72	52	110	84	65.5
	HSK A 100	EM 8x80	100	8	28	-	80	51
EM 10x80		100	10	35	-	80	51	-
EM 12x80		100	12	42	-	80	51	-
EM 14x80		100	14	44	-	80	51	-
EM 16x100		100	16	48	-	100	71	-
EM 18x100		100	18	50	-	100	71	-
EM 20x100		100	20	52	-	100	71	-
EM 25x100		100	25	65	-	100	71	-
EM 32x100		100	32	72	-	100	71	-
EM 40x110	100	40	85	-	110	81	-	



HSK A-EM-E

End mill holders - Whistle notch

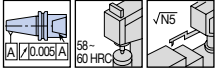
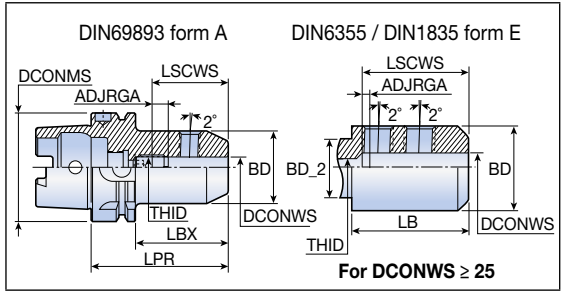

Designation	Dimension (mm)										
	DCONMS	DCONWS	BD	BD_2	LPR	LBX	LB	ADJRGA	LSCWS	THID	
HSK A 63	EM 6x80 E	63	6	25	-	80	54	-	8	40	M5
	EM 8x80 E	63	8	28	-	80	54	-	5	40	M6
	EM 10x80 E	63	10	35	-	80	54	-	5	44	M8
	EM 12x90 E	63	12	42	-	90	64	-	5	49	M10
	EM 14x90 E	63	14	44	-	90	64	-	5	49	M10
	EM 16x100 E	63	16	48	-	100	74	-	5	52	M12
	EM 18x100 E	63	18	50	-	100	74	-	8	55	M12
	EM 20x100 E	63	20	52	-	100	74	-	5	54	M16
	EM 25x110 E	63	25	65	52	110	84	65.5	7	61	M16
EM 32x110 E	63	32	72	52	110	84	65.5	5	63	M20x1.5	
HSK A 100	EM 8x90 E	100	8	28	-	90	61	-	5	40	M6
	EM 12x100 E	100	12	42	-	100	71	-	10	54	M10
	EM 14x100 E	100	14	44	-	100	71	-	10	54	M10
	EM 16x100 E	100	16	48	-	100	71	-	5	52	M12
	EM 18x100 E	100	18	50	-	100	71	-	5	52	M12
	EM 20x110 E	100	20	52	-	110	81	-	5	54	M16
	EM 25x120 E	100	25	65	-	120	91	-	7	61	M20x1.5
	EM 32x120 E	100	32	72	-	120	91	-	5	63	M20x1.5



HSK A-SRKIN



Thermal shrinking chucks

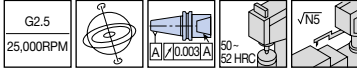
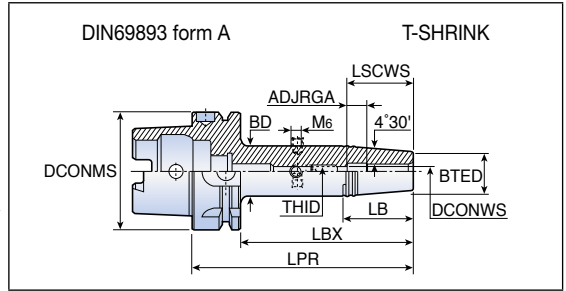

Designation	Dimension (mm)										
	DCONMS	DCONWS	BTED	BD	LPR	LBX	LB	ADJRGA	LSCWS	THID	Hex key
HSK A 50 SRKIN 6x80	50	6	21	27	80	54	38	11	36	M5	2.5
HSK A 63 SRKIN 6x80	63	6	21	27	80	54	38	11	36	M5	2.5
SRKIN 6x120	63	6	21	27	120	94	38	11	36	M5	2.5
SRKIN 6x160	63	6	21	27	160	134	38	11	36	M5	2.5
SRKIN 8x80	63	8	21	27	80	54	38	11	36	M6	3.0
SRKIN 8x120	63	8	21	27	120	94	38	11	36	M6	3.0
SRKIN 8x160	63	8	21	27	160	134	38	11	36	M6	3.0
SRKIN 10x85	63	10	24	32	85	54	51	11	42	M8	4.0
SRKIN 10x120	63	10	24	32	120	94	51	11	42	M8	4.0
SRKIN 10x160	63	10	24	32	160	134	51	11	42	M8	4.0
SRKIN 12x90	63	12	24	32	90	64	51	6	42	M8	4.0
SRKIN 12x120	63	12	24	32	120	94	51	11	47	M10	5.0
SRKIN 12x160	63	12	24	32	160	134	51	11	47	M10	5.0
SRKIN 14x90	63	14	27	34	90	64	45	11	47	M10	5.0
SRKIN 14x120	63	14	27	34	120	94	45	11	47	M10	5.0
SRKIN 14x160	63	14	27	34	160	134	45	11	47	M10	5.0
SRKIN 16x75	63	16	27	34	75	49	-	11	50	-	-
SRKIN 16x95	63	16	27	34	95	69	44	11	50	M12	6.0
SRKIN 16x120	63	16	27	34	120	94	44	11	50	M12	6.0
SRKIN 16x160	63	16	27	34	160	134	44	11	50	M12	6.0
SRKIN 18x95	63	18	33	42	95	69	57	11	50	M12	6.0
SRKIN 18x120	63	18	33	42	120	94	57	11	50	M12	6.0
SRKIN 18x160	63	18	33	42	160	134	57	11	50	M12	6.0
SRKIN 20x75	63	20	33	41	75	49	-	9	50	-	-
SRKIN 20x100	63	20	33	42	100	74	57	11	52	M16	8.0
SRKIN 20x120	63	20	33	42	120	94	57	11	52	M16	8.0
SRKIN 20x160	63	20	33	42	160	134	57	11	52	M16	8.0
SRKIN 25x85	63	25	44	53	85	59	-	11	58	-	-

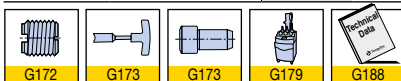

► Use only inductive heating device for T-SHRINK holders

HSK A-SRKIN



Thermal shrinking chucks

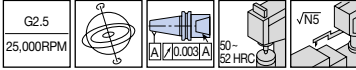
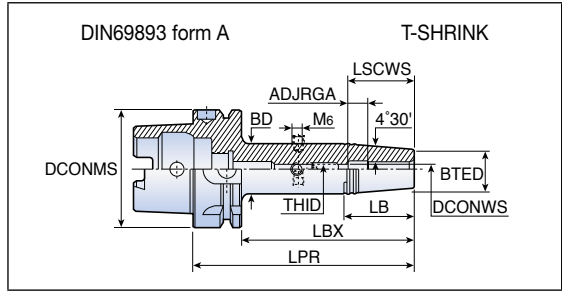

Designation	Dimension (mm)											
	DCONMS	DCONWS	BTED	BD	LPR	LBX	LB	ADJRGA	LSCWS	THID	Hex key	
HSK A 63 SRKIN 25x115	63	25	44	53	115	89	55	11	58	M16	8.0	
SRKIN 32x85	63	32	44	53	85	59	-	11	58	-	-	
SRKIN 32x120	63	32	44	53	120	94	55	11	58	M16	8.0	
HSK A 100 SRKIN 6x85	100	6	21	27	85	56	38	11	36	M5	2.5	
SRKIN 6x120	100	6	21	27	120	91	38	11	36	M5	2.5	
SRKIN 6x160	100	6	21	27	160	131	38	11	36	M6	3.0	
SRKIN 8x85	100	8	21	27	85	56	38	11	36	M6	3.0	
SRKIN 8x120	100	8	21	27	120	91	38	11	36	M6	3.0	
SRKIN 8x160	100	8	21	27	160	131	38	11	36	M6	3.0	
SRKIN 10x90	100	10	24	32	90	61	51	11	42	M8	4.0	
SRKIN 10x120	100	10	24	32	120	91	51	11	42	M8	4.0	
SRKIN 10x160	100	10	24	32	160	131	51	11	42	M8	4.0	
SRKIN 12x95	100	12	24	32	95	66	51	11	47	M10	5.0	
SRKIN 12x120	100	12	24	32	120	91	51	11	47	M10	5.0	
SRKIN 12x160	100	12	24	32	160	131	51	11	47	M10	5.0	
SRKIN 14x95	100	14	27	34	95	66	45	11	47	M10	5.0	
SRKIN 14x120	100	14	27	34	120	91	45	11	47	M10	5.0	
SRKIN 14x160	100	14	27	34	160	131	45	11	47	M10	5.0	
SRKIN 16x100	100	16	27	34	100	71	45	11	50	M12	6.0	
SRKIN 16x120	100	16	27	34	120	91	45	11	50	M12	6.0	
SRKIN 16x160	100	16	27	34	160	131	45	11	50	M12	6.0	
SRKIN 18x100	100	18	33	42	100	71	57	11	50	M12	6.0	
SRKIN 18x160	100	18	33	42	160	131	57	11	50	M12	6.0	
SRKIN 20x105	100	20	33	42	105	76	57	11	52	M16	8.0	
SRKIN 20x160	100	20	33	42	160	131	57	11	52	M16	8.0	
SRKIN 25x115	100	25	44	53	115	86	57	11	58	M16	8.0	
SRKIN 32x120	100	32	44	53	120	91	57	11	58	M16	8.0	

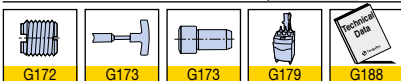

► Use only inductive heating device for T-SHRINK holders

Thermal shrinking chucks

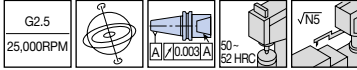
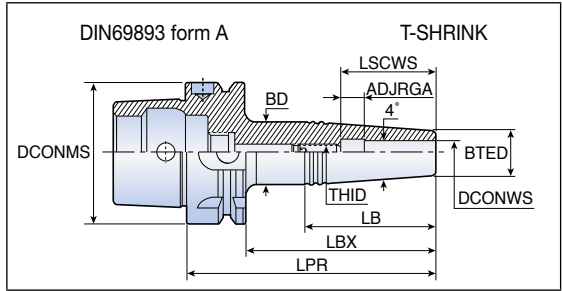

Designation	Dimension (mm)										
	DCONMS	DCONWS	BTED	BD	LPR	LBX	LB	ADJRGA	LSCWS	THID	Hex key
HSK A 63 SRK 3x50	63	3	10	17	76	50	-	6	16	M6	3.0
SRK 3x85	63	3	10	21	111	85	79	6	16	M6	3.0
SRK 4x50	63	4	10	17	76	50	-	6	18	M6	3.0
SRK 4x85	63	4	10	21	111	85	79	6	18	M6	3.0
SRK 5x50	63	5	10	17	76	50	-	6	21	M6	3.0
SRK 5x85	63	5	10	21	111	85	79	6	21	M6	3.0
SRK 6x50	63	6	11	18	76	50	-	6	24	M8	4.0
SRK 6x85	63	6	11	22	111	85	79	6	24	M8	4.0
SRK 8x50	63	8	14	20	76	50	43	11	36	M6	3.0
SRK 8x85	63	8	14	23	111	85	64	11	36	M6	3.0
SRK 10x50	63	10	16	23	76	50	-	11	41	M8	4.0
SRK 10x85	63	10	16	26	111	85	72	11	41	M8	4.0
SRK 12x50	63	12	20	27	76	50	-	11	43	M8	4.0
SRK 12x85	63	12	20	30	111	85	72	11	43	M8	4.0

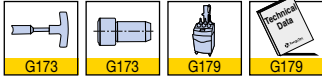

Thermal shrinking chucks

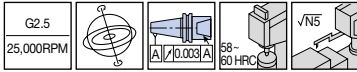
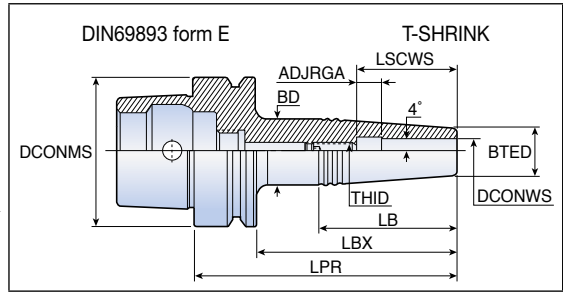

Designation	Dimension (mm)										
	DCONMS	DCONWS	BTED	BD	LPR	LBX	LB	ADJRGA	LSCWS	THID	Hex key
HSK E 32 SRK 3x45	32	3	10	13	65	45	30.0	6	16	M4	2.0
SRK 4x45	32	4	10	15	65	45	35.0	6	18	M4	2.0
SRK 6x45	32	6	11	16	65	45	35.0	10	28	M4	2.0
SRK 10x45	32	12	16	22	65	45	42.0	10	40	M4	2.0
HSK E 40 SRK 3x45	40	3	10	13	65	45	30.0	6	16	M5	2.5
SRK 3x80	40	3	10	19	100	80	64.0	6	16	M5	2.5
SRK 4x45	40	4	10	15	65	45	35.0	6	18	M5	2.5
SRK 4x80	40	4	10	19	100	80	64.0	6	18	M5	2.5
SRK 5x45	40	5	10	15	65	45	35.0	10	25	M4	2.0
SRK 5x80	40	5	10	19	100	80	64.0	10	25	M4	2.0
SRK 6x45	40	6	11	16	65	45	35.0	10	28	M5	2.5
SRK 6x80	40	6	11	20	100	80	64.0	10	28	M5	2.5
SRK 8x45	40	8	14	20	65	45	42.0	10	35	M5	2.5
SRK 8x80	40	8	14	23	100	80	64.0	10	35	M6	3.0
SRK 10x45	40	10	16	22	65	45	42.0	10	40	M5	2.5
SRK 10x80	40	10	16	24	100	80	60.0	10	40	M8	4.0
SRK 12x45	40	12	20	26	65	45	42.0	10	42	M5	2.5
SRK 12x80	40	12	20	28	100	80	56.0	10	42	M10	5.0
HSK E 50 SRK 3x45	50	3	10	15	71	45	36.0	6	16	M5	2.5
SRK 3x80	50	3	10	19	106	80	64.0	6	16	M5	2.5
SRK 4x45	50	4	10	15	71	45	36.0	6	18	M5	2.5
SRK 4x80	50	4	10	19	106	80	64.0	6	18	M5	2.5
SRK 6x45	50	6	11	16	71	45	36.0	10	28	M5	2.5
SRK 6x80	50	6	11	20	106	80	64.0	10	28	M5	2.5
SRK 8x45	50	8	14	20	71	45	43.0	10	35	M6	3.0
SRK 8x80	50	8	14	23	106	80	64.0	10	35	M6	3.0
SRK 10x45	50	10	16	22	71	45	42.0	7	37	M6	3.0
SRK 10x80	50	10	16	24	106	80	60.0	10	40	M8	4.0
SRK 12x45	50	12	20	26	71	45	42.0	7	39	M6	3.0

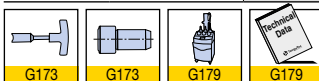

HSK A-THC

Hydraulic chucks

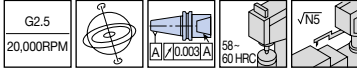
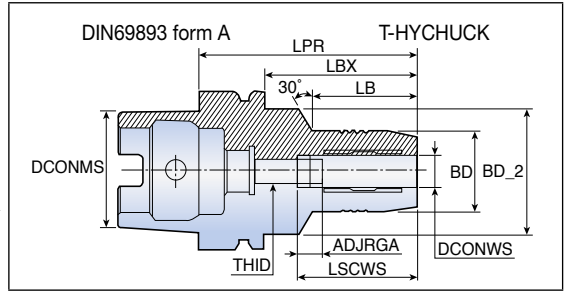

Designation	Dimension (mm)										
	DCONMS	DCONWS	BD	BD_2	LPR	LBX	LB	ADJRGA	LSCWS	THID	
HSK A 40	THC 6-70	40	6	28	34	70	50	28	10	37.5	M5
	THC 8-70	40	8	30	34	70	50	28	10	37.5	M6
	THC 10-75	40	10	32	34	75	55	34	10	42.5	M6
	THC 12-85	40	12	34	34	85	60	60	10	47.5	M6
HSK A 50	THC 6-70	50	6	28	40	70	44	28	10	37.5	M5
	THC 8-70	50	8	30	40	70	44	28	10	37.5	M6
	THC 10-75	50	10	32	40	75	49	34	10	42.5	M8x1
	THC 12-80	50	12	34	40	85	59	39	10	47.5	M10x1
	THC 16-90	50	16	38	53	90	64	30	10	52.5	M10x1
	THC 20-90	50	20	43	60	90	64	29	10	52.5	M10x1
	THC 25-120	50	25	48	67	120	71	30	10	57.5	M10x1
HSK A 63	THC 6-70	63	6	28	50	70	44	24	10	37.5	M5
	THC 8-70	63	8	30	50	70	44	24	10	37.5	M6
	THC 10-80	63	10	32	50	80	54	35	10	42.5	M8x1
	THC 12-85	63	12	34	50	85	59	40	10	47.5	M10x1
	THC 14-85	63	14	36	50	85	59	40	10	47.5	M10x1
	THC 16-90	63	16	38	50	90	64	46	10	52.5	M10x1
	THC 20-90	63	20	43	50	90	64	48	10	52.5	M10x1
	THC 25-120	63	25	48	63	120	71	30	10	57.5	M10x1
	THC 32-125	63	32	53	63	125	76	30	10	62.5	M10x1
	THC 32-125	63	32	63	75	125	99	63	10	65.0	M16x1
HSK A 100	THC 6-80⁽¹⁾	100	6	28	50	80	46	29	10	37.5	M5
	THC 8-75⁽¹⁾	100	8	30	54	75	46	26	10	37.5	M6
	THC 10-90⁽¹⁾	100	10	32	50	90	61	42	10	42.5	M8x1
	THC 12-95⁽¹⁾	100	12	34	50	95	66	47	10	47.5	M10x1
	THC 16-100⁽¹⁾	100	16	38	50	100	71	53	10	52.5	M10x1
	THC 18-100⁽¹⁾	100	18	41	50	100	71	53	10	52.5	M10x1
	THC 20-105⁽¹⁾	100	20	43	50	105	76	59	10	52.5	M10x1
	THC 25-110⁽¹⁾	100	25	48	53	110	81	62	10	57.5	M10x1
THC 32-110⁽¹⁾	100	32	53	63	110	81	62	10	57.5	M16x1	

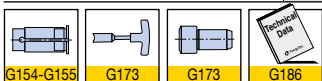

► ⁽¹⁾ Balance to G2.5 at 15,000RPM

HSK E-THC

Hydraulic chucks

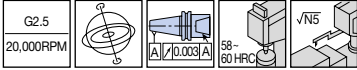
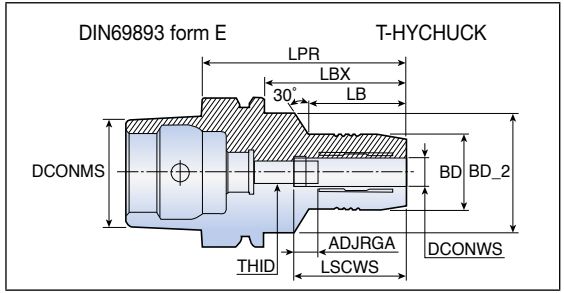

Designation	Dimension (mm)										
	DCONMS	DCONWS	BD	BD_2	LPR	LBX	LB	ADJRGA	LSCWS	THID	
HSK E 40 THC 6-70	40	6	28	34	70	50	28	10	37.5	M5	
THC 8-70	40	8	30	34	70	50	28	10	37.5	M6	
THC 10-75	40	10	32	34	75	55	34	10	42.5	M6	
THC 12-80	40	12	34	34	80	60	-	10	47.5	M6	
HSK E 50 THC 6-70	50	6	28	40	70	44	28	10	37.5	M5	
THC 8-70	50	8	30	40	70	44	28	10	37.5	M6	
THC 10-75	50	10	32	40	75	49	34	10	42.5	M8x1	
THC 12-85	50	12	34	40	85	59	44	10	47.5	M10x1	
THC 16-90	50	16	38	53	90	64	30	10	52.5	M10x1	
THC 20-90	50	20	43	60	90	64	29	10	52.5	M10x1	

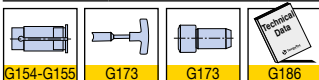

HSK A-SEM

Face mill arbors

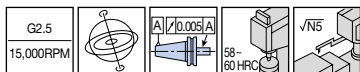
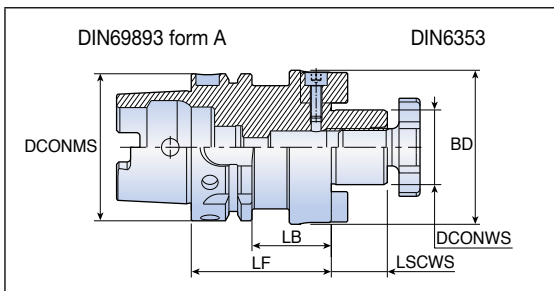

Designation	Dimension (mm)					
	DCONMS	DCONWS	BD	LF	LB	LSCWS
HSK A 63 SEM 16x50	63	16	38	50	24	17
SEM 22x50	63	22	47	50	24	19
SEM 27x60	63	27	58	60	34	21
SEM 32x60	63	32	66	60	34	24
SEM 40x60	63	40	82	60	24	27
HSK A 100 SEM 22x50⁽¹⁾	100	22	47	50	21	19
SEM 27x50⁽¹⁾	100	27	58	50	21	21
SEM 32x50⁽¹⁾	100	32	66	50	21	24
SEM 40x60⁽¹⁾	100	40	82	60	31	27
SEM 50x70⁽¹⁾	100	50	95	70	41	30

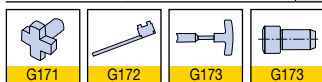

► Wrench not included
► ⁽¹⁾ Balance to G6.3 at 12,000RPM

HSK A-SEM-C

Face mill arbors with internal coolant hole

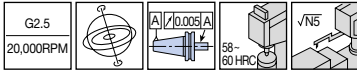
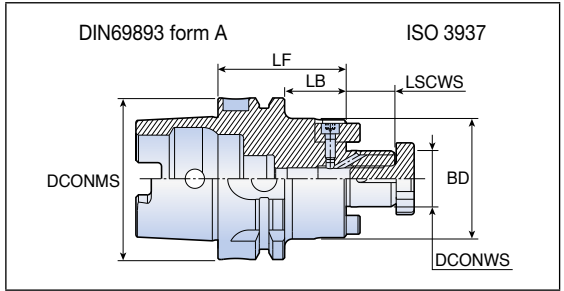

Designation	Dimension (mm)					
	DCONMS	DCONWS	BD	LF	LB	LSCWS
HSK A 63 SEM 16x50 C	63	16	38	50	24	17
SEM 16x100 C	63	16	38	100	74	17
SEM 22x50 C	63	22	47	50	24	19
SEM 22x100 C	63	22	47	100	74	19
SEM 27x60 C	63	27	58	60	34	21
SEM 27x100 C	63	27	58	100	74	21
SEM 32x60 C	63	32	66	60	34	24
HSK A 100 SEM 16x50 C⁽¹⁾	100	16	38	50	21	17
SEM 16x100 C⁽¹⁾	100	16	38	100	71	17
SEM 22x50 C⁽¹⁾	100	22	47	50	21	19
SEM 22x100 C⁽¹⁾	100	22	47	100	71	19
SEM 27x50 C⁽¹⁾	100	27	58	50	21	21
SEM 27x100 C⁽¹⁾	100	27	58	100	71	21
SEM 32x50 C⁽¹⁾	100	32	66	50	21	24
SEM 32x100 C⁽¹⁾	100	32	66	100	71	24

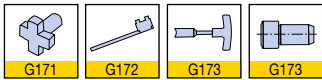

▶ Wrench not included
▶ ⁽¹⁾ Balance to G2.5 at 15,000RPM

HSK A-SEMC

Combi shell end mill arbors

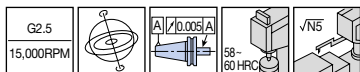
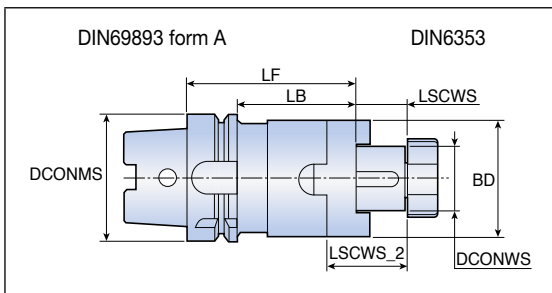

Designation	Dimension (mm)						
	DCONMS	DCONWS	BD	LF	LB	LSCWS	LSCWS_2
HSK A 63 SEMC 16x60	63	16	32	60	34	17	21
SEMC 22x60	63	22	40	60	34	19	31
SEMC 27x60	63	27	48	60	34	21	33
SEMC 32x60	63	32	58	60	34	24	38
SEMC 40x70	63	40	70	70	44	27	41
HSK A 100 SEMC 16x60	100	16	32	60	31	17	27
SEMC 22x60	100	22	40	60	31	19	31
SEMC 27x60	100	27	48	60	31	21	33
SEMC 32x60	100	32	58	60	31	24	38
SEMC 40x70	100	40	70	70	41	27	41
SEMC 50x80	100	50	90	80	51	30	46

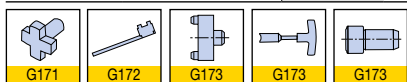

► Wrench not included

HSK A-FM

Face mill arbors

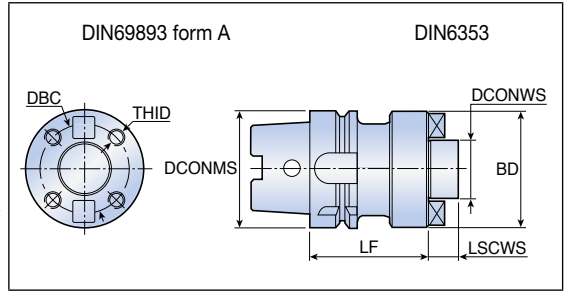
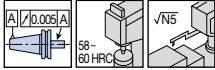

Designation	Dimension (mm)						
	DCONMS	DCONWS	BD	DBC	LF	LSCWS	THID
HSK A 100 FM 60x70	100	60	128	101.6	70	40	M16

► Wrench not included

HSK FM-SEM

Face mill arbors - HSK high torque

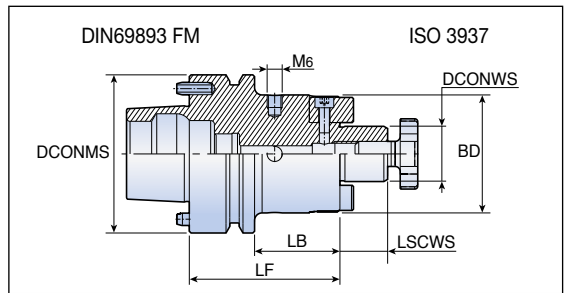
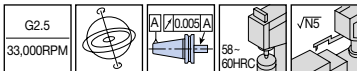

Designation	Dimension (mm)					
	DCONMS	DCONWS	BD	LF	LB	LSCWS
HSK FM 63 SEM 22x60	63	22	47	60	34	19

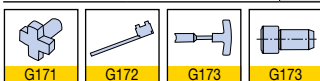

► ⁽¹⁾ The driving pins can be removed to turn the toolholder into a standard HSK F 63 type

T-FLEXTEC holders

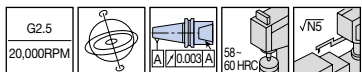
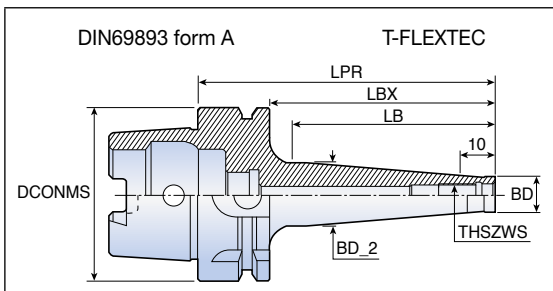

Designation	Dimension (mm)						
	DCONMS	THSZWS	BD	BD_2	LPR	LBX	LB
HSK A 63 ODP 6x109	63	M06	9.8	23.0	109	83	75
	63	M08	13.1	15.0	59	33	25
	63	M08	13.1	23.0	109	83	75
	63	M10	18.0	20.0	59	33	25
	63	M10	18.0	28.0	109	83	75
	63	M12	21.0	24.0	59	33	25
	63	M12	21.0	31.0	109	83	75
	63	M16	29.0	34.0	59	33	25
	63	M16	29.0	34.0	109	83	75
HSK A 100 ODP 12x87 ⁽¹⁾	100	M12	23.0	30.0	87	58	50
	100	M12	23.0	30.0	137	108	100
	100	M12	23.0	40.0	187	158	150
	100	M12	23.0	46.0	237	208	200
	100	M16	29.0	31.5	87	58	50
	100	M16	29.0	41.5	137	108	100
	100	M16	29.0	55.0	187	158	150
	100	M16	29.0	55.0	237	208	200

▶⁽¹⁾ Balance to G6.3 at 12,000RPM

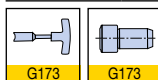

HSK A-B-MN

HSK blanks

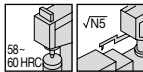
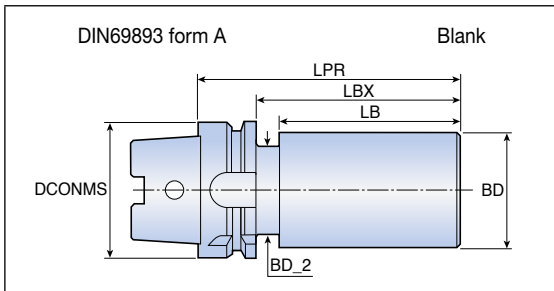

Designation	Dimension (mm)					
	DCONMS	BD	BD_2	LPR	LBX	LB
HSK A 100 B16MN 200	100	102	85.0	200	171	154.8

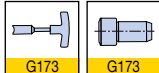

- Material: Case hardened alloy steel
- Shank hardness 57-60 HRC minimum
- Nose hardness 22-30 HRC

BT MAS



BT MAS 403 Form A/AD/B/ADB

Standard toolholder

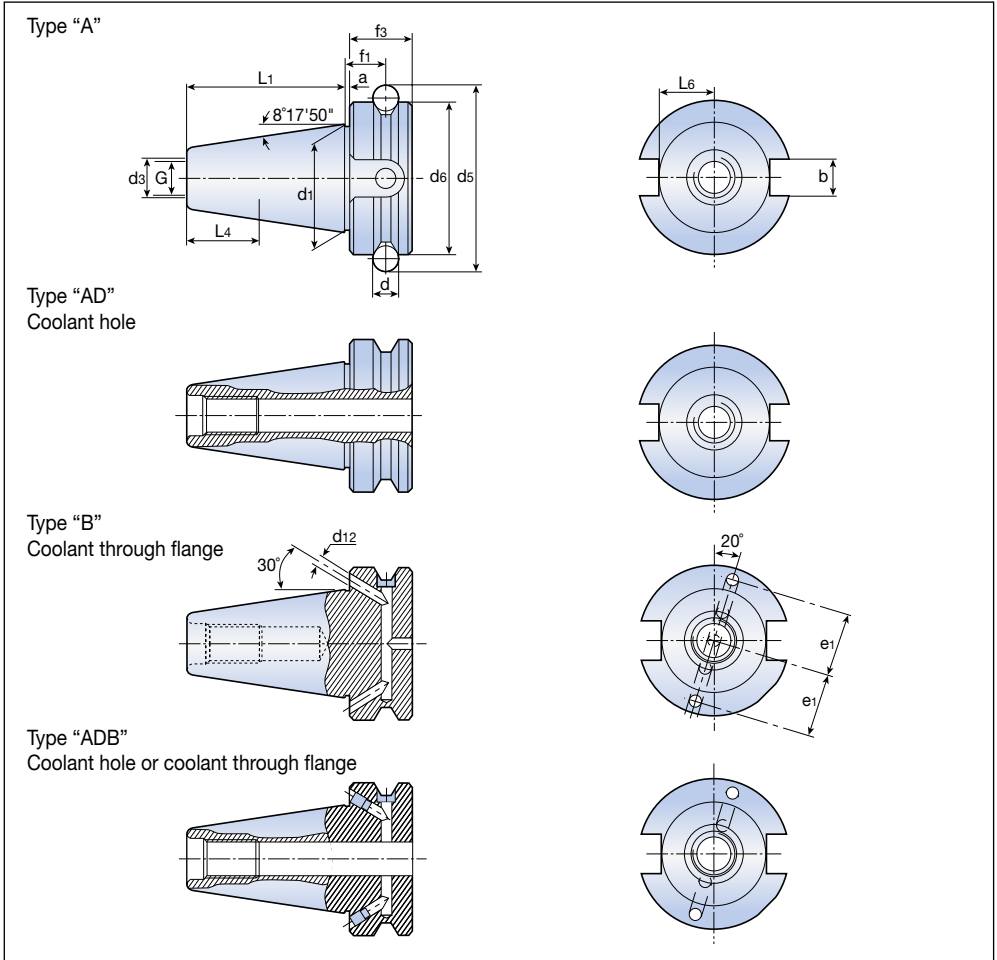

Shank	a ±0.1	b (H12)	d	d1	G	d3 (H8)	d5	d6 (H8)
30	2	16.1	8	31.75	M12	12.5	56.144	46
40	2	16.1	10	44.45	M16	17.0	75.679	63
50	3	25.7	15	69.85	M24	25.0	119.020	100

Shank	f1 ±0.1	f3	L1 ±0.2	L4min	L6 -0.2	e1 ±0.1	d12	Taper AT3
30	13.6	20	48.4	24	16.3	21	4	0.002
40	16.6	25	65.4	30	22.6	27	4	0.003
50	23.2	35	101.8	45	35.4	42	6	0.004

► For non-stock items: Supply condition is subject to availability
 If not available in stock then MOQ (Minimum order qty) will be applicable

BT-ER

ER collet chucks

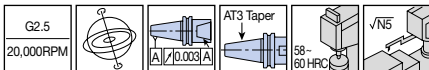
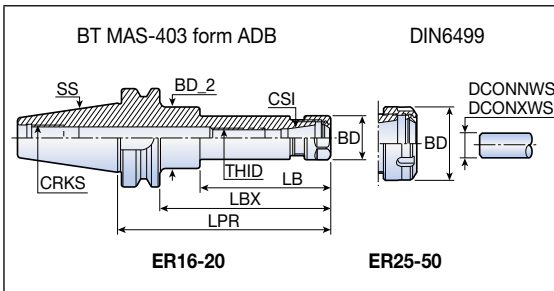

Designation	Dimension (mm)											
	SS	CSI	DCONNWS	DCONXWS	BD	BD_2	LPR	LBX	LB	CRKS	THID	
BT30 ER 16x70⁽¹⁾	30	ER16	0.5	10.0	28	-	70	48	-	M12	M10	
ER 16x100⁽¹⁾	30	ER16	0.5	10.0	28	-	100	73	-	M12	M10	
ER 20x70⁽¹⁾	30	ER20	1.0	13.0	34	-	70	48	-	M12	M12	
ER 25x60⁽¹⁾	30	ER25	1.0	16.0	42	-	60	38	-	M12	M16	
ER 32x60⁽¹⁾	30	ER32	2.0	20.0	50	-	60	38	-	M12	M18x1.5	
BT40 ER 16x70	40	ER16	0.5	10.0	28	-	70	43	-	M16	M12	
ER 16x100	40	ER16	0.5	10.0	28	-	100	73	-	M16	M12	
ER 16x150⁽¹⁾	40	ER16	0.5	10.0	28	40	150	123	85	M16	M12	
ER 16x200⁽¹⁾	40	ER16	0.5	10.0	28	40	200	173	85	M16	M10	
ER 20x70	40	ER20	1.0	13.0	34	-	70	43	-	M16	M12	
ER 20x100	40	ER20	1.0	13.0	34	-	100	73	-	M16	M12	
ER 20x120	40	ER20	1.0	13.0	34	-	120	93	-	M16	M12	
ER 20x150⁽¹⁾	40	ER20	1.0	13.0	34	-	150	123	-	M16	M12	
ER 25x60	40	ER25	1.0	13.0	42	-	60	33	-	M16	M16	
ER 25x100	40	ER25	1.0	16.0	42	-	100	73	-	M16	M16	
ER 25x150⁽¹⁾	40	ER25	1.0	16.0	42	-	150	123	-	M16	M16	
ER 32x60	40	ER32	2.0	20.0	50	-	60	33	-	M16	M22x1.5	
ER 32x100	40	ER32	2.0	20.0	50	-	100	73	-	M16	M22x1.5	
ER 32x150⁽¹⁾	40	ER32	2.0	20.0	50	-	150	123	-	M16	M22x1.5	
ER 32x200⁽¹⁾	40	ER32	2.0	20.0	50	-	200	162	-	M17	M22x1.6	
ER 40x80	40	ER40	3.0	26.0	63	-	80	53	-	M16	M28x1.5	
ER 40x100	40	ER40	3.0	26.0	63	-	100	73	-	M16	M28x1.5	
ER 40x150⁽¹⁾	40	ER40	3.0	26.0	63	-	150	123	-	M16	M28x1.5	
ER 50x90	40	ER50	10.0	34.0	78	-	90	63	-	M16	M28x1.5	
BT50 ER 16x100⁽¹⁾	50	ER16	0.5	10.0	28	-	100	62	-	M24	M12	
ER 16x125⁽¹⁾	50	ER16	0.5	10.0	28	-	125	87	-	M24	M12	
ER 16x150⁽¹⁾	50	ER16	0.5	10.0	28	-	150	112	-	M24	M12	
ER 16x200⁽¹⁾	50	ER16	0.5	10.0	28	40	200	162	85	M24	M10	
ER 20x100⁽¹⁾	50	ER20	1.0	10.0	34	-	100	62	-	M24	M12	
ER 20x125⁽¹⁾	50	ER20	1.0	13.0	34	-	125	87	-	M24	M12	
ER 20x150⁽¹⁾	50	ER20	1.0	13.0	34	-	150	112	-	M24	M12	
ER 20x200⁽¹⁾	50	ER20	1.0	13.0	34	50	200	162	85	M24	M12	

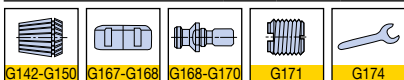

► ⁽¹⁾ Balance to G6.3 at 12,000RPM

BT-ER

ER collet chucks

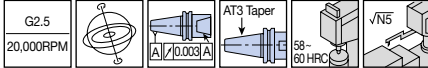
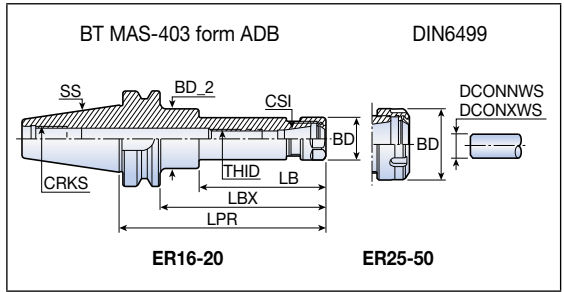

Designation	Dimension (mm)											
	SS	CSI	DCONNWS	DCONXWS	BD	BD_2	LPR	LBX	LB	CRKS	THID	
BT50 ER 25x100	50	ER25	1.0	16.0	42	-	100	62	-	M24	M16	
ER 25x150	50	ER25	1.0	16.0	42	-	150	112	-	M24	M16	
ER 25x200⁽¹⁾	50	ER25	1.0	16.0	42	55	200	162	87	M24	M16	
ER 32x100	50	ER32	2.0	20.0	50	-	100	62	-	M24	M22x1.5	
ER 32x125	50	ER32	2.0	20.0	50	-	125	87	-	M24	M22x1.5	
ER 32x150	50	ER32	2.0	20.0	50	-	150	112	-	M24	M22x1.5	
ER 32x200⁽¹⁾	50	ER32	2.0	20.0	50	63	200	162	88	M24	M22x1.5	
ER 40x100	50	ER40	3.0	26.0	63	-	100	62	-	M24	M28x1.5	
ER 40x150	50	ER40	3.0	26.0	63	-	150	112	-	M24	M28x1.5	
ER 40x200⁽¹⁾	50	ER40	3.0	26.0	63	-	200	162	-	M24	M28x1.5	
ER 50x100	50	ER50	3.0	26.0	78	-	100	62	-	M24	M36x1.5	
ER 50x150	50	ER50	10.0	34.0	78	-	150	112	-	M24	M36x1.5	

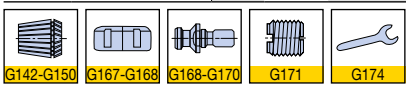

► ⁽¹⁾ Balance to G6.3 at 12,000RPM

BT-FC-ER

ER collet chucks

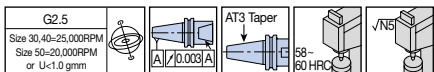
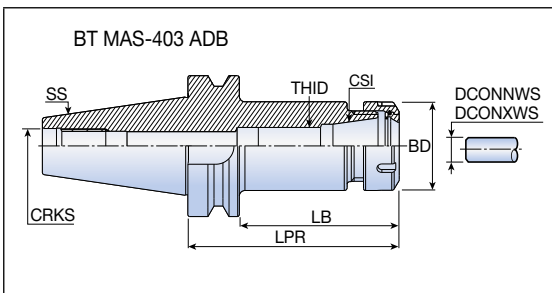

Designation	Dimension (mm)									
	SS	CSI	DCONNWS	DCONXWS	BD	LPR	LB	CRKS	THID	
BT30 FC ER16X70	30	ER16	0.5	10.0	28	70	48	M12	M10	
FC ER16X100	30	ER16	0.5	10.0	28	100	79	M12	M10	
FC ER20X70	30	ER20	1.0	13.0	34	70	48	M12	M12	
FC ER25X60	30	ER25	1.0	16.0	42	60	38	M12	M16	
FC ER32X60	30	ER32	2.0	20.0	50	60	38	M12	M18	
BT40 FC ER16X70	40	ER16	0.5	10.0	28	70	44	M16	M12	
FC ER16X100	40	ER16	0.5	10.0	28	100	74	M16	M12	
FC ER32X60	40	ER32	2.0	20.0	50	60	34	M16	M22X1.5	
FC ER32X100	40	ER32	2.0	20.0	50	100	74	M16	M22X1.5	
FC ER40X80	40	ER40	3.0	26.0	63	80	54	M16	M28X1.5	
BT50 FC ER16X100	50	ER16	0.5	10.0	28	100	63.5	M24	M12	
FC ER16X150	50	ER16	0.5	10.0	28	150	113.5	M24	M12	
FC ER32X100	50	ER32	2.0	20.0	50	100	63.5	M24	M22X1.5	
FC ER32X150	50	ER32	2.0	20.0	50	150	113.5	M24	M22X1.5	
FC ER40X100	50	ER40	3.0	26.0	63	100	63.5	M24	M28X1.5	
FC ER40X150	50	ER40	3.0	26.0	63	150	113.5	M24	M28X1.5	

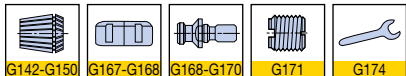

BT-ER-SHORT



Short ER collet chucks

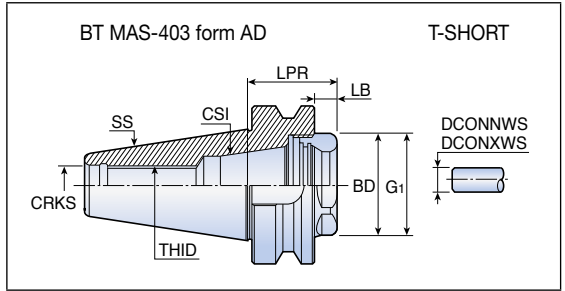

G2.5 20,000RPM					
-------------------	--	--	--	--	--

Designation	Dimension (mm)									
	SS	CSI	DCONNWS	DCONXWS	BD	LPR	LB	CRKS	G1	THID
BT30 ER 20 SHORT	30	ER20	1.0	13.0	25	27.2	5.2	M12	M25x1.5	M12
BT40 ER 32 SHORT	40	ER32	2.0	20.0	40	36.5	9.5	M16	M40x1.5	M16
ER 40 SHORT	40	ER40	3.0	26.0	50	46.5	9.5	M16	M50x1.5	M16
BT50 ER 32 SHORT	50	ER32	2.0	20.0	40	47.5	9.5	M24	M40x1.5	M22x1.5
ER 40 SHORT	50	ER40	3.0	26.0	50	47.5	9.5	M24	M50x1.5	M28x1.5

--	--	--	--	--	--

► Add B for coolant through flange

BT-TSK

TSK collet chucks

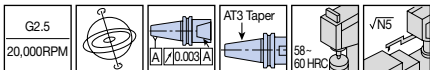
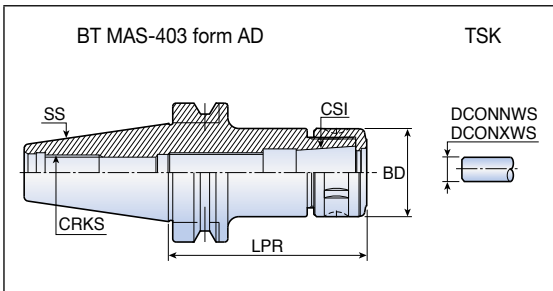

Designation	Dimension (mm)						
	SS	CSI	DCONNWS	DCONXWS	BD	LPR	CRKS
BT30 TSK 6-90 ⁽¹⁾	30	TSK6	1.5	6.0	19.5	90	M12
TSK 10-90 ⁽¹⁾	30	TSK10	1.5	10.0	27.5	90	M12
BT40 TSK 6-90	40	TSK6	1.5	6.0	19.5	90	M16
TSK 6-120	40	TSK6	1.5	6.0	19.5	120	M16
TSK 10-90	40	TSK10	1.5	10.0	27.5	90	M16
TSK 10-120	40	TSK10	1.5	10.0	27.5	120	M16
TSK 16-90	40	TSK16	2.5	16.0	40.0	90	M16
TSK 16-120	40	TSK16	2.5	16.0	40.0	120	M16
TSK 25-90	40	TSK25	7.5	25.0	55.0	90	M16
TSK 25-120	40	TSK25	7.5	25.0	55.0	120	M16
BT50 TSK 6-120 ⁽¹⁾	50	TSK6	1.5	6.0	19.5	120	M24
TSK 6-165 ⁽¹⁾	50	TSK6	1.5	6.0	19.5	165	M24
TSK 6-195 ⁽¹⁾	50	TSK6	1.5	6.0	19.5	195	M24
TSK 10-120 ⁽¹⁾	50	TSK10	1.5	10.0	27.5	120	M24
TSK 10-165 ⁽¹⁾	50	TSK10	1.5	10.0	27.5	165	M24
TSK 10-195 ⁽¹⁾	50	TSK10	1.5	10.0	27.5	195	M24
TSK 16-120 ⁽¹⁾	50	TSK16	2.5	16.0	40.0	120	M24
TSK 16-165 ⁽¹⁾	50	TSK16	2.5	16.0	40.0	165	M24
TSK 16-195 ⁽¹⁾	50	TSK16	2.5	16.0	40.0	195	M24
TSK 25-120 ⁽¹⁾	50	TSK25	7.5	25.0	55.0	120	M24
TSK 25-165 ⁽¹⁾	50	TSK25	7.5	25.0	55.0	165	M24
TSK 25-195 ⁽¹⁾	50	TSK25	7.5	25.0	55.0	195	M24

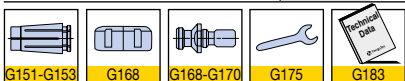

▶ Add B for coolant through flange
 ▶ ⁽¹⁾ Balance to G6.3 at 20,000RPM

GTI BT-ER

GTI tap attachments

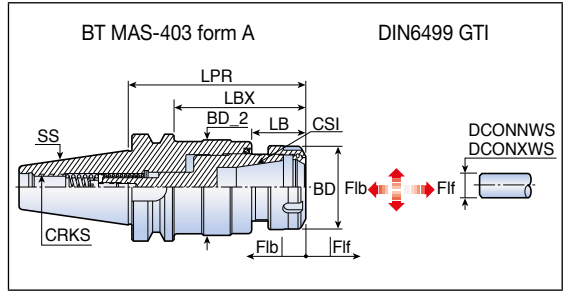
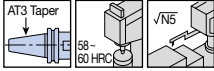

Designation	Dimension (mm)													
	SS	CSI	Tap _{min}	Tap _{max}	DCONNWS	DCONXWS	BD	BD_2	LPR	LBX	LB	F1f	F1b	CRKS
GTI BT40 ER16	40	ER16	M3	M10	0.5	10.0	28	29.5	84.2	52.7	24.6	8	3	M16
ER32	40	ER32	M6	M20	2.0	20.0	50	56.5	106.8	79.8	33.0	9	4	M16
ER40	40	ER40	M6	M28	3.0	26.0	63	56.5	124.8	97.8	51.0	9	4	M16
GTI BT50 ER16	50	ER16	M3	M10	0.5	10.0	28	29.5	106.8	68.8	24.6	8	3	M24
ER32	50	ER32	M6	M20	2.0	20.0	50	56.5	114.2	77.2	33.0	9	4	M24
ER40	50	ER40	M6	M28	3.0	26.0	63	56.5	133.2	95.2	51.0	9	4	M24

► No coolant should be induced through the tap chuck as it will cause malfunctioning of the mechanism

BT-TC

Tap holders

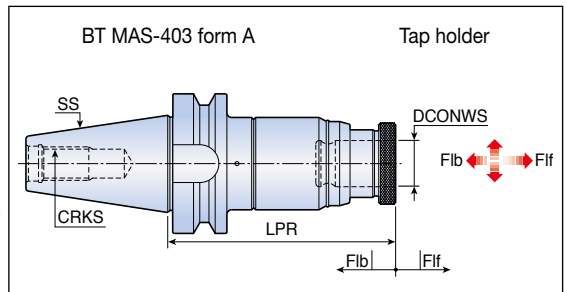
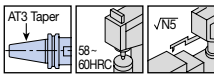

Designation	Dimension (mm)								
	SS	Tap _{min}	Tap _{max}	DCONWS	LPR	F1b	F1f	Tap adapter	CRKS
BT30 TC 12-105	30	M3	M12	19	105	6.5	12	TA1	M12
BT40 TC 12-95	40	M3	M12	19	95	6.5	12	TA1	M16
TC 12-110	40	M3	M12	19	110	6.5	12	TA1	M16
TC 22-127	40	M6	M24	31	127	14.5	13	TA2	M16
BT50 TC 12-125	50	M6	M12	19	125	6.5	12	TA1	M24
TC 22-142	50	M6	M24	31	142	14.5	13	TA2	M24
TC 38-195	50	M18	M38	48	195	20.0	20	TA3	M24

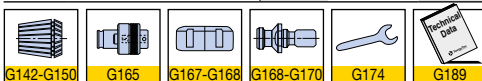

BT-NTMC

Milling chucks

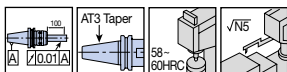
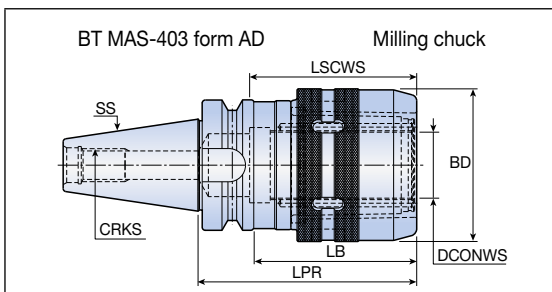

Designation	Dimension (mm)						
	SS	DCONWS	BD	LPR	LB	LSCWS	CRKS
BT30 NTMC 20-75	30	20	53	75	51.4	70	M12
NTMC 25-80	30	25	62	80	58.3	70	M12
BT40 NTMC 20-80	40	20	53	80	53	82	M16
NTMC 20-90	40	20	53	90	63	82	M16
NTMC 25-90	40	25	62	90	63	85	M16
NTMC 25-105	40	25	62	105	78	95	M16
NTMC 32-85	40	32	72	85	56	80	M16
NTMC 32-105	40	32	72	105	78.5	90	M16
NTMC 32-120	40	32	72	120	93.5	105	M16
BT50 NTMC 20-105	50	20	53	105	67	82	M24
NTMC 20-135	50	20	53	135	97	82	M24
NTMC 20-165	50	20	53	165	127	82	M24
NTMC 25-105	50	25	62	105	67	90	M24
NTMC 25-135	50	25	62	135	97	90	M24
NTMC 25-165	50	25	62	165	127	90	M24
NTMC 32-105	50	32	74	105	67	110	M24
NTMC 32-120	50	32	74	120	82	125	M24
NTMC 32-135	50	32	74	135	97	125	M24
NTMC 32-165	50	32	74	165	127	125	M24
NTMC 42-120	50	42	94	120	82	125	M24
NTMC 42-135	50	42	94	135	97	130	M24
NTMC 42-165	50	42	94	165	127	135	M24

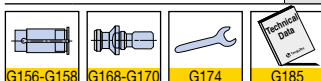

► Spanner not included

BT-EM

Short end mill holders

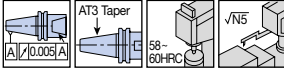
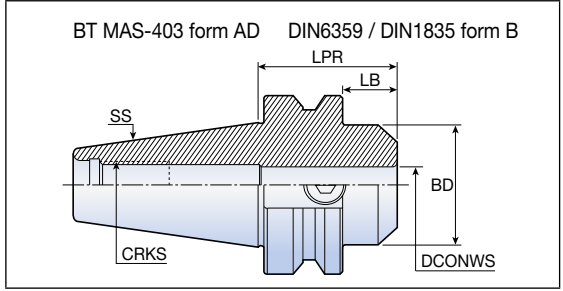

Designation	Dimension (mm)					
	SS	DCONWS	BD	LPR	LB	CRKS
BT40 EM 10x45	40	10	35	45	18	M16
EM 12x45	40	12	42	45	18	M16
EM 14x45	40	14	44	45	18	M16
EM 16x45	40	16	48	45	18	M16
EM 18x45	40	18	50	45	18	M16
EM 20x45	40	20	52	45	18	M16
EM 25x45	40	25	63	45	-	M16

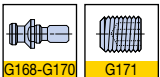

► Add B for coolant through flange

BT-EM

End mill holders

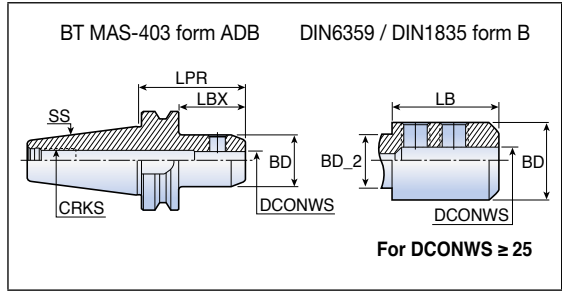
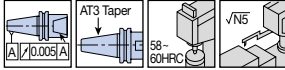

Designation	Dimension (mm)							
	SS	DCONWS	BD	BD_2	LPR	LBX	LB	CRKS
BT30 EM 6x50	30	6	25	-	50	28	-	M12
EM 8x60	30	8	28	-	60	38	-	M12
EM 10x60	30	10	35	-	60	38	-	M12
EM 12x60	30	12	42	-	60	38	-	M12
EM 14x60	30	14	44	-	60	38	-	M12
EM 16x60	30	16	46	-	60	38	-	M12
EM 18x60	30	18	50	-	60	38	-	M12
EM 20x80	30	20	52	-	80	58	-	M12
BT40 EM 6x50	40	6	25	-	50	23	-	M16
EM 8x50	40	8	28	-	50	23	-	M16
EM 10x65	40	10	35	-	65	38	-	M16
EM 12x65	40	12	42	-	65	38	-	M16
EM 14x65	40	14	44	-	65	38	-	M16
EM 16x65	40	16	48	-	65	38	-	M16
EM 18x65	40	18	50	-	65	38	-	M16
EM 20x75	40	20	52	-	75	48	-	M16
EM 25x105	40	25	65	61	105	78	68	M16
EM 32x110	40	32	72	61	110	83	73	M16
BT50 EM 6x70	50	6	25	-	70	32	-	M24
EM 8x70	50	8	28	-	70	32	-	M24
EM 10x70	50	10	35	-	70	32	-	M24
EM 12x100	50	12	42	-	100	62	-	M24
EM 14x100	50	14	44	-	100	62	-	M24
EM 16x100	50	16	48	-	100	62	-	M24
EM 18x100	50	18	50	-	100	62	-	M24
EM 20x100	50	20	52	-	100	62	-	M24
EM 25x115	50	25	65	-	115	77	-	M24
EM 32x115	50	32	72	-	115	77	-	M24
EM 40x115	50	40	90	-	115	77	-	M24
EM 50x125	50	50	100	-	125	87	-	M24

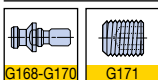

BT-FC-EM

End mill holders

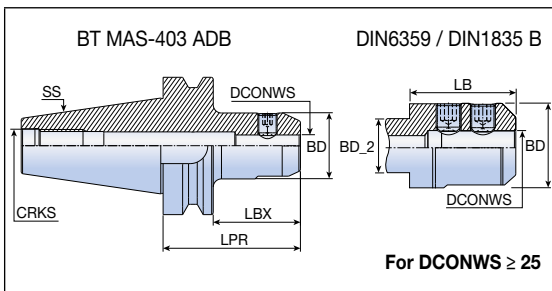
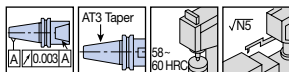

Designation	Dimension (mm)							
	SS	DCONWS	BD	BD_2	LPR	LBX	LB	CRKS
BT30 FC EM12X60	30	12	42	-	60	38	-	M12
FC EM16X60	30	16	45.9	-	60	38	-	M12
FC EM20X80	30	20	52	44.4	80	58	48	M12
BT40 FC EM10X65	40	10	35	-	65	39	-	M16
FC EM12X65	40	12	42	-	65	39	-	M16
FC EM16X65	40	16	48	-	65	39	-	M16
FC EM20X75	40	20	52	-	75	49	-	M16
FC EM25X105	40	25	65	61	105	79	68	M16
FC EM32X110	40	32	71	61	110	83	73	M16
BT50 FC EM12X100	50	12	42	-	100	62	-	M24
FC EM16X100	50	16	48	-	100	63.5	-	M24
FC EM20X100	50	20	52	-	100	63.5	-	M24
FC EM25X115	50	25	65	-	115	78.5	-	M24
FC EM32X115	50	32	71	-	115	78.5	-	M24
FC EM40X115	50	40	90	-	115	78.5	-	M24
FC EM50X125	50	50	100	-	125	87	-	M24

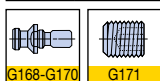

BT-EM-E

End mill holders - Whistle notch

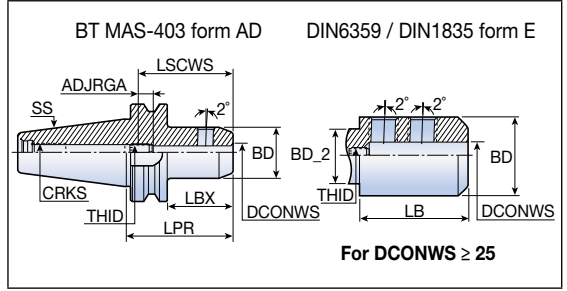
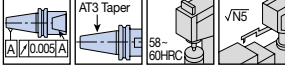

Designation	Dimension (mm)												
	SS	DCONWS	BD	BD_2	LPR	LBX	LB	ADJRGGA	LSCWS	CRKS	THID	Hex key	
BT40 EM 16x65E	40	16	48	-	65	38	-	10	57	M16	M12	6.0	
EM 20x75E	40	20	52	-	75	48	-	10	59	M16	M16	8.0	
EM 25x105E	40	25	65	61	105	78	68	10	64	M16	M20x1.5	10.0	
EM 32x110E	40	32	72	61	110	83	73	10	68	M16	M20x1.5	10.0	
BT50 EM 6x70E	50	6	25	-	70	32	-	10	45	M24	M5	2.5	
EM 10x70E	50	10	35	-	70	32	-	10	49	M24	M8	4.0	
EM 12x100E	50	12	42	-	100	62	-	10	54	M24	M10	5.0	
EM 14x100E	50	14	44	-	100	62	-	10	54	M24	M10	5.0	
EM 20x100E	50	20	52	-	100	62	-	10	59	M24	M16	8.0	
EM 25x115E	50	25	65	-	115	77	-	10	64	M24	M20x1.5	10.0	
EM 32x115E	50	32	72	-	115	77	-	10	68	M24	M20x1.5	10.0	
EM 40x115E	50	40	90	-	115	77	-	10	78	M24	M20x1.5	10.0	
EM 50x125E	50	50	98	-	125	67	-	10	88	M24	M20x1.5	10.0	

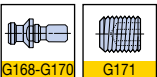

▶ Add B for coolant through flange

Thermal shrinking chucks

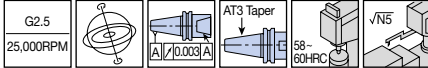
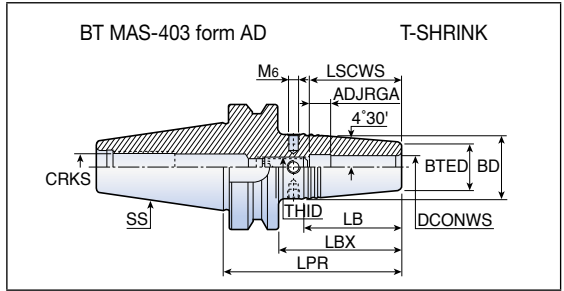

Designation	Dimension (mm)											
	SS	DCONWS	BTED	BD	LPR	LBX	LB	ADJRGA	LSCWS	CRKS	THID	Hex key
BT40 SRKIN 6x90	40	6	21	27	90	63	38.0	10	36	M16	M5	2.5
SRKIN 8x90	40	8	21	27	90	63	38.0	10	36	M16	M6	3.0
SRKIN 10x90	40	10	24	32	90	63	50.5	10	42	M16	M8	4.0
SRKIN 12x90	40	12	24	32	90	63	50.5	10	47	M16	M10	5.0
SRKIN 14x90	40	14	27	34	90	63	44.5	10	47	M16	M10	5.0
SRKIN 16x90	40	16	27	34	90	63	44.5	10	50	M16	M12	6.0
SRKIN 18x90	40	18	33	42	90	63	57.0	10	50	M16	M12	6.0
SRKIN 20x90	40	20	33	42	90	63	57.0	10	52	M16	M16	8.0
SRKIN 25x110	40	25	44	53	110	83	57.0	10	58	M16	M16	8.0
BT50 SRKIN 6x100⁽¹⁾	50	6	21	26	100	62	32.0	10	36	M24	M5	2.5
SRKIN 8x100⁽¹⁾	50	8	21	27	100	62	38.0	10	36	M24	M6	3.0
SRKIN 10x100⁽¹⁾	50	10	24	32	100	62	51.0	10	42	M24	M8	4.0
SRKIN 12x100⁽¹⁾	50	12	24	32	100	62	51.0	10	47	M24	M10	5.0
SRKIN 14x100⁽¹⁾	50	14	27	34	100	62	44.5	10	47	M24	M10	5.0
SRKIN 16x100⁽¹⁾	50	16	27	34	100	62	44.5	10	50	M24	M12	6.0
SRKIN 18x100⁽¹⁾	50	18	33	42	100	62	57.0	10	50	M24	M12	6.0
SRKIN 20x100⁽¹⁾	50	20	33	42	100	62	57.0	10	52	M24	M16	8.0
SRKIN 25x120⁽¹⁾	50	25	44	53	120	82	57.0	10	58	M24	M16	8.0
SRKIN 32x120⁽¹⁾	50	32	44	53	120	82	57.0	10	58	M24	M16	8.0

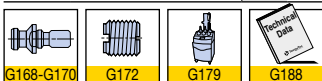

► ⁽¹⁾ Balance to G2.5 at 20,000RPM

BT-FC-SRKIN



Thermal shrinking chucks

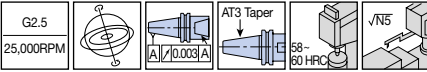
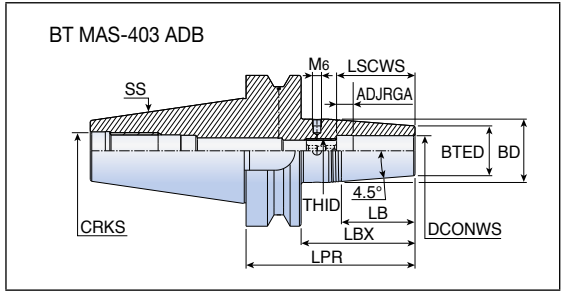

Designation	Dimension (mm)												
	SS	DCONWS	BTED	BD	LPR	LBX	LB	ADJRGA	LSCWS	THID	CRKS	Hex key	
BT40 FC SRKIN 6X90	40	6	21	27	90	64	38	11	36	M5	M16	2.5	
SRKIN 8X90	40	8	21	27	90	64	38	11	36	M6	M16	3.0	
SRKIN10X90	40	10	24	32	90	64	50.8	11	42	M8	M16	4.0	
SRKIN12X90	40	12	24	32	90	64	50.8	11	47	M10	M16	5.0	
SRKIN14X90	40	14	27	34	90	64	44.5	11	47	M10	M16	5.0	
SRKIN16X90	40	16	27	34	90	64	44.5	11	50	M12	M16	6.0	
SRKIN18X90	40	18	33	42	90	64	57.2	11	50	M12	M16	6.0	
SRKIN20X90	40	20	33	42	90	64	57.2	11	52	M16	M16	8.0	
SRKIN25X110	40	25	44	53	110	84	57.2	11	58	M16	M16	8.0	
BT50 FC SRKIN 6X100⁽¹⁾	50	6	21	27	100	63.5	38	11	36	M6	M24	2.5	
SRKIN 8X100⁽¹⁾	50	8	21	27	100	63.5	38	11	36	M5	M24	3.0	
SRKIN10X100⁽¹⁾	50	10	24	32	100	63.5	50.8	11	42	M8	M24	4.0	
SRKIN12X100⁽¹⁾	50	12	24	32	100	63.5	50.8	11	47	M10	M24	5.0	
SRKIN14X100⁽¹⁾	50	14	27	34	100	63.5	44.5	11	47	M10	M24	5.0	
SRKIN16X100⁽¹⁾	50	16	27	34	100	63.5	44.5	11	50	M12	M24	6.0	
SRKIN20X100⁽¹⁾	50	20	33	42	100	63.5	57.2	11	52	M16	M24	8.0	
SRKIN25X120⁽¹⁾	50	25	44	53	120	83.5	57.2	11	58	M16	M24	8.0	
SRKIN32X120⁽¹⁾	50	32	44	53	120	83.5	57.2	11.5	62	M16	M24	8.0	



► ⁽¹⁾ Balance to G2.5 at 20,000RPM

Thermal shrinking chucks

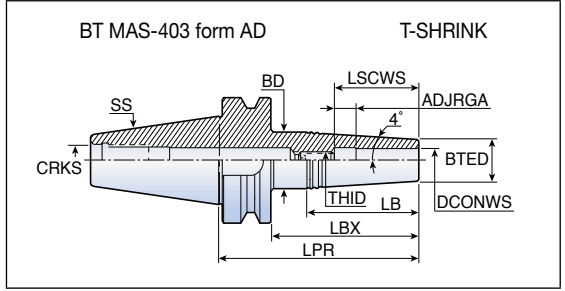

G2.5
25.000RPM

AT3 Taper
58-60HRC
 $\sqrt{R5}$

Designation	Dimension (mm)											
	SS	DCONWS	BD	BTED	LPR	LBX	LB	ADJRGA	LSCWS	CRKS	THID	Hex key
BT40 SRK 3x50	40	3	15.0	10	77	50	35.5	6	16	M16	M6	3.0
SRK 3x85	40	3	19.0	10	112	85	64.1	6	16	M16	M6	3.0
SRK 4x50	40	4	15.0	10	77	50	35.5	6	18	M16	M6	3.0
SRK 4x85	40	4	19.0	10	112	85	64.1	6	18	M16	M6	3.0
SRK 5x50	40	5	15.0	10	77	50	35.5	6	21	M16	M6	3.0
SRK 5x85	40	5	19.0	10	112	85	64.1	6	21	M16	M6	3.0
SRK 6x50	40	6	16.0	11	77	50	35.5	6	24	M16	M8	4.0
SRK 6x85	40	6	20.0	11	112	85	64.1	6	24	M16	M8	4.0
SRK 8x50	40	8	20.0	14	77	50	42.5	6	31	M16	M10	5.0
SRK 8x85	40	8	23.0	14	112	85	63.9	6	31	M16	M10	5.0
SRK 10x50	40	10	22.0	16	77	50	42.4	6	36	M16	M12	6.0
SRK 10x85	40	10	24.5	16	112	85	60.2	6	36	M16	M12	6.0
SRK 12x50	40	12	26.0	20	77	50	42.3	10	42	M16	M10	5.0
SRK 12x85	40	12	28.0	20	112	85	56.6	10	42	M16	M10	5.0

 **G168-G170**
 **G179**
 **G188**

BT-FC-SRK



Thermal shrinking chucks



BT MAS-403 ADB

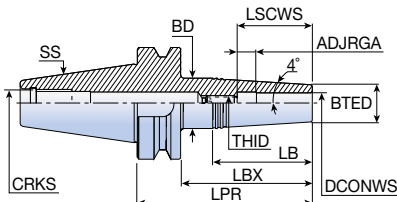

G2.5
20,000RPM

AF3 Taper

S8-80 HRC

√N5

Designation	Dimension (mm)											
	SS	DCONWS	BTED	BD	LPR	LBX	LB	ADJRGA	LSCWS	THID	CRKS	Hex key
BT30 FCSRK 3X50	30	3	9.93	15	72	50	36.3	0	10	M6	M12	3.0
SRK 4X50	30	4	9.93	15	72	50	36.3	0	12	M6	M12	3.0
SRK 6X50	30	6	10.88	16	72	50	36.6	0	18	M8	M12	4.0
SRK 8X50	30	8	13.95	20	72	50	43.3	0	25	M10	M12	5.0
SRK12X50	30	12	20.03	26	72	50	42.7	10	42	M10	M12	5.0

G168-G170

G179

G188

Hydraulic chucks

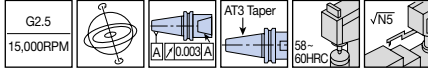
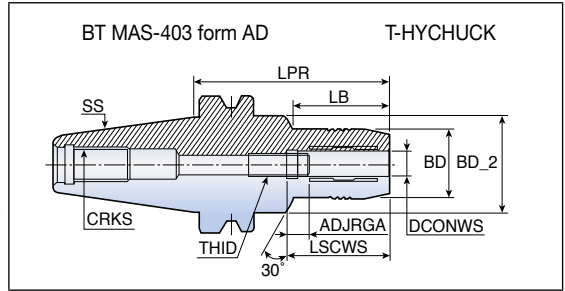

Designation	Dimension (mm)										
	SS	DCONWS	BD	BD_2	LPR	LB	ADJRGGA	LSCWS	THID	CRKS	
BT30 THC 6-70 ⁽¹⁾	30	6	28	45	70	28.0	10	37.5	M5	M12	
THC 8-70 ⁽¹⁾	30	8	30	45	70	28.0	10	37.5	M6	M12	
THC 10-75 ⁽¹⁾	30	10	32	45	75	38.0	10	42.5	M8x1	M12	
THC 12-85 ⁽¹⁾	30	12	34	45	85	44.0	10	47.5	M10x1	M12	
THC 14-85 ⁽¹⁾	30	14	36	45	85	44.0	10	47.5	M10x1	M12	
THC 16-90 ⁽¹⁾	30	16	38	45	90	46.0	10	52.5	M10x1	M12	
THC 20-85 ⁽¹⁾	30	20	43	63	85	38.0	10	52.5	M10x1	M12	
THC 20-90 ⁽¹⁾	30	20	43	-	90	68.0	10	52.5	M10x1	M12	
BT40 THC 6-65	40	6	28	50	65	23.0	10	37.5	M5	M16	
THC 6-95	40	6	28	50	65	43.0	10	37.5	M5	M16	
THC 8-95	40	8	30	50	95	44.0	10	37.5	M6	M16	
THC 10-95	40	10	32	50	95	44.0	10	42.5	M8x1	M16	
THC 12-95	40	12	34	50	95	44.0	10	47.5	M10x1	M16	
THC 14-95	40	14	36	50	95	44.0	10	47.5	M10x1	M16	
THC 16-95	40	16	38	50	95	46.0	10	52.5	M10x1	M16	
THC 16-140	40	16	38	50	140	47.5	10	52.5	M10x1	M16	
THC 20-95	40	20	43	50	95	48.0	10	52.5	M10x1	M16	
THC 25-100	40	25	57	-	100	73.0	10	61.0	M16x1	M16	
THC 25-135	40	25	57	-	135	108.0	10	61.0	M16x1	M16	
THC 32-105	40	32	63	-	105	78.0	10	61.0	M16x1	M16	

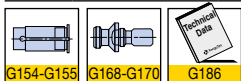

▶ ⁽¹⁾ Balance to G2.5 at 20,000RPM

BT-THC



Hydraulic chucks

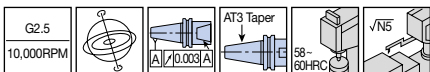
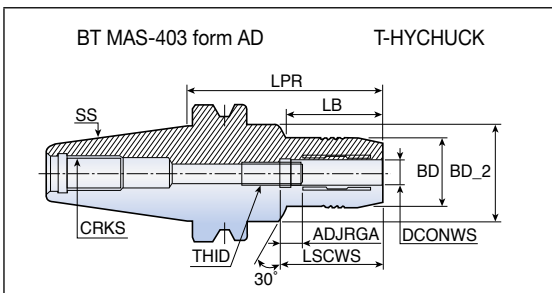

Designation	Dimension (mm)									
	SS	DCONWS	BD	BD_2	LPR	LB	ADJRGA	LSCWS	THID	CRKS
BT50 THC 6-90	50	6	28	50	90	32	10	37.5	M5	M24
THC 6-120	50	6	28	50	120	38	10	37.5	M5	M24
THC 10-90	50	10	32	50	90	32	10	42.5	M8x1	M24
THC 10-120	50	10	32	50	120	42	10	42.5	M8x1	M24
THC 12-90	50	12	34	50	90	32	10	47.5	M8x1	M24
THC 12-120	50	12	34	50	120	44	10	47.5	M8x1	M24
THC 14-90	50	14	36	50	90	32	10	47.5	M10x1	M24
THC 16-90	50	16	38	50	90	32	10	52.5	M10x1	M24
THC 20-90	50	20	43	50	90	32	10	52.5	M10x1	M24
THC 20-120	50	20	43	50	120	48	10	52.5	M10x1	M24
THC 20-140	50	20	43	50	140	48	10	52.5	M10x1	M24
THC 25-105	50	25	57	-	105	67	10	61.0	M16x1	M24
THC 25-150	50	25	57	-	150	112	10	61.0	M16x1	M24
THC 32-90	50	32	63	-	90	52	10	65.0	M16x1	M24
THC 32-115	50	32	63	-	115	77	10	65.0	M16x1	M24
THC 32-135	50	32	63	-	135	97	10	65.0	M16x1	M24
THC 32-150	50	32	63	-	150	112	10	65.0	M16x1	M24

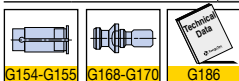

BT-SCA

Slotting cutter arbors

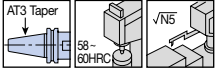
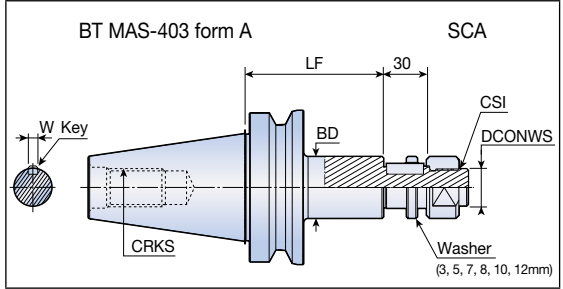

Designation	Dimension (mm)						
	SS	DCONWS	BD	LF	W	CRKS	CSI
BT40 - SCA-22(22.225)-75	40	22(22.225)	34	75	6(3.18)	M16	M20x1.5
SCA-22(22.225)-90	40	22(22.225)	34	90	6(3.18)	M24	M20x1.5
SCA-22-120	40	22	34	120	6(3.18)	M16	M20x1.5
SCA-27(25.4)-75	40	27(25.4)	40	75	7(6.35)	M16	M24x2.0
SCA-27-120	40	27	40	120	7(6.35)	M16	M24x2.0
SCA-32(31.75)-90	40	32(31.75)	46	90	8(7.92)	M16	M30x2.0
BT50 - SCA-22-135	50	22	34	135	6(3.18)	M24	M20x1.5
SCA-27(25.4)-90	50	27(25.4)	40	90	7(6.35)	M24	M24x2.0
SCA-27-135	50	27	40	135	7(6.35)	M24	M24x2.0
SCA-32(31.75)-90	50	32(31.75)	46	90	8(7.92)	M24	M32x2.0
SCA-40(38.1)-90	50	40(38.1)	55	90	10(9.52)	M24	M36x3.0
SCA-50-90	50	50	68	90	12	M24	M42x3.0



▶ Washers & key are included (Each 3, 5, 7, 8, 10, 12mm)

BT-SEM

Face mill arbors

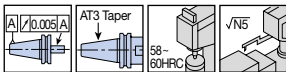
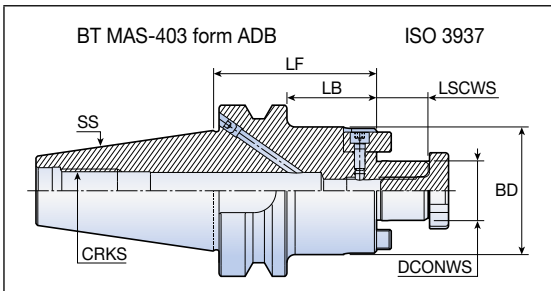

Designation	Dimension (mm)						
	SS	DCONWS	BD	LF	LB	LSCWS	CRKS
BT30 SEM 16x50	30	16	38	50	28	17	M12
SEM 22x50	30	22	47	50	28	19	M12
SEM 27x50	30	27	58	50	18	21	M12
BT40 SEM 16x60	40	16	38	60	33	17	M16
SEM 16x120	40	16	38	120	93	17	M16
SEM 22x60	40	22	47	60	33	19	M16
SEM 22x120	40	22	47	120	93	19	M16
SEM 27x45	40	27	58	45	18	21	M16
SEM 27x105	40	27	58	105	78	21	M16
SEM 32x60	40	32	65	60	23	24	M16
SEM 32x75	40	32	65	75	36	24	M16
SEM 40x60	40	40	82	60	23	27	M16
SEM 40x75	40	40	82	75	38	27	M16
BT50 SEM 16x75	50	16	38	75	37	17	M24
SEM 16x120	50	16	38	120	82	17	M24
SEM 22x50x220	50	22	50	220	182	19	M24
SEM 22x64x320	50	22	64	320	282	19	M24
SEM 22x75	50	22	47	75	37	19	M24
SEM 22x120	50	22	47	120	82	19	M24
SEM 27x60	50	27	58	60	22	21	M24
SEM 27x105	50	27	58	105	67	21	M24
SEM 32x48	50	32	66	48	10	24	M24
SEM 32x75	50	32	66	75	37	24	M24
SEM 40x48	50	40	82	48	10	27	M24
SEM 40x75	50	40	82	75	37	27	M24

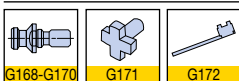

► Wrench not included

BT-SEM-C

Face mill arbors with internal coolant hole

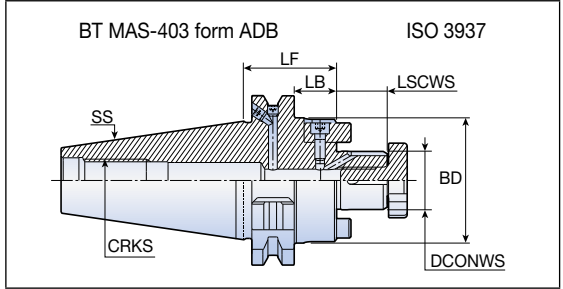
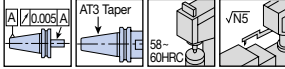

Designation	Dimension (mm)						
	SS	DCONWS	BD	LF	LB	LSCWS	CRKS
BT40 SEM 16x60C	40	16	38	60	33	17	M16
SEM 16x100C	40	16	38	100	73	17	M16
SEM 22x60C	40	22	47	60	33	19	M16
SEM 22x100C	40	22	47	100	73	19	M16
SEM 27x45C	40	27	58	45	18	21	M16
SEM 27x100C	40	27	58	100	73	21	M16
SEM 32x60C	40	32	66	60	33	24	M16
BT50 SEM 16x75C	50	16	38	75	37	17	M24
SEM 16x100C	50	16	38	100	62	17	M24
SEM 22x75C	50	22	47	75	37	19	M24
SEM 22x100C	50	22	47	100	62	19	M24
SEM 27x60C	50	27	58	60	22	21	M24
SEM 27x100C	50	27	58	100	62	21	M24
SEM 32x75C	50	32	66	75	37	24	M24
SEM 32x100C	50	32	66	100	62	24	M24
BT50 SEM 22x48x220C	50	22	48	220	182	19	M24
SEM 22x61x320C	50	22	61	320	282	19	M24
SEM 27x61x320C	50	27	61	320	282	21	M24
SEM 32x78x390C	50	32	78	390	352	24	M24



► If the “B type” option is required, the plug screw must be removed from the flange cooling hole (Use a 2mm hex key)
 ► Wrench not included

BT-FC-SEM-C

Face mill arbors with internal coolant hole

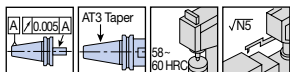
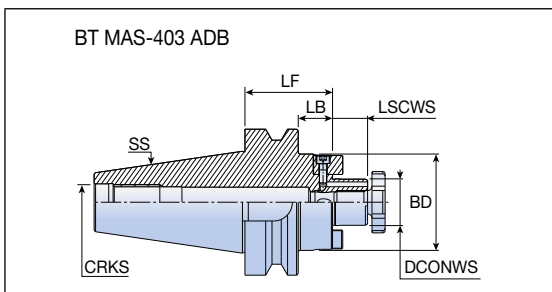

Designation	Dimension (mm)							
	SS	DCONWS	BD	LF	LB	LSCWS	CRKS	
BT30 FC SEM16X50C	30	16	38	50	28	17	M12	
	30	22	47	50	28	19	M12	
	30	27	58	50	28	21	M12	
BT40 FC	SEM16X60C	40	16	38	60	34	17	M16
	SEM22X60C	40	22	47	60	34	19	M16
	SEM22X120C	40	22	47	120	94	19	M16
	SEM27X45C	40	27	58	45	19	21	M16
	SEM32X60C	40	32	66	60	34	24	M16
	SEM32X78X60C	40	32	78	60	34	24	M16
	SEM16X75C	50	16	38	75	38.5	17	M24
BT50 FC	SEM16X120C	50	16	38	120	83.5	17	M24
	SEM22X75C	50	22	47	75	38.5	19	M24
	SEM22X120C	50	22	47	120	83.5	19	M24
	SEM27X60C	50	27	58	60	23.5	21	M24
	SEM27X105C	50	27	58	105	68.5	21	M24
	SEM32X60 C	50	32	66	60	23.5	24	M24
	SEM32X78X60C	50	32	78	60	23.5	24	M24
	SEM40X60 C	50	40	82	60	11.5	27	M24

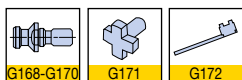

► Wrench not included

BT-FM

Face mill arbors

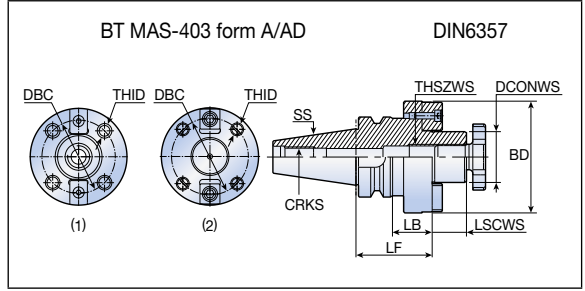
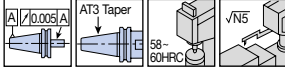

Designation	Dimension (mm)									
	SS	DCONWS	BD	DBC	LF	LB	LSCWS	CRKS	THID	THSZWS
BT40 FM 40⁽¹⁾	40	40	88	66.7	60	22	27	M16	M12	M20
BT50 FM 40⁽¹⁾	50	40	88	66.7	50	12	27	M24	M12	M20
FM 60⁽²⁾	50	60	128	101.6	88	40	38	M24	M16	-

Wrench not included
⁽¹⁾ Form AD
⁽²⁾ Form A

G168-G170
 G171
 G172

BT-FC-FM

Face mill arbors

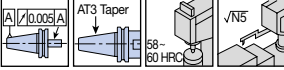
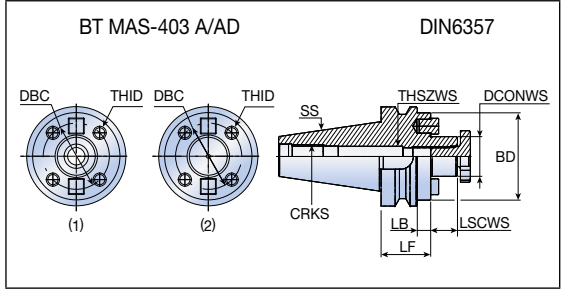

Designation	Dimension (mm)										
	SS	DCONWS	BD	DBC	LF	LB	LSCWS	CRKS	THID	THSZWS	
BT40 FC FM40⁽¹⁾	40	40	88	66.7	60	23	27	M16	M12	M20	
BT50 FC FM40⁽¹⁾	50	40	88	66.7	50	13.5	27	M24	M12	M20	
FC FM60⁽²⁾	50	60	128	101.6	88	41.5	40	M24	M16	-	

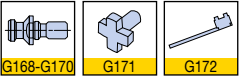

▶ Wrench not included
 ▶ ⁽¹⁾ Form AD
 ▶ ⁽²⁾ Form A

BT-SEMC

Combi shell end mill arbors

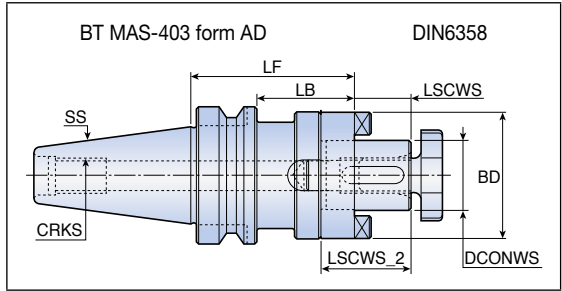
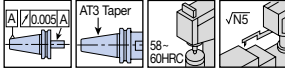

Designation	Dimension (mm)							
	SS	DCONWS	BD	LF	LB	LSCWS	LSCWS_2	CRKS
BT40 SEMC 16x50	40	16	32	50	23	17	27	M16
SEMC 16x100	40	16	32	100	73	17	27	M16
SEMC 22x53	40	22	40	53	26	19	31	M16
SEMC 22x100	40	22	40	100	73	19	31	M16
SEMC 27x55	40	27	48	55	28	21	33	M16
SEMC 27x100	40	27	48	98	73	21	33	M16
SEMC 32x60	40	32	58	60	33	24	38	M16
SEMC 32x100	40	32	58	100	73	24	38	M16
SEMC 40x80	40	40	70	80	53	27	41	M16
BT50 SEMC 16x100	50	16	32	100	62	17	27	M24
SEMC 16x150	50	16	32	150	112	17	27	M24
SEMC 22x68	50	22	40	68	30	19	31	M24
SEMC 22x100	50	22	40	100	62	19	31	M24
SEMC 22x150	50	22	40	150	112	19	31	M24
SEMC 27x78	50	27	48	78	40	21	33	M24
SEMC 27x100	50	27	48	100	62	21	33	M24
SEMC 27x150	50	27	48	150	112	21	33	M24
SEMC 32x78	50	32	58	78	40	24	38	M24
SEMC 32x100	50	32	58	100	62	24	38	M24
SEMC 32x150	50	32	58	150	112	24	38	M24
SEMC 40x78	50	40	70	78	40	27	41	M24
SEMC 40x100	50	40	70	100	62	27	41	M24
SEMC 40x150	50	40	70	150	112	27	41	M24
SEMC 50x79	50	50	90	79	41	30	46	M24
SEMC 50x150	50	50	90	150	112	30	46	M24

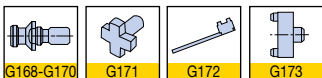

► Wrench not included

BT-FMA

Face mill arbors(Type inch)

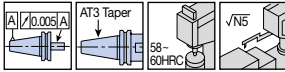
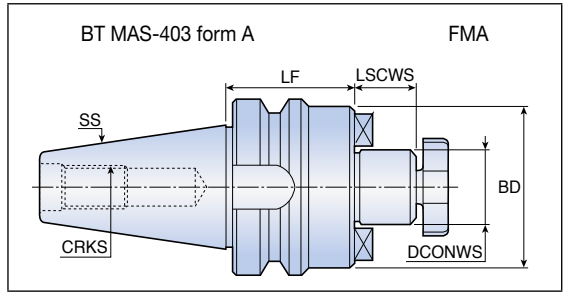

Designation	Dimension (mm)							Mounting screw
	SS	DCONWS	BD	LF	LSCWS	CRKS		
BT40 FMA 25.4-45L	40	25.4	50	45	22	M16	MBA M12	
FMA 25.4-90L	40	25.4	50	90	22	M16	MBA M12	
FMA 31.75-45L	40	31.75	60	45	30	M16	MBA M16	
FMA 31.75-75L	40	31.75	60	75	30	M16	MBA M16	
FMA 38.1-60L	40	38.1	78	60	34	M16	MBA M20	
BT50 FMA 25.4-45L	50	25.4	50	45	22	M24	MBA M12	
FMA 25.4-90L	50	25.4	50	90	22	M24	MBA M12	
FMA 25.4-150L	50	25.4	50	150	22	M24	MBA M12	
FMA 31.75-45L	50	31.75	60	45	30	M24	MBA M16	
FMA 31.75-75L	50	31.75	60	75	30	M24	MBA M16	
FMA 31.75-105L	50	31.75	60	105	30	M24	MBA M16	
FMA 38.1-45L	50	38.1	80	45	34	M24	MBA M20	
FMA 38.1-75L	50	38.1	80	75	34	M24	MBA M20	
FMA 50.8-45L	50	50.8	98	45	36	M24	MBA M24	
FMA 50.8-75L	50	50.8	98	75	36	M24	MBA M24	
FMA 47.625-75L	50	47.625	128	75	38	M24	SH M16x2x40	

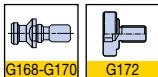

BT-MT

Morse taper adapters

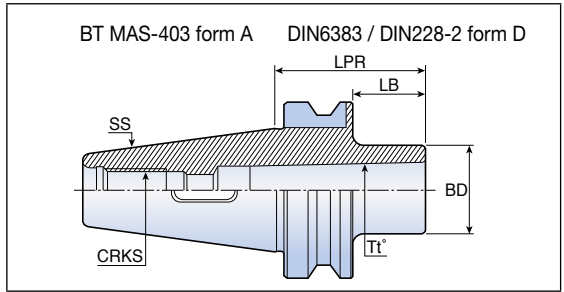
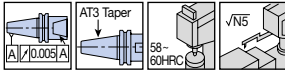

Designation	Dimension (mm)					
	SS	Tt°	BD	LPR	LB	CRKS
BT30 MT 1x45	30	MT1	25	45	23	M12
MT 2x60	30	MT2	32	60	38	M12
BT40 MT 1x45	40	MT1	25	45	25	M16
MT 1x120	40	MT1	25	120	25	M16
MT 2x60	40	MT2	32	60	32	M16
MT 2x120	40	MT2	32	120	32	M16
MT 3x75	40	MT3	40	75	40	M16
MT 3x139	40	MT3	40	139	40	M16
MT 4x95	40	MT4	50	95	50	M16
BT50 MT 1x45	50	MT1	25	45	7	M24
MT 1x120	50	MT1	25	120	82	M24
MT 2x45	50	MT2	32	45	7	M24
MT 2x135	50	MT2	32	135	97	M24
MT 2x180	50	MT2	32	180	142	M24
MT 3x45	50	MT3	40	45	7	M24
MT 3x150	50	MT3	40	150	112	M24
MT 3x180	50	MT3	40	180	142	M24
MT 4x75	50	MT4	50	75	37	M24
MT 4x180	50	MT4	50	180	142	M24
MT 5x105	50	MT5	70	105	67	M24



G168-G170

BT-MT-DRW

Morse taper adapters

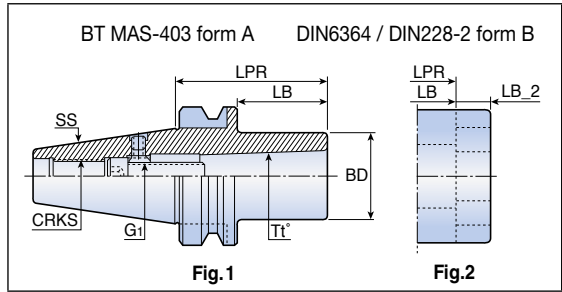
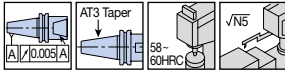

Designation	Dimension (mm)								Fig.
	SS	Tt°	BD	LPR	LB	LB_2	CRKS	G1	
BT40 MT1 DRW	40	MT1	25	50	23	-	M16	M6	1
MT2 DRW	40	MT2	32	50	23	-	M16	M10	1
MT3 DRW	40	MT3	40	70	43	-	M16	M12	1
MT4 DRW⁽¹⁾	40	MT4	63	95	68	15	M16	M16	2
BT50 MT1 DRW	50	MT1	25	45	7	-	M24	M6	1
MT2 DRW	50	MT2	32	60	22	-	M24	M10	1
MT3 DRW	50	MT3	40	65	27	-	M24	M12	1
MT4 DRW⁽¹⁾	50	MT4	63	70	32	15	M24	M16	2
MT5 DRW⁽¹⁾	50	MT5	78	100	62	18	M24	M20	2

▶ ⁽¹⁾ DIN2201

BT-AD

Adapters

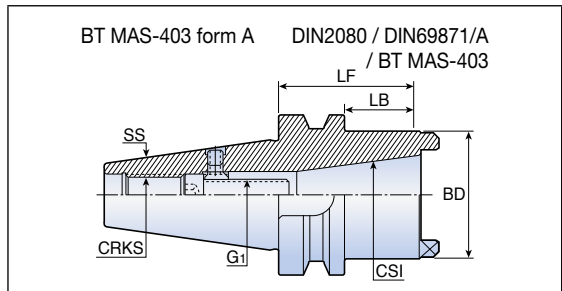
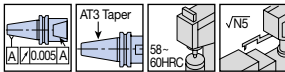

Designation	Dimension (mm)						
	SS	CSI	BD	LF	LB	CRKS	G1
BT50 AD 40	50	DIN 2080	63	75	32	M24	M16
AD BT/SK 40	50	DIN 69871/A, BT MAS	66	75	37	M24	M16



BT-DC

Drill chuck arbors - Jacobs taper arbors

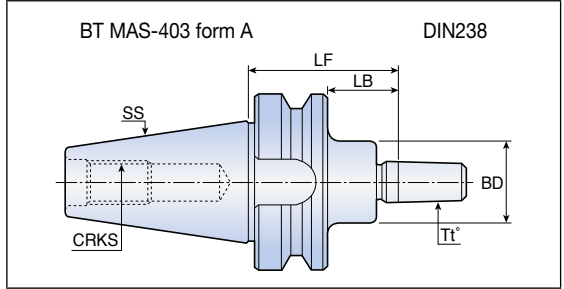
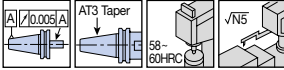

Designation	Dimension (mm)					
	SS	Tt°	BD	LF	LB	CRKS
BT30 DC B12x30	30	B12	-	30	8.0	M12
BT40 DC B12x45	40	B12	24	45	18.0	M16
DC B12x90	40	B12	24	90	63.0	M16
DC B16x45	40	B16	30	45	18.0	M16
DC B16x90	40	B16	30	90	63.0	M16
DC B18x90	40	B18	30	90	63.0	M16
BT50 DC B12x45	50	B12	-	45	6.7	M24
DC B16x45	50	B16	-	45	7.0	M24
DC B16x105	50	B16	50	105	67.0	M24
DC B18x45	50	B18	-	45	7.0	M24

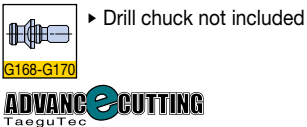

T-FLEXTEC holders

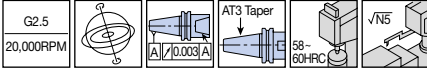
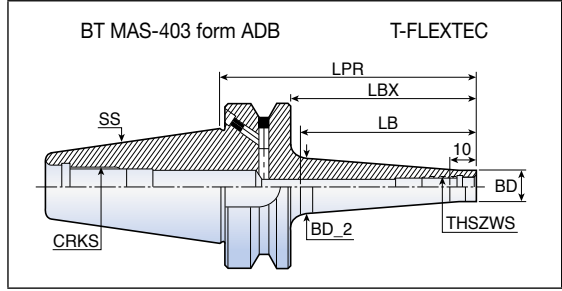

Designation	Dimension (mm)								
	SS	THSZWS	BD	BD_2	LPR	LBX	LB	CRKS	
BT40 ODP 6x66	40	M06	9.8	13.0	66	39	30	M16	
ODP 6x106	40	M06	9.8	23.0	106	79	70	M16	
ODP 8x66	40	M08	13.0	15.0	66	39	30	M16	
ODP 10x66	40	M10	18.0	20.0	66	39	30	M16	
ODP 10x106	40	M10	18.0	28.0	106	79	70	M16	
ODP 12x66	40	M12	21.0	24.0	66	39	30	M16	
ODP 12x106	40	M12	21.0	31.0	106	79	70	M16	
ODP 16x66	40	M16	29.0	28.6	66	39	35	M16	
ODP 16x106	40	M16	29.0	34.0	106	79	70	M16	
BT50 ODP 12x94⁽¹⁾	50	M12	23.0	30.0	94	56	50	M24	
ODP 12x144⁽¹⁾	50	M12	23.0	40.0	144	106	100	M24	
ODP 12x194⁽¹⁾	50	M12	23.0	40.0	194	156	150	M24	
ODP 16x94⁽¹⁾	50	M16	29.0	34.0	94	56	50	M24	
ODP 16x144⁽¹⁾	50	M16	29.0	40.0	144	106	100	M24	
ODP 16x194⁽¹⁾	50	M16	29.0	55.0	194	156	150	M24	
ODP 16x244⁽¹⁾	50	M16	29.0	55.0	244	206	200	M24	

▶ If the “B type” option is required, the plug screw must be removed from the flange cooling hole (Use a 2mm hex key)
 ▶ ⁽¹⁾ Balance to G6.3 at 12,000RPM

DIN2080



DIN2080

Standard toolholder

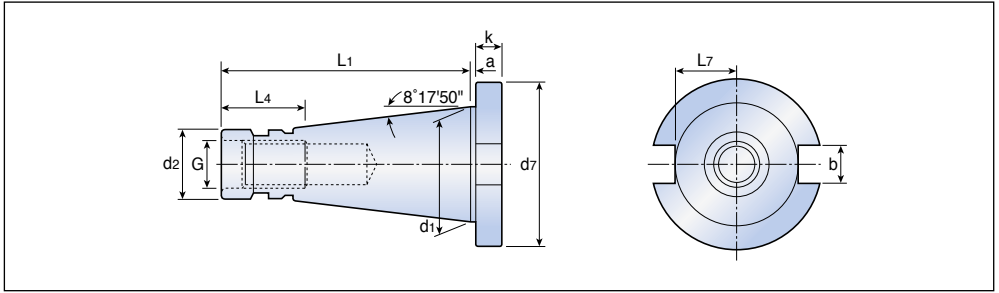

Shank	a ±0.2	b (H12)	d1	d2	G	d7	K ±0.15	L1	L4	L7max	Taper AT3
30	1.6	16.1	31.75	17.4	M12	50.0	8	68.4	24	16.2	0.002
40	1.6	16.1	44.45	25.3	M16	63.0	10	93.4	32	22.5	0.003
50	3.2	25.7	69.85	39.6	M24	97.5	12	126.8	47	35.3	0.004

► For non-stock items: Supply condition is subject to availability.
 If not available in stock then MOQ (Minimum order qty) will be applicable.

DIN2080-ER

ER collet chucks

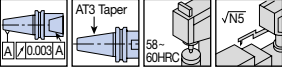
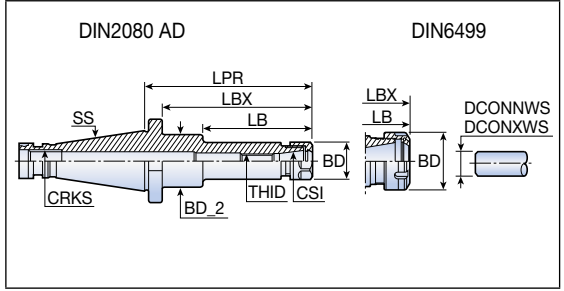

Designation	Dimension (mm)										
	SS	CSI	DCONNWS	DCONXWS	BD	BD_2	LPR	LBX	LB	CRKS	THID
DIN2080 30 ER 16x75	30	ER16	0.5	10.0	28	-	75	65.4	-	M12	M10
ER 32x55	30	ER32	2.0	20.0	50	-	55	45.4	-	M12	M18x1.5
ER 40x83	30	ER40	3.0	26.0	63	-	83	69.4	-	M12	M22x1.5
DIN2080 40 ER 16x63	40	ER16	0.5	10.0	28	-	63	51.4	-	M16	M12
ER 16x100	40	ER16	0.5	10.0	28	-	100	88.4	-	M16	M12
ER 20x100	40	ER20	1.0	13.0	34	-	100	88.4	-	M16	M12
ER 25x50	40	ER25	1.0	16.0	42	-	50	38.4	-	M16	M16x1.5
ER 32x50	40	ER32	2.0	20.0	50	-	50	38.4	-	M16	M22x1.5
ER 40x55	40	ER40	3.0	26.0	63	-	55	43.4	-	M16	M22x1.5
ER 50x80	40	ER50	10.0	34.0	78	-	80	68.4	-	M24	M22x1.5
DIN2080 50 ER 20x100	50	ER20	1.0	13.0	34	-	100	84.8	-	M24	M16
ER 20x160	50	ER20	1.0	13.0	34	-	160	144.8	-	M24	M12
ER 40x58	50	ER40	3.0	26.0	63	-	58	42.8	-	M24	M28x1.5
ER 50x63	50	ER50	10.0	34.0	78	-	63	47.8	-	M24	M36x1.5

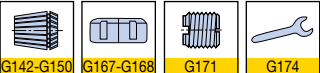

DIN2080-NTMC

Milling chucks

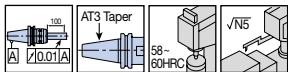
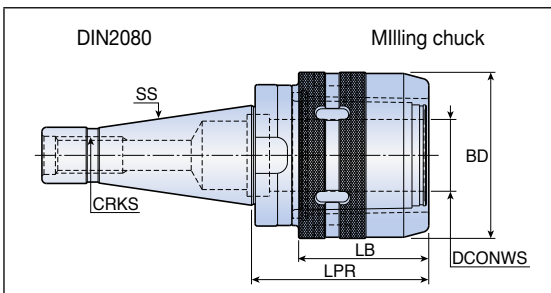

Designation	Dimension (mm)					
	SS	DCONWS	BD	LPR	LB	CRKS
DIN2080 40 NTMC 25-70	40	25	62	70	52.5	M16
NTMC 32-75	40	32	72	75	57.5	M16
DIN2080 50 NTMC 32-90	50	32	74	90	71.8	M24
NTMC 42-90	50	42	94	90	67	M24



DIN2080-EM

End mill holders

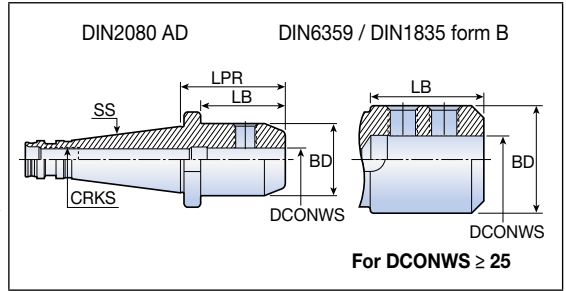
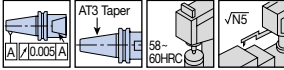

Designation	Dimension (mm)					
	SS	DCONWS	BD	LPR	LB	CRKS
DIN2080 30 EM 6x40	30	6	25	40	30.4	M12
EM 8x40	30	8	28	40	30.4	M12
EM 10x40	30	10	35	40	30.4	M12
DIN2080 40 EM 8x50	40	8	28	50	38.4	M16
EM 10x50	40	10	35	50	38.4	M16
EM 12x50	40	12	42	50	38.4	M16
EM 20x63	40	20	52	63	51.4	M16
EM 25x80	40	25	65	80	68.4	M16
EM 32x80	40	32	72	80	68.4	M16
DIN2080 50 EM 8x63	50	8	28	63	47.8	M24
EM 10x63	50	10	35	63	47.8	M24
EM 12x63	50	12	42	63	47.8	M24
EM 16x63	50	16	48	63	47.8	M24
EM 20x63	50	20	52	63	47.8	M24
EM 25x80	50	25	65	80	64.8	M24
EM 32x80	50	32	72	80	64.8	M24
EM 40x90	50	40	90	90	74.8	M24
EM 50x100	50	50	100	100	84.8	M24



DIN2080-FM

Face mill arbors

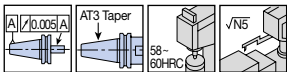
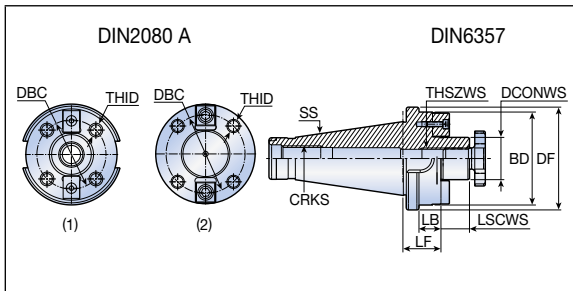

Designation	Dimension (mm)										
	SS	DCONWS	DF	BD	DBC	LF	LB	LSCWS	CRKS	THSZWS	THID
DIN2080 50 FM40 ⁽¹⁾	50	40	97.3	88	66.7	36.0	20.8	27	M24	M20	M12
FM60 ⁽²⁾	50	60	128.0	-	101.6	35.8	-	40	M24	-	M16

-  G171
-  G172
- ▶ Wrench not included
- ▶ ⁽¹⁾ Form AD
- ▶ ⁽²⁾ Form A

DIN2080-SEM

Shell end mill arbors

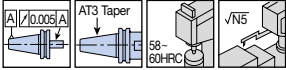
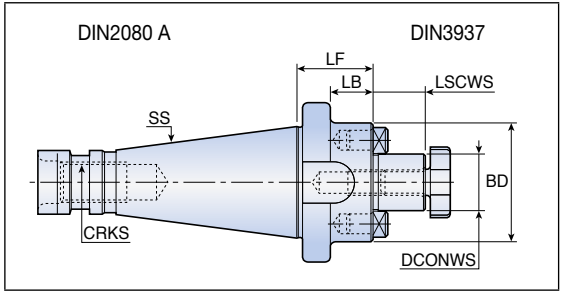

Designation	Dimension (mm)						
	SS	DCONWS	BD	LF	LB	LSCWS	CRKS
DIN2080 30 SEM 22x28	30	22	47	28	18.4	19	M12
DIN2080 40 SEM 16x28	40	16	38	28	16.4	17	M16
SEM 22x27	40	22	47	27	15.4	19	M16
SEM 27x26	40	27	58	26	14.4	21	M16
SEM 32x23	40	32	66	23	11.4	24	M16
SEM 40x34	40	40	82	34	22.4	27	M16
DIN2080 50 SEM 16x38	50	16	38	38	22.8	17	M24
SEM 22x38	50	22	47	38	22.8	19	M24
SEM 27x38	50	27	58	38	22.8	21	M24
SEM 32x36	50	32	66	36	20.8	24	M24
SEM 40x40	50	40	82	40	24.8	27	M24

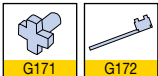

► Wrench not included

DIN2080-SEMC

Combi shell end mill arbors

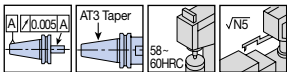
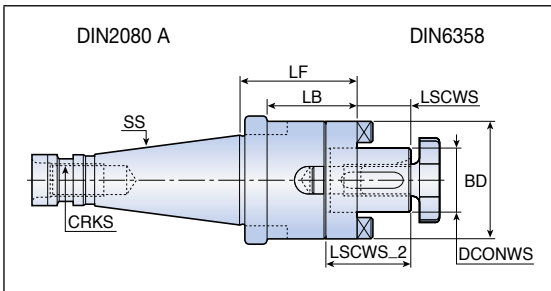

Designation	Dimension (mm)							
	SS	DCONWS	BD	LF	LB	LSCWS	LSCWS_2	CRKS
DIN2080 30 SEMC 16x35	30	16	32	35	25.4	17	27	M12
SEMC 22x35	30	22	40	35	25.4	19	31	M12
DIN2080 40 SEMC 22x52	40	22	40	52	40.4	19	31	M16
SEMC 27x52	40	27	48	52	40.4	21	33	M16
SEMC 32x52	40	32	58	52	40.4	24	38	M16
SEMC 40x52	40	40	70	52	40.4	27	41	M16
DIN2080 50 SEMC 16x55	50	16	32	55	39.8	17	27	M24
SEMC 22x55	50	22	40	55	39.8	19	31	M24
SEMC 27x55	50	27	48	55	39.8	21	33	M24
SEMC 32x55	50	32	58	55	39.8	24	38	M24
SEMC 50x55	50	50	90	55	39.8	30	46	M24



► Wrench not included

DIN2080-MT

Morse taper adapters

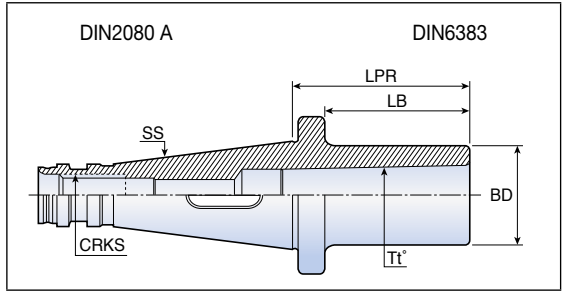
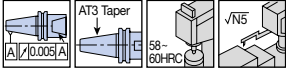

Designation	Dimension (mm)					
	SS	Tt°	BD	LPR	LB	CRKS
DIN2080 40 MT 1x50	40	MT1	25	50	38.4	M16
MT 2x50	40	MT2	32	50	38.4	M16
MT 3x65	40	MT3	40	65	53.4	M16
MT 4x95	40	MT4	48	95	83.4	M16
DIN2080 50 MT 1x45	50	MT1	25	45	29.8	M24
MT 2x60	50	MT2	32	60	44.8	M24
MT 3x65	50	MT3	40	65	49.8	M24
MT 4x70	50	MT4	48	70	54.8	M24
MT 5x105	50	MT5	63	105	89.2	M24

DIN2080-MT-DRW

Morse taper draw bar adapters

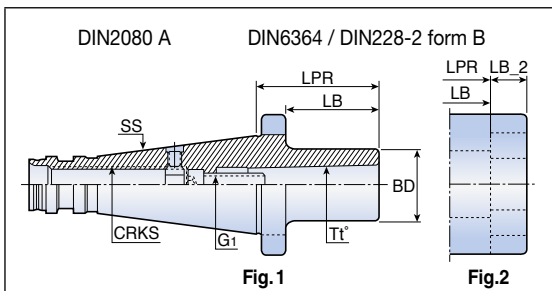
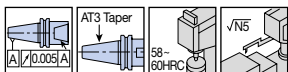

Designation	Dimension (mm)									Fig.
	SS	Tt°	BD	LPR	LB	LB_2	G1	CRKS		
DIN2080 40 MT1 DRW	40	MT1	25	50	38.4	-	M6	M16	1	
MT2 DRW	40	MT2	32	50	38.4	-	M10	M16	1	
MT3 DRW	40	MT3	40	65	53.4	-	M12	M16	1	
MT4 DRW	40	MT4	63	110	-	15	M16	M16	2	
DIN2080 50 MT1 DRW	50	MT1	25	60	44.8	-	M6	M24	1	
MT2 DRW	50	MT2	32	60	44.8	-	M10	M24	1	
MT3 DRW	50	MT3	40	65	49.8	-	M12	M24	1	
MT4 DRW	50	MT4	63	80	49.8	15	M16	M24	2	
MT5 DRW	50	MT5	78	100	84.4	18	M20	M24	2	

► MT4 & MT5: DIN2201

DIN2080-DC

Drill chuck arbors - Jacobs taper arbors

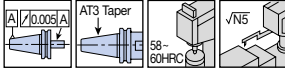
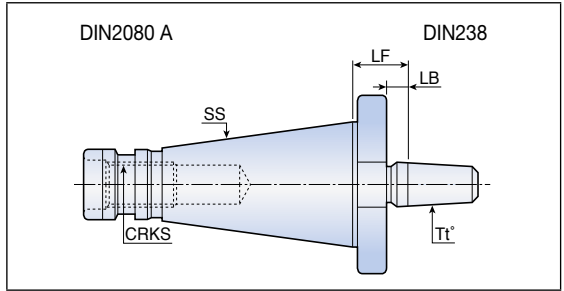

Designation	Dimension (mm)				
	SS	Tt°	LF	LB	CRKS
DIN2080 40 DC B16x22	40	B16	22	10.4	M16

► Drill chuck not included

DIN2080-CP

Centering plug

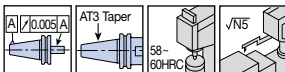
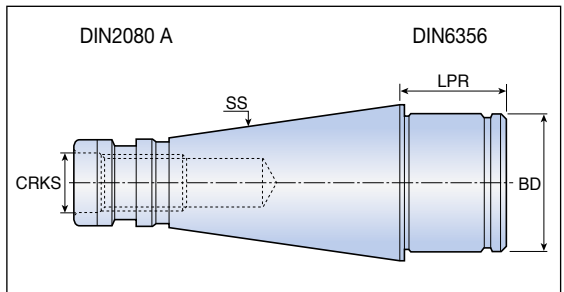

Designation	Dimension (mm)			
	SS	BD	LPR	CRKS
DIN2080 50 CP 60	50	60	39	M24

CADAPTER



C-ADAPTER ISO 26623-1

Standard toolholder

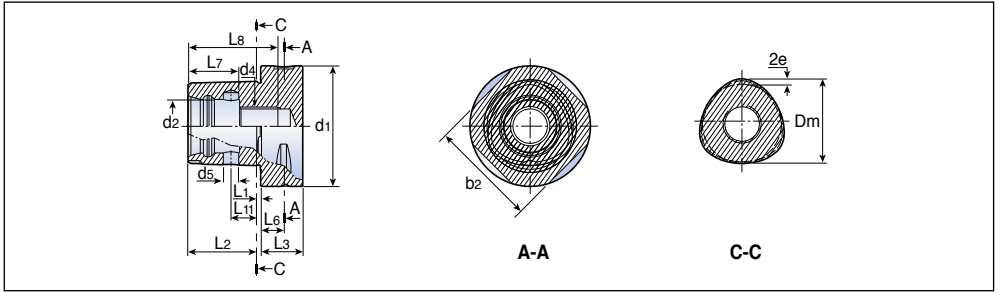

C-ADAPTER	b2	d1 ±0.1	d2	d4	d5 ±0.1	Dm	e
C3	28.3	32	15	M12x1.5	3.6	22	0.70
C4	35.3	40	18	M14x1.5	4.6	28	0.90
C5	44.4	50	21	M16x1.5	6.1	35	1.12
C6	55.8	63	28	M20x2	8.1	44	1.40
C8	71.1	80	32	M20x2	9.1	55	2.00

C-ADAPTER	L1	L2 ±0.1	L3min	L6 ±0.15	L7 ±0.15	L8min	L11 ±0.1
C3	2.5	19	15	6	13	25	8.0
C4	2.5	24	20	8	15	30	11.5
C5	3.0	30	20	10	20	37	14.0
C6	3.0	38	22	12	27	47	15.5
C8	3.0	48	30	12	28	48	25.0

► For non-stock items: Supply condition is subject to availability.
 If not available in stock then MOQ (Minimum order qty) will be applicable.

C-ER

ER collet chucks

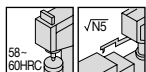
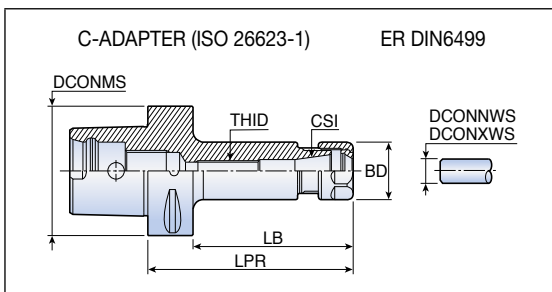

Designation	Dimension (mm)							
	DCONMS	CSI	DCONNWS	DCONXWS	BD	LPR	LB	THID
C4 ER 16x70	40	ER16	1.0	10.0	28	70	50	M10
ER 20x35⁽¹⁾	40	ER20	1.0	13.0	34	35	27	-
ER 20x52	40	ER20	1.0	13.0	34	52	32	-
ER 25x38⁽¹⁾	40	ER25	1.0	16.0	42	38	30	-
ER 25x52	40	ER25	1.0	16.0	42	52	32	-
ER 32x54	40	ER32	2.0	20.0	50	54	34	-
C5 ER 16x100	50	ER16	1.0	10.0	28	100	80	M10
ER 16x130	50	ER16	1.0	10.0	28	130	110	M10
ER 20x055	50	ER20	1.0	13.0	34	55	35	-
ER 20x100	50	ER20	1.0	13.0	34	100	80	M12
ER 20x130	50	ER20	1.0	13.0	34	130	110	M12
ER 25x055	50	ER25	1.0	16.0	42	55	35	-
ER 25x100	50	ER25	1.0	16.0	42	100	80	M16
ER 32x057	50	ER32	2.0	20.0	50	57	36	-
ER 32x100	50	ER32	2.0	20.0	50	100	80	M22x1.5
C6 ER 16x100	63	ER16	1.0	10.0	28	100	78	M10
ER 16x130	63	ER16	1.0	10.0	28	130	108	M10
ER 16x160	63	ER16	1.0	10.0	28	160	138	M10
ER 20x060	63	ER20	1.0	13.0	34	60	38	-
ER 20x100	63	ER20	1.0	13.0	34	100	78	M12
ER 20x130	63	ER20	1.0	13.0	34	130	108	M12
ER 20x160	63	ER20	1.0	13.0	34	160	138	M12
ER 25x060	63	ER25	1.0	16.0	42	60	38	-
ER 25x100	63	ER25	1.0	16.0	42	100	78	M16
ER 25x130	63	ER25	1.0	16.0	42	130	108	M16
ER 25x160	63	ER25	1.0	16.0	42	160	138	M16
ER 32x060	63	ER32	2.0	20.0	50	60	36	-
ER 32x100	63	ER32	2.0	20.0	50	100	78	M22x1.5
ER 32x130	63	ER32	2.0	20.0	50	130	108	M22x1.5
ER 32x160	63	ER32	2.0	20.0	50	160	138	M22x1.5
ER 40x065	63	ER40	3.0	26.0	63	65	37	-
ER 40x100	63	ER40	3.0	26.0	63	100	78	M28x1.5
ER 40x130	63	ER40	3.0	26.0	63	130	108	M28x1.5

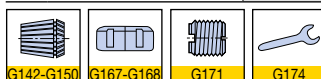

► ⁽¹⁾ Without V grooves, for manual use only

C-ER

ER collet chucks

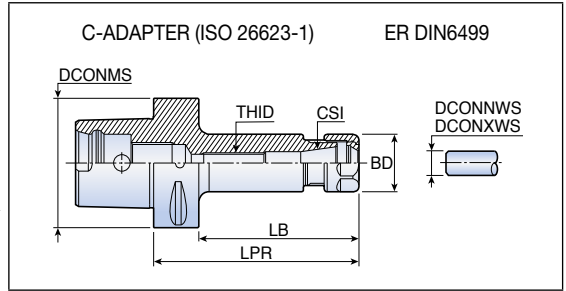
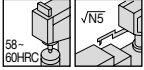

Designation	Dimension (mm)							
	DCONMS	CSI	DCONNWS	DCONXWS	BD	LPR	LB	THID
C8 ER 32x70	80	ER32	2.0	20.0	50	70	40	-
ER 32x100	80	ER32	2.0	20.0	50	100	70	M22x1.5
ER 32x160	80	ER32	2.0	20.0	50	160	130	M22x1.5
ER 40x70	80	ER40	3.0	26.0	63	70	40	-
ER 40x100	80	ER40	3.0	26.0	63	100	70	M28x1.5
ER 40x160	80	ER40	3.0	26.0	63	160	130	M28x1.5

C-ER-M

ER mini collet chucks

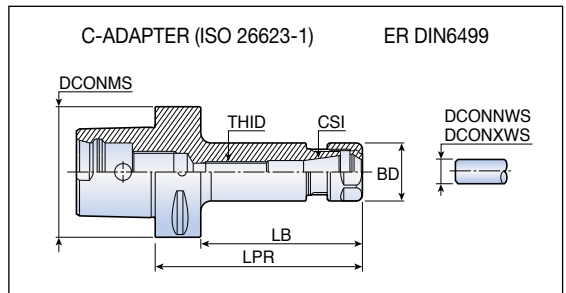
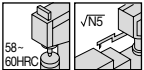

Designation	Dimension (mm)							
	DCONMS	CSI	DCONNWS	DCONXWS	BD	LPR	LB	THID
C4 ER 16x70 M	40	ER16	0.5	10.0	22	70	50	M10
C5 ER 16x100 M	50	ER16	0.5	10.0	22	100	80	M10
ER 16x130 M	50	ER16	0.5	10.0	22	130	120	M10
C6 ER 16x100 M	63	ER16	0.5	10.0	22	100	78	M10
ER 16x130 M	63	ER16	0.5	10.0	22	130	108	M10
ER 16x160 M	63	ER16	0.5	10.0	22	160	138	M10

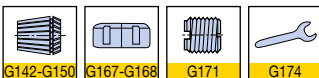

C-EM

End mill holders

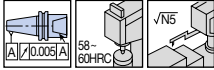
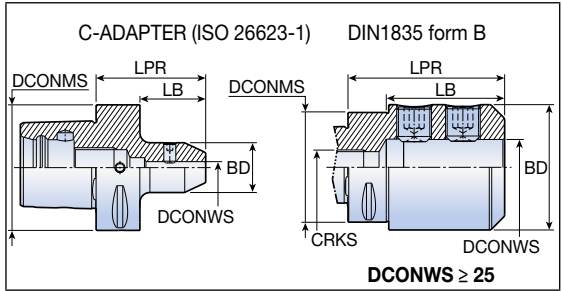

Designation	Dimension (mm)					
	DCONMS	DCONWS	BD	LPR	LB	CRKS
C4 EM 6x50	40	6	25	50	30	M14
EM 8x50	40	8	28	50	30	M14
EM 10x50	40	10	35	50	30	M14
EM 12x55	40	12	42	55	35	M14
EM 14x55	40	14	44	55	35	M14
EM 16x60	40	16	48	60	40	M14
C5 EM 6x50	50	6	25	50	30	M16
EM 8x50	50	8	28	50	30	M16
EM 10x55	50	10	35	55	35	M16
EM 12x60	50	12	42	60	40	M16
EM 14x60	50	14	44	60	40	M16
EM 16x60	50	16	48	60	40	M16
EM 18x60	50	18	50	60	40	M16
EM 20x60	50	20	52	60	40	M16
EM 25x85	50	25	65	85	65	M16
C6 EM 6x55	63	6	25	55	33	M20
EM 8x55	63	8	28	55	33	M20
EM 10x60	63	10	35	60	38	M20
EM 12x60	63	12	42	60	38	M20
EM 14x60	63	14	44	60	38	M20
EM 16x65	63	16	48	65	43	M20
EM 18x65	63	18	50	65	43	M20
EM 20x65	63	20	52	65	43	M20
EM 25x80	63	25	65	80	58	M20
EM 32x90	63	32	72	90	68	M20
EM 40x100	63	40	90	100	78	M20



C-EM

End mill holders

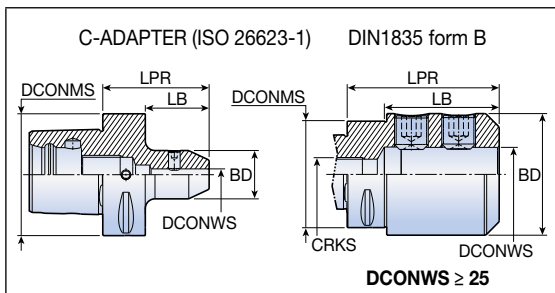
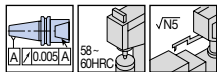

Designation	Dimension (mm)					
	DCONMS	DCONWS	BD	LPR	LB	CRKS
C8 EM 6x70	80	6	25	70	40	M20
EM 8x70	80	8	28	70	40	M20
EM 10x70	80	10	35	70	40	M20
EM 12x70	80	12	42	70	40	M20
EM 14x70	80	14	44	70	40	M20
EM 16x70	80	16	48	70	40	M20
EM 18x70	80	18	50	70	40	M20
EM 20x70	80	20	52	70	40	M20
EM 25x90	80	25	65	90	60	M20
EM 32x95	80	32	72	95	65	M20
EM 40x110	80	40	90	110	80	M20
EM 50x120	80	50	98	120	90	M20



C-EM-E

End mill holders - Whistle notch type

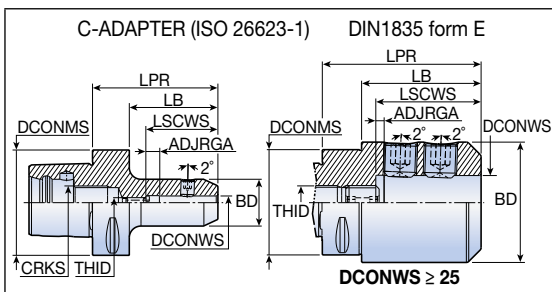
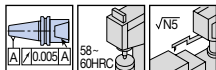

Designation	Dimension (mm)								
	DCONMS	DCONWS	BD	LPR	LB	ADJRGA	LSCWS	CRKS	THID
C4 EM 6x70 E	40	6	25	70	50	5	35	M14	M5
EM 8x70 E	40	8	28	70	50	8	43	M14	M6
EM 12x75 E	40	12	42	75	55	5	49	M14	M10
EM 14x75 E	40	14	44	75	55	5	49	M14	M10
C5 EM 10x70 E	50	10	35	70	50	6	45	M16	M8
EM 12x75 E	50	12	42	75	55	5	49	M16	M10
EM 14x75 E	50	14	44	75	55	5	49	M16	M10
EM 16x80 E	50	16	48	80	60	5	52	M16	M12
EM 18x80 E	50	18	50	80	60	5	52	M16	M12
EM 20x85 E	50	20	52	85	65	6	55	M16	M16
C6 EM 6x75 E	63	6	25	75	53	6	36	M20	M5
EM 8x75 E	63	8	28	75	53	8	43	M20	M6
EM 10x75 E	63	10	35	75	53	7	46	M20	M8
EM 12x80 E	63	12	42	80	58	5	49	M20	M10
EM 14x80 E	63	14	44	80	58	5	49	M20	M10
EM 16x85 E	63	16	48	85	63	5	52	M20	M12
EM 18x85 E	63	18	50	85	63	5	52	M20	M12
EM 20x85 E	63	20	52	85	63	6	55	M20	M16
EM 25x90 E	63	25	65	90	68	6	60	M20	M20
EM 32x95 E	63	32	72	95	73	5	63	M20	M20
C8 EM 8x65 E	80	8	28	65	35	8	43	M20	M6
EM 10x65 E	80	10	35	65	35	7	46	M20	M8
EM 12x70 E	80	12	42	70	40	5	49	M20	M10
EM 14x70 E	80	14	44	70	40	5	49	M20	M10
EM 16x75 E	80	16	48	75	45	5	52	M20	M12
EM 18x75 E	80	18	50	75	45	5	52	M20	M12
EM 20x80 E	80	20	52	80	50	8	57	M20	M16
EM 25x90 E	80	25	65	90	60	6	60	M20	M20
EM 32x95 E	80	32	72	95	65	6	64	M20	M20



G171

C-SEM-C

Face mill arbors

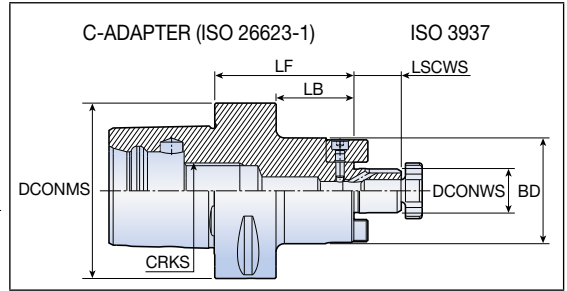
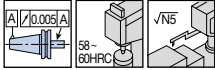

Designation	Dimension (mm)						
	DCONMS	DCONWS	BD	LF	LB	LSCWS	CRKS
C4 SEM 16x32 C	40	16	38	32	12	17	M14
SEM 16x55 C	40	16	38	55	35	17	M14
SEM 22x40 C	40	22	47	40	20	19	M14
SEM 22x55 C	40	22	47	55	35	19	M14
C5 SEM 16x35 C	50	16	38	35	15	17	M16
SEM 16x70 C	50	16	38	70	50	17	M16
SEM 22x35 C	50	22	47	35	15	19	M16
SEM 22x70 C	50	22	47	70	50	19	M16
SEM 27x40 C	50	27	58	40	20	21	M16
SEM 32x40 C	50	32	63	40	20	24	M16
C6 SEM 16x50 C	63	16	38	50	28	17	M20
SEM 16x100 C	63	16	38	100	78	17	M20
SEM 22x50 C	63	22	47	50	28	19	M20
SEM 22x100 C	63	22	47	100	78	19	M20
SEM 27x60 C	63	27	58	60	38	21	M20
SEM 27x100 C	63	27	58	100	78	21	M20
SEM 32x60 C	63	32	66	60	38	24	M20
SEM 40x60 C	63	40	82	60	38	27	M20
C8 SEM 16x50 C	80	16	38	50	20	17	M20
SEM 16x100 C	80	16	38	100	70	17	M20
SEM 22x50 C	80	22	47	50	20	19	M20
SEM 22x100 C	80	22	47	100	70	19	M20
SEM 27x50 C	80	27	58	50	20	21	M20
SEM 27x100 C	80	27	58	100	70	21	M20
SEM 32x50 C	80	32	66	50	20	24	M20
SEM 32x100 C	80	32	66	100	70	24	M20
SEM 40x60 C	80	40	82	60	30	27	M20

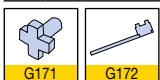

C-SEMC

Combi shell mill arbors

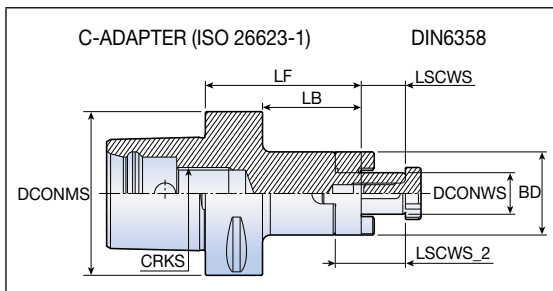
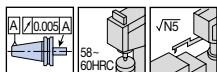

Designation	Dimension (mm)							
	DCONMS	DCONWS	BD	LF	LB	LSCWS	LSCWS_2	CRKS
C4 SEMC 16x45	40	16	32	45	25	17	27	M14
SEMC 22x45	40	22	40	45	25	19	31	M14
SEMC 27x50	40	27	48	50	30	21	33	M14
C5 SEMC 16x55	50	16	32	55	35	17	27	M16
SEMC 22x65	50	22	40	65	45	19	31	M16
SEMC 27x85	50	27	48	85	65	21	33	M16
C6 SEMC 16x60	63	16	32	60	38	17	27	M20
SEMC 16x100	63	16	32	100	78	17	27	M20
SEMC 22x60	63	22	40	60	38	19	31	M20
SEMC 22x100	63	22	40	100	78	19	31	M20
SEMC 27x60	63	27	48	60	38	21	33	M20
SEMC 27x100	63	27	48	100	78	21	33	M20
SEMC 32x60	63	32	58	60	38	24	38	M20
SEMC 40x70	63	40	70	70	48	27	41	M20



C-FM

Face mill arbors

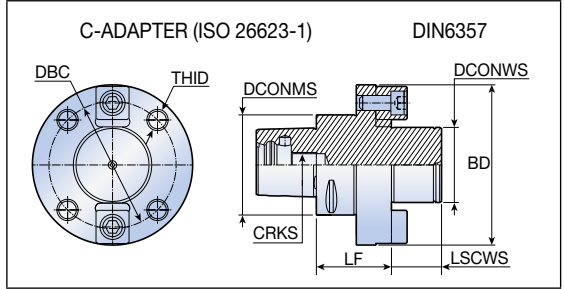
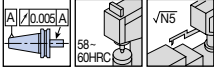

Designation	Dimension (mm)							
	DCONMS	DCONWS	BD	DBC	LF	LSCWS	CRKS	THID
C8 FM 60x60	80	60	128	101.6	20	40	M20	M16



Thermal shrinking chucks

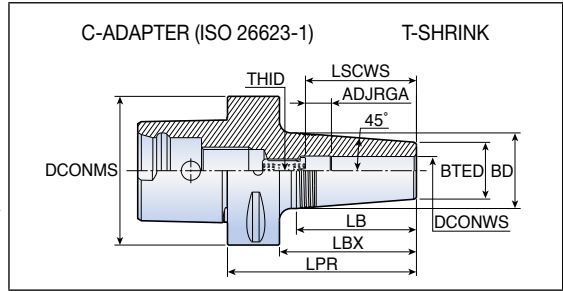

Designation	Dimension (mm)										
	DCONMS	DCONWS	BTED	BD	LPR	LBX	LB	ADJRGA	LSCWS	THID	Hex key
C4 SRKIN 6x75	40	6	21	27	75	55	38.1	11	36	M5	2.5
SRKIN 8x75	40	8	21	27	75	55	38.1	11	36	M6	3.0
SRKIN 10x75	40	10	24	32	75	55	50.8	11	42	M8	4.0
SRKIN 12x75	40	12	24	32	75	55	50.8	11	47	M10	5.0
SRKIN 14x80	40	14	27	34	80	60	44.5	11	47	M10	5.0
SRKIN 16x80	40	16	27	34	80	60	44.5	11	50	M12	6.0
SRKIN 18x80	40	18	33	42	80	60	57.2	11	50	M12	6.0
SRKIN 20x85	40	20	33	42	85	65	57.2	11	52	M16	8.0
C5 SRKIN 6x75	50	6	21	27	75	55	38.1	11	36	M5	2.5
SRKIN 8x75	50	8	21	27	75	55	38.1	11	36	M6	3.0
SRKIN 10x75	50	10	24	32	75	55	50.8	11	42	M8	4.0
SRKIN 12x75	50	12	24	32	75	55	50.8	11	47	M10	5.0
SRKIN 14x80	50	14	27	34	80	60	44.5	11	47	M10	5.0
SRKIN 16x80	50	16	27	34	80	60	44.5	11	50	M12	6.0
SRKIN 18x80	50	18	33	42	80	60	57.2	11	50	M12	6.0
SRKIN 20x85	50	20	33	42	85	65	57.2	11	52	M16	8.0
SRKIN 25x90	50	25	44	53	90	70	57.2	11	58	M16	8.0
C6 SRKIN 6x80	63	6	21	27	80	58	38.1	11	36	M5	2.5
SRKIN 8x80	63	8	21	27	80	58	38.1	11	36	M6	3.0
SRKIN 10x80	63	10	24	32	80	58	50.8	11	42	M8	4.0
SRKIN 12x80	63	12	24	32	80	58	50.8	11	47	M10	5.0
SRKIN 14x85	63	14	27	34	85	63	44.5	11	47	M10	5.0
SRKIN 16x85	63	16	27	34	85	63	44.5	11	50	M12	6.0
SRKIN 18x85	63	18	33	42	85	63	57.2	11	50	M12	6.0
SRKIN 20x85	63	20	33	42	85	63	57.2	11	52	M16	8.0
SRKIN 25x90	63	25	44	53	90	68	57.2	11	58	M16	8.0
SRKIN 32x95	63	32	44	53	95	73	57.2	11	58	M16	8.0



T-FLEXTEC holders

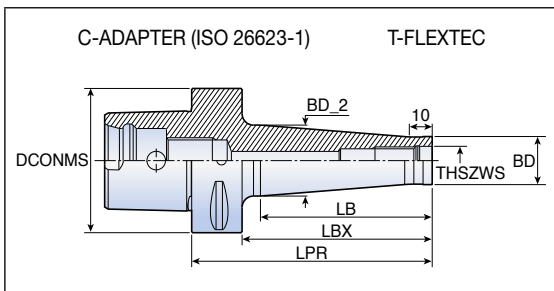
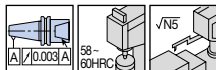

Designation	Dimension (mm)						
	DCONMS	THSZWS	BD	BD_2	LPR	LBX	LB
C4 ODP 10x53	40	M10	18	23.0	53	33	23
ODP 12x53	40	M12	21	26.0	53	33	23
ODP 16x53	40	M16	29	34.0	53	33	23
C5 ODP 10x53	50	M10	18	19.5	53	33	25
ODP 12x53	50	M12	21	23.5	53	33	25
ODP 12x103	50	M12	21	31.0	103	83	75
ODP 16x53	50	M16	29	29.5	53	33	25
ODP 16x103	50	M16	29	36.0	103	83	75
C6 ODP 10x55	63	M10	18	19.5	55	33	25
ODP 10x105	63	M10	18	28.0	105	83	75
ODP 10x130	63	M10	18	32.0	130	108	100
ODP 12x55	63	M12	21	23.5	55	33	25
ODP 12x105	63	M12	21	31.0	105	83	75
ODP 12x130	63	M12	21	36.0	130	108	100
ODP 16x55	63	M16	29	34.0	55	33	25
ODP 16x105	63	M16	29	34.0	105	83	75
ODP 16x130	63	M16	29	41.0	130	108	100

C-B4340

Blank

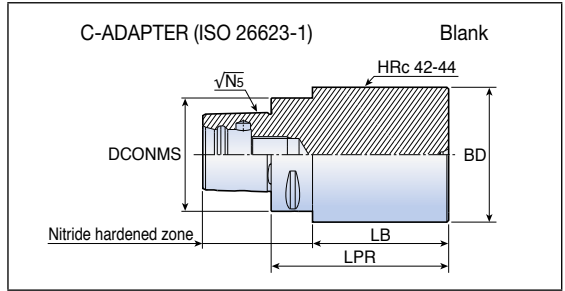

Designation	Dimension (mm)			
	DCONWS	BD	LPR	LB
C4 B4340 040095	40	40	95	75
B4340 060165	40	60	165	144
B4340 080075	40	80	75	54
B4340 100085	40	100	85	64
C5 B4340 050125	50	50	125	105
B4340 075175	50	75	175	154
B4340 090080	50	90	80	59
B4340 110090	50	110	90	69
C6 B4340 075195	63	75	195	172
B4340 110085	63	110	85	62
B4340 130095	63	130	95	72
B4340 120180	63	120	180	157
C8 B4340 080200	80	80	200	170
B4340 120160	80	120	160	129
B4340 130090	80	130	90	59
B4340 145200	80	145	200	169

Straight & Morse Taper Shank



ST-ER-M

ER mini collet chucks

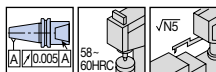
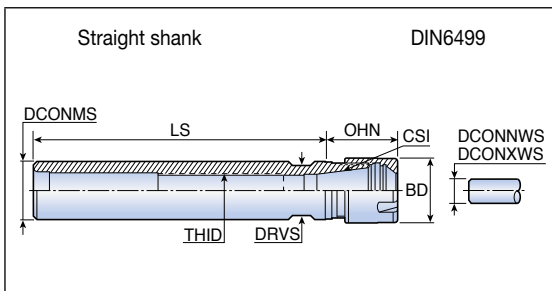

Designation	Dimension (mm)								
	DCONMS	CSI	DCONNWS	DCONXWS	BD	OHN	LS	THID	DRVS
ST 12x80 ER11 M	12	ER11	0.5	7.0	16	26.5	80	-	11
16x100 ER11 M	16	ER11	0.5	7.0	16	18.5	100	M8	13
16x150 ER11 M	16	ER11	0.5	7.0	16	18.5	150	M8	13
12x80 ER16 M	12	ER16	0.5	10.0	22	36.5	80	-	17
20x100 ER16 M	20	ER16	0.5	10.0	22	25.0	100	M12	17
20x150 ER16 M	20	ER16	0.5	10.0	22	25.0	150	M12	17
20x100 ER20 M	20	ER20	1.0	13.0	28	40.0	100	M12	21
20x150 ER20 M	20	ER20	1.0	13.0	28	40.0	150	M12	21

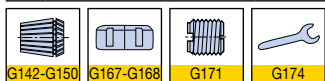

ST-ER-F

ER collet chucks

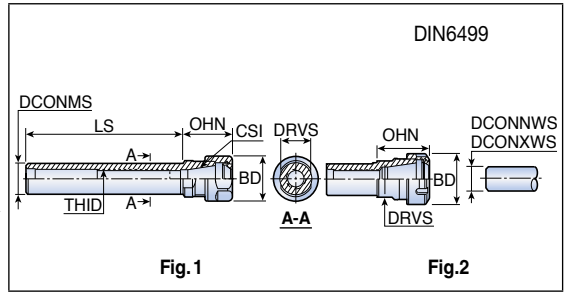
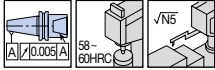
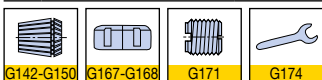

Fig. 1

Fig. 2

Designation	Dimension (mm)									Fig.
	DCONMS	CSI	DCONNWS	DCONXWS	BD	OHN	LS	THID	DRVS	
ST 16x50 ER11 F	16	ER11	0.5	7.0	19	18.5	50	M8	13	1
20x50 ER11 F	20	ER11	0.5	7.0	19	18.5	50	M10	17	1
20x100 ER11	20	ER11	0.5	7.0	19	18.5	100	M10	17	1
20x100 ER11 F	20	ER11	0.5	7.0	19	18.5	100	M10	17	1
20x150 ER11	20	ER11	0.5	7.0	19	18.5	150	M10	17	1
20x50 ER16 F	20	ER16	0.5	10.0	28	32.3	50	M12	19	1
20x100 ER16	20	ER16	0.5	10.0	28	30.0	100	M12	19	1
20x100 ER16 F	20	ER16	0.5	10.0	28	30.0	100	M12	19	1
20x150 ER16	20	ER16	0.5	10.0	28	30.0	150	M12	19	1
20x50 ER20 F	20	ER20	1.0	13.0	34	42.5	50	M12	22	1
25x100 ER20	25	ER20	1.0	13.0	34	36.0	100	M16	22	1
25x150 ER20	25	ER20	1.0	13.0	34	36.0	150	M16	22	1
20x50 ER25 F	20	ER25	1.0	16.0	42	46.0	50	M12	28	2
20x100 ER25	20	ER25	1.0	16.0	42	46.0	100	M12	28	2
20x100 ER25 F	20	ER25	1.0	16.0	42	46.0	100	M12	28	2
25x50 ER25 F	25	ER25	1.0	16.0	42	46.0	50	M16	28	2
25x100 ER25	25	ER25	1.0	16.0	42	46.0	100	M16	28	2
20x50 ER32 F	20	ER32	2.0	20.0	50	54.0	50	M12	36	2
20x100 ER32	20	ER32	2.0	20.0	50	54.0	100	M12	36	2
20x100 ER32 F	20	ER32	2.0	20.0	50	54.0	100	M12	36	2
25x50 ER32 F	25	ER32	2.0	20.0	50	52.0	50	M16x2	36	2
30x50 ER32 F	30	ER32	2.0	20.0	50	52.0	50	M18x1.5	36	2
32x50 ER32 F	32	ER32	2.0	20.0	50	52.0	50	M18x1.5	36	2
32x150 ER32	32	ER32	2.0	20.0	50	52.0	150	M18x1.5	36	2
40x75 ER32 F	40	ER32	2.0	20.0	50	46.0	75	M22x1.5	44	2
25x50 ER40 F	25	ER40	3.0	26.0	63	60.0	50	M16x2	45	2
30x50 ER40 F	32	ER40	3.0	26.0	63	60.0	50	M18x1.5	45	2
32x50 ER40 F	32	ER40	3.0	26.0	63	60.0	50	M18x1.5	45	2
40x75 ER40 F	40	ER40	3.0	26.0	63	55.0	75	M22x1.5	45	2
50x80 ER40 F	50	ER40	3.0	26.0	63	60.0	80	M28x1.5	54	2
50x80 ER50 F	50	ER50	10.0	34.0	78	77.0	80	M36x1.5	58	2



► F: Flat on the shank

ST-ER-MF

Straight shanks - Mini collet

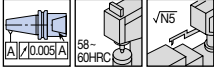
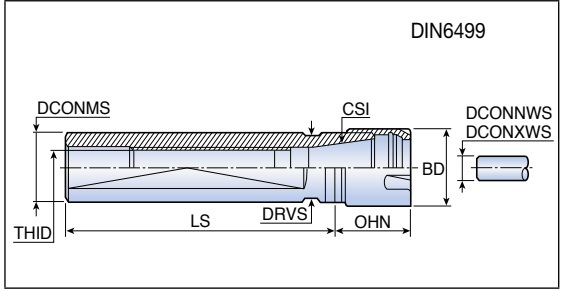

Designation	Dimension (mm)								
	DCONMS	CSI	DCONNWS	DCONXWS	BD	OHN	LS	THID	DRVS
ST 16x38 ER11 MF	16	ER11	0.5	7.0	16	18.5	38	M8x1	14
16x50 ER11 MF	16	ER11	0.5	7.0	16	18.5	50	M8x1	13
16x140 ER11 MF	16	ER11	0.5	7.0	16	18.5	140	M8x1	14
16x35 ER16 MF	16	ER16	0.5	10.0	22	36.0	35	M8x1	17
20x50 ER16 MF	20	ER16	0.5	10.0	22	26.0	50	M12x1	17
20x70 ER16 MF	20	ER16	0.5	10.0	22	26.0	70	M12x1	17
20x120 ER16 MF	20	ER16	0.5	10.0	22	26.0	120	M12x1	17
20x140 ER16 MF	20	ER16	0.5	10.0	22	26.0	140	M12x1	17
22x38 ER16 MF	22	ER16	0.5	10.0	22	26.0	38	M12x1	19
22x70 ER16 MF	22	ER16	0.5	10.0	22	26.0	70	M12x1	19
22x100 ER16 MF	22	ER16	0.5	10.0	22	28.0	100	M12x1	19
25x65 ER16 MF	25	ER16	0.5	10.0	22	28.0	65	M14x1	22
22x80 ER20 MF	22	ER20	1.0	13.0	28	39.0	80	M12x1	21
25x100 ER20 MF	25	ER20	1.0	13.0	28	28.0	100	M14x1	22
25x154 ER20 MF	25	ER20	1.0	13.0	28	28.0	154	M14x1	22
22x70 ER25 MF	22	ER25	1.0	16.0	35	47.0	70	M12x1	27
25x75 ER25 MF	25	ER25	1.0	16.0	35	48.0	75	M14x1	27
25x145 ER25 MF	25	ER25	1.0	16.0	35	36.0	145	M14x1	27
32x70 ER25 MF	32	ER25	1.0	16.0	35	30.0	70	M18x1	27

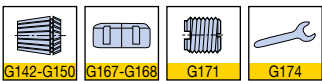

► MF: Mini flat shank

ST-ER-MF D

Straight shanks - Double mini collet

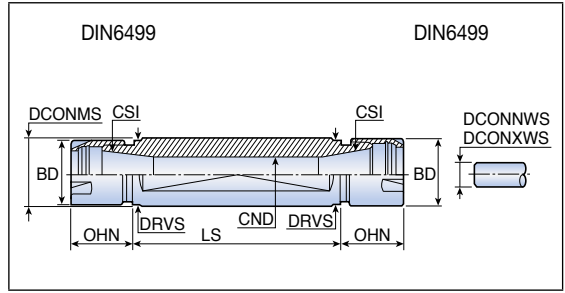
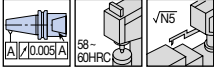

Designation	Dimension (mm)								
	DCONMS	CSI	DCONNWS	DCONXWS	CND	BD	OHN	LS	DRVS
ST 16x50 ER11 MF D	16	ER11	0.5	7.0	7.5	16	18.5	50	14
20x30 ER11 MF D	20	ER11	0.5	7.0	7.5	16	18.5	30	17
20x50 ER11 MF D	20	ER11	0.5	7.0	7.5	16	18.5	50	17
20x55 ER16 MF D	20	ER16	0.5	10.0	10.5	22	25.0	55	17
22x55 ER16 MF D	22	ER16	0.5	10.0	10.5	22	28.0	55	19
22x75 ER16 MF D	22	ER16	0.5	10.0	10.5	22	28.0	75	19
25x62 ER16 MF D	25	ER16	0.5	10.0	10.5	22	28.0	62	22
32x55 ER20 MF D	32	ER20	1.0	13.0	13.5	28	28.0	55	27
32x75 ER20 MF D	32	ER20	1.0	13.0	13.5	28	28.0	75	27

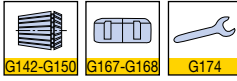

► MF D: Mini flat double

ST-ER-S

Straight shanks - Internal coolant

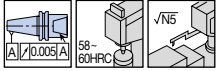
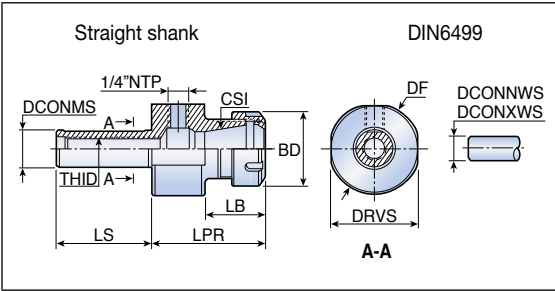

Designation	Dimension (mm)										
	DCONMS	CSI	DCONNWS	DCONXWS	DF	BD	LPR	LB	LS	THID	DRVS
ST 20x65 ER20 S	20	ER20	1.0	13.0	40	34	63	31.0	65	M12	34
20x65 ER25 S	20	ER25	1.0	16.0	54	42	72	32.0	65	M12	51
25x65 ER32 S	25	ER32	2.0	20.0	63	50	77	41.0	65	M16	59
32x65 ER32 S	32	ER32	2.0	20.0	63	50	77	41.0	65	M18x1.5	59
40x75 ER32 S	40	ER32	2.0	20.0	63	50	77	41.0	75	M22x1.5	59

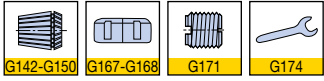

Straight shanks

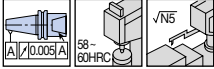
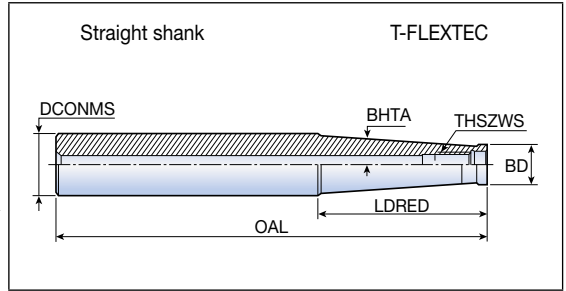

Designation	Dimension (mm)						Shank type
	THSZWS	DCONMS	BD	OAL	LDRED	BHTA	
S M06 - L60 C10	M06	10	9.7	60	20.0	-	C
L105-C12	M06	12	9.7	105	60.0	1.2	C
L125-C16	M06	16	9.7	125	60.0	3.3	C
S M08 - L73 C16	M08	16	13.0	73	25.0	-	C
L128-C 16	M08	16	13.0	128	80.0	0.9	C
L170-C20	M08	20	13.0	170	66.8	3.3	C
S M10 - L80 C20	M10	20	18.0	80	30.0	-	C
L130-C20	M10	20	18.0	130	80.0	0.6	C
L200-C25	M10	25	19.0	200	57.2	3.3	C
S M12 - L86-C25	M12	25	21.0	86	30.0	5.1	C
L200-C32	M12	32	21.0	200	78.0	4.4	C
S M16 - L95-C32	M16	32	29.0	95	35.0	1.7	C
L230-C32	M16	32	29.0	230	50.0	1.8	C

► All shanks have coolant holes

S M-CT-L (M04/06)



Carbide T-FLEXTEC shanks

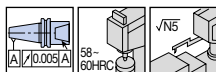
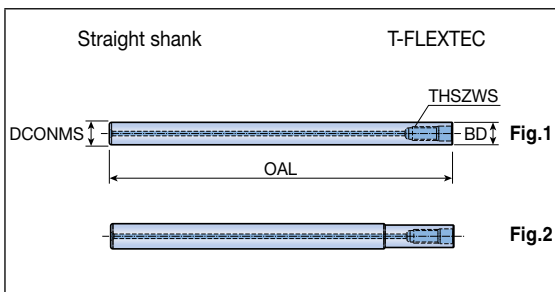

Designation	Dimension (mm)				Coolant hole	Fig.
	THSZWS	DCONMS	BD	OAL		
S M04 - CT08-20-L100	M04	8	7.8	100	•	2
CT08-40-L150-B	M04	8	7.8	150	x	2
S M06 - CT10-L100	M06	10	10	100	•	1
CT10-L150	M06	10	10	150	•	1
CT12-L100	M06	12	12	100	•	1
CT12-L150	M06	12	12	150	•	1

S M-CT-L (M08/10/12/16)



Carbide T-FLEXTEC shanks with internal coolant hole

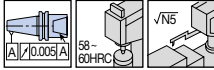
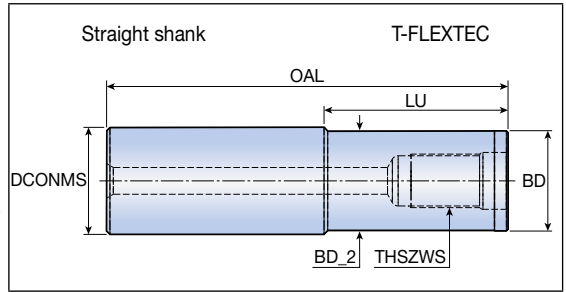

Designation	Dimension (mm)					
	THSZWS	DCONMS	BD	BD_2	OAL	LU
S M08-CT16 - 20-L80	M08	16	15.3	15.3	80	20
40-L100	M08	16	15.3	15.3	100	40
80-L150	M08	16	15.3	15.3	150	80
100-L200	M08	16	13.0	12.5	200	100
140-L200	M08	16	15.3	15.3	200	140
180-L250	M08	16	15.3	15.3	250	180
S M10-CT20 - 20-L80	M10	20	18.5	18.5	80	20
40-L100	M10	20	18.5	18.5	100	40
80-L150	M10	20	18.5	18.5	150	80
100-L200	M10	20	18.5	18.5	200	100
130-L250	M10	20	18.0	17.5	250	130
140-L200	M10	20	18.0	17.5	200	140
140-L200-N	M10	20	18.5	18.5	200	140
180-L250	M10	20	18.0	17.5	250	180
180-L250-N	M10	20	18.5	18.5	250	180
180-L300	M10	20	18.0	17.5	300	180
230-L300	M10	20	18.0	17.5	300	230
S M12-CT25 - 40-L100	M12	25	24	24.0	100	40
80-L150	M12	25	21	20.5	150	80
80-L150-N	M12	25	24	24.0	150	80
100-L200	M12	25	21	20.5	200	100
100-L200-N	M12	25	24	24.0	200	100
130-L250	M12	25	21	20.5	250	130
140-L200	M12	25	21	20.5	200	140
180-L250	M12	25	24	24.0	250	180
180-L250-B	M12	25	21	20.5	250	180
180-L300	M12	25	21	20.5	300	180
180-L300-N	M12	25	24	24.0	300	180
230-L300	M12	25	21	20.5	300	230

S M-CT-L (M08/10/12/16)



Carbide T-FLEXTEC shanks with internal coolant hole

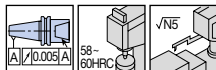
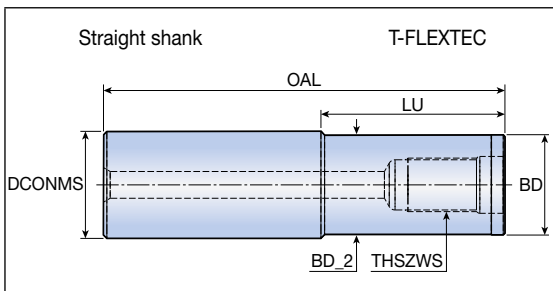

Designation	Dimension (mm)					
	THSZWS	DCONMS	BD	BD_2	OAL	LU
S M16-CT32 - 40-L100	M16	32	29	29.0	100	40
80-L150	M16	32	29	29.0	150	80
100-L200	M16	32	29	29.0	200	100
130-L250	M16	32	29	29.0	250	130
140-L200	M16	32	29	29.0	200	140
180-L250	M16	32	29	29.0	250	180
180-L300	M16	32	29	29.0	300	180
230-L300	M16	32	29	29.0	300	230
230-L350	M16	32	29	29.0	350	230
280-L350	M16	32	29	29.0	350	280

TFLEX-TCD-M12



T-FLEXTEC shank

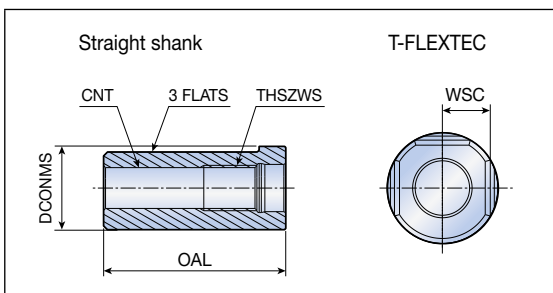

Designation	Dimension (mm)				CNT
	THSZWS	DCONMS	OAL	WSC	
TFLEX 160X36-TCD-M12	M12	16	36	7.5	UNF 5/16
1905X36-TCD-M12	M12	19.05	36	8.5	UNF 5/16
200X36-TCD-M12	M12	20	36	8.5	G 1/8
220X48-TCD-M12	M12	22	48	9.5	G 1/8
250X54-TCD-M12	M12	25	54	11	G 1/8
254X54-TCD-M12	M12	25.4	54	11	G 1/8

CAB M-M



Reducers

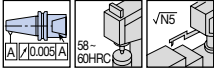
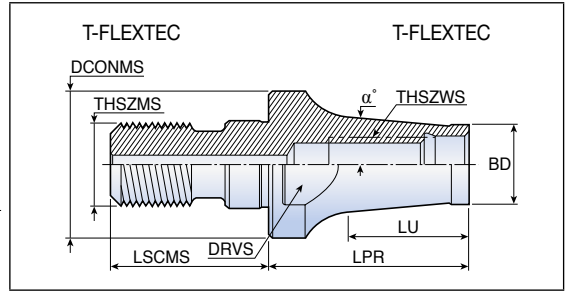

Designation	Dimension (mm)								
	THSZWS	THSZMS	BD	DCONMS	LPR	LSCMS	LU	DRVS	α°
CAB M06M08	M06	M08	9.7	13	30	17.5	24.8	9.5	5.7
M08M10	M08	M10	13.0	18	40	20.0	33.4	15.0	5.2
M10M12	M10	M12	18.0	21	45	22.0	36.4	17.0	2.5
M12M16	M12	M16	21.0	29	50	25.0	42.5	25.0	6.3

► With coolant holes

CAB M-M-C



Extensions

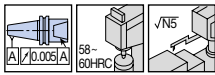
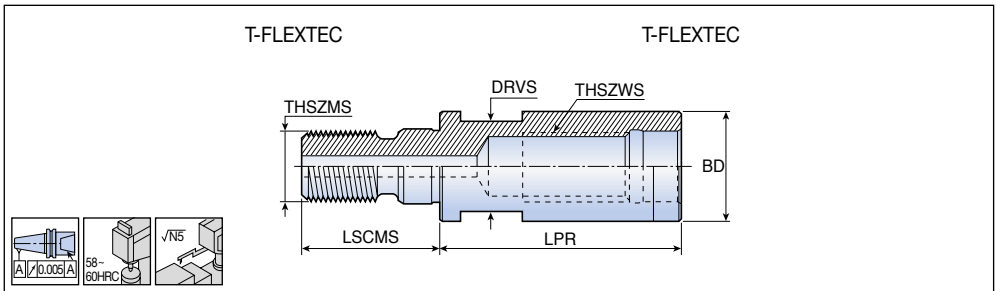

Designation	Dimension (mm)					
	THSZWS	THSZMS	BD	LPR	LSCMS	DRVS
CAB M08M08-C	M08	M08	13	30	17.5	9.6
M10M10-C	M10	M10	18	35	20.0	15.0
M12M12-C	M12	M12	21	40	22.0	17.0
M16M16-C	M16	M16	29	40	25.0	25.0

► With coolant holes

CDP ER-M



Adapters with ER collet chuck

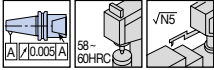
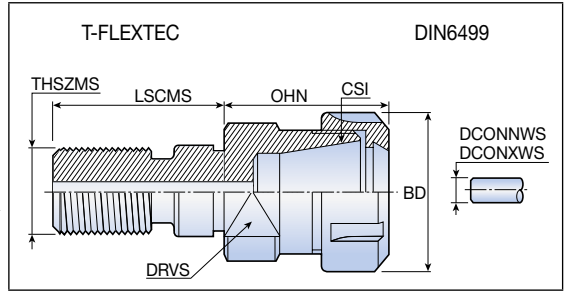

Designation	Dimension (mm)							
	CSI	THSZMS	DCONNWS	DCONXWS	BD	OHN	LSCMS	DRVS
CDP ER11 M10 M	ER11	M10	0.5	7.0	16	27.0	20	15
ER11 M12 M	ER11	M12	0.5	7.0	16	27.0	22	17
ER16 M10 M	ER16	M10	0.5	10.0	22	38.1	20	17
ER16 M12 M	ER16	M12	0.5	10.0	22	37.1	22	17
ER16 M16	ER16	M16	0.5	10.0	28	36.6	25	25
ER20 M16	ER20	M16	1.0	13.0	34	45.5	25	25
ER25 M16	ER25	M16	1.0	16.0	42	44.5	25	28

► With coolant holes

CAB M-SEM-C



Shell mill arbors

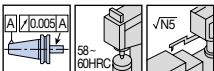
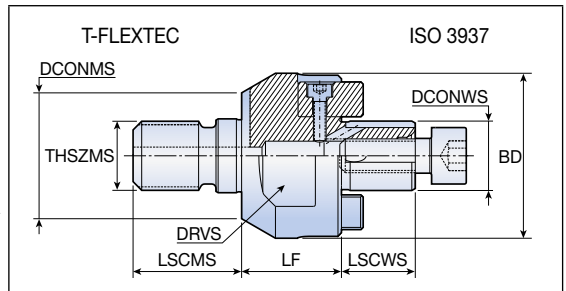

Designation	Dimension (mm)							
	THSZMS	DCONWS	DCONMS	BD	LF	LSCWS	LSCMS	DRVS
CAB M16 SEM 16C	M16	16	29	38	23	17	25	32

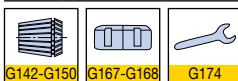

► With coolant holes

GFI ST-ER

GFI floating reamer ER collet chucks

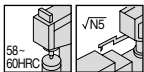
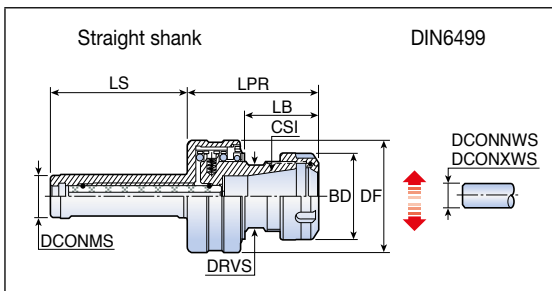

Designation	Dimension (mm)										
	DCONMS	CSI	DCONNWS	DCONXWS	DF	BD	LPR	LB	LS	Radial float	DRVS
GFI ST20 ER20	20	ER20	1.0	13.0	50	34	55.5	34.5	65	1.0	22
ST25 ER32	25	ER32	2.0	20.0	65	50	76.9	45.9	80	1.6	36

► Max. 2,000RPM

GFI MT-ER

Morse taper GFI reamer holders

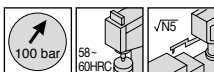
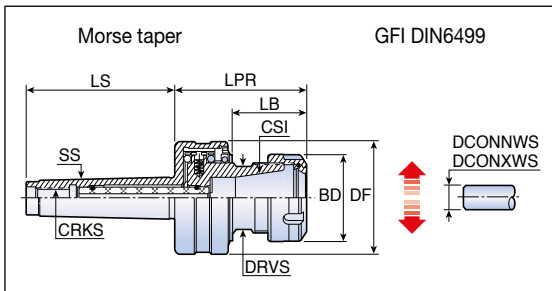

Designation	Dimension (mm)											
	SS	CSI	DCONNWS	DCONXWS	DF	BD	LPR	LB	LS	CRKS	Radial float	DRVS
GFI MT2 ER20	2	ER20	1.0	13.0	50	34	60.5	34.5	64	M10	1.0	22
MT3 ER32	3	ER32	2.0	20.0	65	50	81.9	45.9	81	M12	1.6	36

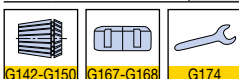

► Max. 2,000RPM

MT-ER

Morse taper collet chucks

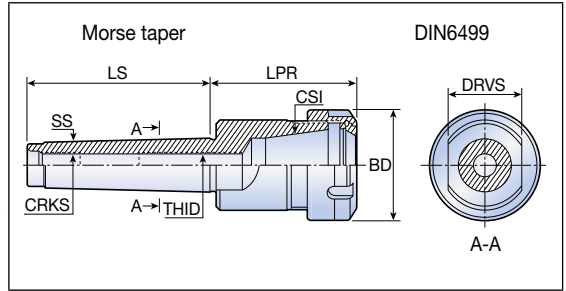
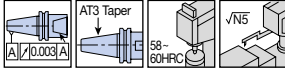

Designation	Dimension (mm)									
	SS	CSI	DCONWS	DCONXWS	BD	LPR	LS	CRKS	THID	DRVS
MT2 ER 20x48.5	2	ER20	1.0	13.0	34	48.5	64.0	M10	M10	22
ER 25x52	2	ER25	1.0	16.0	42	52.0	64.0	M10	M10	28
MT3 ER 32x69	3	ER32	2.0	20.0	50	69.0	81.0	M12	M12	24
ER 40x79	3	ER40	3.0	26.0	63	79.0	81.0	M12	M12	24
MT4 ER 32x61	4	ER32	2.0	20.0	50	60.5	102.5	M16	M16	32
ER 40x82	4	ER40	3.0	26.0	63	81.5	102.5	M16	M16	32
ER 50x108	4	ER50	10.0	34.0	78	107.5	102.5	M16	M16	32
MT5 ER 40x82	5	ER40	3.0	26.0	63	82.0	129.5	M20	M28x1.5	45
ER 50x85	5	ER50	10.0	34.0	78	85.0	129.5	M20	M28x1.5	45

MTA-TC

Tap holders - MTA

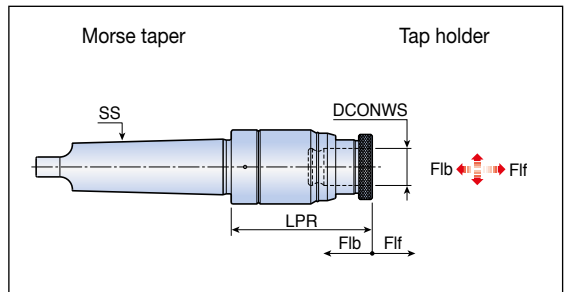

Designation	Dimension (mm)							
	SS	Tapmin	Tapmax	DCONWS	LPR	Flb	Flf	Tap adapter
MTA3 TC12-90	12	M3	M12	19	90	6.5	12	TA1
TC22-115	22	M6	M24	31	115	14.5	13	TA2
MTA4 TC12-105	12	M3	M12	19	105	6.5	12	TA1
TC22-115	22	M6	M24	31	115	14.5	13	TA2
MTA5 TC12-145	12	M3	M12	19	145	6.5	12	TA1

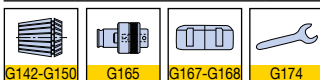

TYPHOON



TJS GJET HSK

Coolant driven high-speed compact spindles with HSK shank

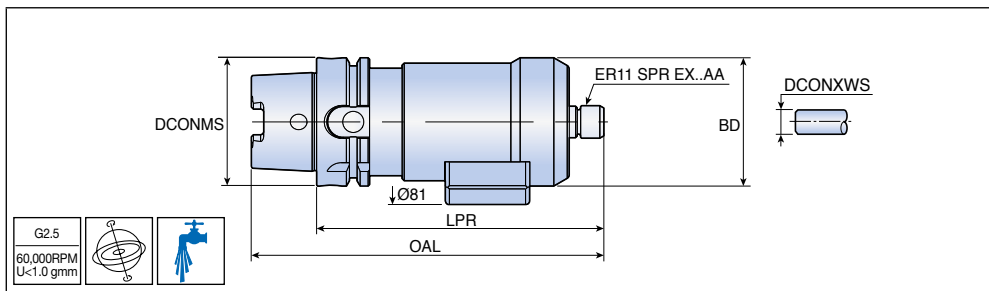

Designation	Dimension (mm)					Kg
	DCONMS	DCONXWS	LPR	OAL	BD	
TJS GJET HSK A63	63.0	7.0	141.0	173.0	63.0	1.8

- ▶ Minimum coolant pressure 20 bar and flow rate 12 l/min
- ▶ The spindle provides only external strong coolant jet around the tool
- ▶ DCONXWS: Maximum tool shank diameter

Spare parts

Designation	Mini ER nut	ER wrench	Key	Locking pin	Display*
TJS-GJET-HSK A63	NUT ER11 GHS	WRENCH ER11 SMS	HW 2.0	TJS SHAFT LOCK KEY	TJS TSD DISPLAY

▶ *: Optional, sold separately

TJS M90

Coolant driven high-speed compact angular head spindle

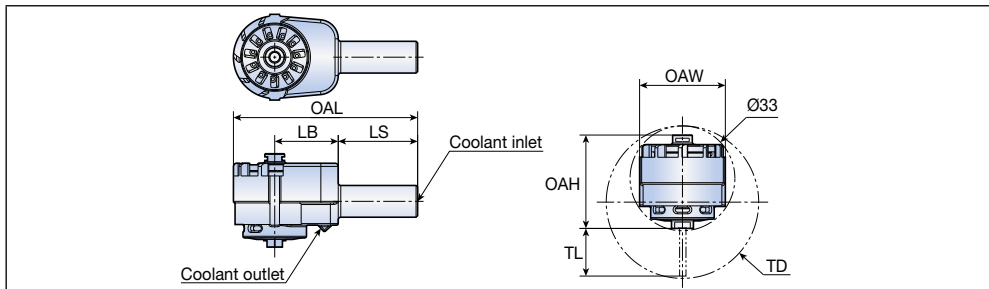

Designation	Dimension (mm)					
	DCONMS	LS	LB	OAL	OAH	OAW
TJS M90-3.0	10	25	20	58	29	27

- ▶ Coolant pressure 20 – 40 bar and flow rate 10 - 20 l/min
 - ▶ Rotational spindle speed [rpm]: 35,000–53,000 (rev/min)
 - ▶ The spindle provides only external strong coolant jet around the tool
- ▶ TD: TL (Tool Length)+33 mm

TJS M00

Coolant driven high-speed compact spindle

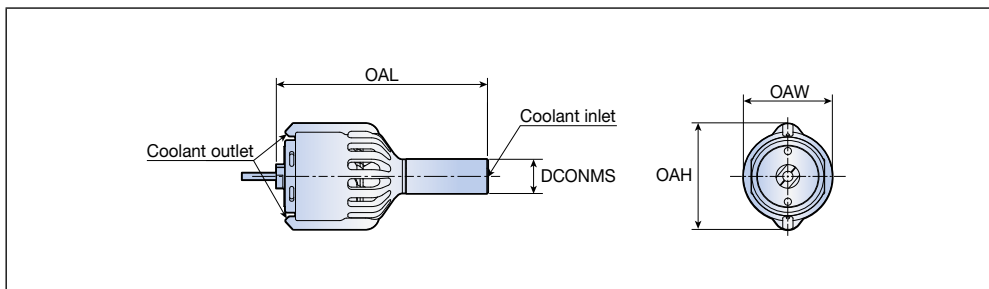

Designation	Dimension (mm)				
	DCONMS	LS	OAL	OAH	OAW
TJS M00-3.0	10	23.8	61.8	26	31

- ▶ Coolant pressure: 15 - 40 bar and flow rate: 10 - 20 l/min
- ▶ Rotational spindle speed [rpm]: 18,000 - 40,000 (rev/min)
- ▶ The spindle provides only external strong coolant jet around the tool

Spare parts

Designation	Ø3 collet	Lock key	Wrench	Nozzle	Collet*
			(1) (2)		
TJS M90-3.0	TJS-COLLET 3.0		TJS MJ90 WRENCH-2430		* TJS-COLLET 1.6 * TJS-COLLET 2.0 * TJS-COLLET 3.175
TJS M00-3.0	TJS-COLLET 3.0	TJS MJ-SHAFTLOCK	TJS MJ-WRENCH COLLET	TJS MJ-PLUG COOLANT	* TJS-COLLET 1.6 * TJS-COLLET 2.0

- ▶ *: Optional, sold separately
- ▶ (1): For TJS M90, (2): For TJS M00

Collet



Collet

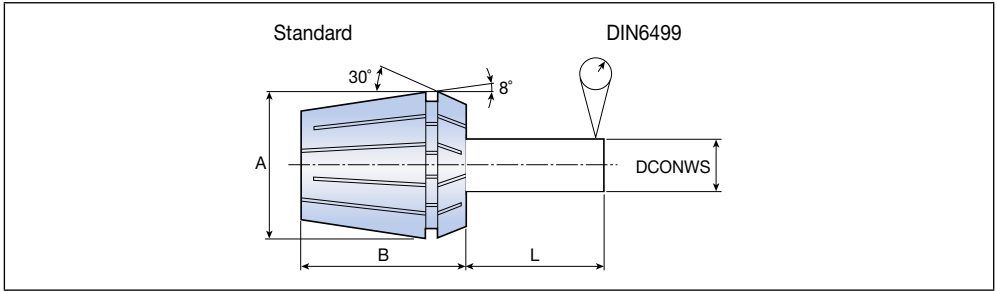

Precision

(mm)

DCONWS _{range}	L	Run-out		
		Standard precision	Ultra precision	DIN6499
1.0-1.6	6	0.01	0.005	-
1.6-3.0	10	0.01	0.005	0.015
3.0-6.0	16	0.01	0.005	0.015
6.0-10.0	25	0.01	0.005	0.015
10.0-18.0	40	0.01	0.005	0.020
18.0-26.0	50	0.01	0.005	0.020
26.0-34	60	-	-	0.025

Dimension

(mm)

Type	A	B
ER11	11.5	18
ER16	17.0	27
ER20	21.0	31
ER25	26.0	35
ER32	33.0	40
ER40	41.0	46
ER50	52.0	60

ER-SPR

ER spring collets - Precision

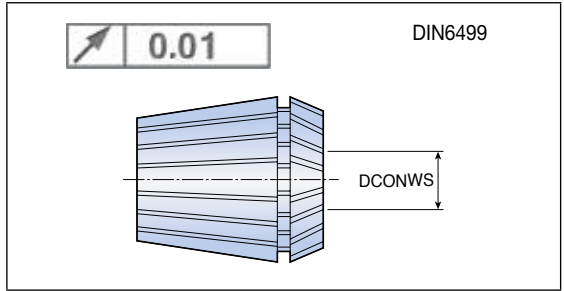

DCONWSrange		ER11	ER16	ER20	ER25	ER32	ER40	ER50
0.5-1		ER11 SPR 0.5-1.0	ER16 SPR 0.5-1					
1-2	1-1.5	1.0-1.5						
	1.5-2	1.5-2.0	1-2	ER20 SPR 1-2	ER25 SPR 1-2			
2-3	2-2.5	2.0-2.5						
	2.5-3	2.5-3.0	2-3	2-3	2-3	ER32 SPR 2-3		
3-4	3-3.5	3.0-3.5						
	3.5-4	3.5-4.0	3-4	3-4	3-4	3-4	ER40 SPR 3-4	
4-5	4-4.5	4.0-4.5						
	4.5-5	4.5-5.0	4-5	4-5	4-5	4-5	4-5	
5-6	5-5.5	5.0-5.5						
	5.5-6	5.5-6.0	5-6	5-6	5-6	5-6	5-6	
6-7	6-6.5	6.0-6.5						
	6.5-7	6.5-7.0	6-7	6-7	6-7	6-7	6-7	
7-8			7-8	7-8	7-8	7-8	7-8	
8-9			8-9	8-9	8-9	8-9	8-9	
9-10			9-10	9-10	9-10	9-10	9-10	
10-11				10-11	10-11	10-11	10-11	ER50 SPR 10-12
11-12				11-12	11-12	11-12	11-12	ER50 SPR 10-12
12-13				12-13	12-13	12-13	12-13	12-14
13-14					13-14	13-14	13-14	12-14
14-15					14-15	14-15	14-15	14-16
15-16					15-16	15-16	15-16	14-16
16-17						16-17	16-17	16-18
17-18						17-18	17-18	16-18
18-19						18-19	18-19	18-20
19-20						19-20	19-20	18-20
20-21							20-21	20-22
21-22							21-22	20-22
22-23							22-23	22-24
23-24							23-24	22-24
24-25							24-25	24-26
25-26							25-26	24-26
26-28								26-28
28-30								28-30
30-32								30-32
32-34								32-34

ER-SPR-AA

ER spring collets - Ultra precision "AA"

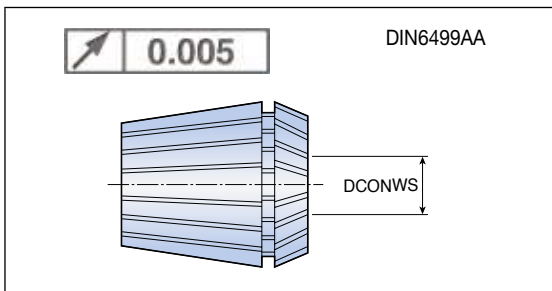

DCONWS _{range}	ER11	ER16	ER20	ER25	ER32	ER40
0.5-1	ER11 SPR 0.5-1.0AA	ER16 SPR 0.5-1AA				
1-2	1-1.5	1.0-1.5AA				
	1.5-2	1.5-2.0AA	1-2AA	ER20 SPR 1-2AA	ER25 SPR 1-2AA	
2-3	2-2.5	2.0-2.5AA				
	2.5-3	2.5-3.0AA	2-3AA	2-3AA	2-3AA	ER32 SPR 2-3AA
3-4	3-3.5	3.0-3.5AA				
	3.5-4	3.5-4.0AA	3-4AA	3-4AA	3-4AA	3-4AA
4-5	4-4.5	4.0-4.5AA				
	4.5-5	4.5-5.0AA	4-5AA	4-5AA	4-5AA	4-5AA
5-6	5-5.5	5.0-5.5AA				
	5.5-6	5.5-6.0AA	5-6AA	5-6AA	5-6AA	5-6AA
6-7	6-6.5	6.0-6.5AA				
	6.5-7	6.5-7.0AA	6-7AA	6-7AA	6-7AA	6-7AA
7-8		7-8AA	7-8AA	7-8AA	7-8AA	7-8AA
8-9		8-9AA	8-9AA	8-9AA	8-9AA	8-9AA
9-10		9-10AA	9-10AA	9-10AA	9-10AA	9-10AA
10-11			10-11AA	10-11AA	10-11AA	10-11AA
11-12			11-12AA	11-12AA	11-12AA	11-12AA
12-13			12-13AA	12-13AA	12-13AA	12-13AA
13-14				13-14AA	13-14AA	13-14AA
14-15				14-15AA	14-15AA	14-15AA
15-16				15-16AA	15-16AA	15-16AA
16-17					16-17AA	16-17AA
17-18					17-18AA	17-18AA
18-19					18-19AA	18-19AA
19-20					19-20AA	19-20AA
20-21						20-21AA
21-22						21-22AA
22-23						22-23AA
23-24						23-24AA
24-25						24-25AA
25-26						25-26AA

EROH

ER collets for internal coolant

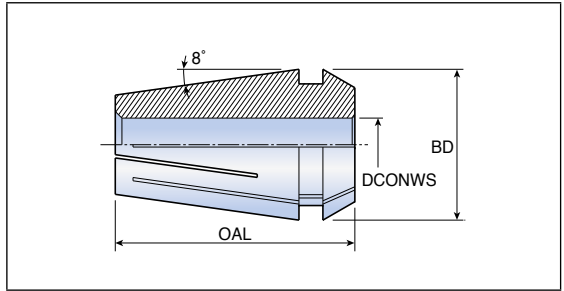

Designation	Dimension (mm)		
	DCONWSrange	BD	OAL
EROH 16	4.0-10.0	17	27.5
EROH 20	6.0-13.0	21	31.5
EROH 25	6.0-16.0	26	34.0
EROH 32	8.0-20.0	33	40.0
EROH 40	10.0-26.0	41	46.0

DCONWS	ER16	ER20	ER25	ER32	ER40
4	EROH 16-4				
5	EROH 16-5				
6	EROH 16-6	EROH 20-6	EROH 25-6		
7	EROH 16-7	EROH 20-7	EROH 25-7		
8	EROH 16-8	EROH 20-8	EROH 25-8	EROH 32-8	
9	EROH 16-9	EROH 20-9	EROH 25-9	EROH 32-9	
10	EROH 16-10	EROH 20-10	EROH 25-10	EROH 32-10	EROH 40-10
11		EROH 20-11	EROH 25-11	EROH 32-11	EROH 40-11
12		EROH 20-12	EROH 25-12	EROH 32-12	EROH 40-12
13		EROH 20-13	EROH 25-13	EROH 32-13	EROH 40-13
14			EROH 25-14	EROH 32-14	EROH 40-14
15			EROH 25-15	EROH 32-15	EROH 40-15
16			EROH 25-16	EROH 32-16	EROH 40-16
17				EROH 32-17	EROH 40-17
18				EROH 32-18	EROH 40-18
19				EROH 32-19	EROH 40-19
20				EROH 32-20	EROH 40-20
21					EROH 40-21
22					EROH 40-22
23					EROH 40-23
24					EROH 40-24
25					EROH 40-25
26					EROH 40-26

ER TAP (For JIS)

ER type tap collets

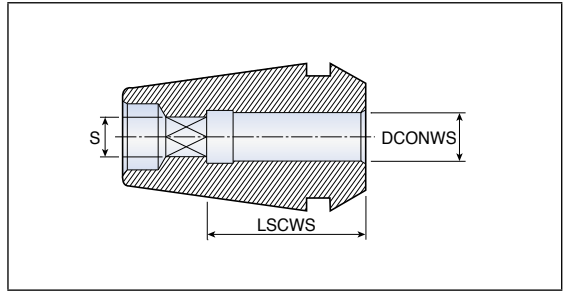

Tap size	Dimension (mm)			ER TAP 16	ER TAP 20	ER TAP 25	ER TAP 32	ER TAP 40
	LSCWS	DCONWS	S					
M4	15	5.0	4.0	ER TAP 16-M4	ER TAP 20-M4	ER TAP 25-M4	ER TAP 32-M4	
M5	15	5.5	4.5	ER TAP 16-M5	ER TAP 20-M5	ER TAP 25-M5	ER TAP 32-M5	
M6	15	6.0	4.5	ER TAP 16-M6	ER TAP 20-M6	ER TAP 25-M6	ER TAP 32-M6	
M8	20	6.2	5.0	ER TAP 16-M8	ER TAP 20-M8	ER TAP 25-M8	ER TAP 32-M8	
M10	20	7.0	5.5	ER TAP 16-M10	ER TAP 20-M10	ER TAP 25-M10	ER TAP 32-M10	ER TAP 40-M10
M12	20	8.5	6.5		ER TAP 20-M12	ER TAP 25-M12	ER TAP 32-M12	ER TAP 40-M12
M14	25	10.5	8.0			ER TAP 25-M14	ER TAP 32-M14	ER TAP 40-M14
M16	25	12.5	10.0			ER TAP 25-M16	ER TAP 32-M16	ER TAP 40-M16
M18	30	14.0	11.0				ER TAP 32-M18	ER TAP 40-M18
M20	30	15.0	12.0				ER TAP 32-M20	ER TAP 40-M20
M22	30	17.0	13.0					ER TAP 40-M22
M24	35	19.0	15.0					ER TAP 40-M24
M27	35	20.0	15.0					ER TAP 40-M27

▶ Tap specification is based on JIS (DIN or ISO standard prepared by special quotation)

SET ER-SPR

ER spring collet sets

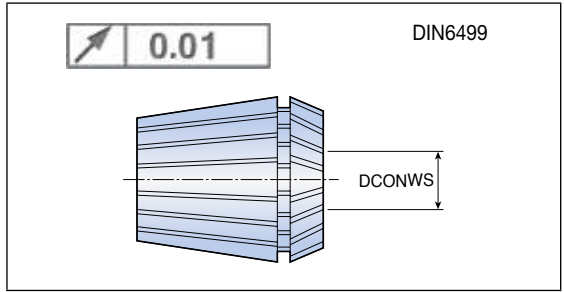

Designation	Pieces / set	DCONWSrange
SET ER11 SPR 13	13	0.5-7
ER16 SPR 10	10	0.5-10
ER20 SPR 12	12	1-13
ER25 SPR 15	15	1-16
ER32 SPR 18	18	2-20
ER40 SPR 23	23	3-26
ER50 SPR 12	12	10-34

SET ER-SPR-AA

ER spring collet sets – Ultra precision “AA”

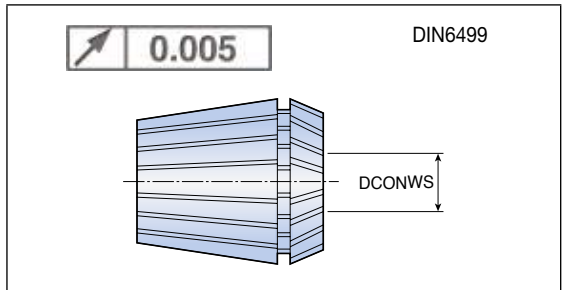

Designation	Pieces / set	DCONWSrange
SET ER11 SPR 13AA	13	0.5-7
ER16 SPR 10AA	10	0.5-10
ER20 SPR 12AA	12	1-13
ER25 SPR 15AA	15	1-16
ER32 SPR 18AA	18	2-20
ER40 SPR 23AA	23	3-26

SET ER-SPR-EM

ER spring collet sets

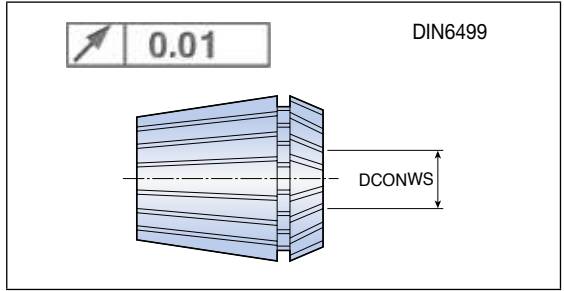

Designation	Pieces / set	DCONWSrange
SET ER16 SPR 7 EM	7	1,2,3,4,5,6,7
ER16 SPR 8 EM	8	3, 4, 5, 6, 7, 8, 9, 10
ER20 SPR 5 EM	5	4, 6, 8, 10, 12
ER25 SPR 6 EM	6	4, 6, 8, 10, 12, 16
ER32 SPR 6 EM	6	6, 8, 10, 12, 16, 20
ER40 SPR 7 EM	7	6, 8, 10, 12, 16, 20, 25

SET ER-SPR-EM AA

ER spring collet sets – Ultra precision “AA”

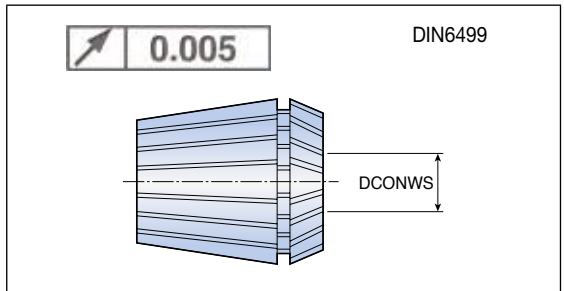

Designation	Pieces / set	DCONWSrange
SET ER11 SPR 7 EM AA	7	1,2,3,4,5,6,7

TSK

TSK collets

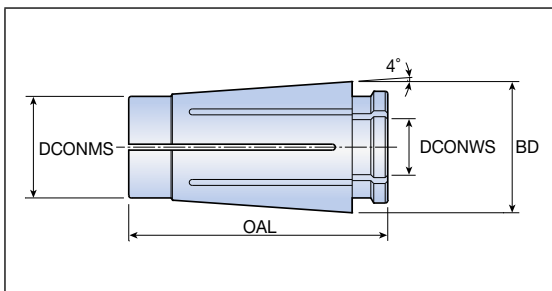

Designation	Dimension (mm)			
	DCONWS _{range}	BD	DCONMS	OAL
TSK 06	2.0-6.0	10.4	7.5	25.0
TSK 10	2.0-10.0	15.5	12.0	30.6
TSK 16	3.0-16.0	24.6	18.8	45.0
TSK 25	8.0-25.0	35.7	28.8	57.0

DCONWS _{range}	TSK 06	TSK 10	TSK 16	TSK 25
1.5-2.0	TSK 06-2.0	TSK 10-2.0		
2.0-2.5	TSK 06-2.5	TSK 10-2.5		
2.5-3.0	TSK 06-3.0	TSK 10-3.0	TSK 16-3.0	
3.0-3.5	TSK 06-3.5	TSK 10-3.5	TSK 16-3.5	
3.5-4.0	TSK 06-4.0	TSK 10-4.0	TSK 16-4.0	
4.0-4.5	TSK 06-4.5	TSK 10-4.5	TSK 16-4.5	
4.5-5.0	TSK 06-5.0	TSK 10-5.0	TSK 16-5.0	
5.0-5.5	TSK 06-5.5	TSK 10-5.5	TSK 16-5.5	
5.5-6.0	TSK 06-6.0	TSK 10-6.0	TSK 16-6.0	
6.0-6.5		TSK 10-6.5	TSK 16-6.5	
6.5-7.0		TSK 10-7.0	TSK 16-7.0	
7.0-7.5		TSK 10-7.5	TSK 16-7.5	
7.5-8.0		TSK 10-8.0	TSK 16-8.0	TSK 25-8.0
8.0-8.5		TSK 10-8.5	TSK 16-8.5	TSK 25-8.5
8.5-9.0		TSK 10-9.0	TSK 16-9.0	TSK 25-9.0
9.0-9.5		TSK 10-9.5	TSK 16-9.5	TSK 25-9.5
9.5-10.0		TSK 10-10.0	TSK 16-10.0	TSK 25-10.0
10.0-10.5			TSK 16-10.5	TSK 25-10.5
10.5-11.0			TSK 16-11.0	TSK 25-11.0
11.0-11.5			TSK 16-11.5	TSK 25-11.5
11.5-12.0			TSK 16-12.0	TSK 25-12.0
12.0-12.5			TSK 16-12.5	TSK 25-12.5
12.5-13.0			TSK 16-13.0	TSK 25-13.0
13.0-13.5			TSK 16-13.5	TSK 25-13.5
13.5-14.0			TSK 16-14.0	TSK 25-14.0
14.0-14.5			TSK 16-14.5	TSK 25-14.5
14.5-15.0			TSK 16-15.0	TSK 25-15.0
15.0-15.5			TSK 16-15.5	TSK 25-15.5
15.5-16.0			TSK 16-16.0	TSK 25-16.0
16.0-16.5				TSK 25-16.5
16.5-17.0				TSK 25-17.0

TSK

TSK collets

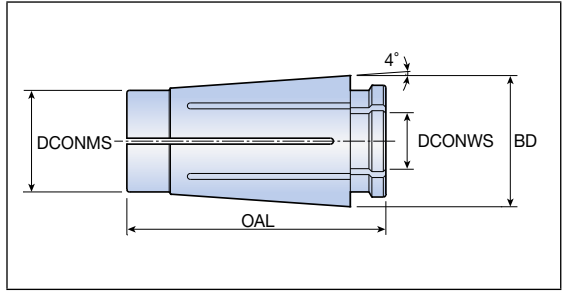

Designation	Dimension (mm)			
	DCONWSrange	BD	DCONMS	OAL
TSK 06	2.0-6.0	10.4	7.5	25.0
TSK 10	2.0-10.0	15.5	12.0	30.6
TSK 16	3.0-16.0	24.6	18.8	45.0
TSK 25	8.0-25.0	35.7	28.8	57.0
DCONWSrange	TSK 06	TSK 10	TSK 16	TSK 25
17.0-17.5				TSK 25-17.5
17.5-18.0				TSK 25-18.0
18.0-18.5				TSK 25-18.5
18.5-19.0				TSK 25-19.0
19.0-19.5				TSK 25-19.5
19.5-20.0				TSK 25-20.0
20.0-20.5				TSK 25-20.5
20.5-21.0				TSK 25-21.0
21.0-21.5				TSK 25-21.5
21.5-22.0				TSK 25-22.0
22.0-22.5				TSK 25-22.5
22.5-23.0				TSK 25-23.0
23.0-23.5				TSK 25-23.5
23.5-24.0				TSK 25-24.0
24.0-24.5				TSK 25-24.5
24.5-25.0				TSK 25-25.0

TSKC

Internal coolant type collets for TSKC chucks

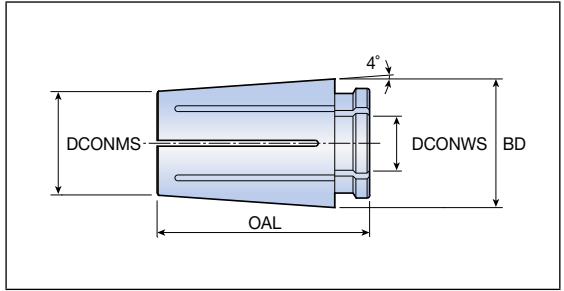

Designation	Dimension (mm)			
	DCONWS _{range}	BD	DCONMS	OAL
TSKC 06	4.0-6.0	10.4	8.00	21.0
TSKC 10	6.0-10.0	15.5	12.50	25.6
TSKC 16	8.0-16.0	24.6	20.12	37.0
TSKC 25	16.0-25.0	35.7	29.70	48.5

DCONWS _{range}	TSKC 06	TSKC 10	TSKC 16	TSKC 25
4	TSKC 06-4.0			
5	TSKC 06-5.0			
6	TSKC 06-6.0	TSKC 10-6.0		
7		TSKC 10-7.0		
8		TSKC 10-8.0	TSKC 16-8.0	
9		TSKC 10-9.0	TSKC 16-9.0	
10		TSKC 10-10.0	TSKC 16-10.0	
11			TSKC 16-11.0	
12			TSKC 16-12.0	
13			TSKC 16-13.0	
14			TSKC 16-14.0	
15			TSKC 16-15.0	
16			TSKC 16-16.0	TSKC 25-16.0
17				TSKC 25-17.0
18				TSKC 25-18.0
19				TSKC 25-19.0
20				TSKC 25-20.0
21				TSKC 25-21.0
22				TSKC 25-22.0
23				TSKC 25-23.0
24				TSKC 25-24.0
25				TSKC 25-25.0

THC

Straight collets for hydraulic chucks

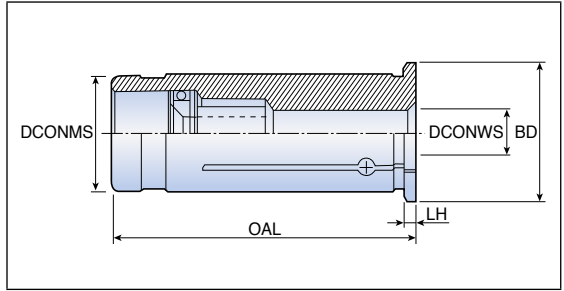

Designation	Dimension (mm)				
	DCONMS	DCONWS	BD	OAL	LH
THC 12-3	12	3	16	46.5	2
12-4	12	4	16	46.5	2
12-5	12	5	16	46.5	2
12-6	12	6	16	46.5	2
12-7	12	7	16	46.5	2
12-8	12	8	16	46.5	2
12-9	12	9	16	46.5	2
20-3	20	3	24	50.5	2
20-4	20	4	24	50.5	2
20-5	20	5	24	50.5	2
20-6	20	6	24	50.5	2
20-7	20	7	24	50.5	2
20-8	20	8	24	50.5	2
20-9	20	9	24	50.5	2
20-10	20	10	24	50.5	2
20-11	20	11	24	50.5	2
20-12	20	12	24	50.5	2
20-13	20	13	24	50.5	2
20-14	20	14	24	50.5	2
20-15	20	15	24	50.5	2
20-16	20	16	24	50.5	2
20-17	20	17	24	50.5	2
32-6	32	6	36	60.5	3
32-8	32	8	36	60.5	3
32-10	32	10	36	60.5	3
32-12	32	12	36	60.5	3
32-14	32	14	36	60.5	3
32-16	32	16	36	60.5	3
32-18	32	18	36	60.5	3
32-20	32	20	36	60.5	3
32-25	32	25	36	60.5	3

THC C

Straight collets of internal coolant type for hydraulic chucks

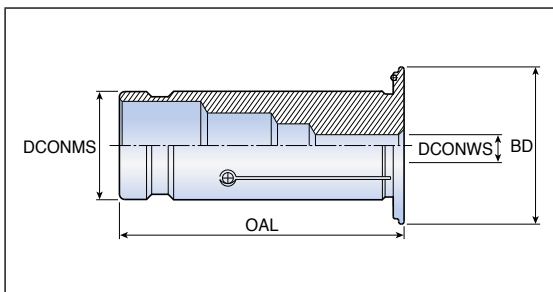

Designation	Dimension (mm)			
	DCONMS	DCONWS	BD	OAL
THC C12-3	12	3	19	47.0
C12-4	12	4	19	47.0
C12-5	12	5	19	47.0
C12-6	12	6	19	47.0
C12-7	12	7	19	47.0
C12-8	12	8	19	47.0
C20-3	20	3	29	52.5
C20-4	20	4	29	52.5
C20-5	20	5	29	52.5
C20-6	20	6	29	52.5
C20-7	20	7	29	52.5
C20-8	20	8	29	52.5
C20-9	20	9	29	52.5
C20-10	20	10	29	52.5
C20-11	20	11	29	52.5
C20-12	20	12	29	52.5
C20-13	20	13	29	52.5
C20-14	20	14	29	52.5
C20-15	20	15	29	52.5
C20-16	20	16	29	52.5
C20-17	20	17	29	52.5
C32-6	32	6	39	63.5
C32-8	32	8	39	63.5
C32-10	32	10	39	63.5
C32-12	32	12	39	63.5
C32-14	32	14	39	63.5
C32-16	32	16	39	63.5
C32-18	32	18	39	63.5
C32-20	32	20	39	63.5
C32-25	32	25	39	63.5

NCSR

Straight collets for milling chucks: general type

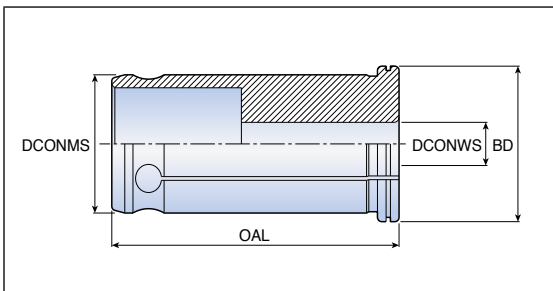

Designation	Dimension (mm)			
	DCONMS	DCONWS	BD	OAL
NCSR 20-6	20	6	25	55
20-8	20	8	25	55
20-10	20	10	25	55
20-12	20	12	25	55
20-16	20	16	25	55
25-6	25	6	29	59
25-8	25	8	29	59
25-10	25	10	29	59
25-12	25	12	29	59
25-16	25	16	29	59
25-20	25	20	29	59
32-6	32	6	36	65
32-8	32	8	36	65
32-10	32	10	36	65
32-12	32	12	36	65
32-16	32	16	36	65
32-20	32	20	36	65
32-25	32	25	36	65
42-6	42	6	45	70
42-8	42	8	45	70
42-10	42	10	45	70
42-12	42	12	45	70
42-16	42	16	45	70
42-20	42	20	45	70
42-25	42	25	45	70
42-32	42	32	45	70

NCSR-C

Straight collets for milling chucks: internal coolant type

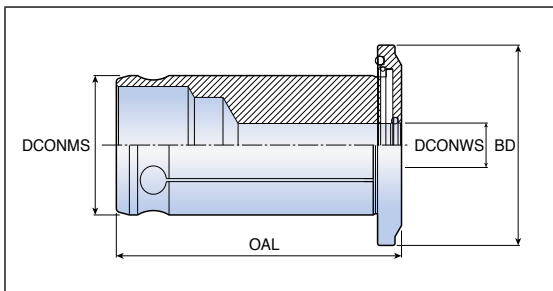

Designation	Dimension (mm)			
	DCONMS	DCONWS	BD	OAL
NCSR 20-6C	20	6	34.4	55
20-8C	20	8	34.4	55
20-10C	20	10	34.4	55
20-12C	20	12	34.4	55
20-16C	20	16	34.4	55
25-6C	25	6	39.4	59
25-8C	25	8	39.4	59
25-10C	25	10	39.4	59
25-12C	25	12	39.4	59
25-16C	25	16	39.4	59
25-20C	25	20	39.4	59
32-6C	32	6	46	65
32-8C	32	8	46	65
32-10C	32	10	46	65
32-12C	32	12	46	65
32-16C	32	16	46	65
32-20C	32	20	46	65

NCMR

Collet for milling chucks - Morse taper adapter for milling chuck



NCMR type

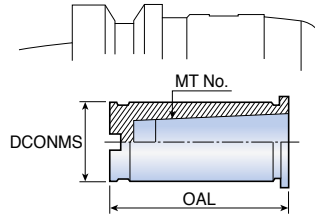

Designation	MT No.	Dimension (mm)		Application chuck
		DCONMS	OAL	
NCMR 32-1	1	32	60	NTMC 32
32-2	2	32	72	NTMC 32
32-3	3	32	90	NTMC 32
42-1	1	42	60	NTMC 42
42-2	2	42	72	NTMC 42
42-3	3	42	90	NTMC 42
42-4	4	42	113	NTMC 42

CJA

Collet for milling chucks - Jacobs taper adapter for milling chuck



CJA type

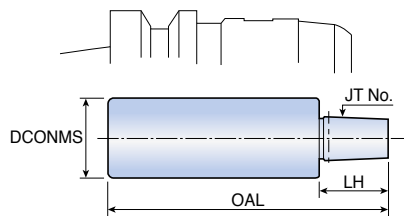

Designation	JT No.	Dimension (mm)			Application chuck
		DCONMS	OAL	LH	
CJA 32-6	6	32	118	28	NTMC 32
42-6	6	42	128	28	NTMC 42

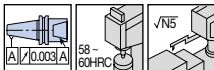
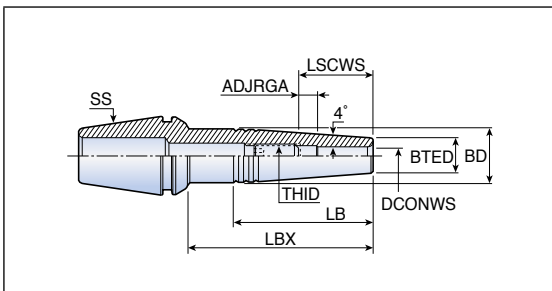

Designation	Dimension (mm)									
	SS	DCONWS	BTED	BD	LBX	LB	ADJRGA	LSCWS	THID	Hex key
ER11 SRK 3x10⁽¹⁾	ER11	3	7.6	8.5	10	-	-	10	-	-
SRK 3x25⁽¹⁾	ER11	3	7.6	8.5	25	-	-	10	-	-
SRK 4x10⁽¹⁾	ER11	4	7.6	8.5	10	-	-	12	-	-
SRK 4x25⁽¹⁾	ER11	4	7.6	8.5	25	-	-	12	-	-
ER20 SRK 3x35	ER20	3	10	13.5	35	24.5	6	16	M6	3.0
SRK 3x60	ER20	3	10	13.5	60	24.5	6	16	M6	3.0
SRK 4x35	ER20	4	10	13.5	35	24.5	6	18	M6	3.0
SRK 4x60	ER20	4	10	13.5	60	24.5	6	18	M6	3.0
SRK 5x35	ER20	5	10	13.5	35	24.5	6	21	M6	3.0
SRK 5x60	ER20	5	10	13.5	60	24.5	6	21	M6	3.0
SRK 6x35	ER20	6	11	13.5	35	25.5	6	24	M8	4.0
SRK 6x60	ER20	6	11	13.5	60	29.5	6	24	M8	4.0
ER25 SRK 3x35	ER25	3	10	13.5	35	24.5	6	16	M6	3.0
SRK 3x60	ER25	3	10	16.3	60	44.5	6	16	M6	3.0
SRK 4x35	ER25	4	10	13.5	35	24.5	6	18	M6	3.0
SRK 4x60	ER25	4	10	16.3	60	44.5	6	18	M6	3.0
SRK 5x35	ER25	5	10	13.5	35	24.5	6	21	M6	3.0
SRK 5x60	ER25	5	10	16.3	60	44.5	6	21	M6	3.0
SRK 6x35	ER25	6	11	14.7	35	26.0	6	24	M8	4.0
SRK 6x60	ER25	6	11	17.3	60	44.5	6	24	M8	4.0
SRK 8x35	ER25	8	14	17.8	35	26.5	5	30	M10	5.0
SRK 8x60	ER25	8	14	17.9	60	39.5	6	31	M10	5.0

► ⁽¹⁾ To be used only for TYPHOON spindles

ER-SRK



T-SHRINK ER collets DIN6499

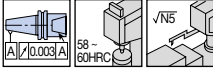
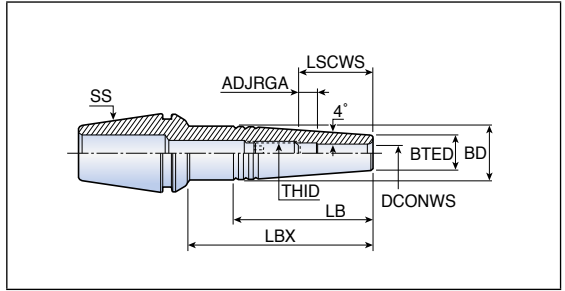

Designation	Dimension (mm)									
	SS	DCONWS	BTED	BD	LBX	LB	ADJRGA	LSCWS	THID	Hex key
ER32 SRK 3x35	ER32	3	10	13.5	35	22.5	6	16	M6	3.0
SRK 3x60	ER32	3	10	16.3	60	44.5	6	16	M6	3.0
SRK 3x85	ER32	3	10	19.8	85	70.0	6	16	M6	3.0
SRK 4x35	ER32	4	10	13.5	35	23.5	6	18	M6	3.0
SRK 4x60	ER32	4	10	16.3	60	44.5	6	18	M6	3.0
SRK 4x85	ER32	4	10	19.8	85	70.0	6	18	M6	3.0
SRK 5x35	ER32	5	10	13.5	35	24.5	6	21	M6	3.0
SRK 5x60	ER32	5	10	16.3	60	44.5	6	21	M6	3.0
SRK 5x85	ER32	5	10	19.8	85	70.0	6	21	M6	3.0
SRK 6x35	ER32	6	11	14.7	35	25.5	6	24	M8	4.0
SRK 6x60	ER32	6	11	17.3	60	45.0	6	24	M8	4.0
SRK 6x85	ER32	6	11	20.8	85	69.5	8	26	M8	4.0
SRK 8x35	ER32	8	14	18.9	35	33.0	6	31	M10	5.0
SRK 8x60	ER32	8	14	20.4	60	45.0	6	31	M10	5.0
SRK 8x85	ER32	8	14	23.2	85	65.0	6	31	M10	5.0
SRK 10x35	ER32	10	16	20.8	35	34.0	5	35	M12	6.0
SRK 10x60	ER32	10	16	22.4	60	44.5	6	36	M12	6.0
SRK 10x85	ER32	10	16	23.0	85	49.5	6	36	M12	6.0
SRK 12x35	ER32	12	20	24.0	35	28.0	-	-	-	-
SRK 12x60	ER32	12	20	24.0	60	28.0	6	38	M14	6.0
SRK 12x85	ER32	12	20	24.0	85	28.0	6	38	M14	6.0

ER-SRK-JET2



T-SHRINK ER collets DIN6499

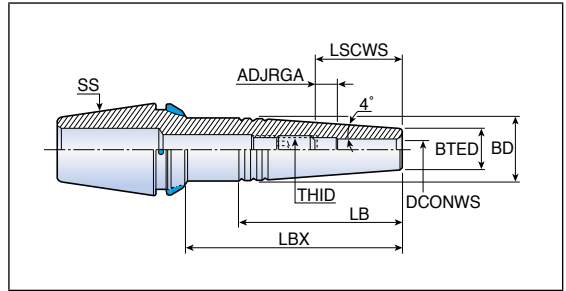

Designation	Dimension (mm)										
	SS	DCONWS	BTED	BD	LBX	LB	ADJRGA	LSCWS	THID	Hex key	
ER20 SRK 3x35 JET2	ER20	3	10	13.5	35	24.5	6	16	M6	3.0	
SRK 4x35 JET2	ER20	4	10	13.5	35	24.5	6	18	M6	3.0	
SRK 5x35 JET2	ER20	5	10	13.5	35	24.5	6	21	M6	3.0	
SRK 6x35 JET2	ER20	6	11	13.5	35	25.5	6	24	M8	4.0	
ER25 SRK 3x35 JET2	ER25	3	10	13.5	35	24.5	6	16	M6	3.0	
SRK 3x60 JET2	ER25	3	10	16.3	60	44.5	6	16	M6	3.0	
SRK 4x35 JET2	ER25	4	10	13.5	35	24.5	6	18	M6	3.0	
SRK 4x60 JET2	ER25	4	10	16.3	60	44.5	6	18	M6	3.0	
SRK 5x35 JET2	ER25	5	10	13.5	35	24.5	6	21	M6	3.0	
SRK 5x60 JET2	ER25	5	10	16.3	60	44.5	6	21	M6	3.0	
SRK 6x35 JET2	ER25	6	11	14.7	35	26.0	6	24	M8	4.0	
SRK 6x60 JET2	ER25	6	11	17.3	60	44.5	6	24	M8	4.0	
SRK 8x35 JET2	ER25	8	14	17.8	35	26.5	5	30	M10	5.0	
SRK 8x60 JET2	ER25	8	14	17.9	60	39.5	6	31	M10	5.0	
ER32 SRK 3x35 JET2	ER32	3	10	13.5	35	22.5	6	16	M6	3.0	
SRK 3x60 JET2	ER32	3	10	16.3	60	44.5	6	16	M6	3.0	
SRK 3x85 JET2	ER32	3	10	19.8	85	70.0	6	16	M6	3.0	
SRK 4x35 JET2	ER32	4	10	13.5	35	23.5	6	18	M6	3.0	
SRK 4x60 JET2	ER32	4	10	16.3	60	44.5	6	18	M6	3.0	
SRK 4x85 JET2	ER32	4	10	19.8	85	70.0	6	18	M6	3.0	
SRK 5x35 JET2	ER32	5	10	13.5	35	24.5	6	21	M6	3.0	
SRK 5x60 JET2	ER32	5	10	16.3	60	44.5	6	21	M6	3.0	
SRK 5x85 JET2	ER32	5	10	19.8	85	70.0	6	21	M6	3.0	
SRK 6x35 JET2	ER32	6	11	14.7	35	25.5	6	24	M8	4.0	
SRK 6x60 JET2	ER32	6	11	17.3	60	45.0	6	24	M8	4.0	
SRK 6x85 JET2	ER32	6	11	20.8	85	69.5	8	26	M8	4.0	
SRK 8x35 JET2	ER32	8	14	18.8	35	33.0	6	31	M10	5.0	
SRK 8x60 JET2	ER32	8	14	20.4	60	45.0	6	31	M10	5.0	
SRK 8x85 JET2	ER32	8	14	23.2	85	65.0	6	31	M10	5.0	
SRK 10x35 JET2	ER32	10	16	20.8	35	34.0	5	35	M12	6.0	
SRK 10x60 JET2	ER32	10	16	22.4	60	44.5	6	36	M12	6.0	
SRK 10x85 JET2	ER32	10	16	23.0	85	49.5	6	36	M12	6.0	
SRK 12x35 JET2	ER32	12	20	24.0	35	28.0	-	-	-	-	
SRK 12x60 JET2	ER32	12	20	24.0	60	28.0	6	38	M14	6.0	
SRK 12x85 JET2	ER32	12	20	24.0	85	28.0	6	38	M14	6.0	

ER-ODP



T-FLEXTEC holder

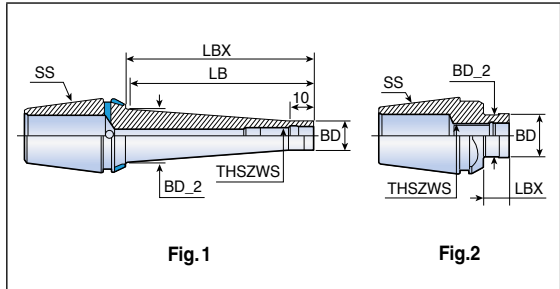
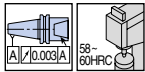

Fig.1

Fig.2

Designation	Dimension (mm)							Fig
	SS	THSZWS	BD	BD_2	LB	LBX		
ER 25 ODP M12x10	ER25	M12	20.0	20.0	10	10.0	2	
32 ODP M12x10	ER32	M12	10.0	10.0	21	20.6	2	
32 ODP M12x25	ER32	M12	24.0	25.0	21	24.0	1	

GTIN ER

GTIN ER collets

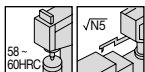
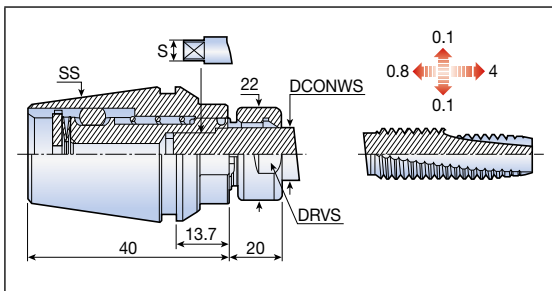

GTIN ER 32 - DIN 371 / 352

Designation	Dimension (mm)					
	SS	DCONWS	Tap _{min}	Tap _{max}	S	DRVS
GTIN ER32 DIN 2.50x2.10	ER32	2.5	M1	M1.8	2.1	20
DIN 2.80x2.10	ER32	2.8	M2	M4	2.1	20
DIN 3.50x2.70	ER32	3.5	M3	M5	2.7	20
DIN 4.00x3.00	ER32	4.0	M3.5	M3.5	3.0	20
DIN 4.50x3.40	ER32	4.5	M4	M6	3.4	20
DIN 6.00x4.90	ER32	6.0	M5	M8	4.9	20
DIN 7.00x5.50	ER32	7.0	M7	M10	5.5	20
DIN 8.00x6.20	ER32	8.0	M8	M8	6.2	20
DIN 9.00x7.00	ER32	9.0	M12	M12	7.0	20
DIN 10.00x8.00	ER32	10.0	M10	M10	8.0	20
DIN 11.00x9.00	ER32	11.0	M14	M14	9.0	20
DIN 12.00x9.00	ER32	12.0	M16	M16	9.0	20

GTIN ER 32 - JIS

Designation	Dimension (mm)					
	SS	DCONWS	Tap _{min}	Tap _{max}	S	DRVS
GTIN ER32 JIS 3.00x2.50	ER32	3.0	M1	M2.6	2.5	20
JIS 4.00x3.20	ER32	4.0	M3	M3.5	3.2	20
JIS 5.00x4.00	ER32	5.0	M4	M4	4.0	20
JIS 6.00x4.50	ER32	6.0	M6	M6	4.5	20
JIS 6.20x5.00	ER32	6.2	M8	M8	5.0	20
JIS 7.00x5.50	ER32	7.0	M10	M10	5.5	20
JIS 8.50x6.50	ER32	8.5	M12	M12	6.5	20
JIS 10.50x8.00	ER32	10.5	M14	M14	8.0	20
JIS 12.50x10.00	ER32	12.5	M16	M16	10.0	20

► No coolant should be induced through the tap collet, as it will cause malfunctioning of the mechanism

GTIN ER

GTIN ER collets

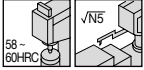
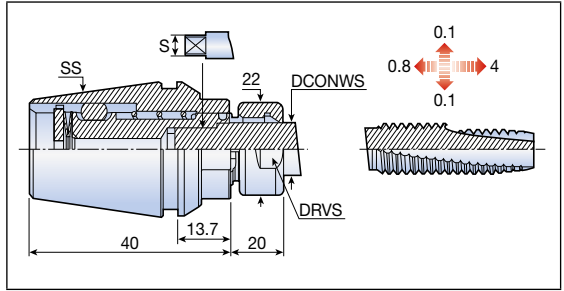

GTIN ER32 - ISO metric ISO 529/2283

Designation	Dimension (mm)					
	SS	DCONWS	Tap _{min}	Tap _{max}	S	DRVS
GTIN ER32 ISO 2.24x1.80	ER32	2.24	M3	M3	1.80	20
ISO 2.50x2.00	ER32	2.50	M3.5	M3.5	2.00	20
ISO 2.80x2.24	ER32	2.80	M2.2	M2.5	2.24	20
ISO 3.15x2.50	ER32	3.15	M3	M4	2.50	20
ISO 3.55x2.80	ER32	3.55	M3.5	M4.5	2.80	20
ISO 4.00x3.15	ER32	4.00	M4	M5	3.15	20
ISO 4.50x3.55	ER32	4.50	M6	M6	3.55	20
ISO 5.00x4.00	ER32	5.00	M5	M5	4.00	20
ISO 5.60x4.50	ER32	5.60	UNC#12-24	UNC (ONLY)	4.50	20
ISO 6.30x5.00	ER32	6.30	M6	M8	5.00	20
ISO 7.10x5.60	ER32	7.10	UNC#3/8-16	UNC (ONLY)	5.60	20
ISO 8.00x6.30	ER32	8.00	M8	M10	6.30	20
ISO 9.00x7.10	ER32	9.00	M12	M12	7.10	20
ISO 10.00x8.00	ER32	10.00	M10	M10	8.00	20
ISO 11.20x9.00	ER32	11.20	M14	M14	9.00	20
ISO 12.50x10.00	ER32	12.50	M16	M16	10.00	20

► No coolant should be induced through the tap collet, as it will cause malfunctioning of the mechanism

TA (For JIS)

Tap adapters

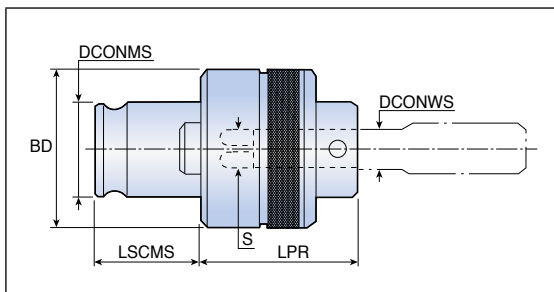

Designation	Dimension (mm)					
	DCONMS	DCONWS	BD	LPR	LSCMS	S
TA 1-M3	19	4.0	32	25	21.5	3.2
1-M4	19	5.0	32	25	21.5	4.0
1-M5	19	5.5	32	25	21.5	4.5
1-M6	19	6.0	32	25	21.5	4.5
1-M8	19	6.2	32	25	21.5	5.0
1-M10	19	7.0	32	25	21.5	5.5
1-M12	19	8.5	32	25	21.5	6.5
2-M6	31	6.0	50	33	35.5	4.5
2-M8	31	6.2	50	33	35.5	5.0
2-M10	31	7.0	50	33	35.5	5.5
2-M12	31	8.5	50	33	35.5	6.5
2-M14	31	10.5	50	33	35.5	8.0
2-M16	31	12.5	50	33	35.5	10.0
2-M18	31	14.0	50	33	35.5	11.0
2-M20	31	15.0	50	33	35.5	12.0
2-M22	31	17.0	50	33	35.5	13.0
2-M24	31	19.0	50	33	35.5	15.0
3-M18	48	14.0	72	45	55.5	11.0
3-M20	48	15.0	72	45	55.5	12.0
3-M22	48	17.0	72	45	55.5	13.0
3-M24	48	19.0	72	45	55.5	15.0
3-M27	48	20.0	72	45	55.5	15.0
3-M30	48	23.0	72	45	55.5	17.0
3-M33	48	25.0	72	45	55.5	19.0
3-M36	48	28.0	72	45	55.5	19.0
3-M38	48	28.0	72	45	55.5	21.0

► Based on JIS standard tap

Accessories



NUT ER TOP

ER - Top™ clamping nuts

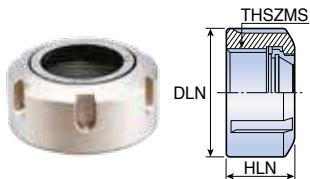

Designation	Dimension (mm)		
	DLN	HLN	THSZMS
NUT ER16 TOP	28	17	M22x1.5
ER20 TOP	34	19	M25x1.5
ER25 TOP	42	20	M32x1.5
ER32 TOP	50	22	M40x1.5
ER40 TOP	63	25	M50x1.5

NUT ER MINI/UM

ER clamping nuts

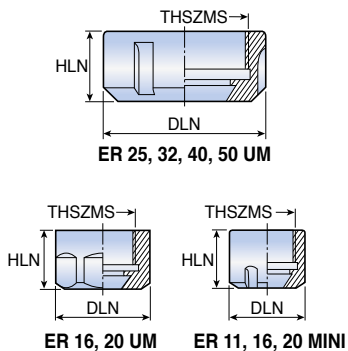

Designation	Dimension (mm)		
	DLN	HLN	THSZMS
NUT ER11 MINI	16	10.8	M13x0.75
ER11 UM	19	11.3	M14x0.75
ER16 MINI	22	18.0	M19x1.0
ER16 UM	28	17.0	M22x1.5
ER20 MINI	28	19.0	M24x1.0
ER20 UM	34	19.0	M25x1.5
ER25 MINI	35	20.0	M30x1.5
ER25 UM	42	20.0	M32x1.5
ER32 UM	50	22.0	M40x1.5
ER40 UM	63	25.0	M50x1.5
ER50 UM	78	55.0	M64x2.0

NUT ER11 GHS

Tightening nuts

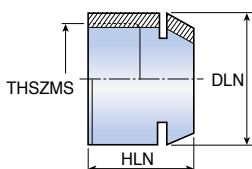

Designation	Dimension (mm)			
	DLN	HLN	THSZMS	Wrench
NUT ER11 GHS	16	11.5	M13x0.75	WRENCH ER11 SMS

NUT ER SHORT

T-SHORT nuts

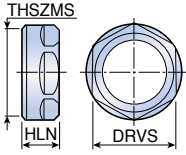
		Designation	Dimension (mm)		
			DRVS	HLN	THSZMS
		NUT ER20 SHORT	22	10.7	M25x1.5
		ER32 SHORT	36	15.0	M40x1.5
ER40 SHORT	46	16.0	M50x1.5		

TSKN

TSK clamping nuts

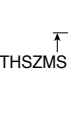
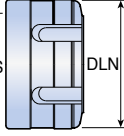
 <p>Fig.1</p>	 <p>Fig.2</p>	Designation	Dimension (mm)		Fig.
			DLN	THSZMS	
		TSKN 6	20	M15x1.0	1
		10	28	M21.5x1.0	1
		16	40	M32x1.5	2
25	55	M45x1.5	2		

PS SK-DIN

Pull studs DIN69872 with JIS63398 retention knob

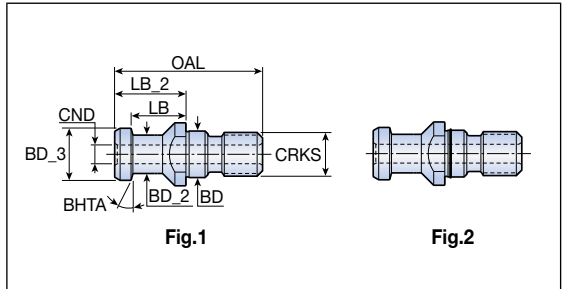
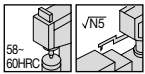

Designation	Dimension (mm)									Fig.
	CRKS	BD	BD_2	BD_3	CND	LB	LB_2	OAL	BHTA	
PS SK30 15 M12 DIN	M12	13	9.0	13.00	-	19.00	24.00	44.0	15	1
PS SK40 15 M16 DIN	M16	17	14.0	19.00	-	20.00	26.00	54.0	15	1
15 M16 DIN O	M16	17	14.0	19.00	-	20.00	26.00	54.0	15	2
15 M16 DIN B	M16	17	14.0	19.00	7.00	20.00	26.00	54.0	15	1
15 M16 DIN OB	M16	17	14.0	19.00	7.00	20.00	26.00	54.0	15	2
PS SK50 15 M24 DIN	M24	25	21.0	28.00	-	25.00	34.00	74.0	15	1
15 M24 DIN O	M24	25	21.0	28.00	-	25.00	34.00	74.0	15	2
15 M24 DIN B	M24	25	21.0	28.00	11.50	25.00	34.00	74.0	15	1

- ▶ Coolant holes only in items with a "B" suffix
- ▶ Fig. 2: With external O-ring

PS OTT BT/SK

Pull studs OTT system

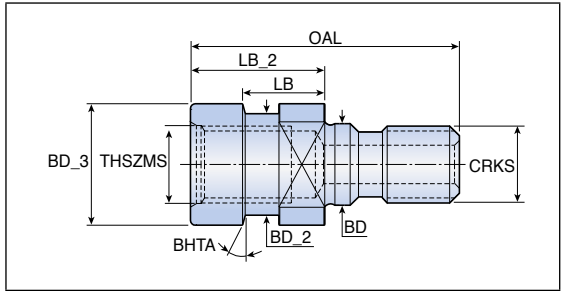

Designation	Dimension (mm)								
	CRKS	THSZMS	BD	BD_2	BD_3	LB	LB_2	OAL	BHTA
PS OTT BT40 M16	M16	M16	17	21.1	25.0	16.60	28	56	15
BT50 M24	M24	M24	24	32.0	39.3	13.35	25	65	15
SK40 M16	M16	M16	17	21.1	25.0	13.60	25	53	15

PS BT-JIS/MAZAK

Pull studs BT-JIS 63398 / ANSI-metric for MAZAK machine

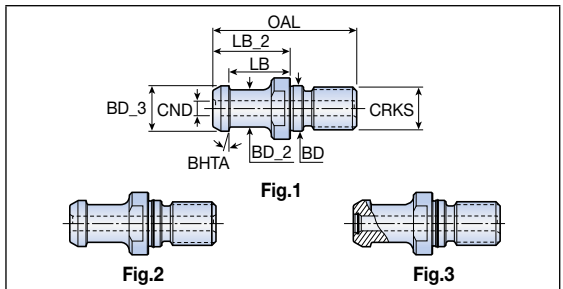

Designation	Dimension (mm)									Fig.
	CRKS	BD	BD_2	BD_3	CND	LB	LB_2	OAL	BHTA	
PS BT30 15 M12 JIS B	M12	13	8.00	12.00	4.0	18.40	23.4	43.0	15	1
BT40 15 M16 JIS B	M16	17	14.00	19.00	5.5	23.00	29.0	54.0	15	1
BT40 15 M16 JIS O B	M16	17	14.00	19.00	5.5	23.00	29.0	54.0	15	2
BT40 15 M16 JIS O B O	M16	17	14.00	19.00	5.5	23.00	29.0	54.0	15	3
BT50 15 M24 JIS B	M24	25	21.00	28.00	8.0	25.00	34.0	74.0	15	1
BT50 15 M24 JIS O B	M24	25	21.00	28.00	8.0	25.00	34.0	74.0	15	2
BT40 45 M16 MAZAK B	M16	17	12.45	18.79	7.0	14.02	19.1	44.1	45	1
BT50 45 M24 MAZAK B	M24	25	20.83	28.95	8.0	17.58	25.2	65.2	45	1

- ▶ Fig. 1: Coolant holes only in items with a "B" suffix
- ▶ Fig. 2: With external O-ring and coolant hole
- ▶ Fig. 3: With external and internal O-rings and coolant hole

PS BT-MAS

Pull studs BT-MAS-metric

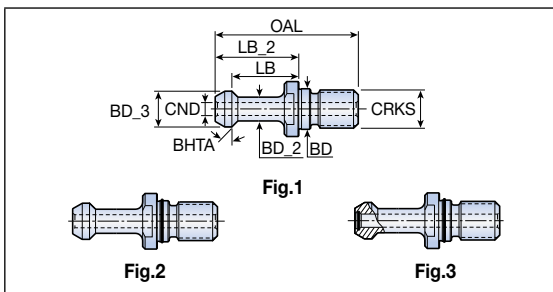

Designation	Dimension (mm)										Fig.
	CRKS	BD	BD_2	BD_3	CND	LB	LB_2	OAL	BHTA		
PS BT30 45 M12 MAS1	M12	12.5	7	11	-	18	23	43	45	1	
45 M12 MAS1 B	M12	12.5	7	11	3.0	18	23	43	45	1	
60 M12 MAS2	M12	12.5	7	11	-	18	23	43	30	1	
PS BT40 45 M16 MAS1	M16	17.0	10	15	-	28	35	60	45	1	
45 M16 MAS1 B	M16	17.0	10	15	5.5	28	35	60	45	1	
60 M16 MAS2	M16	17.0	10	15	-	28	35	60	30	1	
60 M16 MAS2 B	M16	17.0	10	15	5.5	28	35	60	30	1	
90 M16 MAS3	M16	17.0	10	15	-	28	35	60	90	1	
90 M16 MAS3 B	M16	17.0	10	15	5.5	28	35	60	90	1	
PS BT50 45 M24 MAS1	M24	25.0	17	23	-	35	45	85	45	1	
45 M24 MAS1 B	M24	25.0	17	23	6.0	35	45	85	45	1	
45 M24 MAS1 O B	M24	25.0	17	23	6.0	35	45	85	45	2	
45 M24 MAS1 O B O	M24	25.0	17	23	6.0	35	45	85	45	3	
60 M24 MAS2	M24	25.0	17	23	-	35	45	85	30	1	
60 M24 MAS2 B	M24	25.0	17	23	6.0	35	45	85	30	1	
90 M24 MAS3	M24	25.0	17	23	-	35	45	85	90	1	
90 M24 MAS3 B	M24	25.0	17	23	6.0	35	45	85	90	1	

- ▶ Fig. 1: Coolant holes only in items with a "B" suffix
- ▶ Fig. 2: With external O-ring and coolant hole
- ▶ Fig. 3: With external and internal O-rings and coolant hole

SR-DIN

Lock screw DIN1835 B/E for end mill holders

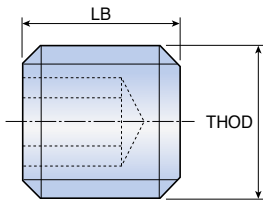

Designation	Dimension (mm)		
	THOD	LB	Used for shanks
SR M6x10 DIN 1835-B	M6	10	6
M8x10 DIN 1835-B	M8	10	8
M10x12 DIN 1835-B	M10	12	10
M12x16 DIN 1835-B	M12	16	12, 14
M14x16 DIN 1835-B	M14	16	16
M16x16 DIN 1835-B	M16	16	20
M18x2x20 DIN 1835-B	M18x2	20	25
M20x2x20 DIN 1835-B	M20x2	20	32, 40
M24x2x25 DIN 1835-B	M24x2	25	50

PRESET ER-JET

Preset screw with oil hole for ER collets

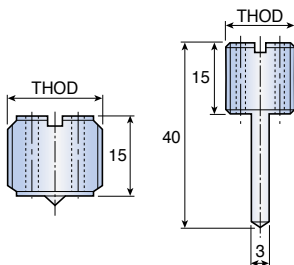

Fig.1

Fig.2

Designation	Dimension (mm)	Fig.
	THOD	
PRESET ER-JET 8x1.25	M8x1.25	1
10x1.5	M10x1.5	1
12x1.75	M12x1.75	1
12x1.75L	M12x1.75	2
16x2	M16x2	1
16x2L	M16x2	2
18x1.5	M18x1.5	1
18x1.5L	M18x1.5	2
22x1.5	M22x1.5	1
22x1.5L	M22x1.5	2
28x1.5	M28x1.5	1

M-CLAMP SCREW SEM

Lock screw DIN6367 for face mill arbors

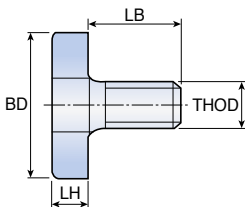

Designation	Dimension (mm)				
	S.M.C	THOD	BD	LH	LB
M8 CLAMP SCREW SEM 16	16	M8	20	6	16
M10 CLAMP SCREW SEM 22	22	M10	28	7	18
M12 CLAMP SCREW SEM 27	27	M12	35	8	22
M16 CLAMP SCREW SEM 32	32	M16	42	9	26
M20 CLAMP SCREW SEM 40	40	M20	52	10	30
M24 CLAMP SCREW SEM 50	50	M24	63	12	36

MBA M

Lock screw for FMA

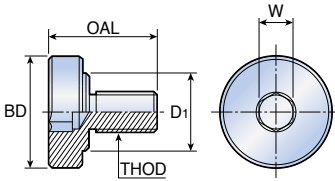

Designation	Dimension (mm)				
	THOD	BD	D1	OAL	W
MBA M8	M8x1.25	20	15	24	6
M10	M10x1.5	28	18	28	8
M12	M12x1.75	33	23	32	10
M16	M16x2.0	40	23	40	14
M20	M20x2.5	50	27	50	17
M24	M24x3.0	65	37	60	19

► Wrench for MBA screw: L-W □□

WRENCH M-SEMC

Wrench DIN6368 for combi shell end mill holders

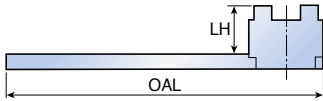

Designation	Dimension (mm)			
	DRVS	FTDZ	LH	OAL
WRENCH M8 SEMC 16	16	M8	20	180
M10 SEMC 22	22	M10	25	200
M12 SEMC 27	27	M12	32	225
M16 SEMC 32	32	M16	36	250
M20 SEMC 40	40	M20	40	280
M24 SEMC 50	50	M24	50	315

PRESET SCREW

SRKIN thermal shrink collets

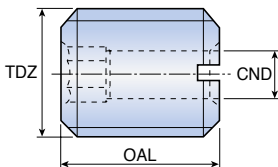

Designation	Dimension (mm)				
	TDZ	OAL	CND	Used for shanks	Hex key
PRESET SCREW M5x18 B	M5	18	2.1	EM E / SRKIN	2.5
M6x20 B	M6	20	2.5	EM E / SRKIN	3.0
M8x20 B	M8	20	3.5	EM E / SRKIN	4.0
M10x18 B	M10	18	4.5	EM E / SRKIN	5.0
M12x18 B	M12	18	5.5	EM E / SRKIN	6.0
M16x20 B	M16	20	7.5	EM E / SRKIN	6.0
M16x25 B	M16	25	7.5	SRKIN	6.0
M20x20 B	M20	20	6.0	EM E	6.0

D-RING SEMC

Driving ring DIN6366/1 for combi shell end mill holders

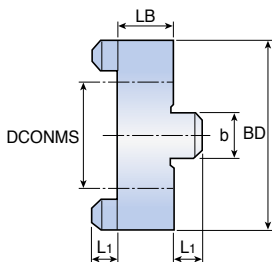

Designation	Dimension (mm)				
	DCONMS	BD	LB	b	L1
16 D · RING SEMC	16	32	10	8	5.0
22 D · RING SEMC	22	40	12	10	5.6
27 D · RING SEMC	27	48	12	12	6.3
32 D · RING SEMC	32	58	14	14	7.0
40 D · RING SEMC	40	70	14	16	8.0
50 D · RING SEMC	50	90	16	18	9.0

COOLING TUBE HSK A

HSK A cooling tube

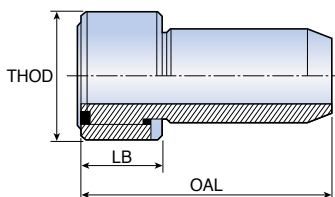

Designation	Dimension (mm)		
	OAL	LB	THOD
COOLING TUBE HSK A 50	33.0	9.5	M16x1
HSK A 63	36.5	11.5	M18x1
HSK A 80	40.0	13.5	M20x1.5
HSK A 100	44.0	15.5	M24x1.5

WRENCH COOL TUBE HSK A

HSK A cooling tube wrench

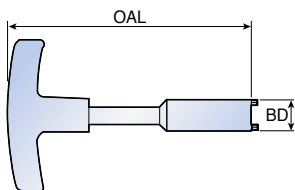

Designation	Dimension (mm)	
	BD	OAL
WRENCH COOL TUBE HSK A 50	15.0	120
HSK A 63	17.0	122
HSK A 83	18.5	186
HSK A 100	22.0	141

WRENCH ER-MINI/SHORT

ER wrench

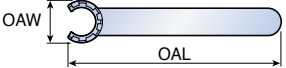
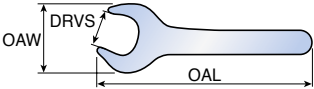
DIN6499	Designation	Dimension (mm)		
		OAW	DRVS	OAL
 <p>Wrench ER 25, 32, 40, 50</p>	WRENCH ER11 MINI	16.8	-	95
	ER11	32.0	17	95
 <p>Wrench ER 11, 16, 20, 25 MINI</p>	ER16 MINI	22.5	-	117
	ER16	42.8	25	143
 <p>Wrench ER 11, 16, 20, SHORT</p>	ER20 MINI	28.0	-	128
	ER20	53.5	30	172
	ER25 MINI	29.0	-	120
	ER25	70.0	-	207
	ER32	78.0	-	255
	ER40	95.0	-	285
	ER50	110.0	-	350
	ER32 SHORT	75.0	36	303
ER40 SHORT	94.0	46	378	

WRENCH ER11 SMS

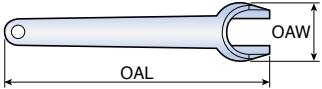

ER11 Tightening wrench

	Designation	Dimension (mm)	
		OAW	OAL
	WRENCH ER11 SMS	22	100

SPANNER TMC

NTMC milling chuck wrench

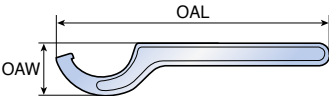
	Designation	Dimension (mm)	
		OAW	OAL
	SPANNER TMC 20	15.8	84.1
	TMC 25	18.1	94.3
	TMC 32	21.7	109.1
	TMC 42	23.2	108.0

TSKS

TSK slim chuck wrench

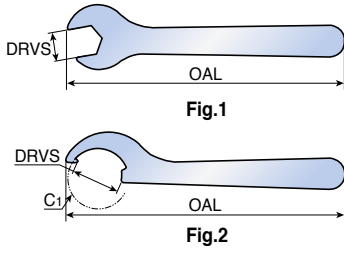

Designation	Dimension (mm)		Fig.
	DRVS	OAL	
TSKS - 6	18.0	174	1
10	25.4	177	1
16	36.0	189	2
25	52.0	228	2

TJS TSD DISPLAY



RPM speed display for TYPHOON high-speed spindles

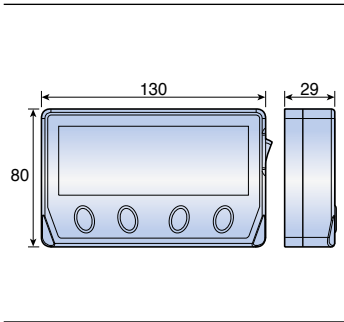

Designation	Machines
TJS TSD DISPLAY	TTS spindles

IND ER11 TOOL ADAPTER

ER 11 shrink collet adapter for induction heating device

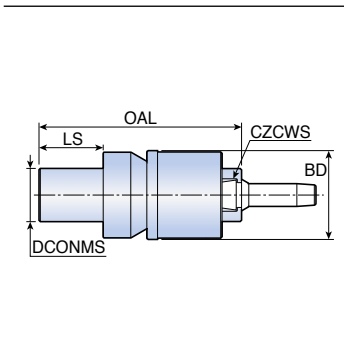

Designation	Dimension (mm)				
	C2CWS	BD	DCONMS	OAL	LS
IND ER11 TOOL ADAPTER	ER11	33.2	19.9	75.7	24

TOOL CLAMP-ROTARY/FIX

Tool clamp fixture - ISO, DIN69871, BT MAS-403

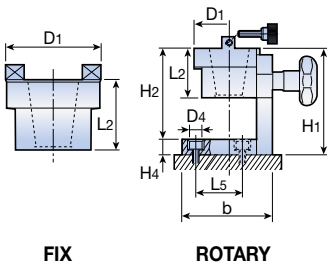

Designation	Dimension (mm)									
	CSI	b	D1	D4	L2	H1	H2	H4	L5	
TOOL CLAMP 30 ROTARY	ROTARY	104	70	12.5	56	128	109	19	40	
40 ROTARY	ROTARY	104	82	12.5	56	128	109	19	40	
50 ROTARY	ROTARY	144	103	12.5	71	170	151	19	85	
30 FIX	FIX	-	82	-	58	-	-	-	-	
40 FIX	FIX	-	82	-	58	-	-	-	-	
50 FIX	FIX	-	103	-	71	-	-	-	-	

MULTI CLAMP-A/C

Tool clamp fixture rotary - For HSK shanks

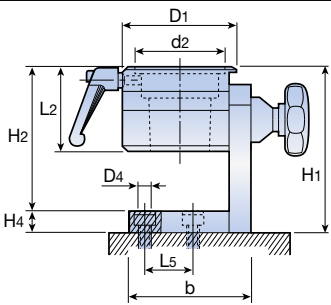

Designation	Dimension (mm)										
	CSI	b	d2	D1	D4	L2	L5	H1	H2	H4	
MULTI CLAMP 50 A/C	50	104	50	82	12.5	72	40	142	123	19	
63 A/C	63	104	63	95	12.5	72	40	142	123	19	
100 A/C	100	144	100	130	12.5	90	85	178	159	19	

MULTI CLAMP C

C-ADAPTER rotary clamp

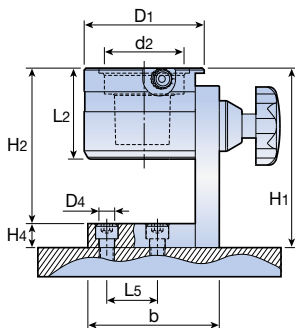

Designation	Dimension (mm)									
	SS	b	d2	D1	D4	L2	L5	H1	H2	H4
MULTI CLAMP C6	63	104	63	95	12.5	72	40	142	123	19

MULTI CLAMP...UNIVERSAL

Universal rotary tool clamping fixtures - for tapered shanks

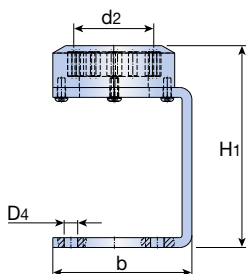

Designation	Dimension (mm)				
	CSI	d2	H1	b	D4
MULTI CLAMP 40 UNIVERSAL	40	40	161	112	11
50 UNIVERSAL	50	50	161	112	11
63 UNIVERSAL	63	63	164	113	11
80 UNIVERSAL	80	80	240	150	11
100 UNIVERSAL	100	100	240	150	11

Mounting adapters/holders (tapered types)

Designation	Dimension (mm)				
	HSK A/C/E/F	C-ADAPTER	BT	DIN69871	DIN2080
MULTI CLAMP 40 UNIVERSAL	HSK 40	C4	-	-	-
50 UNIVERSAL	HSK 50	C5	-	DIN69871 30	DIN2080 30
63 UNIVERSAL	HSK 63	C6	BT 40	DIN69871 40	DIN2080 40
80 UNIVERSAL	HSK 80	C8	-	-	-
100 UNIVERSAL	HSK 100	C10	BT 50	-	-

EASYLOCK T.C EU

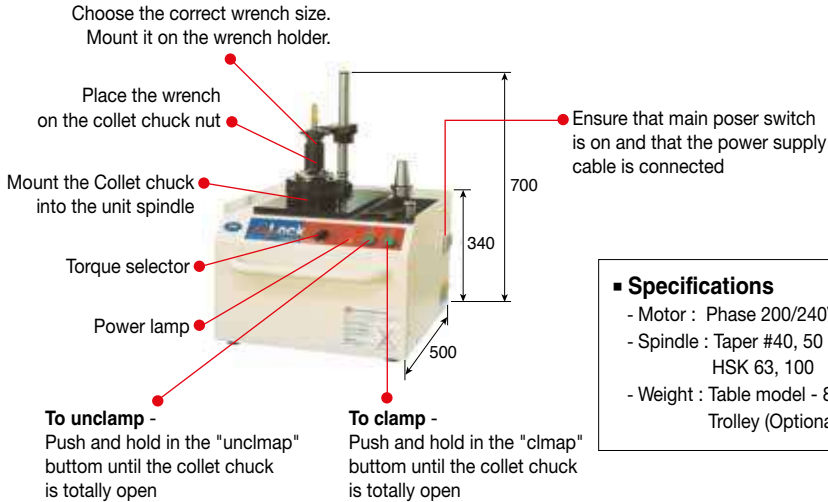

■ Specifications	
- Motor :	Phase 200/240V, 50/60HZ(1HP)
- Spindle :	Taper #40, 50 HSK 63, 100
- Weight :	Table model - 85kg Trolley (Optional) - 15kg

Note: Assemble the collet and cutting tools. By hand, place the nut onto the collet chuck.

Designation	TaeguTec No.	Accssories	
		Standard	Optional
EASYLOCK T.C EU	4651108	TP50 AD 40 EASY	EASY LOCK TROLLEY
		WRENCH ER16 EASY LOCK	TP40 AD 30 EASY
		WRENCH ER20 EASY LOCK	TP50 AD HSK 63 EASY
		WRENCH ER25 EASY LOCK	TP50 AD HSK 100 EASY
		WRENCH ER32 EASY LOCK	WRENCH ER50 EASY LOCK
		WRENCH ER40 EASY LOCK	WRENCH TG100 OPEN EASY

EASYLOCK TROLLEY

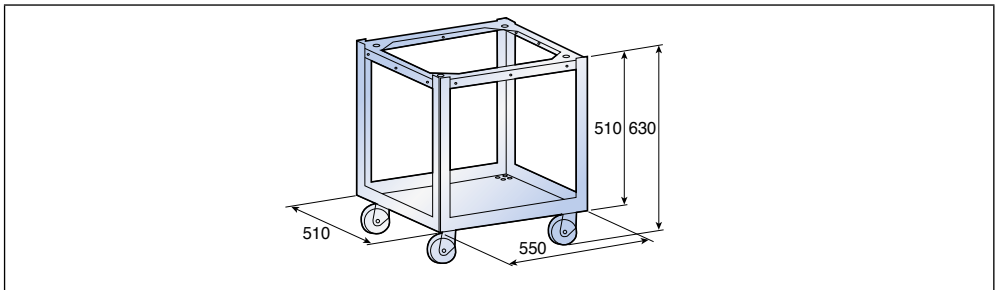

Designation	TaeguTec No.
EASYLOCK TROLLEY	4651109

IND SHRINKIN UNIT EUR



Induction heating units



Technical specifications		
Clamping range	3-32mm	Carbide tool shank
Clamping range	6-32mm	
Main power supply	3x380 - 500V 50/60Hz	
Nominal power	13kW	
Nominal current	16 AMP	
Cooling unit power supply	220V 50Hz	
Nominal power	0.5kW	
Max. tool length	440mm (From gauge line)	
Max. dia. clamping chuck	52mm	
Effective induction field length	45mm	
Expansion time	5-12 seconds	
Cooling time	50-90 seconds	
Weight	150kg	
Overall dimensions	170x73x60cm	

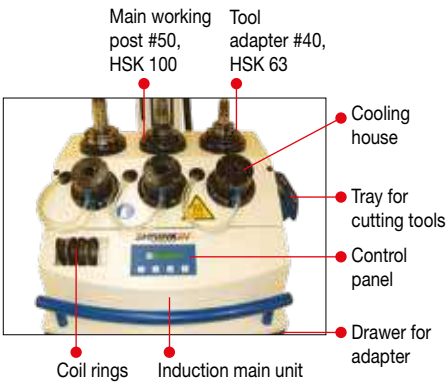

INDUCTION starter unit
4654106 IND SHRINK START UNIT EUR
• One working post without cooling unit

TaeguTec No.	Designation	Includes
4652264	IND SHRINKIN UNIT EUR	Induction unit, cooling unit, trolley, three tool adapters

Cooling sleeves	Used for
IND COOLING COLLET 6-8	SRKIN
10-12	SRKIN
14-16	SRKIN
18-20	SRKIN
ER 3-5	SRK
ER 6	SRK
ER 8	SRK
ER 10	SRK
ER 12	SRK

Optional tool adapter for HSK
IND 32 HSK TOOL ADAPTER
40 HSK TOOL ADAPTER
50 HSK TOOL ADAPTER⁽¹⁾
63 HSK TOOL ADAPTER
80 HSK TOOL ADAPTER

• ⁽¹⁾ For taper #30

Technical Data

► ER-SEAL collet

■ Application

ER collets are used for applications requiring through coolant, as well as for standard cutting tools such as drills, boring bars, end mills, reamers, taps and special tools.

They provide an effective solution for accurate controlled coolant flow.

Front sealing collets are available for advanced high speed machines with through coolant spindles/turrets. They provide maximum performance, high cutting speeds, extended tool life and high quality surface finish.

■ Features

- A revolutionary high precision front sealing collet with 1.00mm collapsibility that has through coolant capability
- Increased machining efficiency
- Extended tool life
- Has powerful gripping and parallel clamping
- Front sealing provides protection from contamination
- Fast chip removal from work piece

■ Advantages

- High-pressure coolant supply up to 100 bar
- Eliminates coolant flow interference

■ Notes

- For maximum security and clamping power, the cutting tool shank must be inserted into the collet to a minimum depth of 2 x shank diameter
- Suitable for all shank standards

► TaeguTec ER coolant sealed collet

■ Two types:



Oil hole collet: ER-SEAL

For straight shank cutting tools with internal coolant supply



JET2 collet: ER-SEAL-JET

With angular double nozzle.

Coolant flow is direct to the cutting edge
- For use with standard straight shank cutting tools (Without coolant hole)

► Shank standards

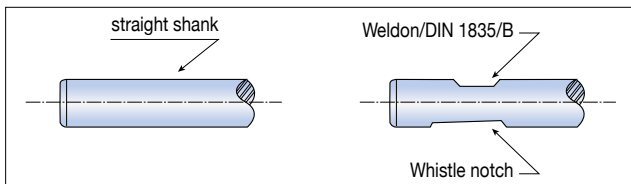

Technical Data

► ER - Top clamping nut DIN6499

■ Description

The friction ER Nut has a unique two piece exclusive friction mechanism combining radial and angular self-centering movements.

■ Features

- Unique two piece friction bearing
- Radial and angular float for better concentricity
- Powerful gripping force, 50-100% higher than standard ER nut due to the friction bearing mechanism
- Balanced for higher spindle speed due to unique extractor teeth design
- Compact design: General dimensions and size range are the same as the standard nut sealed design for use with sealed collets.

■ Operation

To insert collet: Always assemble the collet into the nut before mounting onto the collet chuck.

■ Inserting procedure

Insert the collet slantwise, fitting the two protruding extractor teeth (A) into the collet groove (B).

Place the two parts onto a clean and horizontal surface.

Press down with your thumb on the back end of the collet until it clicks into place (C).

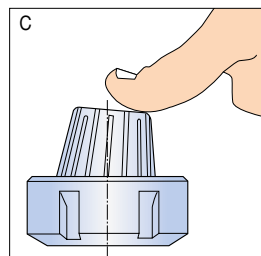
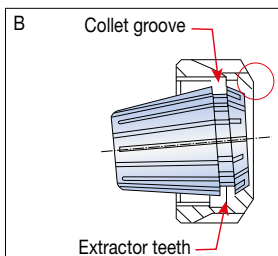
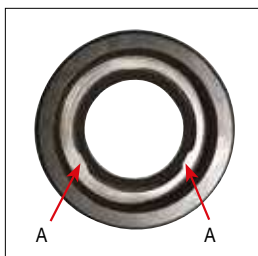

■ Important

Never insert the collet parallel to the extractor ring. This will chip or break the teeth of the extractor. When unclamping the nut, the collet will self release from the chuck by means of the extractor teeth.

Technical Data

► ER - Top clamping nut DIN6499

■ Extracting procedure

- 1 Align the diamond-shaped engraved logo which is on the silver ring (D) to any of the key slots (E) of the nut.
- 2 Place the nut with the collet facing down on a clean and horizontal work surface.
- 3 Insert a screwdriver vertically between the nut slots and the collet - on the reverse side of the diamond shaped engraved logo (D).
- 4 Tilt the screwdriver outwards while helping the extraction by pushing the back of the collet in the opposite direction (F).

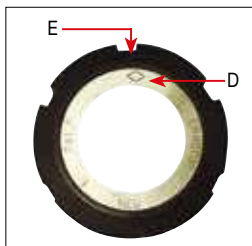

Note:

For maximum performance the clamping nut thread and collet taper must be cleaned and oiled before use.

Recommended clamping torque for standard ER & ER-Top clamping nut.

Nut type	Kg x m
ER-11	5
ER-11M	3
ER-16	7
ER-16M	4
ER-20	12
ER-20M	8
ER-25	20
ER-32	22
ER-40	25
ER-50	35

Important:

The torque is calculated to suit the maximum diameter capacity of each collet. The torque should be gradually reduced when used with a smaller shank size.

Technical Data

▶ TSK slim collet chuck

■ Features & advantages

- Excellent accuracy & good gripping power by gentle taper angle (ER collet : 8°, TSK collet : 4°)
- Slim design for deep and cavity machining
- Suitable on high speed machining
- Variety of TSK collets (Normal & coolant type)
- General machining using drill & end mill

■ Application

- General machining using drill & end mill
- High speed machining for mold & die industry
- Accurate machining using reamer & end mill

■ How to assemble the collet with a nut



a. Assembly device
(Optional, sold separately)



b. Nut



c. Collet

❶ Insert the back end of the collet (c) into the assembly device (a)



❷ Insert the combined part (a+c) in the nut (b)



❸ Pluck out the assembly device (a) from the remaining part (b+c)



a. Assembly device

Designation

TSK 06, TSK 10, TSK 16, TSK 25

Technical Data

► HSK (DIN69893) system

■ Features

- DIN standard
- For high speed machining
- Size: #32, 40, 50, 63, 100
- For A.T.C. & manual machine
- Double face contact
- High stiffness

► Radial stiffness of different machine tool interface

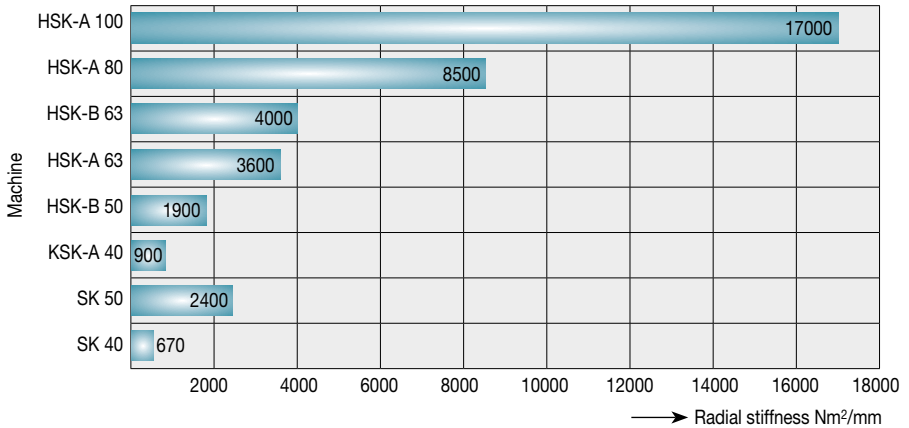

► Type

■ A type: Automatic tool change

■ B type: With coolant through face

■ C type: Manual clamp

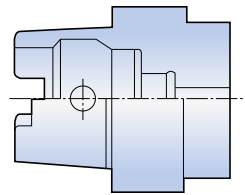
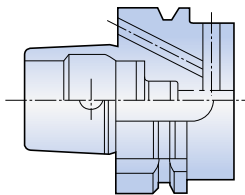
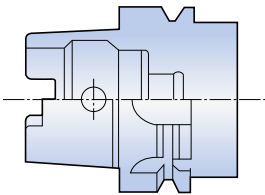

■ D type: With coolant through face

■ E type: Super high speed

■ F type: Ultra high speed

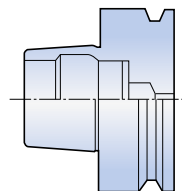
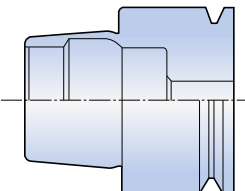
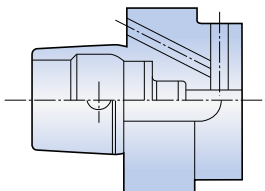

Technical Data

► Milling chuck

- Exceptional gripping power and simple operation

- Torque

Type	Torque (kgf·m)
NTMC 25	180
NTMC 32	360
NTMC 42	520

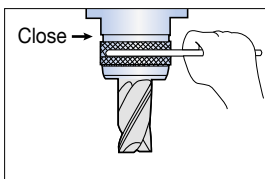
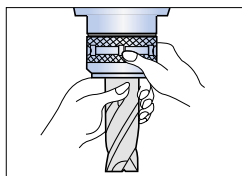

Tighten slightly when collar is close to body (Avoid hammering)

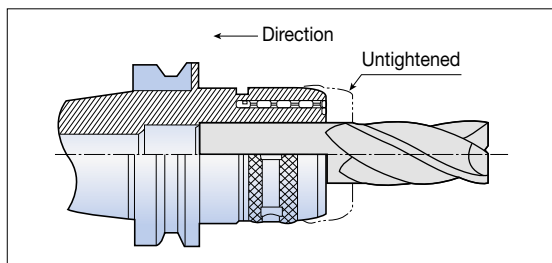

- Improved accuracy prolongs tool life

The accuracy and low runout has been achieved by utilizing precise grinding and spiral laser slitting to avoid damage and tool distortion.

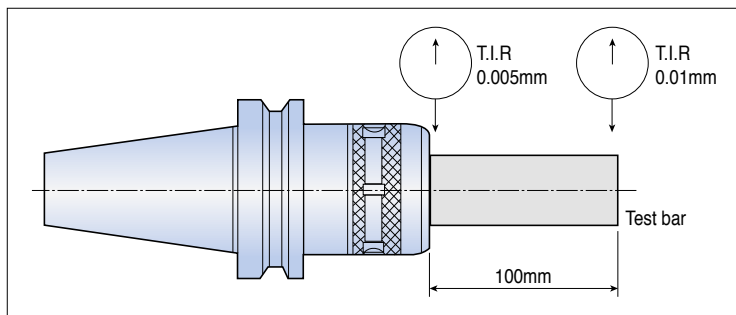

► Hydraulic chuck

■ Features & advantages

- Consistent gripping force
- Excellent accuracy (Run-out : within $5\mu\text{m}$)
- Convenient and safe tool change using a clamping screw
- Can use THC straight collets (Normal & coolant type)

■ Application

- Accurate machining
 - a) Fine milling, reaming, fine boring
- Drilling: Small diameter using carbide drill
 - a) For Al or Cast iron

■ Operation

- Tool mounting
 - a) Insert the tool shank between L_{max} and L_{min} (Fig 1.) and then, turn the clamping screw clockwise until it can no longer rotate.
- Tool releasing
 - a) To release the tool from the hydraulic chuck, turn the clamping screw in a counter clock-wise direction approximately 5 or 6 evolutions and remove the tool shank.

- Notice

- a) **Eliminate grease, coolant oil and any dirt** from the internal bore of the hydraulic chuck and tool shank prior to mounting.
- b) **Ensure the minimum chucking length (L_{min})** is maintained. (see Fig 1. & Table 1.)
- c) Cylindrical tool shanks available in accordance with **$h6$ tolerance** (Table 2.) and **$Ra \text{ min} = 0.3\mu\text{m}$ (ground)** and weldon shanks should be used in collet only.
- d) Remove the end tool from the hydraulic chuck when not in use for long periods of time.
- e) Do not turn the clamping screw prior to tool mounting in the hydraulic chuck.

* Please refer to the backface for information tables.

Figure 1. Tool structure

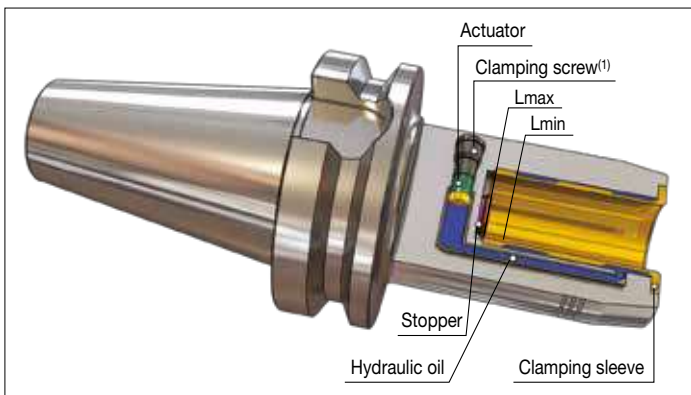

Table 1. Recommended minimum & maximum depth (L) of end tool insertion

Inner bore diameter Ø (mm)	Lmin (mm)	Lmax (mm)
6	27.5	37.5
8	27.5	37.5
10	32.5	42.5
12	37.5	47.5
14	37.5	47.5
16	42.5	52.5
20	42.5	52.5
25	51.0	61.0
32	55.0	65.0

Table 2. h6 tolerance range

Shank size Ø (mm)		h6 tolerance range (µm)
	3	0
		-6
3	6	0
		-8
6	10	0
		-9
10	18	0
		-11
18	30	0
		-13
30	50	0
		-16

Table 3. Clamping torque

Inner bore diameter Ø (mm)	Clamping torque (N•m)
6	10
8	25
10	40
12	65
14	90
16	120
20	240
25	260
32	450

► Thermal T-SHRINK chucking system



► T-SHRINK chucking system

The thermal T-SHRINK ER collet chucking system is an enhancement to the existing popular ER system. The T-SHRINK collets utilize the thermal shrink phenomena for rigid clamping of solid carbide cutters. This new system provides higher torque, precision runout and better repeatability. The T-SHRINK collets with their slim design and different projection length allows the user to reach into deeper cavities and perform narrow milling applications. TaeguTec offers a complete system for T-SHRINK ER collets, including a uniquely designed heating unit with a portable heating handle. The unit is equipped with a high-tech temperature control for easy and practical use at the machining center or in the tool room.



- For carbide tools only



L(mm)	Max. T.I.R
35	7 μ m
60	9 μ m
85	10 μ m

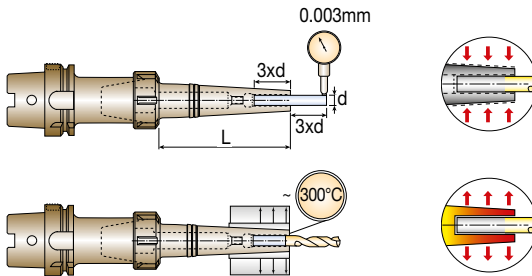

▶ GTI-Tap attachment

■ Description

Short tap chucks for ER collets



■ Application

Axial-float/tension/compression type for CNC milling machines and lathes with reversing motors and rigid tapping

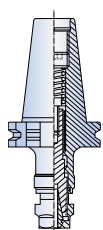

DIN 69871

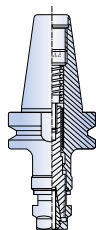

BT MAS-403

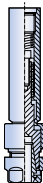

Straight shank

■ Features

- Compensates for machine feed and tap pitch variance
- Floating mechanism compensates for misalignment between tap and workpiece
- Right and left-hands tapping

■ Advantages

- Practical and efficient tap holding by the ER spring collet without using drive jaw
- Compact design for minimal clearance applications
- Heavy-duty design for high torque drive ensures the same accuracy as the tap itself

■ Operation

For through and blind hole tapping

- 1** Enter feed rate according to thread pitch (or 1-2% lower), and set spindle to starting point with 0.08mm clearance.

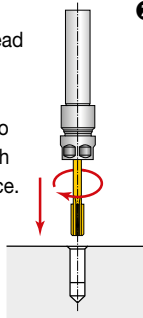

- 2** Start spindle forward with right hand rotation until reaching desired depth.

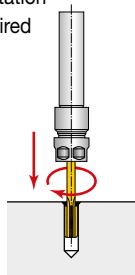

- 3** Stop feed and rotation and reverse to starting point.

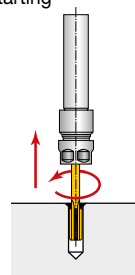



MPT

MODULAR PRECISION TOOLING

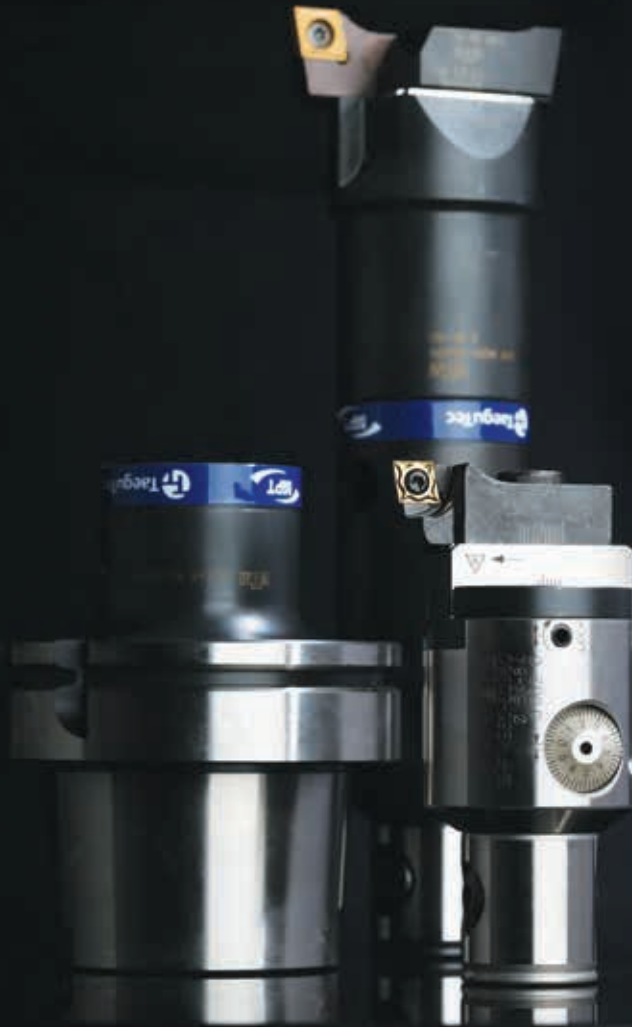

MPT

Modular Precision Tooling



contents

Tool Selection Guide	H4
Shanks	H6
Extensions and Reducers	H18
Toolholders	H21
Rough Boring Heads	H29
Fine Boring Heads	H35

Guide to Icons



> Insert Page



> Spare Parts Page



> Toolholders Page



> Slide Page



> Cutting Condition Page

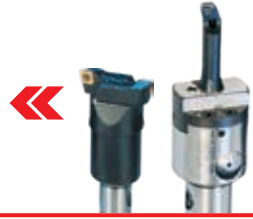

Boring Inserts	H50
Kits	H54
Spare Parts	H58
Recommended Cutting Conditions	H69
Technical Data	H76

Tool Selection Guide

MPT system

Shanks

SKA

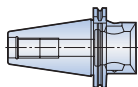

HSK

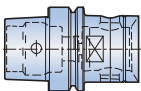

CATM

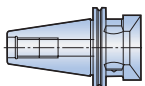

BT/BT-FC

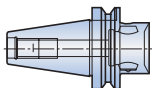

ISOM/ISO

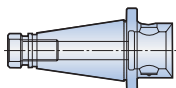

C MB

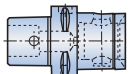

MTT/MTD

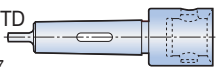

ST

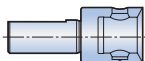

Extensions and reducers

EX  H18

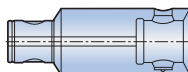

RE  H19

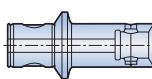

RE AVI  H20

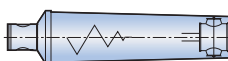

CHR  H20

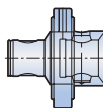

Tool Selection Guide

MPT system

Toolholders

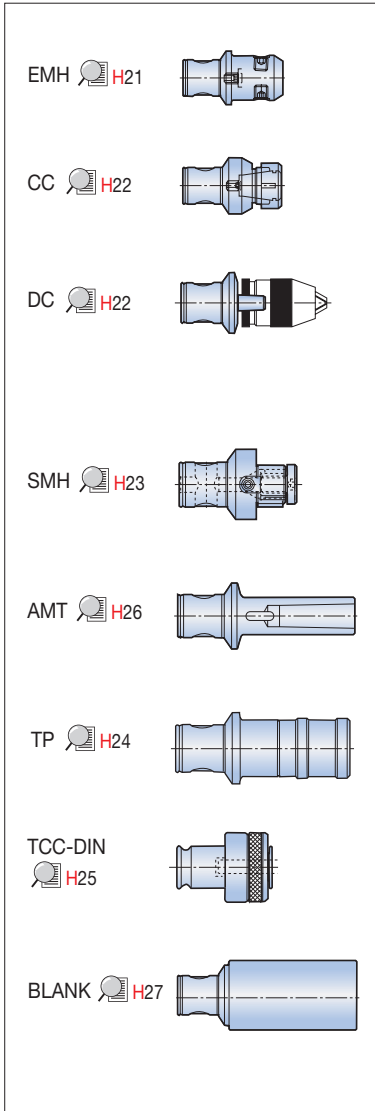

Boring heads

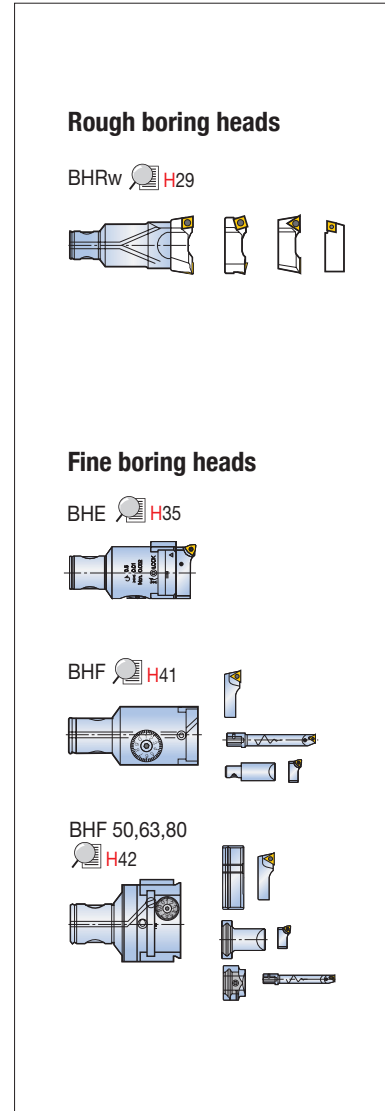

SK shank with MB connection

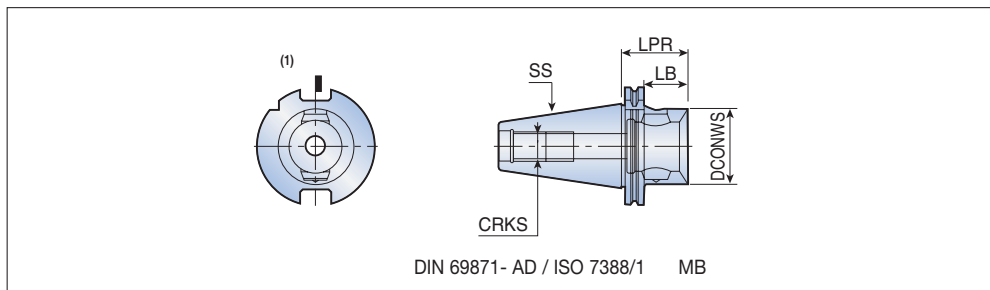

Designation	Dimension (mm)					CRKS	Kg
	SS	DCONWS	LPR	LB	BD		
SKA 30-MB32	30	MB32	30	10.5	-	M12	0.6
30-MB50	30	MB50	60	41	-	M12	0.7
40-MB40	40	MB40	45	26	-	M16	0.9
40-MB50	40	MB50	48	29	-	M16	1.2
40-MB63	40	MB63	80	61	-	M16	1.6
45-MB50	45	MB50	48	29	-	M20	1.9
50-MB50	50	MB50	48	29	-	M24	2.8
50-MB63	50	MB63	56	37	-	M24	3.0
50-MB80	50	MB80	62	43	-	M24	3.6
40 MB40x120	40	MB40	120	101	44.50	M16	1.7
40 MB50x120	40	MB50	120	101	-	M16	2.8
50 MB50x120	50	MB50	120	101	60.00	M24	4.0
50 MB63x150	50	MB63	150	131	70.00	M24	2.8
50 MB80x180	50	MB80	180	161	-	M24	7.9
50 MB110x150	50	MB110	150	131	-	M24	8.2
60 MB80x65	60	MB80	65	46	-	M30	10.7
60 MB110x100	60	MB110	100	81	-	M30	10.5
60 MB110x200	60	MB110	200	181	-	M30	18.0

▶ (1) Cutting edge position

CAT shank with MB connection

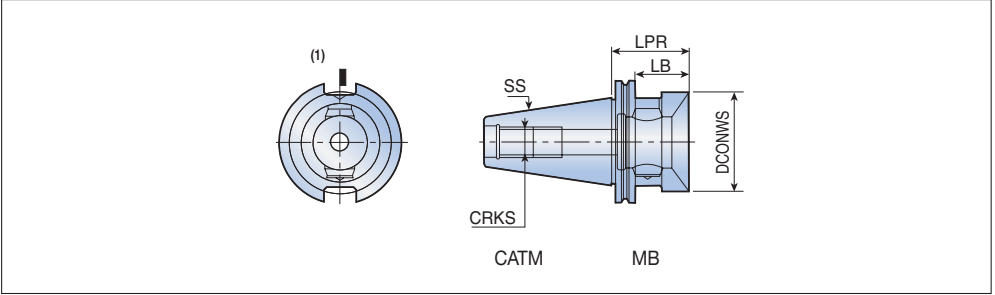

Designation	Dimension (mm)				CRKS	Kg
	SS	DCONWS	LPR	LB		
CATM 40-MB50	40	MB50	66	47	M16	1.1
40-MB63	40	MB63	100	81	M16	1.9
45-MB50	45	MB50	48	29	M20	1.7
50-MB50	50	MB50	48	29	M24	2.9
50-MB63	50	MB63	56	37	M24	2.9
50-MB80	50	MB80	62	43	M24	3.2

► ⁽¹⁾ Cutting edge position

HSK shank with MB connection

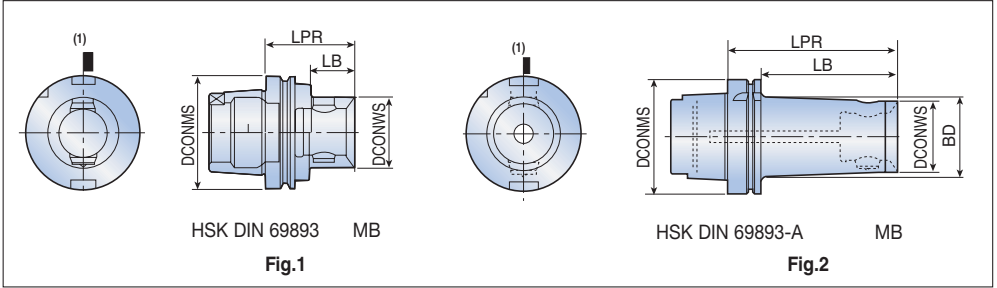

Designation	Dimension (mm)					Kg	Fig.
	DCONMS	DCONWS	LPR	LB	BD		
HSK A 50-MB50	50	MB50	66	40	-	0.6	1
63-MB40	63	MB40	60	34	-	1.0	1
63-MB40x120	63	MB40	120	94	46	1.6	2
63-MB50	63	MB50	66	40	-	0.9	1
63-MB50x120	63	MB50	120	94	-	1.1	2
63-MB63	63	MB63	75	49	-	1.1	1
80-MB50	80	MB50	70	44	-	1.5	1
80-MB63	80	MB63	80	54	-	1.8	1
80-MB80	80	MB80	86	60	-	2.1	1
100-MB50	100	MB50	72	43	-	2.0	1
100-MB50x120	100	MB50	120	91	60	4.9	2
100-MB63	100	MB63	82	53	-	2.7	1
100-MB63x150	100	MB63	150	121	70	4.7	2
100-MB80	100	MB80	88	59	-	3.0	1
100-MB80x180	100	MB80	180	151	-	7.3	2

▶ (1) Cutting edge position

HSK E-MB/HSK F-MB

HSK shank with MB connection

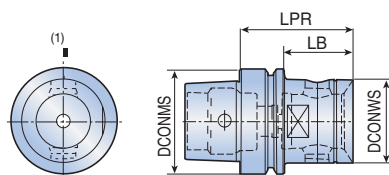

HSK DIN 69893-E MB

Fig.1

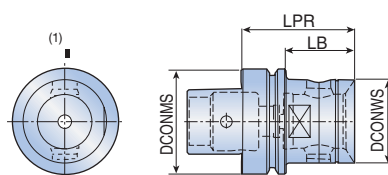

HSK DIN 69893-F MB

Fig.2

Designation	Dimension (mm)				Kg	Fig.
	DCONMS	DCONWS	LPR	LB		
HSK E 40 MB32	40	MB32	42	22	0.3	1
50 MB50	50	MB50	66	-	0.7	1
HSK F 63 MB50	63	MB50	65	39	1.0	2

► ⁽¹⁾ Cutting edge position

C-adapter shank with MB connection

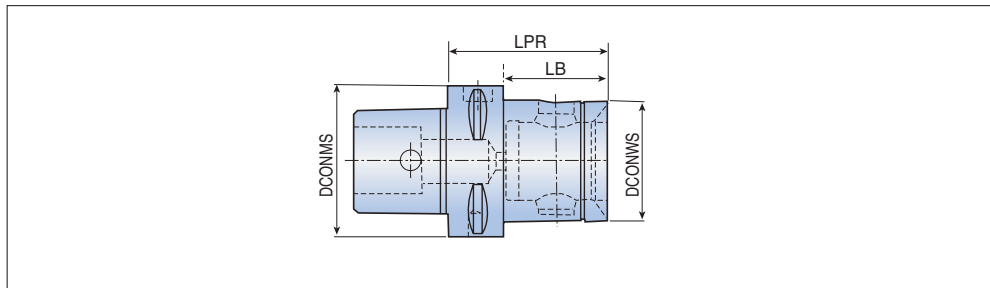

Designation	Dimension (mm)				 Kg
	DCONMS	DCONWS	LPR	LB	
C6 MB50x67	63	MB50	67	45	1.1
MB63x77	63	MB63	77	-	1.8
C8 MB63x70	80	MB63	70	39	2.3

BT shanks with MB connection

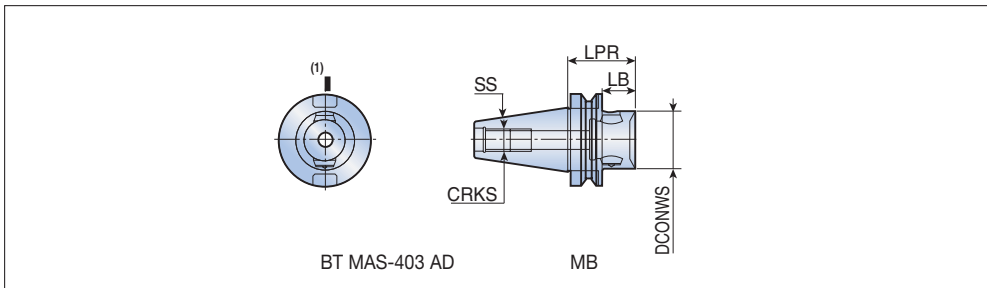

Designation	Dimension (mm)					CRKS	Kg
	SS	DCONWS	LPR	LB	BD		
BT-30-MB32	30	MB32	32	10.6	-	M12	0.5
30-MB50	30	MB50	60	38.6	-	M12	0.7
40-MB40	40	MB40	45	18	-	M16	0.6
40-MB50	40	MB50	48	21	-	M16	0.9
40-MB63	40	MB63	66	39	-	M16	1.2
45-MB50	45	MB50	62	29	-	M20	1.7
50-MB50	50	MB50	66	28	-	M24	3.5
50-MB63	50	MB63	75	37	-	M24	3.7
50-MB80	50	MB80	75	37	-	M24	4.0
40-MB40x120	40	MB40	120	93	44.5	M16	0.9
40-MB50x120	40	MB50	120	93	-	M16	1.9
50-MB50x120	50	MB50	120	82	60	M24	4.2
50-MB63x150	50	MB63	150	112	70	M24	5.8
50-MB80x180	50	MB80	180	142	-	M24	7.5
50-MB110x140	50	MB110	140	102	-	M24	6.8

► ⁽¹⁾ Cutting edge position

BT-FC shanks with MB connection

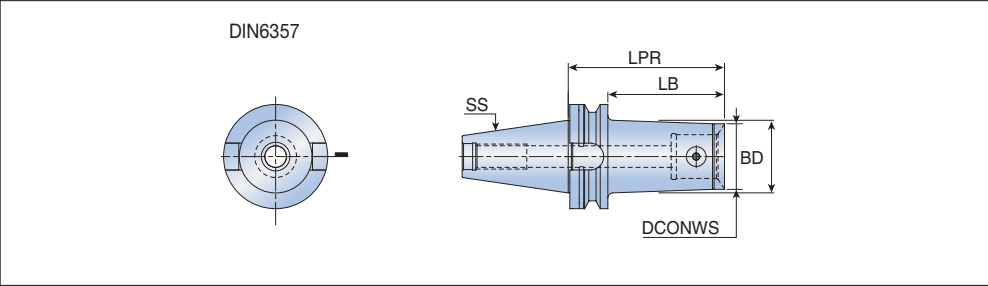

Designation	Dimension (mm)					CRKS	Kg
	SS	DCONWS	LPR	BD	LB		
BT40 FC MB50	40	50	48	-	21	M16	0.9
FC MB50X120	40	50	120	-	93	M16	1.9
FC MB63	40	63	66	-	-	M16	1.2
BT50 FC MB50	50	50	66	-	28	M24	3.3
FC MB50X120	50	50	120	60	82	M24	4.2
FC MB63	50	63	75	-	37	M24	3.7
FC MB63X150	50	63	150	70	112	M24	5.8
FC MB80	50	80	75	-	37	M24	4
FC MB80X180	50	80	180	-	142	M24	7.5

ISO Taper shank with MB connection

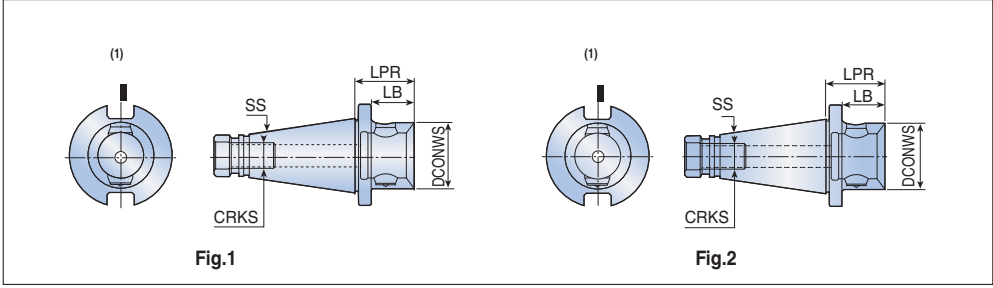

Fig.1

Fig.2

Designation	Dimension (mm)				CRKS	Kg	Fig.
	SS	DCONWS	LPR	LB			
ISOM 30-MB50	30	MB50	58	-	M12	0.6	1
40-MB50	40	MB50	48	36	M16	0.9	1
40-MB63	40	MB63	60	-	M16	1.2	1
45-MB50	45	MB50	48	33	M20	1.6	1
50-MB50	50	MB50	48	33	M24	2.6	1
50-MB63	50	MB63	56	41	M24	2.7	1
50-MB80	50	MB80	60	45	M24	3.2	1
ISO 50-MB50	50	MB50	48	33	UNC 1"-8	2.6	2
50-MB80	50	MB80	60	45	UNC 1"-8	3.2	2

► ⁽¹⁾ Cutting edge position

Straight shanks with MB connection

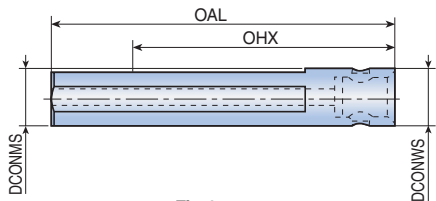

Fig.1

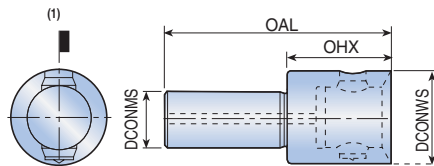
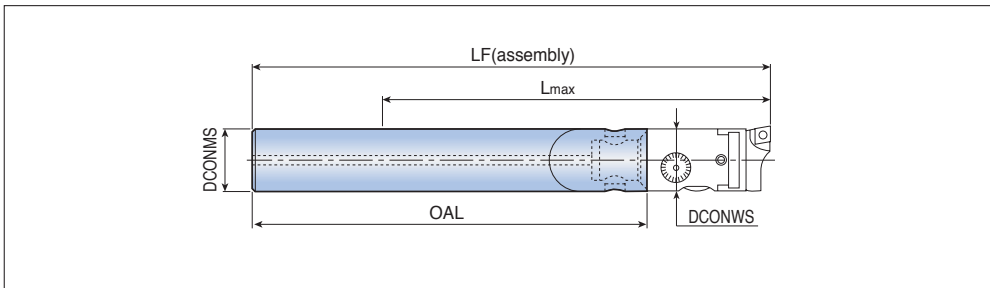

Fig.2

Designation	Dimension (mm)				kg	Fig.
	DCONMS	DCONWS	OAL	OHX		
ST 16-MB16	16	MB16	100	66	0.2	1
20-MB20	20	MB20	125	85	0.3	1
32-MB50	32	MB50	140	60	1.0	2

▶ ⁽¹⁾ Cutting edge position

Straight carbide shanks with MB connection



Designation	Dimension (mm)					Kg
	DCONMS	DCONWS	OAL	LF	Lmax	
ST16 MB16x110E	16	MB16	110	144	100	0.3
MB16x140E	16	MB16	140	174	125	0.4
MB16x170E	16	MB16	170	204	160	0.5
ST20 MB20x135E	20	MB20	135	175	125	0.6
MB20x170E	20	MB20	170	210	160	0.8
MB20x210E	20	MB20	210	250	200	0.9
ST25 MB25x160E	25	MB25	160	210	160	1.0
MB25x205E	25	MB25	205	255	200	1.3
MB25x255E	25	MB25	255	305	250	1.6
ST32 MB32x195E	32	MB32	195	258	200	2.1
MB32x250E	32	MB32	250	313	250	2.8
MB32x315E	32	MB32	315	378	320	3.5

ST-MB straight carbide shank with MB connection assembly options

ST16-ST32 MB16-MB32

Diameter range: 18-50 mm

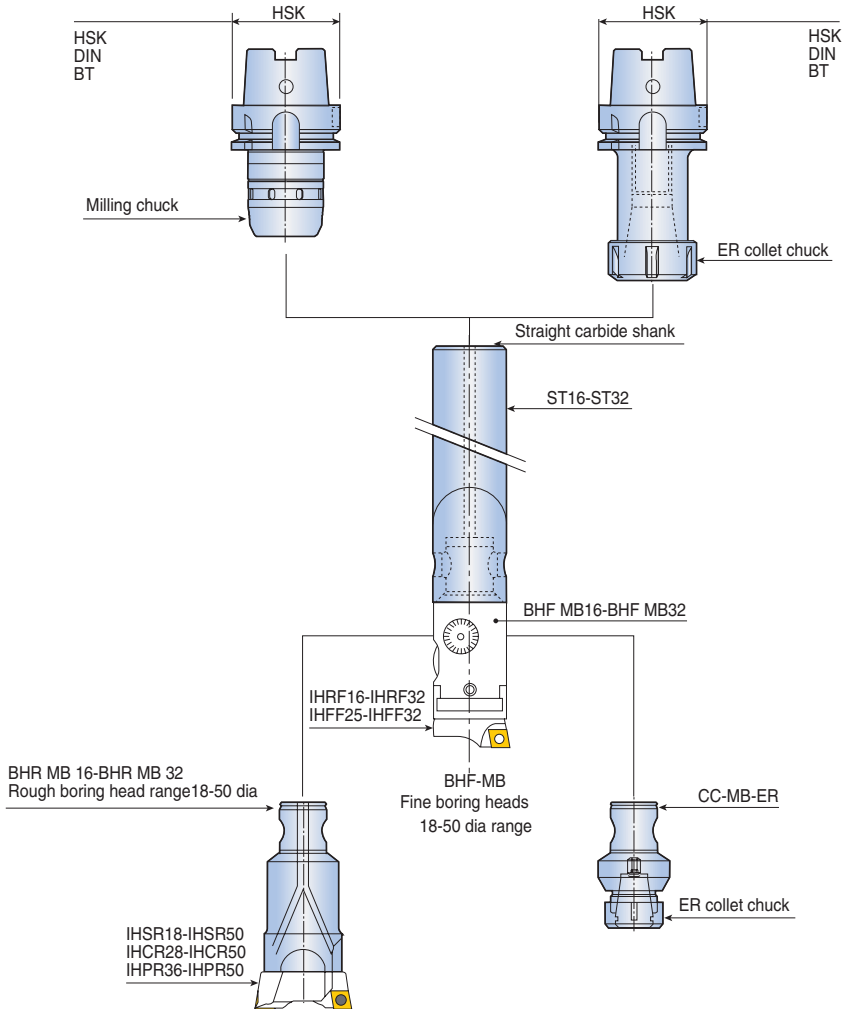

Morse taper shanks with MB connection

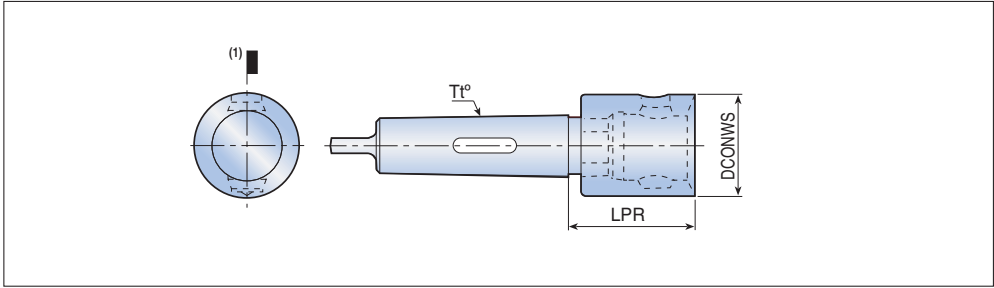



Designation	Dimension (mm)			
	Tt°	DCONWS	LPR	
MTT 5-MB63	MT5	MB63	65	2.1

▶ ⁽¹⁾Cutting edge position

MTD-MB

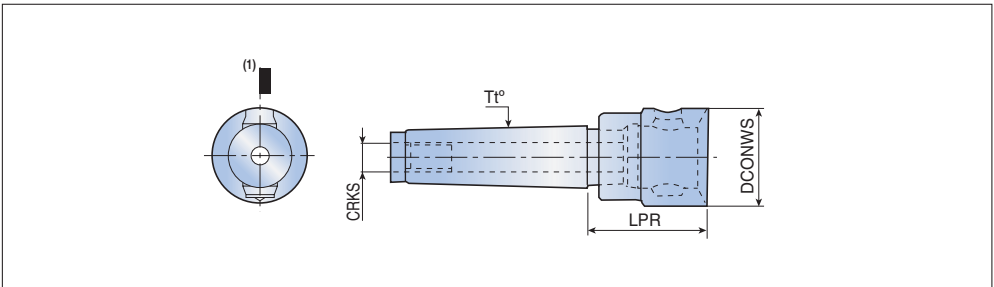
Morse taper shanks with MB connection



Designation	Dimension (mm)			CRKS	
	Tt°	DCONWS	LPR		
MTD 4-MB50	MT4	MB50	63	M16	0.9
MB50 SIP	MT4	MB50	63	M14	1.0

▶ ⁽¹⁾Cutting edge position

EX-MB

Extensions and Reducers

Extensions with MB connection

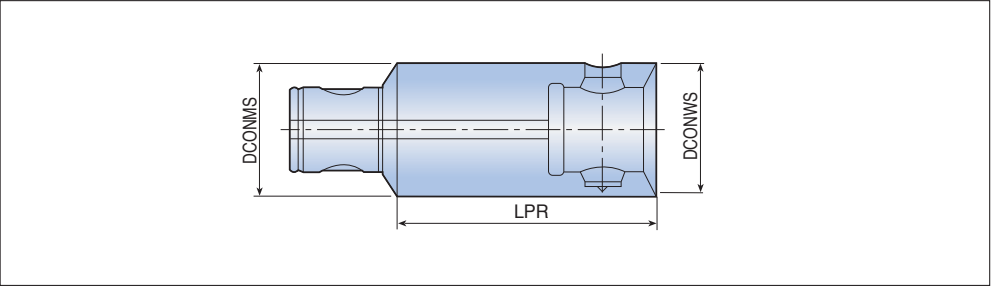

Designation	Dimension (mm)			Kg
	DCONMS	DCONWS	LPR	
EX 14x25-MB14	MB14	MB14	25	0.2
16x25-MB16	MB16	MB16	25	0.4
20x32-MB20	MB20	MB20	32	0.7
25x25-MB25	MB25	MB25	25	0.9
25x40-MB25	MB25	MB25	40	0.2
32x32-MB32	MB32	MB32	32	0.2
32x50-MB32	MB32	MB32	50	0.3
40x40-MB40	MB40	MB40	40	0.4
40x63-MB40	MB40	MB40	63	0.6
50x50-MB50	MB50	MB50	50	0.7
50x80-MB50	MB50	MB50	80	1.1
50x100-MB50	MB50	MB50	100	1.5
63x63-MB63	MB63	MB63	63	1.4
63x100-MB63	MB63	MB63	100	2.2
63x125-MB63	MB63	MB63	125	2.9
80x80-MB80	MB80	MB80	80	3.0
80x125-MB80	MB80	MB80	125	4.6
80x160-MB80	MB80	MB80	160	6.1

Reducers with MB connection

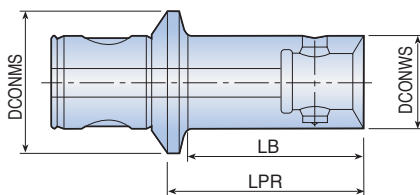

Designation	Dimension (mm)				Kg
	DCONMS	DCONWS	LPR	LB	
RE MB16-MB14x24	MB16	MB14	24	19.5	0.3
MB20-MB14x19	MB20	MB14	19	13.5	0.4
MB20-MB16x20	MB20	MB16	20	16	0.5
MB25-MB14x19	MB25	MB14	19	13.5	0.6
MB25-MB16x20	MB25	MB16	20	15	0.8
MB25-MB20x25	MB25	MB20	25	20	0.9
MB32-MB14x25	MB32	MB14	25	17	1.0
MB32-MB16x24	MB32	MB16	24	18	1.3
MB32-MB20x25	MB32	MB20	25	20	1.6
MB32-MB25x28	MB32	MB25	28	23	2.1
MB40-MB14x23	MB40	MB14	23	16	2.8
MB40-MB16x24	MB40	MB16	24	17	3.5
MB40-MB20x26	MB40	MB20	26	20	0.4
MB40-MB25x28	MB40	MB25	28	22	0.5
MB40-MB32x32	MB40	MB32	32	27	0.6
MB50-MB14x23	MB50	MB14	23	14.5	0.8
MB50-MB14x39	MB50	MB14	39	30.5	0.9
MB50-MB16x24	MB50	MB16	24	15	1.0
MB50-MB16x40	MB50	MB16	40	31	1.3
MB50-MB16x74	MB50	MB16	74	65	1.6
MB50-MB20x26	MB50	MB20	26	18	3.5
MB50-MB20x70	MB50	MB20	70	62	0.4
MB50-MB20x93	MB50	MB20	93	85	0.5
MB50-MB25x28	MB50	MB25	28	21	0.6
MB50-MB25x87	MB50	MB25	87	80	0.8
MB50-MB25x117	MB50	MB25	117	110	3.5
MB50-MB32x32	MB50	MB32	32	25	0.4
MB50-MB32x87	MB50	MB32	87	80	0.5
MB50-MB32x144	MB50	MB32	144	137	0.6
MB50-MB40x36	MB50	MB40	36	30	0.8
MB50-MB40x87	MB50	MB40	87	80	0.9
MB50-MB40x176	MB50	MB40	176	170	1.0
MB63-MB50x40	MB63	MB50	40	34	1.3
MB80-MB50x45	MB80	MB50	45	36	1.6
MB80-MB63x60	MB80	MB63	60	52	1.6
MB110-MB80x70	MB110	MB80	70	52	6.0

Carbide core reducers with MB connection

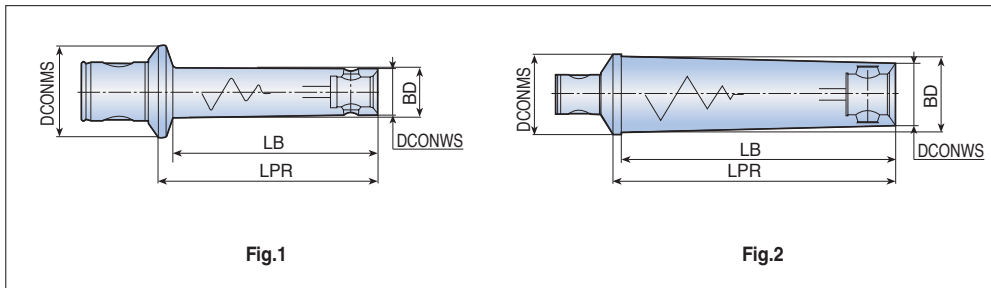

Designation	Dimension (mm)					Kg	Fig.
	DCONMS	DCONWS	BD	LPR	LB		
RE MB50-MB16x74-AVI	MB50	MB16	17.5	74	65	0.4	1
MB50-MB20x93-AVI	MB50	MB20	21.5	93	85	0.5	1
MB50-MB25x117-AVI	MB50	MB25	27	117	110	0.8	1
MB50-MB32x144-AVI	MB50	MB32	35	144	138	1.4	1
MB50-MB40x176-AVI	MB50	MB40	47	176	170	2.5	1
MB63-MB50x220-AVI	MB63	MB50	60	220	214	5.6	1
MB80-MB63x280-AVI	MB80	MB63	77	280	272	10.6	2

CHR MB

Extensions and Reducers

Coolant extensions with MB connection

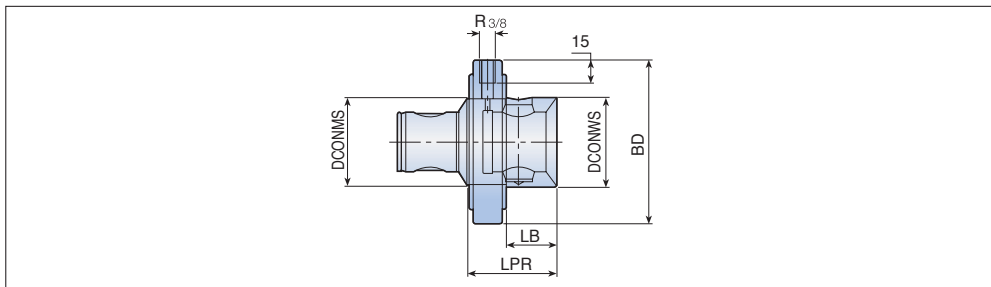

Designation	Dimension (mm)								Kg	
	DCONMS	DCONWS	R	BD	LPR	LB	LS	RPM _{Max}		Bar
CHR MB63	MB63	MB63	-	115	63	35	-	3500	10	5.0

- ▶ Important: Start coolant flow prior to rotating the spindle to avoid damage of the O rings.
- ▶ Use with stop block. (not included)

Weldon holder with MB connection

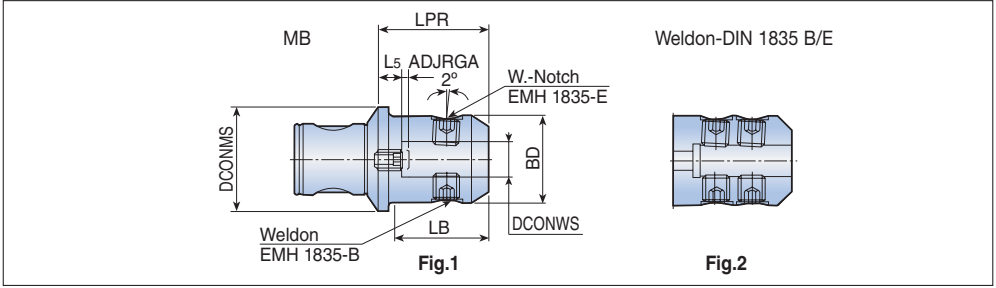

Designation	Dimension (mm)							Kg	Fig.
	DCONMS	DCONWS	BD	LPR	LB	L5	ADJRGA		
EMH MB50-6	MB50	6	25	44	32.5	7	2	0.5	1
MB50-8	MB50	8	28	44	33	7	2	0.5	1
MB50-10	MB50	10	35	52	42	11	3	0.7	1
MB50-12	MB50	12	42	57	48	11	3	0.8	1
MB50-14	MB50	14	42	57	48	11	3	0.8	1
MB50-16	MB50	16	48	67	61	17	4	1.1	1
MB50-20	MB50	20	51	67	-	16	4	1.1	1
MB50-25	MB50	25	63	80	-	22	4	1.2	2
MB63-16	MB63	16	48	64	53	14	4	1.4	1
MB63-20	MB63	20	52	66	56	14	4	1.5	1
MB63-25	MB63	25	64	74	-	16	4	2.1	2
MB63-32	MB63	32	72	76	-	14	4	2.5	2
MB80-40	MB80	40	80	83	-	12	4	3.2	2



ER Collet chucks with MB connection

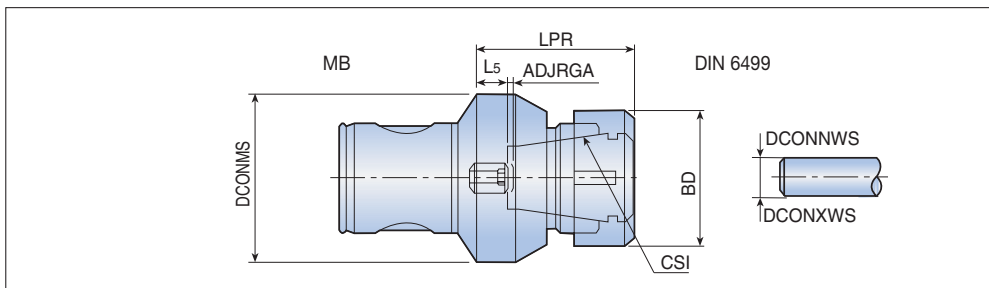

Designation	Dimension (mm)							Kg
	DCONMS	CSI	DCONXWS	DCONXWS	BD	LPR	ADJRGA	
CC MB16 ER11M	MB16	ER11	0.5	7.0	16	25	2.5	0.03
MB20 ER16M	MB20	ER16	0.5	10.0	22	32	1.0	0.06
MB25 ER20M	MB25	ER20	1.0	13.0	28	40	2.5	0.15
MB32 ER25M	MB32	ER25	1.0	16.0	35	42	1.5	0.25
MB40 ER25	MB40	ER25	1.0	16.0	42	45	5.0	0.25
MB50 ER25	MB50	ER25	1.0	16.0	42	48	7.0	0.70
MB50 ER32	MB50	ER32	2.0	20.0	50	59	7.0	1.00
MB63 ER32	MB63	ER32	2.0	20.0	50	59	12	1.30
MB63 ER40	MB63	ER40	3.0	26.0	63	64	12	1.50

DC MB

Toolholders

Drill chucks with MB connection

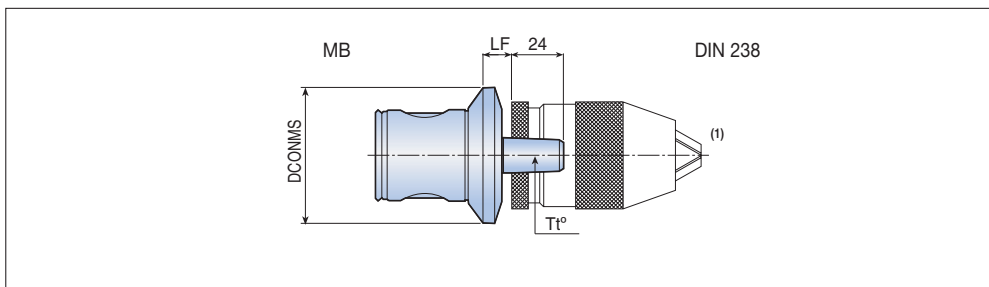

Designation	Dimension (mm)			Kg
	DCONMS	T1°	LF	
DC MB50 B16	MB50	B16	10.0	0.4
MB63 B16	MB63	B16	13.5	0.8

Spare Parts ▶ ⁽¹⁾Without drill chuck



H58-H68

Shell mill holders with MB connection

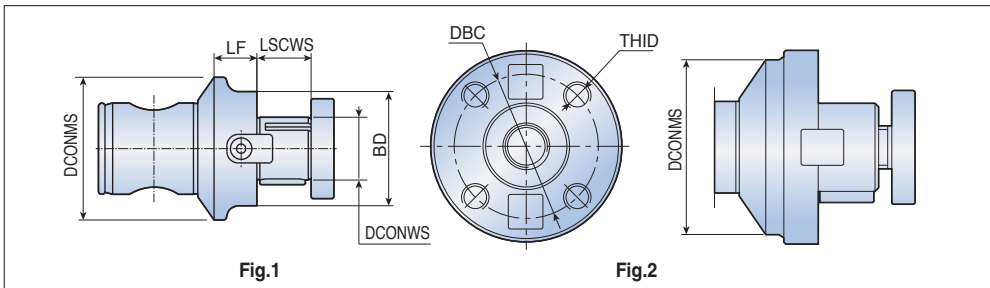



Designation	Dimension (mm)							Fig.	Kg
	DCONMS	DCONWS	BD	DBC	THID	LF	LSCWS		
SMH MB40-16	40	16	32	-	-	15	17	1	0.32
MB40-22	40	22	40	-	-	13	19	1	0.38
MB50-16	50	16	32	-	-	15	17	1	0.48
MB50-22	50	22	40	-	-	15	19	1	0.55
MB50-27	50	27	50	-	-	15	21	1	0.66
MB50-32	50	32	60	-	-	15	24	1	0.79
MB63-22	63	22	60	-	-	15	19	1	1.01
MB63-27	63	27	60	-	-	15	21	1	1.09
MB63-32	63	32	70	-	-	15	24	1	1.24
MB80-32	80	32	88	-	-	24	24	1	2.09
MB80-40	80	40	88	66.7	M12	24	27	2	2.25
MB80-50	80	50	90	-	-	24	30	2	2.58
MB80-60⁽¹⁾	80	60	128.5	101.6	M16	31.5	40	2	4.19

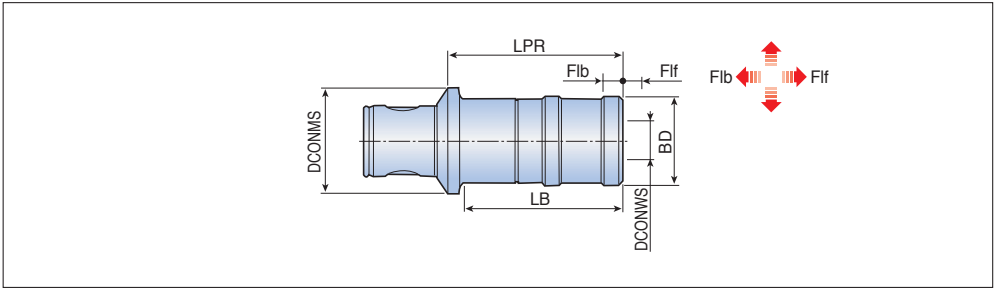

► ⁽¹⁾Shell locking screw not supplied

Tapping chucks with MB connection



Designation	Dimension (mm)									Kg 
	DCONMS	TAP _{min}	TAP _{max}	LB	LPR	BD	DCONWS	F1f	F1b	
TP MB50-M 3-12	MB50	M1	M14	60	72	36	19	7.5	7.5	0.8
MB50-M 8-20	MB50	M4.5	M20	-	106	53	31	12.5	12.5	1.6
MB63-M 3-12	MB63	M1	M14	58	70	36	19	7.5	7.5	1.2
MB63-M 8-20	MB63	M4.5	M20	93	104	53	31	12.5	12.5	1.9

Quick change tap collets with a safety clutch

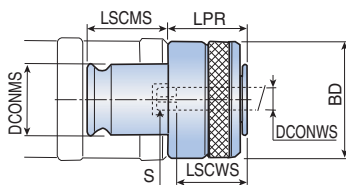

Designation	Dimension (mm)								
	DCONWS ⁽¹⁾	S ⁽²⁾	S ₁ ⁽³⁾	S ₂ ⁽⁴⁾	BD	DCONMS	LSCWS	LPR	LSCMS
TCC #1 DIN 4-3	4.0	3.0	M3.5	-	32	19	17	25	21.5
#1 DIN 4.5-3.4	4.5	3.4	M4	M6	32	19	17	25	21.5
#1 DIN 6-4.9	6.0	4.9	M4.5,M6	M8	32	19	17	25	21.5
#1 DIN 7-5.5	7.0	5.5	M7	M10	32	19	17	25	21.5
#1 DIN 8-6.2	8.0	6.2	M8	-	32	19	17	25	21.5
#1 DIN 9-7	9.0	7.0	-	M12	32	19	17	25	21.5
#1 DIN 10-8	10.0	8.0	M10	-	32	19	17	25	21.5
#2 DIN 6x4.9	6.0	4.9	M4.5,M6	M8	50	31	30	34	35.0
#2 DIN 7x5.5	7.0	5.5	M7	M10	50	31	30	34	35.0
#2 DIN 8x6.2	8.0	6.2	M8	-	50	31	30	34	35.0
#2 DIN 9x7	9.0	7.0	M7	M12	50	31	30	34	35.0
#2 DIN 10x8	10.0	8.0	M10	-	50	31	30	34	35.0
#2 DIN 12x9	12.0	9.0	-	M16	50	31	30	34	35.0
#2 DIN 14x11	14.0	11.0	-	M18	50	31	30	34	35.0
#2 DIN 16x12	16.0	12.0	-	M20	50	31	30	34	35.0

► ⁽¹⁾According to tap shank size ⁽²⁾Square size ⁽³⁾Tap size according to DIN371 ⁽⁴⁾Tap size according to DIN376/374

MB shanks for Morse taper tang

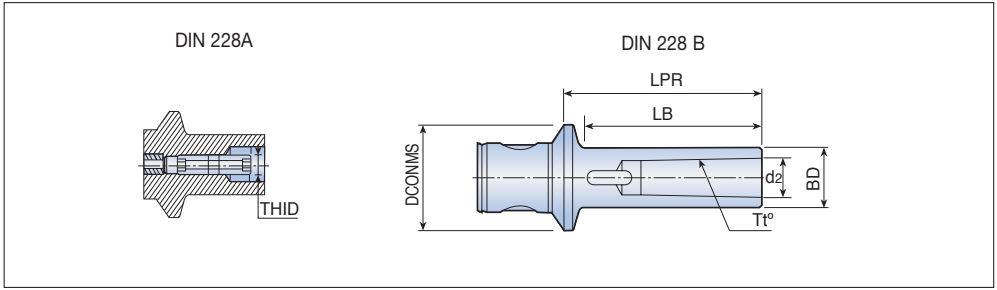

Designation	Dimension (mm)							Kg
	DCONMS	Tt°	d ₂	BD	THID	LPR	LB	
AMT MB50-MT1	MB50	MT1	12.07	20	M6	80	68	0.6
MB50-MT2	MB50	MT2	17.78	30	M10	100	86	0.7
MB50-MT3	MB50	MT3	23.82	36	M12	120	110	1.0
MB63-MT3	MB63	MT3	23.82	36	M12	120	108	1.3
MB63-MT4	MB63	MT4	31.26	48	M16	150	133	2.0



Blanks with MB connection

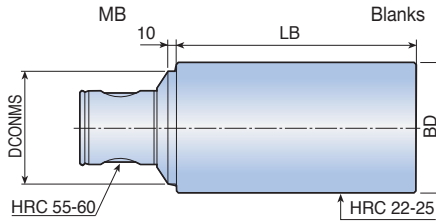

Designation	Dimension (mm)			Kg
	DCONMS	BD	LB	
BLANK MB50-63x160	MB50	63	160	4.4
MB63-80x200	MB63	80	200	8.8
MB80-100x250	MB80	100	250	16.6
MB110-130x250	MB110	130	250	18.0

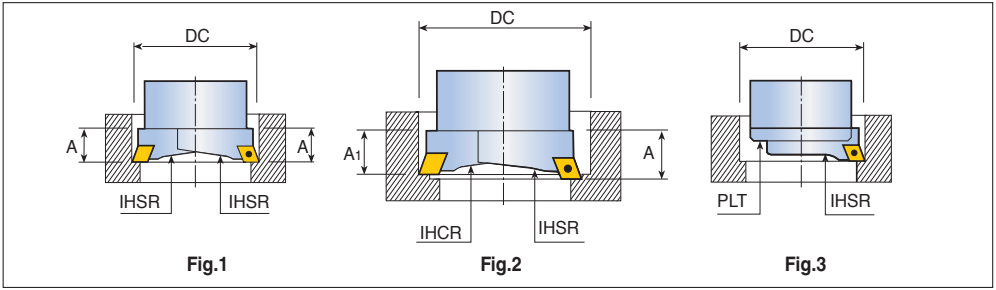

- ▶ When using the MPT system, it is strongly recommended that the user utilizes the tool pre-setting equipment provided to set the radial cutting edges. The boring bars that are equipped with two inserts holders are for rough machining and heavy stock removal.
- ▶ The bars are applicable to three types of machining scenarios:
 - When two IHSR insert holders are on the same plane, the two cutting edges are placed at identical radial distances for high feed rough machining(Fig. 1).
 - When each IHCR and IHSR insert is not set on the same plane, each of the two cutting edges is placed at a different radial distance for deep rough machining(Fig. 2).
 - If boring bars are set with a single insert holder it allows rough and finish machining with normal chip removal. In this situation, it is strongly recommended that a serrated surface protection plate (PLT) is used(Fig. 3).

Rough boring head diameter range

	0	10	20	30	40	50	60	70	80	90	100	110	120	130	150	200	300	400	600	700	800	
BHR MB 16-16x34				18-22																		
20-20x40				22-28																		
25-25x50					28-38																	
32-32x63						35.5-50																
40-40x80							50-68															
50-50x100										68-90												
50-63x80														90-120								
63-63x125														90-120								
80-80x140																	120-200					

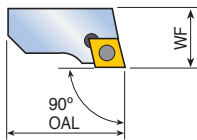

Fig.1

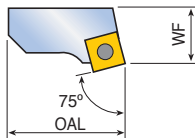

Fig.2

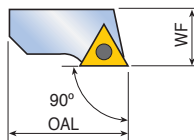

Fig.3

Designation	Dimension (mm)				Spare parts			Fig.
	DCN	DCX	WF	OAL	Insert	Insert screw	Torx key	
IHSR 18-22	18	22	8.0	15.0	CCMT 0602...	SR 14-548	T 7	1
22-28	22	28	9.5	19.0	CCMT 0602...	SR 14-548	T 7	1
28-38	28	38	12.5	23.0	CCMT 0602...	SR 14-548	T 7	1
36-50	36	50	15.0	32.0	CCMT 0602...	SR 14-548	T 7	1
50-68	50	68	19.0	40.0	CCMT 09T3...	SR 16-236	T 15	1
50-68-12	50	68	19.0	40.0	CCMT 1204..	SR 16-212	T 20	1
68-90	68	90	22.0	54.0	CCMT 1204..	SR 16-212	T 20	1
90-120	90	120	27.0	70.5	CCMT 1204...	SR 16-212	T 20	1
120-160	120	160	32.0	94.5	CCMT 1204..	SR 16-212	T 20	1
160-800	160	800	32.0	130.0	CCMT 1204..	SR 16-212	T 20	1
IHCR 28-38	28	38	12.3	23.0	CCMT 0602..	SR 14-548	T 7	1
36-50	36	50	14.8	32.0	CCMT 0602...	SR 14-548	T 7	1
36-50-09	36	50	14.8	32.0	CCMT 09T3..	SR 16-236	T 15	1
50-68	50	68	18.7	40.0	CCMT 09T3..	SR 16-236	T 15	1
50-68-12	50	68	18.7	40.0	CCMT 1204..	SR 16-212	T 20	1
68-90	68	90	21.7	54.0	CCMT 1204..	SR 16-212	T 20	1
90-120	90	120	26.7	70.5	CCMT 1204..	SR 16-212	T 20	1
120-160	120	160	31.7	94.5	CCMT 1204..	SR 16-212	T 20	1
160-800	160	800	31.7	130.0	CCMT 1204..	SR 16-212	T 20	1
IHPR 36-50	36	50	15	32.0	SCMT 09T3..	SR 16-236	T 15	2
50-68	50	68	19	40.0	SCMT 09T3...	SR 16-236	T 15	2
68-90	68	90	22	54.0	SCMT 1204..	SR 16-212	T 20	2
90-120	90	120	27	70.5	SCMT 1204..	SR 16-212	T 20	2
120-160	120	160	32	94.5	SCMT 1204..	SR 16-212	T 20	2
160-800	160	800	32	130.0	SCMT 1204..	SR 16-212	T 20	2
IHBR 90-120	90	120	27	70.5	TCMT 2205..	SR 16-212	T 20	3
120-160	120	160	32	94.5	TCMT 2205..	SR 16-212	T 20	3
160-800	160	800	32	130.0	TCMT 2205..	SR 16-212	T 20	3



H50-H53

Fine boring head range: 10µm direct diametric adjustment and 2µm with the vernier scale

10µm
2µm

BHE MB50-50x80
Ø6-113.5

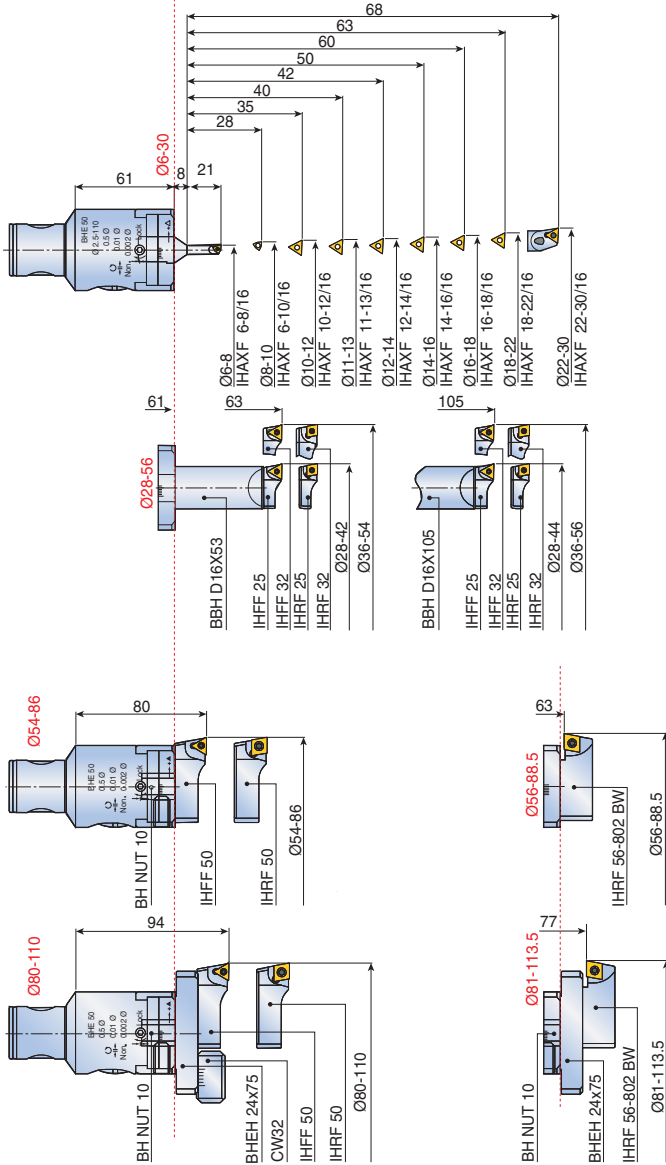

Fine boring head range: 10µm direct diametric adjustment and 2µm with the vernier scale

BHE MB63-63x89
ø6-129.5

10µm
 2µm

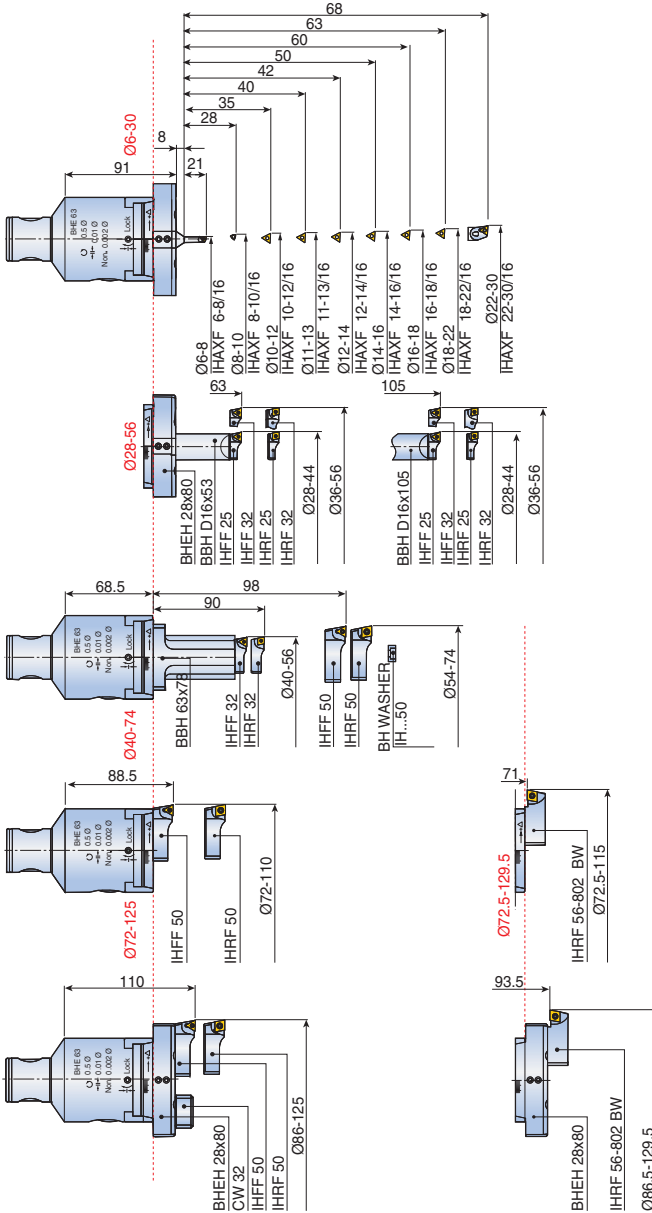

Fine boring head range: 10µm direct diametric adjustment and 2µm with the vernier scale

10µm
2µm

BHE MB80-80x104
Ø6-202.5

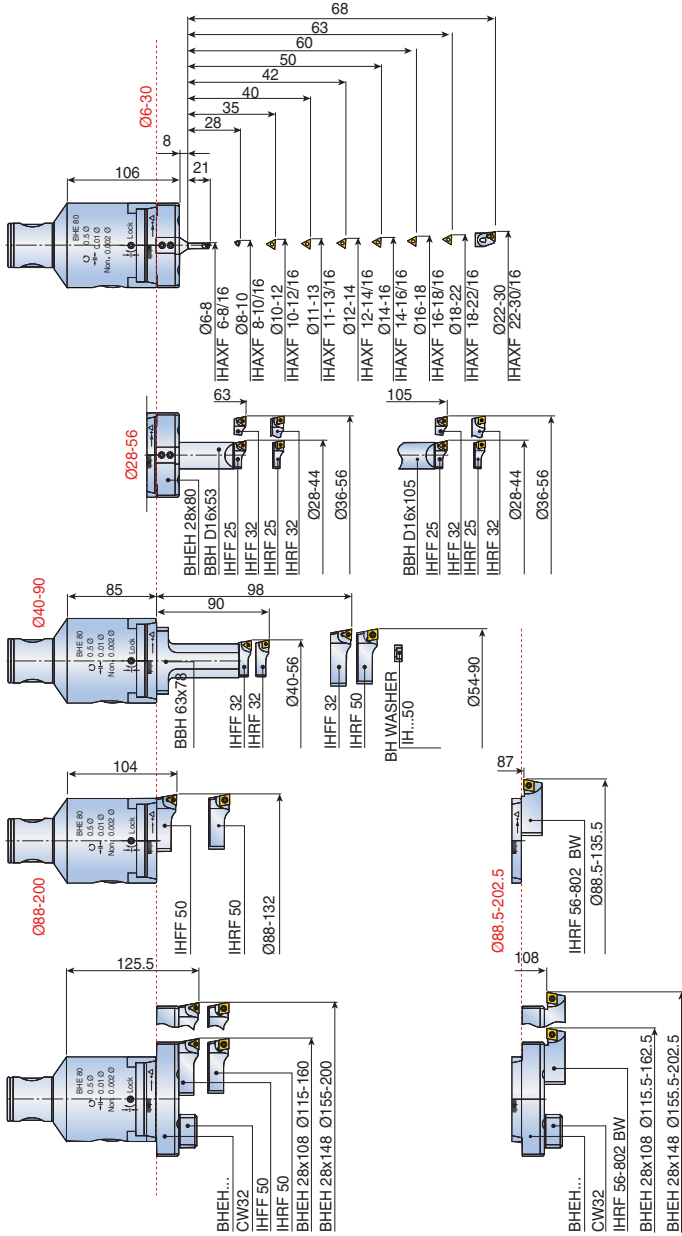

BHF fine boring heads

These intricate boring heads enable fine radial adjustments as small as 0.002mm whilst accomplishing high precision machining to the strictest of tolerances with a superb surface finish.

2µm



Fine boring head diameter range

	0	10	20	30	40	50	60	70	80	90	100	110	120	130	150	180	280	400	600	700	800	
BHF MB 16-16x34 RV				18-23																		
20-20x40 RV				22-29																		
25-25x50					28-38																	
32-32x63						36-50																
40-40x80							48-63															
50-50x60													2.5-108									
50-63x87														2.5-125								
50-80x94															2.5-160							
63-63x87														2.5-125								
80-80x94															2.5-160							
80-125x114																					36-500	

BHF MB16-MB40 Diameter range: 18-63

BHF MB16-16x34 RV

18-23

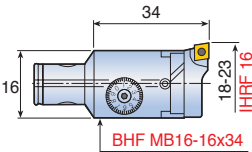

BHF MB20-20x40 RV

22-29

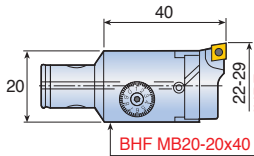

BHF MB25-25x50

28-38

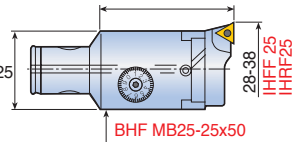

BHF MB32-32x63

36-50

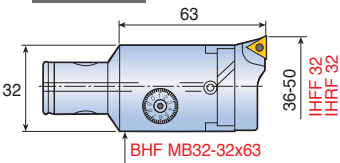

BHF MB40-40x80

48-63

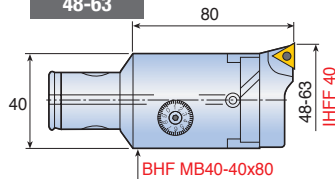

Fine boring head range: 2µm direct diametric adjustment

BHF MB50-50x60
Diameter range: 6-111

2µm

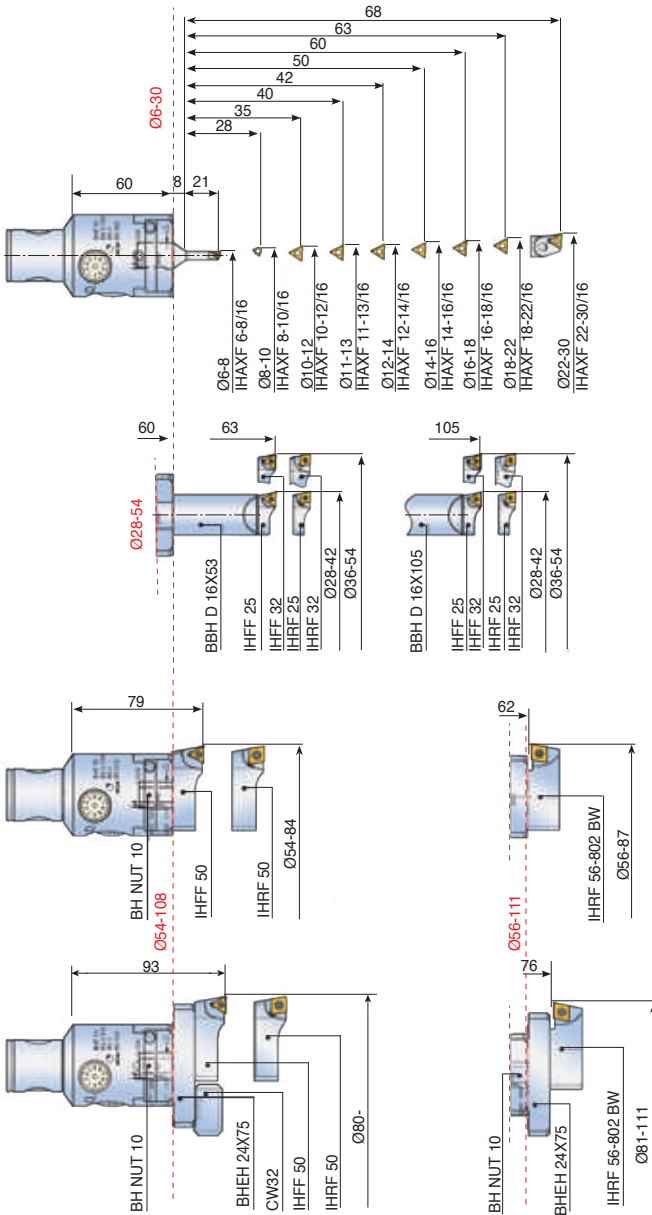

Fine boring head range: 2µm direct diametric adjustment

2µm

BHF MB50-63x87
BHF MB63-63x87
 Diameter range: 2.5-160

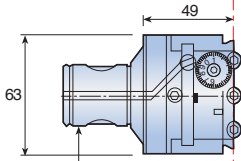

BHF MB50-63x87

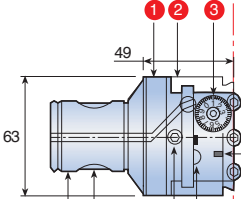

BHF MB63-63x87

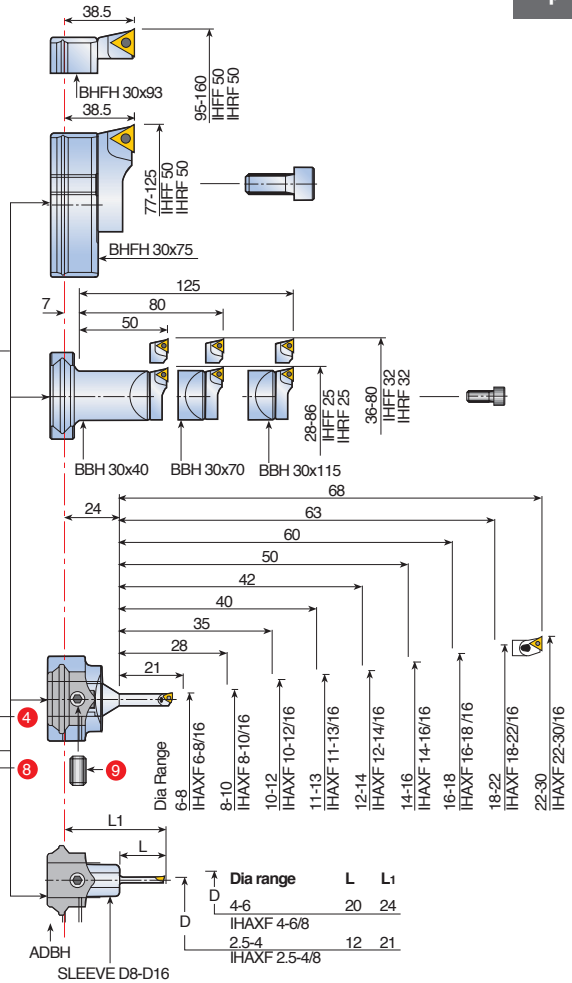

ADBH
 SLEEVE D8-D16

- 1 Body
- 2 Tool slide
- 3 Graduated dial
- 4 Toolholder locking screw
- 5 Expanding pin
- 6 Slide locking screw
- 7 Coolant nozzle
- 8 Oiling nipple
- 9 Toolholder locking screw

Fine boring head range: 2µm direct diametric adjustment

2µm

BHF MB50-80x94
BHF MB80-80x94
Diameter range: 2.5-220

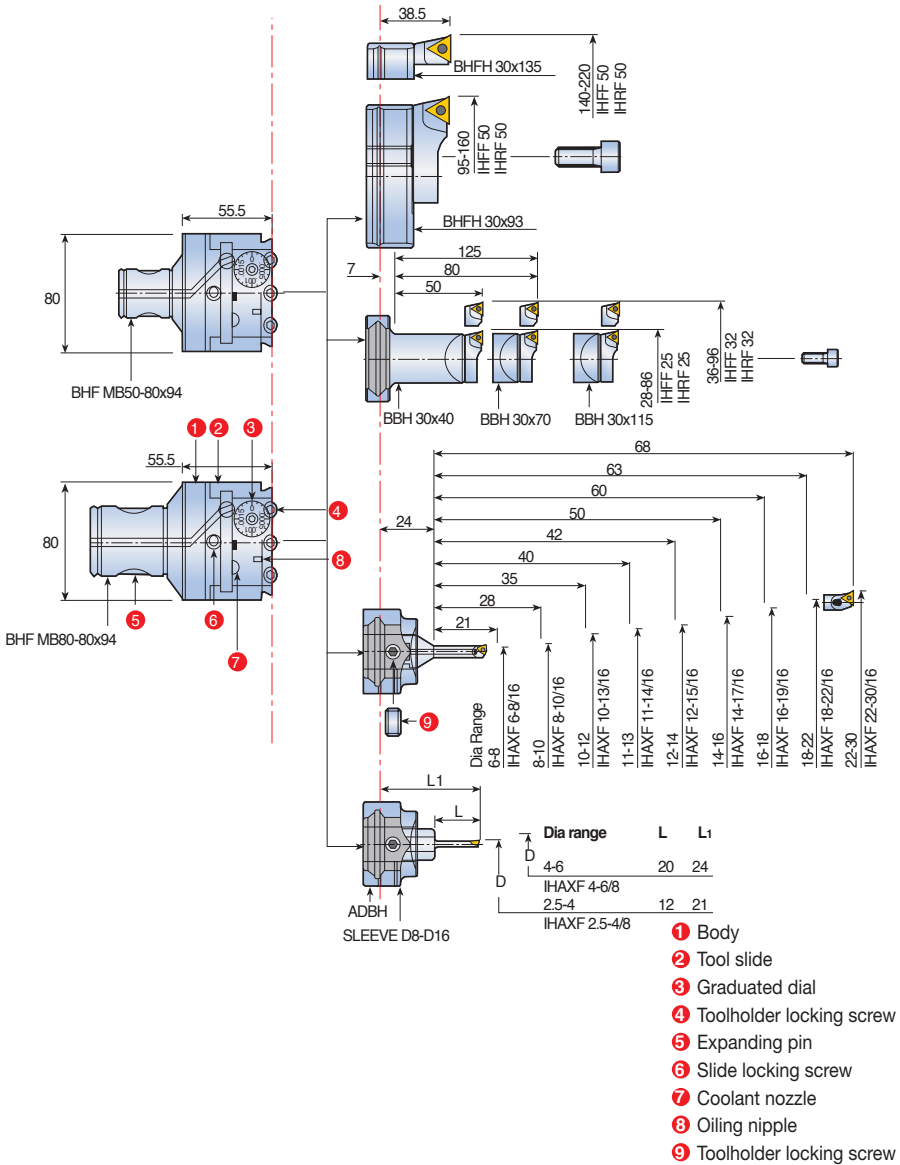

Fine boring head range: 2µm direct diametric adjustment

2µm

BHF MB80-125x114
Diameter range:36-500

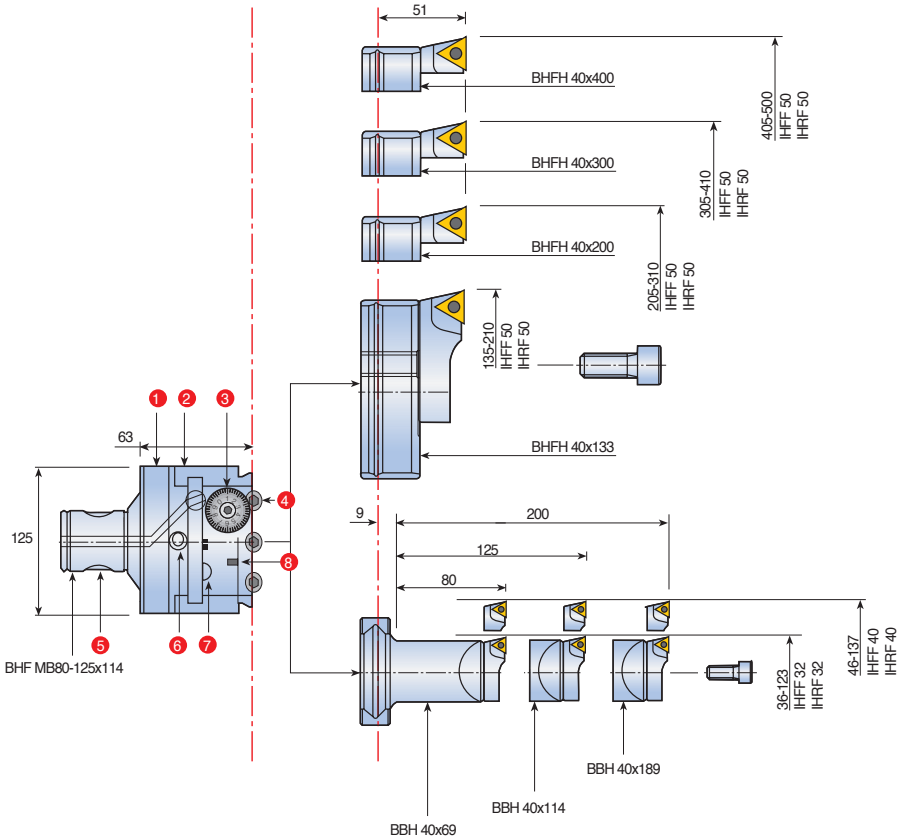

Vibration dampening for fine boring bars – Heavy metal shank

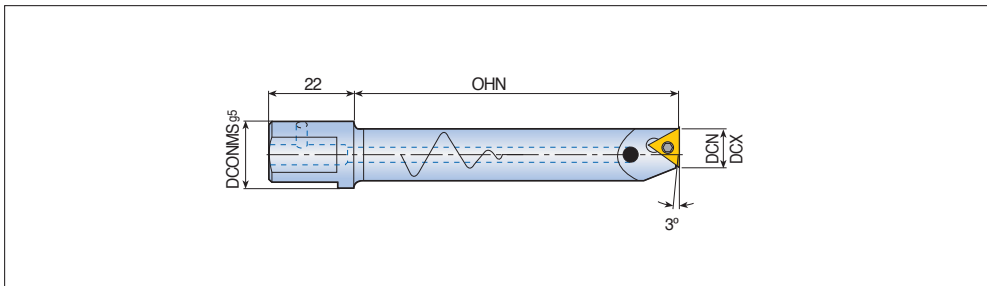

Designation	Dimension (mm)				Spare parts		
	DCN	DCX	OHN	DCONMS	Insert	Screw	Key
IHAXF 6-8-AVI	6	8	36	16	WCGT 0201..	SR 14-299	T 6
8-10-AVI	8	10	48	16	WCGT 0201..	SR 14-299	T 6
10-12-AVI	10	12	60	16	TPGX 0902..	SO 25061I	T 8
12-14-AVI	12	14	72	16	TPGX 0902..	SO 25061I	T 8
14-16-AVI	14	16	84	16	TPGX 0902..	SO 25061I	T 8
16-18-AVI	16	18	96	16	TPGX 0902..	SO 25061I	T 8

IHAXF-E

Fine Boring Bar

Vibration dampening for fine boring bars – Carbide shank

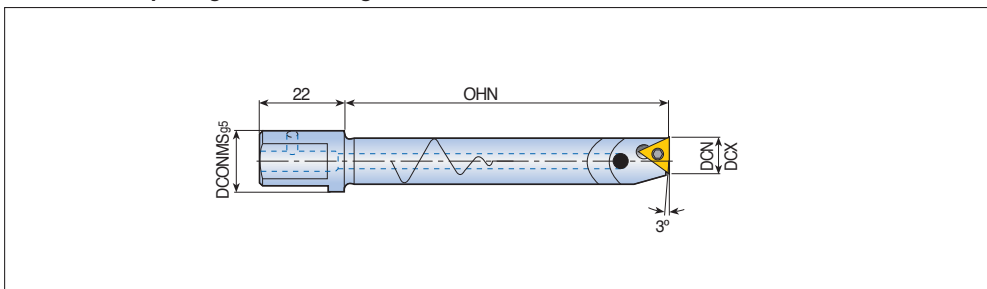

Designation	Dimension (mm)				Spare parts		
	DCN	DCX	OHN	DCONMS	Insert	Screw	Key
IHAXF 6-8-E	6	8	45	16	WCGT 0201..	SR 14-299	T 6
8-10-E	8	10	60	16	WCGT 0201..	SR 14-299	T 6
10-12-E	10	12	75	16	TPGX 0902..	SO 25061I	T 8
12-14-E	12	14	90	16	TPGX 0902..	SO 25061I	T 8
14-16-E	14	16	105	16	TPGX 0902..	SO 25061I	T 8
16-18-E	16	18	120	16	TPGX 0902..	SO 25061I	T 8



Slide extensions for fine boring holders

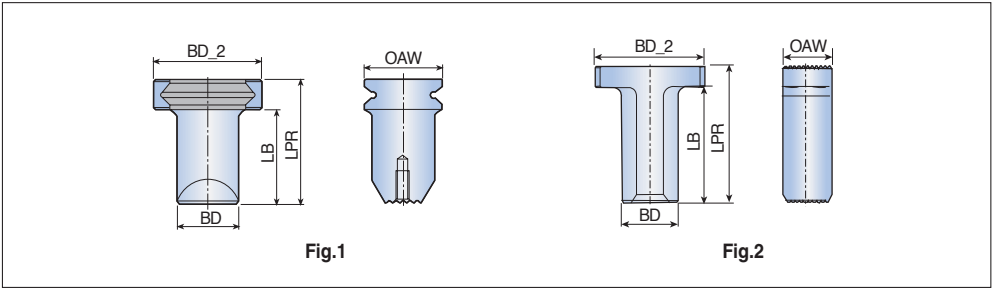

Designation	Dimension (mm)					Kg	Fig.
	BD	LB	LPR	BD_2	OAW		
BBH 30x40	25	40	52.5	43	30.5	0.3	1
30x70	25	70	82.5	43	30.5	0.4	1
30x115	27	115	127.5	43	30.5	0.7	1
40x69	32	69	86	56	40	0.7	1
40x114	32	114	131	56	40	1.0	1
40x189	38	189	206	56	40	2.0	1
63x78	32	66	78	63	28	0.7	2

Sleeve for fine boring holders

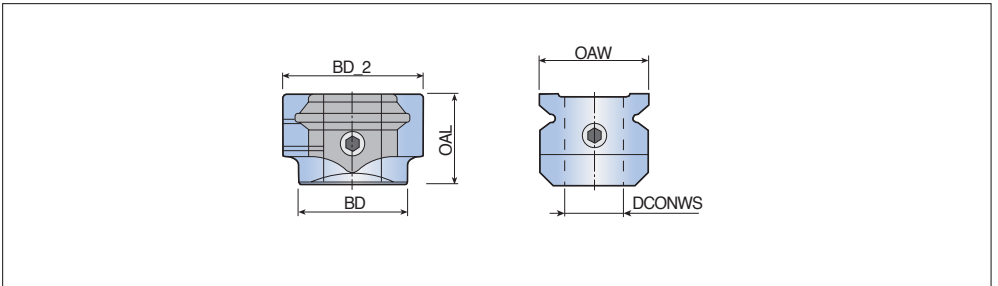

Designation	Dimension (mm)					Kg
	BD	BD_2	OAL	OAW	DCONWS	
ADBH 30xD16	30	39	25	30.5	16	0.2

BHFH/BHEH

Fine Boring Insert Holders & Slides

Slide for BHF & BHE fine boring holders

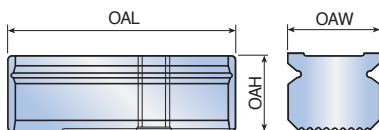

Fig.1

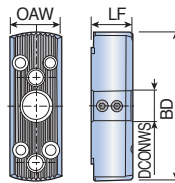

Fig.2

Designation	Dimension (mm)						Kg	Fig.
	OAH	OAL	OAW	BD	LF	DCONWS		
BHFH 30x75	25	75	30.5	-	-	-	0.4	1
30x93	25	93	30.5	-	-	-	0.5	1
30x135	25	135	30.5	-	-	-	0.7	1
40x133	40	133	40	-	-	-	1.5	1
40x200	40	200	40	-	-	-	2.4	1
40x300	40	300	40	-	-	-	3.5	1
40x400	40	400	40	-	-	-	4.6	1
BHEH 24x75	-	-	24	75	14.5	-	0.2	2
28x80	-	-	28	80	22.5	16	0.3	2
28x108	-	-	28	108	22.5	-	0.5	2
28x148	-	-	28	148	22.5	-	0.6	2

CW32

Fine Boring Insert Holders & Slides

Counter balancing weight

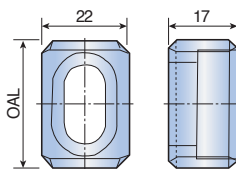

Designation	Dimension (mm)		Kg
	OAL		
CW 32	31.5		0.5

Positive 7° clearance 80° rhombic inserts

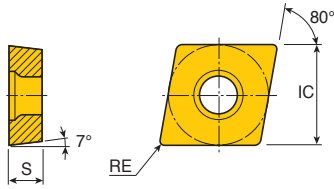

Size	Dimension (mm)		
	IC	S	RE
06	6.35	2.38	0.1-0.8
09	9.52	3.97	0.1-0.8
12	12.7	4.76	0.2-1.2

Insert	Designation	Cermet		CVD coated										PVD coated				Uncoated			
		PV3010	CT3000	TT7005	TT7015	TT7025	TT8105B	TT8115B	TT8125B	TT8135B	TT9215	TT9225	TT9235	TT5100	TT5080	TT8020	TT9020	TT9080	P20	K10	K20
	CCMT 060204 MT	●	●	●	●		●	●	●	●	●	●	●	●	●						●
	060208 MT	●	●	●	●			●	●	●			●	●	●						
	09T304 MT	●	●	●	●	●			●	●		●	●	●	●	●					
	09T308 MT		●	●	●	●			●	●	●		●	●	●	●					
	120404 MT	●	●	●	●				●	●				●		●					
	120408 MT		●	●	●	●			●	●	●		●	●	●	●	●				
	120412 MT			●					●	●				●							
	CCGT 060201 SA													●		●					
	060202 SA													●		●					
	060204 SA													●		●					
	09T301 SA													●		●					
	09T302 SA													●		●					
	09T304 SA													●		●					
	09T308 SA													●		●	●				
	09T308 SA													●		●					
	CCGT 060202 FL																			●	
	060204 FL																			●	
	09T302 FL																			●	
	09T304 FL																			●	
	09T308 FL																			●	
	120402 FL																			●	
	120404 FL																			●	
	120408 FL																			●	

● : Standard items

Positive 7° clearance 55° rhombic inserts

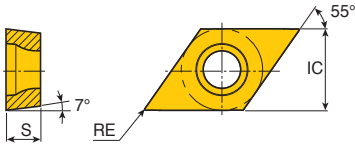

Size	Dimension (mm)		
	IC	S	RE
07	6.35	2.38	0.4-0.8
11	9.52	3.97	0.4-1.2

Insert	Designation	Cermet		CVD coated								PVD coated				Uncoated					
		PV3010	CT3000	TT7005	TT7015	TT8105B	TT8115B	TT8125B	TT8135B	TT9215	TT9225	TT9235	TT5100	TT7100	TT5080	TT8020	TT9020	TT9080	P20	K10	K20
	DCMT 070204 PC					●	●		●	●							●				
	070208 PC					●	●		●	●							●				
	11T304 PC					●	●		●	●							●				
	11T308 PC					●	●		●	●							●				
	11T312 PC						●	●		●	●						●				

● : Standard items

SCGT

Boring Inserts

Positive 7° clearance inserts for aluminum machining

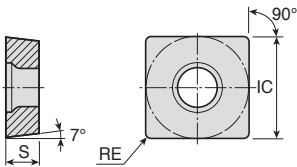

Size	Dimension (mm)		
	IC	S	RE
09	9.52	3.97	0.8
12	12.7	4.76	0.2-0.8

Insert	Designation	Cermet		CVD coated								PVD coated				Uncoated							
		PV3010	CT3000	TT7005	TT7015	TT8105B	TT8115B	TT8125B	TT8135B	TT9215	TT9225	TT9235	TT5100	TT7100	TT5080	TT8020	TT9020	TT9080	P20	K10	K20		
	SCGT 09T308 FL																			●			
	120402 FL																				●		
	120404 FL																				●		
	120408 FL																				●		

● : Standard items

Positive 7° clearance square inserts

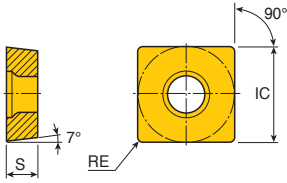

Size	Dimension (mm)		
	IC	S	RE
09	9.52	3.97	0.4-0.8
12	12.7	4.76	0.4-1.2

Insert	Designation	Cermet		CVD coated										PVD coated			Uncoated						
		PV3010	CT3000	TT7005	TT7015	TT7025	TT8105B	TT8115B	TT8125B	TT8135B	TT9215	TT9225	TT9235	TT5100	TT7100	TT5080	TT8020	TT9020	P20	K10	K20		
	SCMT 09T304 FG							●					●										
	09T308 FG							●	●				●	●		●	●						
	SCMT 09T304 MT	●	●	●	●		●	●	●			●		●			●						
	09T308 MT		●	●	●	●		●	●	●		●	●	●	●		●	●					
	120404 MT		●	●	●			●	●				●										
	120408 MT		●	●	●	●		●	●	●		●	●	●		●	●						
	120412 MT			●	●		●		●	●							●						

● : Standard items

TCMT

Boring Inserts

Positive 7° clearance triangular inserts

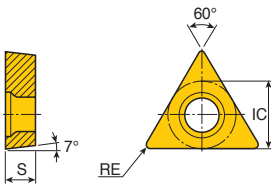

Size	Dimension (mm)		
	IC	S	RE
22	12.7	4.76	0.8

Insert	Designation	Cermet		CVD coated										PVD coated			Uncoated						
		PV3010	CT3000	TT7005	TT7015	TT8105B	TT8115B	TT8125B	TT8135B	TT9215	TT9225	TT9235	TT5100	TT7100	TT5080	TT8020	TT9020	TT9080	P30	K10	K20		
	TCMT 220508-19																		●				

● : Standard items

Positive 11° clearance triangular inserts

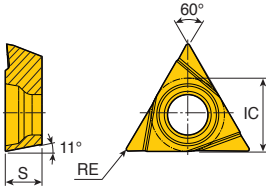

Size	Dimension (mm)		
	IC	S	RE
09	5.56	2.38	0.2-0.4
11	6.35	3.18	0.2-0.4

Insert	Designation	Cermet		CVD coated								PVD coated		Uncoated							
		PV3010	CT3000	TT7005	TT7015	TT8105B	TT8115B	TT8125B	TT8135B	TT9215	TT9225	TT9235	TT5100	TT7100	TT5080	TT8020	TT9020	P20	P30	K10	K20
 Left-hand	TPGX 090202 L	●																			
	090204 L	●																		●	
	110302 L	●																		●	
	110304 L	●																		●	

● : Standard items

WCGT

Boring Inserts

Positive 7° clearance 80° trigon inserts

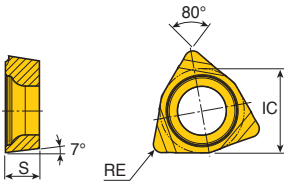

Size	Dimension (mm)		
	IC	S	RE
02	3.97	1.59	0.2-0.4

Insert	Designation	Cermet		CVD coated								PVD coated		Uncoated							
		PV3010	CT3000	TT7005	TT7015	TT8105B	TT8115B	TT8125B	TT8135B	TT9215	TT9225	TT9235	TT5100	TT7100	TT5080	TT8020	TT9030	TT9080	P20	K10	K20
	WCGT 020102L															●					
	020104L															●					

● : Standard items

KIT BHE MB50-50 6-110

Kits

Boring kit BHE MB50-50 (ø6-110mm) with fine boring head

10µm
2µm

Ø6-30
 IHAXF 6-8/16
 IHAXF 8-10/16
 IHAXF 11-13/16
 IHAXF 16-18/16
 IHAXF 22-30/16

Ø28-56
 BBH D16x53
 IHFF 25
 IHFF 32

Ø54-86
 IHFF 50

Ø80-110
 BHEH 24x73
 IHFF 50

Ø92-110
 CW 32
 BHEH 24x75
 IHFF 50

- 1 BHE MB50-50x80
- 1 IHFF 25
- 1 IHFF 32
- 1 IHFF 50
- 1 IHAXF 6-8/16
- 1 IHAXF 8-10/16
- 1 IHAXF 11-13/16
- 1 IHAXF 16-18/16
- 1 IHAXF 22-30/16
- 1 IHAXF 16-18/16
- 1 IHAXF 22-30/16
- 1 BH D16x53
- 1 BH NUT 10
- 1 BHEH 24x73
- 1 BHEH 24x75
- 1 CW 32
- 1 BH WASHHER IH..50
- 1 BH WASHHER IH..50
- 1 BH WASHHER IH..50
- 1 BH WASHHER IH..50

Designation	Dimension (mm)	
	SS	Boring range
KIT BHE MB50-50 6-110	MB50	6-110

▶ 10µm direct diametric adjustment and 2µm by a vernier scale

KIT BHE MB63-63 6-125

Kits

Boring kit BHE MB63-63 (ø6-125mm) with fine boring head

10µm
2µm

Ø6-30
 BHEH 28x80
 IHAXF 6-8/16
 IHAXF 8-10/16
 IHAXF 11-13/16
 IHAXF 16-18/16
 IHAXF 22-30/16

Ø40-90
 BH D16x53
 IHFF 32
 IHFF 50

Ø88-132
 SFTP 50

Ø115-200
 BHEH...
 CW 32
 SFTP 50
 Ø115-160 BHEH 28x108
 Ø155-200 BHEH 28x148

- 1 BHE MB63-63x89
- 1 IHFF 32
- 1 IHFF 50
- 1 IHFF 6-8/16
- 1 IHAXF 8-10/16
- 1 IHAXF 11-13/16
- 1 IHAXF 16-18/16
- 1 IHAXF 22-30/16
- 1 BHEH 63x78
- 1 BHEH 28x80
- 1 CW 32
- 1 BH WASHHER IH..50
- 1 BH WASHHER IH..50
- 1 BH WASHHER IH..50
- 1 BH WASHHER IH..50

Designation	Dimension (mm)	
	SS	Boring range
KIT BHE MB63-63 6-125	MB63	6-125

KIT BHE MB80-80 6-200

Kits

Boring kit BHE MB80-80 (ø6-200mm) with fine boring head

10µm
2µm

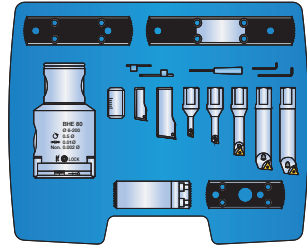
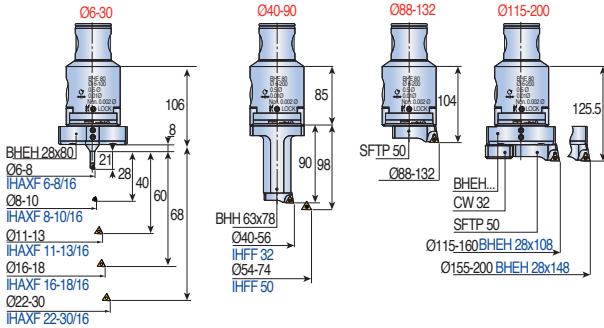

- 1 BHE MB80-80x104
- 1 IHFF 32
- 1 BHFF 6-8/16
- 1 IHAXF 8-10/16
- 1 IHAXF 11-13/16
- 1 IHAXF 16-18/16
- 1 IHAXF 22-30/16
- 1 BHFF 63x78
- 1 BHEH 28x80
- 1 BHEH 28x108
- 1 BHEH 28x148
- 1 BH WASHER IH..50
- 1 CW 32

Designation	Dimension (mm)	
	SS	Boring range
KIT BHE MB80-80 6-200	MB80	6-200

KIT BHF MB50-80/80-80

Kits

Kit BHF MB50-80 / Kit BHF MB80-80 6-220mm diameter range

2µm

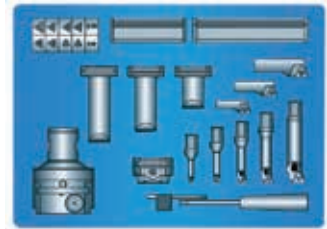
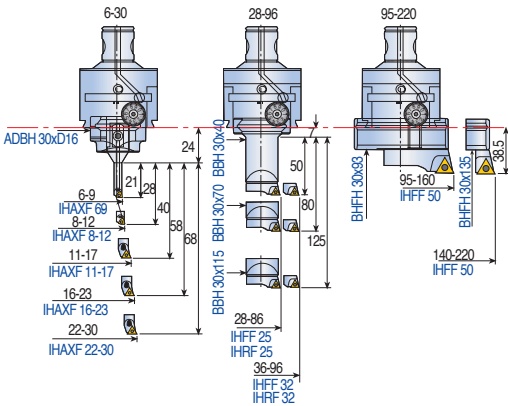

- 1 BHF MB.-80x94
- 1 IHAXF 6-8/16
- 1 IHAXF 8-10/16
- 1 IHAXF 11-13/16
- 1 IHAXF 16-18/16
- 1 IHAXF 22-30/16
- 1 ADBH 30xD16
- 1 BBH 30x40
- 1 BBH 30x70
- 1 BBH 30x115
- 1 BHFH 30x93
- 1 BHFH 30x135
- 1 IHFF 25
- 1 IHFF 32
- 1 IHFF 50
- 5 TPGX 090202L
- 1 TPGX 110302L
- 2 WCGT 020102L
- T-8/5
- T-6/5

Designation	Dimension (mm)	
	SS	Boring range
KIT BHF MB50-80 6-220	MB50	6-220
MB80-80 6-220	MB80	6-220

KIT BHFH MB80-125

Kits

Kit BHFH MB80-125 holder for BHF MB80-125x114,36-410mm diameter range

2µm

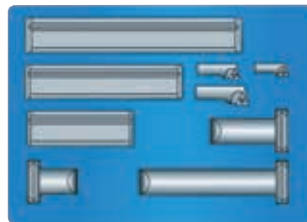
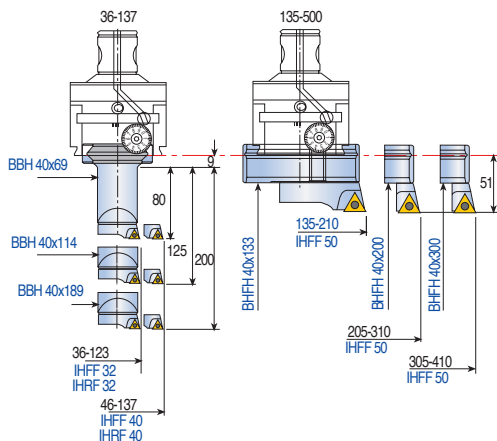

- 1 BBH 40x69
- 1 BBH 40x114
- 1 BBH 40x189
- 1 BHFH 40x133
- 1 BHFH 40x200
- 1 BHFH 40x300
- 1 IHFF 25
- 1 IHFF 40
- 1 IHFF 50

Designation	Dimension (mm)	
	SS	Boring range
KIT BHFH MB80-125	MB80	36-410

► 10µm direct diametric adjustment and 2µm by a vernier scale

MB system clamp set

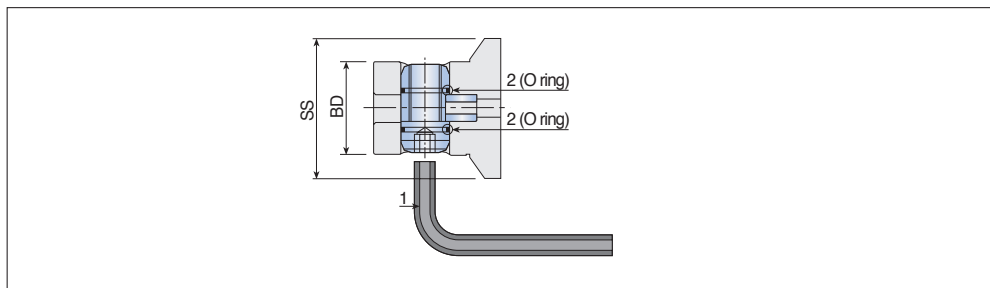

Designation	Dimension (mm)			
	SS	BD	1	2
BH MB 16 COUPLING SET	MB16	10	2.5	-
20 COUPLING SET	MB20	13	3	-
25 COUPLING SET	MB25	16	3	-
32 COUPLING SET	MB32	20	4	ORM 0100-10
40 COUPLING SET	MB40	25	5	ORM 0130-10
50 COUPLING SET	MB50	32	6	ORM 0140-10
63-80 COUPLING SET	MB63-80	42	8	OR 2075

PLT

Cover plate

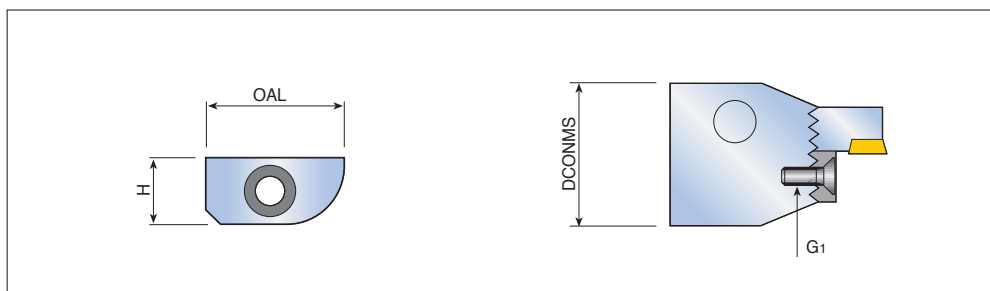

Designation	Dimension (mm)			
	DCONMS	H	OAL	G1
PLT 16	16	7	14	M 3x8
20	20	8.5	17	M 4x10
25	25	10.2	21	M 4x16
32	32	13.9	28	M 5x20
40	40	17.4	35	M 6x25
50	50	21.4	47.5	M 8x25
63	63	26.4	62	M 10x30
80	80	33.9	82.5	M 12x35

► Protects the serrated faces when a single toolholder is being used.

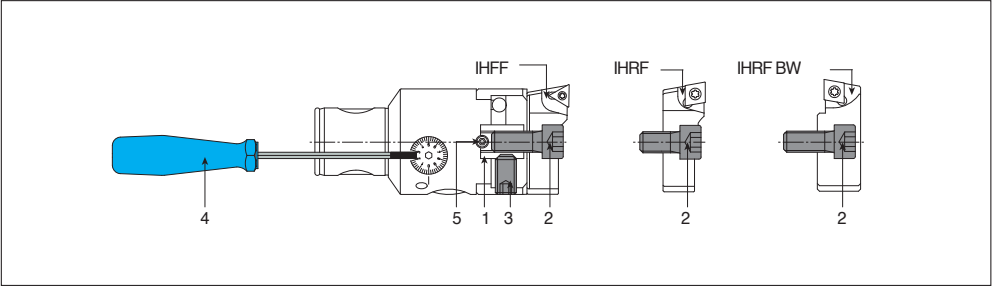

Designation	1	2	3	4	5
BHF...- 16...	-	SR M3x6 DIN 912	-	BH HW 1.5 HANDLE SR M3x4.5 DIN 913	
20...	-	SR M4x8 DIN 912	-	BH HW 1.5 HANDLE SR M3x4.5 DIN 913	
25...	-	SR M5x10 DIN 912	-	BH HW 2.0 HANDLE SR M4x4 DIN 913	
32...	-	SR M6x12 DIN 912	-	BH HW 2.0 HANDLE SR M4x5 DIN 913	
40...	-	SR M8x14 DIN 912	-	BH HW 2.5 HANDLE SR M5x6 DIN 913 SR	
50-60	BH NUT 10	SR M10x25 DIN 912	SR M10x16 DIN 913	BH HW 2.5 HANDLE SR M5x8 DIN 913	

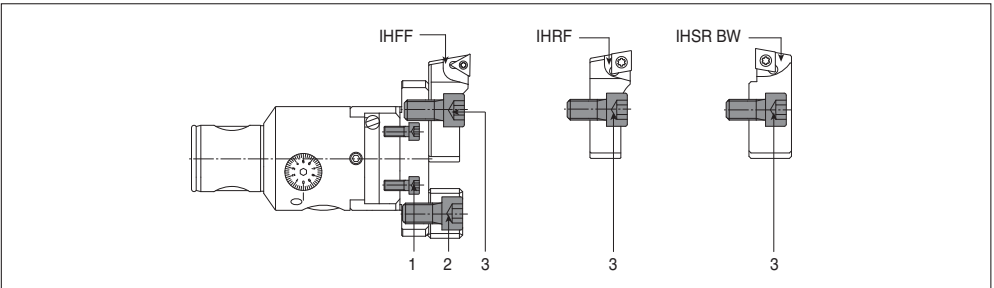

Designation	1	2	3
BHF...- 50...	SR M5x12 DIN 912	SR M10x20 DIN 912	SR M10x25 DIN 912

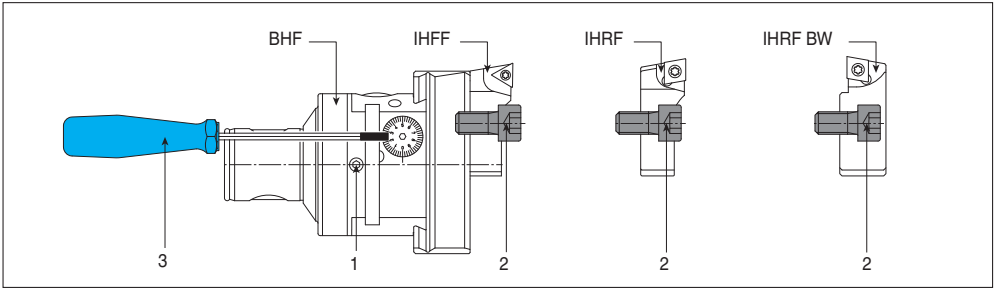

Designation	1	2	3
BHF...- 63...	SR M6x10 DIN 915	SR M10x25 DIN 912	BH HW 3.0 HANDLE
80...	SR M6x14 DIN 915	SR M10x25 DIN 912	BH HW 3.0 HANDLE
125...	SR M6x22 DIN 915	SR M10x25 DIN 912	BH HW 3.0 HANDLE

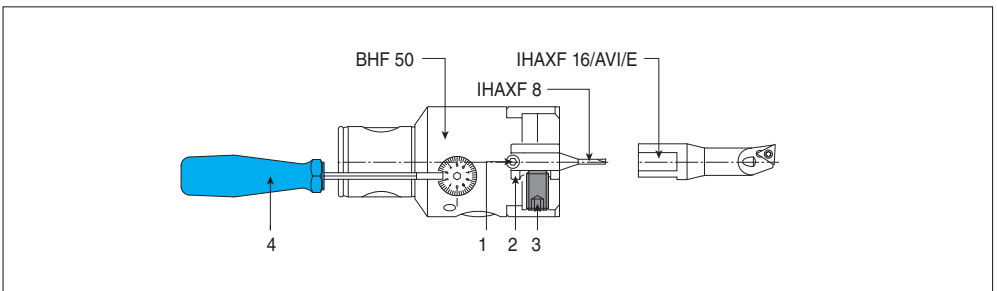

Designation	1	2	3	4
BHF...- 50...	SR M5x8 DIN 913	SLEEVE D8-D16	SR M10x10 DIN 913	BH HW 2.5 HANDLE

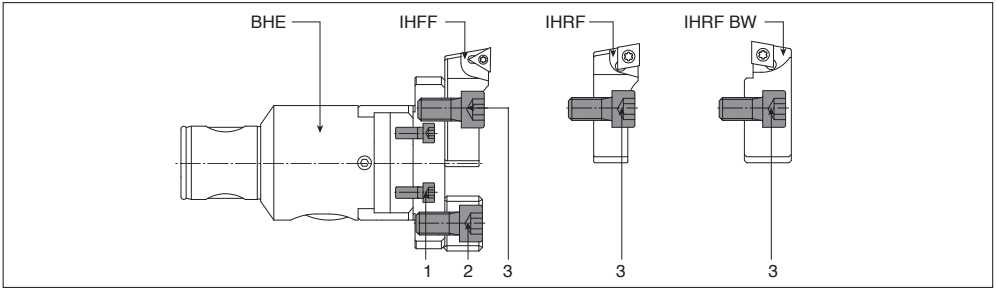

Designation	1	2	3
BHE MB50-50x80	SR M5x12 DIN 912	SR M10x20 DIN 912	SR M10x25 DIN 912
MB63-63x89	SR M5x25 DIN 912	SR M10x20 DIN 912	SR M10x25 DIN 912
MB80-80x104	SR M5x25 DIN 912	SR M10x20 DIN 912	SR M10x25 DIN 912

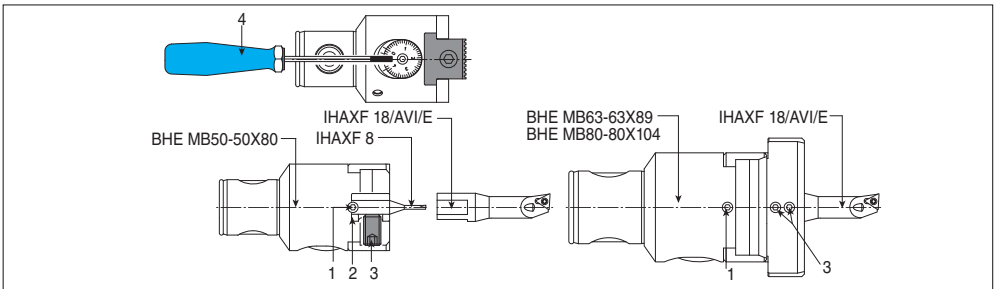

Designation	1	2	3	4
BHE MB50-50x80	SR M6x8 DIN 913	SLEEVE D 8-D16	SR M10x10 DIN 913	BH HW 3.0 HANDLE
MB63-63x89	SR M6x8 DIN 913	-	SR M6x6 DIN 913	BH HW 3.0 HANDLE
MB80-80x104	SR M6x12 DIN 913	-	SR M6x6 DIN 913	BH HW 3.0 HANDLE

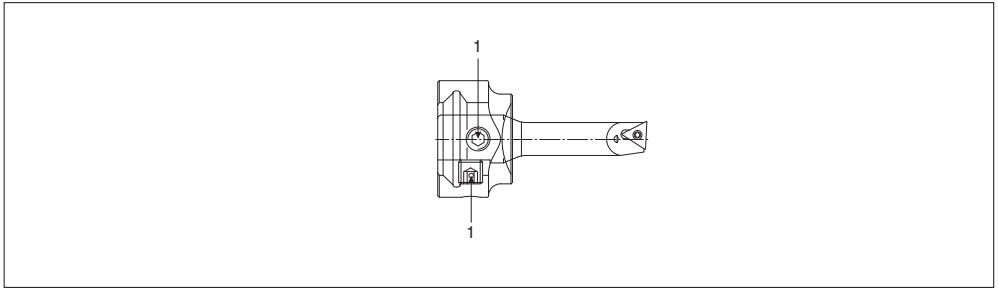

Designation	1
ADBH 30xD16	SR M8x8 DIN 915

BHFH

Spare Parts

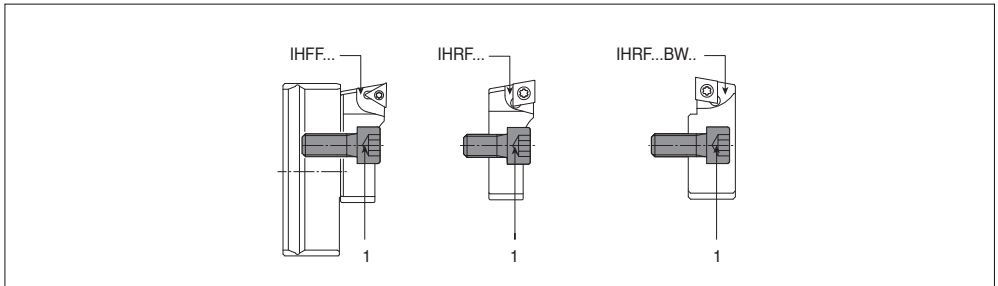

Designation	1
BHFH 30x75	SR M10x18 DIN 912
40x133	SR M10x18 DIN 912
30x93	SR M10x18 DIN 912
40x200	SR M10x25 DIN 912
30x135	SR M10x25 DIN 912
40x300	SR M10x25 DIN 912
40x400	SR M10x25 DIN 912

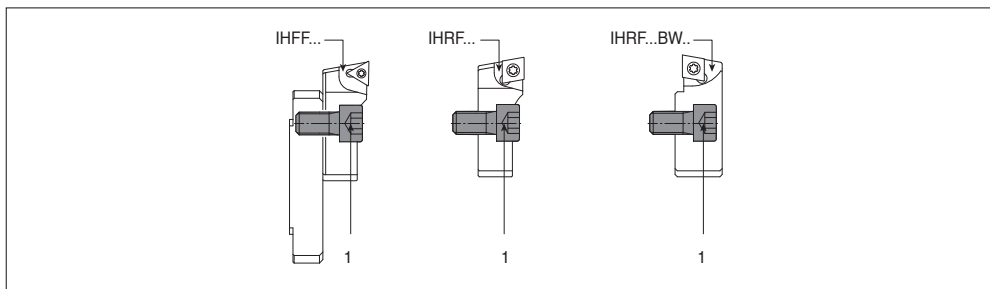

Designation	1
BHEH 24x75	SR M10x20 DIN 912
28x80	SR M10x25 DIN 912
28x108	SR M10x25 DIN 912
28x148	SR M10x25 DIN 912

EMH MB

Spare Parts

Screws for EMH

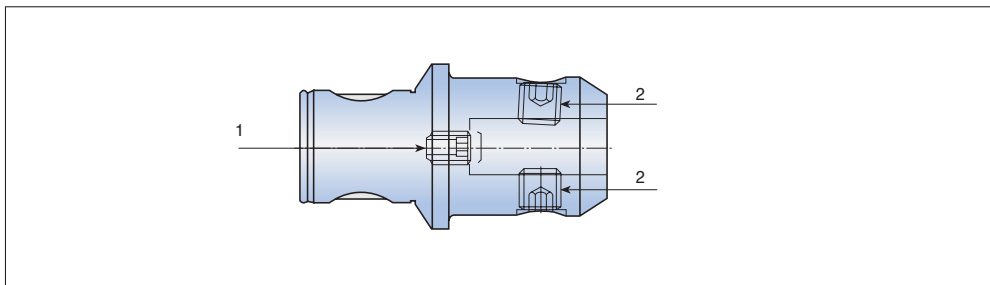

Designation	Screw #1	Screw # 2
EMH MB50-6	BH EMH PRST M8X8B	SR M6X10 DIN1835B
MB50-8	BH EMH PRST M8X8B	BH EMH M8X9.5
MB50-10	BH EMH PRST M8X10B	BH EMH M10X11.5
MB50-12	BH EMH PRST M8X10B	BH EMH M12X15.5
MB50-14	BH EMH PRST M8X10B	BH EMH M12X15.5
MB50-16	BH EMH PRST M12X16B	BH EMH M14X15.5
MB50-20	BH EMH PRST M12X16B	BH EMH M16X15.5
MB63-16	BH EMH PRST M12X16B	BH EMH M14X15.5
MB63-20	BH EMH PRST M12X16B	BH EMH M16X15.5
MB63-25	BH EMH PRST M16X16B	BH EMH M18X19.5
MB63-32	BH EMH PRST M16X16B	BH EMH M20X19.5

Components for CC

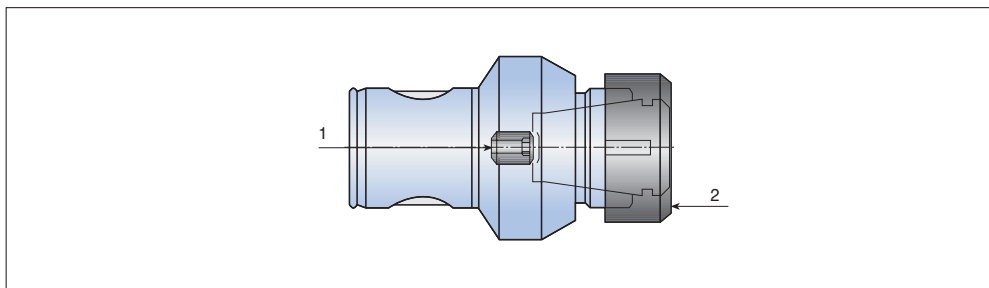

Designation	1	2	Wrench
CC MB16-ER11M	CC MB16 SCREW	NUT ER11 MINI	WRENCH ER11 MINI
MB20-ER16M	CC MB20 SCREW	NUT ER16 MINI	WRENCH ER16 MINI
MB25-ER20M	CC MB25 SCREW	NUT ER20 MINI	WRENCH ER20 MINI
MB32-ER25M	CC MB32 SCREW	NUT ER25 MINI	WRENCH ER25 MINI
MB40-ER25	CC MB40 SCREW	NUT ER25 TOP	WRENCH ER25
MB50-ER25	CC MB50 SCREW	NUT ER25 TOP	WRENCH ER25
MB50-ER32	CC MB50 SCREW	NUT ER32 TOP	WRENCH ER32
MB63-ER32	CC MB63 SCREW	NUT ER32 TOP	WRENCH ER32
MB63-ER40	CC MB63 SCREW	NUT ER40 TOP	WRENCH ER40

AMT MB-MT

Spare Parts

Screw for shanks: Morse taper tang AMT

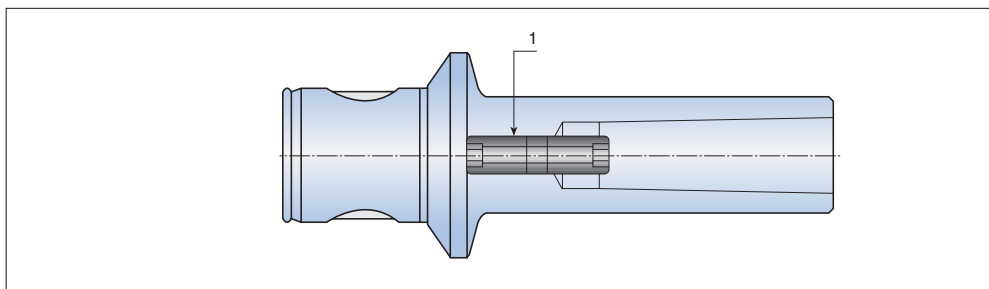

Designation	1
AMT MB50-MT2	AMT MT2-SCREW
MB50-MT3	AMT MT3-SCREW
MB63-MT3	AMT MT3-SCREW
MB63-MT4	AMT MT4-SCREW

Screw for shell mill holders SMH

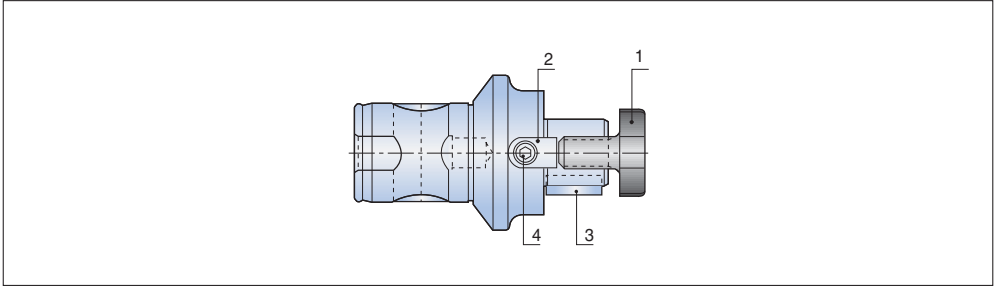

Designation	1	2	3	4
SMH MB40-22	M10 CLAMP SCREW SEM 22	BH DOG DRIVE SMH 22	KEY SMH 22	M4x10 SMH KEY SCREW
MB50-16	M 8 CLAMP SCREW SEM 16	BH DOG DRIVE SMH 16	KEY SMH 16	M3x 8 SMH KEY SCREW
MB50-22	M10 CLAMP SCREW SEM 22	BH DOG DRIVE SMH 22	KEY SMH 22	M4x10 SMH KEY SCREW
MB50-27	M12 CLAMP SCREW SEM 27	BH DOG DRIVE SMH 27	KEY SMH 27	M5x12 SMH KEY SCREW
MB50-32	M16 CLAMP SCREW SEM 32	BH DOG DRIVE SMH 32	KEY SMH 32	M6x16 SMH KEY SCREW
MB63-27	M12 CLAMP SCREW SEM 27	BH DOG DRIVE SMH 27	KEY SMH 27	M5x12 SMH KEY SCREW
MB63-32	M16 CLAMP SCREW SEM 32	BH DOG DRIVE SMH 32	KEY SMH 32	M6x16 SMH KEY SCREW
MB80-32	M16 CLAMP SCREW SEM 32	BH DOG DRIVE SMH 32	KEY SMH 32	M6x16 SMH KEY SCREW
MB80-40	M20 CLAMP SCREW SEM 40	BH D OG DRIVE SMH 40	KEY SMH 40	M6x18 SMH KEY SCREW

NUT ER TOP

ER - Top™ clamping nut



Designation	Dimension (mm)		
	DLN	HLN	THSZMS
NUT ER16 TOP	28	17	M22x1.5
ER20 TOP	34	19	M25x1.5
ER25 TOP	42	20	M32x1.5
ER32 TOP	50	22	M40x1.5
ER40 TOP	63	25	M50x1.5

ER clamping nut

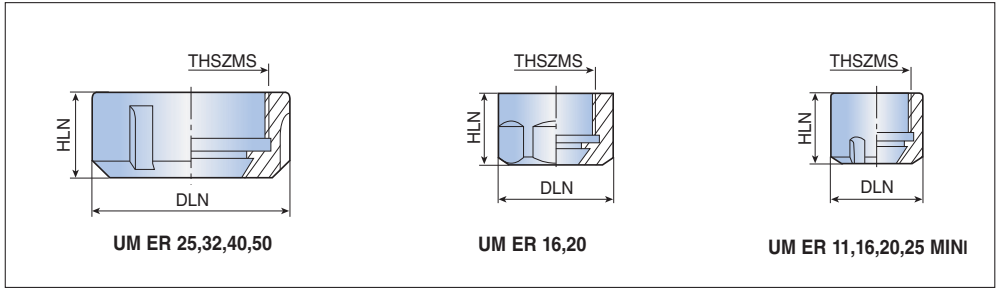

Designation	Dimension (mm)		
	DLN	HLN	THSZMS
NUT ER11 MINI	16	10.8	M13x0.75
ER11 UM	19	11.3	M14x 0.75
ER16 MINI	22	18	M19x1.0
ER16 UM	28	17	M22x1.5
ER20 MINI	28	19	M24x1.0
ER20 UM	34	19	M25x1.5
ER25 MINI	35	20	M30x1.5
ER25 UM	42	20	M32x1.5
ER32 UM	50	22	M40x1.5
ER40 UM	63	25	M50x1.5
ER50 UM	78	55	M64x2.0

Recommended Cutting Conditions

BHR rough boring heads

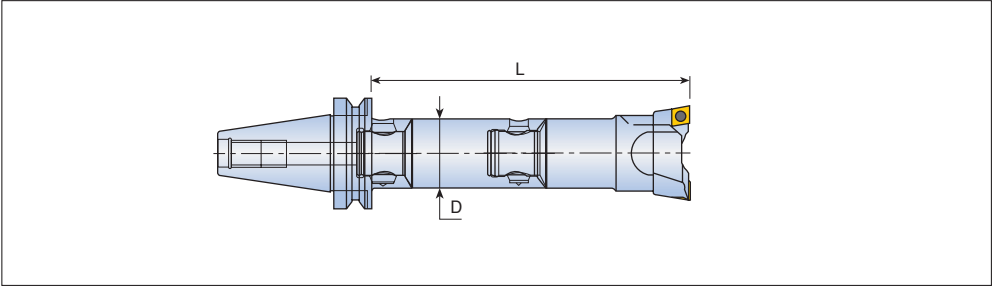

Cutting depth

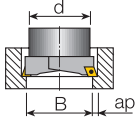

It's advisable to start with
 $B \text{ hole} \geq \text{boring bar diameter } d$

B Working range	ap (mm) Steel	ap (mm) Cast iron, Aluminum
18-20	1.5-2	2-2.5
28-50	2-3	2.5-3.5
50-68	3-4	3.5-5
68-200	4-5	5-7
200-500	5-6	6-8

► In case of a single or a stepped boring cutter configuration, only half the feed should be applied

Recommended Cutting Conditions

Fine boring heads

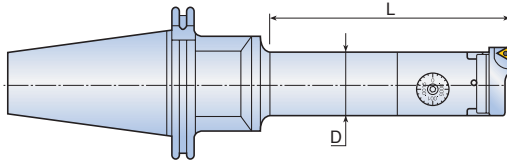

Stability ●●● – Good
 ●● – Normal
 ● – Poor

Material	L/D	Stability	Cutting speed (Vc=m/min)	Feed f=mm/rev		Cutting depth (ap)
				Insert radius		
				R=0.2	R=0.4	
Carbon steel HB≤200	L/D=2.5	●●●	200-300	0.05-0.08	0.08-0.10	
	L/D=4	●●	160-250	0.05-0.08	0.08-0.10	
	L/D=6.3	●	70-100	0.05-0.08	-	
Carbon steel HB>200	L/D=2.5	●●●	160-250	0.05-0.08	0.08-0.10	
	L/D=4	●●	150-200	0.05-0.08	0.08-0.10	
	L/D=6.3	●	70-100	0.05-0.08	-	
Stainless steel	L/D=2.5	●●●	150-200	0.05-0.08	0.08-0.10	
	L/D=4	●●	120-180	0.08-0.10	0.08-0.10	
	L/D=6.3	●	70-80	0.05-0.08	0.08-0.10	
Alloyed steel HB 480-550	L/D=2.5	●●●	120-160	0.05-0.08	0.08-0.10	
	L/D=4	●●	100-140	0.05-0.08	0.08-0.10	
	L/D=6.3	●	70-100	0.05-0.08	-	
Cast iron	L/D=2.5	●●●	120-160	0.05-0.08	0.08-0.10	
	L/D=4	●●	100-140	0.05-0.08	0.08-0.10	
	L/D=6.3	●	70-100	0.05-0.08	-	
Aluminum	L/D=2.5	●●●	300-400	0.05-0.08	0.08-0.10	
	L/D=4	●●	250-350	0.05-0.08	0.08-0.10	
	L/D=6.3	●	100-150	0.05-0.08	-	

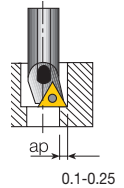

Recommended Cutting Conditions

Stability ●●● – Good
 ●● – Normal
 ● – Poor

BHR rough boring cutting data

ap(mm), R(radius), Vc(m/min), f(mm/rev)

ISO	Workpiece material	Hardness HB	Overhang L/D	Boring range D18-28		Boring range D28-50		Boring range D50-68		
				ap (mm)	0.5-1.2	1.2-2.5	0.8-1.5	1.5-2.5	0.8-1.5	1.5-3.0
				R (Radius)	0.2	0.4	0.2-0.4	0.4	0.2-0.4	0.4-0.8
P	Carbon steel	HB<200	2.5 ●●●	Vc	150-180	120-150	160-200	140-170	160-200	140-180
				f	0.1-0.2	0.08-0.2	0.15-0.2	0.1-0.175	0.15-0.25	0.08-0.2
			4 ●●●	Vc	140-160	100-140	160-180	120-150	160-180	120-150
				f	0.1-0.18	0.08-0.15	0.1-0.12	0.08-0.1	0.1-0.12	0.08-0.1
			6.3 ●●●	Vc	60-80	40-60	60-90	50-60	70-90	50-70
				f	0.06-0.12	0.06-0.1	0.06-0.12	0.06-0.1	0.06-0.1	0.06-0.1
	Carbon steel	HB>200	2.5 ●●●	Vc	130-160	100-130	140-180	120-160	140-180	120-160
				f	0.08-0.15	0.08-0.12	0.08-0.2	0.06-0.12	0.08-0.25	0.08-0.18
			4 ●●●	Vc	110-140	80-110	100-140	80-120	100-140	80-120
				f	0.08-0.12	0.08-0.1	0.08-0.15	0.06-0.15	0.08-0.2	0.06-0.15
			6.3 ●●●	Vc	70-90	60-70	80-100	60-80	80-100	60-80
				f	0.08-0.1	0.06-0.08	0.06-0.1	0.06-0.08	0.08-0.15	0.06-0.1

ISO	Workpiece material	Hardness HB	Overhang L/D	Boring range D68-120		Boring range D120-200		Boring range D200-500		
				ap (mm)	0.8-1.5	1.5-3.5	0.8-2.0	2.0-3.5	0.8-1.5	2.0-4.0
				R (Radius)	0.2-0.4	0.4-0.8	0.2-0.4	0.4-0.8	0.2-0.4	0.4-0.8
P	Carbon steel	HB<200	2.5 ●●●	Vc	160-220	150-180	180-250	160-200	220-280	200-220
				f	0.15-0.25	0.08-0.2	0.15-0.3	0.1-0.2	0.15-0.3	0.1-0.15
			4 ●●●	Vc	140-180	120-150	160-200	140-180	N.R.	N.R.
				f	0.08-0.2	0.08-0.15	0.1-0.2	0.08-0.15		
			6.3 ●●●	Vc	70-100	50-70	N.R.	N.R.	N.R.	N.R.
				f	0.06-0.1	0.06-0.1				
	Carbon steel	HB>200	2.5 ●●●	Vc	140-180	120-160	150-170	100-140	100-140	80-120
				f	0.15-0.3	0.12-0.2	0.15-0.25	0.1-0.2	0.15-0.3	0.1-0.2
			4 ●●●	Vc	120-150	100-140	100-130	80-110	N.R.	N.R.
				f	0.1-0.2	0.1-0.18	0.08-0.2	0.08-0.12		
			6.3 ●●●	Vc	80-100	60-80	N.R.	N.R.	N.R.	N.R.
				f	0.08-0.12	0.08-0.12				

► N.R. = Not recommended

► In case of a single or a stepped boring cutter configuration, only half the feed should be applied

Recommended Cutting Conditions

Stability ●●● – Good
 ●● – Normal
 ● – Poor

BHR rough boring cutting data

ap(mm), R(radius), Vc(m/min), f(mm/rev)

ISO	Workpiece material	Hardness HB	Overhang L/D	Boring range D18-28		Boring range D28-50		Boring range D50-68		
				ap (mm)	0.5-1.0	1.0-1.8	0.5-1.0	1.0-1.8	0.5-1.2	1.2-2.0
				R (Radius)	0.2	0.4	0.2-0.4	0.4	0.2-0.4	0.4-0.8
P	Alloyed steel	HB<200	2.5 ●●●	Vc	140-160	90-120	150-180	100-130	160-200	140-180
				f	0.08-0.18	0.08-0.15	0.08-0.2	0.08-0.18	0.1-0.25	0.1-0.15
			4 ●●	Vc	100-130	70-100	110-150	90-120	140-180	100-130
				f	0.08-0.15	0.06-0.12	0.08-0.18	0.08-0.15	0.8-0.18	0.08-0.12
			6.3 ●	Vc	80-100	60-90	80-100	70-90	100-140	80-120
				f	0.08-0.15	0.06-0.1	0.06-0.12	0.06-0.12	0.6-0.15	0.08-0.1
	Alloyed steel	HB>200	2.5 ●●●	Vc	130-150	120-140	130-150	120-140	140-170	120-150
				f	0.08-0.18	0.06-0.15	0.08-0.18	0.06-0.15	0.08-0.2	0.08-0.18
			4 ●●	Vc	100-130	100-120	100-130	100-120	120-150	100-120
				f	0.08-0.15	0.06-0.13	0.08-0.15	0.06-0.13	0.08-0.18	0.08-0.15
			6.3 ●	Vc	80-100	70-90	80-100	70-90	100-120	70-90
				f	0.08-0.12	0.06-0.11	0.08-0.12	0.06-0.11	0.08-0.12	0.06-0.11
ISO	Workpiece material	Hardness HB	Overhang L/D	Boring range D68-120		Boring range D120-200		Boring range D200-500		
				ap (mm)	0.8	2.5	0.8-2.0	2.0-3.5	0.8-2.0	2.0-4.0
				R (Radius)	0.2-0.4	0.4-0.8	0.2-0.4	0.4-0.8	0.2-0.4	0.4-0.8
P	Alloyed steel	HB<200	2.5 ●●●	Vc	160-220	140-180	160-220	140-180	160-220	140-180
				f	0.1-0.3	0.1-0.25	0.1-0.3	0.1-0.25	0.1-0.35	0.1-0.3
			4 ●●	Vc	150-200	120-160	120-160	120-160	N.R.	N.R.
				f	0.1-0.2	0.08-0.18	0.1-0.2	0.08-0.18		
			6.3 ●	Vc	100-140	100-140	N.R.	N.R.	N.R.	N.R.
				f	0.08-0.18	0.08-0.15				
	Alloyed steel	HB>200	2.5 ●●●	Vc	160-200	140-180	140-200	140-180	140-200	140-180
				f	0.1-0.3	0.01-0.25	0.01-0.35	0.01-0.3	0.01-0.35	0.01-0.3
			4 ●●	Vc	140-160	120-140	150-180	120-140	N.R.	N.R.
				f	0.08-0.2	0.08-0.15	0.08-0.12	0.08-0.12		
			6.3 ●	Vc	100-120	70-90	N.R.	N.R.	N.R.	N.R.
				f	0.08-0.16	0.08-0.12				

► N.R. = Not recommended

► In case of a single or a stepped boring cutter configuration, only half the feed should be applied

Recommended Cutting Conditions

Stability ●●● - Good
 ●● - Normal
 ● - Poor

BHR rough boring cutting data

ap(mm), R(radius), Vc(m/min), f(mm/rev)

ISO	Workpiece material	Hardness HB	Overhang L/D	Boring range								
				D18-28		D28-50		D50-68				
				ap (mm)	0.5-1.0	1.0-1.8	0.5-1.0	1.0-1.8	0.5-1.2	1.2-2.0		
M	Stainless steel	Ferritic & martensitic	2.5 ●●●	Vc	100-150	110-130	120-160	100-150	120-160	110-160		
				f	0.08-0.15	0.06-0.12	0.08-0.18	0.06-0.12	0.08-0.25	0.08-0.18		
			4 ●●	Vc	90-130	90-120	100-140	90-140	100-150	80-120		
				f	0.08-0.12	0.06-0.1	0.08-0.12	0.06-0.1	0.08-0.18	0.08-0.12		
			6.3 ●	Vc	60-90	50-70	60-90	50-70	70-100	50-70		
				f	0.06-0.1	0.06-0.1	0.06-0.12	0.06-0.1	0.06-0.15	0.08-0.1		
	Stainless steel	Austenitic	2.5 ●●●	Vc	110-130	100-130	120-150	110-140	110-160	100-150		
				f	0.08-0.15	0.06-0.12	0.08-0.18	0.06-0.12	0.08-0.25	0.06-0.12		
			4 ●●	Vc	80-110	80-110	90-130	90-120	100-150	90-130		
				f	0.08-0.12	0.06-0.1	0.08-0.12	0.06-0.1	0.08-0.18	0.06-0.1		
			6.3 ●	Vc	60-90	50-70	60-90	50-70	70-100	50-70		
				f	0.06-0.1	0.06-0.1	0.06-0.12	0.06-0.1	0.06-0.15	0.06-0.1		
	Stainless steel cast	Ferritic & martensitic	2.5 ●●●	Vc	90-130	100-130	120-150	110-140	120-160	100-150		
				f	0.08-0.15	0.06-0.12	0.08-0.18	0.06-0.12	0.08-0.25	0.06-0.12		
			4 ●●	Vc	70-110	80-110	90-130	90-120	100-150	90-130		
				f	0.08-0.12	0.06-0.1	0.08-0.12	0.06-0.1	0.08-0.18	0.06-0.1		
			6.3 ●	Vc	60-90	50-70	60-90	50-70	70-100	50-70		
				f	0.06-0.1	0.06-0.1	0.06-0.12	0.06-0.1	0.06-0.15	0.06-0.1		
	Stainless steel cast	Austenitic	2.5 ●●●	Vc	80-120	70-110	100-150	90-140	110-150	100-150		
				f	0.08-0.15	0.06-0.12	0.08-0.18	0.06-0.12	0.08-0.25	0.06-0.12		
			4 ●●	Vc	70-100	70-100	80-130	70-120	90-140	90-130		
				f	0.08-0.12	0.06-0.1	0.08-0.12	0.06-0.1	0.08-0.18	0.06-0.1		
			6.3 ●	Vc	60-90	50-70	60-90	50-70	70-100	50-70		
				f	0.06-0.1	0.06-0.1	0.06-0.12	0.06-0.1	0.06-0.15	0.06-0.1		
M	Stainless steel	Ferritic & martensitic	2.5 ●●●	Vc	130-220	120-200	140-220	120-180	150-220	120-200		
				f	0.08-0.3	0.08-0.25	0.08-0.3	0.08-0.25	0.08-0.3	0.08-0.25		
			4 ●●	Vc	100-160	90-140	120-180	90-140	N.R.	N.R.		
				f	0.08-0.25	0.08-0.18	0.08-0.25	0.08-0.18				
			6.3 ●	Vc	70-100	50-70	N.R.	N.R.	N.R.	N.R.		
				f	0.08-0.2	0.08-0.15						
	Stainless steel	Austenitic	2.5 ●●●	Vc	120-200	100-160	120-200	100-160	120-200	100-180		
				f	0.08-0.3	0.08-0.25	0.08-0.3	0.08-0.25	0.08-0.3	0.08-0.25		
			4 ●●	Vc	100-150	90-140	100-160	90-140	N.R.	N.R.		
				f	0.08-0.25	0.08-0.18	0.08-0.25	0.08-0.18	0.08-0.18	0.06-0.1		
			6.3 ●	Vc	70-100	50-70	N.R.	N.R.	N.R.	N.R.		
				f	0.08-0.2	0.08-0.15						
	Stainless steel cast	Ferritic & martensitic	2.5 ●●●	Vc	130-200	120-180	140-200	120-160	140-200	120-180		
				f	0.08-0.3	0.08-0.25	0.08-0.3	0.08-0.25	0.08-0.3	0.08-0.25		
			4 ●●	Vc	110-150	90-150	100-160	90-140	N.R.	N.R.		
				f	0.08-0.25	0.08-0.18	0.08-0.25	0.08-0.18				
			6.3 ●	Vc	70-100	50-70	N.R.	N.R.	N.R.	N.R.		
				f	0.08-0.2	0.08-0.15						
	Stainless steel cast	Austenitic	2.5 ●●●	Vc	130-180	120-180	120-200	100-160	120-200	100-180		
				f	0.08-0.3	0.08-0.25	0.08-0.3	0.08-0.25	0.08-0.3	0.08-0.25		
			4 ●●	Vc	100-140	90-140	100-160	90-140	N.R.	N.R.		
				f	0.08-0.25	0.08-0.18	0.08-0.25	0.08-0.18				
			6.3 ●	Vc	70-190	50-70	N.R.	N.R.	N.R.	N.R.		
				f	0.08-0.2	0.08-0.15						

▶ N.R. = Not recommended

▶ In case of a single or a stepped boring cutter configuration, only half the feed should be applied

Recommended Cutting Conditions

Stability ●●● – Good
 ●● – Normal
 ● – Poor

BHR rough boring cutting data

ap(mm), R(radius), Vc(m/min), f(mm/rev)

ISO	Workpiece material	Hardness HB	Overhang L/D			Boring range D18-28		Boring range D28-50		Boring range D50-68	
				ap (mm)	0.5-1.0	1.0-1.8	0.5-1.0	1.0-1.8	0.5-1.2	1.2-2.0	
				R (Radius)	0.2-0.4	0.4	0.2-0.4	0.4	0.2-0.4	0.4-0.8	
K	Gray cast iron GG 10-25	HB<200	2.5 ●●●	Vc	120-160	100-140	120-180	110-150	120-180	110-150	
				f	0.06-0.15	0.06-0.18	0.06-0.15	0.06-0.12	0.08-0.2	0.08-0.12	
			4 ●●	Vc	100-140	80-120	100-150	80-120	100-150	80-120	
				f	0.06-0.12	0.06-0.1	0.06-0.12	0.06-0.1	0.08-0.12	0.08-0.1	
			6.3 ●	Vc	70-100	60-90	70-100	60-90	70-100	60-90	
				f	0.06-0.1	0.06-0.1	0.06-0.1	0.06-0.1	0.08-0.1	0.08-0.1	
	Gray cast iron GG 25-40	HB<200	2.5 ●●●	Vc	140-200	140-200	140-220	160-250	180-220	200-280	
				f	0.06-0.15	0.06-0.18	0.06-0.15	0.06-0.18	0.08-0.2	0.1-0.25	
			4 ●●	Vc	120-160	120-160	120-180	140-200	140-180	180-220	
				f	0.06-0.12	0.06-0.14	0.06-0.12	0.06-0.14	0.08-0.12	0.08-0.2	
			6.3 ●	Vc	70-100	60-90	70-100	60-90	60-100	60-120	
				f	0.06-0.1	0.06-0.1	0.06-0.1	0.06-0.1	0.08-0.1	0.08-0.1	
Cast iron GGG	Spheroidal & graphite	2.5 ●●●	Vc	120-180	120-180	120-200	140-220	180-220	180-240		
			f	0.06-0.15	0.06-0.18	0.06-0.15	0.06-0.18	0.08-0.18	0.1-0.2		
		4 ●●	Vc	120-160	120-160	120-180	140-200	140-200	160-220		
			f	0.06-0.12	0.06-0.14	0.06-0.12	0.06-0.14	0.08-0.12	0.08-0.18		
		6.3 ●	Vc	60-100	60-90	60-100	60-90	60-90	60-100		
			f	0.06-0.1	0.06-0.1	0.06-0.1	0.06-0.1	0.08-0.1	0.08-0.1		

ISO	Workpiece material	Hardness HB	Overhang L/D			Boring range D18-28		Boring range D28-50		Boring range D50-68	
				ap (mm)	0.8-1.8	1.8-2.5	0.8-2.0	2.0-3.0	0.8-2.0	2.0-3.5	
				R (Radius)	0.2-0.4	0.4-0.8	0.2-0.4	0.4-0.8	0.2-0.4	0.4-0.8	
K	Gray cast iron GG 10-25	HB<200	2.5 ●●●	Vc	120-200	110-150	150-250	180-280	150-250	180-280	
				f	0.08-0.25	0.08-0.3	0.08-0.25	0.08-0.35	0.08-0.25	0.08-0.35	
			4 ●●	Vc	100-150	80-120	120-170	120-170	N.R.	N.R.	
				f	0.08-0.18	0.08-0.2	0.08-0.18	0.08-0.25	N.R.	N.R.	
			6.3 ●	Vc	70-100	60-90	N.R.	N.R.	N.R.	N.R.	
				f	0.08-0.15	0.08-0.12	N.R.	N.R.	N.R.	N.R.	
	Gray cast iron GG 25-40	HB<200	2.5 ●●●	Vc	50-300	250-350	250-350	250-350	250-350	250-350	
				f	0.12-0.35	0.12-0.35	0.15-0.3	0.15-0.4	0.15-0.3	0.15-0.4	
			4 ●●	Vc	200-270	230-300	200-300	200-270	N.R.	N.R.	
				f	0.1-0.25	0.12-0.3	0.15-0.3	0.15-0.35	N.R.	N.R.	
			6.3 ●	Vc	70-150	60-120	N.R.	N.R.	N.R.	N.R.	
				f	0.1-0.15	0.12-0.25	N.R.	N.R.	N.R.	N.R.	
Cast iron GGG	Spheroidal & graphite	2.5 ●●●	Vc	200-240	200-280	200-280	220-300	220-300	220-300		
			f	0.12-0.3	0.12-0.3	0.15-0.3	0.15-0.35	0.15-0.3	0.15-0.35		
		4 ●●	Vc	160-220	180-240	180-250	200-270	N.R.	N.R.		
			f	0.1-0.2	0.12-0.25	0.15-0.25	0.15-0.35	N.R.	N.R.		
		6.3 ●	Vc	60-100	60-100	N.R.	N.R.	N.R.	N.R.		
			f	0.1-0.15	0.12-0.2	N.R.	N.R.	N.R.	N.R.		

▶ N.R. = Not recommended

▶ In case of a single or a stepped boring cutter configuration, only half the feed should be applied

Recommended Cutting Conditions

Stability ●●● – Good
 ●● – Normal
 ● – Poor

BHR rough boring cutting data

ap(mm), R(radius), Vc(m/min), f(mm/rev)

ISO	Workpiece material	Hardness HB	Overhang L/D	Boring range D18-28		Boring range D28-50		Boring range D50-68		
				ap (mm)	0.5-1.5	1.5-2.5	0.5-1.5	1.5-2.5	0.5-2.0	1.2-3.0
				R (Radius)	0.2-0.4	0.4	0.2-0.4	0.4	0.2-0.4	0.4-0.8
N	Aluminum/ Cast	>12si	2.5 ●●●	Vc	200-300	240-350	200-300	240-350	200-300	240-350
				f	0.06-0.2	0.06-0.25	0.06-0.2	0.06-0.25	0.06-0.25	0.06-0.3
			4 ●●	Vc	150-220	150-220	150-220	150-220	150-220	150-220
				f	0.06-0.2	0.06-0.2	0.06-0.2	0.06-0.2	0.06-0.2	0.06-0.2
			6.3 ●	Vc	60-100	60-100	60-100	60-100	60-100	60-100
				f	0.06-0.1	0.06-0.1	0.06-0.1	0.06-0.1	0.06-0.1	0.06-0.1
	Aluminum/ Cast	<12si	2.5 ●●●	Vc	180-250	220-280	180-250	220-280	180-250	220-280
				f	0.06-0.2	0.06-0.25	0.06-0.25	0.06-0.25	0.06-0.25	0.06-0.3
			4 ●●	Vc	120-220	120-220	120-220	120-220	120-220	120-220
				f	0.06-0.2	0.06-0.2	0.06-0.2	0.06-0.2	0.06-0.2	0.06-0.25
			6.3 ●	Vc	60-100	60-100	60-100	60-100	60-100	60-100
				f	0.06-0.1	0.06-0.1	0.06-0.1	0.06-0.1	0.06-0.1	0.06-0.1

ISO	Workpiece material	Hardness HB	Overhang L/D	Boring range D68-120		Boring range D120-200		Boring range D200-500		
				ap (mm)	0.8-3.0	1.8-4.0	0.8-3.0	2.0-4.0	0.8-3.0	2.0-4.5
				R (Radius)	0.2-0.4	0.4-0.8	0.2-0.4	0.4-0.8	0.2-0.4	0.4-0.8
N	Aluminum/ Cast	>12si	2.5 ●●●	Vc	200-300	240-350	200-300	240-350	200-300	240-350
				f	0.06-0.25	0.06-0.3	0.06-0.25	0.06-0.4	0.06-0.25	0.06-0.4
			4 ●●	Vc	150-220	150-220	150-220	150-220	N.R.	N.R.
				f	0.06-0.2	0.06-0.2	0.06-0.2	0.06-0.2		
			6.3 ●	Vc	60-100	60-100	N.R.	N.R.	N.R.	N.R.
				f	0.06-0.1	0.06-0.1				
	Aluminum/ Cast	<12si	2.5 ●●●	Vc	180-250	220-280	180-250	220-280	180-250	220-280
				f	0.06-0.25	0.06-0.3	0.06-0.3	0.06-0.4	0.06-0.3	0.06-0.4
			4 ●●	Vc	120-220	120-220	120-220	120-220	N.R.	N.R.
				f	0.06-0.2	0.06-0.25	0.06-0.2	0.06-0.25		
			6.3 ●	Vc	60-100	60-100	N.R.	N.R.	N.R.	N.R.
				f	0.06-0.1	0.06-0.1				

▶ N.R. = Not recommended

▶ In case of a single or a stepped boring cutter configuration, only half the feed should be applied

Technical Data

► Fine boring head BHF 16-50 and BHE operating instructions

■ Assembly

- When mounting the BHF boring head, the expanding pin should be kept tightly inside the cylindrical body
- Insert the BHF into the shank
- Tighten the pin ② by turning clockwise

The recommended tightening torque guidelines are as follows:

Recommended Torque	(N·m)
BHF MB16 - 16 x 34	2.0 - 2.5
BHF MB20 - 20 x 40	4.0 - 4.5
BHF MB25 - 25 x 50	6.5 - 7.5
BHF MB32 - 32 x 63	7.0 - 8.0
BHF MB40 - 40 x 80	16.0 - 18.0
BHF MB50 - 50 x 60	30.0 - 35.0

- Insert screw ⑤ until it completely enters the recess in the sleeve nut or boring bar

■ Disassembly

- Loosen the pin ② by turning counter-clockwise

■ Positioning

- Loosen the screw ④ before making any slide adjustment
- By turning the graduated dial ③ counterclockwise, set the tool slide ⑦ allowance for a 4mm adjustment
- Lock the tool slide by means of screw ④, to the desired position
- Lock the screw ④
- When making any slide adjustment, firstly loosen the screw ④

■ Maintenance

Weekly:

- Lubricate through the oiling nipple ⑧ with ISO UN G220 oil
- Periodically:
- Clean the conical cylindrical surface and then lubricate
 - Grease the expanding pin ② with an anti-friction lubricant
 - Clean and lubricate the tool slide guideway

■ Important note:

- Toolholder should be firmly affixed to the slide at all times

* Due to back-lash phenomenon, if you pass the required value, turn the dial ③ in the reverse direction at least one rotation and then re-adjust in the original direction

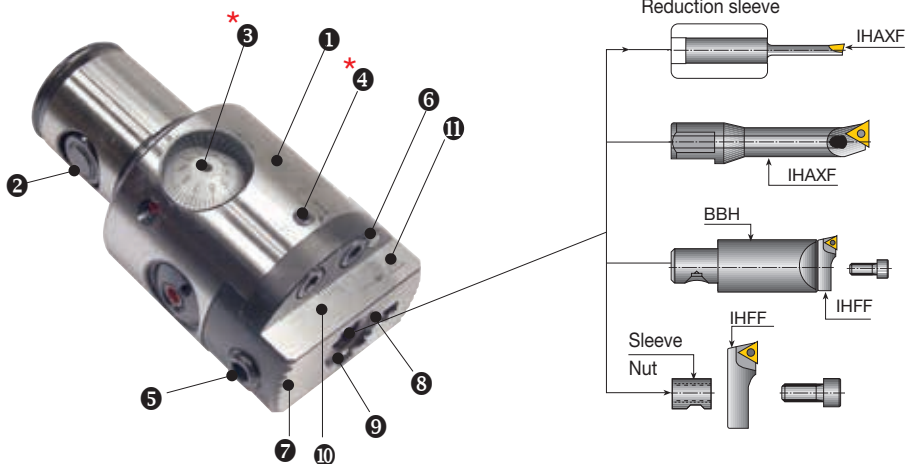

1 Body

2 Expanding pin

* 3 Graduated dial

* 4 Slide locking screw

5 Toolholder locking screw

6 Coolant nozzle

7 Slide holder

8 Oiling nipple

9 Tool bore .63H7

10 Slide adjusting range

Do not exceed the range marks!!

11 Cutting edge position mark

Technical Data

► Fine boring head BHF 63-125 operating instructions

■ Assembly

- When mounting the BHF boring head, the expanding pin should be kept tightly inside the cylindrical body
- Insert the BHF into the shank
- Tighten the pin ② by turning clockwise

The recommended tightening torque guidelines are as follows:

Recommended Torque	(N·m)
BHF MB50 - 63 x 87	30 - 35
BHF MB50 - 80 x 94	30 - 35
BHF MB63 - 63 x 87	80 - 90
BHF MB80 - 80 x 94	80 - 90
BHF MB80 - 125 x 94	80 - 90
BHF MB50 - 50 x 60	30 - 35

- Insert screw ⑤ until it completely enters the recess in the sleeve nut or boring bar

■ Disassembly

- Loosen the pin ② by turning counter-clockwise

■ Positioning

- Loosen the screw ④ before making any slide adjustment
- By turning the graduated dial ③ counterclockwise, set the tool slide ⑦ allowance for a 4mm adjustment
- Lock the tool slide by means of screw ④, to the desired position
- Lock the screw ④
- When making any slide adjustment, firstly loosen the screw ④

■ Maintenance

Weekly:

- Lubricate through the oiling nipple ⑧ with ISO UN G220 oil

Periodically:

- Clean the conical cylindrical surface and then lubricate
- Grease the expanding pin ② with an anti-friction lubricant
- Clean and lubricate the tool slide guideway

■ Important note:

- Toolholder should be firmly affixed to the slide at all times

* Due to back-lash phenomenon, if you pass the required value, turn the dial ③ in the reverse direction at least one rotation and then re-adjust in the original direction

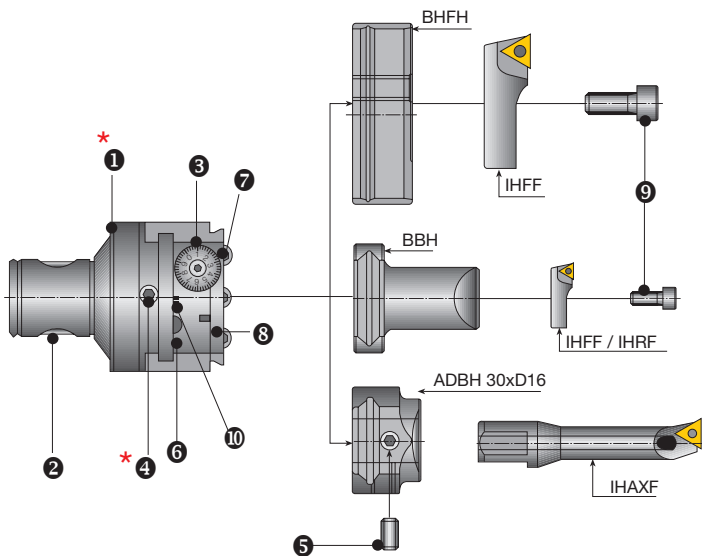

- * 1 Body
 - 2 Expanding pin
 - 3 Graduated dial
 - * 4 Slide locking screw
 - 5 Toolholder locking screw
 - 6 Coolant nozzle
 - 7 Slide holder
 - 8 Oiling nipple
 - 9 Toolholder locking screws
 - 10 Slide adjusting range
- Do not exceed the range marks!!



MATERIALS & GRADES



Grade Comparison Table

▶ Milling grades

ISO class	TaeguTec	Sandvik	Walter	Seco	Kennametal	MMC	Sumitomo	Tungaloy	Kyocera	Korloy	Iscar
P	TT5505 TT5515 TT2510 TT7080 TT8515B	GC4330 GC1010 GC4220 GC4230	WKP25S WKP25 WAM10 WAM20 WHH15X WXM15	MP1500 MP2500 T250M	KC510M KCPM15	MP6120 UP20M	ACP100	T3130 AH3035 AH710		PC2005 PC3525 PC3530 NC5330 NC5340	IC5400 IC380 IC902 IC950 IC520M
	TT5513 TT5520 TT9080 TT5523 TT5525	GC4340 GC1130 GC1030 GC4240	WKP25S WAM30 WJ30TF	F25M F30M F32M MK2050 MP3000	KC522M KC635M KC633M KC643M	MP9120 MP9130 VP15TF MP6130 VP20RT	XCU2500 ACP3000 ACU2500 ACP200	AH110 AH3225 AH725 AH730 GH330 AH120	PR830 PR1225 PR1230 PR925 PR1825	PC3700 PC3500 PC3600 PC5300 PC5535 PC210F	IC608 IC808 IC908
	TT8080 TT5543 TT8525B	GC4240 GC1040	WKP35G WKP35S WKP45S WSP45S WSP45G WSP46	F40M T350M T60M MS2050 MP2050	KC725M KC735M KC935M KCPM20 KCPM40	VP30RT FH7020 F7030	ACP300 ACZ350	AH140 T3130 AH130 AH3135 AH9030	PR1525	PC3600 PC5400 NC5350 NCM535	IC830 IC330 IC845 IC928 IC300
M S	TT5515 TT5520 TT9080 TT9030 TT5523	GC1010 GC1130 GC1030 GC2030 S30T GC1025	WXM15 WAM30 WXM35	MS2050 MP3000 MP2500 F25M F30M F32M	KC635M KCSM15A KCPM15 KC643M KCSM15 KC633M	MP9120 MP9130 VP15TF VP20RT	XCU2500 ACU2500 ACK300 ACP300 ACM100 ACM20	AH110 AH3225 T3130 AH8015 AH725 AH120 AH4035	PR830 PR1210 PR1025 PR1225 PR905	PC5300 PC9530	IC608 IC808 IC902 IC908
	TT8080 TT5543 TT8020 TT3535 TT3520	GC2040 GC1040 S40T	WJ30RA WSM30 WSM35 WSM35G WSM35S WSM36 WSP45G WSP45S WSP45X WMP45G WSP45G WSP46	F40M MS2500 MM4500 MP2050	KC725M KCPM40 KCSM40	MP9140 MP7030 MP7130 MP7140 VP30RT MV1020 MC7020	ACM200 ACM300 ACS2500 ACS3000	AH130 AH140 SH730 AH3135	PR1225 PR905 PR1525 PR1535	PC5400 NC5350 PC9540	IC840 IC830 IC882 IC330 IC328
K	TT7505 TT7515	GC1010 GC3220 GC3330 GC4220	WAK15 WHH15X WXM15	F15M MK1500 MP1500 MH1000	KC915M KCK15 KC643M KCPM15	MC5020	ACK3000 ACU2500 ACK200	T1115 AH9130		PC2005 PC8110	IC5100 IC4100 IC902 DT7150 IC4050
	TT5515 TT5520 TT6080 TT5525	GC1020 GC4230 GC3040 GC4240 K20D	WKP25S WKP35G WKP35S WKK25G WKK25S	F25M MK2000 MK3000 MK2050 F32M	KCKP10 KCK15 KC520M KC633M KC643M KCPM15	MP8010 VP15TF VP20RT F5010	XCU2500 XCK2000 ACK300 ACZ310	AH110 AH725 AH120 AH8015	PR905 PR1210 PR1510 PR1810	PC210F PC6510 NC5330 PC5535 NC5340 NCM535	IC808 IC810 IC910 IC608
H	TT5505 TT5515 TT2510 TT6080 TT9080	GC1010 GC1130 GC1030	WHH15 WHH15X	F15M MH1000 MP1500 MP3000 F32M	KC510M KC522M KC635M KC639M KCPM15	MV1020 MP8010 VP15TF VP20RT F5010		AH710 AH750 AH8005 AH8015 AH9030	PRO15S	PC2005 PC2010 PC2015 PC2510 PC2505 PC210F PC5535	IC902 IC903 IC900 IC808 IC908

Grade Comparison Table

► Cermet grades

ISO class	TaeguTec	Sandvik	Kennametal	Sumitomo	Kyocera	Tungaloy	Mitsubishi	Korloy	Seco	NTK	Ceramtec
P	CT7000	CT530	KT1120 KT175	T250A T130A	TN100M TN620M TC60M PV90	NS740	VP45N NX99 NX3035	CN20 CN30	TP1020 C15M	N20 Z15 C50 C7X	SC7015 SC60

► Ceramic grades

ISO class	Composition	TaeguTec	Sandvik	Kennametal	Ceramtec	NTK	Kyocera	Sumitomo	Tungaloy
K	Al ₂ O ₃ , ZrO ₂	AW120	CC620		SN60 SN80	HC1 HW2	KA30		TZ120
	Al ₂ O ₃ , TiC	AB30	CC650	KY1615	SH2 SH4	HC2 HC5 HC6	A65	NB90S NB90M	LX21
	Si ₃ N ₄ , Al ₂ O ₃ , Y ₂ O ₃ , AlN	AS500		KY1310 KY3000	SL506 SL508 SL606 SL608	SX9			
	Si ₃ N ₄ , ZrO ₂ , Al ₂ O ₃ , Y ₂ O ₃	AS10	CC6090 CC6190	KY1320 KY3500 KYK10	SL500 SL808	SX1 SX6 SX8	KS6000 KS6050	SN2000K SN2100K NS260	FX105 CX710
	CVD coated	SC10	CC1690	KY3400 KYK25	SL550C SL554C SL654C SL658C SL854C SL858C	SP2 SP9	CS7050	NS260C	CXC73
H	Al ₂ O ₃ , TiCN	AB20	CC6050		SH2 SH4	HC2 HC5 HC7			LX10
	PVD coated	AB2010	CC670	KY4400		ZC4 ZC7	A66N PT600M	NB100C	LX11
S	Al ₂ O ₃ , SiC whisker	TC430	CC6060 CC6065 CC6160	KY4300		WA1 WA5		WX2000	
	Si ₃ N ₄ , TiN	TC3020 TC3030	CC6220 CC6230	KY2100 KY1540 KYS30 KYS25 KYS30P		SX3 SX5 SX7 SX9	KS6030 KS6040	SN1000S SN2000S	TS200 TS300

Grade Comparison Table

▶ CBN grades

ISO class	TaeguTec	Iscar	Tungaloy	Sumitomo	Sandvik	Kennametal	Mitsubishi	Kyocera	Seco
H	TB610	IB10H IB50	BX310	BN1000 BNX10	CB7105 CB7015	KB1610	MBC010	KBN510	CBN010
		IB10HC	BXC30 BXA30	BNC80 BNC100 BNC2010		KB5610 KB9610	MB8025 BC8105 BC8210	KBN10M KBN10C KBN25C	CBN050C CH0550
	TB2015 TB650	IB20H IB55	BX330 BX530	BN250 BN2000 BNX20	CB7115 CB7025	KB1625	MB810	KBN525	CBN100
		IB25HA	BXM10 BXC30 BXA40	BNC160 BNC2020		KB5625	MB820 BC8110 BC8220	KBN05M KBN25M	CBN160C CH2540
	TB670	IB25HC	BX360 BX380	BNX25 BN350	CB7125 CB7135 CB50 CB7525 CB7925		MB825 MB8025 BC8120 BC8220		CBN150 CBN170
			BXM20 BXA20 BXA40 BXC50	BNC200 BNC300			MB835 BC8020 BC8130		KBN30M
K	TB7015 TB730	IB90	BX930 BX850 BX950	BN500 BN7500 BN7000	CB50 CB7525	KB1630 KB1345	MB4020 MB710	KBN475 KBN60M KBN65B	CBN200
		IB05S IB10S	BX470 BX480	BN700 BNC500	CB7050	KB5630 KB9640	MB730	KBN65M KBN70M KBN570	CH3515
	KB90A TB7020		BX90S BXC90	BNS800	CB7925		MBS140	KBN900	CBN200 CBN300 CBN300P CBN350 CBN400C

▶ PCD grades

ISO class	TaeguTec	Iscar	Tungaloy	Sumitomo	Sandvik	Kennametal	Mitsubishi	Kyocera	Seco	NTK
N01-N10	TC1010	ID8	DX180 DX160	DA90		KD1405	MD203	KPD230	PCD30M PCD30	
N05-N20	TC1020	ID5	DX140	DA150	CD10	KD1400	MD220	KPD010	PCD20	PD1
N15-N30	TC1030		DX120 DX110	DA2200 DA1000		KD1425	MD205	KPD001	PCD10 PCD05	PD2

SFEED-RUSH Grades

► Milling SFEED-RUSH grades

SFEED-RUSH grades have upgraded toughness and chipping resistance through special post-coating treatment process of CVD grades. Through the post-coating treatment process, single color inserts have been transformed into two different colors, on the side and the top (see the illustrations below).

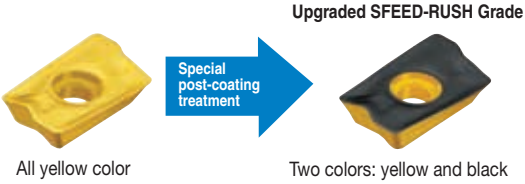
ISO class	Grade	ISO Range	Insert color
P	TT8525B	P30-P45	 <p>All yellow color</p> <p>Special post-coating treatment</p> <p>Upgraded SFEED-RUSH Grade</p> <p>Two colors: yellow and black</p>



Hardness Conversion Table

Vickers 50kg HV	Brinell HB10mm ball LOAD 3000kgf		Rockwell				Shore's HS	Tensile strength N/mm ² (kgf/mm ²)
	Standard ball	Tungsten carbide ball	A scale 60kgf diamond brale HRA	B scale 100kgf 1/16in ball HRB	C scale 150kgf diamond brale HRC	D scale 100kgf diamond brale HRD		
1900			93.1		80.5			
1800			92.6		79.2			
1700			91.9		77.9			
1600			91.3		76.6			
1500			90.5		75.3			
1450			90.1		74.6			
1400			89.6		74.0			
1350			89.1		73.4			
1300			88.7		72.7			
1250			88.3		72.1			
1200			87.9		71.5			
1150			87.5		70.9			
1100			87.1		70.3			
1050			86.6		69.6			
1000			86.2		68.9			
940			85.6		68.0	76.9	97	
920			85.3		67.5	76.5	96	
900			85.0		67.0	76.1	95	
880		(767)	84.7		66.4	75.7	93	
860		(757)	84.4		65.9	75.3	92	
840		(745)	84.1		65.3	74.8	91	
820		(733)	83.8		64.7	74.3	90	
800		(722)	83.4		64.0	74.8	88	
780		(710)	83.0		63.3	73.3	87	
760		(698)	82.6		62.5	72.6	86	
740		(684)	82.2		61.8	72.1	84	
720		(670)	81.8		61.0	71.5	83	
700		(656)	81.3		60.1	70.8	81	
690		(647)	81.1		59.7	70.5		
680		(638)	80.8		59.2	70.1	80	
670		630	80.6		58.8	69.8		
660		620	80.3		58.3	69.4	79	
650		611	80.0		57.8	69.0		
640		601	79.8		57.3	68.7	77	2205(210)
630		591	79.5		56.8	68.3		2020(206)
620		582	79.2		56.3	67.9	75	1985(202)
610		573	78.9		55.7	67.5		1950(199)
600		564	78.6		55.2	67.0	74	1905(194)
590		554	78.4		54.7	66.7		1860(190)
580		545	78.0		54.1	66.2	72	1825(186)
570		535	77.8		53.6	65.8		1795(183)
560		525	77.4		53.0	65.4	71	1750(179)
550	(505)	517	77.0		52.3	64.8		1750(174)
540	(496)	507	76.7		51.7	64.4	69	1660(169)
530	(488)	497	76.4		51.1	64.0		1620(165)
520	(480)	488	76.1		50.5	63.5	67	1570(160)
510	(473)	479	75.7		49.8	62.9		1530(156)
500	(465)	471	75.3		49.1	62.2	66	1459(153)
490	(456)	460	74.9		48.4	61.6		1460(149)
480	488	452	74.5		47.7	61.3	64	1410(144)





▶ Note: Gray figures come from ASTM E 140 table (Calculated by SAE-ASM-ASTM together)







Vickers 50kg HV	Brinell HB10mm ball LOAD 3000kgf		Rockwell				Shore's HS	Tensile strength N/mm ² (kgf/mm ²)
	Standard ball	Tungsten carbide ball	A scale 60kgf diamond brale HRA	B scale 100kgf 1/16in ball HRB	C scale 150kgf diamond brale HRC	D scale 100kgf diamond brale HRD		
470	441	442	74.1		46.9	60.7		1570(160)
460	433	433	73.6		46.1	60.1	62	1530(156)
450	425	425	73.3		45.3	59.4		1459(153)
440	415	415	72.8		44.5	58.8	59	1460(149)
430	405	405	72.3		43.6	58.2		1410(144)
420	397	397	71.8		42.7	57.5	57	1370(140)
410	388	388	71.4		41.8	56.8		1330(136)
400	379	379	70.8		40.8	56.0	55	1290(131)
390	369	369	70.3		39.8	55.2		1240(127)
380	360	360	69.8	(110.0)	38.8	54.4	52	1250(123)
370	350	350	69.2		37.7	53.6		1170(120)
360	341	341	68.7	(109.0)	36.6	52.8	50	1130(115)
350	331	331	68.1		35.5	51.9		1095(112)
340	322	322	67.6	(108.0)	34.4	51.1	47	1070(109)
330	313	313	67.0		33.3	50.2		1035(105)
320	303	303	66.4	(107.0)	32.2	49.4	45	1005(103)
310	294	294	65.8		31.0	48.4		980(100)
300	284	284	65.2	(105.5)	29.8	47.5	42	950(97)
295	280	280	64.8		29.2	47.1		935(96)
290	275	275	64.5	(104.5)	28.5	46.5	41	915(94)
285	270	270	64.2		27.8	46.0		905(92)
280	265	265	63.8	(103.5)	27.1	45.3	40	890(91)
275	261	261	63.5		26.4	44.9		875(89)
270	256	256	63.1	(102.0)	25.6	44.3	38	855(87)
265	252	252	62.7		24.8	43.7		840(86)
260	247	247	62.4	(101.0)	24.0	43.1	37	825(84)
255	243	243	62.0		23.1	42.2		805(82)
250	238	238	61.6	99.5	22.2	41.7	36	795(81)
245	233	233	61.2		21.3	41.1		780(79)
240	228	228	60.7	98.1	20.3	40.3	34	765(78)
230	219	219		96.7	(18.0)		33	730(75)
220	209	209		95.0	(15.7)		32	695(71)
210	200	200		93.4	(13.4)		30	670(68)
200	190	190		91.5	(11.0)		29	635(65)
190	181	181		89.5	(8.5)		28	605(62)
180	171	171		87.1	(6.0)		26	580(59)
170	162	162		85.0	(3.0)		25	545(56)
160	152	152		81.7	(0.0)		24	515(53)
150	143	143		78.7			22	490(50)
140	133	133		75.0			21	455(45)
130	124	124		71.2			20	425(44)
127	121			69.8			19	(42)
122	116			67.6			18	(41)
117	111			65.7			15	(39)

► Note: Gray figures come from ASTM E 140 table (Calculated by SAE-ASM-ASTM together)

Material Conversion Table





► According to VDI 3323 standard







Material group					
	AISI/SAE	Material No. DIN	BS	EN	AFNOR
1	A 366 (1012) 1008	0.0030 C10	040 A 10 045 M 10 1449 10 CS		AF 34 C 10 XC 10
1		1.0028 Ust 34-2 (S250G1T)			A 34-2
1		1.0034 RSt 34-2 (S250G2T)	1449 34/20 HR, HS, CR, CS		A 34-2 NE
1		1.0035 St185 (Fe 310-0) St 33	Fe 310-0 1449 15 HR, HS		A 33
1	A 570 Gr. 33,36	1.0036 S235JRG1 (Fe 360 B) Ust 37-2	Fe 360 B 4360-40 B		
1		1.0037 S235JR (Fe 360 B) St 37-2	Fe 360 B 4360-40 B		E 24-2
1	1115	1.0038 GS-CK16	030A04	1A	
1	A 570 Gr. 40	1.0044 S275JR (Fe 430 B) St44-2	Fe 430 B FN 1449 43/25 HR, HS 4360-43 B		E 28-2
1		1.0045 S355JR	4360-50 B		E 36-2
1	A 570 Gr.50 A 572 Gr.50	1.0050 E295 (Fe 490-2) St 50-2	Fe 490-2 FN 4360-50 B		A 50-2
1	A 572 Gr. 65	1.0060 E335 (Fe 590-2) St 60-2	Fe 60-2 4360-55 E; 55 C		A 60-2
1		1.0060 St 60-2			
1		1.0070 E360 (Fe 690-2) St 70-2	Fe 690-2 FN		A 70-2
1		1.0112 P235S	1501-164-360B LT20		A37AP
1		1.0114 S235JU;St 37-3 U	4360-40C		E 24-3
1	A 284 Gr.D A 573 Gr.58 A 570 Gr 36;C A 611 Gr. C	1.0116 S235J2G3 (Fe 360 D 1) St 37-3	Fe 360 D1 FF 1449 37/23 CR 4360-40 D		E 24-3 E 24-4
1		1.0130 P265S	1501-164-400B LT 20		A 42 AP
1		1.0143 S275J0; St 44-3 U	4360-43C		E 28-3

 SS	 UNI	 UNE	 JIS	 KS	 GOST
	C 10 1 C 10	F.1511 F.151A	S 10C	SM 10C	10
	Fe 330, Fe 330 B FU		SS 330	SS 330	
	Fe 330 B FU				St2sp
1300	Fe 320	Fe 310-0			St0
1311	FE37BFU	AE 235 B			16D, 18Kp
1312		Fe 360 B			St3Kp
1311	Fe 360 B 1449 37/23 HR	AE 235 B Fe 360 B	STKM 12A;C	STKM 12A;C	
1325	Fe 330, Fe 330 B FU		SS 330	SS 330	
1412	Fe 430 B Fe 430 B FN	AE 275 B Fe 430 B FN	SM 400 A;B;C	SM 400 A;B;C	St4ps; sp
2172	Fe 510 B	AE 355 B			
1550	Fe 490	a 490-2	SS 490	SS 490	ST5ps; sp
2172		Fe 490-2 FN			
1650	Fe 60-2 Fe 590	A 590-2 Fe 590-2 FN	SM 570	SM 570	St6ps; sp
	Fe 60-2				
1655	Fe 70-2 Fe 690	A 690-2 Fe 690-2 FN			
	Fe 360 C	AE 235 C			
	Fe 360 C	AE 235 C			
1312	Fe 360 D1 FF				
1313	Fe 360 C FN Fe 360 D FF Fe 37-2	AE 235 D Fe 360 D1 FF			St3kp; ps; sp 16D
		SPH 265			
1414-01	Fe 430 D	AE 275 D			

Material Conversion Table





► According to VDI 3323 standard







Material group					
	AISI/SAE	Material No. DIN	BS	EN	AFNOR
1	A 573 Gr. 70	1.0144 S275J2G3 (Fe 430 D 1)	Fe 430 D1 FF		E 28-3
	A 611 Gr.D	St 44-3	4360-43 C; 43 D		E 28-4
1		1.0149 S275JOH; RoSt 44-2	4360-43C		
1		1.0226 DX51D; St 02 Z	Z2		GC
1	M 1010	1.0301 C10	040 A 10		AF 34 C 10
			045 M 10		XC 10
			1449 10 CS		
1	A 621 (1008)	1.0330 DC 01	1449 4 CR		TE
		St 2; St 12	1449 3 CS		
1	A 619 (1008)	1.0333 Ust 3 (DC03G1)	1449 2 CR;3 CR		E
		Ust 13			
1	A 621 (1008)	1.0334 UStW 23 (DD12G1)			SC
1	A 622 (1008)	1.0335 DD13; StW 24	1449 1 HR		3C
1	A 620 (1008)	1.0338 DC04	1449 1 CR;2 CR		ES
		St4; St 14			
1	A 516 Gr. 65; 55	1.0345 P235GH	1501 Gr. 141-360		A 37 CP;AP
	A 515 Gr. 65;55	HI	1501 Gr. 161-360; 151-360		
	A 414 Gr. C		1501 Gr. 161-400; 154-360		
	A 442 Gr.55		1501 Gr. 164-360; 161-360		
1	(M) 1020	1.0402 C22	055 M 15, 070 M 20 2C/2D		AF 42 C 20;
	M 1023		1499 22 HS, CS		XC 25;1 C 22
1	1020	1.0402 C22	050A20	2C/2D	CC20
1	1020;1023	1.0402 C22	055 M 15, 070 M 20 2C		AF 42 C 20;
					XC 25;1 C 22
1		1.0425 P265GH	H II	1501 Gr. 161-400;151-400	A 42 CP; AP
				1501 Gr. 164-360; 161-400	
				1501 Gr. 164-400;154-400	
1	A27 65-35	1.0443 GS-45	A1		E 23-45 M
1		1.0539 S355NH;StE 335			TSE 355-4
1		1.0545 S355N; StE 355	4360-50E		E 355 R
1		1.0546 S355NL;TStE 355	4360-50EE		E 355 FP
1		1.0547 S355JOH	4360-50C		TSE 355-3
1		1.0549 S355 NLH;TStE 355			
1		1.0553 S355JO;St 52-3U	4360-50C		E 36-3

					
SS	UNI	UNE	JIS	KS	GOST
1411, 1412 1414	Fe 430 B, Fe 430 C (FN) Fe 430 D (FF)	AE 275 D Fe 430 D1 FF	SM 400 A;B;C	SM 400 A;B;C	St4kp> ps; sp
1412-04	Fe 430 C	Fe 430 C			
1151 10	FeP 02 G	FeP 02 G			
	C 10 1 C 10	F.1511 F.151.A	S 10C	SM 10C	10
1142	FeP 00 FeP 01 FeP 02	AP 11 AP 02	SPHD SPCD	SPHD SPCD	15kp
	FeP 12 FeP 13	AP 12 AP 13	SPHE SPHE	SPHE SPHE	10kp 08kp
1147	FeP 04	AP 04	SPCE	SPCE	08jU; JUA
1331 1330	FeE235, Fe 360 1 KW;KG Fe 360 2 KW;KG	A 37 RC I RA II	SGV 410, SGV 450, SGV 48, SPV 450;SPV 480	SGV 410, SGV 450, SGV 480, SPPV 450;SPPV 480	
1450	C 20 C 21, C 25	1 C 22 F.112	S20C	SM 20C	20
1450	C20, C21	F.112	S22C	SM 22C	20
1450	C 20; C 21;C 25	1 C 22F.112	S 20 C;S 22 C	SM 20 C;SM 22C	
1431 1430 1432 1305	Fe 410 1 KW; KG; KT Fe 410 2 KW; KG	A 42 RC I A 42 RC II	SPV 315; SPV 355 SG 295; SGV 410 SGV 450; SGV 480	SPPV 315; SPPV 355 SG 295; SGV 410 SGV 450; SGV 480	16K 20K
2134-04	Fe 510 B	Fe 355 KGN			
2334-01	FeE 355 KG	AE 355 KG			
2135-01	FeE 355 KT	AE 355 KT			
2172-04	Fe 510 C	Fe 510 C			
2135	Fe 510 D Fe 510 C	FeE 355 KTM			

Material Conversion Table





► According to VDI 3323 standard







Material group	 AISI/SAE	 Material No. DIN	 BS	 EN	AFNOR
1	A 633 Gr.C A 588	1.0562 P355N StE 355	1501 Gr.225-490A LT 20		FeE 355 KG N E 355 R/FP; A 510 AP
1		1.0565 P355NH; WStE 355	1501-225-490B LT 20		A 510 AP
1		1.0566 P355NL1; TStE 355	1501-225-490A LT 50		A 510 FP
1	1	1.0570 S355J2G3 St 52-3	Fe 510 D1 FF 1449 50/35 HR>HS 4360-50 D		E 36-3 E 36-4
1	1213	1.0715 9 SMn 28 (1SMn30)	230 M 07		S 250
1	1213	1.0715 9 SMn 28	230 M 07		S 250
1	12 L 13	1.0718 9 SMnPb 28 (11SMnPb30)			S 250 Pb
1	1108 1109	1.0721 10 S 20	(210 M 15)		10S20 10F 2
1	11 L 08	1.0722 10 SPb 20			10PbF 2
1	11 L 08	1.0722 10 SPb 20			10PbF 2
1	1215	1.0736 9 SMn 36 11SMn37)			S 300
1	12 L 14	1.0737 9 SMnPb 36 (11SMnPb37)			
1		1.0972 S315MC; QStE 300 TM	1501-40F30		E 315 D
1		1.0976 S355MC; QStE 360 TM	1501-43F35		E 355 D
1		1.0982 S460MC; QStE 460 TM	1501-50F45		
1		1.0984 S500MC; QStE 500 TM			E 490 D
1		1.0986 S500MC; QStE 500 TM	1501 - 60F55		E 560 D
1	1010	1.1121 CK 10 (C10E)	040 A 10		XC 10
1		1.1121 St 37-1	4360 40 A		
1	1015	1.1141 CK 15 (C15E)	040 A 15 080 M 15	32C	XC 12 XC 15 XC 18
1	1020 1023	1.1151 C22E CK 22	055 M 15 (070 M 20)		2 C 22 XC 18 XC 25
1	D 3	1.2080 X 210 Cr 12	BD 3		Z 200 C 12

					
SS	UNI	UNE	JIS	KS	GOST
2106	FeE 355 KG;KW	AEE 355 KG;DD	SM 490 A;B;C; YA;YB	SM 490 A;B;C; YA;YB	15GF
2106	FeE 355-2				
2107-01	FeE 355-3				
2132, 2133	17GS	AE 355 D	SM 490 A;B;C;	SM 490 A;B;C;	17GS
2134, 2174	17G1S	Fe 510, D1 FF	YA;YB	YA;YB	17G1S
1912	CF SMn 28	F.2111 - 11 SMn 28	SUM 22	SUM 22	
1912	CF 9 SMn 28	11 SMn 28	SUM 22	SUM 22	
1914	CF 9 SMnPb 28	F.2112-11 SMnPb 28	SUM 22 L SUM 23 L, SUM 24 L	SUM 22 L SUM 23 L, SUM 24 L	
	CF 10 S 20	F. 2121 - 10 S 20			
	CF 10 SPb 20	F.2122-10 SPb 20			
	CF 10 SPb 20	10 SPb 20			
	CF 9 Mn 36	F.2113 - 12 SMn 35	SUM25	SUM25	
2642	FeE 355TM				
2662	FeE 490 TM FeE 560 TM				
1265	C 10, 2 C 10 2 C 15	F-1510-C 10 K	S 9 CK S 10 C	S 9 CK S 10 C	08;10
1300					
1370	C 15	C 16 F.1110-C 15 F.1511-C 16 K	S 15 S 15 CK	SM 15C SM 15CK	15
1450	C 20	C 25 F.1120-C 25 K	S 20 C, S 20 CK S 22 C	SM 20 C, SM20 CK SM22 C	20
2642					

Material Conversion Table



► According to VDI 3323 standard







Material group					
	AISI/SAE	Material No. DIN	BS	EN	AFNOR
1	A36	St 44-2	4360 43 A		NFA 35-501 E 28
1		StE 320-3Z	1 501 160		
1	A572-60	1.8900 StE 380	4360 55 E		
2	(M) 1025	1.0406 C 25	070 M 26		1 C 25
2		1.0416 GS-38			20-400 M
2	A 537 Cl.1 A 414 Gr. G A 612	1.0473 P355GH	19 Mn 6		A 52 CP
2	1035	1.0501 C 35	080 A 32, 080 A 35 080 M 36, 1449 40 CS		1 C 35 AF 55 C 35 XC 38
2	1045	1.0503 CF 45 (C45G)	060 A 47 080 M 46		XC 42 H 1 TS
2	1040	1.0511 C 40	080 M 40		1 C 40 AF 60 C 40
2		1.0540 C 50			
2	A27 70-36	1.0551 GS-52	A2		280-480 M
2	A148 80-40	1.0553 GS-60	A3		320-560 M
2	A738	1.0577 S355J2G4 (Fe 510 D 2)	Fe 510 D2 FF 1501 Gr.224-460 1501 Gr. 224-490		A 52 FP
2	1140	1.0726 35 S 20	212 M 36	8M	35MF 6
2	1146	1.0727 45 S 20 (46S20)			45 MF 4
2	1035 1041	1.1157 40Mn4	150 M 36	15	35 M 5 40 M 5
2	1025	1.1158 C25E CK 25	(070 M 25)		2 C 25 XC 25
2	1536	1.1166 34Mn5			
2	1330	1.1170 28Mn6	(150 M 28), (150 M 18)		20 M 5, 28 Mn 6
2	1330	1.1170 28Mn6	150 M 5		20 M 5
2	1330	1.1170 28Mn6		14A	20 M 5
2		1.1178 C30E; CK 30	080M30		XC 32

 SS	 UNI	 UNE	 JIS	 KS	 GOST
1411					
1421					
2145	FeE390KG C 25	1 C 25	S 25C	SM 25C	
1306					
2101 2102	Fe E 355-2	A 52 RC I RA II	SGV 410 SGV 450 SGV 480	SGV 410 SGV 450 SGV 480	
1572 1550	C 35 1 C 35	F.113	S35C	SM35C	35
1672	C 43 C 46 C 40	1 C 40	S 45 C S 40 C	SM 45 C SM 40 C	45
1674	C 50	1 C 50			
1505					
1606					
2107		A 52 RB II AE 355 D			
1957 1973		F.210.G			
			S 09CK	SMn 433	
C 25	F.1120 - C 25 K TO.B	S 25 C S 28 C SMn 433 H	S 25 C	SM 25 C	
1421	C 28 Mn	28 Mn 6	SCMn 1	SCMn 1	30G
2145					
	C 28 Mn C 30	2 C 30	SCMn 1	SCMn 1	

Material Conversion Table





► According to VDI 3323 standard







Material group					
	AISI/SAE	Material No. DIN	BS	EN	AFNOR
2	1035	1.1180 C35R Cm 35	080 A 35		3 C 35 XC 32
2	1035	1.1181 C35E	080 A 35		2 C 35, XC 32
	1038	CK 35	(080 M 36)		XC 38 H 1
2	1035	1.1181 C35E CK 35	080 A 35 (080 M 36)		
2	1042	1.1191 GS- Ck 45	080 A 46		XC 45
2	1049	1.1206 C50E	080 M 50		2 C 50
	1050	CK 50			XC 48 H 1; XC 50 H 1
2	1050	1.1213 Cf 53	070 M 55		XC 48 H TS
	1055	(C53G)			
2	4520	1.5423 22Mo4	1503-245-420		
3		1.0050 St50-2			
3	A 516 Gr.70 A 515 Gr. 70 A 414 Gr.F; G	1.0481 P295GH 17 Mn 4	1501 Gr. 224		a 48 Cp;AP
3	1043	1.0503 C35	060 A 47 080 M 46 1449 50 HS, CS		1 C 45 AF 65 C 45
3	1074	1.0614 C 76 D; D 75-2			XC 75
3	1086	1.0616 C 86 D; D 85-2			XC 80
3	1095	1.0618 C 92 D;D 95-2			XC 90
3	1036 1330	1.1165 30Mn5	120 M 36 (150 M 28)		35 M 5
3	1335	1.1167 30Mn5	150 M 36		40 M 5
3	1040	1.1186 C40E CK 40	060 A 40, 080 A 40 080 M 40		2 C 40 XC 42 H 1
3	1045	1.1191 C45E CK 45	080 M 46 060 A 47		2 C 45 XC 42 H 1 XC 45 XC 48 H 1

					
SS	UNI	UNE	JIS	KS	GOST
1572		F.1130-C 35 K-1			
1550	C35	F.1130-C 35 K	S 35 C	SM 35 C	35
1572					
1572	C36		S 35 C	SM 35 C	
1660	C45	F-1140			
1674	C 50				50
1674	C 53		S 50 C	SM 50 C	50
	16 Mo 5 KG; KW	F.2602- 16 Mo 5	SB 450 M	SB 450 M	SB 480 M
	FE50				
	Fe 510 KG;KT;KW	A 47 RC I RA II	SG 365, SGV 410	SG 365, SGV 410	14G2
	Fe 510-2 KG;KT;KW		SGV 450	SGV 450	
	FeE 295		SGV 480	SGV 480	
1672	C 45	F.114	S 45 C	SM 45 C	45
1650	1 C 45				
C 85					
		F.8211-30 Mn 5	SMn 433 H	SMn 433 H	27ChGSNMDDL
		f.8311-AM 30 Mn 5	SCMn 2	SCMn 2	30GSL
2120		F. 1203-36 Mn 6	SMn 438 (H)	SMn 438 (H)	35G2
		F. 8212-36 Mn 5	SCMn 3	SCMn 3	35GL
	C 40		S 40 C	SM 40 C	
1672	C 45	F.1140-C 45 K	S 45 C	S 45 C	45
	C 46	F.1142-C48 K	S 48 C	S 48 C	

Material Conversion Table





► According to VDI 3323 standard







Material group					
	AISI/SAE	Material No. DIN	BS	EN	AFNOR
3	1049	1.1201 C45R Cm 45	080 M 46		3 C 45 XC 42 H 1 XC 48 H 1
3		1.7242 18 CrMo 4			
3	A 387 Gr. 12 Cl	1.7337 16 CrMo 4 4			
3	A 387 Gr. 12 Cl	1.7337 16 CrMo 4 4			
3		1.7362 12 CrMo 19 5	3606-625		Z 10 CD 5.05
3	A572-60	17 MnV 6	436055 E		NFA 35-501 E 36
4	1055	1.0535 C55	070 M 55		1 C 55 AF 70 C 55
4	1060	1.0601 C60	060 A 62 1449 HS,CS	43D	1 C 60 AF 70 C 55
4	1070	1.0603 C67	080 A 67 1449 70HS		XC65
4	1074 1075	1.0605 C75	1449 80 HS		
4	1055	1.1203 C55E CK 55	060 A 57 070 M 55		2 C 5 XC 55 H 1
4	1055	1.1209 C55R Cm 55	070 M 55		3 C 55 XC 55 H 1
4	1060 1064	1.1221 C60E CK 60	060 A 62	43D	2 C 60 XC 60 H 1
4	1070	1.1231 CK 67 (C67E)	060 A 67		XC 68
4	1074 1075 1078	1.1248 CK 75 (C75E)	060 A 78		XC 75
4	1086	1.1269 CK 85 (C85E)			XC 90
4	1095	1.1274 Ck 101 (C101E)			XC 100
4	W 112	1.1663 C 125 W			Y2 120
4					
5		1.0070 St70-2			
5		1.7238 49 CrMo 4			
5		1.7701 51 CrMoV 4			

					
SS	UNI	UNE	JIS	KS	GOST
1660	C 45	F.1145-C 45K-1 F.1147C 48 K-1	S 50 C	SM 50 C	
18 CrMo 4	A 18 CrMo 4 5 KW A 18 CrMo 4 5 KW 16 CrMo 20 5				
2142					
1655	C 55 1 C 55 C 60 1 C 60 C 67 C 75		S 55 C S 58 C	SM 55 C SM 58 C	55 60(G) 75
1655	C 55 C 55	F.1150-C 55 K F.1155-C 55 K-1	S 55 C	SM 55 C	55
1655 1678	C 60		S 58 C	SM 58 C	60 60G, 60GA
1770	C 70				65GA 68GA , 70
774	C 75 C 90 C 100	F-5117	SUP 4	SPS 4	75(A) 85(A)
1870 2223	FE70-2				
	51 CrMoV 4				

Material Conversion Table



► According to VDI 3323 standard







Material group					
	AISI/SAE	Material No. DIN	BS	EN	AFNOR
6	A573-81 65	1.0116 St 37-3	4360 40 B		E 24-U
6	A515 65	1.0345 H1	1 501 161		A 37 CP
6	5120	1.0841 St 52-3	150 M 19		20 MC 5
6	9255	1.0904 55 Si 7	250A53	45	55S7
6	9254	1.0904 55 Si 7	250 A 53		55 S 7
6	9262	1.0961 60SiCr7	1 501 161		60SC6
6	L3	1.2067 100Cr6	BL3		Y100C6
6	L1	1.2108 90 CrSi 5			
6	L2	1.2210 115CrV3			100C3
6		1.2241 51CrV4			
6		1.2311 40 CrMnMo 7			
6	4135	1.2330 35 CrMo 4	708 A 37		34 CD 4
6		1.2419 105WCr6	BO1		105WC13
6	0 1	1.2510 100 MnCrW 4	BS1		8 MO 8
6	S1	1.2542 45 WCrV7			
6	S1	1.255 60WCrV7			55WC20
6	L6	1.2713 55NiCrMoV6			55NCDV7
6	L6	1.2721 50NiCr13			55 NCV 6
6	O2	1.2842 90MnCrV8	BO2		90 MV8
6	E 50100	1.3501 100 Cr 2			55WC20
6	52100	1.3505 100Cr6	2 S 135 535 A 99	31	100 C 6
6		1.5024 46Si7			45 S 7; Y 46 7;46 SI 7
6	9255	1.5025 51Si7			51 S 7 51 Si 7
6	9255	1.5026 55Si7	251 a 58		55 S 7
6	9260	1.5027 60Si7	251 A 60 251 H 60		60 S 7
6	9260 H	1.5028 65Si7			60 S 7
6		1.5120 38 MnSi 4			

 SS	 UNI	 UNE	 JIS	 KS	 GOST
1312	Fe37-3				
1330					
2172	Fe 52	F-431			
2085	55Si8	56Si7			
2090		F-431			
60SiCr8	60SiCr8				
	100Cr6				
2092	105WCR 5				
	107CrV3KU				
	35 cRmO 8 KU				
2234	35CrMo4	34CrMo4	SCM435TK	SCM435TK	
2140	10WCr6	105WCr5			
2140	10WCr6	105WCr5	SKS 31	STS 31	
2710	45 WCrV8 KU	45WCrSi8			
2710	58WCr9KU				
		F.520.S	SKT 4	STF 4	
2550		f-528			
2258	100Cr6	F.1310 - 100 Cr 6	SUJ2	STB 2	SchCh 15
		F. 1451 - 46 Si 7			
2090	48 Si 7	F.1450-50 Si 7			
	50 Si 7				
2085 2090	55 Si 7	F.1440 - 56 Si 7			55S2
	60 Si 7	F. 1441 - 60 Si 7			60S2
			50 P 7 SUP 6	SPS 6	

Material Conversion Table

► According to VDI 3323 standard







Material group					
	AISI/SAE	Material No. DIN	BS	EN	AFNOR
6	A 204 Gr.A 4017	1.5415 16Mo3 15 Mo 3	1503-243 B		15 D 3
6	4419	1.5419 20Mo4	1503-243-430		
6	A 350-LF 5	1.5622 14Ni6			16N6
6	3415	1.5732 1 NiCr10			14 NC 11
6	3310; 3314	1.5752 14NiCr14	655M13	36A	12NC15
6		1.6587 17CrNiMo6	820A16		18NCD6
6		1.6657 14NiCrMo134			
6	5515	1.7015 15 Cr 3	523 M 15		12 C 3
6	5132	1.7033 34Cr4	530A32	18B	32C4
6	5140	1.7035 41C r4	530M40	18	42C4
6	5140	1.7045 42Cr41	530 A 40		42 C 4 TS
6	5115	1.7131 16MnCr5	527 M 17		16 MC 5
6		1.7139 16MnCr5			
6	5515	1.7176 55Cr3	527 A 60	48	55 C 3
6	4135; 4137	1.7220 34CrMo4	708 Aa 37		35 CD 4
6	4142	1.7223 41CrMo4			
6	4140	1.7225 42CrMo4	708 M 0		42 CD 4
6		1.7228 55NiCrMoV6G	823M30	33	
6		1.7262 15CrMo5			12 CD 4
6		1.7321 20 mOcR 4			
6	ASTM A182 F-12	1.7335 13CrMo4 4	1501-620Gr27		
6	A 182-F11;12	1.7335 13 CrMo 4 4	1 501 620 Gr. 27		15 CD 4.5
6	ASTM A 182 F.22	1.7380 10CrMo9 10	1501-622gR31; 45		
6	A182 F-22	1.7380 10 CrMo 9 10	1501-622		12 CD 9.10
6		1.7715 14MoV6 3	1503-660-440		
6	A355A	1.8509 41CrAlMo 7	905 M 39	41B	40 CAD 6.12
7	A570.36	1.0038 S235JRG2 (Fe 360 B) RSt 37-2	Fe 360 B FU 1449 27/23 CR 4360-40 B		E 24-2NE
7	3135	1.5710 36NiCr6	640A35		35NC6

					
SS	UNI	UNE	JIS	KS	GOST
2912	16Mo3(KG;KW)	F. 2601 - 16 Mo 3			
-2512	G 20 Mo 5 G 22 Mo5		SCPH 11	SCPH 11	
14 Ni 6 KG;KT	F.2641 - 15 Ni 6				
16NiCr11	15NiCr11	SNC415(H) SNC815(H)			
	14NiCrMo13				
	14NiCrMo131				
			SCr415(H)	SCr415(H)	
	34Cr4(KB)	35Cr4	SCr430(H)	SCr430(H)	
	41Cr4	42Cr4	SCr440(H)	SCr440(H)	
2245	41Cr4	42Cr4	SCr440	SCr440	
2511	16MnCr5	16MnCr5			
2127					
2253			SUP9(A)	SPS 9(A)	
2234					
	41CrMo4	42CrMo4	SNB 22-1	SNB 22-1	
2244					
2512	653M31				
2216		12CrMo4			
2625					
	14CrMo4 5	14CrMo45			
2216		12CrMo4	SCM415(H)	SCM415(H)	
2218	12CrMo9,10	TU.H 13MoCrV6			
2940	41CrAlMo7	41CrAlMo7			
1312	Fe 360 B FN	AE 235 B FN;FU Fe 360 B FN; FU			St3ps; sp

Material Conversion Table





► According to VDI 3323 standard







Material group					
	AISI/SAE	Material No. DIN	BS	EN	AFNOR
7		1.5755 31 NiCr 14	653 M 31		18 NC 13
7	8620	1.6523 2 NiCrMo2	805M20	362	20 NCD 2
7	8740	1.6546 40 NiCrMo 22	311-Tyre 7		
7	4130	1.7218 25CrMo4	CDS 110		25 CD 4
7		1.7733 24 CrMoV 5 5			20 CDV 6
7		1.7755 GS-45 CrMOV 10 4			
7		1.8070 21 CrMoV 5 11			
8	4142	1.2332 47 CrMo 4	708 M 40	19A	42 CD 4
8	A128 (A)	1.3401 G-X120 Mn 12			Z 120 M 12
8	3435	1.5736 36 NiCr 10			30 NC 11
8	9840	1.6511 36CrNiMo4	816M40	110	40NCD3
8	4340	1.6582 35CrNiM 6	817 M 40	24	35 NCD 6
8		1.7361 32 CeMo12	722 M 24	40B	30 CD 12
8	6150	1.8159 50 CrV 4	735 A 50	47	50CrV4
8		1.8161 58 CrV 4			
8		1.8515 32 CrMo 12	722 M 24	40B	30 CD 12
8		1.8523 39CrMoV13 9	897M39	40C	
9		1.4882 X 50 CrMnNiNbN 21 9			Z 50 CMNNb 21.09
9	3135	1.5710 36NiCr6	640A35	111A	35NC6
9		1.5864 35 niCr 18			
9		31 NiCrMo 13 4	830 m 31		
10	A573-81	1.0144 ST 44-3	4360 43 C		E 28-3
10	A 619	1.0347 DCO3 RSt;RRSt 13	1449 3 CR 1449 2 CR		E
10	M 1015 M 1016 M 1017	1.0401 C15	080 M 15 080 M 15 1449 17 CS		AF 37 C12 XC 18
10		1.0570 ST 52-3	4360 50 B		E 36-3
10	12L13	1.0718 9SMnPb28			S250Pb
10	(12L13)	1.0718 9 SMnPb 28			S 250 Pb

					
SS	UNI	UNE	JIS	KS	GOST
2506	20NiCrMo2	20NiCrMo2	SNCM220(H)	SNCM220(H)	
	40NiCrMo2(KB)	40NiCrMo2	SNCM240	SNCM240	
2225	25CrMo4(KB)	55Cr3	SCM420/430	SCM420/430	
	21 CrMoV 5 11				
	35 NiCr 9				
2244	42CrMo4	42CrMo4	SCM (440)	SCM (440)	
2183	GX120Mn12	F. 8251-AM-X120Mn12	SCMnH 1, SCMn H 11	SCMnH 1, SCMn H 11	110G13L
	36NiCrMo4(KB)	35NiCrMo4	SUP 10	SPS 10	
2541	35NiCrMo6(KB)		SNCM 447	SNCM 447	
2240	30CrMo12	F.124.A			
2230	50CrV4	51CrV4			
2240	32CrMo12	F.124.A			
	36CrMoV12				
			SNC236	SNC236	
2534		f-1270			
1412			SM 400A;B;C	SM 400A;B;C	
	Fep 02	AP 02			08JU
1350	C15				
	C16	F.111	S 15 C	SM 15 C	
	1 C 15				
2132	Fe52BFN/Fe52CFN		SM490A;B;C;YA;YB	SM490A;B;C;YA;YB	
1914	CF9SMnPb28	11SMnPb28			
1914	CF 9 SMnPb 28	11 SMnPb 28	SUM 22L	SUM 22L	

Material Conversion Table





► According to VDI 3323 standard







Material group					
	AISI/SAE	Material No. DIN	BS	EN	AFNOR
10		1.0723 15 S 22 15 S 20	210 A 15 210 M 15		
10		1.2083			
10	H 11	1.2343 x 38 CrMoV 5 1	BH 11		Z 38 CDV 5
10	H 13	1.2344 X 40 CrMoV 5 1	BH 13		Z 40 CDV 5
10	A 2	1.2363 X100 CrMoV 5 1	BA 2		Z 100 CDV 5
10	D 2	1.2379 X 155 CrMo 12 1	BD2		Z 160 CDV 12
10	HNV3	1.2379 X210Cr12G	BD2		Z160CDV12
10	D 4 (D 6)	1.2436 X 210 CrW 12	BD6		Z 200 CD 12
10	H 21	1.2581 X 30 WCv 9 3	BH 21		Z 30 WCV 9
10		1.2601 X 165 CrMoV 12			
10	H 12	1.2606 X 37 CrMoW 5 1	BH 12		Z 35 CWDV 5
10	D3	1.3343 S 6-5-2	BM2		Z200C12
10	N08028	1.4563			Z1NCDU31-27-03
10	ASTM A353	1.5662 X8Ni9	1501-509;510		
10	ASM A353	1.5662 X8Ni9	502-650		9 Ni
10	2517	1.5680 12Ni19	12Ni19		Z18N5
10	2515	1.5680 12 Ni 19			Z 18 N 5
11		1.3202 S 12-1-4-5	BT 15		
11		1.3207 S 10-4-3-10	BT 42		Z130WKCDV
11	T15	1.3243 S 6-5-2-5			KCV 06-05-05-04-02
11		1.3246 S 7-4-2-5			Z110 WKCDV 07-05-04
11		1.3247 S 2-10-1-8	BM 42		Z110 DKCWW 09-08-04
11	M 42	1.3249 S 2-9-2-8	BM 34		
11	T 4	1.3255 S 18-1-2-5	BT 4		Z 80 WKCV 18-05-04-0
11	M 2	1.3343 S6-5-2	BM2		Z 85 WDCV
11	M 7	1.3348 S2-9-2			Z 100 DCWV 09-04-02-

 SS	 UNI	 UNE	 JIS	 KS	 GOST
1922		F.210.F	SUM 32	SUM 32	
2314	X 37 CrMoV 5 1 KU				
2242	X40CrMoV511KU	F-5318	SKD61	STD61	
2260	X100CrMoV51KU	F-5227	SKD12	STD12	
2310	X165CrMoW12KU	X160CrMoW12KU			
2736					
2312	X215CrW 12 1 KU	F-5213			
	X30WCrV 9 3 KU	F-526	SKD5	STD5	
2310					
	X 35 CrMoW 05 KU	F.537			
2715	X210Cr13KU	X210Cr12	SUH3	STR3	
2584					
	14 Ni 6 KG;KT	XBNI09			
	X10Ni9	F-2645	SL9N60(53)	SL9N590(520)	
	HS 12-1-5-5	12-1-5-5			
2723	HS 6-5-2-5	6-5-2-5	SKH55	SKH55	
7-4-2-5	HS 7-4-2-5	M 35			
2-10-1-8	HS 2-9-1-8 2-9-2-8	M 41			
2722	HS 652	F-5604	SKH 51	SKH 51	
2782	HS 292	F-5607			

Material Conversion Table





► According to VDI 3323 standard







Material group					
	AISI/SAE	Material No. DIN	BS	EN	AFNOR
11	T 1	1.3355 S 18-0-1	BT 1		Z 80 WCV 18-4-01
11	630	1.4548			Z7CNU17-04
11	HNV 3	1.4718 X45CrSi 9 3	401S45	52	Z45CS9
11	422	1.4935 x20 CrMoWV 12 1			
12	403	1.4000 X6Cr13	403 S 17		Z 6 C 13
12		1.4001 X6Cr14			
12	(410S)	1.4001 X7 Cr 13	(403 S 7)		Z 8 C 13
12	405	1.4002 X6CrA12	405S17		Z8CA12
12	405	1.4002 X6 CrAl 13	405 S 17		Z6CA13
12	416	1.4005 X12CrS 13	416 S 21		Z11 CF 13
12	410; CA-15	1.4006 (G-)X10 Cr 13	410S21	56A	Z10 C 13
12	430	1.4016 X8Cr17	Z8C17		430S15
12	430	1.4016 X6 Cr 17	430 S 15	60	Z 8 C 17
12		1.4027 G-X20Cr14	420 C 29		Z20 C 13M
12		1.4027 G-X 20 Cr 14	420 C 29		Z 20 C 13M
12	420	1.4028 X30 Cr 13	420 S 45		Z 30 C 13
12		1.4086 G-X120Cr29	452C11		
12	430 F	1.4104 X12CrMoS17	420 S 37		Z 10 CF 17
12	440B	1.4112 X90 CrMoV 18			
12	434	1.4113 X6CrMo 17	434 S 17		Z 8 CD 17.01
12		1.4340 G-X40CrNi27 4			
12	S31500	1.4417 X2CrNiMoSi19 5			
12	S31500	1.4417 X2 CrNoMoSi 18 5 3			
12		1.4418 X4 CrNiMo16 5			Z6CND16-04-01
12	XM 8	1.4510			Z 4 CT 17
	430 Ti				
	439				
12	430tl	1.4510 X6 CrTi 17			Z 4 CT 17
12		1.4511 X 6 CrNb 17(X 6 CrNb 17			Z 4 CNb 17
12	409	1.4512 X 6 CrTi 12 (X2CrTi12)	LW 19 409 S 19		Z 3 CT 12
12		1.4720 X20CrMo13			

 SS	 UNI	 UNE	 JIS	 KS	 GOST
	X45CrSi8	F322	SUH1	STR1	
2301	X6Cr13	F.3110 F8401	SUS403	STS 403	
2301	X6CrAl13				
2302	X6CrAl13				
2380	X12 CrSC13	F-3411	SUS 416	SUS 416	
2302	X12Cr13	F.3401	SUS 410	SUS 410	
2320	X8Cr17	F.3113			
2320	X8Cr17	F.3113	SUS 430	SUS 430	
2304					
2383	X10CrS17	F.3117	SUS430F	STS 430F	
2325	X8CrMo17		SUS434	STS 434	
2376					
2376					
2387	X 6 CrTi 17	F.3115-X 5 CrTi 17	SUS 430 LK	STS 430 LX	08 Ch17T
	X 6 CrNb 17	F.3122-X 5 CrNb 17	SUS 430 LK	STS 430 LX	
	X 6 CrTi 17		SUH 409	STR 409	

Material Conversion Table





► According to VDI 3323 standard



Material group					
	AISI/SAE	Material No. DIN	BS	EN	AFNOR
12	405	1.4724 X10CrA113	403S17		Z10C13
12	430	1.4742 X10CrA118	439S15	60	Z10CAS18
12	HNV6	1.4747 X80CrNiSi20	443S65	59	Z80CSN20.02
12	446	1.4749 x18 cRn 28			
12	446	1.4762 X10CrA124			Z10CAS24
12	EV 8	1.4871 X 53 CrMnNiN 21 9	349 S 54		Z 52 CMN 21.09
12	302	x12 CrNi 18 9	302 S 31		Z 10 CN 18-09
12	429	X10 CrNi 15			
13	420	1.4021 X20Cr13	420S37		Z 20 C 13
13	420	1.4031 X40 Cr 13			Z 40 C 14
13		1.4034 X46Cr13	420 S 45		Z40 C 14
13	431	1.4057 X20CrNi172	431 S 29	57	Z 15 CN 16.02
13		1.4125 X 105 CrMo 17			Z 100 CD 17
13	CA6-NM	1.4313 G-X4 CrNi 13 4	425 C 11		Z 4 CND 13-04 M
13	630	1.4542 X 5 CrNiCuNb 17 4 (X5CrNiCuNb 16-4)			
13		1.4544	S. 524 S. 526		
13	348	1.4546 X5CrNiNb 18-10	347 S 31 2 S. 130 2 S. 143/144/145 S.525/527		
13		1.4922 x20cRmV12-1			
13		1.4923 X22 CrMoV12 1			
14	304	1.4301 X 5 CrNi 18 9	304 S 15		Z 5 CN 18.09
14	303	1.4305 X10 CrNiS 18 9	303 S 21	58M	Z 8 CNF 18-09
14	304L	1.4306 X2CrNi18 9	304S12		Z2CrNi18 10
14	304L	1.4306 X2 CrNi 18 10	304 S 11		Z 3 CN 19-11
14	CF-8	1.4308 X6 CrNi 18 9	304 C 15	58E	Z 6 CN 18-10 M
14	301	1.4310 X12CrN i17 7	301 S 21		Z 12 CN 17.07

					
SS	UNI	UNE	JIS	KS	GOST
	X10CrA112	F.311			
	X8Cr17	F.3113	SUS430	STS430	
	X80CrSiNi20	F.320B	SUH4	STR4	
2322	X16Cr26		SUH446	STR446	
	X53CrMnNiN21 9		SUH35,SUH36	STR35,STR36	
2330					
2303	14210				
-2304					
	X40Cr14	F.3405	SUS420J2	STS420J2	
2321	X16CrNi16	F.3427	SUS431	STS431	
	X 105 CrMo 17				
2385	(G)X6CrNi304		SCS5	SSC5	
	X 6 CrNiTi 18 11				08Ch 18N12T
	X 6 CrNiNb 18 11				
2317	x20cRmOnl 12 01				
2332;2333					
2346	X10CrNiS18.09	F.3508	SUS303	STS303	
2352	x2cRn18 11	F.3503	SCS19	SSC19	
2352	X2CrNi18 11				
2333			SUS304L	STS304L	
2331	X2CrNi18 07	F.3517			

Material Conversion Table





► According to VDI 3323 standard







Material group					
	AISI/SAE	Material No. DIN	BS	EN	AFNOR
14	304 LN	1.4311 X2 CrNiN 18 10	304 S 62		Z 2 CN18.10
14		1.4312 G-X10CrNi18 8	302C25		Z10CN18.9M
14	305	1.4312 X8 CrNi 18 12	305 S 19		
14		1.4332 X2 CrNi 18-8			
14	304	1.4350 X5CrNi18 9	304S15	58E	Z6CN18.09
14	S32304	1.4362 X2 CrNiN 23 4			Z 2 CN 23-04 AZ
14	202	1.4371 X3 CrMnNiN 188 8 7	284 S 16		Z 8 CMN 18- 08-05
14	316	1.4401 X 5 CrNiMo 17 12 2 (X4 CrNiMo 17 -12-2)	316 S 13 316 S 17 316 S 19 316 S 31 316 S 33		Z 3 CND 17 -11-01 Z 6 CND 17-11 Z 6 CND 17-11-02 Z 7 CND 17-11-02 Z 7 CND 17-12-02
14	316L	1.4404 X2 CrNiMo 17 13 2 (X2 CrNiMo 17-12-2) GX 2 CrNiMoN 18-10	316 S 11, 316 S 13 316 S 14, 316 S 31; 316 S 42, S.537;316 C 12, T.75, S. 161		Z 2 CND 17-12 Z 2 CND 18-13 Z 3 CND 17-11-02 Z 3 CND 17-12-02 FF Z 3 CND 18-12-03 Z 3 CND 19.10 M
14	316LN	1.4406 X2 CrNiMoN 17 12 2 (X2CrNiMoN 18-10)	316 S 61 316 S 63		Z2 CND 17-12 AZ
14	CF-8M	1.4408 GX 5 CrNiMoN 7 12 2 G-X 6 CrNiMo 18 10	316 C 16 (LT 196) ANC 4 B		
14		1.4410 G-X10CrNiMo18 9			Z5CNaD20.12M
14	316 Ln	1.4429 X2 CrNiMo 17 -13-3	316 S 62		Z 2 CND 17-13 Az
14	316L	1.4435 X2 CrNiMo18 14 3	316 S 11;316 S 13 316 S 14;316 S 31 LW 22 LWCF 22		Z 3 CND 17-12-03 Z 3 CND 18-14-03
14	316	1.4436 X 5 CrNiMo 17 13 3 (X4CRNIMO 17-13-3)	316 S 19; 316 S 31 316 S 33 LW 23 LWCF 23		Z 6 CND 18-12-03 Z 7 CND 18-12-03

					
SS	UNI	UNE	JIS	KS	GOST
2371	X2CrNiN18 10		SUS304LN	STS304LN	
2332	X5CrNi18 10	F.3551	SUS304	STS304	
2347	X 5 CrNiMo 17 12	F.3534-X 5 CrNiMo 17 12 2	SUS 316	STS 316	
2348	X 2 CrNiMo 17 12	F.3533 - X 2 CrNiMo 17 13 2			
	G-X 2 CrNiMo 19 11	F.3537 - X 2 CrNiMo 17 13 3	SUS 316 L	STS 316 L	
	X 2 CrNiMoN 17 12	F.3542-X 2 CrNiMoN 17 12 2	SUS316LN	STS316LN	
2343		F.8414-AM-X 7 CrNiMo 20 10	SCS 14	SSC 14	07 Ch 18N10G2S2MSL
2328					
2375	X 2 CrNiMoN 17 13	F.3543-X 2 CrNiMoN 17 13 3	SUS 316 LN	STS 316 LN	
2375	X 2 CrNiMoN 17 13	F.3533-X 2 CrNiMo 17 13 2	SUS 316 L	STS 316 L	O3 Ch 17N14M3
2343	X 5 CrNiMo 117 13 X 8 cRnImO 17 13	F.3543-X 5 CrNiMo 17 12 2 F.3538-X 5 CrNiMo 17 13	SUS 316	STS 316	

Material Conversion Table

► According to VDI 3323 standard







Material group	 AISI/SAE	 Material No. DIN	 BS	 EN	 AFNOR
14	317L	1.4438 X2 CrNiMo 18 16 4 (X2CrNiMo 18-15-4)	317 S 12		Z 2 CND 19-15-04 z 3 cnd 19-15-04
14	(s31726)	1.4439 X2 CrNiMoN 17 13 5			Z 3 CND 18-14-06 AZ
14		1.4440 X 2 CrNiMo 18 13			
14	317	1.4449 X5 CrNiMo 17 13 3	317 S 16		
14	329	1.4449 X 4 CrNiMo 27 5 2 1.4460 (X3CrNiMo27-5-2)			(Z 3 CND 25-07 Az) Z 5 CND 27-05 Az
14	329	1.4460 X8CrNiMo27 5			
14		1.4462 X2CrNiMoN22 5 3	318 S 13		Z 3 CND 22-05 Az (Z 2 CND 24 -08 Az) (Z 3 CND 25-06-03 Az)
14		1.4500 G-X7NiCrMoCuNb25 20			Z3NCDU25.20M
14	17-7PH	1.4504	316S111		
14	443 444	1.4521 X2CrMoTi18-2	317 S 16		
14	UNS N 08904	1.4539 X1NiCrMoCuN25-20-5			Z 2 NCDU 25-20
14	CN-7M	1.4539 (G-)X1 NiCrMoCu 25 20 5			Z1 NCDU 25-02 M
14	321	1.4541 Z 6 CrNiTi 18-10	321 S 31 321 S 51 (1010;1105) LW 24 LWCF 24		Z 6 CNT 18-10
14	630	1.4542 X5 CrNiCuNb 17 4 (X5 CrNiChNb 16-4)			Z 7 CNU 15-05 Z 7 CNU 17-04
14	17-4PH	1.4542			Z7CNU17-04
14	S31254	1.4547 X1 CrNiMoN 20 18 7			
14	17-4PH	1.4548			Z7CNU17-04
14	347	1.4550 X6 CrNiNb 18 10	347 S 17	58F	Z 6 CNNb 18.10
14		1.4552 G-X7CrNiNb18 9			Z4CNNb19.10M
14	17-7PH	1.4568	316S111		
14	316tTi	1.4571 X6 CrNiMoTi 17 12 2	320 S 31		Z 6 CNDT 17-12002
14		1.4581 G-X 5 CrNiMoNb	318 C 17		Z 4 CNDNb 18.12 M
14	318	1.4583 X 10CrNiMoNb 18 12	303 S 21		Z15CNS20.12

 SS	 UNI	 UNE	 JIS	 KS	 GOST
2367	X2CrNiMo18 16	f.3539-x 2 cRnlmO 18 16 4	SUS317L	STS317L	
	X 5 CrNiMo 18 15		SUS 317	STS 317	
2324		F.3309-X 8 CrNiMo 17 12 2 F.3552-X 8 CrNiMo 18 16 4	SUS 329 J 1	STS 329 J 1	
2377			SUS 329 J3L	STS 329 J3L	
	Z8CNA17-07	X2CrNiMo1712			
2326		F.3123-X 2 CrMoTiNb 18 2	SUS 444	STS 444	
2562					
2564					
2337	X 6 CrNiTi 18 11	F.3523 - X 6 CrNiTi 18 10	SUS 321	STS 321	06Ch18N10T 08Ch18N10T 09Ch18N10T 12Ch18N10T
			SCS 24 SUS 630	SSC 24 STS 630	
2378					
2338	X6CrNiNb18 11	F.3552	SUS347	STS347	
	Z8CNA17-07	X2CrNiMo1712			
2350					
	x15cRnlsI2 12				

Material Conversion Table





► According to VDI 3323 standard







Material group	 AISI/SAE	 Material No. DIN	 BS	 EN	 AFNOR
14		1.4585 G-X7CrNiMoCuNb18 18			
14		1.4821 X20CrNiSi25 4			Z20CNS25.04
14		1.4823 G-X40CrNiSi27 4			
14	309	1.4828 X15CrNiSi20 12	309 S 24	58C	Z15CNS20.12
14	309S	1.4833 X6 CrNi 22 13	309 S 13		Z 15 CN 24-13
14	310 S	1.4845 X12 CrNi 25 21	310S24		Z 12 CN 25-20
14	321	1.4878 X6 CrNiTi 18 9	32 1 S 20	58B	Z 6 CNT 18-12 (B)
14	Ss30415	1.4891 X5 CrNiNb 18 10			Z20CNS25.04
14	S30815	1.4893 X8 CrNiNb 11			
14	304H	1.4948 X6 CrNi 18 11	304 S 51		Z 5 CN 18-09
14	660	1.498 X5 NiCrTi 25 15			Zz 8 nctv 25-15 b ff
14		X5 NiCrN 35 25			
14	S31753	X2 CrNiMoN 18 13 4			
14		X2 CrNiMoN 25 22 7			
15	CLASS20	0.6010 GG10			Ft10D
15	A48-20B	0.6010 GG-10			Ft 10 D
15	NO 25 B	0.6015 GG 15	Grade 150		Ft 15 D
15	CLASS25	0.6015 GG 15	Grade 150		Ft 15D
15	A48 25 B	0.6015 GG 15	Grade 150		Ft 15 D
15	A48-30B	0.6020 GG-20	Grade 220		Ft 20 D
15	NO 30 B	0.6020 GG 20	Grade 220		Ft 20 D
15	A436 Type 2	0.6660 GGL-NiCr202	L-NiCuCr202		L-NC 202
15	60-40-18	0.7040 GGG 40	SNG 420/12		FCS 400-12
15	No 20 B	GG 10			Ft 10 D
16	CLASS30	0.6020 GG 20	Grade 220		Ft 20D
16	CLASS45	0.6030 GG 30	Grade 300		Ft 30D
16	A48-45 B	0.6030	Grade 350		Ft 30D
16	A48-50	0.6035 GG-35	Grade 350		Ft 35 D
16	A48-60 B	0.6040 GG40	Grade 400		Ft 40 D
16	100/70/03	0.7070 GGG-70	SNG700/2		FGS 700-2

					
SS	UNI	UNE	JIS	KS	GOST
	X6CrNiMoTi17 12				
		F.8414	SCS17	SSC17	
2361	X6CrNi25 20	F.331	SUH310	STR310	
2337	X6CrNiTi18 11	F.3553	SUS321	STS321	
2372					
2368					
2333					
2570					
110	G 10				
0110-00					
0115-00	G 15	FG 15	FC150	GC150	
115	G 15	FG 15			
01 15-00	G 14	FG 15			
0120-00					
120	G 20		FC200	GC200	
0523-00					
0717-02	GS 370-17	FGE 38-17	FCD400	GCD400-18,15	
110			FC100	GC100	
120	G 20	FG 20			
130	G 30	FG 30	FC300	GC300	
01 30-00					
135	G 35	FG 35	FC350	GC350	
140					
07 37-01	GGG 70	GGG 70	FCD700	GCD700-2	

Material Conversion Table



► According to VDI 3323 standard







Material group					
	AISI/SAE	Material No. DIN	BS	EN	AFNOR
16		1.4829 X 12 CrNi 22 12			
17		0.7033 GGG35.3			
17		0.7033 GGG-35.3	350/22 L 40		FGS 370/17
17	60-40-18	0.7040 GGG-40	SNG 420/12		FGS 400-12
17	60/40/18	0.7043 GGG-40.3	370/7		FGS 370/17
17	80-55-06	0.7050 GGG50	SNG500/7		FGS 500/7
17	65-45-12	0.7050 GGG-50	SNG 500/7		FGS 500-7
17		0.7652 GGG-NiMn 13 7	S-NiMn 137		S-Mn 137
17	A43D2	0.7660 GGG-NiCr 20 2	Grade S6		S-NC 202
17		GGG 40.3	SNG 370/17		FGS 370-17
18	A48-40 B	0.6025 GG25	Grade260		Ft 25 D
18		0.7060 GGG60	SNG600/3		FGS600-3
18	80/55/06	0.7060 GGG-60	600/3		FGS 600/3
18	A48 40 B				
19		0.8055 GTW55			
19	32510	0.8135 GTS-35-10	B 340/12		MN35-10
19	A47-32510	0.8135 GTS-35-10	B 340/2		Mn 35-10
19	A220-40010	0.8145 GTS-45-06	P 440/7		Mn 450-6
19		GTS-35	B 340/12		
19			8 290/6		MN 32-8
19	32510	GTS-35	B340/12		MN 35-10
20		0.8035 GTM-35	W340/3		MB35-7
20		0.8040 GTW-40	W410/4		MB40-10
20		0.8045			
20		0.8065 GTMW-65			
20	A220-50005	0.8155 GTS-55-04	P 510/4		Mn 550-4
20	50005	0.8155 GTS-55-04	P 510/4		MP 50-5
20	70003	0.8165 GTS-65-02	P 570/3		Mn 650-3
20	90001	0.8170 GTS-70-02	P 690/2		Mn 700-2
20	A220-90001	0.8170 GTS-70-02			Mn 700-2

					
SS	UNI	UNE	JIS	KS	GOST
0717-15					
0717-15					
0717-02					
0717-15					
0727-02	GGG 50				
	0727-02		FCD 500	GCD 500-7	
0772-00					
0776-00					
0717-12					
125	G 25	FG 25	FC250	GC250	
07 32-03	GGG 60	GGG 60			
0727-03			FCD600	GCD600-3	
		GTW 55			
810		GTS 35			
0815-00					
	0852-00	GMN 45			FCMW370
0810-00					
814			AC4A	AC4A	
08 15			FCMW330	FCMW330	
852		GTM 35			
	GTB40	GTM 40			
	GMB45	GTM 45			
		GTM 65			
0854-00					
0854-00	GMN 55		FCMP490	PMC 490	
0856-00	GMN 65		FCMP590	PMC 590	

Material Conversion Table





► According to VDI 3323 standard

Material group	 AISI/SAE	 Material No. DIN	 BS	 EN	AFNOR
20		0.8170 GTS-70-02	IP 70-2		
20	1022				
	1518	1.1133 20Mn5	120 M 19		20 M 5
20	1035	1.1183 Cf 35 (C35G)	080 A 35		XC 38 H 1 TS
20	400 10	GTS-45	P440/7		
20	70003	GTS-65	P 570/3		MP 60-3
21	Al99	3.0205			
21	1000	3.0255 Al99.5	L31/34/36		A59050C
21		3.3315 AlMg1			
22		3.1325 AlCuMg 1			
22		3.1655 AlCuSiPb			
22		3.2315 AlMgSi1			
21	7050	3.4345 AlZnMgCuO,5	L 86		AZ 4 GU/9051
23		3.2381 G-AlSi 10 Mg			
23		3.2382 GD-AlSi10Mg			
23		3.2581 G-AlSi12			
23		3.3561 G-ALMg 5			
23	ZE 41	3.5101 G-MgZn4sE1Zr1	MAG 5		
23	EZ 33	3.5103 MgSE3Zn27r1	MAG 6		G-TR3Z2
23	AZ 81	3.5812 G-MgAl8Zn1	NMAG 1		
23	AZ 91	3.5912 G-MgAl9Zn1	MAG 7		
24		2.1871 G-AlCu 4 TiMg			
24		3.1754 G-AlCu5Ni1,5			
24		3.2163 G-AlSi9Cu3			
24	4218 B	3.2371 G-AlSi 7 Mg			
24	SC64D	3.2373 G-AlSi9MGWA			A-S7G
24		3.2373 G-AlSi 9 Mg			
24	QE 22	3.5106 G-MgAg3SE2Zr1	mag 12		
24	GD-AlSi12	G-ALMG5	LM5		A-SU12
23-24	A360.2	3.2383 G-AlSi0Mg(Cu)	LM9		

 SS	 UNI	 UNE	 JIS	 KS	 GOST
0862-00	GMN 70		FCMP690	PMC 690	
0864-00					
2132	G 22 Mn 3				
	20 Mn 7	F.1515-20 Mn 6	SMnC 420	SMnC 420	
1572	C 36; C 38		S 35 C	SM 35 C	35
08 52					
858			FCMP540	PMC 540	
811-04					
4231			C4BS	C4BS	
4252					
4253					





Material Conversion Table

► According to VDI 3323 standard

					
Material group	AISI/SAE	Material No. DIN	BS	EN	AFNOR
23-24	A356-72		2789;1973		NF A32-201
23-24	356.1		LM25		
23-24	A413.2	G-AISi12	LM6		
23-24	A413.1	G-AISi 12 (Cu)	LM20		
23-24	A413.0	GD-AISi12			
23-24	A380.1	GD-AISi8Cu3	LM24		
26	C93200	2.1090 G-CuSn 7 5 pb			U-E 7 Z 5 pb 4
26	C83600	2.1096 G-CuSn5ZnPb	LG 2		
26	C83600	2.1098 G-CuSn 2 Znpb			
26	C23000	2.1182 G-CuPb15Sn	LB1		U-pb 15 E 8
26	C93800	2.1182 G-CuPb15Sn			Uu-PB 15e 8
27		2.0240 CuZn 15			
27	C27200	2.0321 CuZn 37	cz 108		CuZn 36, CuZn 37
27	C27700	2.0321 CuZn 37	cz 108		CuZn 36, CuZn 37
27		2.0590 G-CuZn40Fe			
27	C 86500	2.0592 G-CuZn 35 Al 1	U-Z 36 N 3		HTB 1
27	C 86200	2.0596 G-CuZn 34 Al 2	HTB 1		U-Z 36 N 3
27	C 18200	2.1293 CuCrZr	CC 102		U-Cr 0.8 Zr
28		2.0060 E-Cu57			
28		2.0375 CuZn36Pb3			
28	C 94100	2.0596 G-CuZn 34 Al 2	HTB 1		U-Z 36 N 3
28	C 63000	2.0966 CuAl 10 Ni 5 Fe 4	Ca 104		U-A 10 N
28	B-148-52	2.0975 G-CuAl 10 Ni			
28	C 90700	2.105 G-CuSn 10	CT1		
28	C 90800	2.1052 G-CuSn 12	pb 2		UE 12 P
28	C 81500	2.1292 G-CuCrF 35	CC1-FF		
28		2.4764 CoCr20W15Ni			
31	N 08800	1.4558 X 2 NiCrAlTi 32 20	NA 15		
31	N 08031	1.4562 X 1 NiCrMoCu 32 28 7			





Material Conversion Table







► According to VDI 3323 standard

					
Material group	AISI/SAE	Material No. DIN	BS	EN	AFNOR
31	N 08028	1.4563 X 1 NiCrMoCuN 32 27 4			
31	N 08330	1.4564 X 12 NiCrSi 36 16	NA 17		Z 12 NCS 35.16
31	330	1.4564 X12 NiCrSi 36 16	NA 17		Z 12 NCS 37.18
31		1.4865 G-X40NiCrSi38 18	330 C 40		
31		1.4958 X 5 NiCrAlTi 31 20			
31	AMS 5544	LW2.4668 NiCr19NbMo			NC20K14
32		1.4977 X 40 CoCrNi 20 20			Z 42 CNKDOWNb
33	Monel 400	2.4360 NiCu30Fe	NA 13		NU 30
33	5390A	2.4603			NC22FeD
33	Hastelloy C-4	2.4610 NiMo16Cr16Ti			
33	Nimonic75	2.4630 NiCr20Ti	HR 5,203-4		NC 20 T
33		2.4630 NiCr20Ti	HR5,203-4		NC20T
33	Inconel 690	2.4642 NiCr29Fe			Nnc 30 Fe
33	Inconel 625	2.4856 NiCr22Mo9Nb	NA 21		NC 22 FeDNb
33	5666	2.4856 NiCr22Mo9Nb			Inconel 625
33	Incoloy 825	2.4858 NiCr21Mo	NA 16		NC 21 Fe DU
34	Monel k-500	2.4375 NiCu30 Al	NA 18		NU 30 AT
34	4676	2.4375 NiCu30Al	3072-76		
34		2.4631 NiCr20TiAl	Hr40;601		NC20TA
34	Inconel 718	2.4668 NiCr19FeNbMo			NC 19 Fe Nb
34	Inconel	2.4694 NiCr16fE7TiAl			
34		2.4955 NiFe25Cr20NbTi			
34	5383	LM2.4668 NiCr19Fe19NbMo	HR8		NC19eNB
34	5391	LW2 4670 S-NiCr13A16MoNb	3146-3		NC12AD
34	5660	LW2.4662 NiFe35Cr14MoTi			ZSNCDT42
34	5537C	LW2.4964 CoCr20W15Ni			KC20WN
34	AMS 5772	C0Cr22W14Ni			KC22WN
35	Inconel X-750	2.4669 NiCr15Fe7TiAl			NC 15 TNb A
35	Hastelloy B	2.4685 G-NiMo28			
35	Hastelloy C	2.4810 G-NiMo30			

Material Conversion Table

► According to VDI 3323 standard

Material group				
	AISI/SAE	Material No. DIN	BS	EN AFNOR
35	AMS 5399	2.4973 NiCr19Co11MoTi		NC19KDT
35		3.7115 TiAl5Sn2		
36	R 50250	3.7025 Ti 1	2 TA 1	
36	R 52250	3.7225 Ti 1 pd	TP 1	
36	AMS 5397	LW2 4674 NiCo15Cr10MoAlTi		
37		3.7124 TiCu2	2 TA 21-24	
37	R 54620	3.7145 TiAl6Sn2Zr4Mo2Si		
37		3.7165 TiAl6V4	TA 10-13;TA 28	T-A 6 V
37		3.7185 TiAl4Mo4Sn2	TA 45-51; TA 57	
37		3.7195 TiAl 3 V 2.5		
37		TiAl4Mo4Sn4Si0.5		
37	AMS R54520	TiAl5Sn2.5	TA14/17	T-A5E
37	AMS R56400	TiAl6V4	TA10-13/TA28	T-A6V
37	AMS R56401	TiAl6V4ELI	TA11	
38	W 1	1.1545 C105W1	BW 1A	Y1105
38	W210	1.1545 C105W1	BW2	Y120
38		1.2762 75 CrMoNiW 6 7		
38	440C	1.4125 X105 CrMo 17		Z 100 CD 17
38		1.6746 32 nlcRmO 14 5	832 M 31	35 NCD 14
40	Ni- Hard 2	0.9620 G-X 260 NiCr 4 2	Grade 2 A	
40	Ni- Hard 1	0.9625 G-X 330 Ni Cr 4 2	Grade 2 B	
40	Ni- Hard 4	0.9630 G-X 300 CrNiSi 9 5 2		
40		0.9640 G-X 300 CrMoNi 15 2 1		
40	A 532 III A 25% Cr	0.9650 G-X 260 Cr 27	Grade 3 D	
40	A 532 III A 25% Cr	0.9655 G-X 300 CrNMo 27 1	Grade 3 E	
40		1.2419 105 WCr 6	105WC 13	
40	310	1.4841 X15 CrNiSi 25 20	314 S31	Z 15 CNS 25-20
41		0.9635 G-X 300 CrMo 15 3		
41		0.9645 G-X 260 CrMoNi 20 2 1		
41		0.9655 G-X 300 CrNMo 27 1		

 SS	 UNI	 UNE	 JIS	 KS	 GOST
1880	C100KU	F-5118	SK3	STC 105(STC3)	
2900	C120KU	CF.515	SUP4	SPS 4	
	0512-00				
	0513-00				
	0466-00				
		107 WCr 5 KU			

TaeguTec Supply Network

World Headquarters

TaeguTec Ltd.

1040 Gachang-ro, Gachang-myeon,
Dalseong-gun, Daegu, 42936, Korea
Tel: +82-53-760-7639
Web: <http://www.taegutec.com>

Argentina

TaeguTec Argentina SA

11 de septiembre 4237- Piso 7
(C1429BJC) Ciudad Autónoma
Buenos Aires, Argentina
Tel: +54-11-4702-6222
E-mail: ventas@taegutec.com.ar

Australia

TaeguTec Australia Pty Ltd.

14/345 Plummer Street,
Port Melbourne, VIC 3207, Australia
Tel: +61-1300-811-080
E-mail: sales@taegutec.com.au

Belarus Rep.

Twing-M ALC

Slutskaia str 3, Minsk Area, 223056,
Village Senitsa, Republic of Belarus
Tel: +375-17-506-3238
E-mail: info@twing.by

Brazil

TaeguTec Do Brasil LTDA.

Rua Francisco Foga 500, 13288166
Dist Ind Benedito Storani, Vinhedo, Brazil
Tel: +55-11-3868-6032
E-mail: vendas@taegubrasil.com.br

Bulgaria

Tekotek BG Ltd.

Alexander Stamboliyski No 31,
7700 Targovishte, Bulgaria
Tel: +359-878-05-1818
E-mail: tekotekbg@gmail.com

Chile

Cutting Tools Chile SpA

Alcalde Pedro Alarcón N° 765,
San Miguel, Santiago - Chile
Tel: +56-2-553 6944
E-mail: ventas@cuttingtools.cl

China

TaeguTec Cutting Tools Trading

(Shanghai) Co., Ltd.

RM 1706, T1 Building, Global Creative
Center, No. 166 Minghong RD, Minhang
District, Shanghai, China
Zip Code : 201102
Tel: +86-21-5106-1260
E-mail: mail@taegutec.com.cn

Croatia

Intehna Zagreb D.O.O.

Samoborska cesta 255, 10090
Zagreb-Susedgrad, Croatia
Tel: + 385-1-3436-919
E-mail: info@intehna.hr

Czech Rep.

TaeguTec CR S.R.O.

Domažlická 180a, CZ-31800 Plzeň,
Czech Rep.
Tel: +420-373-720-999
E-mail: top@taegutec.cz

Denmark

TaeguTec Scandinavia A/S.

Hollandsvej 12, Room 206
DK-2800 Kgs. Lyngby, Denmark
Tel: +45-7022-0103
E-mail: tts@taegutec.dk

Finland

Knorrng OY AB

Mestarintie 4 FI-01730 Vantaa, Finland
Tel: +358-9-560-41
E-mail: knorrng@knorrng.fi

France

Ingersoll France S.A.R.L

22 Rue Albert Einstein -BAT.3
F-77420 Champs Sur Marne, France
Tel: +33 (0)1-64-68-45-36
E-mail: info@ingersoll-ipc.fr

Germany

Ingersoll Werkzeuge GmbH

Kalteiche Ring 21-25, D-35708
Haiger, Germany
Tel: +49-2773-742 146
E-mail: info@Ingersoll-IMC.de

Greece

Technotools Monoprosopi I.K.E

25th Martiou & Thrakis 15, 15235 Vrilissia,
Athens, Greece
Tel: +30-2-10-832-0752
E-mail: Giorgos@technotools.gr

Hungary

TaeguTec Hungary KFT.

1142 Budapest, Kassai u.151.
Tel: +36-1-273-29-55
E-mail: info@taegutec.hu

India

TaeguTec India Pvt. Ltd.

No.120, Bommasandra Industrial Area,
Phase IV, Bangalore-560 099, India
Tel: +91-80-4901-3000
E-mail: sales@taegutec-india.com

Indonesia

PT. TaeguTec Indonesia

Easton Commercial Center
Jl. Gunung Panderman Blok B no. 12
Cikarang Selatan-Bekasi 17550, Indonesia
Tel: +62-21-29093176/78
E-mail: sales@taegutec.co.id

Ireland

Hardmetal Machine Tools Ireland Ltd.

Dargan House, Duncairn Terrace,
Bray Co. Wicklow, Ireland
Tel: +353-1-286-2466
E-mail: sales@hardmetal.ie

Italy

Ingersoll TaeguTec Italia S.R.L.

Via Monte grappa N.78, 20020 Arese (MI), Italy
Tel: +39 02.99.76.6700
E-mail: taegutec@taegutec.it

Japan

TaeguTec Japan Ltd.

Senri Asahi Hankyu Bldg. 20F
1-5-3 Shinsenri-Higashimachi
Toyonaka-shi Osaka 560-0082, Japan
Tel: +81-6-6835-7731
E-mail: taegutec@taegutec.co.jp

Lithuania

UAB TTMT

Panerių Str. 5 LT-48337 Kaunas, Lithuania
Tel: +370-37-328487
E-mail: giedre@ttmt.lt

Malaysia

TaeguTec Tooling Systems

Malaysia Sdn. Bhd

No.23-1&2, Jalan Anggerik Vanilla
BF 31/BF Kota Kemuning, Seksyen 31
40460 Shah Alam Selangor D.E., Malaysia
Tel: +603-5131-7514
E-mail: info@taegutec.com.my

The Netherlands

TCE Tools

Kennedylaan 14, 5466 AA, Veghel,
The Netherlands
Tel: +31 (413) 38 83 10
E-mail: info@tce-tools.nl

New Zealand

TaeguTec Pacific Ltd.

1/501 Mt. Wellington Highway
Sylvia Park, Auckland, New Zealand 1060
Tel: +64-0800-808-477
E-mail: sales@iscar.co.nz

Norway

Svea Service AS

Graaterudveien 20 No-3036 Drammen,
Norway
Tel: +47-32-277-750
E-mail: per.martin.bakken@svea.no

Pakistan

Dynamic Tooling Services

Office No. 304, 3rd Floor, Azeem
Mansion, Fazal-ul-Haque Road,
Blue Area, Islamabad-44000, Pakistan
Tel: +92-51-2150382/383
E-mail: info@dts.com.pk

Peru

Trade Tools Cia. S.A.C.

Av. Guillermo Dansey No 774
Urb. Lima Industrial, Lima Peru 4000.
Tel: +51-01-433-6999
E-mail: purchases@tradetoolscia.com.pe

Philippines

Colt Commercial Inc.

No.52B Balete Drive, Brgy Mariana
NCR, 2nd District Quezon City
Philippines 1112
Tel: +63-2-8244-9757
E-mail: cyrus@colt.com.ph

Poland

TaeguTec Polska Sp. z o.o.

Ul.Nenckiego 136
52-223 Wrocław, Poland
Tel: +48 71 785 40 85
E-mail: sales@taegutec.pl

Portugal

Hexatool, S.A.

Rua Casal Galego, N°70A
2430-084 Casal Galego
Marinha Grande, Portugal
Tel: +351-244-550424/5
E-mail: hexatool@hexatool.com

Romania

SC TaeguTec Tools SRL

Splaiul Unirii, nr. 4, Bl. B3, 5th Floor,
Office 5.1, District 4., Bucharest,
Romania, 040031
Tel: +4021 210 3108
E-mail: marian.luca@taegutec.ro

Russia

TaeguTec Russia

123290, Russia, Moscow,
2nd Magistralnaya str, 8A, building 5
Tel: +7-495-221-7617
E-mail: sales@taegutec.ru

Serbia

Intehna Beo D.O.O.

Autoput 22, 11080 Zemun, Serbia
Tel: +381-11-3149-092
E-mail: info@intehna.rs

Singapore

TT Tooling Systems

BK502, #03-823, Jurong West Avenue 1,
Singapore 640502
Tel: +65-6-4254918
E-mail: kltan@sinotool.com.sg

Slovakia

TaeguTec Slovakia, s.r.o.

Bytčická 2/44 010 01 Žilina Slovak
Republic
Tel: +421 41 7000056
E-mail: info@taegutec.sk

Slovenia

Intehna D.O.O.

Špruha 40, Si-1236, Trzin, Slovenia
Tel: +386-1-580-9260
E-mail: info@intehna.si

South Africa

TaeguTec South Africa (Pty) Ltd.

Block F, Clearwater Office Park,
Corner of Atlas and Park Roads,
Parkhaven, Boksburg 1459, South Africa
Tel: +2711-362-1500
E-mail: info@taegutec.co.za

Spain

TaeguTec Spain S.L.U

Miquel Servet, 35 P.I.Bufalvent
08243 Manresa (Barcelona), Spain
Tel: +34-93-878-7309/7310
E-mail: info@taegutec.es

Sweden

SMV Verktyg AB

Parkgatan 6
SE-333 31 Smalandsstenar, Sweden
Tel: +46-371-343-40
E-mail: verktyg@smv.se

Taiwan

Qunling International Trading Co.,Ltd.

RM B, 7F, No. 801 of Zhongzheng Road,
Zhonghe District, New Taipei City 23552,
Taiwan
Tel: +886-2-2223-0851
E-mail: qunling.service@qunling.url.tw

Thailand

TaeguTec(Thailand) Co.,Ltd.

6/177 M.7 Srinakarin Rd.,
T.Bangmuang, A.Muangsamutprakarn,
Samutprakarn 10270, Thailand
Tel: +66-2-759-9300
E-mail: info@taegutecthai.co.th

Turkey

TaeguTec Kesici Takimler A.S.

TOSB Otomotiv Yan Sanayi Ihtisas
Organize Sanayi Bolgesi
1.Cad. 15.Sokak No:9 41420 Şekerpınar
Çayırova/KOCAELI, Türkiye
Tel: +90-850-201-6900
E-mail: info@taegutec.com.tr

Ukraine

TaeguTec Ukraine LLC

40-b, Lesya Ukrainka avenue, Dnipro,
Ukraine, 49006
Tel: +38-056-790-84-09
E-mail: td@taegutec.com.ua

United Arab Emirates

Varycarb Tools Trading LLC

Office BC-53
European Business Centre, DIP-1
Dubai, U.A.E
Tel: +971561610359
E-mail: santosh.gawade@varycarb.com

United Kingdom

TaeguTec UK Ltd.

Waterside, Grange Park, Wetherby,
Leeds, LS22 5NB, United Kingdom
Tel: +44-1937-589-828
E-mail: info@taegutec.co.uk

U.S.A.

Ingersoll Cutting Tools

845 S Lyford Road Rockford,
IL 61108-2749, U.S.A.
Tel: +1-815-387-6600
E-mail: info@ingersoll-imc.com

Vietnam

TaeguTec Vietnam Limited Liability

3rd Floor, Intan Building, 97 Nguyen
Van Troi Street, Ward 12, Phu Nhuan Dist,
HCMC, Vietnam.
Tel: +84-28-3999-1835
E-mail: info@taegutec.vn



ADVANCEe**CUTTING**
TaeguTec



- Cat. no.: 6266751
- English version: CT 02/2024
- ©TaeguTec LTD.