

Catalogue 2023



BAHCO



Catalogue 2023

Catalogue

Contents	2-9
Alphanumerical index	657-737
Warranty	751

11-20 BANDSAWS & POWER SAWS

21-36 FILES



37-60 WRENCHES



61-104 SOCKETS & RATCHETS



105-122 TORQUE TOOLS



123-186 POWER TOOL ACCESSORIES



BAHCO

187-220 SCREWDRIVERS



221-230 L-KEYS



231-264 PLIERS



265-272 PIPE WRENCHES & TUBING TOOLS



273-288 AIR TOOLS



289-294 CORDLESS POWER TOOLS



479-500 TOOLS @ HEIGHT



501-516 INSULATED TOOLS



517-536 NON SPARKING TOOLS



537-542 STAINLESS STEEL TOOLS



543-550 TWEEZERS & ELECTRONICS SPECIALTY TOOLS



551-560 MEASURING & LAYOUT



561-568 WALL TOOLS



569-572 HAND HACKSAWS



573-582 HANDSAWS



583-588 WOOD CHISELS



589-600 SCISSORS & KNIVES



601-604 CLAMPS & VICES

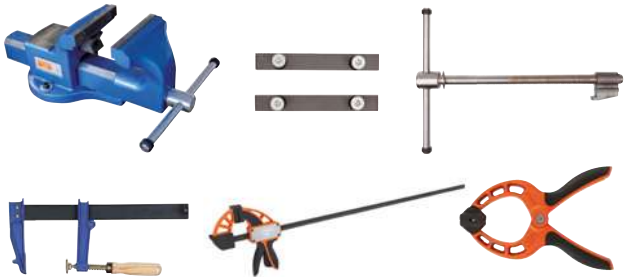

605-612 HAMMERS



613-616 TREE FELLING & FORESTRY TOOLS



617-624 COLD CHISELS & PUNCHES



625-628 PRY BARS



629-632 PLANTING & CULTIVATING TOOLS



633-652 PRUNING TOOLS



653-656 AIR TOOLS OUTDOOR



Contents

Bandsaws & Power Saws	11-20	Screwdrivers	187-220
METAL CUTTING BI-METAL BANDSAWS	12	ERGO™ SCREWDRIVERS WITH RIGGED RUBBER GRIP & COLOUR ID	188
METAL CUTTING CARBIDE BANDSAWS	15	ERGO™ SCREWDRIVERS WITH IMPACT GRIP	198
HSS CIRCULAR SAWBLADES	17	BAHCOFIT SCREWDRIVERS WITH GROOVED RUBBER GRIP	200
WOOD CUTTING	18	SCREWDRIVERS WITH RUBBERED GRIP	207
BANDSAW ACCESSORIES	18	SCREWDRIVERS WITH RATCHETING GRIP	210
POWER HACKSAW BLADES	19	SCREWDRIVERS WITH PRECISION GRIP	212
		SCREWDRIVERS WITH T-HANDLE GRIP	214
		SCREWDRIVERS WITH 1/4" BIT HOLDERS	216
		SCREWDRIVERS WITH WOODEN OR PLASTIC GRIP	216
		ELECTRICAL TESTERS	218
		ACCESSORIES	219
Files	21-36	L-Keys	221-230
ENGINEERING FILES	22	HEXAGONAL TIPPED	222
SHARPENING FILES	26	TORX® TIPPED	226
RASPS	30	DOUBLE OFFSET	229
MILLED TOOTH FILES	31	MULTITOOLS	229
NEEDLE FILES	31		
DIAMOND FILES	34		
ACCESSORIES	35		
Wrenches	37-60	Pliers	231-264
ADJUSTABLE WRENCHES	38	CUTTING PLIERS	232
COMBINATION WRENCHES	40	COMBINATION PLIERS	239
RATCHETING WRENCHES	45	GRIPPING PLIERS	241
OPEN END WRENCHES	48	WATERPUMP PLIERS	247
RING END WRENCHES	52	CIRCLIP PLIERS	249
FLARE NUT WRENCHES	54	WIRE STRIPPERS & DISMANTLING TOOLS	251
SLOGGING WRENCHES	55	CRIMPING PLIERS	254
SOCKET WRENCHES	56	PLIERS SETS	257
MULTIFITTING KEYS	59	LOCKING PLIERS	259
HOOK WRENCHES	60	RIVETING TOOLS	262
		SPECIAL PLIERS	264
Sockets & Ratchets	61-104	Pipe Wrenches & Tubing Tools	265-272
SOCKET SETS	62	PIPE WRENCHES	266
1/4"	79	TUBE CUTTING TOOLS	268
3/8"	86	BENDING & FORMING TOOLS	270
1/2"	92	DEBURRING TOOLS	271
3/4"	100		
1"	102		
EMPTY SOCKET SET CASES	104		
SCAFFOLDING WRENCHES	104		
Torque Tools	105-122	Air Tools	273-288
DIGITAL TORQUE WRENCHES	106	IMPACT WRENCHES	274
MECHANICAL TORQUE WRENCHES	108	RATCHETS	277
TORQUE SCREWDRIVERS	113	GRINDERS, SANDERS & POLISHERS	277
MULTIPLIERS	115	DRILLS & SCREWDRIVERS	282
TORQUE TESTERS	116	CUTTING TOOLS	283
TORQUE ANGLE ADAPTORS	117	HAMMERS, RIVETERS & MARKERS	284
INSERT TOOLS	117	PAINT GUNS	285
		BLOWING & CLEANING TOOLS	286
		AIR TOOLS ACCESSORIES & EQUIPMENT	286
Power Tool Accessories	123-186	Cordless Power Tools	289-294
HOLESAWS	124	IMPACT WRENCHES	290
SABRE SAWBLADES	134	RATCHETS	290
JIGSAW BLADES	138	DRILLS & SCREWDRIVERS	291
MULTI TOOL ACCESSORIES	139	GRINDERS, SANDERS & POLISHERS	292
CIRCULAR SAW BLADES	141	CUTTING TOOLS	292
ABRASIVE CUTTING DISCS	142	GREASERS	293
BANDSAW BLADES	143	BATTERIES & CHARGERS	293
CARBIDE ROTARY BURRS	144		
DRILL BITS	148		
SCREWDRIVER BITS	156		
IMPACT TOOLS	172		



Automotive Tools 295-358

ENGINE TOOLS	296
EXHAUST TOOLS	318
OIL SERVICE TOOLS & EQUIPMENT	319
BRAKE SYSTEM TOOLS & EQUIPMENT	325
TRANSMISSION & WHEEL TOOLS	328
SUSPENSION TOOLS & EQUIPMENT	336
BATTERY MANAGEMENT & ELECTRICAL TOOLS	337
PRESSES & ACCESSORIES	342
GENERAL AUTOMOTIVE TOOLS AND EQUIPMENT	343
BODY SHOP TOOLS	345
LIFTING EQUIPMENT	350

Lighting Equipment 359-360

HAND LIGHTS	360
HEAD LIGHTS	360
CABLE REELS	360

Inspection Tools 361-364

ENDOSCOPES	362
STETHOSCOPIES	362
MIRRORS	362

Extractors & Pullers 365-374

MECHANICAL	366
PRY BARS	372
PICKING TOOLS	373
THREAD TOOLS	373

Tool Storage & Toolkits 375-478

TOOL TROLLEYS	376
FIT&GO FOAM INLAY TOOLSETS	384
APPLICATION TOOLKITS	434
RIGID CASES	457
WORKBENCHES	463
CABINETS & PANELS	467
METALLIC TOOL BOXES	470
TEXTILE & LEATHER EQUIPMENT	472
PLASTIC BOXES & CASES	477
TOOLSETS	478

Tools @ Height 479-500

TOOL STORAGE & LANYARDS	480
WRENCHES	483
PIPE WRENCHES	485
SOCKETS & RATCHETS	485
SCREWDRIVERS	488
PLIERS	491
CUTTING TOOLS	493
HAMMERS, PRY BARS & CHISELS	494
MEASURING & LAYOUT	496
TORQUE TOOLS	497
CLAMPING TOOLS	498
OTHER TOOLS	498
GLOVES	499

Insulated Tools 501-516

SCREWDRIVERS	502
PLIERS	509
WRENCHES	511
INSULATED SOCKETS & RATCHETS	512
SCISSORS & KNIVES	513

TWEEZERS	513
PROTECTIVE EQUIPMENT	513
TOOLSETS	514

Non Sparking Tools 517-536

WRENCHES	518
PIPE WRENCHES & VALVE TOOLS	523
SOCKETS & RATCHETS	524
SCREWDRIVERS	527
PLIERS	528
HAMMERS, PRY BARS & CHISELS	530
SCRAPERS	533
DIGGING TOOLS	535
EXTRACTORS & PULLERS	535
TORQUE TOOLS	536

Stainless Steel Tools 537-542

TROLLEYS	538
WRENCHES	538
SOCKETS & RATCHETS	539
SCREWDRIVERS	540
L-KEYS	540
SCREWDRIVER BITS	541
PLIERS	542
HAMMERS	542
PUNCHES & COLD CHISELS	542

Tweezers & Electronics Specialty Tools 543-550

TWEEZERS	544
SOLDERING TOOLS	547
FINE MECHANICAL	548

Measuring & Layout 551-560

MEASURING TAPES	552
MEASURING WHEELS	553
SPIRIT LEVELS	553
MARKING	556
RULES	557
SQUARES	558
PRECISION MEASURING	559

Wall Tools 561-568

SCRAPERS	562
MASONRY TOOLS	564
DRYWALL TOOLS	566

Hand Hacksaws 569-572

HAND HACKSAW FRAMES	570
HAND HACKSAW BLADES	571

Handsaws 573-582

HANDSAWS FOR CONSTRUCTION MATERIAL	574
HANDSAWS FOR WOOD	575
PRECISION HANDSAWS	579
HANDLES & SHARPENERS	580
FRET SAWS & SAWBLADES	580
COPING SAWS & SAWBLADES	581
MUSICAL SAW	581

Wood Chisels 583-588

WOODWORKING CHISELS	584
GOUGE CHISELS	586
DEMOLITION CHISELS	586
WOOD CHISEL ACCESSORIES	587

Scissors & Knives 589-600

METAL SHEARS	590
SCISSORS	593
KNIVES	594

Clamps & Vices 601-604

CLAMPS	602
BENCH VICES	603
BENCH VICE ACCESSORIES	604

Hammers 605-612

CLAW HAMMERS	606
NAIL PULLERS	607
ENGINEERING HAMMERS	607
CONSTRUCTION HAMMERS	608
SPECIALTY HAMMERS	610
SLEDGE HAMMERS	610
SOFT FACE HAMMERS & MALLETS	611

Tree Felling & Forestry Tools 613-616

AXES, HATCHETS & MAULS	614
WEDGES	616

Cold Chisels & Punches 617-624

COLD CHISELS	618
COLD CHISELS WITH GUARD	619
COLD CHISELS, REGRINDABLE	619
COLD CHISELS ACCESSORIES	620
PUNCHES	620
PUNCHES WITH 2-COMPONENT HANDLE	624
COLD CHISELS WITH 2-COMPONENT HANDLE	624

Pry Bars 625-628

WRECKING BARS	626
---------------	-----

Planting & Cultivating Tools 629-632

SHOVELS	630
SPADES	630
FORKS	630
RAKES	630
SMALL GARDEN TOOLS	630

Pruning Tools 633-652

SECATEURS	634
FRUIT PICKING TOOLS	638
LOPPERS	639
POLE SAWS & TOP PRUNERS	641
HEDGE SHEARS	644
GRASS SHEARS	646
PRUNING KNIVES	646

SCISSORS	647
BOW SAWS	647
PRUNING SAWS	648
SPARE PARTS & ACCESSORIES	650
ACCESSORIES & MAINTENANCE	651

Air Tools Outdoor 653-656

SECATEURS	654
-----------	-----



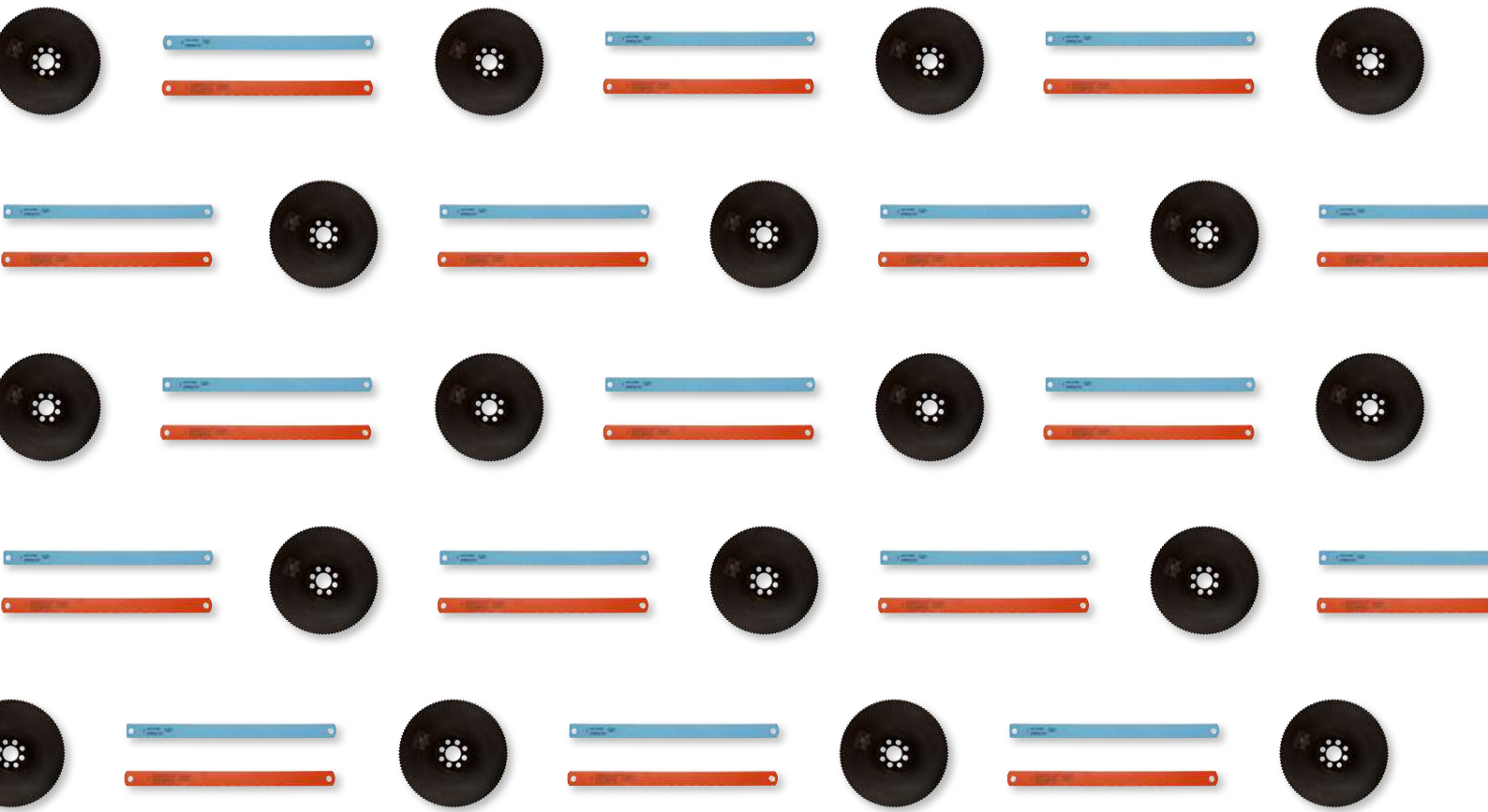

Bandsaws & Power Saws



METAL CUTTING BI-METAL BANDSAWS

Universal Bandsaw Blade for Small Workshops



3857 Easy-Cut

13 mm	EZ	1	3857-13-0.6-EZ-S
13 mm	EZ	1	3857-13-0.6-EZ-M
13 mm	EZ	1	3857-13-0.6-EZ-L
20 mm	EZ	1	3857-20-0.9-EZ-S
20 mm	EZ	1	3857-20-0.9-EZ-M
20 mm	EZ	1	3857-20-0.9-EZ-L
27 mm	EZ	1	3857-27-0.9-EZ-S
27 mm	EZ	1	3857-27-0.9-EZ-M
27 mm	EZ	1	3857-27-0.9-EZ-L
34 mm	EZ	1	3857-34-1.1-EZ-S
34 mm	EZ	1	3857-34-1.1-EZ-M
34 mm	EZ	1	3857-34-1.1-EZ-L

General Purpose Metal Cutting Bi-Metal Bandsaw Blade for Contour and Small Machines



3851 Contour and small machine

6 mm	PRX	1	3851-6-0.6-10/14
6 mm	Hook	1	3851-6-0.6-H-6
6 mm	PRX	1	3851-6-0.9-10/14
6 mm	Hook	1	3851-6-0.9-H-6
10 mm	PRX	1	3851-10-0.6-10/14
10 mm	Hook	1	3851-10-0.6-H-4
10 mm	Hook	1	3851-10-0.6-H-6
10 mm	PRX	1	3851-10-0.9-10/14
10 mm	Hook	1	3851-10-0.9-H-4
10 mm	Hook	1	3851-10-0.9-H-6
10 mm	Regular	1	3851-10-0.9-R-14
13 mm	PRX	1	3851-13-0.5-10/14

13 mm	PRX	1	3851-13-0.5-14/18
13 mm	Regular	1	3851-13-0.5-R-10
13 mm	Regular	1	3851-13-0.5-R-14
13 mm	Regular	1	3851-13-0.5-R-18
13 mm	Regular	1	3851-13-0.5-R-24
13 mm	Hook	1	3851-13-0.5-H-4
13 mm	PRX	1	3851-13-0.6-10/14
13 mm	PRX	1	3851-13-0.6-5/8
13 mm	PRX	1	3851-13-0.6-6/10
13 mm	PRX	1	3851-13-0.6-8/12
13 mm	Hook	1	3851-13-0.6-H-3
13 mm	Hook	1	3851-13-0.6-H-4
13 mm	Hook	1	3851-13-0.6-H-6
13 mm	Regular	1	3851-13-0.6-R-10
13 mm	Regular	1	3851-13-0.6-R-14
13 mm	Regular	1	3851-13-0.6-R-18
13 mm	PRX	1	3851-13-0.9-10/14
13 mm	PRX	1	3851-13-0.9-6/10
13 mm	Hook	1	3851-13-0.9-H-3
13 mm	Hook	1	3851-13-0.9-H-4
13 mm	Hook	1	3851-13-0.9-H-6
13 mm	Regular	1	3851-13-0.9-R-14
13 mm	Regular	1	3851-13-0.9-R-6
20 mm	PRX	1	3851-20-0.9-10/14
20 mm	Hook	1	3851-20-0.9-H-3
20 mm	Hook	1	3851-20-0.9-H-4
20 mm	Regular	1	3851-20-0.9-R-18
20 mm	PRX	1	3851-20-0.9-4/6
20 mm	PRX	1	3851-20-0.9-5/8
20 mm	PRX	1	3851-20-0.9-6/10
20 mm	PRX	1	3851-20-0.9-8/12
27 mm	PS	1	3851-27-0.9-P-3
27 mm	PS	1	3851-27-0.9-P-4
27 mm	Regular	1	3851-27-0.9-R-6
34 mm	PS	1	3851-34-1.1-P-2
34 mm	PS	1	3851-34-1.1-P-3

Foundry Bandsaw Blade

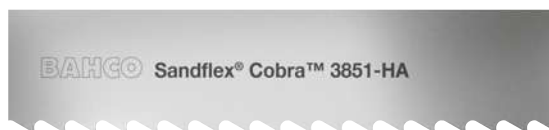

3851 Sandflex® Cobra™ Foundry

10 mm	HA	1	3851-10-0.6-HA-4
13 mm	HA	1	3851-13-0.6-HA-4
13 mm	HA	1	3851-13-0.6-HA-6
13 mm	HA	1	3851-13-0.9-HA-4
20 mm	HA	1	3851-20-0.9-HA-3
20 mm	HA	1	3851-20-0.9-HA-4
27 mm	HA	1	3851-27-0.9-HA-4
27 mm	HA	1	3851-27-0.9-HA-3

Production Metal Cutting Bi-Metal Bandsaw Blade for High Performance



3851 Sandflex® Cobra™



27 mm	PRX	1	3851-27-0.9-2/3
27 mm	PRX	1	3851-27-0.9-3/4
27 mm	PRX	1	3851-27-0.9-4/6
27 mm	PRX	1	3851-27-0.9-5/8
27 mm	PRX	1	3851-27-0.9-6/10
27 mm	PRX	1	3851-27-0.9-8/12
27 mm	PRX	1	3851-27-0.9-10/14
34 mm	PRX	1	3851-34-1.1-2/3
34 mm	PRX	1	3851-34-1.1-3/4
34 mm	PRX	1	3851-34-1.1-4/6
34 mm	PRX	1	3851-34-1.1-5/8
34 mm	PRX	1	3851-34-1.1-6/10
41 mm	PRX	1	3851-41-1.3-1.4/2
41 mm	PRX	1	3851-41-1.3-2/3
41 mm	PRX	1	3851-41-1.3-3/4
41 mm	PRX	1	3851-41-1.3-4/6
41 mm	PRX	1	3851-41-1.3-5/8
54 mm	PRX	1	3851-54-1.3-1.4/2
54 mm	PRX	1	3851-54-1.3-2/3
54 mm	PRX	1	3851-54-1.3-4/6
54 mm	PR	1	3851-54-1.6-P-1.25
54 mm	PRX	1	3851-54-1.6-1/1.4
54 mm	PRX	1	3851-54-1.6-1.4/2
54 mm	PRX	1	3851-54-1.6-2/3
54 mm	PRX	1	3851-54-1.6-3/4
54 mm	PRX	1	3851-54-1.6-4/6
67 mm	PRX	1	3851-67-1.6-7/1
67 mm	PRX	1	3851-67-1.6-1/1.4
67 mm	PRX	1	3851-67-1.6-1.4/2
67 mm	PRX	1	3851-67-1.6-2/3
67 mm	PRX	1	3851-67-1.6-3/4
67 mm	PRX	1	3851-67-1.6-4/6
80 mm	PRX	1	3851-80-1.6-7/1
80 mm	PRX	1	3851-80-1.6-1/1.4
80 mm	PRX	1	3851-80-1.6-1.4/2

34 mm	PHX	1	3854-34-1.1-PHX-2/3
34 mm	PHX	1	3854-34-1.1-PHX-3/4
34 mm	PHX	1	3854-34-1.1-PHX-4/6
41 mm	PHX	1	3854-41-1.3-PHX-1.4/2
41 mm	PHX	1	3854-41-1.3-PHX-2/3
41 mm	PHX	1	3854-41-1.3-PHX-3/4
41 mm	PHX	1	3854-41-1.3-PHX-4/6
54 mm	PHX	1	3854-54-1.3-PHX-1.4/2
54 mm	PHX	1	3854-54-1.3-PHX-2/3
54 mm	PHX	1	3854-54-1.3-PHX-3/4
54 mm	PHX	1	3854-54-1.6-PHX-7/1
54 mm	PHX	1	3854-54-1.6-PHX-1/1.4
54 mm	PHX	1	3854-54-1.6-PHX-1.4/2
54 mm	PHX	1	3854-54-1.6-PHX-2/3
54 mm	PHX	1	3854-54-1.6-PHX-3/4
67 mm	PHX	1	3854-67-1.6-PHX-7/1
67 mm	PHX	1	3854-67-1.6-PHX-1/1.4
67 mm	PHX	1	3854-67-1.6-PHX-1.4/2
67 mm	PHX	1	3854-67-1.6-PHX-2/3
80 mm	PHX	1	3854-80-1.6-PHX-7/1
80 mm	PHX	1	3854-80-1.6-PHX-1/1.4
80 mm	PHX	1	3854-80-1.6-PHX-1.4/2

Production Metal Cutting Bi-Metal Bandsaw Blade for Special and Difficult Alloys



3854-Sandflex® King Cobra™ PQ



27 mm	PQ	1	3854-27-0.9-PQ-3/4
27 mm	PQ	1	3854-27-0.9-PQ-4/6
34 mm	PQ	1	3854-34-1.1-PQ-2/3
34 mm	PQ	1	3854-34-1.1-PQ-3/4
34 mm	PQ	1	3854-34-1.1-PQ-4/6
41 mm	PQ	1	3854-41-1.3-PQ-1.4/2
41 mm	PQ	1	3854-41-1.3-PQ-2/3
41 mm	PQ	1	3854-41-1.3-PQ-3/4
41 mm	PQ	1	3854-41-1.3-PQ-4/6
54 mm	PQ	1	3854-54-1.6-PQ-9/1.2
54 mm	PQ	1	3854-54-1.6-PQ-1.4/2
54 mm	PQ	1	3854-54-1.6-PQ-2/3
54 mm	PQ	1	3854-54-1.6-PQ-3/4
54 mm	PQ	1	3854-54-1.6-PQ-4/6
67 mm	PQ	1	3854-67-1.6-PQ-9/1.2
67 mm	PQ	1	3854-67-1.6-PQ-1.4/2
67 mm	PQ	1	3854-67-1.6-PQ-2/3
80 mm	PQ	1	3854-80-1.6-PQ-9/1.2
80 mm	PQ	1	3854-80-1.6-PQ-1.4/2

Unique Design Bandsaw Blade for Tool Steels and Hard Materials

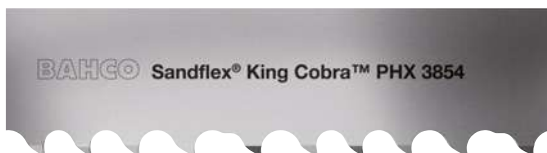

3854-Sandflex® King Cobra™ PHX



27 mm	PHX	1	3854-27-0.9-PHX-2/3
27 mm	PHX	1	3854-27-0.9-PHX-3/4
27 mm	PHX	1	3854-27-0.9-PHX-4/6
34 mm	PHX	1	3854-34-1.1-PHX-1.4/2



Production Metal Cutting Bi-Metal Bandsaw Blade for Special and Difficult Alloys



3858 PQ P9000

41 mm	PQ	1	3858-41-1.3-PQ-1.4/2	
41 mm	PQ	1	3858-41-1.3-PQ-2/3	
41 mm	PQ	1	3858-41-1.3-PQ-3/4	
54 mm	PQ	1	3858-54-1.6-PQ-9/1.2	
54 mm	PQ	1	3858-54-1.6-PQ-1.4/2	
54 mm	PQ	1	3858-54-1.6-PQ-2/3	
67 mm	PQ	1	3858-67-1.6-PQ-9/1.2	
67 mm	PQ	1	3858-67-1.6-PQ-1.4/2	
80 mm	PQ	1	3858-80-1.6-PQ-9/1.2	

Unique Design Bandsaw Blade for Tool Steels and Hard Materials for Better Blade Life



3858 PHX P9000

34 mm	PHX	1	3858-34-1.1-PHX-1.4/2	
34 mm	PHX	1	3858-34-1.1-PHX-2/3	
34 mm	PHX	1	3858-34-1.1-PHX-3/4	
41 mm	PHX	1	3858-41-1.3-PHX-1.4/2	
41 mm	PHX	1	3858-41-1.3-PHX-2/3	
41 mm	PHX	1	3858-41-1.3-PHX-3/4	
54 mm	PHX	1	3858-54-1.3-PHX-1.4/2	
54 mm	PHX	1	3858-54-1.3-PHX-2/3	
54 mm	PHX	1	3858-54-1.3-PHX-3/4	
54 mm	PHX	1	3858-54-1.6-PHX-7/1	
54 mm	PHX	1	3858-54-1.6-PHX-1/1.4	
54 mm	PHX	1	3858-54-1.6-PHX-1.4/2	
54 mm	PHX	1	3858-54-1.6-PHX-2/3	
54 mm	PHX	1	3858-54-1.6-PHX-3/4	
67 mm	PHX	1	3858-67-1.6-PHX-7/1	
67 mm	PHX	1	3858-67-1.6-PHX-1/1.4	
67 mm	PHX	1	3858-67-1.6-PHX-1.4/2	
67 mm	PHX	1	3858-67-1.6-PHX-2/3	
80 mm	PHX	1	3858-80-1.6-PHX-7/1	
80 mm	PHX	1	3858-80-1.6-PHX-1/1.4	
80 mm	PHX	1	3858-80-1.6-PHX-1.4/2	

Sandflex® Top Fabricator Bandsaw Blades



3853 Sandflex® Top Fabricator

20 mm	PF	1	3853-20-0.9-5/7-VS	
20 mm	PF	1	3853-20-0.9-8/11-VS	
27 mm	PF	1	3853-27-0.9-3/4	
27 mm	PF	1	3853-27-0.9-4/6	
27 mm	PF	1	3853-27-0.9-5/8	
27 mm	PF	1	3853-27-0.9-5/7-VS	
27 mm	PF	1	3853-27-0.9-8/11-VS	
34 mm	PF	1	3853-34-1.1-2/3	
34 mm	PF	1	3853-34-1.1-3/4	
34 mm	PF	1	3853-34-1.1-4/6	
34 mm	PF	1	3853-34-1.1-5/8	
34 mm	PF	1	3853-34-1.1-5/7-VS	
34 mm	PF	1	3853-34-1.1-8/11-VS	
41 mm	PF	1	3853-41-1.3-2/3	
41 mm	PF-W	1	3853-41-1.3-2/3-W	
41 mm	PF	1	3853-41-1.3-3/4	
41 mm	PF-W	1	3853-41-1.3-3/4-W	
41 mm	PF	1	3853-41-1.3-4/6	
41 mm	PF	1	3853-41-1.3-5/8	
41 mm	PF	1	3853-41-1.3-5/7-VS	
54 mm	PF	1	3853-54-1.3-3/4	
54 mm	PF	1	3853-54-1.3-3/4-W	
54 mm	PF	1	3853-54-1.3-5/8	
54 mm	PF	1	3853-54-1.6-2/3	
54 mm	PF-W	1	3853-54-1.6-2/3-W	
54 mm	PF	1	3853-54-1.6-3/4	
54 mm	PF-W	1	3853-54-1.6-3/4-W	
54 mm	PF	1	3853-54-1.6-4/6	
67 mm	PF	1	3853-67-1.6-2/3	
67 mm	PF-W	1	3853-67-1.6-2/3-W	
67 mm	PF	1	3853-67-1.6-3/4	
67 mm	PF-W	1	3853-67-1.6-3/4-W	
67 mm	PF-W	1	3853-67-1.6-5/8-W	

Sandflex® Top Fabricator Coated Bandsaw Blades



3853 Sandflex® Top Fabricator Coated

41 mm	PF	1	3853-41-1.3-2/3-WS	
41 mm	PF	1	3853-41-1.3-3/4-WS	
54 mm	PF	1	3853-54-1.6-2/3-WS	
54 mm	PF	1	3853-54-1.6-3/4-WS	
67 mm	PF	1	3853-67-1.6-2/3-WS	
67 mm	PF	1	3853-67-1.6-3/4-WS	

METAL CUTTING CARBIDE BANDSAWS

Extreme Easy-Cut Carbide Bandsaw Blades



3859 Carbide EasyCut EZX

27 mm	EZX	1	3859-27-0.9-EZX-3/4
27 mm	EZX	1	3859-27-0.9-EZX-4/6
34 mm	EZX	1	3859-34-1.1-EZX-2/3
34 mm	EZX	1	3859-34-1.1-EZX-3/4
34 mm	EZX	1	3859-34-1.1-EZX-4/6
41 mm	EZX	1	3859-41-1.3-EZX-1.4/2
41 mm	EZX	1	3859-41-1.3-EZX-2/3
41 mm	EZX	1	3859-41-1.3-EZX-3/4
41 mm	EZX	1	3859-41-1.3-EZX-4/6
54 mm	EZX	1	3859-54-1.6-EZX-1.4/2
54 mm	EZX	1	3859-54-1.6-EZX-1/1.25
54 mm	EZX	1	3859-54-1.6-EZX-2/3
54 mm	EZX	1	3859-54-1.6-EZX-3/4
54 mm	EZX	1	3859-54-1.6-EZX-4/6
67 mm	EZX	1	3859-67-1.6-EZX-.7/1
67 mm	EZX	1	3859-67-1.6-EZX-1.4/2
67 mm	EZX	1	3859-67-1.6-EZX-1/1.25
67 mm	EZX	1	3859-67-1.6-EZX-2/3
80 mm	EZX	1	3859-80-1.6-EZX-.7/1
80 mm	EZX	1	3859-80-1.6-EZX-1.4/2
80 mm	EZX	1	3859-80-1.6-EZX-1/1.25

Foundry Bandsaw Blade

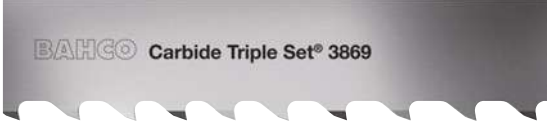

3869 Carbide Triple Set®

13 mm	TS	1	3869-13-0.9-TS-3
20 mm	TS	1	3869-20-0.9-TS-3
20 mm	TS	1	3869-20-0.9-TS-4
27 mm	TS	1	3869-27-0.9-TS-3
27 mm	TS	1	3869-27-0.9-TS-4
34 mm	TS	1	3869-34-1.1-TS-2
34 mm	TS	1	3869-34-1.1-TS-3

Versatile Carbide Bandsaw Blade



3868 Carbide Triple Set® TSX

27 mm	TSX	1	3868-27-0.9-TSX-3/4
34 mm	TSX	1	3868-34-1.1-TSX-2
34 mm	TSX	1	3868-34-1.1-TSX-2/3
34 mm	TSX	1	3868-34-1.1-TSX-3/4
41 mm	TSX	1	3868-41-1.3-TSX-1.4/2
41 mm	TSX	1	3868-41-1.3-TSX-1.6
41 mm	TSX	1	3868-41-1.3-TSX-2
41 mm	TSX	1	3868-41-1.3-TSX-2/3
41 mm	TSX	1	3868-41-1.3-TSX-3/4
54 mm	TSX	1	3868-54-1.3-TSX-1.4/2
54 mm	TSX	1	3868-54-1.3-TSX-2/3
54 mm	TSX	1	3868-54-1.6-TSX-1/1.25
54 mm	TSX	1	3868-54-1.6-TSX-1.4/2
54 mm	TSX	1	3868-54-1.6-TSX-1.6
54 mm	TSX	1	3868-54-1.6-TSX-2/3
54 mm	TSX	1	3868-54-1.6-TSX-3/4
67 mm	TSX	1	3868-67-1.6-TSX-.7/1
67 mm	TSX	1	3868-67-1.6-TSX-1/1.25
67 mm	TSX	1	3868-67-1.6-TSX-1.4/2
67 mm	TSX	1	3868-67-1.6-TSX-2/3
80 mm	TSX	1	3868-80-1.1-TSX-3/4
80 mm	TSX	1	3868-80-1.6-TSX-.7/1
80 mm	TSX	1	3868-80-1.6-TSX-1/1.25
80 mm	TSX	1	3868-80-1.6-TSX-1.4/2
80 mm	TSX	1	3868-80-1.6-TSX-2/3

Versatile Honed Carbide Bandsaw Blade

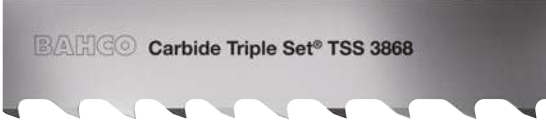

3868 Carbide Triple Set® TSS

27 mm	TSS	1	3868-27-0.9-TSS-3/4
34 mm	TSS	1	3868-34-1.1-TSS-2/3
41 mm	TSS	1	3868-41-1.3-TSS-1.4/2
41 mm	TSS	1	3868-41-1.3-TSS-2/3
54 mm	TSS	1	3868-54-1.6-TSS-1/1.25
54 mm	TSS	1	3868-54-1.6-TSS-1.4/2
54 mm	TSS	1	3868-54-1.6-TSS-2/3
67 mm	TSS	1	3868-67-1.6-TSS-.7/1
67 mm	TSS	1	3868-67-1.6-TSS-1/1.25
67 mm	TSS	1	3868-67-1.6-TSS-1.4/2
67 mm	TSS	1	3868-67-1.6-TSS-2/3
67 mm	TSS	1	3868-67-1.6-TSS-3/4
80 mm	TSS	1	3868-80-1.6-TSS-.7/1
80 mm	TSS	1	3868-80-1.6-TSS-1.4/2
80 mm	TSS	1	3868-80-1.6-TSS-2/3



Advanced Carbide Bandsaw Blade



3881 Carbide Multi Set THQ

Width	Grade	Quantity	Part Number
34 mm	THQ	1	3881-34-1.1-THQ-2/3
41 mm	THQ	1	3881-41-1.3-THQ-1.4/2
41 mm	THQ	1	3881-41-1.3-THQ-2/3
54 mm	THQ	1	3881-54-1.6-THQ-1.4/2
54 mm	THQ	1	3881-54-1.6-THQ-1/1.25
54 mm	THQ	1	3881-54-1.6-THQ-2/3
67 mm	THQ	1	3881-67-1.6-THQ-1/1.25
67 mm	THQ	1	3881-67-1.6-THQ-1.4/2
67 mm	THQ	1	3881-67-1.6-THQ-2/3
80 mm	THQ	1	3881-80-1.6-THQ-7/1
80 mm	THQ	1	3881-80-1.6-THQ-1/1.25
80 mm	THQ	1	3881-80-1.6-THQ-1.4/2
80 mm	THQ	1	3881-80-1.6-THQ-2/3

Advanced Honed Carbide Bandsaw Blade



3881 Carbide Multi Set THS

Width	Grade	Quantity	Part Number
41 mm	THS	1	3881-41-1.3-THS-1.4/2
54 mm	THS	1	3881-54-1.6-THS-1/1.25
54 mm	THS	1	3881-54-1.6-THS-1.4/2
67 mm	THS	1	3881-67-1.6-THS-1/1.25
67 mm	THS	1	3881-67-1.6-THS-1.4/2
67 mm	THS	1	3881-67-1.6-THS-2/3
80 mm	THS	1	3881-80-1.6-THS-7/1
80 mm	THS	1	3881-80-1.6-THS-1.4/2
80 mm	THS	1	3881-80-1.6-THS-2/3
100 mm	THS	1	3881-100-1.6-THS-7/1

Most Advanced Carbide Bandsaw Blade



3860 Unset Carbide TMC

Width	Grade	Quantity	Part Number
41 mm	TMC	1	3860-41-1.3-TMC-1.4/2
41 mm	TMC	1	3860-41-1.3-TMC-2/3
54 mm	TMC	1	3860-54-1.3-TMC-1.4/2

Width	Grade	Quantity	Part Number
54 mm	TMC	1	3860-54-1.3-TMC-2/3
54 mm	TMC	1	3860-54-1.6-TMC-7/1
54 mm	TMC	1	3860-54-1.6-TMC-1/1.25
54 mm	TMC	1	3860-54-1.6-TMC-1.4/2
54 mm	TMC	1	3860-54-1.6-TMC-2/3
67 mm	TMC	1	3860-67-1.6-TMC-1/1.25
67 mm	TMC	1	3860-67-1.6-TMC-1.4/2
67 mm	TMC	1	3860-67-1.6-TMC-2/3
80 mm	TMC	1	3860-80-1.1-TMC-1.4/2
80 mm	TMC	1	3860-80-1.6-TMC-7/1
80 mm	TMC	1	3860-80-1.6-TMC-1/1.25
80 mm	TMC	1	3860-80-1.6-TMC-1.4/2
80 mm	TMC	1	3860-80-1.6-TMC-2/3
100 mm	TMC	1	3860-100-1.1-TMC-1.4/2

Versatile Carbide Bandsaw Blade



3860 Unset Carbide TCD

Width	Grade	Quantity	Part Number
27 mm	TCD	1	3860-27-0.9-TCD-3
27 mm	TCD	1	3860-27-0.9-TCD-3/4
34 mm	TCD	1	3860-34-1.1-TCD-2/3
34 mm	TCD	1	3860-34-1.1-TCD-3/4
34 mm	TCD	1	3860-34-1.1-TCD-3/4-W
41 mm	TCD	1	3860-41-1.3-TCD-1.4/2
41 mm	TCD	1	3860-41-1.3-TCD-1.9/2.1
41 mm	TCD	1	3860-41-1.3-TCD-2/3
41 mm	TCD	1	3860-41-1.3-TCD-3/4
54 mm	TCD	1	3860-54-1.6-TCD-1.4/2
54 mm	TCD	1	3860-54-1.6-TCD-1.9/2.1
54 mm	TCD	1	3860-54-1.6-TCD-2/3
54 mm	TCD	1	3860-54-1.6-TCD-3/4
67 mm	TCD	1	3860-67-1.6-TCD-1.4/2
67 mm	TCD	1	3860-67-1.6-TCD-1/1.25
80 mm	TCD	1	3860-80-1.6-TCD-5/0.8

Bandsaw Blade for Induction Hardened Bars



3860 Unset Carbide TCZ

Width	Grade	Quantity	Part Number
27 mm	TCZ	1	3860-27-0.9-TCZ-3/4
34 mm	TCZ	1	3860-34-1.1-TCZ-2/3
34 mm	TCZ	1	3860-34-1.1-TCZ-3/4
41 mm	TCZ	1	3860-41-1.3-TCZ-2/3
41 mm	TCZ	1	3860-41-1.3-TCZ-3/4

Coated TMC Multi Chip Unset Carbide Bandsaw Blades



3860 Unset Carbide TMC Coated



54 mm	TMC	1	3860-54-1.6-TMC-1/1.25S
54 mm	TMC	1	3860-54-1.6-TMC-1.4/2S
54 mm	TMC	1	3860-54-1.6-TMC-2/3S
67 mm	TMC	1	3860-67-1.6-TMC-1/1.25S
67 mm	TMC	1	3860-67-1.6-TMC-1.4/2S

HSS CIRCULAR SAWBLADES

HSS Circular Saw Blades with 32-1 Bore



3815-32-1

200 mm	BW3	1	3815-200-2.0-32-1-03BW
200 mm	BW4	1	3815-200-2.0-32-1-04BW
225 mm	BW3	1	3815-225-2.0-32-1-03BW
225 mm	BW4	1	3815-225-2.0-32-1-04BW
225 mm	BW5	1	3815-225-2.0-32-1-05BW
225 mm	C6	1	3815-225-2.0-32-1-06C
250 mm	BW3	1	3815-250-2.0-32-1-03BW
250 mm	BW4	1	3815-250-2.0-32-1-04BW
250 mm	BW5	1	3815-250-2.0-32-1-05BW
250 mm	C6	1	3815-250-2.0-32-1-06C
275 mm	BW4	1	3815-275-2.5-32-1-04BW
275 mm	BW5	1	3815-275-2.5-32-1-05BW
275 mm	C6	1	3815-275-2.5-32-1-06C
275 mm	C8	1	3815-275-2.5-32-1-08C
300 mm	BW4	1	3815-300-2.5-32-1-04BW
300 mm	BW5	1	3815-300-2.5-32-1-05BW
300 mm	C5	1	3815-300-2.5-32-1-05C
300 mm	C6	1	3815-300-2.5-32-1-06C
300 mm	C8	1	3815-300-2.5-32-1-08C
315 mm	BW4	1	3815-315-2.5-32-1-04BW
315 mm	BW5	1	3815-315-2.5-32-1-05BW
315 mm	C6	1	3815-315-2.5-32-1-06C

315 mm	C8	1	3815-315-2.5-32-1-08C
350 mm	BW4	1	3815-350-2.5-32-1-04BW
350 mm	C6	1	3815-350-2.5-32-1-06C

HSS Circular Saw Blades with 40-2 Bore



3815-40-2

250 mm	BW3	1	3815-250-2.0-40-2-03BW
250 mm	BW4	1	3815-250-2.0-40-2-04BW
250 mm	BW5	1	3815-250-2.0-40-2-05BW
275 mm	BW3	1	3815-275-2.5-40-2-03BW
275 mm	BW4	1	3815-275-2.5-40-2-04BW
275 mm	BW5	1	3815-275-2.5-40-2-05BW
275 mm	C6	1	3815-275-2.5-40-2-06C
275 mm	C8	1	3815-275-2.5-40-2-08C
315 mm	BW4	1	3815-315-2.5-40-2-04BW
315 mm	BW5	1	3815-315-2.5-40-2-05BW
315 mm	C6	1	3815-315-3.0-40-2-06C

HSS Circular Saw Blades with 50-4 Bore



3815-50-4

370 mm	C8	1	3815-370-3.0-50-4-08C
370 mm	C10	1	3815-370-3.0-50-4-10C
400 mm	C10	1	3815-400-3.5-50-4-10C



WOOD CUTTING

Bi-metal Bandsaw Blade for Longer Life



3861 Sandcut Bi-metal

Teeth per inch	Hook	Quantity	Part Number
4	Hook	1	3861-20-0.6-H-4
1.33	Hook	1	3861-27-0.9-H-1.33
1.15	Hook	1	3861-34-0.9-H-1.15
1.15	Hook	1	3861-34-1.1-H-1.15
1.15	Hook	1	3861-41-1.1-H-1.15
1.15	Hook	1	3861-54-1.1-H-1.15

Standard Bandsaw Blade

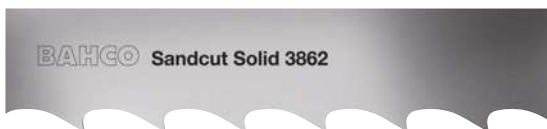

3862 Sandcut Solid

Teeth per inch	Hook	Quantity	Part Number
1.15	Hook	1	3862-33-0.9-H-1.15
1.15	Hook	1	3862-33-1.1-H-1.15
1.15	Hook	1	3862-40-1.1-H-1.15

BANDSAW ACCESSORIES

Chip Brushes for Cleaning Bandsaw Blade

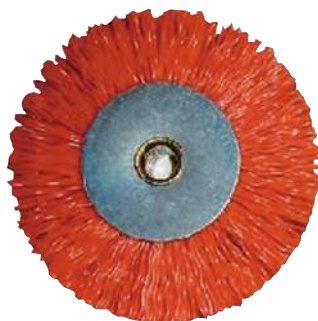

3870-BRUSH

Quantity	Part Number
4	3870-BRUSH-60-6
4	3870-BRUSH-80-6
4	3870-BRUSH-80-8
4	3870-BRUSH-80-10
4	3870-BRUSH-100-10



100 mm
100 mm
100 mm

4 3870-BRUSH-100-12
4 3870-BRUSH-100-10-HEX
1 3870-BRUSH-100-13

Tachometers for Bandsaw



3870-TACHO

Quantity	Part Number
1	3870-TACHO METER

Tension Meters for Bandsaw



3870-TENSION

Quantity	Part Number
1	3870-TENSION METER

Refractometers for Bandsaw



3870-REFR

Quantity	Part Number
1	3870-REFRACTOMETER

Steel Wedges 75 mm



3870-WEDGE



60 g



1 3870-WEDGE-3

Bandsaw Tension Adjusting Wheel



3870-Wheel



0.7790 kg



1 3870-WHEEL

POWER HACKSAW BLADES

Sandflex® Bi-Metal Power Hacksaw Blades



3809



10



300 mm



10 3809-300-25-1.25-10

14

300 mm

10 3809-300-25-1.25-14

6

300 mm

10 3809-300-32-1.60-6

10

300 mm

10 3809-300-32-1.60-10

6

350 mm

10 3809-350-25-1.25-6

10

350 mm

10 3809-350-25-1.25-10

14

350 mm

10 3809-350-25-1.25-14

4

350 mm

10 3809-350-32-1.60-4





6	350 mm	10	3809-350-32-1.60-6
8	350 mm	10	3809-350-32-1.60-8
10	350 mm	10	3809-350-32-1.60-10
14	350 mm	10	3809-350-32-1.60-14
4	350 mm	10	3809-350-32-2.00-4
6	350 mm	10	3809-350-32-2.00-6
10	350 mm	10	3809-350-32-2.00-10
6	350 mm	10	3809-350-38-2.00-6
10	350 mm	10	3809-350-38-2.00-10
10	400 mm	10	3809-400-25-1.25-10
4	400 mm	10	3809-400-32-1.60-4
6	400 mm	10	3809-400-32-1.60-6
8	400 mm	10	3809-400-32-1.60-8
10	400 mm	10	3809-400-32-1.60-10
14	400 mm	10	3809-400-32-1.60-14
4	400 mm	10	3809-400-32-2.00-4
6	400 mm	10	3809-400-32-2.00-6
8	400 mm	10	3809-400-32-2.00-8
10	400 mm	10	3809-400-32-2.00-10
4	400 mm	10	3809-400-38-2.00-4
6	400 mm	10	3809-400-38-2.00-6
10	400 mm	10	3809-400-38-2.00-10
6	425 mm	10	3809-425-32-1.60-6
10	425 mm	10	3809-425-32-1.60-10
4	450 mm	10	3809-450-32-1.60-4
6	450 mm	10	3809-450-32-1.60-6
10	450 mm	10	3809-450-32-1.60-10
14	450 mm	10	3809-450-32-1.60-14
4	450 mm	10	3809-450-32-2.00-4
6	450 mm	10	3809-450-32-2.00-6
10	450 mm	10	3809-450-32-2.00-10
4	450 mm	10	3809-450-38-2.00-4
6	450 mm	10	3809-450-38-2.00-6
8	450 mm	10	3809-450-38-2.00-8
10	450 mm	10	3809-450-38-2.00-10
4	450 mm	10	3809-450-45-2.25-4
6	450 mm	10	3809-450-45-2.25-6
6	475 mm	10	3809-475-45-2.25-6
4	500 mm	10	3809-500-38-2.00-4
6	500 mm	10	3809-500-38-2.00-6
10	500 mm	10	3809-500-38-2.00-10
4	500 mm	10	3809-500-45-2.25-4
6	500 mm	10	3809-500-45-2.25-6
4	500 mm	10	3809-500-50-2.50-4
6	500 mm	10	3809-500-50-2.50-6
8	500 mm	10	3809-500-50-2.50-8
6	525 mm	10	3809-525-38-2.00-6
10	525 mm	10	3809-525-38-2.00-10
4	525 mm	10	3809-525-45-2.25-4
6	525 mm	10	3809-525-45-2.25-6
4	550 mm	10	3809-550-45-2.25-4
6	550 mm	10	3809-550-45-2.25-6
4	550 mm	10	3809-550-50-2.50-4
6	550 mm	10	3809-550-50-2.50-6
4	575 mm	10	3809-575-45-2.25-4
3	575 mm	10	3809-575-50-2.50-3
4	575 mm	10	3809-575-50-2.50-4
6	575 mm	10	3809-575-50-2.50-6
6	600 mm	10	3809-600-38-2.00-6
4	600 mm	10	3809-600-45-2.25-4
6	600 mm	10	3809-600-45-2.25-6
3	600 mm	10	3809-600-50-2.50-3
4	600 mm	10	3809-600-50-2.50-4
6	600 mm	10	3809-600-50-2.50-6
4	650 mm	5	3809-650-50-2.50-4
6	650 mm	5	3809-650-50-2.50-6
4	700 mm	5	3809-700-50-2.50-4
6	700 mm	5	3809-700-50-2.50-6
4	750 mm	5	3809-750-50-2.50-4
6	750 mm	5	3809-750-50-2.50-6







Sandflex® Bi-metal Power Hacksaw Blades for KASTO machines



3809 KA



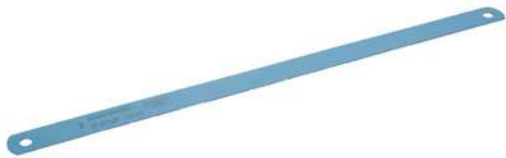

			
6	400 mm	10	3809-400-32-2.00-6-KA
4	450 mm	10	3809-450-38-2.00-4-KA
6	450 mm	10	3809-450-38-2.00-6-KA
10	450 mm	10	3809-450-38-2.00-10-KA
6	500 mm	10	3809-500-45-2.25-6-KA
4	500 mm	10	3809-500-50-2.50-4-KA
6	500 mm	10	3809-500-50-2.50-6-KA
4	550 mm	10	3809-550-50-2.50-4-KA
6	550 mm	10	3809-550-50-2.50-6-KA
3	575 mm	10	3809-575-50-2.50-3-KA
4	575 mm	10	3809-575-50-2.50-4-KA
6	575 mm	10	3809-575-50-2.50-6-KA
10	575 mm	10	3809-575-50-2.50-10-KA
4	600 mm	10	3809-600-50-2.50-4-KA
6	600 mm	10	3809-600-50-2.50-6-KA
3	650 mm	5	3809-650-50-2.50-3-KA
4	650 mm	5	3809-650-50-2.50-4-KA
6	650 mm	5	3809-650-50-2.50-6-KA
3	700 mm	5	3809-700-50-2.50-3-KA
4	700 mm	5	3809-700-50-2.50-4-KA
6	700 mm	5	3809-700-50-2.50-6-KA

			
10	425 mm	10	3802-425-32-1.60-10
4	450 mm	10	3802-450-32-1.60-4
6	450 mm	10	3802-450-32-1.60-6
10	450 mm	10	3802-450-32-1.60-10
14	450 mm	10	3802-450-32-1.60-14
4	450 mm	10	3802-450-38-2.00-4
6	450 mm	10	3802-450-38-2.00-6
8	450 mm	10	3802-450-38-2.00-8
10	450 mm	10	3802-450-38-2.00-10
8	475 mm	10	3802-475-38-2.00-8
4	500 mm	10	3802-500-38-2.00-4
6	500 mm	10	3802-500-38-2.00-6
8	500 mm	10	3802-500-38-2.00-8
10	500 mm	10	3802-500-38-2.00-10
10	500 mm	10	3802-500-45-2.25-10
4	500 mm	10	3802-500-50-2.50-4
6	500 mm	10	3802-500-50-2.50-6
6	525 mm	10	3802-525-38-2.00-6
8	525 mm	10	3802-525-38-2.00-8
10	525 mm	10	3802-525-38-2.00-10
6	550 mm	10	3802-550-38-2.00-6
4	550 mm	10	3802-550-50-2.50-4
6	550 mm	10	3802-550-50-2.50-6
8	550 mm	5	3802-550-50-2.50-8
10	550 mm	10	3802-550-50-2.50-10
4	575 mm	10	3802-575-50-2.50-4
6	575 mm	10	3802-575-50-2.50-6
4	600 mm	10	3802-600-50-2.50-4
6	600 mm	10	3802-600-50-2.50-6
8	600 mm	10	3802-600-50-2.50-8
4	650 mm	5	3802-650-50-2.50-4
6	650 mm	5	3802-650-50-2.50-6
3	700 mm	5	3802-700-50-2.50-3
4	700 mm	5	3802-700-50-2.50-4
6	700 mm	5	3802-700-50-2.50-6
4	750 mm	5	3802-750-50-2.50-4
6	750 mm	5	3802-750-50-2.50-6

HSS Power Hacksaw Blades







3802

			
6	300 mm	10	3802-300-25-1.25-6
10	300 mm	10	3802-300-25-1.25-10
14	300 mm	10	3802-300-25-1.25-14
6	300 mm	10	3802-300-32-1.60-6
10	300 mm	10	3802-300-32-1.60-10
6	350 mm	10	3802-350-25-1.25-6
10	350 mm	10	3802-350-25-1.25-10
14	350 mm	10	3802-350-25-1.25-14
4	350 mm	10	3802-350-32-1.60-4
6	350 mm	10	3802-350-32-1.60-6
8	350 mm	10	3802-350-32-1.60-8
10	350 mm	10	3802-350-32-1.60-10
14	350 mm	10	3802-350-32-1.60-14
6	400 mm	10	3802-400-25-1.25-6
10	400 mm	10	3802-400-25-1.25-10
14	400 mm	10	3802-400-25-1.25-14
4	400 mm	10	3802-400-32-1.60-4
6	400 mm	10	3802-400-32-1.60-6
8	400 mm	10	3802-400-32-1.60-8
10	400 mm	10	3802-400-32-1.60-10
14	400 mm	10	3802-400-32-1.60-14
4	400 mm	10	3802-400-38-2.00-4
6	400 mm	10	3802-400-38-2.00-6
10	400 mm	10	3802-400-38-2.00-10
6	425 mm	10	3802-425-32-1.60-6

HSS Power Hacksaw Blades for KASTO machines



3802 KA

			
4	450 mm	10	3802-450-38-2.00-4-KA
6	450 mm	10	3802-450-38-2.00-6-KA
8	450 mm	10	3802-450-38-2.00-8-KA
10	450 mm	10	3802-450-38-2.00-10-KA
4	500 mm	10	3802-500-50-2.50-4-KA
6	500 mm	10	3802-500-50-2.50-6-KA
4	550 mm	10	3802-550-50-2.50-4-KA
8	550 mm	10	3802-550-50-2.50-8-KA
3	575 mm	10	3802-575-50-2.50-3-KA
4	575 mm	10	3802-575-50-2.50-4-KA
6	575 mm	10	3802-575-50-2.50-6-KA
4	650 mm	5	3802-650-50-2.50-4-KA
6	650 mm	5	3802-650-50-2.50-6-KA
2	700 mm	5	3802-700-50-2.50-2-KA
4	700 mm	5	3802-700-50-2.50-4-KA
6	700 mm	5	3802-700-50-2.50-6-KA



Files



ENGINEERING FILES

Engineering Flat Hand Files Bastard/
Second/Smooth Cut Unhandled



1-100...-0

100 mm	1		10	1-100-04-1-0
100 mm	2		10	1-100-04-2-0
100 mm	3		10	1-100-04-3-0
150 mm	1		10	1-100-06-1-0
150 mm	2		10	1-100-06-2-0
150 mm	3		10	1-100-06-3-0
200 mm	1		10	1-100-08-1-0
200 mm	2		10	1-100-08-2-0
200 mm	3		10	1-100-08-3-0
250 mm	1		10	1-100-10-1-0
250 mm	2		10	1-100-10-2-0
250 mm	3		10	1-100-10-3-0
300 mm	1		5	1-100-12-1-0
300 mm	2		5	1-100-12-2-0
300 mm	3		5	1-100-12-3-0
350 mm	1		5	1-100-14-1-0
350 mm	2		5	1-100-14-2-0

Type of cut: 1 = Bastard, 2 = Second, 3 = Smooth

ERGO™ Engineering Flat Hand Files
Bastard/Second/Smooth Cut



ergo



1-100...-2

100 mm	1		5	1-100-04-1-2
100 mm	2		5	1-100-04-2-2
150 mm	1		5	1-100-06-1-2
150 mm	2		5	1-100-06-2-2
150 mm	3		5	1-100-06-3-2
200 mm	1		5	1-100-08-1-2
200 mm	2		5	1-100-08-2-2
200 mm	3		5	1-100-08-3-2
250 mm	1		5	1-100-10-1-2
250 mm	2		5	1-100-10-2-2
250 mm	3		5	1-100-10-3-2
300 mm	1		5	1-100-12-1-2
300 mm	2		5	1-100-12-2-2
300 mm	3		5	1-100-12-3-2

Type of cut: 1 = Bastard, 2 = Second, 3 = Smooth

Engineering Pillar Files Bastard/Second/
Smooth Cut Unhandled



1-102

150 mm	2		10	1-102-06-2-0
150 mm	3		10	1-102-06-3-0
200 mm	1		10	1-102-08-1-0
200 mm	2		10	1-102-08-2-0
200 mm	3		10	1-102-08-3-0

Type of cut: 1 = Bastard, 2 = Second, 3 = Smooth

Engineering Lathe Files Second/Smooth
Cut Unhandled



1-104

250 mm	2		10	1-104-10-2-0
250 mm	3		10	1-104-10-3-0
300 mm	2		5	1-104-12-2-0
300 mm	3		5	1-104-12-3-0
350 mm	3		5	1-104-14-3-0

Type of cut: 1 = Bastard, 2 = Second, 3 = Smooth

Engineering Oberg Cut Flat Hand Files
Bastard Cut Unhandled



1-106...-0

200 mm	1		10	1-106-08-1-0
250 mm	1		10	1-106-10-1-0
300 mm	1		5	1-106-12-1-0

Type of cut: 1 = Bastard, 2 = Second, 3 = Smooth

ERGO™ Engineering Oberg Cut Flat Hand
Files Bastard Cut



ergo



1-106...-2

200 mm	1		5	1-106-08-1-2
250 mm	1		5	1-106-10-1-2
300 mm	1		5	1-106-12-1-2

Type of cut: 1 = Bastard, 2 = Second, 3 = Smooth

Engineering Flat Files with Tapered Edge
Bastard/Second/Smooth Cut Unhandled



1-110...-0

100 mm	1		10	1-110-04-1-0
100 mm	2		10	1-110-04-2-0
100 mm	2		10	1-110-04-3-0
150 mm	1		10	1-110-06-1-0
150 mm	2		10	1-110-06-2-0
150 mm	3		10	1-110-06-3-0
200 mm	1		10	1-110-08-1-0
200 mm	2		10	1-110-08-2-0
200 mm	2		10	1-110-08-3-0
250 mm	1		10	1-110-10-1-0
250 mm	2		10	1-110-10-2-0
250 mm	3		10	1-110-10-3-0
300 mm	1		5	1-110-12-1-0
300 mm	2		5	1-110-12-2-0
300 mm	3		5	1-110-12-3-0
350 mm	1		5	1-110-14-1-0

Type of cut: 1 = Bastard, 2 = Second, 3 = Smooth

ERGO™ Engineering Tapered Edge Flat File Bastard/Second/Smooth Cut



1-110...-2

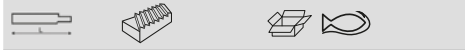

150 mm	1	5	1-110-06-1-2
150 mm	2	5	1-110-06-2-2
150 mm	3	5	1-110-06-3-2
200 mm	1	5	1-110-08-1-2
200 mm	2	5	1-110-08-2-2
200 mm	3	5	1-110-08-3-2
250 mm	1	5	1-110-10-1-2
250 mm	2	5	1-110-10-2-2
250 mm	3	5	1-110-10-3-2
300 mm	1	5	1-110-12-1-2
300 mm	2	5	1-110-12-2-2
300 mm	3	5	1-110-12-3-2

Type of cut: 1 = Bastard, 2 = Second, 3 = Smooth

Engineering Warding Flat Hand Files Bastard/Second/Smooth Cut Unhandled



1-111...-0



100 mm	1	10	1-111-04-1-0
100 mm	2	10	1-111-04-2-0
100 mm	3	10	1-111-04-3-0
150 mm	1	10	1-111-06-1-0
150 mm	2	10	1-111-06-2-0
150 mm	3	10	1-111-06-3-0
200 mm	1	10	1-111-08-1-0
200 mm	2	10	1-111-08-2-0

Type of cut: 1 = Bastard, 2 = Second, 3 = Smooth

ERGO™ Engineering Warding Flat Files Second Cut



1-111...-2



150 mm	2	5	1-111-06-2-2
--------	---	---	--------------

Type of cut: 1 = Bastard, 2 = Second, 3 = Smooth

Engineering Flat Contact Files Smooth Cut Unhandled



1-115

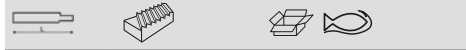

110 mm	3	10	1-115-11-3-1
--------	---	----	--------------

Engineering Mill Files with 2 Flat Edges Bastard/Second Cut Unhandled



1-143...-0

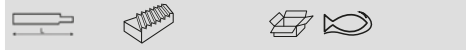

100 mm	1	10	1-143-04-1-0
150 mm	1	10	1-143-06-1-0
200 mm	1	10	1-143-08-1-0
250 mm	1	10	1-143-10-1-0
300 mm	1	5	1-143-12-1-0

Type of cut: 1 = Bastard, 2 = Second, 3 = Smooth

ERGO™ Engineering Mill Files with 2 Flat Edges Bastard/Second Cut



1-143...-2



150 mm	1	5	1-143-06-1-2
200 mm	1	5	1-143-08-1-2
250 mm	1	5	1-143-10-1-2
300 mm	1	5	1-143-12-1-2

Type of cut: 1 = Bastard, 2 = Second, 3 = Smooth

ERGO™ Engineering Diagonal Files Second Cut



1-320 ...-2

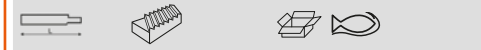

200 mm	2	5	1-320-08-2-2
250 mm	2	5	1-320-10-2-2
300 mm	2	5	1-320-12-2-2

Type of cut: 1 = Bastard, 2 = Second, 3 = Smooth

Engineering Diagonal Files Second Cut Unhandled



1-320...-0

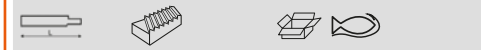

200 mm	2	10	1-320-08-2-0
250 mm	2	10	1-320-10-2-0
300 mm	2	5	1-320-12-2-0

Type of cut: 1 = Bastard, 2 = Second, 3 = Smooth



Engineering Half-Round Files Bastard/
Second/Smooth Cut Unhandled



1-210...-0

Length	Cut	Quantity	Part No.
100 mm	1	10	1-210-04-1-0
100 mm	2	10	1-210-04-2-0
100 mm	3	10	1-210-04-3-0
150 mm	1	10	1-210-06-1-0
150 mm	2	10	1-210-06-2-0
150 mm	3	10	1-210-06-3-0
200 mm	1	10	1-210-08-1-0
200 mm	2	10	1-210-08-2-0
200 mm	3	10	1-210-08-3-0
250 mm	1	10	1-210-10-1-0
250 mm	2	10	1-210-10-2-0
250 mm	3	10	1-210-10-3-0
300 mm	1	5	1-210-12-1-0
300 mm	2	5	1-210-12-2-0
300 mm	3	5	1-210-12-3-0
350 mm	1	5	1-210-14-1-0

Type of cut: 1 = Bastard, 2 = Second, 3 = Smooth

Engineering Round Files Bastard/Second/
Smooth Cut Unhandled



1-230...-0

Length	Cut	Quantity	Part No.
100 mm	1	10	1-230-04-1-0
100 mm	2	10	1-230-04-2-0
100 mm	3	10	1-230-04-3-0
150 mm	1	10	1-230-06-1-0
150 mm	2	10	1-230-06-2-0
150 mm	3	10	1-230-06-3-0
200 mm	1	10	1-230-08-1-0
200 mm	2	10	1-230-08-2-0
200 mm	3	10	1-230-08-3-0
250 mm	1	10	1-230-10-1-0
250 mm	2	10	1-230-10-2-0
250 mm	3	10	1-230-10-3-0
300 mm	1	5	1-230-12-1-0
300 mm	2	5	1-230-12-2-0
300 mm	3	5	1-230-12-3-0

Type of cut: 1 = Bastard, 2 = Second, 3 = Smooth

Engineering Three Square Files Bastard/
Second/Smooth Cut Unhandled



1-170...-0

Length	Cut	Quantity	Part No.
100 mm	1	10	1-170-04-1-0
100 mm	2	10	1-170-04-2-0
100 mm	3	10	1-170-04-3-0
150 mm	1	10	1-170-06-1-0
150 mm	2	10	1-170-06-2-0
150 mm	3	10	1-170-06-3-0
200 mm	1	10	1-170-08-1-0
200 mm	2	10	1-170-08-2-0
200 mm	3	10	1-170-08-3-0
250 mm	1	10	1-170-10-1-0
250 mm	2	10	1-170-10-2-0
250 mm	3	10	1-170-10-3-0
300 mm	1	5	1-170-12-1-0
300 mm	2	5	1-170-12-2-0

Type of cut: 1 = Bastard, 2 = Second, 3 = Smooth

ERGO™ Engineering Half-Round Files
Bastard/Second/Smooth Cut



1-210...-2

Length	Cut	Quantity	Part No.
100 mm	1	5	1-210-04-1-2
100 mm	2	5	1-210-04-2-2
150 mm	1	5	1-210-06-1-2
150 mm	2	5	1-210-06-2-2
150 mm	3	5	1-210-06-3-2
200 mm	1	5	1-210-08-1-2
200 mm	2	5	1-210-08-2-2
200 mm	3	5	1-210-08-3-2
250 mm	1	5	1-210-10-1-2
250 mm	2	5	1-210-10-2-2
250 mm	3	5	1-210-10-3-2
300 mm	1	5	1-210-12-1-2
300 mm	2	5	1-210-12-2-2
300 mm	3	5	1-210-12-3-2

Type of cut: 1 = Bastard, 2 = Second, 3 = Smooth

ERGO™ Engineering Round Files
Bastard/Second/Smooth Cut



1-230...-2

Length	Cut	Quantity	Part No.
100 mm	1	5	1-230-04-1-2
100 mm	2	5	1-230-04-2-2
150 mm	1	5	1-230-06-1-2
150 mm	2	5	1-230-06-2-2
150 mm	3	5	1-230-06-3-2
200 mm	1	5	1-230-08-1-2
200 mm	2	5	1-230-08-2-2
200 mm	3	5	1-230-08-3-2
250 mm	1	5	1-230-10-1-2
250 mm	2	5	1-230-10-2-2
250 mm	3	5	1-230-10-3-2
300 mm	1	5	1-230-12-1-2
300 mm	2	5	1-230-12-2-2
300 mm	3	5	1-230-12-3-2

Type of cut: 1 = Bastard, 2 = Second, 3 = Smooth

ERGO™ Engineering Three Square Files
Bastard/Second/Smooth Cut



1-170...-2

Length	Cut	Quantity	Part No.
100 mm	2	5	1-170-04-2-2
150 mm	1	5	1-170-06-1-2
150 mm	2	5	1-170-06-2-2
150 mm	3	5	1-170-06-3-2
200 mm	1	5	1-170-08-1-2
200 mm	2	5	1-170-08-2-2
200 mm	3	5	1-170-08-3-2
250 mm	1	5	1-170-10-1-2
250 mm	2	5	1-170-10-2-2
250 mm	3	5	1-170-10-3-2

Type of cut: 1 = Bastard, 2 = Second, 3 = Smooth

Engineering Square Files Bastard/Second/
Smooth Cut Unhandled



1-160...-0

Length	Cut	Quantity	Part No.
100 mm	1	10	1-160-04-1-0
100 mm	2	10	1-160-04-2-0
100 mm	3	10	1-160-04-3-0
150 mm	1	10	1-160-06-1-0
150 mm	2	10	1-160-06-2-0
150 mm	3	10	1-160-06-3-0
200 mm	1	10	1-160-08-1-0
200 mm	2	10	1-160-08-2-0
200 mm	3	10	1-160-08-3-0
250 mm	1	10	1-160-10-1-0
250 mm	2	10	1-160-10-2-0
250 mm	3	10	1-160-10-3-0
300 mm	1	5	1-160-12-1-0
300 mm	2	5	1-160-12-2-0
300 mm	3	5	1-160-12-3-0

Type of cut: 1 = Bastard, 2 = Second, 3 = Smooth

ERGO™ Engineering Square Files
Bastard/Second/Smooth Cut



1-160...-2

Length	Cut	Quantity	Part No.
100 mm	1	5	1-160-04-1-2
100 mm	2	5	1-160-04-2-2
150 mm	1	5	1-160-06-1-2
150 mm	2	5	1-160-06-2-2
150 mm	3	5	1-160-06-3-2
200 mm	1	5	1-160-08-1-2
200 mm	2	5	1-160-08-2-2
200 mm	3	5	1-160-08-3-2
250 mm	1	5	1-160-10-1-2
250 mm	2	5	1-160-10-2-2
250 mm	3	5	1-160-10-3-2
300 mm	1	5	1-160-12-1-2
300 mm	2	5	1-160-12-2-2
300 mm	3	5	1-160-12-3-2

Type of cut: 1 = Bastard, 2 = Second, 3 = Smooth

ERGO™ Engineering File Set Smooth
Cut - 6 Pcs



1-476

Length	Cut	Quantity	Part No.
100 mm	3	1	1-476-04-3-2

1-160-04-3-2, 1-111-04-3-2, 1-230-04-3-2, 1-170-04-3-2, 1-210-04-3-2, 1-100-04-3-2

ERGO™ Engineering File Set Second Cut
150 mm - 3 Pcs



1-473

Length	Cut	Quantity	Part No.
150 mm	2	5	1-473-06-2-2

1-230-06-2-2

1-210-06-2-2

1-100-06-2-2

ERGO™ Engineering File Set Second Cut
200 mm - 3 Pcs



1-473-08-2-2

Length	Cut	Quantity	Part No.
200 mm	2	5	1-473-08-2-2

1-230-08-2-2

1-210-08-2-2

1-100-08-2-2

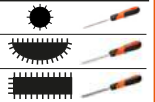

ERGO™ Engineering File Set Second Cut
250 mm - 3 Pcs



1-473-10-2-2 1

Length	Cut	Quantity	Part No.
250 mm	2	5	1-473-10-2-2

1-230-10-2-2

1-210-10-2-2

1-100-10-2-2

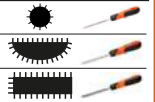

ERGO™ Engineering File Set with Half-
Round Rasp Second Cut 200 mm - 5 Pcs



1-477

Length	Cut	Quantity	Part No.
200 mm	2	5	1-477-08-2-2

1-100-08-2-2

1-210-08-2-2

6-343-08-2-2

1-230-08-2-2

1-170-08-2-2

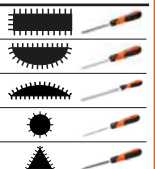

ERGO™ Engineering File Set with Half-Round Rasp Second Cut 250 mm - 5 Pcs



ergo



1-477-10-2-2



250 mm 2 5 1-477-10-2-2

1-100-10-2-2	
1-210-10-2-2	
6-343-10-2-2	
1-230-10-2-2	
1-170-10-2-2	

ERGO™ Engineering File Set 4 Bastard/1 Second Cut 200 mm - 5 Pcs



ergo



1-478



200 mm 1&2 5 1-478-08-1-2

1-210-08-1-2	
1-230-08-1-2	
1-100-08-1-2, 1-100-08-2-2	
1-160-08-1-2	

ERGO™ Engineering File Set 4 Bastard/1 Second Cut 250 mm - 5 Pcs



ergo



1-478-10-1-2_1

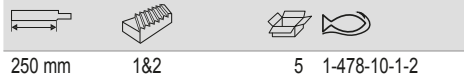

250 mm 1&2 5 1-478-10-1-2

1-210-10-1-2	
1-230-10-1-2	
1-100-10-1-2, 1-100-10-2-2	
1-160-10-1-2	

ERGO™ Engineering File Set with Cabinet Rasp Bastard Cut 200 mm - 5 Pcs



ergo



1-479

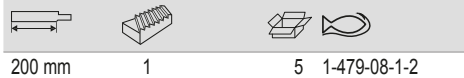

200 mm 1 5 1-479-08-1-2

4-138-08-1-2	
1-210-08-1-2	
6-343-08-2-2	
1-230-08-1-2	
1-100-08-1-2	

ERGO™ Engineering File Set with Cabinet Rasp Second Cut 200 mm - 5 Pcs



ergo



1-479-08-2-2

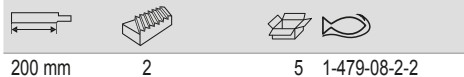

200 mm 2 5 1-479-08-2-2

4-138-08-1-2	
1-210-08-2-2	
6-343-08-2-2	
1-230-08-2-2	
1-100-08-2-2	

SHARPENING FILES

ERGO™ Flat Chainsaw Files



ergo



166-2



150 mm 3 5 166-6-16-2.5-2

Flat Chainsaw Files Unhandled



166/167-12

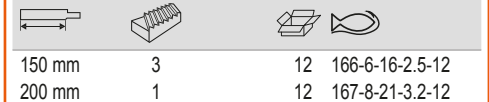

150 mm 3 12 166-6-16-2.5-12
200 mm 1 12 167-8-21-3.2-12

Round Chainsaw Files - 12 x 1 Pck



168 - 1P

150 mm	3.2 mm	12	168-6-3.2-1P
150 mm	3.5 mm	12	168-6-3.5-1P
200 mm	4.0 mm	12	168-8-4.0-1P
200 mm	4.5 mm	12	168-8-4.5-1P
200 mm	4.8 mm	12	168-8-4.8-1P
200 mm	5.2 mm	12	168-8-5.2-1P
200 mm	5.5 mm	12	168-8-5.5-1P
200 mm	6.3 mm	12	168-8-6.3-1P

Round Chainsaw Files - 12 x 3 Pck



168 - 3P

Length	Thickness	Quantity	Part No.
150 mm	3.2 mm	12	168-6-3.2-3P
150 mm	3.5 mm	12	168-6-3.5-3P
200 mm	4.0 mm	12	168-8-4.0-3P
200 mm	4.5 mm	12	168-8-4.5-3P
200 mm	4.8 mm	12	168-8-4.8-3P
200 mm	5.2 mm	12	168-8-5.2-3P
200 mm	5.5 mm	12	168-8-5.5-3P
200 mm	6.3 mm	12	168-8-6.3-3P

ERGO™ Chainsaw File Set with Two-Component Handle



168-C

Length	Thickness	Quantity	Part No.
200 mm	4.0 mm	10	168-COMBI-4.0
200 mm	4.5 mm	10	168-COMBI-4.5
200 mm	4.8 mm	10	168-COMBI-4.8
200 mm	5.5 mm	10	168-COMBI-5.5

Mill Saw Files with 2 Round Edges Bastard Cut Unhandled



4-140...-0

Length	Quantity	Part No.
150 mm	1	10 4-140-06-1-0
200 mm	1	10 4-140-08-1-0
250 mm	1	10 4-140-10-1-0

Round Chainsaw Files - 6 Pck



168-8

Length	Thickness	Quantity	Part No.
200 mm	4.0 mm	6	168-8-4.0-6
200 mm	4.5 mm	6	168-8-4.5-6
200 mm	4.8 mm	6	168-8-4.8-6
200 mm	5.2 mm	6	168-8-5.2-6
200 mm	5.5 mm	6	168-8-5.5-6

Mill Saw Files with 1 Round Edge Bastard Cut Unhandled



4-138...-0

Length	Quantity	Part No.
150 mm	1	10 4-138-06-1-0
200 mm	1	10 4-138-08-1-0
250 mm	1	10 4-138-10-1-0
300 mm	1	5 4-138-12-1-0

ERGO™ Mill Saw Files with Dual-Component Handle and 2 Round Edges Bastard Cut



4-140...-2

Length	Quantity	Part No.
200 mm	1	5 4-140-08-1-2
250 mm	1	5 4-140-10-1-2

ERGO™ Chainsaw File Set with Two-Component Handle and Filing Guide



168-C-G

Length	Thickness	Quantity	Part No.
200 mm	4.0 mm	10	168-COMBI-4.0-6922
200 mm	4.8 mm	10	168-COMBI-4.8-6920
200 mm	5.5 mm	10	168-COMBI-5.5-6924

ERGO™ Mill Saw Files with Dual-Component Handle and 1 Round Edge Bastard Cut



4-138...-2

Length	Quantity	Part No.
150 mm	1	5 4-138-06-1-2
200 mm	1	5 4-138-08-1-2
250 mm	1	5 4-138-10-1-2
300 mm	1	5 4-138-12-1-2

Mill Saw Files with 2 Flat Edges Bastard Cut Unhandled



4-142

Length	Quantity	Part No.
150 mm	1	10 4-142-06-1-0
200 mm	1	10 4-142-08-1-0
250 mm	1	10 4-142-10-1-0



Mill Saw Files with 1 Round Edge Extra thin Second Cut Unhandled



4-144...-0

200 mm	2	10	4-144-08-2-0

2-in-1 ERGO™ Homeowner's Files with Two-Component Handle for Metal



4-153

200 mm	1 & 1	5	4-153-08-1-2

Taper Saw Files Second Cut Unhandled



4-183...-0

100 mm	2	10	4-183-04-2-0
112 mm	2	10	4-183-45-2-0
125 mm	2	10	4-183-05-2-0
150 mm	2	10	4-183-06-2-0
175 mm	2	10	4-183-07-2-0
200 mm	2	10	4-183-08-2-0
250 mm	2	10	4-183-10-2-0

ERGO™ Mill Saw Files with Dual-Component Handle and 1 Round Edge Second Cut



4-144...-2

200 mm	2	5	4-144-08-2-2

4-in-2 ERGO™ Homeowner's File Set with Two-Component Handle for Wood and Metal



4-154

200 mm	1 & 2	10	4-154-08-2-2

ERGO™ Taper Saw Files with Dual-Component Handle Second Cut



4-183...-2

100 mm	2	5	4-183-04-2-2
125 mm	2	5	4-183-05-2-2
150 mm	2	5	4-183-06-2-2
175 mm	2	5	4-183-07-2-2
200 mm	2	5	4-183-08-2-2

2-in-1 ERGO™ Homeowner's Files with Two-Component Handle for Wood & Metal



4-152

200 mm	2 & 2	5	4-152-08-2-2

2-in-1 Farmer's own double Duty Files Bastard Cut



4-155

200 mm	1	10	4-155-08-2-0
250 mm	1	5	4-155-10-2-0

Slim Taper Saw Files Second Cut Unhandled



4-186...-0

100 mm	2	10	4-186-04-2-0
112 mm	2	10	4-186-45-2-0
125 mm	2	10	4-186-05-2-0
150 mm	2	10	4-186-06-2-0
175 mm	2	10	4-186-07-2-0
200 mm	2	10	4-186-08-2-0

ERGO™ Slim Taper Files with Dual-Component Handle Second Cut



4-186...-2



100 mm	2	5	4-186-04-2-2
125 mm	2	5	4-186-05-2-2
150 mm	2	5	4-186-06-2-2

Double Extra Slim Taper Saw Files Second Cut Unhandled



4-188...-0



125 mm	2	10	4-188-05-2-0
150 mm	2	10	4-188-06-2-0

ERGO™ Double-Ended Saw Files with Dual-Component Handle Second Cut



4-190...-2



150 mm	2	5	4-190-06-2-2
175 mm	2	5	4-190-07-2-2
200 mm	2	5	4-190-08-2-2

Extra Slim Taper Saw Files Second Cut Unhandled



4-187...-0



100 mm	2	10	4-187-04-2-0
112 mm	2	10	4-187-45-2-0
125 mm	2	10	4-187-05-2-0
150 mm	2	10	4-187-06-2-0
175 mm	2	10	4-187-07-2-0

ERGO™ Double Extra Slim Taper Files with Dual-Component Handle Second Cut



4-188...-2



125 mm	2	5	4-188-05-2-2
--------	---	---	--------------

Tapered Bandsaw Files Second Cut Unhandled



4-192...-0



150 mm	2	10	4-192-06-2-0
175 mm	2	10	4-192-07-2-0
200 mm	2	10	4-192-08-2-0

ERGO™ Extra Slim Taper Files with Dual-Component Handle Second Cut



4-187...-2



125 mm	2	5	4-187-05-2-2
150 mm	2	5	4-187-06-2-2

Double-Ended Saw Files with Wooden Handle Second Cut



4-190...-0



175 mm	2	10	4-190-07-2-0
200 mm	2	10	4-190-08-2-0

ERGO™ Tapered Bandsaw Files with Dual-Component Handle Second Cut



4-192...-2



150 mm	2	5	4-192-06-2-2
200 mm	2	5	4-192-08-2-2



Machine Bandsaw Files Second Cut



4-202 - 4-204



216 mm	2	10	4-202-85-2-0
216 mm	2	10	4-204-85-2-0

Wasa™ Double Edge Saw Files Smooth Cut Unhandled



4-272...-0



150 mm	3	10	4-272-06-3-0
--------	---	----	--------------

ERGO™ Wasa™ Double Edge Saw Files with Dual-Component Handle Smooth Cut



4-272...-2



125 mm	3	5	4-272-05-3-2
150 mm	3	5	4-272-06-3-2

RASPS

Flat Hand Rasps Medium Cut Unhandled



6-344...-0



200 mm	2	10	6-344-08-2-0
250 mm	2	10	6-344-10-2-0

ERGO™ Flat Hand Rasps Medium Cut



6-344...-2



200 mm	2	5	6-344-08-2-2
250 mm	2	5	6-344-10-2-2

Half-Round Rasps Coarse/Medium Cut Unhandled



6-342...-0



150 mm	2	10	6-342-06-2-0
200 mm	1	10	6-342-08-1-0
200 mm	2	10	6-342-08-2-0
250 mm	1	10	6-342-10-1-0
250 mm	2	10	6-342-10-2-0

ERGO™ Half-Round Rasps Coarse/Medium Cut



6-342...-2



150 mm	2	5	6-342-06-2-2
200 mm	1	5	6-342-08-1-2
200 mm	2	5	6-342-08-2-2
250 mm	1	5	6-342-10-1-2
250 mm	2	5	6-342-10-2-2

Half-Round Cabinet Rasps Medium/Fine Cut Unhandled



6-343...-0



200 mm	2	10	6-343-08-2-0
200 mm	3	10	6-343-08-3-0
250 mm	2	10	6-343-10-2-0
250 mm	3	10	6-343-10-3-0

ERGO™ Half-Round Cabinet Rasps Medium Cut



6-343...-2



200 mm	2	5	6-343-08-2-2
250 mm	2	5	6-343-10-2-2

Round Rasps Medium Cut Unhandled



6-345...-0

200 mm	2	10	6-345-08-2-0
250 mm	2	10	6-345-10-2-0

ERGO™ Round Rasps Coarse/Medium Cut



6-345...-2

200 mm	1	5	6-345-08-1-2
200 mm	2	5	6-345-08-2-2
250 mm	1	5	6-345-10-1-2

ERGO™ Rasp File Set Second Cut - 3 Pcs



6-470

200 mm	2	5	6-470-08-2-2

6-345-08-2-2

6-342-08-2-2

4-152-08-2-2

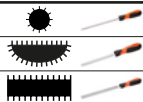

MILLED TOOTH FILES

Pansar® Milled Tooth Flat Blades Bastard/Second Cut Unhandled



3-330

300 mm	1	5	3-330-12-1-0
300 mm	2	5	3-330-12-2-0
350 mm	1	5	3-330-14-1-0
350 mm	2	5	3-330-14-2-0

Pansar® Milled Tooth Half-Round Blades Bastard Cut Unhandled



3-331

350 mm	1	5	3-331-14-1-0

ERGO™ Milled Tooth Filemasters with Two-component handle



FM10

300 mm	4 & 5	5	FM12
250 mm	4 & 5	5	FM10

ERGO™ Milled Tooth Half-Round Filemasters with Two-component handle



HRFM10

250 mm	5	5	HRFM10

NEEDLE FILES

Needle Flat Files Bastard/Second/Smooth/Dead Smooth Cut Unhandled



2-300

140 mm	0	10	2-300-14-0-0
140 mm	2	10	2-300-14-2-0
140 mm	4	10	2-300-14-4-0
160 mm	0	10	2-300-16-0-0
160 mm	1	10	2-300-16-1-0
160 mm	2	10	2-300-16-2-0
160 mm	4	10	2-300-16-4-0
180 mm	0	10	2-300-18-0-0
180 mm	2	10	2-300-18-2-0

Needle Flat Files with Tapered Edge Bastard/Second/Smooth Cut Unhandled



2-301

140 mm	0	10	2-301-14-0-0
140 mm	2	10	2-301-14-2-0
160 mm	0	10	2-301-16-0-0
160 mm	1	10	2-301-16-1-0
160 mm	2	10	2-301-16-2-0



Needle Half-Round Files Bastard/Second/
Smooth/Dead Smooth Cut Unhandled



2-304

Length	Coarse	Medium	Part No.
140 mm	0	10	2-304-14-0-0
140 mm	2	10	2-304-14-2-0
140 mm	4	10	2-304-14-4-0
160 mm	0	10	2-304-16-0-0
160 mm	1	10	2-304-16-1-0
160 mm	2	10	2-304-16-2-0
160 mm	4	10	2-304-16-4-0
180 mm	0	10	2-304-18-0-0
180 mm	2	10	2-304-18-2-0

Needle Half-Round Files Bastard Cut
Unhandled



2-313

Length	Coarse	Medium	Part No.
160 mm	0	10	2-313-16-0-0

Needle Round Files Bastard/Second/
Smooth/Dead Smooth Cut Unhandled



2-307

Length	Coarse	Medium	Part No.
140 mm	0	10	2-307-14-0-0
140 mm	2	10	2-307-14-2-0
140 mm	4	10	2-307-14-4-0
160 mm	0	10	2-307-16-0-0
160 mm	1	10	2-307-16-1-0
160 mm	2	10	2-307-16-2-0
160 mm	4	10	2-307-16-4-0
180 mm	0	10	2-307-18-0-0
180 mm	2	10	2-307-18-2-0

Needle Oval Files Second/Smooth Cut
Unhandled



2-305

Length	Coarse	Medium	Part No.
160 mm	1	10	2-305-16-1-0
160 mm	2	10	2-305-16-2-0

Needle Crossing Files Second/Smooth Cut
Unhandled



2-306

Length	Coarse	Medium	Part No.
160 mm	1	10	2-306-16-1-0
160 mm	2	10	2-306-16-2-0

Needle Three Square Files Bastard/
Second/Smooth/Dead Smooth Cut
Unhandled



2-302

Length	Coarse	Medium	Part No.
140 mm	0	10	2-302-14-0-0
140 mm	2	10	2-302-14-2-0
140 mm	4	10	2-302-14-4-0
160 mm	0	10	2-302-16-0-0
160 mm	1	10	2-302-16-1-0
160 mm	2	10	2-302-16-2-0
160 mm	4	10	2-302-16-4-0
180 mm	0	10	2-302-18-0-0
180 mm	2	10	2-302-18-2-0

Needle Barrette Files Smooth/Dead
Smooth Cut Unhandled



2-309

Length	Coarse	Medium	Part No.
160 mm	2	10	2-309-16-2-0
160 mm	4	10	2-309-16-4-0

Needle Knife Files Bastard/Second/
Smooth Cut Unhandled



2-308

Length	Coarse	Medium	Part No.
140 mm	2	10	2-308-14-2-0
160 mm	0	10	2-308-16-0-0
160 mm	1	10	2-308-16-1-0
160 mm	2	10	2-308-16-2-0

Needle Square Files Bastard/Second/
Smooth/Dead Smooth Cut Unhandled



2-303

Length	Coarse	Medium	Part No.
140 mm	2	10	2-303-14-2-0
160 mm	0	10	2-303-16-0-0
160 mm	1	10	2-303-16-1-0
160 mm	2	10	2-303-16-2-0
160 mm	4	10	2-303-16-4-0
180 mm	0	10	2-303-18-0-0
180 mm	2	10	2-303-18-2-0

Needle File Set Bastard Cut Unhandled
140 mm - 6 Pcs

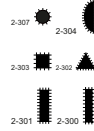

2-470



140 mm 0 10 2-470-14-0-0

9-488-02-10	
2-304-14-0-0	
2-300-14-0-0	
2-303-14-0-0	
2-302-14-0-0	
2-301-14-0-0	
2-307-14-0-0	

Needle File Set Smooth Cut Unhandled
140 mm - 6 Pcs



2-470-14-2-0



140 mm 2 10 2-470-14-2-0

9-488-02-10	
2-304-14-2-0	
2-300-14-2-0	
2-303-14-2-0	
2-302-14-2-0	
2-301-14-2-0	
2-307-14-2-0	

Needle File Set Dead Smooth Cut
Unhandled 140 mm - 6 Pcs



2-470-14-4-0



140 mm 4 10 2-470-14-4-0

9-488-02-10	
2-304-14-4-0	
2-300-14-4-0	
2-303-14-4-0, 2-301-14-4-0	
2-302-14-4-0	
2-307-14-4-0	

Needle File Set Second Cut Unhandled
160 mm - 6 Pcs



2-470-16-1-0

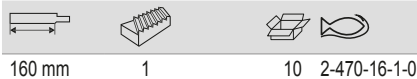

160 mm 1 10 2-470-16-1-0

9-488-02-10	
2-304-16-1-0	
2-300-16-1-0	
2-303-16-1-0	
2-302-16-1-0	
2-301-16-1-0	
2-307-16-1-0	

Needle File Set Smooth Cut Unhandled
160 mm - 6 Pcs



2-470-16-2-0



160 mm 2 10 2-470-16-2-0

9-488-02-10	
2-304-16-2-0	
2-300-16-2-0	
2-303-16-2-0	
2-302-16-2-0	
2-301-16-2-0	
2-307-16-2-0	

Needle File Set Second Cut Unhandled
160 mm - 9 Pcs



2-471



160 mm 1 5 2-471-16-1-0

9-488-02-10	
2-303-16-1-0	
2-304-16-1-0	
2-302-16-1-0	
2-300-16-1-0	
2-308-16-1-0	
2-301-16-1-0	
2-306-16-1-0	
2-305-16-1-0	
2-307-16-1-0	



Needle File Set Bastard Cut Unhandled
140 mm - 12 Pcs



2-472



140 mm 0 5 2-472-14-0-0

2-312-14-0-0, 2-311-14-0-0, 2-308-14-0-0

2-303-14-0-0, 2-313-14-0-0, 2-309-14-0-0, 2-306-14-0-0

2-300-14-0-0	
2-301-14-0-0	
2-304-14-0-0	
2-302-14-0-0	
2-307-14-0-0	
9-488-02-10	

Needle File Set Smooth Cut Unhandled
140 mm - 12 Pcs



2-472-14-2-0



140 mm 2 5 2-472-14-2-0

2-312-14-2-0, 2-311-14-2-0, 2-309-14-2-0

2-303-14-2-0	
2-300-14-2-0	
2-301-14-2-0	
2-304-14-2-0	
2-302-14-2-0	
2-313-14-2-0, 2-306-14-2-0	
2-307-14-2-0	
2-308-14-2-0	
9-488-02-10	

Needle File Set Bastard Cut Unhandled
160 mm - 12 Pcs



2-472-16-0-0

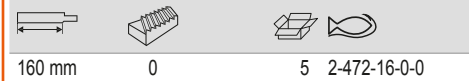

160 mm 0 5 2-472-16-0-0

2-312-16-0-0, 2-311-16-0-0, 2-309-16-0-0

2-303-16-0-0	
2-300-16-0-0	
2-301-16-0-0	
2-304-16-0-0	
2-302-16-0-0	
2-313-16-0-0	
2-307-16-0-0	
2-306-16-0-0	
2-308-16-0-0	
9-488-02-10	

Needle File Set Second Cut Unhandled
160 mm - 12 Pcs



2-472-16-1-0



160 mm 1 5 2-472-16-1-0

2-312-16-1-0, 2-313-16-1-0, 2-309-16-1-0

2-300-16-1-0	
2-301-16-1-0	
2-303-16-1-0	
2-304-16-1-0	
2-306-16-1-0	
2-307-16-1-0	
2-308-16-1-0	
2-309-16-2-0	
2-313-16-2-0	
9-488-02-10	

Needle File Set Smooth Cut Unhandled
160 mm - 12 Pcs



2-472-16-2-0

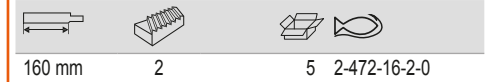

160 mm 2 5 2-472-16-2-0

2-312-16-2-0

2-303-16-2-0	
2-300-16-2-0	
2-301-16-2-0	
2-304-16-2-0	
2-302-16-2-0	
2-313-16-2-0	
2-307-16-2-0	
2-309-16-2-0	
2-306-16-2-0	
2-308-16-2-0	
9-488-02-10	

DIAMOND FILES

Diamond Precision Needle Files Unhandled



2-300-D - 2-304-D



140 mm	10	2-300-14-D-1P
160 mm	10	2-300-16-D-1P
140 mm	1	2-301-14-D-1P
140 mm	10	2-302-14-D-1P
160 mm	10	2-302-16-D-1P
140 mm	10	2-303-14-D-1P
160 mm	1	2-303-16-D-1P
140 mm	10	2-304-14-D-1P
160 mm	10	2-304-16-D-1P

Diamond Precision Needle Files
Unhandled 140/160 mm



2-306-D - 2-308-D

140 mm	1	2-306-14-D-1P
140 mm	10	2-307-14-D-1P
160 mm	10	2-307-16-D-1P
140 mm	1	2-308-14-D-1P

Tunable Holders for Pansar® 3-330, 12"
and 14" Flat Blade



9-463

300 & 350 mm	1	9-463-14-0-0

Steel Wire File Cards with Wooden Handle



9-469

110 mm	240 mm	1 9-469-00-0-0

Diamond Precision Files Integrated handle



5-600-D - 5-670-D

215 mm	10	5-600-21-D-1P
215 mm	5	5-610-21-D-1P
215 mm	1	5-630-21-D-1P
215 mm	1	5-670-21-D-1P

Universal Handle for Needle Files



9-488-02

5 g	10	9-488-02-10

ERGO™ Round Shaped Handles for Small
files - 10 Pcs Loose



9-484...10

3.2	3.2 mm	10 9-484-3.2-10
5.2	5.2 mm	10 9-484-5.2-10

ACCESSORIES

Aluminum Holders for Pansar® 3-330 14"
Flat Blade



9-462

350 mm	5	9-462-14-0-0

Plastic Handles for 8" Round Chainsaw
Files



PH-6604

55 g	15	PH-6604-1P
50 g	25	PH-6604-25

ERGO™ Round Shaped Handles for Small
files - 1 Pck Carded



9-484...1P

3.2	3.2 mm	10 9-484-3.2-1P
5.2	5.2 mm	10 9-484-5.2-1P

File Cleaners with Steel Wire Card



9-467

130 mm	260 mm	1 9-467-00-0-0



ERGO™ Oval Shaped Handles for Flat & Half-Round Files - 10 Pcs Loose



ergo



9-485...10

Length	Width	Quantity	Part No.
4	4 mm	10	9-485-04-10
5	5 mm	10	9-485-05-10
6	6 mm	10	9-485-06-10
9	9 mm	10	9-485-09-10
13	13 mm	10	9-485-13-10

ERGO™ Handles for Round Chainsaw Files - 1 Pck Carded



ergo



9-486-C-1P

Length	Width	Quantity	Part No.
3,2	3,2 mm	10	9-486-C-1P

ERGO™ Oval Shaped Handles for Flat & Half-Round Files - 1 Pck Carded



ergo



9-485...1P

Length	Width	Quantity	Part No.
4	4 mm	10	9-485-04-1P
5	5 mm	10	9-485-05-1P
6	6 mm	20	9-485-06-1P
9	9 mm	20	9-485-09-1P
13	13 mm	1	9-485-13-1P

ERGO™ Round Shaped Handles for Shaped Files - 10 Pcs Loose



ergo



9-486...10

Length	Width	Quantity	Part No.
4	4 mm	10	9-486-04-10
5	5 mm	10	9-486-05-10
7	7 mm	10	9-486-07-10
8	8 mm	10	9-486-08-10

ERGO™ Handles for Round Chainsaw Files - 10 Pcs Loose



ergo



9-486-C-10

Length	Width	Quantity	Part No.
3,2	3,2 mm	10	9-486-C-10

ERGO™ Round Shaped Handles for Shaped Files - 1 Pck Carded



ergo



9-486...1P

Length	Width	Quantity	Part No.
4	4 mm	20	9-486-04-1P
5	5 mm	20	9-486-05-1P
7	7 mm	20	9-486-07-1P



Wrenches



ADJUSTABLE WRENCHES

ERGO™ Central Nut Adjustable Wrenches with Rubber Handle and Phosphate Finish



ergo



90

L	W	W	W
158mm/6"	20 mm	5	9070
208mm/8"	27 mm	5	9071
257mm/10"	31 mm	5	9072
308mm/12"	34 mm	5	9073

ERGO™ rubber handle central nut phosphated adjustable wrench, with reversible jaw.



ergo



90P

L	W	W	W
158mm/6"	21 mm	5	9070 P
208mm/8"	28 mm	5	9071 P
257mm/10"	33 mm	5	9072 P
308mm/12"	35 mm	5	9073 P

ERGO™ Central Nut Adjustable Wrenches with Rubber Handle and Chrome Finish



ergo



90C

L	W	W	W
158mm/6"	20 mm	5	9070C
208mm/8"	27 mm	5	9071C
257mm/10"	31 mm	5	9072 C
308mm/12"	34 mm	3	9073 C

ERGO™ Rubber Handle Central Nut Adjustable Wrenches, with reversible jaw.



ergo



90PC

L	W	W	W
158mm/6"	21 mm	5	9070 PC
208mm/8"	28 mm	5	9071 PC
257mm/10"	33 mm	5	9072 PC
308mm/12"	35 mm	3	9073 PC

ERGO™ Central Nut Wide Opening Jaw Adjustable Wrenches with Rubber Handle and Phosphate Finish



ergo



9029-9035

L	W	W	W
170mm/6"	32 mm	5	9029
218mm/8"	38 mm	5	9031
270mm/10"	46 mm	5	9033
324mm/12"	55 mm	5	9035

ERGO™ Central Nut Wide Opening Jaw Adjustable Wrenches with Rubber Handle and Chrome Finish



ergo



9029C/9031C

L	W	W	W
170mm/6"	32 mm	5	9029 C
218mm/8"	38 mm	5	9031 C

ERGO™ Central Nut Wide Opening Thin Jaw Adjustable Wrenches with Rubber Handle



ergo



9029-T/9031-T

L	W	W	W
170mm/6"	32 mm	5	9029-T
218mm/8"	38 mm	5	9031-T

ERGO™ Central Nut Reversible Extra Wide Opening Jaw Adjustable Wrenches with Rubber Handle



ergo



9031P

L	W	W	W
218mm/8"	39 mm	5	9031P

ERGO™ Central Nut Adjustable Wrench Set with Rubber Handle



ergo



ADJUST3-90

g	W	W
900 g	1	ADJUST 3-90

9070, 9071, 9072



ERGO™ Adjustable Wrenches Twin Pack



ADJUST9031/29



550 g 3 ADJUST 9031/29

9029, 9031



Central Nut Adjustable Wrenches with Phosphate Finish



80



110mm/4"	13 mm	5	8069
155mm/6"	20 mm	5	8070
205mm/8"	27 mm	5	8071
255mm/10"	31 mm	5	8072
305mm/12"	34 mm	5	8073
380mm/15"	44 mm	3	8074
455mm/18"	53 mm	3	8075
110mm/4"	13 mm	50	8069 IP
155mm/6"	20 mm	40	8070 IP
205mm/8"	27 mm	50	8071 IP
255mm/10"	31 mm	30	8072 IP
305mm/12"	34 mm	20	8073 IP
380mm/15"	44 mm	20	8074 IP
455mm/18"	53 mm	10	8075 IP

Standard Central Nut Adjustable Wrenches with Chrome Finish



80C



110mm/4"	13 mm	5	8069 C
155mm/6"	20 mm	5	8070 C
205mm/8"	27 mm	5	8071 C
255mm/10"	31 mm	5	8072 C
305mm/12"	34 mm	5	8073 C
380mm/15"	44 mm	3	8074 C
455mm/18"	53 mm	3	8075 C



110mm/4"	13 mm	5	8069 C IP
155mm/6"	20 mm	5	8070 C IP
205mm/8"	27 mm	5	8071 C IP
255mm/10"	31 mm	5	8072 C IP
305mm/12"	34 mm	5	8073 C IP
380mm/15"	44 mm	3	8074 C IP
455mm/18"	53 mm	3	8075 C IP

Standard Central Nut Adjustable Wrenches with Phosphate Finish



86/87



614mm/24"	63 mm	1	86
770mm/30"	85 mm	3	87

Standard Central Nut Adjustable Wrench Set



ADJUST3



810 g 1 ADJUST 3

8070, 8071, 8072



Spare Jaw for Central Nut Adjustable Wrenches



RPS



8069, 8069 C	1	8069-1
8070, 8070 C, 9070, 9070 C	1	8070-1
8071, 8071 C, 9071, 9071 C	1	8071-1

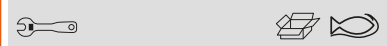

8072, 8072 C, 9072, 9072 C	1	8072-1
8073, 8073 C, 9073, 9073 C	1	8073-1
8074, 8074 C	1	8074-1
8075, 8075 C	1	8075-1
9029, 9029 C, 31	1	9029-1
9029-T	1	9029T-1
9031, 9031 C	1	9031-1
9031-T	1	9031T-1
9033, 33H	1	9033-1
9035	1	9035-1
86	1	86-1
87	1	87-1
9031 P	1	9031 P-1
9070 P, 9070 PC	1	9070 P-1
9071 P, 9071 PC	1	9071 P-1
9072 P, 9072 PC	1	9072 P-1
9073 P, 9073 PC	1	9073 P-1

Spare Knurl, Pin & Spring for Central Nut Adjustable Wrenches



RPS2



8069, 8069 C	3 g	1	8069-2
8070, 8070 C, 9070, 9070 C, 9070 P, 9070 PC	8 g	1	8070-2
8071, 8071 C, 9071, 9071 C, 9071 P, 9071 PC	10 g	1	8071-2
8072, 8072 C, 9072, 9072 C, 9072 P, 9072 PC	16 g	1	8072-2
8073, 8073 C, 9073, 9073 C, 9073 P, 9073 PC, 9033	25 g	1	8073-2
8074, 8074 C, 9035	47 g	1	8074-2
8075, 8075 C	54 g	1	8075-2
9029, 9029 C, 9029-T, 9031-T, 31, 9031, 9031 C, 9031P	9 g	1	9029-2
86	125 g	1	86-2
87	185 g	1	87-2



Podger Adjustable Wrenches with Phosphate Finish



84

405mm/16"	41 mm	1	84-PODGER

Wide Jaw Adjustable Wrenches with Serrated Pipe Jaws and Phosphate Finish



31

209mm/8"	32 mm	5	31
209mm/8"	32 mm	50	31 IP

Thin Jaw Adjustable Spanners with Serrated Pipe Jaws & Phosphate Finish



31-T

209mm/8"	32 mm	5	31-T
209mm/8"	32 mm	50	31-T IP

Wide Jaw Adjustable Wrenches with Hook and Phosphate Finish



33H

254mm/10"	46 mm	5	33H

Side Nut Heavy Duty Adjustable Wrenches with Rubber Handle and Phosphate Finish



95

257mm/10"	35 mm	5	9572

Side Nut Adjustable Wrenches with Chrome Finish



91C/97C

155mm/6"	21 mm	5	91C
205mm/8"	29 mm	5	92C
255mm/10"	34 mm	5	93C
305mm/12"	39 mm	5	94C
405mm/16"	48 mm	1	95C
500mm/20"	60 mm	1	96C
750mm/30"	77 mm	1	97C



COMBINATION WRENCHES

Metric Flat Combination Wrenches with Chrome Finish



111M



5.5 mm	10	111M-5.5
6 mm	10	111M-6
7 mm	10	111M-7
8 mm	10	111M-8
9 mm	10	111M-9
10 mm	10	111M-10
11 mm	10	111M-11
12 mm	10	111M-12
13 mm	10	111M-13
14 mm	10	111M-14
15 mm	10	111M-15
16 mm	10	111M-16
17 mm	10	111M-17
18 mm	10	111M-18
19 mm	10	111M-19
20 mm	10	111M-20
21 mm	10	111M-21
22 mm	5	111M-22
23 mm	5	111M-23
24 mm	5	111M-24
25 mm	5	111M-25
26 mm	5	111M-26
27 mm	5	111M-27
28 mm	5	111M-28
29 mm	5	111M-29
30 mm	5	111M-30
32 mm	5	111M-32
33 mm	5	111M-33
34 mm	5	111M-34
36 mm	1	111M-36
38 mm	1	111M-38
41 mm	1	111M-41
46 mm	1	111M-46
50 mm	1	111M-50
55 mm	1	111M-55
60 mm	1	111M-60
65 mm	1	111M-65
70 mm	1	111M-70
75 mm	1	111M-75
80 mm	1	111M-80
85 mm	1	111M-85
90 mm	1	111M-90
95 mm	1	111M-95
100 mm	1	111M-100
5.5 mm	1	SB111M-5.5
6 mm	1	SB111M-6
7 mm	1	SB111M-7
8 mm	1	SB111M-8
9 mm	1	SB111M-9
10 mm	1	SB111M-10
11 mm	1	SB111M-11
12 mm	1	SB111M-12
13 mm	1	SB111M-13
14 mm	1	SB111M-14
15 mm	1	SB111M-15

  	
16 mm	1 SB111M-16
17 mm	1 SB111M-17
18 mm	1 SB111M-18
19 mm	1 SB111M-19
20 mm	1 SB111M-20
21 mm	1 SB111M-21
22 mm	1 SB111M-22
23 mm	1 SB111M-23
24 mm	1 SB111M-24
25 mm	1 SB111M-25
26 mm	1 SB111M-26
27 mm	1 SB111M-27
28 mm	1 SB111M-28
29 mm	1 SB111M-29
30 mm	1 SB111M-30
32 mm	1 SB111M-32

Imperial Stubby Combination Wrenches with Chrome Finish





1Z

  	
3/16 in	20 1Z-3/16
7/32 in	20 1Z-7/32
9/32 in	20 1Z-9/32
5/16 in	10 1Z-5/16
11/32 in	10 1Z-11/32
3/8 in	10 1Z-3/8
7/16 in	10 1Z-7/16
1/2 in	10 1Z-1/2
9/16 in	10 1Z-9/16
5/8 in	10 1Z-5/8
11/16 in	10 1Z-11/16
3/4 in	10 1Z-3/4
13/16 in	10 1Z-13/16
7/8 in	10 1Z-7/8
15/16 in	5 1Z-15/16
1 in	10 1Z-1

Imperial Flat Combination Wrenches with Chrome Finish





111Z

  	
1/4 in	5 111Z-1/4
5/16 in	5 111Z-5/16
3/8 in	5 111Z-3/8
7/16 in	5 111Z-7/16
1/2 in	5 111Z-1/2
9/16 in	5 111Z-9/16
5/8 in	5 111Z-5/8
11/16 in	5 111Z-11/16
3/4 in	5 111Z-3/4
13/16 in	5 111Z-13/16
7/8 in	5 111Z-7/8
15/16 in	3 111Z-15/16
1 in	3 111Z-1
1 1/16 in	5 111Z-1.1/16
1 1/8 in	5 111Z-1.1/8
1 1/4 in	5 111Z-1.1/4
1 5/16 in	5 111Z-1.5/16
1 3/8 in	1 111Z-1.3/8
1 7/16 in	1 111Z-1.7/16
1 1/2 in	1 111Z-1.1/2
1 5/8 in	1 111Z-1.5/8
1 11/16 in	1 111Z-1.11/16
1 3/4 in	1 111Z-1.3/4
1 13/16 in	1 111Z-1.13/16
1 7/8 in	1 111Z-1.7/8
2 in	1 111Z-2
2 1/8 in	1 111Z-2.1/8
2 1/4 in	1 111Z-2.1/4
2 3/8 in	1 111Z-2.3/8
2 1/2 in	1 111Z-2.1/2
2 5/8 in	1 111Z-2.5/8
2 3/4 in	1 111Z-2.3/4
2 7/8 in	1 111Z-2.7/8
3 in	1 111Z-3

Metric Flat Combination Wrenches with Matte Finish



S20

  	
7	1 SBS20-7
8	1 SBS20-8
9	1 SBS20-9
11	1 SBS20-11
12	1 SBS20-12
13	1 SBS20-13
14	1 SBS20-14
15	1 SBS20-15
16	1 SBS20-16
20	1 SBS20-20
22	1 SBS20-22
24	1 SBS20-24

Metric Flat Combination Wrench Set - 5 Pcs/Plastic Holder



111M/SH5

  	
5	1 111M/SH5

111M-8, 111M-10, 111M-13, 111M-17, 111M-19

Metric Flat Combination Wrench Set - 8 Pcs/Plastic Holder



111M/SH8

  	
8	1 111M/SH8

111M-8, 111M-10, 111M-12, 111M-13, 111M-14, 111M-17, 111M-19, 111M-22

Metric Flat Combination Wrench Set 9-18 mm - 12 Pcs/Plastic Holder



111M/SH12

  	
12	1 111M/SH12

111M-8, 111M-9, 111M-10, 111M-11, 111M-12, 111M-13, 111M-14, 111M-15, 111M-16, 111M-17, 111M-18, 111M-19



Metric Flat Combination Wrench Set
Cardboard Box



111M/



10

1 111M/S10

111M-8, 111M-9, 111M-10, 111M-11,
111M-12, 111M-13, 111M-14, 111M-17,
111M-19, 111M-22



Metric Flat Combination Wrench Set - 11
Pcs/Pouch



111M/11T



11

1 111M/11T

111M-8, 111M-9, 111M-10, 111M-11,
111M-12, 111M-13, 111M-14, 111M-15,
111M-17, 111M-19, 111M-22



Metric Flat Combination Wrench Set - 14
Pcs/Pouch



111M/14T



14

1 111M/14T

111M-6, 111M-8, 111M-9, 111M-10,
111M-13, 111M-14, 111M-15, 111M-17,
111M-19, 111M-22, 111M-24, 111M-27,
111M-30, 111M-32



Metric Flat Combination Wrench Set 6-22
mm - 17 Pcs/Pouch



111M/17T



17

1 111M/17T

111M-6, 111M-7, 111M-8, 111M-9,
111M-10, 111M-11, 111M-12, 111M-13,
111M-14, 111M-15, 111M-16, 111M-17,
111M-18, 111M-19, 111M-20, 111M-21,
111M-22



Metric Flat Combination Wrench Set 8-32
mm - 17 Pcs/Pouch



111M/17TL



17

1 111M/17TL

111M-8, 111M-9, 111M-10, 111M-11,
111M-12, 111M-13, 111M-14, 111M-15,
111M-16, 111M-18, 111M-19, 111M-22,
111M-24, 111M-26, 111M-27, 111M-30,
111M-32



Metric Flat Combination Wrench Set - 24
Pcs/Pouch



111M/24T



24

1 111M/24T

111M-6, 111M-7, 111M-8, 111M-9,
111M-10, 111M-11, 111M-12, 111M-13,
111M-14, 111M-15, 111M-16, 111M-17,
111M-18, 111M-19, 111M-20, 111M-21,
111M-22, 111M-24, 111M-26, 111M-27,
111M-28, 111M-30, 111M-32, 111M-36



Metric Flat Combination Wrench Set - 26
Pcs/Pouch



111M/26T



26

1 111M/26T

111M-6, 111M-7, 111M-8, 111M-9,
111M-10, 111M-11, 111M-12, 111M-13,
111M-14, 111M-15, 111M-16, 111M-17,
111M-18, 111M-19, 111M-20, 111M-21,
111M-22, 111M-23, 111M-24, 111M-25,
111M-26, 111M-27, 111M-28, 111M-29,
111M-30, 111M-32



Imperial Flat Combination Wrench Set - 8
Pcs/Black Plastic Pouch



111Z/



8

1 111Z/8T

111Z-3/8, 111Z-7/16, 111Z-1/2,
111Z-9/16, 111Z-5/8, 111Z-11/16,
111Z-3/4, 111Z-7/8



Imperial Flat Combination Wrench Set - 11
Pcs/Black Plastic Pouch



111Z/11T



11

1 111Z/11T

111Z-3/8, 111Z-7/16, 111Z-1/2,
111Z-9/16, 111Z-5/8, 111Z-11/16,
111Z-3/4, 111Z-13/16, 111Z-7/8,
111Z-15/16, 111Z-1



Metric Long Type Combination Wrenches
with Chrome Finish



11M



8 mm
9 mm
10 mm
11 mm
12 mm
13 mm
14 mm
15 mm
16 mm
17 mm
18 mm
19 mm
21 mm
22 mm
24 mm
27 mm
30 mm
32 mm
36 mm
38 mm

5 11M-8
5 11M-9
5 11M-10
5 11M-11
5 11M-12
5 11M-13
5 11M-14
5 11M-15
5 11M-16
5 11M-17
5 11M-18
5 11M-19
5 11M-21
5 11M-22
5 11M-24
1 11M-27
1 11M-30
1 11M-32
1 11M-36
1 11M-38

Imperial Long Type Combination
Wrenches with Chrome Finish



11Z



3/8 in	5	11Z-3/8
7/16 in	5	11Z-7/16
1/2 in	5	11Z-1/2
9/16 in	5	11Z-9/16
5/8 in	5	11Z-5/8
11/16 in	5	11Z-11/16
3/4 in	5	11Z-3/4
13/16 in	5	11Z-13/16
1 in	5	11Z-1

Metric Lollipop Combination Wrenches with
Chrome Finish



4020L-M



3 mm	5	4020L-M-3
3.2 mm	5	4020L-M-3.2
3.5 mm	5	4020L-M-3.5
4 mm	5	4020L-M-4
4.5 mm	5	4020L-M-4.5
5 mm	5	4020L-M-5
5.5 mm	5	4020L-M-5.5

Metric Offset Combination Wrenches with
Chrome Finish



1952M



6 mm	10	1952M-6
7 mm	10	1952M-7
8 mm	10	1952M-8
9 mm	10	1952M-9
10 mm	10	1952M-10
11 mm	10	1952M-11
12 mm	10	1952M-12
13 mm	10	1952M-13
14 mm	10	1952M-14
15 mm	10	1952M-15
16 mm	10	1952M-16



17 mm	10	1952M-17
18 mm	10	1952M-18
19 mm	10	1952M-19
20 mm	10	1952M-20
21 mm	10	1952M-21
22 mm	5	1952M-22
23 mm	5	1952M-23
24 mm	5	1952M-24
25 mm	5	1952M-25
26 mm	5	1952M-26
27 mm	5	1952M-27
28 mm	1	1952M-28
29 mm	1	1952M-29
30 mm	1	1952M-30
32 mm	1	1952M-32
34 mm	1	1952M-34
36 mm	1	1952M-36
41 mm	1	1952M-41
46 mm	1	1952M-46
50 mm	1	1952M-50
55 mm	1	1952M-55
60 mm	1	1952M-60
65 mm	1	1952M-65
70 mm	1	1952M-70
75 mm	1	1952M-75
80 mm	1	1952M-80
7 mm	1	SB1952M-7
8 mm	1	SB1952M-8
10 mm	1	SB1952M-10
12 mm	1	SB1952M-12
13 mm	1	SB1952M-13
14 mm	1	SB1952M-14
17 mm	1	SB1952M-17
19 mm	1	SB1952M-19
24 mm	1	SB1952M-24

Imperial Offset Combination Wrenches
with Chrome Finish



1952Z



1/4 in	5	1952Z-1/4
5/16 in	5	1952Z-5/16
11/32 in	5	1952Z-11/32
3/8 in	5	1952Z-3/8
7/16 in	5	1952Z-7/16
1/2 in	5	1952Z-1/2
9/16 in	5	1952Z-9/16
5/8 in	5	1952Z-5/8
11/16 in	5	1952Z-11/16
3/4 in	5	1952Z-3/4
13/16 in	5	1952Z-13/16
7/8 in	5	1952Z-7/8
15/16 in	5	1952Z-15/16
1 in	1	1952Z-1
1 1/16 in	1	1952Z-1.1/16
1 1/8 in	1	1952Z-1.1/8
1 1/4 in	1	1952Z-1.1/4
1 5/16 in	1	1952Z-1.5/16
1 3/8 in	1	1952Z-1.3/8
1 7/16 in	1	1952Z-1.7/16
1 1/2 in	1	1952Z-1.1/2
1 5/8 in	1	1952Z-1.5/8



Metric Offset Combination Wrenches with 12-Point Dynamic-Drive™



PU

6 mm	5	PU-6
9 mm	5	PU-9
14 mm	5	PU-14
20 mm	3	PU-20
22 mm	3	PU-22
24 mm	3	PU-24

Metric Offset Combination Wrench Set - 10 Pcs/Box



1952M/

10	1	1952M/10

1952M-8, 1952M-9, 1952M-10, 1952M-11, 1952M-12, 1952M-13, 1952M-14, 1952M-16, 1952M-17, 1952M-19

Metric Offset Combination Wrench Set - 17 Pcs/Pouch



1952M/17T

17	1	1952M/17T

1952M-6, 1952M-7, 1952M-8, 1952M-9, 1952M-10, 1952M-11, 1952M-12, 1952M-13, 1952M-14, 1952M-15, 1952M-16, 1952M-17, 1952M-18, 1952M-19, 1952M-20, 1952M-21, 1952M-22

Metric Offset Combination Ratcheting Wrench Set - 8 Pcs



1952M/SH

6	1	1952M/SH6

1952M-8, 1952M-10, 1952M-12, 1952M-13, 1952M-14, 1952M-17

Metric Offset Combination Wrench Set - 7 Pcs/Pouch



1952M/T

7	1	1952M/7T

1952M-8, 1952M-10, 1952M-13, 1952M-14, 1952M-17, 1952M-19, 1952M-22

Metric Offset Combination Wrench Set - 26 Pcs/Pouch



1952M/26T

26	1	1952M/26T

1952M-6, 1952M-7, 1952M-8, 1952M-9, 1952M-10, 1952M-11, 1952M-12, 1952M-13, 1952M-14, 1952M-15, 1952M-16, 1952M-17, 1952M-18, 1952M-19, 1952M-20, 1952M-21, 1952M-22, 1952M-23, 1952M-24, 1952M-25, 1952M-26, 1952M-27, 1952M-28, 1952M-29, 1952M-30, 1952M-32

Metric Offset Combination Ratcheting Wrench Set - 12 Pcs



1952M/SH12

12	1	1952M/SH12

1952M-8, 1952M-9, 1952M-10, 1952M-11, 1952M-12, 1952M-13, 1952M-14, 1952M-15, 1952M-16, 1952M-17, 1952M-18, 1952M-19

Metric Offset Combination Wrench Set - 14 Pcs/Pouch



1952M/14T

14	1	1952M/14T

1952M-6, 1952M-8, 1952M-9, 1952M-10, 1952M-13, 1952M-14, 1952M-15, 1952M-17, 1952M-19, 1952M-22, 1952M-24, 1952M-27, 1952M-30, 1952M-32

Imperial Offset Combination Wrench Set



1952Z/T



11 1 1952Z/11T

1952Z-1/4, 1952Z-5/16, 1952Z-3/8,
1952Z-7/16, 1952Z-1/2, 1952Z-9/16,
1952Z-5/8, 1952Z-11/16, 1952Z-3/4,
1952Z-13/16, 1952Z-7/8



RATCHETING WRENCHES

Metric Combination Ratcheting Wrenches with Chrome Finish



1RM



6 mm	1	1RM-6
7 mm	1	1RM-7
8 mm	1	1RM-8
9 mm	1	1RM-9
10 mm	1	1RM-10
11 mm	1	1RM-11
12 mm	1	1RM-12
13 mm	1	1RM-13
14 mm	1	1RM-14
15 mm	1	1RM-15
16 mm	1	1RM-16
17 mm	1	1RM-17
18 mm	1	1RM-18
19 mm	1	1RM-19
21 mm	1	1RM-21
22 mm	1	1RM-22
24 mm	1	1RM-24
27 mm	1	1RM-27
30 mm	1	1RM-30
32 mm	1	1RM-32

Imperial Combination Ratcheting Wrenches with Chrome Finish



1RZ



1/4 in	1	1RZ-1/4
5/16 in	1	1RZ-5/16
11/32 in	1	1RZ-11/32
3/8 in	1	1RZ-3/8
7/16 in	1	1RZ-7/16
1/2 in	1	1RZ-1/2
9/16 in	1	1RZ-9/16
5/8 in	1	1RZ-5/8
11/16 in	1	1RZ-11/16
3/4 in	1	1RZ-3/4
7/8 in	1	1RZ-7/8
15/16 in	1	1RZ-15/16

Metric Stubby Combination Ratcheting Wrenches with Chrome Finish



10RM



8 mm	1	10RM-8
10 mm	1	10RM-10
13 mm	1	10RM-13
14 mm	1	10RM-14
17 mm	1	10RM-17
19 mm	1	10RM-19

Imperial Stubby Combination Ratcheting Wrenches with Chrome Finish



10RZ



5/16 in	1	10RZ-5/16
3/8 in	1	10RZ-3/8
7/16 in	1	10RZ-7/16



1/2 in	1	10RZ-1/2
9/16 in	1	10RZ-9/16
5/8 in	1	10RZ-5/8
11/16 in	1	10RZ-11/16
3/4 in	1	10RZ-3/4

Metric Swivel Head Combination Ratcheting Wrenches with Chrome Finish



41RM



8 mm	1	41RM-8
10 mm	1	41RM-10
11 mm	1	41RM-11
12 mm	1	41RM-12
13 mm	1	41RM-13
14 mm	1	41RM-14
17 mm	1	41RM-17
19 mm	1	41RM-19
21 mm	1	41RM-21

Imperial Swivel Head Combination Ratcheting Wrenches with Chrome Finish



41RZ



5/16 in	1	41RZ-5/16
3/8 in	1	41RZ-3/8
7/16 in	1	41RZ-7/16
1/2 in	1	41RZ-1/2
9/16 in	1	41RZ-9/16
5/8 in	1	41RZ-5/8
11/16 in	1	41RZ-11/16
3/4 in	1	41RZ-3/4
13/16 in	1	41RZ-13/16
7/8 in	1	41RZ-7/8



Metric Combination Ratcheting Wrench Set - 6 Pcs/Plastic Holder



1RM/



6

1 1RM/SH6

1RM-8, 1RM-10, 1RM-12, 1RM-13, 1RM-14, 1RM-17



Metric Combination Ratcheting Wrench Set - 5 Pcs/Plastic Box



1RM/S5



5

10 1RM/S5

1RM-8, 1RM-10, 1RM-13, 1RM-17, 1RM-19



Stubby Combination Ratcheting Wrench Set



10RM/



6

1 10RM/SH6

10RM-8, 10RM-10, 10RM-13, 10RM-14, 10RM-17, 10RM-19



Metric Combination Ratcheting Wrench Set - 8 Pcs/Plastic Holder



1RM/SH8



8

1 1RM/SH8

1RM-8, 1RM-10, 1RM-11, 1RM-12, 1RM-13, 1RM-14, 1RM-17, 1RM-19



Imperial Combination Ratcheting Wrench Set Plastic Holder



1RZ/



8

1 1RZ/SH8

1RZ-5/16, 1RZ-3/8, 1RZ-7/16, 1RZ-1/2, 1RZ-9/16, 1RZ-5/8, 1RZ-11/16, 1RZ-3/4



Metric Swivel Head Combination Ratcheting Wrench Set Plastic Holder



41RM/SH8



8

10 41RM/SH8

41RM-8, 41RM-10, 41RM-11, 41RM-12, 41RM-13, 41RM-14, 41RM-17, 41RM-19



Metric Combination Ratcheting Wrench Set - 12 Pcs/Plastic Holder



1RM/SH12



12

10 1RM/SH12

1RM-8, 1RM-9, 1RM-10, 1RM-11, 1RM-12, 1RM-13, 1RM-14, 1RM-15, 1RM-16, 1RM-17, 1RM-18, 1RM-19



Combination Ratcheting Wrench and Adaptors Set



1RMA/S8



160 x 283 x 75 mm

1 1RMA/S8

1RMA-13-3/8-SQ, 1RMA-10-1/4-SQ, 1RMA-19-1/2-SQ



1RMA-13-5/16-BIT, 1RMA-10-1/4-BIT 1RM-13, 1RM-10, 1RM-19



Ratcheting Adjustable Ring Wrench Set



42RM/S12



g



229 x 70 x 280 mm 1562 g

1 42RM/S12

72 teeth / 5° action angle ratchet with 12 faced inserts

Metric Ratcheting Ring Wrenches with Chrome Finish



1320RM

6-7 mm	1	1320RM-6-7
8-9 mm	1	1320RM-8-9
10-11 mm	1	1320RM-10-11
12-13 mm	1	1320RM-12-13
14-15 mm	1	1320RM-14-15
16-17 mm	1	1320RM-16-17
17-19 mm	1	1320RM-17-19
18-19 mm	1	1320RM-18-19
22-24 mm	1	1320RM-22-24

S Type Ratcheting Ring Wrenches with Chrome Finish



1320SRM

14-19 mm	1	1320SRM-14-19

4-in-1 Ratcheting Ring Wrenches with Chrome Finish



S4RM

4x5 6x7 mm	1	S4RM-4-7
8x9 10x11 mm	1	S4RM-8-11
12x13 14x15 mm	1	S4RM-12-15
16x17 18x19 mm	1	S4RM-16-19
20x21 24x27 mm	1	S4RM-21-27
30x32 34x36 mm	1	S4RM-30-36

Imperial Ratcheting Ring Wrenches with Chrome Finish



1320RZ

1/4-5/16" in	1	1320RZ-1/4-5/16
5/16-11/32 in	60	1320RZ-5/16-11/32
3/8-7/16" in	1	1320RZ-3/8-7/16
1/2-9/16" in	1	1320RZ-1/2-9/16
5/8-11/16" in	1	1320RZ-5/8-11/16
3/4-13/16" in	1	1320RZ-3/4-13/16
3/4-7/8" in	1	1320RZ-3/4-7/8
7/8-15/16" in	1	1320RZ-7/8-15/16

Metric Ratcheting Ring Wrench Set



1320RM/

8	1	1320RM/SH8

1320RM-6-7, 1320RM-8-9, 1320RM-10-11, 1320RM-12-13, 1320RM-14-15, 1320RM-16-17, 1320RM-18-19, 1320RM-22-24

4-in-1 Ratcheting Ring Wrench Set - 3 Pcs/Pouch



S4RM/

3	20	S4RM/3T

S4RM-8-11, S4RM-12-15, S4RM-16-19

Imperial Angled Head Ratcheting Ring Wrenches with Chrome Finish



1321RZ

3/8-7/16 in	1	1321RZ-3/8-7/16
1/2-9/16 in	1	1321RZ-1/2-9/16
5/8-11/16 in	1	1321RZ-5/8-11/16
3/4x7/8 in	1	1321RZ-3/4-7/8

S Type Ratcheting Ring Wrench and Adaptor Set



1320SRM/

29	1	1320SRM/S29

1320SRM-14-19
1RMA-19-1/4-SQ
SBS19-TH22

4-in-1 Ratcheting Ring Wrench Set - 4 Pcs/Pouch



S4RM/4T

4	1	S4RM/4T

S4RM-8-11, S4RM-12-15, S4RM-16-19, S4RM-21-27



4-in-1 Ratcheting Ring Wrench Set - 5 Pcs/Pouch



S4RM/5T



5 1 S4RM/5T

S4RM-8-11, S4RM-12-15, S4RM-16-19, S4RM-21-27, S4RM-30-36



Drive Socket and Bit Adaptors for Ratcheting Wrenches



1RMA-SQ

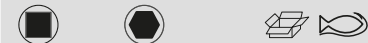

1/4 in	10 mm	1	1RMA-10-1/4-SQ
3/8 in	13 mm	1	1RMA-13-3/8-SQ
1/2 in	19 mm	1	1RMA-19-1/2-SQ
1/4 in	19 mm	1	1RMA-19-1/4-SQ

Ratcheting Wrenches Adaptors for 1/4" and 5/16" Bits



1RMA-BIT

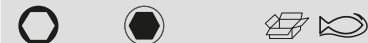

1/4	10 mm	1	1RMA-10-1/4-BIT
5/16	13 mm	1	1RMA-13-5/16-BIT
10	13 mm	1	1RMA-13-10-BIT

Ratcheting Wrench Adaptor Set



1RMA/S4



84 x 100 x 35 mm 1 1RMA/S4

1RMA-10-1/4-SQ, 1RMA-19-1/2-SQ, 1RMA-13-3/8-SQ



1RMA-10-1/4-BIT



OPEN END WRENCHES

Metric Double Open End Wrenches with Chrome Finish



6M

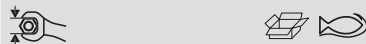

4x5 mm	10	6M-4-5
4.5x5.5 mm	10	6M-4.5-5.5
5x5.5 mm	10	6M-5-5.5
5.5x7 mm	10	6M-5.5-7
6x7 mm	10	6M-6-7
7x8 mm	10	6M-7-8
8x9 mm	10	6M-8-9
8x10 mm	10	6M-8-10
10x11 mm	10	6M-10-11
10x13 mm	10	6M-10-13
12x13 mm	10	6M-12-13
12x14 mm	10	6M-12-14
13x14 mm	10	6M-13-14
13x15 mm	10	6M-13-15
13x16 mm	10	6M-13-16
13x17 mm	10	6M-13-17
14x15 mm	10	6M-14-15
14x17 mm	10	6M-14-17
16x17 mm	10	6M-16-17
16x18 mm	10	6M-16-18
17x19 mm	10	6M-17-19
18x19 mm	10	6M-18-19
19x22 mm	10	6M-19-22
19x24 mm	10	6M-19-24
20x22 mm	10	6M-20-22
21x23 mm	10	6M-21-23
21x24 mm	10	6M-21-24
22x24 mm	10	6M-22-24

Imperial Double Open End Wrenches with Chrome Finish



6Z

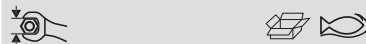

1/4x5/16 in	5	6Z-1/4-5/16
5/16x11/32 in	5	6Z-5/16-11/32
3/8x7/16 in	5	6Z-3/8-7/16
7/16x1/2 in	5	6Z-7/16-1/2
1/2x9/16 in	5	6Z-1/2-9/16
9/16x5/8 in	5	6Z-9/16-5/8
19/32x11/16 in	5	6Z-19/32-11/16
5/8x3/4 in	5	6Z-5/8-3/4
11/16x3/4 in	5	6Z-11/16-3/4
3/4x7/8 in	5	6Z-3/4-7/8
25/32x13/16 in	5	6Z-25/32-13/16
13/16x7/8 in	5	6Z-13/16-7/8
7/8x15/16 in	5	6Z-7/8-15/16
15/16x1 in	5	6Z-15/16-1
1x1.1/8 in	1	6Z-1-1.1/8
1.1/16x1.1/4 in	1	6Z-1.1/16-1.1/4
1.1/4x1.3/8 in	1	6Z-1.1/4-1.3/8

Metric Lilliput Double Open End Wrenches with Chrome Finish



1931M

Size	Part No.
4 mm	5 1931M-4
4.5 mm	5 1931M-4.5
5 mm	5 1931M-5
5.5 mm	5 1931M-5.5
6 mm	5 1931M-6
7 mm	5 1931M-7
8 mm	5 1931M-8
9 mm	5 1931M-9
10 mm	5 1931M-10
11 mm	5 1931M-11
12 mm	5 1931M-12
13 mm	5 1931M-13
14 mm	5 1931M-14
17 mm	5 1931M-17

Imperial Lilliput Double Open End Wrenches with Chrome Finish



1931Z

Size	Length	Part No.
1/8 in	74 mm	5 1931Z-1/8
5/32 in	80 mm	5 1931Z-5/32
3/16 in	80 mm	5 1931Z-3/16
13/64 in	80 mm	5 1931Z-13/64
7/32 in	80 mm	5 1931Z-7/32
15/64x1/4 in	84 mm	5 1931Z-15/64-1/4
1/4 in	80 mm	5 1931Z-1/4
9/32 in	90 mm	5 1931Z-9/32
9/32x5/16 in	94 mm	5 1931Z-9/32-5/16
5/16 in	90 mm	5 1931Z-5/16
11/32 in	105 mm	5 1931Z-11/32
11/32x3/8 in	94 mm	5 1931Z-11/32-3/8
3/8 in	105 mm	5 1931Z-3/8
7/16 in	120 mm	5 1931Z-7/16
1/2 in	120 mm	5 1931Z-1/2
9/16 in	130 mm	5 1931Z-9/16
5/8 in	130 mm	5 1931Z-5/8

Metric Double Open End Wrenches with Phosphate Finish



895M

Size	Length	Part No.
6x7 mm	96 mm	10 895M-6-7
8x9 mm	109 mm	10 895M-8-9
8x10 mm	115 mm	10 895M-8-10
10x11 mm	124 mm	10 895M-10-11
10x13 mm	110 mm	10 895M-10-13
13x17 mm	155 mm	10 895M-13-17
17x19 mm	172 mm	10 895M-17-19
19x22 mm	195 mm	10 895M-19-22
19x24 mm	206 mm	5 895M-19-24
22x24 mm	220 mm	5 895M-22-24
24x27 mm	244 mm	5 895M-24-27
24x30 mm	265 mm	5 895M-24-30
27x32 mm	270 mm	5 895M-27-32
30x32 mm	275 mm	5 895M-30-32
30x36 mm	305 mm	1 895M-30-36
32x36 mm	307 mm	1 895M-32-36
36x41 mm	345 mm	1 895M-36-41
41x46 mm	381 mm	1 895M-41-46
46x50 mm	420 mm	1 895M-46-50
50x55 mm	460 mm	1 895M-50-55
55x60 mm	500 mm	1 895M-55-60
65x70 mm	580 mm	1 895M-65-70

Metric Double Open End Wrench Set - 8 Pcs/Plastic Holder



6M/SH

Part No.	Quantity
6M-6-7, 6M-8-9, 6M-10-11, 6M-12-13, 6M-14-15, 6M-16-17, 6M-18-19, 6M-20-22	8
6M/SH8	1

Metric Double Open End Wrench Set - 12 Pcs/Plastic Holder



6M/SH12

Part No.	Quantity
6M-6-7, 6M-8-9, 6M-10-11, 6M-12-13, 6M-14-15, 6M-16-17, 6M-18-19, 6M-20-22, 6M-21-23, 6M-24-26, 6M-25-28, 6M-30-32	12
6M/SH12	1

Metric Double Open End Wrench Set - 8 Pcs/Box



6M/S

Part No.	Quantity
6M-6-7, 6M-8-9, 6M-10-11, 6M-12-13, 6M-14-15, 6M-16-17, 6M-18-19, 6M-20-22	8
6M/S8	1

Metric Double Open End Wrench Set - 6 Pcs/Plastic Clip



6M/

Part No.	Quantity
6M-6-7, 6M-8-9, 6M-10-11, 6M-12-13, 6M-14-15, 6M-16-17	6
6M/6C	1



Metric Double Open End Wrench Set - 8 Pcs/Plastic Clip



6M/8C



8



1 6M/8C

6M-6-7, 6M-8-9, 6M-10-11, 6M-12-13, 6M-14-15, 6M-16-17, 6M-18-19, 6M-20-22



Metric Double Open End Wrench Set - 10 Pcs/Plastic Clip



6M/10C



10



1 6M/10C

6M-6-7, 6M-8-9, 6M-10-11, 6M-12-13, 6M-14-15, 6M-16-17, 6M-18-19, 6M-20-22, 6M-24-27, 6M-30-32



Metric Double Open End Wrench Set - 12 Pcs/Plastic Clip



6M/12C



12



1 6M/12C

6M-6-7, 6M-8-9, 6M-10-11, 6M-12-13, 6M-14-15, 6M-16-17, 6M-18-19, 6M-20-22, 6M-21-23, 6M-24-27, 6M-25-28, 6M-30-32



Imperial Double Open End Wrench Set



6Z/



8



1 6Z/8C

6Z-1/4-5/16, 6Z-3/8-7/16, 6Z-5/16-11/32, 6Z-1/2-9/16, 6Z-19/32-11/16, 6Z-5/8-3/4, 6Z-13/16-7/8, 6Z-15/16-1



Metric Lilliput Double Open End Wrench Set



1931M/



10



1 1931M/10T

1931M-4, 1931M-4.5, 1931M-5, 1931M-5.5, 1931M-6, 1931M-7, 1931M-8, 1931M-9, 1931M-10, 1931M-11



Imperial Lilliput Double Open End Wrench Set



1931Z/



12



1 1931Z/12T

1931Z-5/32, 1931Z-9/32, 1931Z-5/16, 1931Z-11/32, 1931Z-3/8, 1931Z-3/16, 1931Z-7/32, 1931Z-1/4, 1931Z-7/16, 1931Z-1/2, 1931Z-5/8, 1931Z-9/16



Metric Electronic Double Open End Wrench Set



1933M/



6



1 1933M/6T

4x4, 4.5x4.5, 5x5, 5.5x5.5, 6x6, 7x7



Metric Double Open End Magneto Wrench Set on Ring



3280M/



8



1 3280M

4, 4.5, 5, 5.5, 6, 6.5, 7, 7.5 mm

1/4" Square Drive Crowfoot Open End Wrenches



677-

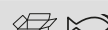

7 mm	1/4 in	1	677-7
8 mm	1/4 in	1	677-8
9 mm	1/4 in	1	677-9
10 mm	1/4 in	1	677-10
13 mm	1/4 in	1	677-13
3/8 in	1/4 in	1	677-3/8

3/8" Square Drive Crowfoot Open End Wrenches



747-



Size	Size	Quantity	Part Number
10 mm	3/8 in	1	747-10
11 mm	3/8 in	1	747-11
12 mm	3/8 in	1	747-12
13 mm	3/8 in	1	747-13
14 mm	3/8 in	1	747-14
15 mm	3/8 in	1	747-15
16 mm	3/8 in	1	747-16
17 mm	3/8 in	1	747-17
18 mm	3/8 in	1	747-18
19 mm	3/8 in	1	747-19
20 mm	3/8 in	1	747-20
21 mm	3/8 in	1	747-21
22 mm	3/8 in	1	747-22
23 mm	3/8 in	1	747-23
24 mm	3/8 in	1	747-24
25 mm	3/8 in	1	747-25
26 mm	3/8 in	1	747-26
27 mm	3/8 in	1	747-27
28 mm	3/8 in	1	747-28
30 mm	3/8 in	1	747-30
32 mm	3/8 in	1	747-32
34 mm	3/8 in	1	747-34
36 mm	3/8 in	1	747-36
40 mm	3/8 in	1	747-40
41 mm	3/8 in	1	747-41
42 mm	3/8 in	1	747-42
46 mm	3/8 in	1	747-46
50 mm	3/8 in	1	747-50
3/8 in	3/8 in	1	747-3/8
7/16 in	3/8 in	1	747-7/16
1/2 in	3/8 in	1	747-1/2
9/16 in	3/8 in	1	747-9/16
5/8 in	3/8 in	1	747-5/8
11/16 in	3/8 in	1	747-11/16
3/4 in	3/8 in	1	747-3/4
13/16 in	3/8 in	1	747-13/16
7/8 in	3/8 in	1	747-7/8
15/16 in	3/8 in	1	747-15/16
1 in	3/8 in	1	747-1
1.1/16 in	3/8 in	1	747-1.1/16
1.1/8 in	3/8 in	1	747-1.1/8
1.3/16 in	3/8 in	1	747-1.3/16
1.1/4 in	3/8 in	1	747-1.1/4
1.5/16 in	3/8 in	1	747-1.5/16
1.3/8 in	3/8 in	1	747-1.3/8
1.7/16 in	3/8 in	1	747-1.7/16
1.1/2 in	3/8 in	1	747-1.1/2
1.9/16 in	3/8 in	1	747-1.9/16
1.5/8 in	3/8 in	1	747-1.5/8
1.11/16 in	3/8 in	1	747-1.11/16
1.3/4 in	3/8 in	1	747-1.3/4
1.13/16 in	3/8 in	1	747-1.13/16
1.7/8 in	3/8 in	1	747-1.7/8
1.15/16 in	3/8 in	1	747-1.15/16
2 in	3/8 in	1	747-2
2.1/16 in	3/8 in	1	747-2.1/16
2.1/8 in	3/8 in	1	747-2.1/8

Size	Size	Quantity	Part Number
2.3/16 in	3/8 in	1	747-2.3/16
2.1/4 in	3/8 in	1	747-2.1/4
2.5/16 in	3/8 in	1	747-2.5/16
2.3/8 in	3/8 in	1	747-2.3/8
2.7/16 in	3/8 in	1	747-2.7/16
2.1/2 in	3/8 in	1	747-2.1/2
2.9/16 in	3/8 in	1	747-2.9/16
2.5/8 in	3/8 in	1	747-2.5/8
2.3/4 in	3/8 in	1	747-2.3/4
2.7/8 in	3/8 in	1	747-2.7/8

1/2" Square Drive Crowfoot Open End Wrenches



787-



Size	Size	Quantity	Part Number
1.1/16 in	1/2 in	1	787-1.1/16
1.1/8 in	1/2 in	1	787-1.1/8
1.3/16 in	1/2 in	1	787-1.3/16
1.1/4 in	1/2 in	1	787-1.1/4
1.5/16 in	1/2 in	1	787-1.5/16
1.3/8 in	1/2 in	1	787-1.3/8
1.7/16 in	1/2 in	1	787-1.7/16
1.1/2 in	1/2 in	1	787-1.1/2
1.5/8 in	1/2 in	1	787-1.5/8
1.11/16 in	1/2 in	1	787-1.11/16
1.3/4 in	1/2 in	1	787-1.3/4
1.13/16 in	1/2 in	1	787-1.13/16
1.7/8 in	1/2 in	1	787-1.7/8
2 in	1/2 in	1	787-2
2.1/8 in	1/2 in	1	787-2.1/8
2.3/16 in	1/2 in	1	787-2.3/16
2.1/4 in	1/2 in	1	787-2.1/4
2.3/8 in	1/2 in	1	787-2.3/8

Metric Single Open End Wrenches with Phosphate Finish



894M



Size	Size	Quantity	Part Number
7 mm	78 mm	10	894M-7
8 mm	94 mm	10	894M-8
9 mm	100 mm	10	894M-9
10 mm	106 mm	10	894M-10

Size	Size	Quantity	Part Number
11 mm	112 mm	10	894M-11
12 mm	125 mm	10	894M-12
13 mm	125 mm	10	894M-13
14 mm	140 mm	10	894M-14
15 mm	140 mm	10	894M-15
16 mm	140 mm	10	894M-16
17 mm	158 mm	10	894M-17
19 mm	171 mm	10	894M-19
21 mm	195 mm	5	894M-21
22 mm	195 mm	5	894M-22
24 mm	216 mm	5	894M-24
27 mm	240 mm	5	894M-27
30 mm	262 mm	5	894M-30
32 mm	274 mm	5	894M-32
34 mm	274 mm	1	894M-34
36 mm	303 mm	5	894M-36
38 mm	305 mm	1	894M-38
41 mm	343 mm	1	894M-41
46 mm	378 mm	1	894M-46
50 mm	413 mm	1	894M-50
55 mm	457 mm	1	894M-55
60 mm	492 mm	1	894M-60
65 mm	528 mm	1	894M-65
70 mm	573 mm	1	894M-70
75 mm	608 mm	1	894M-75
80 mm	644 mm	1	894M-80
85 mm	690 mm	1	894M-85
90 mm	690 mm	1	894M-90
95 mm	850 mm	1	894M-95
100 mm	1000 mm	1	894M-100
105 mm	1000 mm	1	894M-105
110 mm	1000 mm	1	894M-110
115 mm	1000 mm	1	894M-115
120 mm	1000 mm	1	894M-120
125 mm	1000 mm	1	894M-125
130 mm	1000 mm	1	894M-130
135 mm	1000 mm	1	894M-135

Metric Scaffolding Open End Wrench with Phosphate finish



SC335M



Size	Size	Quantity	Part Number
17 mm	320 mm	1	SC335M-17
19 mm	350 mm	1	SC335M-19
22 mm	350 mm	1	SC335M-22
24 mm	370 mm	1	SC335M-24
27 mm	370 mm	1	SC335M-27
30 mm	400 mm	1	SC335M-30
32 mm	400 mm	1	SC335M-32
36 mm	430 mm	1	SC335M-36
41 mm	470 mm	1	SC335M-41
46 mm	500 mm	1	SC335M-46



RING END WRENCHES

Metric Deep Offset Double Ring End Wrenches with Chrome Finish



2M

Size	Length (mm)	Quantity	Part No.
6x7 mm	165 mm	5	2M-6-7
8x9 mm	180 mm	5	2M-8-9
8x10 mm	180 mm	5	2M-8-10
10x11 mm	190 mm	5	2M-10-11
10x13 mm	190 mm	5	2M-10-13
12x13 mm	210 mm	5	2M-12-13
13x17 mm	243 mm	5	2M-13-17
14x15 mm	226 mm	5	2M-14-15
16x17 mm	246 mm	5	2M-16-17
16x18 mm	246 mm	5	2M-16-18
17x19 mm	266 mm	5	2M-17-19
18x19 mm	266 mm	5	2M-18-19
19x22 mm	291 mm	5	2M-19-22
20x22 mm	291 mm	5	2M-20-22
21x23 mm	306 mm	5	2M-21-23
22x24 mm	306 mm	5	2M-22-24
24x26 mm	326 mm	5	2M-24-26
24x27 mm	326 mm	5	2M-24-27
25x28 mm	336 mm	5	2M-25-28
27x29 mm	351 mm	5	2M-27-29
27x30 mm	351 mm	5	2M-27-30
27x32 mm	353 mm	5	2M-27-32
30x32 mm	362 mm	5	2M-30-32
32x36 mm	416 mm	1	2M-32-36
36x41 mm	444 mm	1	2M-36-41
41x46 mm	483 mm	1	2M-41-46
46x50 mm	541 mm	1	2M-46-50

Imperial Deep Offset Double Ring End Wrenches with Chrome Finish



2Z

Size	Length (mm)	Quantity	Part No.
1/4x5/16 in	165 mm	1	2Z-1/4-5/16
5/16x3/8 in	180 mm	1	2Z-5/16-3/8
3/8x7/16 in	190 mm	1	2Z-3/8-7/16
1/2x9/16 in	210 mm	1	2Z-1/2-9/16
9/16x5/8 in	225,8 mm	1	2Z-9/16-5/8

Size	Length (mm)	Quantity	Part No.
5/8x11/16 in	245,5 mm	1	2Z-5/8-11/16
3/4x7/8 in	290,5 mm	1	2Z-3/4-7/8
13/16x7/8 in	290,5 mm	1	2Z-13/16-7/8
15/16x1 in	325,8 mm	1	2Z-15/16-1
1x1 1/8 in	335,9 mm	1	2Z-1-1.1/8
1 1/16x1 1/4 in	353 mm	1	2Z-1.1/16-1.1/4

Imperial Offset Double Ring End Wrenches with Chrome Finish



1300Z

Size	Length (mm)	Quantity	Part No.
1/4x5/16 in	156 mm	1	1300Z-1/4-5/16
3/8x7/16 in	193 mm	1	1300Z-3/8-7/16
19/32x11/16 in	258 mm	1	1300Z-19/32-11/16
5/8x3/4 in	278 mm	1	1300Z-5/8-3/4
25/32x13/16 in	300 mm	1	1300Z-25/32-13/16
7/8x15/16 in	334 mm	1	1300Z-7/8-15/16
15/16x1 in	352 mm	1	1300Z-15/16-1
1x1.1/8 in	380 mm	1	1300Z-1-1.1/8

Metric Deep Offset Double Ring End Wrench Set - 8 Pcs/Box



2M/S

Quantity	Part No.
8	2M/S8

2M-6-7, 2M-8-9, 2M-10-11, 2M-12-13, 2M-14-15, 2M-16-17, 2M-18-19, 2M-20-22

Metric Deep Offset Double Ring End Wrench Set - 8 Pcs/Pouch



2M/T

Quantity	Part No.
8	2M/T8

2M-6-7, 2M-8-9, 2M-10-11, 2M-12-13, 2M-14-15, 2M-16-17, 2M-18-19, 2M-20-22

Metric Deep Offset Double Ring End Wrench Set - 10 Pcs/Pouch



2M/10T

Quantity	Part No.
10	2M/10T

2M-6-7, 2M-8-9, 2M-10-11, 2M-12-13, 2M-14-15, 2M-16-17, 2M-18-19, 2M-20-22, 2M-21-23, 2M-24-27

Metric Deep Offset Double Ring End Wrench Set - 12 Pcs/Pouch



2M/12T

Quantity	Part No.
12	2M/12T

2M-6-7, 2M-8-9, 2M-10-11, 2M-12-13, 2M-14-15, 2M-16-17, 2M-18-19, 2M-20-22, 2M-21-23, 2M-24-27, 2M-25-28, 2M-30-32

Imperial Deep Offset Double Ring End Wrench Set Black Plastic Pouch



2Z/T

7	1	2Z/T

2Z-1/4-5/16, 2Z-5/16-3/8, 2Z-3/8-7/16, 2Z-1/2-9/16, 2Z-9/16-5/8, 2Z-5/8-11/16, 2Z-3/4-7/8

Flat Double Ring End Wrenches with Chrome Finish



4M

6x7 mm	95 mm	10	4M-6-7
8x9 mm	110 mm	10	4M-8-9
10x11 mm	125 mm	10	4M-10-11
12x13 mm	140 mm	10	4M-12-13
14x15 mm	155 mm	10	4M-14-15
16x17 mm	170 mm	10	4M-16-17
17x19 mm	170 mm	10	4M-17-19
18x19 mm	185 mm	10	4M-18-19
20x22 mm	205 mm	10	4M-20-22
21x23 mm	225 mm	5	4M-21-23
24x26 mm	250 mm	1	4M-24-26
24x27 mm	255 mm	1	4M-24-27
25x28 mm	275 mm	1	4M-25-28
27x29 mm	275 mm	1	4M-27-29
30x32 mm	300 mm	1	4M-30-32

Imperial Long Type Double Ring End Wrenches



44Z

1/4x5/16 in	197 mm	10	44Z-1/4-5/16
5/16x3/8 in	238 mm	10	44Z-5/16-3/8
3/8x7/16 in	284 mm	10	44Z-3/8-7/16

7/16x1/2 in	326 mm	10	44Z-7/16-1/2
1/2x9/16 in	358 mm	10	44Z-1/2-9/16
5/8x3/4 in	401 mm	5	44Z-5/8-3/4
11/16x3/4 in	401 mm	5	44Z-11/16-3/4
11/16x13/16 in	410 mm	5	44Z-11/16-13/16

Metric Starter and Manifold Flat Half Moon Box Wrenches with Double Ring End



1943M

11x13 mm	150 mm	1	1943M-11-13
13x15 mm	185 mm	1	1943M-13-15
13x17 mm	185 mm	1	1943M-13-17
14x16 mm	185 mm	1	1943M-14-16
14x17 mm	185 mm	1	1943M-14-17
15x17 mm	185 mm	1	1943M-15-17
19x22 mm	235 mm	1	1943M-19-22

Imperial Starter and Manifold Flat Half Moon Box Wrenches with Double Ring End



1943Z

5/16x3/8 in	153 mm	1	1943Z-5/16-3/8
7/16x1/2 in	153 mm	1	1943Z-7/16-1/2
9/16x5/8 in	186 mm	1	1943Z-9/16-5/8
5/8x3/4 in	233 mm	1	1943Z-5/8-3/4
11/16x13/16 in	233 mm	1	1943Z-11/16-13/16

Metric Flat Double Ring End Wrench Set Black Plastic Pouch



4M/T

10	1	4M/10T

4M-6-7, 4M-8-9, 4M-10-11, 4M-12-13, 4M-14-15, 4M-16-17, 4M-18-19, 4M-20-22, 4M-24-27, 4M-30-32

Metric Flat Double Ring End Wrench Set Grey Plastic Clip Pack



4M/C

10	1	4M/10C

4M-6-7, 4M-8-9, 4M-10-11, 4M-12-13, 4M-14-15, 4M-16-17, 4M-18-19, 4M-20-22, 4M-21-23, 4M-24-27

Metric Flat Double Ring End Wrench Set



4M/12C

12	1	4M/12C

4M-6-7, 4M-8-9, 4M-10-11, 4M-12-13, 4M-14-15, 4M-16-17, 4M-18-19, 4M-20-22, 4M-21-23, 4M-24-27, 4M-25-28, 4M-30-32



Metric Flat Double Ring End Wrench Set
Standard Cardboard Box



4M/

8	1	4M/8

4M-6-7, 4M-8-9, 4M-10-11, 4M-12-13,
4M-14-15, 4M-16-17, 4M-18-19, 4M-20-22

FLARE NUT WRENCHES

Metric Double End Offset Flare Nut
Wrenches with Chrome Finish



1949M

8x 9 mm	140 mm	1	1949M-8-9
10x11 mm	150 mm	1	1949M-10-11
10x12 mm	150 mm	1	1949M-10-12
12x13 mm	170 mm	1	1949M-12-13
12x14 mm	170 mm	1	1949M-12-14
14x15 mm	170 mm	1	1949M-14-15
14x17 mm	200 mm	1	1949M-14-17
17x19 mm	210 mm	1	1949M-17-19
19x22 mm	220 mm	1	1949M-19-22
22x24 mm	235 mm	1	1949M-22-24
24x27 mm	255 mm	1	1949M-24-27
30x32 mm	280 mm	1	1949M-30-32

Imperial Double End Offset Flare Nut
Wrenches with Chrome Finish



1949Z

3/8x7/16 in	150 mm	1	1949Z-3/8-7/16
1/2x9/16 in	170 mm	1	1949Z-1/2-9/16
5/8x3/4 in	210 mm	1	1949Z-5/8-3/4

3/4x7/8 in	220 mm	1	1949Z-3/4-7/8
1x1 1/8 in	255 mm	1	1949Z-1-1.1/8

1/4" Square Drive Flare Nut Crowfoot
Wrenches



679-

7 mm	1/4 in	1	679-7
8 mm	1/4 in	1	679-8
9 mm	1/4 in	1	679-9
10 mm	1/4 in	1	679-10
11 mm	1/4 in	1	679-11
12 mm	1/4 in	1	679-12
13 mm	1/4 in	1	679-13
14 mm	1/4 in	1	679-14
3/8 in	1/4 in	1	679-3/8
7/16 in	1/4 in	1	679-7/16
1/2 in	1/4 in	1	679-1/2
9/16 in	1/4 in	1	679-9/16

3/8" Square Drive Flare Nut Crowfoot
Wrenches



749-

15 mm	3/8 in	1	749-15
16 mm	3/8 in	1	749-16
17 mm	3/8 in	1	749-17
18 mm	3/8 in	1	749-18
19 mm	3/8 in	1	749-19
20 mm	3/8 in	1	749-20
21 mm	3/8 in	1	749-21
22 mm	3/8 in	1	749-22
23 mm	3/8 in	1	749-23
24 mm	3/8 in	1	749-24
25 mm	3/8 in	1	749-25
26 mm	3/8 in	1	749-26
27 mm	3/8 in	1	749-27
3/8 in	3/8 in	1	749-3/8
7/16 in	3/8 in	1	749-7/16
1/2 in	3/8 in	1	749-1/2
9/16 in	3/8 in	1	749-9/16
5/8 in	3/8 in	1	749-5/8
11/16 in	3/8 in	1	749-11/16
3/4 in	3/8 in	1	749-3/4
13/16 in	3/8 in	1	749-13/16

7/8 in	3/8 in	1	749-7/8
15/16 in	3/8 in	1	749-15/16
1 in	3/8 in	1	749-1
1.1/16 in	3/8 in	1	749-1.1/16
1.1/8 in	3/8 in	1	749-1.1/8
1.3/16 in	3/8 in	1	749-1.3/16
1.1/4 in	3/8 in	1	749-1.1/4
1.5/16 in	3/8 in	1	749-1.5/16
1.3/8 in	3/8 in	1	749-1.3/8
1.7/16 in	3/8 in	1	749-1.7/16
1.1/2 in	3/8 in	1	749-1.1/2
1.9/16 in	3/8 in	1	749-1.9/16
1.5/8 in	3/8 in	1	749-1.5/8
1.11/16 in	3/8 in	1	749-1.11/16
1.3/4 in	3/8 in	1	749-1.3/4
1.13/16 in	3/8 in	1	749-1.13/16
1.7/8 in	3/8 in	1	749-1.7/8
1.15/16 in	3/8 in	1	749-1.15/16
2 in	3/8 in	1	749-2
2.1/8 in	3/8 in	1	749-2.1/8
2.3/16 in	3/8 in	1	749-2.3/16
2.1/4 in	3/8 in	1	749-2.1/4
2.3/8 in	3/8 in	1	749-2.3/8
2.5/8 in	3/8 in	1	749-2.5/8
2.3/4 in	3/8 in	1	749-2.3/4
3.1/8 in	3/8 in	1	749-3.1/8

1/2" Square Drive Flare Nut Crowfoot
Wrenches



789-

28 mm	1/2 in	1	789-28
30 mm	1/2 in	1	789-30
32 mm	1/2 in	1	789-32
34 mm	1/2 in	1	789-34
36 mm	1/2 in	1	789-36
38 mm	1/2 in	1	789-38
40 mm	1/2 in	1	789-40
41 mm	1/2 in	1	789-41
42 mm	1/2 in	1	789-42
46 mm	1/2 in	1	789-46
50 mm	1/2 in	1	789-50
1.1/8 in	1/2 in	1	789-1.1/8
1.1/4 in	1/2 in	1	789-1.1/4
1.5/16 in	1/2 in	1	789-1.5/16
1.3/8 in	1/2 in	1	789-1.3/8
1.7/16 in	1/2 in	1	789-1.7/16
1.1/2 in	1/2 in	1	789-1.1/2
1.9/16 in	1/2 in	1	789-1.9/16
1.5/8 in	1/2 in	1	789-1.5/8
1.3/4 in	1/2 in	1	789-1.3/4
1.13/16 in	1/2 in	1	789-1.13/16
2 in	1/2 in	1	789-2
2.1/4 in	1/2 in	1	789-2.1/4
2.5/16 in	1/2 in	1	789-2.5/16
2.3/8 in	1/2 in	1	789-2.3/8

3/8" Square Drive Crowfoot Adjustable Wrenches



1950MZ

0-29/0-1.1/8 in	1	1950MZ-3/8

SLOGGING WRENCHES

Metric Ring End Slogging Wrenches



7444SG-M

24 mm	1	7444SG-M-24
27 mm	1	7444SG-M-27
30 mm	1	7444SG-M-30
32 mm	1	7444SG-M-32
34 mm	1	7444SG-M-34
36 mm	1	7444SG-M-36
38 mm	1	7444SG-M-38
41 mm	1	7444SG-M-41
42 mm	1	7444SG-M-42
46 mm	1	7444SG-M-46
50 mm	1	7444SG-M-50
55 mm	1	7444SG-M-55
60 mm	1	7444SG-M-60
65 mm	1	7444SG-M-65
70 mm	1	7444SG-M-70
75 mm	1	7444SG-M-75
80 mm	1	7444SG-M-80
85 mm	1	7444SG-M-85
90 mm	1	7444SG-M-90
95 mm	1	7444SG-M-95
100 mm	1	7444SG-M-100
105 mm	1	7444SG-M-105
110 mm	1	7444SG-M-110
115 mm	1	7444SG-M-115

120 mm	1	7444SG-M-120
125 mm	1	7444SG-M-125
130 mm	1	7444SG-M-130
135 mm	1	7444SG-M-135
140 mm	1	7444SG-M-140
145 mm	1	7444SG-M-145
150 mm	1	7444SG-M-150
155 mm	1	7444SG-M-155
160 mm	1	7444SG-M-160
165 mm	1	7444SG-M-165
170 mm	1	7444SG-M-170
175 mm	1	7444SG-M-175

Imperial Ring End Slogging Wrenches



7444SG-Z

1 1/16 in	1	7444SG-Z-1.1/16
1 1/8 in	1	7444SG-Z-1.1/8
1 3/16 in	1	7444SG-Z-1.3/16
1 1/4 in	1	7444SG-Z-1.1/4
1 5/16 in	1	7444SG-Z-1.5/16
1 3/8 in	1	7444SG-Z-1.3/8
1 7/16 in	1	7444SG-Z-1.7/16
1 1/2 in	1	7444SG-Z-1.1/2
1 5/8 in	1	7444SG-Z-1.5/8
1 11/16 in	1	7444SG-Z-1.11/16
1 3/4 in	1	7444SG-Z-1.3/4
1 13/16 in	1	7444SG-Z-1.13/16
1 7/8 in	1	7444SG-Z-1.7/8
2 in	1	7444SG-Z-2
2 1/16 in	1	7444SG-Z-2.1/16
2 1/8 in	1	7444SG-Z-2.1/8
2 3/16 in	1	7444SG-Z-2.3/16
2 1/4 in	1	7444SG-Z-2.1/4
2 3/8 in	1	7444SG-Z-2.3/8
2 9/16 in	1	7444SG-Z-2.9/16
2 5/8 in	1	7444SG-Z-2.5/8
2 3/4 in	1	7444SG-Z-2.3/4
3 in	1	7444SG-Z-3
3 1/8 in	1	7444SG-Z-3.1/8
3 3/8 in	1	7444SG-Z-3.3/8
3 1/2 in	1	7444SG-Z-3.1/2
3 3/4 in	1	7444SG-Z-3.3/4
3 7/8 in	1	7444SG-Z-3.7/8
4 in	1	7444SG-Z-4
4 1/8 in	1	7444SG-Z-4.1/8
4 1/2 in	1	7444SG-Z-4.1/2

Metric Open End Slogging Wrenches



133SGM

27 mm	1	133SGM-27
30 mm	1	133SGM-30
32 mm	1	133SGM-32
36 mm	1	133SGM-36
41 mm	1	133SGM-41
46 mm	1	133SGM-46
50 mm	1	133SGM-50
55 mm	1	133SGM-55
60 mm	1	133SGM-60
65 mm	1	133SGM-65
70 mm	1	133SGM-70
75 mm	1	133SGM-75
80 mm	1	133SGM-80
85 mm	1	133SGM-85
90 mm	1	133SGM-90
95 mm	1	133SGM-95
100 mm	1	133SGM-100
105 mm	1	133SGM-105
110 mm	1	133SGM-110
115 mm	1	133SGM-115
120 mm	1	133SGM-120

Metric Deep Offset Ring End Slogging Wrenches



315M

27 mm	1	315M-27
30 mm	1	315M-30
32 mm	1	315M-32
36 mm	1	315M-36
41 mm	1	315M-41
46 mm	1	315M-46
50 mm	1	315M-50
55 mm	1	315M-55
60 mm	1	315M-60
65 mm	1	315M-65
70 mm	1	315M-70
75 mm	1	315M-75
80 mm	1	315M-80



Imperial Deep Offset Ring End Slogging Wrenches



315Z

Size	Quantity	Part Number
1.1/16 in	1	315Z-1.1/16
1.1/8 in	1	315Z-1.1/8
1.3/16 in	1	315Z-1.3/16
1.1/4 in	1	315Z-1.1/4
1.5/16 in	1	315Z-1.5/16
1.3/8 in	1	315Z-1.3/8
1.7/16 in	1	315Z-1.7/16
1.1/2 in	1	315Z-1.1/2
1.5/8 in	1	315Z-1.5/8
1.11/16 in	1	315Z-1.11/16
1.3/4 in	1	315Z-1.3/4
1.13/16 in	1	315Z-1.13/16
1.7/8 in	1	315Z-1.7/8
1.15/16 in	1	315Z-1.15/16
2 mm	1	315Z-2
2.1/16 in	1	315Z-2.1/16
2.1/8 in	1	315Z-2.1/8
2.3/16 in	1	315Z-2.3/16
2.1/4 in	1	315Z-2.1/4
2.5/16 in	1	315Z-2.5/16
2.3/8 in	1	315Z-2.3/8
2.1/2 in	1	315Z-2.1/2
2.9/16 in	1	315Z-2.9/16
2.5/8 in	1	315Z-2.5/8
2.3/4 in	1	315Z-2.3/4
2.7/8 in	1	315Z-2.7/8
2.15/16 in	1	315Z-2.15/16
3 mm	1	315Z-3
3.1/8 in	1	315Z-3.1/8

Metric Deep Offset Heavy Duty Ring End Wrenches



310M

Size	Quantity	Part Number
24 mm	1	310M-24
27 mm	1	310M-27
30 mm	1	310M-30
32 mm	1	310M-32
36 mm	1	310M-36
38 mm	1	310M-38
41 mm	1	310M-41
46 mm	1	310M-46

Size	Quantity	Part Number
50 mm	1	310M-50
55 mm	1	310M-55
60 mm	1	310M-60
65 mm	1	310M-65
70 mm	1	310M-70
75 mm	1	310M-75
80 mm	1	310M-80
85 mm	1	310M-85
90 mm	1	310M-90
95 mm	1	310M-95

Extension Tubular Handles for 310M Ring Wrench



R310

Size	Length	Quantity	Part Number
24-30 mm	19 mm	1	R310-0
32-41 mm	22 mm	1	R310-1
46-55 mm	25 mm	1	R310-2
60-95 mm	30 mm	1	R310-3

SOCKET WRENCHES

Metric Double Head Offset Socket Wrenches with 12 x 6-Point Dynamic Drive™



28M

Size	Length	Quantity	Part Number
6 mm	6 mm	5	28M-6
7 mm	7 mm	5	28M-7
8 mm	8 mm	5	28M-8
9 mm	9 mm	5	28M-9
10 mm	10 mm	5	28M-10
11 mm	11 mm	5	28M-11
12 mm	12 mm	5	28M-12
13 mm	13 mm	5	28M-13
14 mm	14 mm	5	28M-14
15 mm	15 mm	5	28M-15
16 mm	16 mm	5	28M-16
17 mm	17 mm	5	28M-17
18 mm	18 mm	3	28M-18
19 mm	19 mm	3	28M-19
20 mm	20 mm	3	28M-20
21 mm	21 mm	3	28M-21
22 mm	22 mm	3	28M-22
23 mm	23 mm	3	28M-23
24 mm	24 mm	3	28M-24
25 mm	25 mm	3	28M-25

Size	Length	Quantity	Part Number
26 mm	26 mm	3	28M-26
27 mm	27 mm	3	28M-27
28 mm	28 mm	1	28M-28
29 mm	29 mm	1	28M-29
30 mm	30 mm	1	28M-30
32 mm	32 mm	1	28M-32
6 mm	6 mm	10	SB28M-6
7 mm	7 mm	10	SB28M-7
8 mm	8 mm	10	SB28M-8
9 mm	9 mm	10	SB28M-9
10 mm	10 mm	10	SB28M-10
11 mm	11 mm	10	SB28M-11
12 mm	12 mm	10	SB28M-12
13 mm	13 mm	10	SB28M-13
14 mm	14 mm	10	SB28M-14
15 mm	15 mm	10	SB28M-15
16 mm	16 mm	5	SB28M-16
17 mm	17 mm	5	SB28M-17
18 mm	18 mm	5	SB28M-18
19 mm	19 mm	5	SB28M-19
20 mm	20 mm	4	SB28M-20
21 mm	21 mm	4	SB28M-21
22 mm	22 mm	4	SB28M-22
23 mm	23 mm	4	SB28M-23
24 mm	24 mm	4	SB28M-24

Metric Double Head Offset Socket Wrenches with 6 x 6-Point Dynamic Drive™



29M

Size	Quantity	Part Number
6 mm	5	29M-6
7 mm	5	29M-7
8 mm	5	29M-8
9 mm	5	29M-9
10 mm	5	29M-10
11 mm	5	29M-11
12 mm	5	29M-12
13 mm	5	29M-13
14 mm	5	29M-14
15 mm	5	29M-15
16 mm	5	29M-16
17 mm	5	29M-17
18 mm	3	29M-18
19 mm	3	29M-19
20 mm	3	29M-20
21 mm	3	29M-21
22 mm	3	29M-22
23 mm	3	29M-23
24 mm	3	29M-24
25 mm	3	29M-25
26 mm	3	29M-26
27 mm	3	29M-27
28 mm	1	29M-28
29 mm	1	29M-29
30 mm	1	29M-30
32 mm	1	29M-32

Metric Double Head Offset Socket Wrench Set with 12 x 6-Point Dynamic-Drive™ - 8 Pcs



28M/



8 1 28M/8

28M-8, 28M-10, 28M-11, 28M-13, 28M-16, 28M-17, 28M-18, 28M-19



Metric Double Head Offset Socket Wrench Set with 12 x 6-Point Dynamic-Drive™ - 11 Pcs



28M/11



11 1 28M/11

28M-8, 28M-9, 28M-10, 28M-11, 28M-13, 28M-12, 28M-14, 28M-15, 28M-17, 28M-19, 28M-22



Metric Double Head Offset Socket Wrench Set with 12 x 6-Point Dynamic-Drive™ - 12 Pcs



28M/12



12 1 28M/12

28M-8, 28M-9, 28M-10, 28M-11, 28M-12, 28M-13, 28M-14, 28M-15, 28M-16, 28M-17, 28M-18, 28M-19



Metric Double Head Offset Socket Wrench Set with 12 x 6-Point Dynamic-Drive™ - 15 Pcs



28M/15



15 1 28M/15

28M-8, 28M-9, 28M-10, 28M-11, 28M-12, 28M-13, 28M-14, 28M-15, 28M-16, 28M-17, 28M-18, 28M-19, 28M-21, 28M-22, 28M-24



Metric Double Head Offset Socket Wrench Set with 6 x 6-Point Dynamic-Drive™ - 8 Pcs



29M/



8 1 29M/8

29M-8, 29M-10, 29M-12, 29M-13, 29M-14, 29M-17, 29M-19, 29M-22



Metric Double Head Offset Socket Wrench Set with 6 x 6-Point Dynamic-Drive™ - 10 Pcs



29M/10



10 1 29M/10

29M-8, 29M-10, 29M-11, 29M-12, 29M-13, 29M-14, 29M-16, 29M-17, 29M-18, 29M-19



Metric Double Head Offset Socket Wrench Set with 6 x 6-Point Dynamic-Drive™ - 14 Pcs



29M/14



14 1 29M/14

29M-11, 29M-12, 29M-13, 29M-14, 29M-8, 29M-9, 29M-10, 29M-16, 29M-17, 29M-21, 29M-22, 29M-19, 29M-24, 29M-23



Metric Tubular Double Head Socket Wrench



1936M

Size	Quantity	Part Number
6x7 mm	50	1936M-6-7
8x9 mm	5	1936M-8-9
8x10 mm	30	1936M-8-10
10x11 mm	25	1936M-10-11
10x13 mm	25	1936M-10-13
12x13 mm	25	1936M-12-13
13x17 mm	20	1936M-13-17
14x15 mm	20	1936M-14-15
14x17 mm	15	1936M-14-17
16x17 mm	15	1936M-16-17
17x19 mm	10	1936M-17-19
18x19 mm	10	1936M-18-19
19x22 mm	8	1936M-19-22
20x22 mm	8	1936M-20-22
21x23 mm	8	1936M-21-23
22x24 mm	5	1936M-22-24
24x26 mm	5	1936M-24-26
24x27 mm	5	1936M-24-27
25x28 mm	5	1936M-25-28
30x32 mm	1	1936M-30-32
30x34 mm	4	1936M-30-34
36x41 mm	4	1936M-36-41
46x50 mm	2	1936M-46-50



Metric Double Head Socket Wrenches with Chrome Finish



27M



6x7 mm	10	27M-6-7
8x9 mm	10	27M-8-9
10x11 mm	10	27M-10-11
12x13 mm	10	27M-12-13
13x17* mm	10	27M-13-17
14x15 mm	10	27M-14-15
16x17* mm	10	27M-16-17
16x18* mm	10	27M-16-18
18x19* mm	10	27M-18-19
20x22* mm	10	27M-20-22
21x23* mm	5	27M-21-23
21x24* mm	5	27M-21-24
24x26* mm	5	27M-24-26
24x27* mm	5	27M-24-27
25x28* mm	5	27M-25-28
27x29* mm	5	27M-27-29
30x32* mm	5	27M-30-32
6x7 mm	10	SB27M-6-7
8x9 mm	10	SB27M-8-9
10x11 mm	10	SB27M-10-11
12x13 mm	10	SB27M-12-13
14x15 mm	10	SB27M-14-15
16x17* mm	10	SB27M-16-17
18x19* mm	10	SB27M-18-19
20x22* mm	10	SB27M-20-22
21x23* mm	5	SB27M-21-23
24x26* mm	5	SB27M-24-26

Sizes marked with * in the table have a hole along the shank

Metric Tubular Double Head Socket Wrench Set with Chrome Finish – 7 Pcs



1936M/



7 1 1936M/7

1936M-8-9, 1936M-10-11, 1936M-12-13, 1936M-14-15, 1936M-16-17, 1936M-18-19, 1936M-20-22

26S-610

Metric Tubular Double Head Socket Wrench Set with Chrome Finish - 12 Pcs



1936M/12



12 1 1936M/12

1936M-6-7, 1936M-8-9, 1936M-10-11, 1936M-12-13, 1936M-14-15, 1936M-16-17, 1936M-18-19, 1936M-20-22, 1936M-21-23, 1936M-24-27, 1936M-25-28, 1936M-30-32

26S-610, 26S-1216, 26S-16

Metric Double Head Socket Wrench Set - 8 Pcs/Plastic Pouch



27M/T



8 1 27M/8T

27M-6-7, 27M-8-9, 27M-10-11, 27M-12-13, 27M-14-15, 27M-16-17, 27M-18-19, 27M-20-22

Metric Double Head Socket Wrench Set - 6 Pcs/Cardboard Box



27M/



6 1 27M/6

27M-6-7, 27M-8-9, 27M-10-11, 27M-12-13, 27M-14-15, 27M-16-17

Metric Double Head Socket Wrench Set - 8 Pcs/Cardboard Box



27M/8



8 1 27M/8

27M-6-7, 27M-8-9, 27M-10-11, 27M-12-13, 27M-14-15, 27M-16-17, 27M-18-19, 27M-20-22

Metric Double Head Socket Wrench Set - 12 Pcs/Plastic Pouch



27M/12T



12 1 27M/12T

27M-6-7, 27M-8-9, 27M-10-11, 27M-12-13, 27M-14-15, 27M-16-17, 27M-18-19, 27M-20-22, 27M-21-23, 27M-24-26, 27M-25-28, 27M-30-32

Metric Double Head Socket Wrench Set - 10 Pcs/Cardboard Box



27M/10



10 1 27M/10

27M-6-7, 27M-8-9, 27M-10-11, 27M-12-13, 27M-14-15, 27M-16-17, 27M-18-19, 27M-20-22, 27M-21-23, 27M-24-26

Metric Double Head Socket Wrench Set - 12 Pcs/Cardboard Box



27M/12

12	1	27M/12

27M-6-7, 27M-8-9, 27M-10-11, 27M-12-13, 27M-14-15, 27M-16-17, 27M-18-19, 27M-20-22, 27M-21-23, 27M-24-26, 27M-25-28, 27M-30-32

Stepped Tommy Bars with Chrome Finish



26S

6 8 10 mm	10	26S-610
12 14 mm	8	26S-1216
16 mm	5	26S-16

Metric Swivel Head Double End Wrenches with Bi-Hex Socket



4040M

6x7 mm	1	4040M-6-7
8x9 mm	1	4040M-8-9
10x11 mm	1	4040M-10-11
10x13 mm	1	4040M-10-13

12x13 mm	1	4040M-12-13
13x17 mm	1	4040M-13-17
14x15 mm	1	4040M-14-15
16x17 mm	1	4040M-16-17
16x18 mm	1	4040M-16-18
17x19 mm	1	4040M-17-19
18x19 mm	1	4040M-18-19
20x22 mm	1	4040M-20-22
21x23 mm	1	4040M-21-23
24x27 mm	1	4040M-24-27

Imperial Swivel Head Double End Wrenches with Bi-Hex Socket



4040Z

3/8x7/16 in	1	4040Z-3/8-7/16
1/2x9/16 in	1	4040Z-1/2-9/16
5/8x11/16 in	1	4040Z-5/8-11/16
5/8x3/4 in	1	4040Z-5/8-3/4
13/16x7/8 in	1	4040Z-13/16-7/8

Metric Double Ended Swivel Head Wrench Set with Bi-Hex Socket



4040M/S6

6	1	4040M/S6

4040M-8-9, 4040M-10-11, 4040M-12-13, 4040M-14-15, 4040M-16-17, 4040M-18-19

Metric Double Ended Swivel Head Wrench Set with Bi-Hex Socket Plastic Wallet



4040M/6T

6	1	4040M/6T

4040M-8-9, 4040M-10-11, 4040M-12-13, 4040M-14-15, 4040M-16-17, 4040M-18-19

MULTIFITTING KEYS

5-in-1 Switch Cabinet Wrenches



MK5

97x25 mm	1	MK5

Square: 5,6,7-8 mm, Triangular: 9 mm Two-way-key: 3-5 mm

9-in-1 Switch Cabinet Wrenches



MK9

95x95 mm	1	MK9

Square: 5,6,7-8,9-10 mm, Triangular: 7,8-9,10-11 mm Two-way-key: 3-5 mm Half-moon: 6 mm



HOOK WRENCHES

Flexible Head Adjustable Hook Wrenches with Chrome Finish



4106



19-50 mm	25	4106-19-50
32-75 mm	25	4106-32-75
50-120 mm	20	4106-50-120
115-165 mm	25	4106-115-165
150-230 mm	8	4106-150-230

Spare Pin for Adjustable Pin Hook Wrenches



40B-SP



40B-19-50	1	40B-19-50-SP
40B-32-75	1	40B-32-75-SP
40B-50-120	1	40B-50-120-SP
40B-115-165	1	40B-115-165-SP

Adjustable Pin Hook Wrenches with Chrome Finish



40B



19-50 mm	25	40B-19-50
32-75 mm	25	40B-32-75
50-120 mm	20	40B-50-120
115-165 mm	25	40B-115-165
150-230 mm	8	40B-150-230

Adjustable Pin Wrenches with Chrome Finish



4307/4310



10-50 mm	1	4307
22-100 mm	1	4310



Sockets & Ratchets



SOCKET SETS

1/4" and 1/2" Square Drive Socket and Deep Socket Set with Metric Hex Profile and Combination Spanner Set



S910



110 x 320 x 375 mm



2 S910

1/4" and 1/2" Square Drive Socket Set with Combination Spanner Set/L-Keys



S106



110 x 430 x 375 mm



2 S106

1/4" and 1/2" Square Drive Socket Set with Metric Hex Profile and Combination Wrench/Bit Set/Pliers



S81MIX



110 x 430 x 375 mm



2 S81MIX

Socket Set with Combination Wrenches, Hex L-Keys and Bits - 95 Pcs



S95



110 x 320 x 375 mm



2 S95

1/4" and 1/2" Square Drive Socket Set with Combination Spanner Set



S103



110 x 375 x 430 mm



2 S103

1/4" and 1/2" Square Drive Socket Set with Metric Hex Profile and Combination Spanner Set



S410



110 x 320 x 375 mm



2 S410

1/4" and 1/2" Square Drive Combination Spanner and Socket Set



S87+7



110 x 430 x 375 mm



2 S87+7

1/4" and 1/2" Square Drive Socket Set with Combination Spanner Set/Socket Drivers



S108



110 x 430 x 375 mm



2 S108

1/4" and 1/2" Square Drive Spanner and Socket Set



S800



110 x 375 x 430 mm



2 S800

1 pce removable three section plastic box with lid

1/4" and 1/2" Square Drive Socket Set with Metric Hex Profile and Slim Head Ratchet - 79 Pcs



SL79



100 x 215 x 370 mm

4 SL79

1/4" and 3/8" Square Drive Socket Set with Metric Hex Profile and Slim Head Ratchet - 91 Pcs



SL91



100 x 215 x 370 mm

4 SL91

1/4" - 3/8" - 1/2" Square Drive Socket Set with Metric Hex Profile with Combination Wrenches Set - 137 Pcs



S137



105 x 370 x 430 mm

2 S137

1/4" and 1/2" Square Drive Socket Set with Metric Hex Profile and Swivel Head Ratchet - 79 Pcs



SW79



100 x 215 x 370 mm

4 SW79

1/4" and 3/8" Square Drive Socket Set with Metric Hex Profile and Swivel Head Ratchet - 91 Pcs



SW91



100 x 215 x 370 mm

4 SW91

1/4" and 1/2" Square Drive Socket and Deep Socket Set with Metric Hex Profile and Combination Spanner Set - 92 Pcs



S910AF



110 x 320 x 370 mm

2 S910AF

1/4" and 1/2" Square Drive Socket Set with Metric Bi-Hex Profile and Slim Head Ratchet



S560



100 x 215 x 375 mm

4 S560

1/4" 3/8" and 1/2" Square Drive Socket Set with Combination Wrenches/Screwdriver Bits



S138



110 x 375 x 430 mm

2 S138

SBS81



SBS61



1/4" Square Drive Deep Socket Set with Metric Hex Profile



S0810L



35 x 85 x 160 mm

20 S0810L



1/4" Square Drive Socket Set with Metric Hex Profile and Screwdriver Bits/Bit Holder



SL25



35 x 85 x 160 mm
55 x 80 x 165 mm

24 SL25
5 SBSL25

1/4" Square Drive Socket Set with Metric Hex Profile and Ratchet



S160



70 x 160 x 280 mm

6 S160

1/4" Square Drive Socket Set with Metric Hex Profile and Slim Head Ratchet - 65 Pcs



SL65



70 x 160 x 280 mm

6 SL65

1/4" Square Drive Socket Set with Metric Hex Profile and Screwdriver Bits



SL24



35 x 85 x 160 mm

1 SL24

1/4" Square Drive Socket Set with Metric Hex Profile and Ratchet/Socket Drivers



S290



70 x 160 x 280 mm

6 S290

1/4" Square Drive Socket Set with Metric Hex Profile and Swivel Head Ratchet - 65 Pcs



SW65



70 x 160 x 280 mm

6 SW65

1/4" Square Drive Socket and Deep Socket Set with Metric Hex Profile and Screwdriver Bits



SL25L



46 x 130 x 195 mm

10 SL25L

1/4" Square Drive Socket Set with Metric Hex Profile and Socket Drivers



S460



100 x 215 x 375 mm

6 S460

1/4" Square Drive Socket Set with Imperial Hex Profile and Screwdriver Bits/Bit Holder



SL25AF



35 x 85 x 165 mm

1 SL25AF

1/4" Square Drive Socket Set with Imperial Hex Profile and Ratchet



S160AF



70 x 160 x 280 mm



6 S160AF

1/4" Square Drive Socket Set with Metric Hex Profile and Pear Head Ratchet



6712R



31 x 110 x 178 mm



1 6712R

6700SM-4, 6700SM-5, 6700SM-5.5, 6700SM-6, 6700SM-7, 6700SM-8, 6700SM-10, 6700SM-11, 6700SM-13

6950

6960, 6962

1/4" Square Drive Socket Set with Metric Hex Profile and Round Head Ratchet



6712RN



31 x 108 x 178 mm



1 6712RN

6700SM-4, 6700SM-5, 6700SM-5.5, 6700SM-6, 6700SM-7, 6700SM-8, 6700SM-10, 6700SM-11, 6700SM-13

6960, 6962

6950RN

1/4" Square Drive Socket Set with Metric Bi-Hex Profile and Pear Head Ratchet



A6716DM



35 x 111 x 223 mm



1 A6716DM

A6700DM-5.5, A6700DM-6, A6700DM-7, A6700DM-8, A6700DM-9, A6700DM-10, A6700DM-11, A6700DM-12, A6700DM-13, A6700DM-14

6956

6962

6966

6954

6950

1/4" Square Drive Socket Set with Metric Hex Profile and Round Head Ratchet/ Extension Bars



6715MGS



34 x 113 x 223 mm



1 6715MGS

SB6700SM-4, 6700SM-4.5, 6700SM-5, 6700SM-5.5, 6700SM-6, 6700SM-7, 6700SM-8, 6700SM-9, 6700SM-10, 6700SM-11, 6700SM-13

6954

6950RN

6956

6966

6962

1/4" Square Drive Socket Set with Metric Hex Profile and Round Head Ratchet/T-Handle



6719MHR



50 x 110 x 220 mm



1 6719MHR

6700SM-4, 6700SM-4.5, 6700SM-5.5, 6700SM-5, 6700SM-6, 6700SM-7, 6700SM-8, 6700SM-9, 6700SM-10, 6700SM-11, 6700SM-12, 6700SM-13, 6700SM-14

6950RN

6960, 6962

6954

6956

6966

1/4" Square Drive Socket Set with Metric Hex Profile and Round Head Ratchet/ Screwdriver Bits/Adaptor



6729MHR



50 x 110 x 220 mm



1 6729MHR

6700SM-4, 6700SM-5, 6700SM-6, 6700SM-7, 6700SM-8, 6700SM-9, 6700SM-10, 6700SM-11, 6700SM-13, 6700SM-14

6950RN

6960, 6962

6966

6956

6973A

59S/PH1, 59S/PH2, 59S/PH3

59S/PZ1, 59S/PZ2, 59S/PZ3

59S/0.6-4.5, 59S/0.8-5.5, 59S/1.2-6.5

59S/H3, 59S/H4, 59S/H5, 59S/H6



1/4" Square Drive Socket Set with Metric Hex Profile and Pear Head Ratchet/ Screwdriver Bits/Adaptor



6729MHP



50 x 110 x 220 mm

1 6729MHP

6700SM-4, 6700SM-5, 6700SM-6, 6700SM-7, 6700SM-8, 6700SM-9, 6700SM-10, 6700SM-11, 6700SM-13, 6700SM-14



- 6950
- 6960, 6962
- 6966
- 6956
- 6973A
- 59S/0.6-4.5, 59S/0.8-5.5, 59S/1.2-6.5
- 59S/PZ1, 59S/PZ2, 59S/PZ3
- 59S/PH1, 59S/PH2, 59S/PH3
- 59S/H3, 59S/H4, 59S/H5, 59S/H6

1/4" Square Drive Socket Set with Metric Bi-Hex Profile and Pear Head Ratchet/ Extension Bars



6717MBP



50 x 110 x 220 mm

1 6717MBP

A6700DM-5, A6700DM-5.5, A6700DM-6, A6700DM-7, A6700DM-8, A6700DM-9, A6700DM-10, A6700DM-11, A6700DM-12, A6700DM-13, A6700DM-14



- 6950
- 6960, 6962
- 6954
- 6966
- 6956

1/4" Square Drive Socket Set with Metric Bi-Hex Profile and Pear Head Ratchet/ Screwdriver Bits



6730MBP



50 x 110 x 220 mm

1 6730MBP

A6700DM-5, A6700DM-5.5, A6700DM-6, A6700DM-7, A6700DM-8, A6700DM-9, A6700DM-10, A6700DM-11, A6700DM-12, A6700DM-13, A6700DM-14



- 6950
- 6960, 6962
- 6954
- 6966
- 6956
- 6973A
- 59S/0.6-4.5, 59S/1.2-6.5, 59S/0.8-5.5
- 59S/PH1, 59S/PH2, 59S/PH3
- 59S/PZ1, 59S/PZ2, 59S/PZ3
- 59S/H3, 59S/H4, 59S/H5, 59S/H6

1/4" Square Drive Socket Set with Metric Hex Profile and Pear Head Ratchet/ Universal Joint



6719SM



41 x 113 x 223 mm

1 6719SM

6700SM-4, 6700SM-4.5, 6700SM-5, 6700SM-5.5, 6700SM-6, 6700SM-7, 6700SM-8, 6700SM-9, 6700SM-10, 6700SM-11, 6700SM-12, 6700SM-13



- 6954
- 6950
- 6956
- 6966
- 6962

1/4" Square Drive Socket Set with Metric Hex Profile and Round Head Ratchet/ Breaker Bar



6715MG



35 x 111 x 223 mm

1 6715MG

6700SM-4, 6700SM-4.5, 6700SM-5, 6700SM-5.5, 6700SM-6, 6700SM-7, 6700SM-8, 6700SM-9, 6700SM-10, 6700SM-11, 6700SM-12, 6700SM-13, 6700SM-14



- 6954
- 6958
- 6956
- 6962, 6960
- 6966
- 6950RN

1/4" Square Drive Socket Set with Metric Hex Profile and Pear Head Ratchet/ Adaptor



6721NM



41 x 113 x 223 mm

1 6721NM

6700SM-4, 6700SM-4.5, 6700SM-5, 6700SM-5.5, 6700SM-6, 6700SM-7, 6700SM-8, 6700SM-9, 6700SM-10, 6700SM-11, 6700SM-12, 6700SM-13, 6700SM-14



- 6954
- 6951
- 6956
- 6950
- 6962, 6960
- 6966
- 6958

1/4" Square Drive Socket Set with Metric Hex Profile and Pear Head Ratchet/Extension Bars



6722M

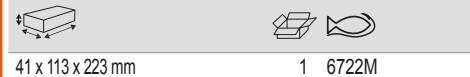

41 x 113 x 223 mm 1 6722M

55M 0.6x4, 1x6, 1x7

6700SM-4, 6700SM-5, 6700SM-6, 6700SM-7, 6700SM-8, 6700SM-9, 6700SM-10, 6700SM-11, 6700SM-13, 6700SM-14		
6954		
6956		
6950		
6966		
6960, 6962		
6972H		
59S/H3, 59S/H4, 59S/H5, 59S/H6		
59S/PH1, 59S/PH2, 59S/PH3		

1/4" Square Drive Socket Set with Metric Hex Profile and Round Head Ratchet/Spinner Handle



6715GE



31 x 113 x 223 mm 1 6715GE

50MH 0.6x4, 1x6, 1x7

6700SM-4, 6700SM-5, 6700SM-6, 6700SM-7, 6700SM-8, 6700SM-9, 6700SM-10, 6700SM-11, 6700SM-13, 6700SM-14		
6956		
6950RN		
6954		
6966		
6960, 6962		
6972H		
59S/H3, 59S/H4, 59S/H5, 59S/H6		
59S/PH1, 59S/PH2, 59S/PH3		

1/4" Square Drive Socket Set with Metric Hex Profile and Pear Head Ratchet/Socket Drivers



6715PZ



41 x 113 x 223 mm 1 6715PZ

6700SM-4, 6700SM-4.5, 6700SM-5, 6700SM-5.5, 6700SM-6, 6700SM-7, 6700SM-8, 6700SM-9, 6700SM-10, 6700SM-11, 6700SM-12, 6700SM-13		
6956		
6950		
6954		
6962, 6960		
6966		
6709F-4.5, 6709F-5.5, 6709F-8		
6709M-3, 6709M-4, 6709M-5, 6709M-6, 6709M-8		
6709PZ-1, 6709PZ-3, 6709PZ-2		

1/4" Square Drive Socket Set with Metric Hex Profile and Pear Head Ratchet/Screwdriver Bits



6715GJ



50 x 113 x 223 mm 1 6715GJ

6700SM-4, 6700SM-4.5, 6700SM-5, 6700SM-5.5, 6700SM-6, 6700SM-7, 6700SM-8, 6700SM-9, 6700SM-10, 6700SM-11, 6700SM-12, 6700SM-13		
6956		
6962, 6960		
6709F-4.5, 6709F-5.5, 6709F-8		
6709M-5, 6709M-6, 6709M-8, 6709M-4, 6709M-3		
6954		
6950		
6966		
6709PH-1, 6709PH-2, 6709PH-3		

1/4" Square Drive Socket Set with Metric Hex Profile and Pear Head Ratchet/Spanner Set



6720NM



43 x 114 x 351 mm 1 6720NM

6700SM-4, 6700SM-4.5, 6700SM-5, 6700SM-5.5, 6700SM-6, 6700SM-7, 6700SM-8, 6700SM-9, 6700SM-10, 6700SM-11, 6700SM-12, 6700SM-13, 6700SM-14		
1931M-4, 1931M-4.5, 1931M-9, 1931M-10, 1931M-11, 1931M-14, 1931M-13, 1931M-12, 1931M-7, 1931M-8, 1931M-6, 1931M-5.5, 1931M-5		
6954		
6950		
6956		
221 D		
73721-3-80		
6966		
6962		

1/4" Square Drive Socket Set with Imperial Bi-Hex Profile and Pear Head Ratchet



A6716DZ



41 x 113 x 223 mm 1 A6716DZ

A6700DZ-3/16, A6700DZ-7/32, A6700DZ-1/4, A6700DZ-9/32, A6700DZ-5/16, A6700DZ-11/32, A6700DZ-3/8, A6700DZ-7/16, A6700DZ-1/2, A6700DZ-9/16		
6956		
6962		
6966		
6954		
6950		



1/4" Socket Set with Imperial Bi-Hex Profile - 18 Pcs



A6718DZ

41 x 113 x 223 mm	1185 g	1	A6718DZ

6950	
6951	
6956	
6954	
6958	
6960, 6962	
6966	
A6700DZ-3/16, A6700DZ-7/32, A6700DZ-1/4, A6700DZ-9/32, A6700DZ-5/16, A6700DZ-11/32, A6700DZ-3/8, A6700DZ-7/16, A6700DZ-1/2, A6700DZ-9/16	

1/4" Square Drive Socket Set with Imperial Hex Profile and Pear Head Ratchet/Breaker Bars



6821NZ

50 x 113 x 223 mm	1	6821NZ

6700SZ-1/4, 6700SZ-11/32, 6700SZ-1/2, 6700SZ-3/16, 6700SZ-5/32, 6700SZ-7/32, 6700SZ-9/32, 6700SZ-5/16, 6700SZ-3/8, 6700SZ-7/16, 6700SZ-9/16	
6954	
6958	
6950	
6956	
6960, 6962	
6966	
6951	

1/4" Square Drive Socket Set with Metric/Imperial Hex Profile and Pear Head Ratchet



6715MZ

40 x 126 x 230 mm	1	6715MZ

6700SM-4, 6700SM-4.5, 6700SM-5, 6700SM-5.5, 6700SM-6, 6700SM-8, 6700SM-9, 6700SM-10, 6700SM-11, 6700SM-13	
6700SZ-7/32, 6700SZ-3/16, 6700SZ-1/4, 6700SZ-9/32, 6700SZ-5/16, 6700SZ-11/32, 6700SZ-3/8, 6700SZ-7/16, 6700SZ-1/2	
6954	
6950	
6956	
6966	
6962	

1/4" Square Drive Socket Set with Metric Hex Profile and Spinner Handle



6729SM

25 x 55 x 190 mm	1	6729SM

6700SM-4, 6700SM-4.5, 6700SM-5, 6700SM-5.5, 6700SM-6, 6700SM-7, 6700SM-8, 6700SM-9, 6700SM-10, 6700SM-11, 6700SM-12, 6700SM-13, 6700SM-14	
6956	

1/4" Square Drive Socket Set with Imperial Hex Profile and Spinner Handle



6729SZ

25 x 55 x 190 mm	1	6729SZ

6700SZ-1/4, 6700SZ-11/32, 6700SZ-1/2, 6700SZ-3/16, 6700SZ-7/32, 6700SZ-3/8, 6700SZ-7/16	
6956	

1/4" Square Drive Socket Set with Metric Hex Profile



6713MH

13	1	6713MH

6700SM-4, 6700SM-4.5, 6700SM-5, 6700SM-5.5, 6700SM-6, 6700SM-7, 6700SM-8, 6700SM-9, 6700SM-10, 6700SM-11, 6700SM-12, 6700SM-13, 6700SM-14	
---	--

1/4" Square Drive Deep Socket Set on Rail with Metric Bi-Hex Profile



6708DMB

8	1	6708DMB

A6800DM-6, A6800DM-7, A6800DM-8, A6800DM-9, A6800DM-10, A6800DM-11, A6800DM-12, A6800DM-13	
--	--

1/4" Square Drive Socket Set with Metric Bi-Hex Profile



6711MB

11 1 6711MB

A6700DM-5, A6700DM-5.5, A6700DM-6, A6700DM-7, A6700DM-8, A6700DM-9, A6700DM-10, A6700DM-11, A6700DM-12, A6700DM-13, A6700DM-14

1/4" Square Drive Socket Set with TORX® Head Screw



6706TE

6 1 6706TE

6700TORX-E4, 6700TORX-E5, 6700TORX-E6, 6700TORX-E7, 6700TORX-E8, 6700TORX-E10

1/4" Square Drive Socket Set with Metric Hex Profile and Refrigeration Ratchet



R6725MK

26 x 105 x 175 mm 1 R6725MK

6700SM-7, 6700SM-8, 6700SM-10

6954

R6967

R6810M-3,4, R6810M-4, R6810M-4,5, R6810M-5, R6810M-6, R6810M-7, R6810M-8, R6810M-9, R6810M-10

6966

R6950

6962

R6964A

1/4" Square Drive Socket Set with Imperial Hex Profile and Refrigeration Ratchet



R6725ZK

48 x 115 x 225 mm 1 R6725ZK

6700SZ-1/4, 6700SZ-5/16, 6700SZ-11/32, 6700SZ-3/8, 6700SZ-7/16, 6700SZ-1/2

6954

R6967

R6950

6962

R6810M-6

R6964A

6966

R6810Z-3/16, R6810Z-7/32, R6810Z-1/4, R6810Z-5/16, R6810Z-3/8

R6822Z

3/8" Square Drive Deep Socket Set



S1214L

49 x 152 x 280 mm 10 S1214L

1/4" and 3/8" Square Drive Socket Set with Metric Hex Profile and Ratchet



S330

70 x 160 x 280 mm 6 S330

1/4" and 3/8" Square Drive Deep Socket Set with Metric Hex Profile and Ratchet



S330L

100 x 215 x 375 mm 4 S330L

3/8" Square Drive Socket Set with Metric/Imperial Hex Profile



S380

100 x 215 x 375 mm 4 S380



3/8" Socket Set - 34 Pcs



SL34



70 x 160 x 280 mm



6 SL34

Pass-Through Socket Set with Flexi Head Ratchet/Extension Bars



S140T



65 x 160 x 280 mm



1 S140T

1 pc pass-through extension bar, 75 mm

SBS19-TH10, SBS19-TH11, SBS19-TH12, SBS19-TH13, SBS19-TH14, SBS19-TH15, SBS19-TH16, SBS19-TH17, SBS19-TH18, SBS19-TH19, SBS19-TH21, SBS19-TH22, SBS19-TH24



Pass-Through Ratchet Set with Hex to Square Drive Adaptors



S140T-R



121 x 280 x 220 mm



10 S140T-R

1RMA-19-1/2-SQ



Pass-Through Socket Set with Flexi Head Ratchet/Adaptors



S530T



90 x 205 x 370 mm



4 S530T

1/4" and 3/8" Square Drive Socket Set with Imperial Hex Profile and Ratchet



S330AF



70 x 160 x 280 mm



6 S330AF

3/8" Square Drive Socket Set with Metric Hex Profile and Round Head Ratchet



7420RE



50 x 115 x 312 mm



1 7420RE

7755-3/8

7400SM-11, 7400SM-10, 7400SM-8, 7400SM-17, 7400SM-18, 7400SM-19, 7400SM-15, 7400SM-14, 7400SM-13, 7400SM-12, 7400SM-16

7761



3/8" Square Drive Socket Set with Metric Hex Profile and Round Head Ratchet/ Breaking Bar



7440ME



57 x 205 x 278 mm



1 7440ME

7400SM-11, 7400SM-10, 7400SM-15, 7400SM-14, 7400SM-13, 7400SM-12, 7400SM-7, 7400SM-6, 7400SM-9, 7400SM-8, 7400SM-17, 7400SM-19

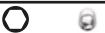

7758

7755-3/8

7761



3/8" Square Drive Socket Set with Metric Hex Profile and Round Head Ratchet/ Wobbler Extension Bar



7430GE



50 x 115 x 312 mm



1 7430GE

7754

7762, 7761

7400SM-7, 7400SM-6, 7400SM-11, 7400SM-10, 7400SM-15, 7400SM-14, 7400SM-13, 7400SM-12, 7400SM-9, 7400SM-8, 7400SM-17, 7400SM-19



7766

7755-3/8



3/8" Square Drive Socket Set with Metric Bi-Hex Profile and Round Head Ratchet/Extension Bars



A7435DME



40 x 150 x 500 mm

1 A7435DME

A7400DM-9, A7400DM-10, A7400DM-11, A7400DM-12, A7400DM-13, A7400DM-14, A7400DM-15, A7400DM-16, A7400DM-17, A7400DM-18, A7400DM-19, A7400DM-20, A7400DM-21, A7400DM-22



7755-3/8



7754



7760, 7762, 7761



7758



7752



7766



3/8" Square Drive Socket Set with Imperial Bi-Hex Profile and Round Head Ratchet



A7440DZE



50 x 115 x 312 mm

1 A7440DZE

A7400DZ-1/4, A7400DZ-5/16, A7400DZ-3/8, A7400DZ-7/16, A7400DZ-1/2, A7400DZ-9/16, A7400DZ-3/4, A7400DZ-13/16, A7400DZ-7/8, A7400DZ-5/8, A7400DZ-11/16



7755-3/8



7758



7761



3/8" Square Drive Socket Set with Metric Bi-Hex Profile and Round Head Ratchet/Breaker Bar



A7440DME



50 x 115 x 312 mm

1 A7440DME

7755-3/8



7758



7761



A7400DM-9, A7400DM-12, A7400DM-13, A7400DM-14, A7400DM-15, A7400DM-16, A7400DM-17, A7400DM-10, A7400DM-11, A7400DM-22, A7400DM-20, A7400DM-21, A7400DM-18, A7400DM-19



3/8" Square Drive Socket Set with Metric Bi-Hex Profile and Round Head Ratchet



7422MBR



60 x 220 x 280 mm

1 7422MBR

A7400DM-6, A7400DM-7, A7400DM-8, A7400DM-9, A7400DM-10, A7400DM-11, A7400DM-12, A7400DM-13, A7400DM-14, A7400DM-15, A7400DM-16, A7400DM-17, A7400DM-18, A7400DM-19, A7400DM-20, A7400DM-21, A7400DM-22



7750RN



7760, 7762



7754



7766



3/8" Square Drive Socket Set with Metric Hex Profile and Round Head Ratchet/T-Handle



7422MHR



50 x 160 x 350 mm

1 7422MHR

7400SM-6, 7400SM-7, 7400SM-8, 7400SM-9, 7400SM-10, 7400SM-11, 7400SM-12, 7400SM-13, 7400SM-14, 7400SM-15, 7400SM-16, 7400SM-17, 7400SM-18, 7400SM-19, 7400SM-20, 7400SM-21, 7400SM-22



7750RN



7760, 7762



7754



7766



3/8" Square Drive Socket Set with Imperial Bi-Hex Profile and Round Head Ratchet/Breaker Bar



A7535DZE



165 x 500 x 45 mm

1 A7535DZE

A7400DZ-1/2, A7400DZ-17/32, A7400DZ-1/4, A7400DZ-3/4, A7400DZ-13/16, A7400DZ-19/32, A7400DZ-11/16, A7400DZ-3/8, A7400DZ-7/16, A7400DZ-5/16, A7400DZ-7/8, A7400DZ-9/16, A7400DZ-5/8



7755-3/8



7754



7760, 7762



7766



7758



7752



3/8" Square Drive Socket Set with Metric Bi-Hex Profile and Round Head Ratchet/Wobbler Extension Bar



7429JDE



38 x 150 x 490 mm

1 7429JDE

A7400DM-6, A7400DM-7, A7400DM-8, A7400DM-9, A7400DM-10, A7400DM-11, A7400DM-12, A7400DM-13, A7400DM-14, A7400DM-15, A7400DM-16, A7400DM-17, A7400DM-18, A7400DM-19, A7400DM-20, A7400DM-21, A7400DM-22

7755-3/8

7754

7760

7757

7407H

7766

7409PH-1, 7409PH-2, 7409PH-3

7409F-6.5, 7409F-8

7409M-3, 7409M-4, 7409M-5, 7409M-6, 7409M-8

3/8" Square Drive Socket Set on Rail with Metric Hex Profile



7400SR/



12 35 x 220 x 25 mm

1 7400SR/S12

7400SM-11, 7400SM-10, 7400SM-15, 7400SM-14, 7400SM-13, 7400SM-12, 7400SM-16, 7400SM-9, 7400SM-8, 7400SM-17, 7400SM-19, 7400SM-18

3/8" Square Drive Socket Set on Rail with Metric Bi-Hex Profile



7409MB



9

1 7409MB

A7400DM-7, A7400DM-8, A7400DM-10, A7400DM-11, A7400DM-13, A7400DM-15, A7400DM-17, A7400DM-19, A7400DM-22

3/8" Square Drive Deep Socket Set on Rail with Metric Bi-Hex Profile



7408MD



8

1 7408MD

A7402DM-10, A7402DM-8, A7402DM-11, A7402DM-12, A7402DM-13, A7402DM-14, A7402DM-17, A7402DM-19

3/8" Square Drive Socket Set for TORX® Head Screw



7400TORX-ER/



7

25 x 55 x 190 mm

1 7400TORX-ER/S7

7400TORX-E14, 7400TORX-E12, 7400TORX-E11, 7400TORX-E10, 7400TORX-E18, 7400TORX-E16, 7400TORX-E8

1/2" Square Drive Deep Socket Set with Metric Hex Profile



S1612L



49 x 152 x 280 mm

4 S1612L

1/2" socket set with Hex bits - 9 Pcs



S9HEX



46 x 130 x 195 mm

10 S9HEX

1/2" socket set with TORX® bits - 9 Pcs



S9TORX



46 x 130 x 195 mm

10 S9TORX

1/2" Socket Set with Hex Bits - 18 Pcs



S18HEX



100 x 210 x 370 mm

4 S18HEX

1/2" Socket Set with TORX® Bits - 18 Pcs



S18TORX



100 x 210 x 370 mm

4 S18TORX

1/2" Square Drive Socket Set with Metric Hex Profile and Ratchet



S240



100 x 215 x 375 mm

4 S240

SBS81



8166



8160-5, 8160-10



7772H



8158-10



7800SM-10, 7800SM-11, 7800SM-12, 7800SM-13, 7800SM-14, 7800SM-15, 7800SM-16, 7800SM-17, 7800SM-18, 7800SM-19, 7800SM-20, 7800SM-21, 7800SM-22, 7800SM-23, 7800SM-24, 7800SM-27, 7800SM-30, 7800SM-32

1/2" Square Drive Socket Set with Metric Hex Profile and Combination Spanner Set



S400



110 x 320 x 375 mm

2 S400

7800SM-10, 7800SM-11, 7800SM-12, 7800SM-13, 7800SM-14, 7800SM-15, 7800SM-16, 7800SM-17, 7800SM-18, 7800SM-19, 7800SM-20, 7800SM-21, 7800SM-22, 7800SM-23, 7800SM-24, 7800SM-25, 7800SM-26, 7800SM-27, 7800SM-28, 7800SM-30, 7800SM-32



SBS81



8160-5, 8160-10



8166



7772H



8158-10



111M-7, 111M-8, 111M-9, 111M-10, 111M-11, 111M-12, 111M-13, 111M-14, 111M-15, 111M-16, 111M-17, 111M-18, 111M-19



1/2" Square Drive Socket Set with Imperial Hex Profile and Ratchet



S240AF



100 x 215 x 375 mm

4 S240AF

SBS81



8166



8160-5, 8160-10



1/2" Sockets inches and Combination Spanners inches set - 35 Pcs



S350AF



110 x 371 x 313 mm

2 S350AF

S 3/8, S 9/16, S 1.1/4, S 1.1/16, S 1.3/16, S 15/16, S 1.1/8, S 1/2, S 1", S 5/8, S 7/8, S 3/4, S 7/16

815



703/A MP



763, 753



773



PU 3/4, PU 7/16, PU 3/8, PU 1/4, PU 9/16, PU 1/2, PU 11/16, PU 5/16



1/2" Square Drive Socket Driver Set for Metric Hex Head Screw



7809M/10



45 x 110 x 255 mm

1 7809M/10

7809M-5, 7809M-6, 7809M-7, 7809M-8, 7809M-9, 7809M-10, 7809M-12, 7809M-14, 7809M-17, 7809M-19



1/2" Square Drive Socket Driver Set for Imperial Hex Head Screw



7809Z/10



45 x 110 x 255 mm

1 7809Z/10

7809Z-3/8, 7809Z-5/16, 7809Z-7/16, 7809Z-1/4, 7809Z-19/32, 7809Z-5/8, 7809Z-17/32, 7809Z-9/16, 7809Z-1/2, 7809Z-3/16



1/2" Square Drive Socket Driver Set for TORX®/Phillips Head Screw



7809TORX/10



45 x 110 x 255 mm

1 7809TORX/10

7809TORX-T20, 7809TORX-T27, 7809TORX-T25, 7809TORX-T40, 7809TORX-T30, 7809TORX-T45, 7809TORX-T50, 7809TORX-T55



7809M-6, 7809M-8



1/2" Square Drive Socket Set with Metric Hex Profile and Round Head Ratchet/Extension Bar



7819SRE



60 x 115 x 280 mm

1 7819SRE

7800SM-17, 7800SM-22, 7800SM-19, 7800SM-24, 7800SM-10, 7800SM-11, 7800SM-12, 7800SM-13



8155-1/2



8160-5



1/2" Square Drive Socket Set with Metric Bi-Hex Profile and Slim Head Ratchet Metal Case



7814DS



60 x 185 x 445 mm

1 7814DS

7800DM-10, 7800DM-11, 7800DM-12, 7800DM-13, 7800DM-14, 7800DM-15, 7800DM-16, 7800DM-17, 7800DM-18, 7800DM-19



8150SL



8160-5, 8160-10



8166



1/2" Square Drive Socket Set with Metric Bi-Hex Profile and Sliding T-Handle Metal Case



7818DS



60 x 185 x 445 mm

1 7818DS

7800DM-8, 7800DM-10, 7800DM-11, 7800DM-12, 7800DM-13, 7800DM-14, 7800DM-15, 7800DM-16, 7800DM-17, 7800DM-18, 7800DM-19, 7800DM-21, 7800DM-22

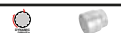

8150SL



8160-5, 8160-10



8154-11



8166



1/2" Square Drive Socket Set with Metric Hex Profile and Round Head Ratchet



7818MHR



50 x 185 x 445 mm

1 7818MHR

7800SM-10, 7800SM-11, 7800SM-12, 7800SM-13, 7800SM-14, 7800SM-15, 7800SM-17, 7800SM-19, 7800SM-22, 7800SM-24, 7800SM-27, 7800SM-30, 7800SM-32



8150RN-1/2



8160-5, 8160-10



8154-11



8166



1/2" Square Drive Socket Set with Metric Hex Profile and Reversible Ratchet/Sliding T-Handle



7825MHP



60 x 185 x 445 mm

1 7825MHP

7800SM-10, 7800SM-11, 7800SM-12, 7800SM-13, 7800SM-14, 7800SM-15, 7800SM-16, 7800SM-17, 7800SM-18, 7800SM-19, 7800SM-20, 7800SM-21, 7800SM-22, 7800SM-23, 7800SM-24, 7800SM-26, 7800SM-27, 7800SM-28, 7800SM-30, 7800SM-32



8150-1/2



8160-5, 8160-10



8154-11



8166



1/2" Square Drive Socket Set with Metric Bi-Hex Profile and Reversible Ratchet/Universal Joint



7825MBP



60 x 185 x 445 mm



1 7825MBP

7800DM-10, 7800DM-11, 7800DM-12, 7800DM-13, 7800DM-14, 7800DM-15, 7800DM-16, 7800DM-17, 7800DM-18, 7800DM-19, 7800DM-20, 7800DM-21, 7800DM-22, 7800DM-23, 7800DM-24, 7800DM-26, 7800DM-27, 7800DM-28, 7800DM-30, 7800DM-32



8150-1/2



8160-5, 8160-10



8154-11



8166



1/2" Square Drive Socket Set with Metric Bi-Hex Profile and Round Head Ratchet



7819DRN



51 x 225 x 445 mm



1 7819DRN

7800DM-19, 7800DM-18, 7800DM-17, 7800DM-16, 7800DM-23, 7800DM-22, 7800DM-21, 7800DM-11, 7800DM-10, 7800DM-15, 7800DM-13, 7800DM-14, 7800DM-12, 7800DM-24, 7800DM-26, 7800DM-27, 7800DM-28, 7800DM-30, 7800DM-32



8150RN-1/2



8152-1/2



8166-1/2



8160-5, 8160-10



8154-11



8166



1/2" Square Drive Socket Set with Metric Bi-Hex Profile and Pear Head Ratchet/Extension Bars



7888DM



73 x 340 x 445 mm



1 7888DM

7800DM-10, 7800DM-11, 7800DM-12, 7800DM-13, 7800DM-14, 7800DM-15, 7800DM-16, 7800DM-17, 7800DM-18, 7800DM-19, 7800DM-20, 7800DM-21, 7800DM-22, 7800DM-23, 7800DM-24, 7800DM-26, 7800DM-27, 7800DM-28, 7800DM-30, 7800DM-32



8150-1/2



8154-11



8160-3, 8160-5, 8160-10



8166



8157-15



1/2" Square Drive Socket and Bit Driver Set with Metric Hex Profile



7823SE



60 x 185 x 445 mm



1 7823SE

7800SM-10, 7800SM-11, 7800SM-12, 7800SM-13, 7800SM-14, 7800SM-15, 7800SM-17, 7800SM-19, 7800SM-22, 7800SM-24, 7800SM-27, 7800SM-30



7809M-5, 7809M-6, 7809M-7, 7809M-8, 7809M-10, 7809M-12, 7809M-14



8155-1/2



8160-10



8154-11



8166



1/4" and 1/2" Square Drive Socket Set with Metric Hex Profile



7847SS



60 x 225 x 445 mm



1 7847SS

6700SM-5, 6700SM-6, 6700SM-7, 6700SM-8, 6700SM-9, 6700SM-10, 6700SM-11, 6700SM-12, 6700SM-13



6950SL



6960, 6962



6954



6966



6956



59S/PH1, 59S/PH2, 59S/PH3



59S/PZ1, 59S/PZ2, 59S/PZ3



59S/0.6-4.5, 59S/0.8-5.5, 59S/1.2-8.0



59S/H3, 59S/H4, 59S/H5, 59S/H6



7800SM-10, 7800SM-11, 7800SM-12, 7800SM-13, 7800SM-14, 7800SM-15, 7800SM-17, 7800SM-19, 7800SM-22, 7800SM-24, 7800SM-27, 7800SM-30, 7800SM-32



8150SL



6973A



8160-5, 8160-10



8154-11



8166



1/2" Square Drive Socket Set with Imperial Bi-Hex Profile and Slim Head Ratchet



7817DZS

60 x 185 x 445 mm 1 7817DZS

7800DZ-3/8, 7800DZ-7/16, 7800DZ-1/2, 7800DZ-9/16, 7800DZ-5/8, 7800DZ-11/16, 7800DZ-3/4, 7800DZ-13/16, 7800DZ-7/8, 7800DZ-15/16, 7800DZ-1, 7800DZ-1.1/8, 7800DZ-1.1/4

8150SL
8160-5, 8160-10
8166

1/2" Square Drive Socket Set with Imperial Bi-Hex Profile and Slim Head Ratchet - 13 Pcs



7817DZS1

60 x 185 x 445 mm 4500 g 1 7817DZS1

7800DZ-3/8, 7800DZ-7/16, 7800DZ-1/2, 7800DZ-9/16, 7800DZ-5/8, 7800DZ-11/16, 7800DZ-3/4, 7800DZ-13/16, 7800DZ-7/8, 7800DZ-15/16, 7800DZ-1, 7800DZ-1.1/8, 7800DZ-1.1/16

8150SL
8160-5, 8160-10
8166

1/2" Square Drive Socket Set with Imperial Bi-Hex Profile and Slim Head Ratchet/ Sliding T-Handle



7823DZS

60 x 185 x 445 mm 1 7823DZS

7800DZ-3/8, 7800DZ-7/16, 7800DZ-1/2, 7800DZ-9/16, 7800DZ-19/32, 7800DZ-5/8, 7800DZ-11/16, 7800DZ-3/4, 7800DZ-25/32, 7800DZ-13/16, 7800DZ-7/8, 7800DZ-15/16, 7800DZ-1, 7800DZ-1.1/16, 7800DZ-1.1/8, 7800DZ-1.3/16, 7800DZ-1.1/4, 7800DZ-1.5/16

8150SL
8160-5, 8160-10
8154-11
8166

1/2" Square Drive Socket Set with Metric Bi-Hex Profile and Slim Head Ratchet Polyester Textile Case



7814DST

60 x 220 x 480 mm 1 7814DST

7800DM-10, 7800DM-11, 7800DM-12, 7800DM-13, 7800DM-14, 7800DM-15, 7800DM-16, 7800DM-17, 7800DM-18, 7800DM-19

8150SL
8160-5, 8160-10
8166

1/2" Square Drive Socket Set with Metric Bi-Hex Profile and Sliding T-Handle Polyester Textile Case



7818DST

60 x 220 x 480 mm 1 7818DST

7800DM-8, 7800DM-10, 7800DM-11, 7800DM-12, 7800DM-13, 7800DM-14, 7800DM-15, 7800DM-16, 7800DM-17, 7800DM-18, 7800DM-19, 7800DM-21, 7800DM-22

8150SL
8160-5, 8160-10
8166
8154-11

1/2" Square Drive Socket Set with Metric Hex Profile and Slim Head Ratchet



7818SST

60 x 220 x 480 mm 1 7818SST

7800SM-10, 7800SM-11, 7800SM-12, 7800SM-13, 7800SM-14, 7800SM-15, 7800SM-17, 7800SM-19, 7800SM-22, 7800SM-24, 7800SM-27, 7800SM-30, 7800SM-32

8150SL
8160-1/2, 8162-1/2, 8166-1/2, 8154-1/2

1/2" Square Drive Socket Set with Metric Hex Profile and Slim Head Ratchet/Universal Joint



7825SST

65 x 250 x 480 mm 1 7825SST

7800SM-10, 7800SM-11, 7800SM-12, 7800SM-13, 7800SM-14, 7800SM-15, 7800SM-16, 7800SM-17, 7800SM-18, 7800SM-19, 7800SM-20, 7800SM-21, 7800SM-22, 7800SM-23, 7800SM-24, 7800SM-26, 7800SM-27, 7800SM-28, 7800SM-30, 7800SM-32

8150SL

8160-1/2, 8162-1/2, 8166-1/2, 8154-1/2

1/2" Square Drive Socket Set with Metric Bi-Hex Profile and Slim Head Ratchet



7825DST

65 x 250 x 480 mm 1 7825DST

7800DM-10, 7800DM-11, 7800DM-12, 7800DM-13, 7800DM-14, 7800DM-15, 7800DM-16, 7800DM-17, 7800DM-18, 7800DM-19, 7800DM-20, 7800DM-21, 7800DM-22, 7800DM-23, 7800DM-24, 7800DM-26, 7800DM-27, 7800DM-28

8150SL

8160-1/2, 8162-1/2, 8166-1/2, 8154-1/2

1/2" Square Drive Socket Set with Metric Bi-Hex Profile and Slim Head Ratchet/Breaker Bar



7827DST

65 x 250 x 480 mm 1 7827DST

7800DM-10, 7800DM-11, 7800DM-12, 7800DM-13, 7800DM-14, 7800DM-15, 7800DM-16, 7800DM-17, 7800DM-18, 7800DM-19, 7800DM-20, 7800DM-21, 7800DM-22, 7800DM-23, 7800DM-24, 7800DM-26, 7800DM-27, 7800DM-28, 7800DM-30, 7800DM-32

8150SL

8159-1/2, 8160-1/2, 8162-1/2, 8154-1/2, 8166-1/2, 8158-1/2

1/2" Square Drive Socket and Bit Driver Set with Metric Bi-Hex Profile



7823DET

60 x 220 x 480 mm 1 7823DET

7800DM-10, 7800DM-11, 7800DM-12, 7800DM-13, 7800DM-14, 7800DM-15, 7800DM-17, 7800DM-19, 7800DM-22, 7800DM-24, 7800DM-27, 7800DM-30

7809M-5, 7809M-6, 7809M-7, 7809M-8, 7809M-10, 7809M-12, 7809M-14

8155-1/2

8162-1/2, 8154-1/2, 8166-1/2

1/2" Square Drive Socket Set on Rail with Metric Hex Profile



7810MH

10 1 7810MH

7800SM-10, 7800SM-11, 7800SM-13, 7800SM-14, 7800SM-15, 7800SM-16, 7800SM-19, 7800SM-17, 7800SM-21, 7800SM-22

1/2" Square Drive Socket Set with Metric Bi-Hex Profile - 10 Pcs/Rail



7810MB

10 1 7810MB

7800DM-11, 7800DM-10, 7800DM-14, 7800DM-13, 7800DM-16, 7800DM-17, 7800DM-19, 7800DM-22, 7800DM-21, 7800DM-15

1/2" Square Drive Socket Set with Metric Bi-Hex Profile - 6 Pcs/Rail



7806MD

6 1 7806MD

7805DM-10, 7805DM-14, 7805DM-13, 7805DM-17, 7805DM-19, 7805DM-22



1/2" Square Drive Socket Set on Rail with TORX® Profile



7807TE



1 7807TE

7

7800TORX-E10, 7800TORX-E12,
7800TORX-E14, 7800TORX-E16,
7800TORX-E18, 7800TORX-E20,
7800TORX-E24



3/4" Square Drive Socket Set with Metric Hex Profile and Ratchet Head



SLX 17



1 SLX 17

375 x 430 x 110 mm

3/4" Square Drive Socket Set with Imperial Hex Profile and Ratchet Head - 17 Pcs



SLX17AF



1 SLX 17AF

70 x 375 x 430 mm

3/4" Square Drive Socket Set with Metric Hex Profile and Round Ratchet Head/ Sliding T-Head



8845NM



1 8845NM

94 x 206 x 591 mm

8900SM-24, 8900SM-22, 8900SM-27,
8900SM-30, 8900SM-32, 8900SM-36,
8900SM-38, 8900SM-41, 8900SM-46,
8900SM-50



8953



8954A



8962, 8961



8950N/A



3/4" Square Drive Socket Set with Metric Bi-Hex Profile and Round Ratchet Head/ Sliding T-Head



8845DM



1 8845DM

94 x 206 x 591 mm

8900DM-19, 8900DM-22, 8900DM-24,
8900DM-27, 8900DM-30, 8900DM-32,
8900DM-36, 8900DM-41, 8900DM-46,
8900DM-50



8950N/A



8953



8954A



8961, 8962



3/4" Square Drive Socket Set with Metric Bi-Hex Profile and Round Ratchet Head



8821MB



1 8821MB

95 x 220 x 600 mm

8950N/A



8954



8965



8966



8961, 8962



8900DM-26, 8900DM-23, 8900DM-22,
8900DM-24, 8900DM-27, 8900DM-29,
8900DM-28, 8900DM-32, 8900DM-30,
8900DM-34, 8900DM-38, 8900DM-35,
8900DM-36, 8900DM-46, 8900DM-41,
8900DM-42, 8900DM-50



3/4" Square Drive Socket Set with Metric Bi-Hex Profile - 24 Pcs



8840M



100 x 210 x 595 mm 1 8840M

8900DM-19, 8900DM-22, 8900DM-24, 8900DM-25, 8900DM-27, 8900DM-28, 8900DM-30, 8900DM-32, 8900DM-36, 8900DM-41, 8900DM-46, 8900DM-50, 8900DM-55, 8900DM-60

- 8953
- 8950N/A
- 8951
- 8954A
- 8958A
- 8962, 8961
- 8966
- 8965
- 8172

1" Square Drive Socket Set with Metric Hex Profile and Round Head Ratchet



9540MB



210 x 560 x 120 mm 1 9540MB

9500SM-80, 9500SM-75, 9500SM-70, 9500SM-65, 9500SM-60, 9500SM-55, 9500SM-50, 9500SM-46

- 9550AB
- 9555
- 9560AB, 9563AB

1" Square Drive Socket Set with Metric Hex Profile and Round Head Ratchet/ Adaptor



9540MBL

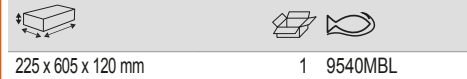

225 x 605 x 120 mm 1 9540MBL

9500SM-80, 9500SM-77, 9500SM-71, 9500SM-70, 9500SM-67, 9500SM-65, 9500SM-63, 9500SM-60, 9500SM-75, 9500SM-46, 9500SM-50, 9500SM-54, 9500SM-55, 9500SM-58

- 9550AB
- 9560AB, 9563AB
- 9555

1" Socket Set with Imperial Bi-Hex Profile - 11 Pcs



9540DZ

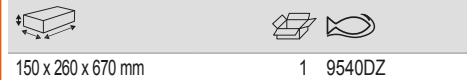

150 x 260 x 670 mm 1 9540DZ

- 9550AB
- 9555
- 9563AB, 9560AB
- 9500DZ-2.3/4, 9500DZ-2.3/8, 9500DZ-2.3/16, 9500DZ-3, 9500DZ-1.13/16, 9500DZ-3.1/8, 9500DZ-2.5/8, 9500DZ-2

1" Socket Set bihexagonal in inches. Metal case



9540DZL



140 x 285 x 630 mm 1 9540DZL

9500DZ-2.1/4, 9500DZ-2.3/4, 9500DZ-2.3/8, 9500DZ-2.1/2, 9500DZ-2.15/16, 9500DZ-2.1/8, 9500DZ-1.7/8, 9500DZ-2.3/16, 9500DZ-3, 9500DZ-1.13/16, 9500DZ-3.1/8, 9500DZ-2.5/8, 9500DZ-2, 9500DZ-2.9/16

- 9550AB
- 9555
- 9563AB, 9560AB
- 9565AB

1/4"

1/4" Square Drive Sockets with Metric Hex Profile and High Polished Finish



6700SM

Size	Quantity	Part Number
4 mm	5	6700SM-4
4.5 mm	5	6700SM-4.5
5 mm	5	6700SM-5
5.5 mm	5	6700SM-5.5
6 mm	5	6700SM-6
7 mm	5	6700SM-7
8 mm	5	6700SM-8
9 mm	5	6700SM-9
10 mm	5	6700SM-10
11 mm	5	6700SM-11
12 mm	5	6700SM-12
13 mm	5	6700SM-13
14 mm	5	6700SM-14
4 mm	1	SB6700SM-4
4.5 mm	1	SB6700SM-4.5
5 mm	1	SB6700SM-5
5.5 mm	1	SB6700SM-5.5
6 mm	1	SB6700SM-6
7 mm	1	SB6700SM-7
8 mm	1	SB6700SM-8
9 mm	1	SB6700SM-9
10 mm	1	SB6700SM-10
11 mm	1	SB6700SM-11
12 mm	1	SB6700SM-12
13 mm	1	SB6700SM-13
14 mm	1	SB6700SM-14

SB: Retail pack on a plastic info card



1/4" Square Drive Sockets with Imperial Hex Profile



6700SZ

Hex Profile	Quantity	Part Number
1/8 in	5	6700SZ-1/8
5/32 in	5	6700SZ-5/32
3/16 in	5	6700SZ-3/16
7/32 in	5	6700SZ-7/32
1/4 in	5	6700SZ-1/4
9/32 in	5	6700SZ-9/32
5/16 in	5	6700SZ-5/16
11/32 in	5	6700SZ-11/32
3/8 in	5	6700SZ-3/8
7/16 in	5	6700SZ-7/16
1/2 in	5	6700SZ-1/2
9/16 in	5	6700SZ-9/16
1/8 in	5	SB6700SZ-1/8
5/32 in	1	SB6700SZ-5/32
3/16 in	1	SB6700SZ-3/16
7/32 in	1	SB6700SZ-7/32
1/4 in	1	SB6700SZ-1/4
9/32 in	1	SB6700SZ-9/32
5/16 in	1	SB6700SZ-5/16
11/32 in	1	SB6700SZ-11/32
3/8 in	1	SB6700SZ-3/8
7/16 in	1	SB6700SZ-7/16
1/2 in	1	SB6700SZ-1/2
9/16 in	1	SB6700SZ-9/16

SB: Retail pack on a plastic info card

1/4" Square Drive Sockets with TORX® Profile



6700TORX-E

TORX Profile	Quantity	Part Number
E4	5	6700TORX-E4
E5	5	6700TORX-E5
E6	5	6700TORX-E6
E7	5	6700TORX-E7
E8	5	6700TORX-E8
E10	5	6700TORX-E10
E4	1	SB6700TORX-E4
E5	1	SB6700TORX-E5
E6	1	SB6700TORX-E6
E7	1	SB6700TORX-E7
E8	1	SB6700TORX-E8
E10	1	SB6700TORX-E10

SB: Retail pack on a plastic info card

1/4" Square Drive Sockets with Metric Square Profile for Refrigeration Ratchet



R6810M

Metric Square Profile	Quantity	Part Number
3.4 mm	5	R6810M-3,4
4 mm	5	R6810M-4
4.5 mm	5	R6810M-4,5
5 mm	5	R6810M-5
6 mm	5	R6810M-6
7 mm	1	R6810M-7
8 mm	5	R6810M-8
9 mm	5	R6810M-9
10 mm	5	R6810M-10

1/4" Square Drive Sockets with Imperial Square Profile for Refrigeration Ratchet



R6810Z

Imperial Square Profile	Quantity	Part Number
3/16 in	1	R6810Z-3/16
7/32 in	1	R6810Z-7/32
1/4 in	1	R6810Z-1/4
5/16 in	1	R6810Z-5/16
3/8 in	1	R6810Z-3/8

1/4" Square Drive Plumbing Adaptor for Refrigeration Ratchet



R6822Z

Quantity	Part Number
5	R6822Z

1/4" Square Drive Female to Female Adaptor



R6967

Quantity	Part Number
5	R6967

1/4" Square Drive Male to Male Adaptor



R6964A

Quantity	Part Number
1	R6964A

1/4" Square Drive Sockets with Metric Bi-Hex Profile



A6700DM

Metric Bi-Hex Profile	Quantity	Part Number
5 mm	5	A6700DM-5
5.5 mm	5	A6700DM-5.5
6 mm	5	A6700DM-6
7 mm	5	A6700DM-7
8 mm	5	A6700DM-8
9 mm	5	A6700DM-9
10 mm	5	A6700DM-10
11 mm	5	A6700DM-11
12 mm	5	A6700DM-12
13 mm	5	A6700DM-13
14 mm	5	A6700DM-14
5 mm	1	SBA6700DM-5
5.5 mm	1	SBA6700DM-5.5
6 mm	1	SBA6700DM-6
7 mm	1	SBA6700DM-7
8 mm	1	SBA6700DM-8

Size	Quantity	Part Number
9 mm	1	SBA6700DM-9
10 mm	1	SBA6700DM-10
11 mm	1	SBA6700DM-11
12 mm	1	SBA6700DM-12
13 mm	1	SBA6700DM-13
14 mm	1	SBA6700DM-14

SB: Retail pack on a plastic info card

1/4" Square Drive Sockets with Imperial Bi-Hex Profile



A6700DZ

Size	Quantity	Part Number
3/16 in	5	A6700DZ-3/16
7/32 in	5	A6700DZ-7/32
1/4 in	5	A6700DZ-1/4
9/32 in	5	A6700DZ-9/32
5/16 in	5	A6700DZ-5/16
11/32 in	5	A6700DZ-11/32
3/8 in	5	A6700DZ-3/8
7/16 in	5	A6700DZ-7/16
1/2 in	5	A6700DZ-1/2
9/16 in	5	A6700DZ-9/16
3/16 in	1	SBA6700DZ-3/16
7/32 in	1	SBA6700DZ-7/32
1/4 in	1	SBA6700DZ-1/4
9/32 in	1	SBA6700DZ-9/32
5/16 in	1	SBA6700DZ-5/16
11/32 in	1	SBA6700DZ-11/32
3/8 in	1	SBA6700DZ-3/8
7/16 in	1	SBA6700DZ-7/16
1/2 in	1	SBA6700DZ-1/2
9/16 in	1	SBA6700DZ-9/16

SB: Retail pack on a plastic info card

1/4" Square Drive Deep Sockets with Metric Bi-Hex Profile



A6800DM

Size	Quantity	Part Number
4 mm	1	A6800DM-4
5 mm	1	A6800DM-5
5.5 mm	1	A6800DM-5.5
6 mm	1	A6800DM-6
7 mm	1	A6800DM-7
8 mm	1	A6800DM-8
9 mm	1	A6800DM-9

Size	Quantity	Part Number
10 mm	1	A6800DM-10
11 mm	1	A6800DM-11
12 mm	1	A6800DM-12
13 mm	1	A6800DM-13
14 mm	1	A6800DM-14

Size	Quantity	Part Number
4 mm	1	SBA6800DM-4
5 mm	1	SBA6800DM-5
5.5 mm	1	SBA6800DM-5.5
6 mm	1	SBA6800DM-6
7 mm	1	SBA6800DM-7
8 mm	1	SBA6800DM-8
9 mm	1	SBA6800DM-9
10 mm	1	SBA6800DM-10
11 mm	1	SBA6800DM-11
12 mm	1	SBA6800DM-12
13 mm	1	SBA6800DM-13
14 mm	1	SBA6800DM-14

SB: Retail pack on a plastic info card

1/4" Square Drive Deep Sockets with Metric Hex Profile



A6800SM

Size	Quantity	Part Number
4 mm	1	A6800SM-4
4.5 mm	1	A6800SM-4.5
5 mm	1	A6800SM-5
6 mm	1	A6800SM-6
7 mm	1	A6800SM-7
8 mm	1	A6800SM-8
9 mm	1	A6800SM-9
10 mm	1	A6800SM-10
11 mm	1	A6800SM-11
12 mm	1	A6800SM-12
13 mm	1	A6800SM-13
14 mm	1	A6800SM-14
15 mm	1	A6800SM-15

SB: Retail pack on a plastic info card

1/4" Square Drive Deep Sockets with Imperial Hex Profile



A6800SZ

Size	Quantity	Part Number
1/8 in	1	A6800SZ-1/8
5/32 in	1	A6800SZ-5/32

1/4" Square Drive Deep Sockets with Imperial Bi-Hex Profile



A6800DZ

Size	Quantity	Part Number
3/16 in	1	A6800DZ-3/16
7/32 in	1	A6800DZ-7/32
1/4 in	1	A6800DZ-1/4
9/32 in	1	A6800DZ-9/32
5/16 in	1	A6800DZ-5/16
11/32 in	1	A6800DZ-11/32
3/8 in	1	A6800DZ-3/8
7/16 in	1	A6800DZ-7/16
1/2 in	1	A6800DZ-1/2
9/16 in	1	A6800DZ-9/16
3/16 in	1	SBA6800DZ-3/16
7/32 in	1	SBA6800DZ-7/32
1/4 in	1	SBA6800DZ-1/4
9/32 in	1	SBA6800DZ-9/32
5/16 in	1	SBA6800DZ-5/16
11/32 in	1	SBA6800DZ-11/32
3/8 in	1	SBA6800DZ-3/8
7/16 in	1	SBA6800DZ-7/16
1/2 in	1	SBA6800DZ-1/2
9/16 in	1	SBA6800DZ-9/16

SB: Retail pack on a plastic info card

1/4" Square Drive Swivel Sockets with Metric Bi-Hex Profile



A6710DM

Size	Quantity	Part Number
5.5 mm	1	A6710DM-5.5
6 mm	1	A6710DM-6
7 mm	1	A6710DM-7
8 mm	1	A6710DM-8
9 mm	1	A6710DM-9
10 mm	1	A6710DM-10
11 mm	1	A6710DM-11
12 mm	1	A6710DM-12
13 mm	1	A6710DM-13
14 mm	1	A6710DM-14



1/4" Square Drive Swivel Sockets with Imperial Bi-Hex Profile



A6710DZ

Length	Quantity	Part Number
3/16 in	1	A6710DZ-3/16
7/32 in	1	A6710DZ-7/32
1/4 in	1	A6710DZ-1/4
9/32 in	1	A6710DZ-9/32
5/16 in	1	A6710DZ-5/16
11/32 in	1	A6710DZ-11/32
3/8 in	1	A6710DZ-3/8
7/16 in	1	A6710DZ-7/16
1/2 in	1	A6710DZ-1/2
9/16 in	1	A6710DZ-9/16

1/4" Square Drive Spinner Handles



6956

Length	Quantity	Part Number
150 mm	10	6956
150 mm	1	SB6956

SB: Retail pack on a plastic info card

1/4" Knurled Extension Bars



696EX

Length	Quantity	Part Number
26 mm	1	696EX-01
152 mm	1	696EX-06
200 mm	1	696EX-08
276 mm	1	696EX-11

1/4" Square Drive Breaker Bars with Swivel Head



6958

Length	Quantity	Part Number
153 mm	1	6958-6
153 mm	1	SB6958-6

SB: Retail pack on a plastic info card

1/4" Square Drive Extension Bars



6960 - 6962L

Length	Quantity	Part Number
50 mm	1	6960
101 mm	1	6961
152 mm	1	6962
355 mm	1	6962L
53 mm	1	SB6960
101 mm	1	SB6961
152 mm	1	SB6962
355 mm	1	SB6962L

1/4" Square Drive Flexible Extension Bars



6963

Length	Quantity	Part Number
148 mm	1	6963
148 mm	1	SB6963

1/4" Square Drive Sliding T-Handles



6954

Length	Quantity	Part Number
125 mm	1	6954
125 mm	10	SB6954

SB: Retail pack on a plastic info card

1/4" Square Drive Wobbler Extension Bars



6960-W - 6962-W

Length	Quantity	Part Number
50 mm	10	6960W-2
100 mm	1	6960W-4
150 mm	10	6960W-6

1/4" Square Drive Universal Joints



6966

Length	Quantity	Part Number
35 mm	10	6966
35 mm	1	SB6966

SB: Retail pack on a plastic info card

1/4" Square Drive Universal Joints for Smooth Operations



6968



35 mm



1 6968

1/4" Square Drive to 3/8" Socket Increasing Adaptors



7765



1/4 3/8 1 7765

1/4 3/8 1 SB7765

1/4" Square Drive to 1/4" Hex Bit Adaptors



6709HL



1/4 in 1 6709HL

1/4" Square Drive Adaptors for Hex Screwdriver Bit



6972H



1/4" in 1/4" 5 6972H

1/4" Square Drive Magnetic Adaptors for 1/4" Hex Screwdriver Bit



6973M



1/4" 1/4" in 1 6973M

1/4" Square Drive Adaptors for 1/4" Hex Screwdriver Bit



6973A



1/4 in 10 6973A

1/4 in 1 SB6973A

SB: retail packed on a plastic info card

1/4" Square Drive to 1/4" Socket Flat Adaptors



6969



1/4 1 6969

1/4" Square Drive to 3/8" Socket Increasing Flat Adaptors



7767



1/4 1 7767

1/4 1 SB7767

SB: Retail pack on a plastic info card

1/4" Square Drive Increasing Flat Adaptor Set



8967/S3



110 x 194 x 30 mm



1 8967/S3

7767

8167

8967



Socket Rails for 1/4" 3/8" and 1/2" Clips



RAIL-187/264/340

187 mm	3 RAIL-187
264 mm	3 RAIL-264
340 mm	3 RAIL-340

Rail-Clips for 1/4" Sockets/Socket Drivers



C1/4

17 mm	25 CLIPS-1/4

1/4" Square Drive Socket Drivers for Slotted Head Screw



6709F

0.6 mm	4.5 mm	5 6709F-4.5
0.8 mm	5.5 mm	5 6709F-5.5
0.9 mm	6.5 mm	5 6709F-6.5
1.2 mm	8 mm	5 6709F-8
0.6 mm	4.5 mm	1 SB6709F-4.5
0.8 mm	5.5 mm	1 SB6709F-5.5
0.9 mm	6.5 mm	1 SB6709F-6.5
1.2 mm	8 mm	1 SB6709F-8

SB: Retail pack on a plastic info card

1/4" Square Drive Socket Drivers for Philips Head Screw



6709PH

1	5 6709PH-1
2	5 6709PH-2
3	5 6709PH-3
1	1 SB6709PH-1
2	1 SB6709PH-2
3	1 SB6709PH-3

SB: Retail pack on a plastic info card

1/4" Square Drive Socket Drivers for Pozidriv Head Screw



6709PZ

1	5 6709PZ-1
2	5 6709PZ-2
3	5 6709PZ-3
1	1 SB6709PZ-1
2	1 SB6709PZ-2
3	1 SB6709PZ-3

SB: Retail pack on a plastic info card

1/4" Square Drive Socket Drivers for TORX® Head Screw



6709TORX

T6	5 6709TORX-T6
T7	5 6709TORX-T7
T8	5 6709TORX-T8
T9	5 6709TORX-T9
T10	5 6709TORX-T10
T15	5 6709TORX-T15
T20	5 6709TORX-T20
T25	5 6709TORX-T25
T27	5 6709TORX-T27
T30	5 6709TORX-T30

T40	5 6709TORX-T40
T8	1 SB6709TORX-T8
T9	1 SB6709TORX-T9
T10	1 SB6709TORX-T10
T15	1 SB6709TORX-T15
T20	1 SB6709TORX-T20
T25	1 SB6709TORX-T25
T27	1 SB6709TORX-T27
T30	1 SB6709TORX-T30
T40	1 SB6709TORX-T40

SB: Retail pack on a plastic info card

1/4" Square Drive Socket Drivers for TORX® Tamper-Resistant Head Screw



6709TORX-R

TR 8	1 6709TORX-R-T8
TR 10	1 6709TORX-R-T10
TR 15	1 6709TORX-R-T15
TR 20	1 6709TORX-R-T20
TR 25	1 6709TORX-R-T25
TR 8	1 SB6709TORX-R-T8
TR 10	1 SB6709TORX-R-T10
TR 15	1 SB6709TORX-R-T15
TR 20	1 SB6709TORX-R-T20
TR 25	1 SB6709TORX-R-T25

SB: Retail pack on a plastic info card

1/4" Square Drive Socket Drivers for TORX® PLUS® Head Screw



6709-IP

IP6		1 6709-IP6
IP7		1 6709-IP7
IP8		1 6709-IP8
IP9		1 6709-IP9
IP10	M3	1 6709-IP10
IP15	-	1 6709-IP15
IP20	M4	1 6709-IP20
IP25	M5	1 6709-IP25
IP27	-	1 6709-IP27
IP30	M6	1 6709-IP30
IP40	M8	1 6709-IP40
IP45	-	1 6709-IP45

SB: Retail pack

1/4" Square Drive Socket Drivers for Hex Head Screw



6709M

3 mm	5	6709M-3		
4 mm	5	6709M-4		
5 mm	5	6709M-5		
6 mm	5	6709M-6		
8 mm	5	6709M-8		
10 mm	5	6709M-10		
3 mm	1	SB6709M-3		
4 mm	1	SB6709M-4		
5 mm	1	SB6709M-5		
6 mm	1	SB6709M-6		
8 mm	1	SB6709M-8		

SB: Retail pack on a plastic info card

1/4" Square Drive Deep Socket Drivers for Metric Hex Head Screw



A6709M

2.5 mm	1	A6709M-2.5		
3 mm	1	A6709M-3		
4 mm	1	A6709M-4		
5 mm	1	A6709M-5		
6 mm	1	A6709M-6		
2.5 mm	1	SBA6709M-2.5		
3 mm	1	SBA6709M-3		
4 mm	1	SBA6709M-4		
5 mm	1	SBA6709M-5		
6 mm	1	SBA6709M-6		

SB: Retail pack on a plastic info card

1/4" Square Drive Deep Socket Drivers for Imperial Hex Head Screw



A6709Z

1/8 in	1	A6709Z-1/8		
9/64 in	1	A6709Z-9/64		
5/32 in	1	A6709Z-5/32		



3/16 in	1	A6709Z-3/16
1/8 in	1	SBA6709Z-1/8
9/64 in	1	SBA6709Z-9/64
5/32 in	1	SBA6709Z-5/32
3/16 in	1	SBA6709Z-3/16

SB: Retail pack on a plastic info card

1/4" Slim Head Reversible Ratchets with 72 Teeth and 5° Action Angle



6950SL

L	Teeth	Part Number
119 mm	72	1 6950SL

1/4" Refrigeration Reversible Ratchets with 32 Teeth and 11.5° Action Angle



R6950

L	Teeth	Part Number
160 mm	32	1 R6950

1/4" Pear Head Reversible Ratchets with 60 Teeth and 6° Action Angle



SBS61

L	Teeth	Part Number
145 mm	60	1 SBS61

SB: Retail pack

1/4" Pear Head Reversible Ratchets with 72 Teeth and 5° Action Angle



6950

L	Teeth	Part Number
121 mm	72	1 6950
121 mm	72	1 SB6950

1/4" Round Head Reversible Ratchets with 72 Teeth and 5° Action Angle



6950RN

L	Teeth	Part Number
121 mm	72	1 6950RN
121 mm	72	1 SB6950RN

1/4" Pear Head Short Reversible Ratchets with 60 Teeth and 6° Action Angle



SBS61S

L	Teeth	Part Number
120 mm	60	1 SBS61S

SB: Retail pack



1/4" Swivel Head Ratchets with 72 Teeth and 5° Action Angle



8120-1/4

149 mm	72	20	8120-1/4

Combination Ratcheting Wrenches for Screwdriver Bits



2058-BR

52	1	2058-BR

Ratcheting Adaptors with 52 Teeth for 1/4" Ratchet



6951

40 mm	1	6951

Spare Part Kit for 6950SL 1/4" Ratchet



6950SL-SPARE

10	6950SL	1	6950SL-SPARE

1/4" Spare Part Kit for 6950 Ratchet



6950-SPARE

12	6950	1	6950-SPARE

Spare Part Kit for 6950RN 1/4" Ratchet



6950RN-SPARE

6	6950RN	1	6950RN-SPARE

3/8"

3/8" Square Drive Sockets with Metric Hex Profile and High Polished Finish



7400SM

6 mm	5	7400SM-6
7 mm	5	7400SM-7
8 mm	5	7400SM-8
9 mm	5	7400SM-9
10 mm	5	7400SM-10
11 mm	5	7400SM-11
12 mm	5	7400SM-12
13 mm	5	7400SM-13
14 mm	5	7400SM-14
15 mm	5	7400SM-15
16 mm	5	7400SM-16
17 mm	5	7400SM-17
18 mm	5	7400SM-18
19 mm	5	7400SM-19
20 mm	5	7400SM-20
21 mm	5	7400SM-21
22 mm	5	7400SM-22
6 mm	1	SB7400SM-6
7 mm	1	SB7400SM-7
8 mm	1	SB7400SM-8
9 mm	1	SB7400SM-9
10 mm	1	SB7400SM-10
11 mm	1	SB7400SM-11
12 mm	1	SB7400SM-12
13 mm	1	SB7400SM-13
14 mm	1	SB7400SM-14
15 mm	1	SB7400SM-15
16 mm	1	SB7400SM-16
17 mm	1	SB7400SM-17
18 mm	1	SB7400SM-18
19 mm	1	SB7400SM-19
20 mm	1	SB7400SM-20
21 mm	1	SB7400SM-21
22 mm	1	SB7400SM-22



SB: Retail pack on a plastic info card

3/8" Square Drive Sockets with Metric Bi-Hex Profile



A7400DM

6 mm	5	A7400DM-6
7 mm	5	A7400DM-7
8 mm	5	A7400DM-8

  	
9 mm	5 A7400DM-9
10 mm	5 A7400DM-10
11 mm	5 A7400DM-11
12 mm	5 A7400DM-12
13 mm	5 A7400DM-13
14 mm	5 A7400DM-14
15 mm	5 A7400DM-15
16 mm	5 A7400DM-16
17 mm	5 A7400DM-17
18 mm	5 A7400DM-18
19 mm	5 A7400DM-19
20 mm	5 A7400DM-20
21 mm	5 A7400DM-21
22 mm	5 A7400DM-22
24 mm	5 A7400DM-24



6 mm	1 SBA7400DM-6
7 mm	1 SBA7400DM-7
8 mm	1 SBA7400DM-8
9 mm	1 SBA7400DM-9
10 mm	1 SBA7400DM-10
11 mm	1 SBA7400DM-11
12 mm	1 SBA7400DM-12
13 mm	1 SBA7400DM-13
14 mm	1 SBA7400DM-14
15 mm	1 SBA7400DM-15
16 mm	1 SBA7400DM-16
17 mm	1 SBA7400DM-17
18 mm	1 SBA7400DM-18
19 mm	1 SBA7400DM-19
20 mm	1 SBA7400DM-20
21 mm	1 SBA7400DM-21
22 mm	1 SBA7400DM-22

SB: Retail pack on a plastic info card

3/8" Square Drive Sockets with Imperial Hex Profile





7400SZ

  	
1/4" in	1 7400SZ-1/4
5/16" in	1 7400SZ-5/16
11/32" in	1 7400SZ-11/32
3/8" in	1 7400SZ-3/8
7/16" in	1 7400SZ-7/16
1/2" in	1 7400SZ-1/2
9/16" in	1 7400SZ-9/16
5/8" in	1 7400SZ-5/8
11/16" in	1 7400SZ-11/16
3/4" in	1 7400SZ-3/4
13/16" in	1 7400SZ-13/16
7/8" in	1 7400SZ-7/8

3/8" Square Drive Sockets with Imperial Bi-Hex Profile



A7400DZ



  	
1/4 in	5 A7400DZ-1/4
5/16 in	5 A7400DZ-5/16
3/8 in	5 A7400DZ-3/8
7/16 in	5 A7400DZ-7/16
1/2 in	5 A7400DZ-1/2
17/32 in	5 A7400DZ-17/32
9/16 in	5 A7400DZ-9/16
19/32 in	5 A7400DZ-19/32
5/8 in	5 A7400DZ-5/8
11/16 in	5 A7400DZ-11/16
3/4 in	5 A7400DZ-3/4
13/16 in	5 A7400DZ-13/16
7/8 in	5 A7400DZ-7/8
1/4 in	1 SBA7400DZ-1/4
5/16 in	1 SBA7400DZ-5/16
3/8 in	1 SBA7400DZ-3/8
7/16 in	1 SBA7400DZ-7/16
1/2 in	1 SBA7400DZ-1/2
17/32 in	1 SBA7400DZ-17/32
9/16 in	1 SBA7400DZ-9/16
19/32 in	1 SBA7400DZ-19/32
5/8 in	1 SBA7400DZ-5/8
11/16 in	1 SBA7400DZ-11/16
3/4 in	1 SBA7400DZ-3/4
13/16 in	1 SBA7400DZ-13/16
7/8 in	1 SBA7400DZ-7/8



SB: Retail pack on a plastic info card

3/8" Square Drive Swivel Sockets with Imperial Bi-Hex Profile



A7410DZ

  	
5/16 in	1 A7410DZ-5/16
3/8 in	1 A7410DZ-3/8
7/16 in	1 A7410DZ-7/16
1/2 in	1 A7410DZ-1/2

  	
9/16 in	1 A7410DZ-9/16
5/8 in	1 A7410DZ-5/8
11/16 in	1 A7410DZ-11/16
3/4 in	1 A7410DZ-3/4

3/8" Square Drive Deep Sockets with Metric Bi-Hex Profile



A7402DM

  	
7 mm	1 A7402DM-7
8 mm	1 A7402DM-8
9 mm	1 A7402DM-9
10 mm	1 A7402DM-10
11 mm	1 A7402DM-11
12 mm	1 A7402DM-12
13 mm	1 A7402DM-13
14 mm	1 A7402DM-14
15 mm	1 A7402DM-15
16 mm	1 A7402DM-16
17 mm	1 A7402DM-17
18 mm	1 A7402DM-18
19 mm	1 A7402DM-19
21 mm	1 A7402DM-21
7 mm	1 SBA7402DM-7
8 mm	1 SBA7402DM-8
9 mm	1 SBA7402DM-9
10 mm	1 SBA7402DM-10
11 mm	1 SBA7402DM-11
12 mm	1 SBA7402DM-12
13 mm	1 SBA7402DM-13
14 mm	1 SBA7402DM-14
15 mm	1 SBA7402DM-15
16 mm	1 SBA7402DM-16
17 mm	1 SBA7402DM-17
18 mm	1 SBA7402DM-18
19 mm	1 SBA7402DM-19

SB: Retail pack on a plastic info card



3/8" Square Drive Deep Sockets with Imperial Bi-Hex Profile



A7402DZ



1/4 in	1	A7402DZ-1/4
5/16 in	1	A7402DZ-5/16
3/8 in	1	A7402DZ-3/8
7/16 in	1	A7402DZ-7/16
1/2 in	1	A7402DZ-1/2
9/16 in	1	A7402DZ-9/16
19/32 in	1	A7402DZ-19/32
5/8 in	1	A7402DZ-5/8
11/16 in	1	A7402DZ-11/16
3/4 in	1	A7402DZ-3/4
13/16 in	1	A7402DZ-13/16
7/8 in	1	A7402DZ-7/8
1/4 in	1	SBA7402DZ-1/4
5/16 in	1	SBA7402DZ-5/16
3/8 in	1	SBA7402DZ-3/8
7/16 in	1	SBA7402DZ-7/16
1/2 in	1	SBA7402DZ-1/2
9/16 in	1	SBA7402DZ-9/16
19/32 in	1	SBA7402DZ-19/32
5/8 in	1	SBA7402DZ-5/8
11/16 in	1	SBA7402DZ-11/16
3/4 in	1	SBA7402DZ-3/4
13/16 in	1	SBA7402DZ-13/16
7/8 in	1	SBA7402DZ-7/8

SB: Retail pack on a plastic info card

3/8" Square Drive Sockets with TORX® Profile



7400TORX-E



E8	5	7400TORX-E8
E10	5	7400TORX-E10
E11	5	7400TORX-E11
E12	5	7400TORX-E12
E14	5	7400TORX-E14
E16	5	7400TORX-E16
E18	5	7400TORX-E18
E8	1	SB7400TORX-E8
E10	1	SB7400TORX-E10
E11	1	SB7400TORX-E11
E12	1	SB7400TORX-E12
E14	1	SB7400TORX-E14
E16	1	SB7400TORX-E16
E18	1	SB7400TORX-E18

SB: Retail pack on a plastic info card

3/8" Square Drive Speeders with Rotary Steel Handle



7752



435 mm



1 7752

3/8" Square Drive Swivel Head Breaker Bars with Matte Finish



S705



246 mm



1 SBS705

3/8" Square Drive Sliding T-Handles



7754



160 mm

160 mm



1 7754

1 SB7754

SB: Retail pack on a plastic info card

3/8" Square Drive Spinner Handles



7757



150 mm

150 mm



6 7756

1 SB7756

SB: With hanging clip

3/8" Square Drive Extension Bars



7760-7761-7762



75 mm

127 mm

250 mm

75 mm

127 mm

252 mm



1 7760

1 7761

1 7762

1 SB7760

1 SB7761

1 SB7762

3/8" Square Drive Wobbler Extension Bars



7760-W - 7761-W



75 mm

150 mm



10 7760W-3

10 7760W-6

3/8" Square Drive Knurled Extension Bars



776EX

Length (mm)	Quantity	Part Number
26 mm	1	776EX-01
76 mm	1	776EX-03
101 mm	1	776EX-04
150 mm	1	776EX-06
200 mm	1	776EX-08
275 mm	1	776EX-11

3/8" Square Drive Universal Joints for Smooth Operations



7768

Length (mm)	Quantity	Part Number
45 mm	1	7768

3/8" Square Drive to 1/2" Socket Increasing Flat Adaptors



8167

Socket Size	Quantity	Part Number
3/8"	1	8167

3/8" Square Drive Flexible Extension Bars

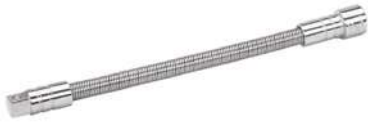

7759

Length (mm)	Quantity	Part Number
200 mm	1	7759
200 mm	1	SB7759

3/8" Square Drive to 1/4" Socket Decreasing Adaptors



7764

Socket Size	Quantity	Part Number
3/8"	1	7764
3/8"	1	SB7764

3/8" Square Drive Adaptors for 1/4" Hex Screwdriver Bits



SBS780

Socket Size	Quantity	Part Number
1/4 in	1	SBS780

3/8" Square Drive Universal Joints



7766

Length (mm)	Quantity	Part Number
51.5 mm	1	7766
51.5 mm	1	SB7766

3/8" Square Drive to 1/2" Socket Increasing Adaptors



8164-1/2

Socket Size	Quantity	Part Number
3/8"	1	8164-1/2

3/8" Square Drive Adaptors for 5/16" Hex Screwdriver Bit



7106J

Socket Size	Quantity	Part Number
5/16 in	1	7106J

SB: Retail pack on a plastic info card



Rail-Clips for 3/8" Sockets/Socket Drivers



C3/8

19 mm	25 CLIPS-3/8

3/8" Pear Head Reversible Ratchets with 80 Teeth and 4.5° Action Angle



7750

207 mm	80	1 7750
207 mm	80	1 SB7750

3/8" Swivel Head Ratchets with 72 Teeth and 5° Action Angle



8120-3/8

223 mm	72	10 8120-3/8

ERGO™ 3/8" Reversible Ratchets with 72 Teeth and 5° Action Angle



7755-3/8

215 mm	72	1 SB7755-3/8

3/8" Round Head Reversible Ratchets with 72 Teeth and 5° Action Angle



7750RN

206 mm	72	1 7750RN
206 mm	72	1 SB7750RN

3/8" Flex Head Reversible Ratchets with 60 Teeth and 6° Action Angle



7710

278 mm	60	1 7710

3/8" Slim Head Reversible Ratchets with 72 Teeth and 5° Action Angle



7750SL

204 mm	72	1 7750SL

3/8" Pear Head Reversible Ratchets with 60 Teeth and 6° Action Angle



SBS750

200 mm	60	10 SBS750

SB: Retail pack

3/8" Square Drive Socket Drivers for Slotted Head Screw



7409F

6.4 mm	5 7409F-6.5
7.9 mm	5 7409F-8
9.5 mm	5 7409F-10
6.4 mm	1 SB7409F-6.5
7.9 mm	1 SB7409F-8
9.5 mm	1 SB7409F-10

SB: Retail pack on a plastic info card

3/8" Square Drive Socket Drivers for Philips Head Screw



7409PH

1	5	7409PH-1
2	5	7409PH-2
3	5	7409PH-3
1	1	SB7409PH-1
2	1	SB7409PH-2
3	1	SB7409PH-3

SB: Retail pack on a plastic info card

3/8" Square Drive Socket Drivers for TORX® Head Screw



7409TORX

T20	5	7409TORX-T20
T25	5	7409TORX-T25
T27	5	7409TORX-T27
T30	5	7409TORX-T30
T40	5	7409TORX-T40
T45	5	7409TORX-T45
T50	5	7409TORX-T50
T20	1	SB7409TORX-T20
T25	1	SB7409TORX-T25
T27	1	SB7409TORX-T27
T30	1	SB7409TORX-T30
T40	1	SB7409TORX-T40
T45	1	SB7409TORX-T45
T50	1	SB7409TORX-T50

SB: Retail pack on a plastic info card

3/8" Square Drive Socket Drivers for TORX® Tamper-Resistant Head Screw



7409TORX-R

TR 27	5	7409TORX-R-T27
TR 30	5	7409TORX-R-T30
TR 40	5	7409TORX-R-T40
TR 45	5	7409TORX-R-T45
TR 50	5	7409TORX-R-T50
TR 27	1	SB7409TORX-R-T27
TR 30	1	SB7409TORX-R-T30
TR 40	1	SB7409TORX-R-T40
TR 45	1	SB7409TORX-R-T45
TR 50	1	SB7409TORX-R-T50

SB: Retail pack on a plastic info card

3/8" Square Drive Socket Driver Set for TORX® Tamper-Resistant Head Screw



7409TORX-TRR/

5	25 x 55 x 190 mm	1	7409TORX-TRR/S5
---	------------------	---	-----------------

7409TORX-R-T40, 7409TORX-R-T30, 7409TORX-R-T27, 7409TORX-R-T50, 7409TORX-R-T45

3/8" Square Drive Deep Socket Drivers for TORX® Head Screw



7409TORX-L

T25	5	7409TORX-T25-L
T30	5	7409TORX-T30-L
T40	5	7409TORX-T40-L
T45	5	7409TORX-T45-L
T50	5	7409TORX-T50-L

T25	1	SB7409TORX-T25-L
T30	1	SB7409TORX-T30-L
T40	1	SB7409TORX-T40-L
T45	1	SB7409TORX-T45-L
T50	1	SB7409TORX-T50-L

SB: Retail pack on a plastic info card

3/8" Square Drive Socket Drivers for Hex Head Screw



7409M

3 mm	5	7409M-3
4 mm	5	7409M-4
5 mm	5	7409M-5
6 mm	5	7409M-6
7 mm	5	7409M-7
8 mm	5	7409M-8
10 mm	5	7409M-10
3 mm	1	SB7409M-3
4 mm	1	SB7409M-4
5 mm	1	SB7409M-5
6 mm	1	SB7409M-6
7 mm	1	SB7409M-7
8 mm	1	SB7409M-8
10 mm	1	SB7409M-10

SB: Retail pack on a plastic info card

3/8" Square Drive Ball Socket Drivers for Hex Head Screw



7409BH

4 mm	5	7409BH-4
5 mm	1	7409BH-5
6 mm	5	7409BH-6
8 mm	5	7409BH-8
10 mm	5	7409BH-10
4 mm	1	SB7409BH-4
5 mm	1	SB7409BH-5
6 mm	1	SB7409BH-6
8 mm	1	SB7409BH-8
10 mm	1	SB7409BH-10

SB: Retail pack on a plastic info card



19 mm Pass Through Sockets with Metric Spline Profile



SBS19-TH

Size	Quantity	Part Number
10 mm	1	SBS19-TH10
11 mm	1	SBS19-TH11
12 mm	1	SBS19-TH12
13 mm	1	SBS19-TH13
14 mm	1	SBS19-TH14
15 in	1	SBS19-TH15
16 mm	1	SBS19-TH16
17 in	1	SBS19-TH17
18 mm	1	SBS19-TH18
19 mm	1	SBS19-TH19
21 mm	1	SBS19-TH21
22 mm	1	SBS19-TH22
24 mm	1	SBS19-TH24

SB: Retail pack

3/8" Square Drive Socket Drivers for Hex Head Screws



7409Z

Size	Length	Quantity	Part Number
1/8 in	47 mm	1	7409Z-1/8
5/32 in	47 mm	1	7409Z-5/32
3/16 in	47 mm	1	7409Z-3/16
7/32 in	47 mm	1	7409Z-7/32
1/4 in	47 mm	1	7409Z-1/4
3/8 in	50.5 mm	1	7409Z-3/8

3/8" Square Drive Socket Driver Set on Rail for Hex Head Screw



7409MR/

Quantity	Dimensions	Part Number
7	25 x 55 x 190 mm	7409MR/S7

7409M-3, 7409M-4, 7409M-10, 7409M-8, 7409M-7, 7409M-6, 7409M-5



Ratcheting Adaptors with 52 Teeth for 3/8" Ratchet



7751

Length	Weight	Quantity	Part Number
55 mm	175 g	10	7751

Spare Part Kit for 7755-3/8 3/8" Ratchet



7755-SO/1

Quantity	Part Number	Quantity	Part Number
6	7755-3/8	1	7755-SO/1

Spare Part Kit for 7750SL 3/8" Ratchet



7750SL-SPARE

Quantity	Part Number	Quantity	Part Number
12	7750SL	1	7750SL-SPARE

Spare Part Kit for 7750 3/8" Ratchet



7750-SPARE

Quantity	Part Number	Quantity	Part Number
11	7750	1	7750-SPARE

Spare Part Kit for 7750RN 3/8" Ratchet



7750RN-SPARE

Quantity	Part Number	Quantity	Part Number
6	7750RN	1	7750RN-SPARE



1/2"

1/2" Square Drive Sockets with Metric Hex Profile and High Polished Finish



7800SM

Size	Quantity	Part Number
8 mm	10	7800SM-8
9 mm	10	7800SM-9
10 mm	10	7800SM-10
11 mm	10	7800SM-11
12 mm	10	7800SM-12
13 mm	10	7800SM-13
14 mm	10	7800SM-14



  	
15 mm	10 7800SM-15
16 mm	10 7800SM-16
17 mm	10 7800SM-17
18 mm	10 7800SM-18
19 mm	10 7800SM-19
20 mm	10 7800SM-20
21 mm	10 7800SM-21
22 mm	10 7800SM-22
23 mm	10 7800SM-23
24 mm	10 7800SM-24
25 mm	10 7800SM-25
26 mm	10 7800SM-26
27 mm	10 7800SM-27
28 mm	10 7800SM-28
29 mm	10 7800SM-29
30 mm	10 7800SM-30
32 mm	10 7800SM-32
33 mm	10 7800SM-33
34 mm	10 7800SM-34
36 mm	10 7800SM-36
8 mm	1 SB7800SM-8
9 mm	1 SB7800SM-9
10 mm	1 SB7800SM-10
11 mm	1 SB7800SM-11
12 mm	1 SB7800SM-12
13 mm	1 SB7800SM-13
14 mm	1 SB7800SM-14
15 mm	1 SB7800SM-15
16 mm	1 SB7800SM-16
17 mm	1 SB7800SM-17
18 mm	1 SB7800SM-18
19 mm	1 SB7800SM-19
21 mm	1 SB7800SM-20
21 mm	1 SB7800SM-21
22 mm	1 SB7800SM-22
23 mm	1 SB7800SM-23
24 mm	1 SB7800SM-24
25 mm	1 SB7800SM-25
26 mm	1 SB7800SM-26
27 mm	1 SB7800SM-27
28 mm	1 SB7800SM-28
29 mm	1 SB7800SM-29
30 mm	1 SB7800SM-30
32 mm	1 SB7800SM-32
33 mm	1 SB7800SM-33
34 mm	1 SB7800SM-34
36 mm	1 SB7800SM-36



SB: Retail pack on a plastic info card

1/2" Square Drive Deep Sockets with Metric Hex Profile



7805SM

  	
10 mm	10 7805SM-10
11 mm	10 7805SM-11
12 mm	10 7805SM-12
13 mm	10 7805SM-13



  	
14 mm	10 7805SM-14
15 mm	10 7805SM-15
16 mm	10 7805SM-16
17 mm	10 7805SM-17
18 mm	10 7805SM-18
19 mm	10 7805SM-19
20 mm	10 7805SM-20
21 mm	10 7805SM-21
22 mm	10 7805SM-22
23 mm	10 7805SM-23
24 mm	10 7805SM-24
25 mm	10 7805SM-25
26 mm	10 7805SM-26
27 mm	10 7805SM-27
28 mm	10 7805SM-28
29 mm	10 7805SM-29
30 mm	10 7805SM-30
32 mm	10 7805SM-32
34 mm	10 7805SM-34
10 mm	1 SB7805SM-10
12 mm	1 SB7805SM-12
13 mm	1 SB7805SM-13
14 mm	1 SB7805SM-14
15 mm	1 SB7805SM-15
16 mm	1 SB7805SM-16
17 mm	1 SB7805SM-17
18 mm	1 SB7805SM-18
19 mm	1 SB7805SM-19
20 mm	1 SB7805SM-20
21 mm	1 SB7805SM-21
22 mm	1 SB7805SM-22
23 mm	1 SB7805SM-23
24 mm	1 SB7805SM-24
25 mm	1 SB7805SM-25
26 mm	1 SB7805SM-26
27 mm	1 SB7805SM-27
28 mm	1 SB7805SM-28
29 mm	1 SB7805SM-29
30 mm	1 SB7805SM-30
32 mm	1 SB7805SM-32
34 mm	1 SB7805SM-34

SB: Retail pack on a plastic info card

1/2" Square Drive Deep Sockets with Imperial Hex Profile





7805SZ

  	
1.3/16 in	1 7805SZ-1.3/16
1.1/4 in	1 7805SZ-1.1/4
1.5/16 in	1 7805SZ-1.5/16
1.3/8 in	1 7805SZ-1.3/8
1.7/16 in	1 7805SZ-1.7/16
1.1/2 in	1 7805SZ-1.1/2

1/2" Square Drive Sockets with Metric Bi-Hex Profile



7800DM

  	
8 mm	10 7800DM-8
9 mm	10 7800DM-9
10 mm	10 7800DM-10
11 mm	10 7800DM-11
12 mm	10 7800DM-12
13 mm	10 7800DM-13
14 mm	10 7800DM-14
15 mm	10 7800DM-15
16 mm	10 7800DM-16
17 mm	10 7800DM-17
18 mm	10 7800DM-18
19 mm	10 7800DM-19
20 mm	10 7800DM-20
21 mm	10 7800DM-21
22 mm	10 7800DM-22
23 mm	10 7800DM-23
24 mm	10 7800DM-24
25 mm	10 7800DM-25
26 mm	10 7800DM-26
27 mm	10 7800DM-27
28 mm	10 7800DM-28
29 mm	10 7800DM-29
30 mm	10 7800DM-30
31 mm	10 7800DM-31
32 mm	10 7800DM-32
33 mm	10 7800DM-33
34 mm	10 7800DM-34
36 mm	10 7800DM-36
8 mm	1 SB7800DM-8
9 mm	1 SB7800DM-9
10 mm	1 SB7800DM-10
11 mm	1 SB7800DM-11
12 mm	1 SB7800DM-12
13 mm	1 SB7800DM-13
14 mm	1 SB7800DM-14
15 mm	1 SB7800DM-15
16 mm	1 SB7800DM-16
17 mm	1 SB7800DM-17
18 mm	1 SB7800DM-18
19 mm	1 SB7800DM-19
21 mm	1 SB7800DM-20
21 mm	1 SB7800DM-21
22 mm	1 SB7800DM-22
23 mm	1 SB7800DM-23
24 mm	1 SB7800DM-24
25 mm	1 SB7800DM-25
26 mm	1 SB7800DM-26
27 mm	1 SB7800DM-27
28 mm	1 SB7800DM-28
29 mm	1 SB7800DM-29
30 mm	1 SB7800DM-30
31 mm	1 SB7800DM-31
32 mm	1 SB7800DM-32
33 mm	1 SB7800DM-33
34 mm	1 SB7800DM-34
36 mm	1 SB7800DM-36

SB: Retail pack on a plastic info card



1/2" Square Drive Sockets with Imperial Bi-Hex Profile



7800DZ

5/16 in	10	7800DZ-5/16	
11/32 in	10	7800DZ-11/32	
3/8 in	10	7800DZ-3/8	
13/32 in	10	7800DZ-13/32	
7/16 in	10	7800DZ-7/16	
1/2 in	10	7800DZ-1/2	
9/16 in	10	7800DZ-9/16	
19/32 in	10	7800DZ-19/32	
5/8 in	10	7800DZ-5/8	
11/16 in	10	7800DZ-11/16	
3/4 in	10	7800DZ-3/4	
25/32 in	10	7800DZ-25/32	
13/16 in	10	7800DZ-13/16	
7/8 in	10	7800DZ-7/8	
15/16 in	10	7800DZ-15/16	
1 in	10	7800DZ-1	
1.1/16 in	10	7800DZ-1.1/16	
1.1/8 in	10	7800DZ-1.1/8	
1.3/16 in	10	7800DZ-1.3/16	
1.1/4 in	10	7800DZ-1.1/4	
1.5/16 in	10	7800DZ-1.5/16	
1.3/8 in	10	7800DZ-1.3/8	
1.7/16 in	1	7800DZ-1.7/16	
1.1/2 in	10	7800DZ-1.1/2	
3/8 in	1	SB7800DZ-3/8	
7/16 in	1	SB7800DZ-7/16	
1/2 in	1	SB7800DZ-1/2	
9/16 in	1	SB7800DZ-9/16	
19/32 in	1	SB7800DZ-19/32	
5/8 in	1	SB7800DZ-5/8	
11/16 in	1	SB7800DZ-11/16	
3/4 in	1	SB7800DZ-3/4	
25/32 in	1	SB7800DZ-25/32	
13/16 in	1	SB7800DZ-13/16	
7/8 in	1	SB7800DZ-7/8	
15/16 in	1	SB7800DZ-15/16	
1 in	1	SB7800DZ-1	
1.1/16 in	1	SB7800DZ-1.1/16	
1.1/8 in	1	SB7800DZ-1.1/8	
1.3/16 in	1	SB7800DZ-1.3/16	
1.1/4 in	1	SB7800DZ-1.1/4	
1.5/16 in	1	SB7800DZ-1.5/16	

SB: Retail pack on a plastic info card

1/2" Square Drive Deep Sockets with Metric Bi-Hex Profile



7805DM

10 mm	10	7805DM-10	
12 mm	10	7805DM-12	
13 mm	10	7805DM-13	

14 mm	10	7805DM-14	
15 mm	10	7805DM-15	
16 mm	10	7805DM-16	
17 mm	10	7805DM-17	
18 mm	10	7805DM-18	
19 mm	10	7805DM-19	
21 mm	10	7805DM-21	
22 mm	10	7805DM-22	
23 mm	10	7805DM-23	
24 mm	10	7805DM-24	
26 mm	10	7805DM-26	
27 mm	10	7805DM-27	
30 mm	10	7805DM-30	
32 mm	10	7805DM-32	
34 mm	10	7805DM-34	

10 mm	1	SB7805DM-10	
12 mm	1	SB7805DM-12	
13 mm	1	SB7805DM-13	
14 mm	1	SB7805DM-14	
15 mm	1	SB7805DM-15	
16 mm	1	SB7805DM-16	
17 mm	1	SB7805DM-17	
18 mm	1	SB7805DM-18	
19 mm	1	SB7805DM-19	
21 mm	1	SB7805DM-21	
22 mm	1	SB7805DM-22	
23 mm	1	SB7805DM-23	
24 mm	1	SB7805DM-24	
26 mm	1	SB7805DM-26	
27 mm	1	SB7805DM-27	
30 mm	1	SB7805DM-30	
32 mm	1	SB7805DM-32	

SB: Retail pack on a plastic info card

1/2" Square Drive Deep Sockets with Imperial Bi-Hex Profile



7805DZ

5/8 in	10	7805DZ-5/8	
11/16 in	10	7805DZ-11/16	
3/4 in	10	7805DZ-3/4	
13/16 in	10	7805DZ-13/16	
7/8 in	10	7805DZ-7/8	
15/16 in	10	7805DZ-15/16	
1 in	10	7805DZ-1	
1.1/16 in	10	7805DZ-1.1/16	
1.1/8 in	10	7805DZ-1.1/8	
1.13/16 in	10	7805DZ-1.3/16	
1.1/4 in	10	7805DZ-1.1/4	
1.5/16 in	10	7805DZ-1.5/16	
1.3/8 in	10	7805DZ-1.3/8	
1.7/16 in	10	7805DZ-1.7/16	
1.1/2 in	10	7805DZ-1.1/2	

1/2" Square Drive Sockets with TORX® Profile



7800TORX-E

E8	1	7800TORX-E8	
E10	1	7800TORX-E10	
E11	1	7800TORX-E11	
E12	1	7800TORX-E12	
E14	1	7800TORX-E14	
E16	1	7800TORX-E16	
E18	1	7800TORX-E18	
E20	1	7800TORX-E20	
E24	1	7800TORX-E24	
E8	1	SB7800TORX-E8	
E10	1	SB7800TORX-E10	
E11	1	SB7800TORX-E11	
E12	1	SB7800TORX-E12	
E14	1	SB7800TORX-E14	
E16	1	SB7800TORX-E16	
E18	1	SB7800TORX-E18	
E20	1	SB7800TORX-E20	
E24	1	SB7800TORX-E24	

SB: Retail pack on a plastic info card

1/2" Square Drive Speeders with Rotary Steel Handle



8152-1/2

425 mm	1	8152-1/2	

1/2" Square Drive Swivel Head Breaker Bars



8157

257 mm	1	8157-1/2	
257 mm	1	8157-10	
390 mm	1	8157-15	
600 mm	1	8157-24	
900 mm	1	8157-36	

L	
257 mm	1 SB8157-10
390 mm	1 SB8157-15
600 mm	1 SB8157-24
900 mm	1 SB8157-36

1/2" Square Drive Swivel Head Breaker Bars with Matte Finish



8158

L	
270 mm	1 8158-10
390 mm	1 8158-15
270 mm	1 SB8158-10
390 mm	1 SB8158-15

1/2" Square Drive Offset Handles



8167-1/2

L	
210 mm	1 8167-1/2

1/2" Square Drive Sliding T-Handles



8154

L	
280 mm	10 8154-11
280 mm	1 SB8154-11

3/8" to 1/2" Adaptor Sliding Head



7772H

3/8"	1/2"	10	7772H

1/2" Square Drive Extension Bars



8160

L	
88 mm	10 8160-3
125 mm	10 8160-5
250 mm	10 8160-10
88 mm	1 SB8160-3
125 mm	1 SB8160-5
250 mm	1 SB8160-10

1/2" Square Drive Wobbler Extension Bars



8159-W - 8162-W

L	
75 mm	10 8160W-3
125 mm	10 8160W-5
250 mm	10 8160W-10

1/2" Square Drive Locking Extension Bars



8160-B

L	
125 mm	1 8160-B

1/2" Square Drive Universal Joints



8166

L	
72 mm	10 8166
72 mm	1 SB8166

1/2" Square Drive Universal Joints for Smooth Operations



8168

L	
62 mm	1 8168



1/2" Square Drive to 3/8" Socket
Decreasing Adaptors



8171

1/2"	3/8"	10	8171
1/2"	3/8"	1	SB8171

1/2" Square Drive to 3/4" Socket
Increasing Flat Adaptors



8967

1/2"	3/4"	1	8967

Spare Part Kit for 8169-1/2 Breaking Bar



SP120

75 g	1	SP120

Combination Stepped Hexagon Keys for
Internal Lug Valve Sizes



8195-key

140 g	50	8195-KEY

For using with 8195-R

1/2" Square Drive Adaptors for 5/16" Hex
Screwdriver Bit



7106S

5/16 in	10	8174A

Spare Part Kit for 8170-1/2 Breaking Bar



SP120XL

55 g	1	SP120XL

1/2" Square Drive to 3/4" Socket
Increasing Adaptors



8172

1/2"	3/4"	10	8172
1/2"	3/4"	1	SB8172

1/2" Square Drive Bit Locking Adaptors for
5/16" Hex Screwdriver Bit



7809HL

5/16 in	1	7809HL

Rail-Clips for 1/2" Sockets/Socket Drivers



C1/2

19 mm	25	CLIPS-1/2

1/2" Square Drive Socket Drivers for Slotted Head Screw 60 mm



7809F

0,8 mm	8 mm	5	7809F-8
1 mm	10 mm	5	7809F-10

1/2" Square Drive Socket Drivers for Phillips Head Screw 23 mm



7809PH

2		1	7809PH-2
3		1	7809PH-3
4		1	7809PH-4

1/2" Square Drive Socket Drivers for Pozidriv Head Screw 60 mm



7809PZ

2		1	7809PZ-2
3		1	7809PZ-3

1/2" Square Drive Socket Drivers for TORX® Head Screw



7809TORX

T20		1	7809TORX-T20
T25		1	7809TORX-T25
T27		1	7809TORX-T27
T30		1	7809TORX-T30
T40		1	7809TORX-T40
T45		1	7809TORX-T45
T50		1	7809TORX-T50
T55		1	7809TORX-T55
T60		1	7809TORX-T60
T20		1	SB7809TORX-T20
T25		1	SB7809TORX-T25
T27		1	SB7809TORX-T27
T30		1	SB7809TORX-T30
T40		1	SB7809TORX-T40
T45		1	SB7809TORX-T45
T50		1	SB7809TORX-T50
T55		1	SB7809TORX-T55
T60		1	SB7809TORX-T60

SB: Retail pack on a plastic info card

1/2" Socket Drivers for TORX® Head Screws



7809TORX_L

T40	82 mm	5	7809TORX-T40-120
T45	80 mm	1	7809TORX-T45-120
T50	62 mm	1	7809TORX-T50-100
T55	102 mm	5	7809TORX-T55-140
T70	102 mm	5	7809TORX-T70-140

1/2" Square Drive Socket Driver Set for TORX® Head Screw



7809TO

9		1	7809TO

7809TORX-T27, 7809TORX-T20, 7809TORX-T25, 7809TORX-T30, 7809TORX-T50, 7809TORX-T40, 7809TORX-T45, 7809TORX-T60, 7809TORX-T55

1/2" Square Drive Socket Drive Set for Torx® Head Screws - 9 pcs



7800TORX/9

g		1	7800TORX/9
800 g			

7800TORX-E8, 7800TORX-E10, 7800TORX-E11, 7800TORX-E12, 7800TORX-E14, 7800TORX-E16, 7800TORX-E18, 7800TORX-E20, 7800TORX-E24

1/2" Square Drive Socket Drivers for Hex Head Screw



7809M

4 mm		10	7809M-4
5 mm		1	7809M-5
6 mm		1	7809M-6
7 mm		1	7809M-7
8 mm		1	7809M-8
9 mm		1	7809M-9
10 mm		1	7809M-10
12 mm		1	7809M-12
14 mm		1	7809M-14
17 mm		1	7809M-17
19 mm		1	7809M-19
4 mm		1	SB7809M-4
5 mm		1	SB7809M-5
6 mm		1	SB7809M-6
7 mm		1	SB7809M-7
8 mm		1	SB7809M-8
9 mm		1	SB7809M-9
10 mm		1	SB7809M-10
12 mm		1	SB7809M-12
14 mm		1	SB7809M-14
17 mm		1	SB7809M-17
19 mm		1	SB7809M-19

SB: Retail pack on a plastic info card



1/2" Socket Drivers for Hex Head Screws



7809M L

Hex Head		Length		Part Number	
5 mm	61 mm	1	7809M-5-100		
5 mm	143 mm	1	7809M-5-180		
6 mm	59 mm	1	7809M-6-100		
6 mm	103 mm	1	7809M-6-140		
7 mm	63 mm	1	7809M-7-100		
8 mm	83 mm	1	7809M-8-120		
10 mm	103 mm	1	7809M-10-140		
5 mm	63 mm	1	SB7809M-5-100		
5 mm	140 mm	1	SB7809M-5-180		
6 mm	62 mm	1	SB7809M-6-100		
6 mm	103 mm	1	SB7809M-6-140		
7 mm	63 mm	1	SB7809M-7-100		
8 mm	81 mm	1	SB7809M-8-120		
10 mm	101 mm	1	SB7809M-10-140		

Size	Part Number
3/8 in	1 7809Z-3/8
7/16 in	1 7809Z-7/16
1/2 in	1 7809Z-1/2
17/32 in	1 7809Z-17/32
9/16 in	1 7809Z-9/16
19/32 in	1 7809Z-19/32
5/8 in	1 7809Z-5/8

1/2" Square Drive Socket Drivers for Multipoint Head Screw



7809XZN

Size	Part Number
6	1 7809XZN-6
8	1 7809XZN-8
8	1 7809XZN-8-100
10	1 7809XZN-10
10	1 7809XZN-10-100
12	1 7809XZN-12
12	1 7809XZN-12-100
14	1 7809XZN-14
14	1 7809XZN-14-100
16	1 7809XZN-16
18	1 7809XZN-18

1/2" Square Drive Socket Driver Set for Hex Head Screw



7808HM

Quantity	Part Number
8	1 7808HM

7809M-4, 7809M-6, 7809M-8, 7809M-7, 7809M-5, 7809M-10, 7809M-12, 7809M-14

1/2" Square Drive Socket Drivers for Imperial Hex Head Screw



7809Z

Size	Part Number
1/4 in	1 7809Z-1/4
5/16 in	1 7809Z-5/16

ERGO™ 1/2" Reversible Ratchets with 60 Teeth and 6° Action Angle



8155-1/2

Length	Teeth	Part Number
262 mm	60	1 8155-1/2

1/2" Slim Head Reversible Ratchets with 72 Teeth and 5° Action Angle



8150SL

Length	Teeth	Part Number
264 mm	72	1 8150SL

1/2" Pear Head Reversible Ratchets with 80 Teeth and 4.5° Action Angle



8150-1/2

Length	Teeth	Part Number
269 mm	80	1 8150-1/2
269 mm	80	1 SB8150-1/2

SB: With hanging clip

1/2" Round Head Reversible Ratchets with 72 Teeth and 5° Action Angle



8150RN-1/2

Length	Teeth	Part Number
267 mm	72	1 8150RN-1/2
267 mm	72	1 SB8150RN-1/2

SB: With hanging clip

1/2" Pear Head Reversible Ratchets with 60 Teeth and 6° Action Angle



SBS81

250 mm	60	5	SBS81

Radiator Valve Ratchet Set - 3 Pcs/Plastic Pouch



8195-SET

350 x 20 x 80 mm	5	8195-SET

Fitting Square Drives for 8195-R 1/2" Reversible Ratchet



8195-SQ

37.5 mm	40 g	25	8195-SQ

1/2" Swivel Head Ratchets with 72 Teeth and 5° Action Angle



8120-1/2

266 mm	72	12	8120-1/2

8195-R

8195-SQ

8195-KEY

1/2" Flex Head Reversible Ratchets with 32 Teeth and 11.25° Action Angle



8110H-1/2

440 mm	32	1	8110H-1/2

Ratcheting Adaptors with 52 Teeth for 1/2" Ratchet



8151-1/2

71 mm	1	8151-1/2

1/2" Reversible Ratchets with 60 Teeth and Dual Pawl



8195-R

260 mm	60	1	8195-R

Fitting Square Drives for 8193-1/2 1/2" Ratchet



8194-1/2

32 mm	1	8194-1/2

Spare Part Kit for 8155-1/2 1/2" Ratchet



8155-SO/1

6	8155-1/2	1	8155-SO/1



Spare Part Kit for 8150SL 1/2" Ratchet



8150SL-SPARE



12 8150SL 1 8150SL-SPARE

Spare Part Kit for 8150-1/2 1/2" Ratchet



8150-1/2-SPARE



11 8150-1/2 1 8150-1/2-SPARE

Spare Part Kit for 8150RN-1/2 1/2" Ratchet



8150RN-1/2-SPARE



6 8150RN-1/2 1 8150RN-1/2-SPARE

3/4"

3/4" Square Drive Sockets with Metric Hex Profile



8900SM



19 mm	1	8900SM-19
22 mm	1	8900SM-22
23 mm	1	8900SM-23
24 mm	5	8900SM-24
26 mm	5	8900SM-26
27 mm	5	8900SM-27
28 mm	1	8900SM-28
29 mm	1	8900SM-29
30 mm	5	8900SM-30
32 mm	5	8900SM-32
33 mm	1	8900SM-33
34 mm	1	8900SM-34
35 mm	1	8900SM-35
36 mm	5	8900SM-36
38 mm	1	8900SM-38
41 mm	5	8900SM-41
42 mm	1	8900SM-42
46 mm	1	8900SM-46
50 mm	1	8900SM-50
55 mm	1	8900SM-55
60 mm	1	8900SM-60

3/4" Square Drive Sockets with Metric Bi-Hex Profile



8900DM



19 mm	1	8900DM-19
21 mm	5	8900DM-21
22 mm	1	8900DM-22
23 mm	1	8900DM-23
24 mm	1	8900DM-24
25 mm	1	8900DM-25
26 mm	1	8900DM-26
27 mm	1	8900DM-27
28 mm	1	8900DM-28
29 mm	1	8900DM-29
30 mm	5	8900DM-30
32 mm	1	8900DM-32
33 mm	1	8900DM-33
34 mm	1	8900DM-34
35 mm	1	8900DM-35
36 mm	1	8900DM-36
37 mm	1	8900DM-37
38 mm	1	8900DM-38
40 mm	1	8900DM-40
41 mm	5	8900DM-41
42 mm	1	8900DM-42
46 mm	1	8900DM-46
47 mm	1	8900DM-47
50 mm	5	8900DM-50
52 mm	1	8900DM-52
40 mm	3	8900DM-54
55 mm	1	8900DM-55
56 mm	1	8900DM-56
60 mm	5	8900DM-60

3/4" Square Drive Sockets with Imperial Hex Profile



8900SZ



3/4" in	1	8900SZ-3/4
13/16" in	1	8900SZ-13/16
7/8" in	1	8900SZ-7/8
1" in	1	8900SZ-1
1.1/16" in	1	8900SZ-1.1/16
1.5/16" in	1	8900SZ-1.5/16
1.3/8" in	1	8900SZ-1.3/8
1.7/16" in	1	8900SZ-1.7/16
1.9/16" in	1	8900SZ-1.9/16
1.5/8" in	1	8900SZ-1.5/8
1.3/4" in	1	8900SZ-1.3/4
1.13/16" in	1	8900SZ-1.13/16
1.7/8" in	1	8900SZ-1.7/8
2 in	1	8900SZ-2

3/4" Square Drive Sockets with Imperial Bi-Hex Profile



8900DZ



3/4 in	1	8900DZ-3/4
13/16 in	1	8900DZ-13/16
7/8 in	1	8900DZ-7/8
15/16 in	1	8900DZ-15/16
31/32 in	1	8900DZ-31/32
1 in	1	8900DZ-1
1 1/16 in	1	8900DZ-1.1/16
1 1/8 in	1	8900DZ-1.1/8
1 3/16 in	1	8900DZ-1.3/16



1 1/4 in	1	8900DZ-1.1/4
1 5/16 in	5	8900DZ-1.5/16
1 3/8 in	1	8900DZ-1.3/8
1 7/16 in	1	8900DZ-1.7/16
1 1/2 in	1	8900DZ-1.1/2
1 9/16 in	1	8900DZ-1.9/16
1 5/8 in	1	8900DZ-1.5/8
1.11/16 in	1	8900DZ-1.11/16
1 3/4 in	1	8900DZ-1.3/4
1 13/16 in	1	8900DZ-1.13/16
1 7/8 in	1	8900DZ-1.7/8
2 in	1	8900DZ-2
2.1/16 in	1	8900DZ-2.1/16
2.1/8 in	1	8900DZ-2.1/8
2.3/16 in	1	8900DZ-2.3/16
2.1/4 in	1	8900DZ-2.1/4
2.3/8 in	5	8900DZ-2.3/8

3/4" Square Drive Sliding T-Heads



8954A



62 mm



1 8954A

3/4" Square Drive Extension Bars



8961/8962



200 mm

400 mm



1 8961

1 8962

3/4" Universal Handles with High Polished Finish



8953



505 mm



1 8953

3/4" Square Drive Flex Head Breaker Bars



8958



570 mm



1 8958

3/4" Square Drive Telescopic Handle with Matte Finish



S93



510 mm



1 S93

3/4" Square Drive Flex Heads for 8958 Breaker Bar



8958A



125 mm



1 8958A

3/4" Square Drive Universal Joints



8966



120 mm



1 8966

3/4" Square Drive Sliding T-Handles



8954



505 mm



1 8954

3/4" Square Drive Offset Handles



8963



415 mm



1 8963

3/4" Square Drive to 1/2" Socket Decreasing Adaptors



8965



3/4



1/2



1 8965



3/4" Square Drive to 1" Socket Increasing Adaptors



9564



3/4" 1" 1 9564

3/4" ratchets.



8955N



525 mm 24 1 8955N

Round Heads with 72 Teeth for 3/4" Reversible Ratchet



8950N/A



170 mm 72 1 8950N/A

Pear Heads with 24 Teeth for 3/4" Reversible Ratchet



8955N/A



152 mm 24 1 8955N/A

3/4" Universal handle



8955N/B



1160 g 390 mm 5 8955N/B

Ratcheting Adaptors with 72 Teeth for 3/4" Ratchet



8951



95.5 mm 1 8951

Spare Part Kit for 8950 N and 8950N/A 3/4" Ratchet



8950NA-SO/2



8 8950N, 8950N/A 1 8950NA-SO/2

Spare Part Kit for 8955N and 8955N/A 3/4" Ratchet



8955N-SPARE

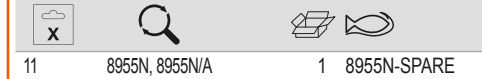

11 8955N, 8955N/A 1 8955N-SPARE

1"

1" Square Drive Sockets with Metric Hex Profile



9500SM



41 in	1	9500SM-41
46 in	1	9500SM-46
50 in	1	9500SM-50
54 in	1	9500SM-54
55 in	1	9500SM-55
58 in	1	9500SM-58

Size	Quantity	Part Number
60 in	1	9500SM-60
63 in	1	9500SM-63
65 in	1	9500SM-65
67 in	1	9500SM-67
70 in	1	9500SM-70
71 in	1	9500SM-71
75 in	1	9500SM-75
77 in	1	9500SM-77
80 in	1	9500SM-80
82 in	1	9500SM-82

1" Square Drive Sliding T-Handles with Matte Finish



1" Square Drive to 3/4" Socket Decreasing Adaptors with Matte Finish



1" Square Drive Sockets with Imperial Bi-Hex Profile







9555



508 mm 1 9555

9565AB

1" 1" 1 9565AB

9500DZ

Size	Quantity	Part Number
1.5/8 in	1	9500DZ-1.5/8
1.13/16 in	1	9500DZ-1.13/16
1.7/8 in	1	9500DZ-1.7/8
2 in	1	9500DZ-2
2.1/8 in	1	9500DZ-2.1/8
2.3/16 in	1	9500DZ-2.3/16
2.1/4 in	1	9500DZ-2.1/4
2.3/8 in	1	9500DZ-2.3/8
2.1/2 in	1	9500DZ-2.1/2
2.9/16 in	1	9500DZ-2.9/16
2.5/8 in	1	9500DZ-2.5/8
2.3/4 in	1	9500DZ-2.3/4
2.15/16 in	1	9500DZ-2.15/16
3 in	1	9500DZ-3
3.1/8 in	1	9500DZ-3.1/8

1" Square Drive Sliding T-Heads



9555AB



78x78x78 mm 1 9555AB

1" Round Head Reversible Ratchets with 72 Teeth and 5° Action Angle



9550N





640 mm 72 1 9550N

1" Square Drive Flex Head Universal Joints with Matte Finish





1" Square Drive Extension Bars with Matte Finish



1" Square Drive Interchangeable Handle Bar for Ratcheting Heads





9566A



167 mm 1 9566A

9560AB/9563AB

200 mm 1 9560AB
440 mm 1 9563AB

9550N/B

1960 g 1 9550N/B



Round Heads with 72 Teeth for 1" Reversible Ratchet



9550N/A

195 mm	72	1	9550N/A

70 x 160 x 280 mm	500 g	1	S330-CASE
110 x 320 x 375 mm	1620 g	1	S400-CASE
110 x 320 x 375 mm	1620 g	1	S410-CASE
100 x 215 x 375 mm	1120 g	1	S460-CASE
100 x 215 x 375 mm	1120 g	1	S560-CASE
110 x 375 x 430 mm	2200 g	1	S81MIX-CASE
110 x 375 x 430 mm	2200 g	1	S108-CASE
110 x 375 x 430 mm	2200 g	1	SLX17-CASE
100 x 215 x 375 mm	1120 g	1	S330L-CASE

Spare Part Kit for 9550 N and 9550N/A 1" Ratchet



9550N-SPARE

2	9550N, 9550N/A	1	9550N-SPARE

Injected Empty Spare Cases



SPARE-CASE

35 x 80 x 100 mm	1	SPAR-CASE-A7
35 x 85 x 160 mm	1	SPAR-CASE-A6
49 x 152 x 280 mm	1	SPAR-CASE-A4

EMPTY SOCKET SET CASES

Empty Cases with Divider for Socket Set



-CASE

110 x 375 x 430 mm	2200 g	1	S103-CASE
70 x 160 x 280 mm	520 g	1	S160-CASE
100 x 215 x 370 mm	1120 g	1	S240AF-CASE
70 x 160 x 280 mm	520 g	1	S290-CASE

SCAFFOLDING WRENCHES

Double Metric Bi-Hex Scaffolding Wrench



SC2RM

13-17 mm	10	SC2RM-13-17
15-17 mm	10	SC2RM-15-17
19-22 mm	10	SC2RM-19-22
27-30 mm	1	SC2RM-27-30



Torque Tools



DIGITAL TORQUE WRENCHES

Digital Torque and Angle Slim Bluetooth® Wrench with Memory and Rectangular Interchangeable Head



TAWMB MICRO

mm	Nm	Nm	
9x12 mm	1.5-30 Nm	0,01 Nm	1 TAWMB930M
9x12 mm	6.8-135 Nm	0,1 Nm	1 TAWMB9135M

Accuracy: 20% to 100% of full scale

Digital Torque and Angle Bluetooth® Wrench with Memory and Rectangular Interchangeable Head



TAWMB14_24

mm	Nm	Nm	
14x18 mm	17-340 Nm	1 Nm	1 TAWMB14340
24x32 mm	32.5-650 Nm	1 Nm	1 TAWMB24650
24x32 mm	40-800 Nm	1 Nm	1 TAWMB24800

Accuracy: 20% to 100% of full scale

Electronic Torque and Angle Slim Wrench with Memory/USB and Fixed Ratchet Head



TAWM MICRO

	Nm	Nm	
1/4 in	0.6-12 Nm	0,01 Nm	1 TAWM1412M
1/4 in	1.5-30 Nm	0,01 Nm	1 TAWM1430M
3/8 in	6.8-135 Nm	0,1 Nm	1 TAWM38135M

Accuracy: 20% to 100% of full scale

Electronic Torque and Angle Slim Wrench with Memory/USB and Rectangular Interchangeable Head



TAWM9 MICRO

mm	Nm	Nm	
9x12 mm	0.6-12 Nm	0,01 Nm	1 TAWM912M
9x12 mm	1.5-30 Nm	0,01 Nm	1 TAWM930M
9x12 mm	6.8-135 Nm	0,1 Nm	1 TAWM9135M

Accuracy: 20% to 100% of full scale

Electronic Torque and Angle Wrench with Memory/USB and Fixed Ratchet Head. with memory and USB data download



TAWM

	Nm	Nm	
3/8 in	7-135 Nm	1 Nm	1 TAWM38135
1/2 in	17-340 Nm	1 Nm	1 TAWM12340
3/4 in	40-800 Nm	1 Nm	1 TAWM34800

Accuracy: 20% to 100% of full scale

Electronic Torque and Angle Wrench with Memory/USB and Rectangular Interchangeable Head



TAWM9_14_24

mm	Nm	Nm	
9x12 mm	7-135 Nm	1 Nm	1 TAWM9135
14x18 mm	17-340 Nm	1 Nm	1 TAWM14340
24x32 mm	40-800 Nm	1 Nm	1 TAWM24800

Accuracy: 20% to 100% of full scale

Electronic Torque and Thin Angle Wrench with Fixed Ratchet Head



TAW MICRO

mm	Nm	Nm	Icons
1/4 in	0.6-12 Nm	0,01 Nm	1 TAW1412M
1/4 in	1.5-30 Nm	0,01 Nm	1 TAW1430M
3/8 in	6.8-135 Nm	0,1 Nm	1 TAW38135M

Accuracy: 20% to 100% of full scale

Electronic Torque and Angle Slim Wrench with Rectangular Interchangeable Head



TAW9 MICRO

mm	Nm	Nm	Icons
9x12 mm	0.6-12 Nm	0,01 Nm	1 TAW912M
9x12 mm	1.5-30 Nm	0,01 Nm	1 TAW930M
9x12 mm	6.8-135 Nm	0,1 Nm	1 TAW9135M

Accuracy: 20% to 100% of full scale

Electronic Torque and Angle Wrench with Fixed Ratchet Head



TAW

mm	Nm	Nm	Icons
3/8 in	7-135 Nm	1 Nm	1 TAW38135
1/2 in	17-340 Nm	1 Nm	1 TAW12340
3/4 in	40-800 Nm	1 Nm	1 TAW34800

Accuracy: 20% to 100% of full scale

Electronic Torque and Angle Wrench with Rectangular Interchangeable Head



TAW9 14 24

mm	Nm	Nm	Icons
9x12 mm	7-135 Nm	1 Nm	1 TAW9135
14x18 mm	17-340 Nm	1 Nm	1 TAW14340
24x32 mm	40-800 Nm	1 Nm	1 TAW24800

Accuracy: 20% to 100% of full scale

Electronic Torque Wrench with Rectangular Interchangeable Head



IZO-D

mm	Nm	Nm	Icons
1/4 in	3-30 Nm	0,1 Nm	1 IZO-D-30
3/8 in	13.5-135 Nm	1 Nm	1 IZO-D-135
1/2 in	20-200 Nm	1 Nm	1 IZO-D-200
1/2 in	34-340 Nm	1 Nm	1 IZO-D-340

Electronic Torque Wrench with Fixed Ratchet Head. ring spanner



IZO-DR

mm	Nm	Nm	Icons
3/4 in	81-810 Nm	1 Nm	1 IZO-DR-810



MECHANICAL TORQUE WRENCHES

Mechanical Adjustable Torque Click Wrench with Window Scale and Fixed Ratchet Head



74WR-15/74WR-25

mm	Nm	Nm		
1/4 in	3-15 Nm	0,1 Nm	1	74WR-15
1/4 in	5-25 Nm	0,2 Nm	1	74WR-25

Mechanical Adjustable Torque Click Wrench with Window Scale and Fixed Push-Through Ratchet Head

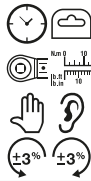

74WR-50/74WR-400

mm	Nm	Nm		
3/8"	10-50 Nm	0,5 Nm	1	74WR-50
3/8"	20-100 Nm	1 Nm	1	74WR-100B
1/2"	20-100 Nm	1 Nm	1	74WR-100
1/2"	40-200 Nm	2 Nm	1	74WR-200
1/2"	60-300 Nm	2 Nm	1	74WR-300
1/2"	60-340 Nm	5 Nm	1	74WR-340
3/4"	80-400 Nm	5 Nm	1	74WR-400

Mechanical Adjustable Torque Click Wrench with Window Scale and Rectangular Interchangeable Head



74W9/74W14

mm	Nm	Nm		
9x12 mm	3-15 Nm	0,2 Nm	1	74W9-15
9x12 mm	5-25 Nm	0,2 Nm	1	74W9-25
9x12 mm	10-50 Nm	0,5 Nm	1	74W9-50

mm	Nm	Nm		
9x12 mm	20-100 Nm	1 Nm	1	74W9-100
9x12 mm	40-200 Nm	1 Nm	1	74W9-200
14x18 mm	40-200 Nm	2 Nm	1	74W14-200
14x18 mm	60-300 Nm	2 Nm	1	74W14-300
14x18 mm	80-400 Nm	5 Nm	1	74W14-400

Mechanical Adjustable Torque Click Wrench with Window Scale and Spigot Interchangeable Head

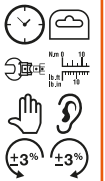

74WS-15/74WS-300

mm	Nm	Nm		
16 mm	3-15 Nm	0,2 Nm	1	74WS-15
16 mm	5-25 Nm	0,2 Nm	1	74WS-25
16 mm	10-50 Nm	0,5 Nm	1	74WS-50
16 mm	20-100 Nm	1 Nm	1	74WS-100
16 mm	40-200 Nm	2 Nm	1	74WS-200
16 mm	60-300 Nm	2 Nm	1	74WS-300

Mechanical Adjustable Torque Click Wrench with Marked Scale and Fixed Ratchet Head

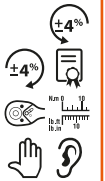

7455

mm	Nm	Nm		
1/4 in	1-5 Nm	0,05 Nm	1	7455-5
1/4 in	3-15 Nm	0,1 Nm	1	7455-15
1/4 in	4-20 Nm	0,1 Nm	1	7455-20
1/4 in	5-25 Nm	0,1 Nm	1	7455-25
3/8 in	12-60 Nm	0,5 Nm	1	7455-60
3/8 in	20-100 Nm	0,5 Nm	1	7455-100
1/2 in	20-100 Nm	0,5 Nm	1	7455-100A
1/2 in	40-200 Nm	2 Nm	1	7455-200
1/2 in	60-300 Nm	2 Nm	1	7455-300
1/2 in	68-340 Nm	2 Nm	1	7455-340
3/4 in	100-500 Nm	5 Nm	1	7455-500
3/4 in	160-800 Nm	5 Nm	1	7455-800
1 in	200-1000 Nm	10 Nm	1	7455-1000

Mechanical Adjustable Torque Click Wrench with Marked Scale, Fixed Ratchet Head and 2 Section Handle

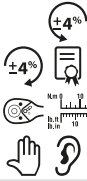

7455-1500

1 in	300-1500 Nm	10 Nm	1	7455-1500

Mechanical Adjustable Torque Click Wrench with Marked Scale, Interchangeable Head and 2 Sections Handle



7465-1500

27x36 mm	300-1500 Nm	10 Nm	1	7465-1500

Mechanical Adjustable Torque Click Wrench with Marked Scale and Fixed Square Drive Head



7455-2500

1 in	500-2500 Nm	10 Nm	1	7455-2500

Mechanical Adjustable Torque Click Wrench with Marked Scale and Flex Ratchet Head



7456

3/8 in	10-80 lb-ft lbf-ft	0,5 lb-ft lbf-ft	1	7456-80LB

Mechanical Adjustable Torque Click Wrench with Marked Scale and Interchangeable Head

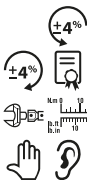

7465

9x12 mm	1-5 Nm	0,05 Nm	1	7465-5
9x12 mm	3-15 Nm	0,1 Nm	1	7465-15
9x12 mm	6-30 Nm	0,1 Nm	1	7465-30
9x12 mm	12-60 Nm	0,5 Nm	1	7465-60
9x12 mm	20-100 Nm	0,5 Nm	1	7465-100
14x18 mm	40-200 Nm	2 Nm	1	7465-200
14x18 mm	68-340 Nm	2 Nm	1	7465-340
24x32 mm	160-800 Nm	5 Nm	1	7465-800

Mechanical Adjustable Free Hand Point Torque Click Wrench with Fixed Ratchet Head



75R3/75R1

3/4" in	130-650 Nm	5 Nm	1	75R3-650
3/4" in	200-800 Nm	10 Nm	1	75R3-800
3/4" in	300-1000 Nm	10 Nm	1	75R3-1000
1" in	500-1500 Nm	10 Nm	1	75R1-1500



Mechanical Adjustable Free Hand Point Torque Click Wrench with Spigot Interchangeable Head



75S-650

22 mm	130-650 Nm	5 Nm	1	75S-650

Mechanical Adjustable Breaking Torque Wrench with Fixed Ratchet Head and Double Adjusting Bar



76R1-2000

1 in	900-2000 N·m	50 N·m	1	76R1-2000

Mechanical Adjustable Window Scale Breaking Torque Wrench with Fixed Ratchet Head



76R3

3/4-1 in	120-600 Nm	10 Nm	1	76R3-600
3/4-1 in	200-800 Nm	10 Nm	1	76R3-800
3/4-1 in	300-1000 Nm	20 Nm	1	76R3-1000

Mechanical Adjustable Window Scale Breaking Torque Click Wrench with Spigot Interchangeable Head



76S-600

22 mm	120-600 Nm	10 Nm	1	76S-600

Mechanical Adjustable Breaking Torque Wrench with Fixed Ratchet Head



76R3-1500

3/4 in	700-1500 N·m	25 N·m	1	76R3-1500

Mechanical Torque Wrench with Dial Scale, Fixed Square Drive Head & Metal Handle



7454 M

1/4 in	0.7-3.5 Nm	0,1 Nm	1	7454-3.5
1/4 in	1.68-8.4 Nm	0,2 Nm	1	7454-8.4
3/8 in	3.4-17 Nm	0,5 Nm	1	7454-17
3/8 in	6.4-32 Nm	0,5 Nm	1	7454-32
3/8 in	14-70 Nm	1 Nm	1	7454-70A
1/2 in	28-140 Nm	5 Nm	1	7454-140A
1/2 in	46-230 Nm	10 Nm	1	7454-230
3/4 in	96-480 Nm	10 Nm	1	7454-480A
	160-800 Nm	20 Nm	1	7454-800A

Mechanical Torque Wrench with Dial Scale, Fixed Square Drive Head and Metal Handle

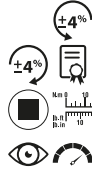

7454-480/7454-800

3/4 in	100-480 Nm	10 Nm	1 7454-480
3/4 in	160-800 Nm	20 Nm	1 7454-800

Mechanical Torque Wrench with Dial Scale, Fixed Square Drive Head and 2 Sections Handle

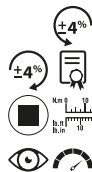

7454-1400

1 in	275-1400 Nm	25 Nm	1 7454-1400

Mechanical Torque Wrench with Dial Scale/LED and Fixed Square Drive Head



7454-800E

3/4 in	160-800 Nm	20 Nm	1 7454-800E	

Mechanical Torque Wrench with Dial Scale/LED and Fixed Square Drive Head and 2 Sections Handle



7454-1400E

1 in	275-1400 Nm	25 Nm	1 7454-1400E	

Mechanical Preset Torque Click Wrench with Fixed Ratchet Head



74PR-20

1/4 in	4-20 Nm	219 mm	1 74PR-20	

Mechanical Preset Torque Click Wrench with Fixed Push-Through Ratchet Head



74PR-60/74PR-400

3/8 in	12-60 Nm	295 mm	1 74PR-60	
1/2 in	12-60 Nm	301 mm	1 74PR-60A	
3/8 in	20-100 Nm	335 mm	1 74PR-100	
1/2 in	20-100 Nm	342 mm	1 74PR-100A	
1/2 in	40-200 Nm	425 mm	1 74PR-200	
1/2 in	60-300 Nm	668 mm	1 74PR-300	
3/4 in	80-400 Nm	675 mm	1 74PR-400	



Mechanical Preset Torque Click Wrench with Rectangular Interchangeable Head and Plastic Handle



74P9-20

mm	Nm	L	
9x12 mm	4-20 Nm	205 mm	1 74P9-20

Mechanical Preset Torque Click Wrench with Spigot Interchangeable Head and Rubber Handle



74PS-60/74PS-300

mm	Nm	L	
16 mm	12-60 Nm	283 mm	1 74PS-60
16 mm	20-100 Nm	324 mm	1 74PS-100
16 mm	40-200 Nm	405 mm	1 74PS-200
16 mm	60-300 Nm	643 mm	1 74PS-300

Mechanical Preset Torque Click Wrench with Rectangular Interchangeable Head and Rubber Handle

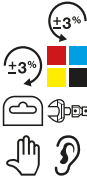

74P9-60/74P14-400

mm	Nm	L	
9x12 mm	12-60 Nm	286 mm	1 74P9-60
9x12 mm	20-100 Nm	326 mm	1 74P9-100
14x18 mm	40-200 Nm	403 mm	1 74P14-200
14x18 mm	60-300 Nm	534 mm	1 74P14-300
14x18 mm	80-400 Nm	652 mm	1 74P14-400

Mechanical Preset Free Hand Point Torque Click Wrench with Fixed Ratchet Head



75P3/75P1

mm	Nm	L	
3/4 in	130-650 Nm	848 mm	1 75P3-650
3/4" in	200-800 Nm	1030 mm	1 75P3-800
3/4" in	300-1000 Nm	1238 mm	1 75P3-1000
1" in	500-1500 Nm	1563 mm	1 75P1-1500

Mechanical Preset Torque Click Wrench with Spigot Interchangeable Head and Plastic Handle



74PS-20

mm	Nm	L	
16 mm	4-20 Nm	206 mm	1 74PS-20

Mechanical Preset Free Hand Point Torque Click Wrench with Spigot Interchangeable Head



75PS-650

mm	Nm	L	
22 mm	130-650 Nm	800 mm	1 75PS-650

Handle Extension for 75 Series Torque Click Wrench



75EXT

700 mm	60 mm	1.600 kg	1	75EXT

Adjustable Torque Screwdriver with Window Scale



6973N-6978N

1/4 in	10-80 cNM	1 cNM	1	6973N
1/4 in	40-200 cNM	2 cNM	1	6976N
1/4 in	50-450 cNM	5 cNM	1	6978N

TORQUE SCREWDRIVERS

Electronic Torque and Angle Screwdriver



TAS14

1/4" in		0.04-0.7 Nm	1	TAS14H007
- in	1/4" in	0.04-0.7 Nm	1	TAS14S007
1/4" in		0.45-9 Nm	1	TAS14H09
	1/4" in	0.45-9 Nm	1	TAS14S09

Accuracy: 20% to 100% of full scale

Adjustable Torque Mini Wrench with Fixed Screwdriver Bit



6852-5

1/4 in	1-5 Nm	0.1 Nm	1	6852-5

Adjustable Torque Mini Wrench Set with Fixed Screwdriver Bit



6852-5/S17

32 x 70 x 200 mm	0.29 kg	1	6852-5/S17

Digital Torque and Angle Bluetooth® Screwdriver



TASMB14H

1/4 in	0.04-0.7 Nm	0,01 Nm	1	TASMB14H007
1/4 in	0.45-9 Nm	0,01 Nm	1	TASMB14H09

Accuracy: 20% to 100% of full scale

KM653-QR

6852-5	
6700SM-4	
59S/PH0, 59S/PH1	
59S/PZ0, 59S/PZ1	
59S/H1.5	
59S/0.8-5.5, 59S/0.6-4.5	
59S/T6, 59S/T7, 59S/T8	



Adjustable Torque Screwdriver with Marked Scale in cN·m



TSS120

1/4 in	10-120 cNM	1 cNM	1	TSS120

Adjustable Torque Screwdriver with Marked Scale in N·m



TSS600

1/4 in	1-6 Nm	0,1 Nm	1	TSS600

Preset Torque Screwdriver with Window Scale



6873N-6880N

7-70 cNM	1/4 in	1/4 in	1	6876N
15-170 cNM	1/4 in	1/4 in	1	6878N
45-450 cNM	1/4 in	1/4 in	1	6880N

Preset Torque Mini Wrench with Fixed Screwdriver Bit



6852P-5

1/4" in	1-5 Nm	157 mm	1	6852P-5

Fixed Preset ERGO™ Torque Screwdriver. With TORX® and TORX Plus® blades



BE-6990

0.6 Nm N·m	T6	IP6	1	BE-6990-IP6
0.9 Nm N·m	T7	IP7	1	BE-6990-IP7
1.2 Nm N·m	T8	IP8	1	BE-6990-IP8
1.4 Nm N·m	T9	IP9	1	BE-6990-IP9
2 Nm N·m	T10	IP10	1	BE-6990-IP10
3 Nm N·m	T15	IP15	1	BE-6990-IP15

Preset Torque Screwdriver with Window Scale



BE-6990-IPSET

40 x 170 x 215 mm	0.755 kg	1	BE-6990-IPSET

BE-6990-IP7, BE-6990-IP8, BE-6990-IP9, BE-6990-IP15



Torque Screwdriver Blades with TORX® Tip



BE-6990TX-KL

T6		1.70 mm	160 mm	10	BE-6990TX-T6-KL
T7		1.99 mm	160 mm	10	BE-6990TX-T7-KL
T8		2.31 mm	160 mm	10	BE-6990TX-T8-KL
T9		2.50 mm	170 mm	10	BE-6990TX-T9-KL
T10		2.74 mm	170 mm	10	BE-6990TX-T10-KL
T15		3.27 mm	170 mm	10	BE-6990TX-T15-KL

Torque Screwdriver Blades with TORX PLUS® Tip



BE-6990-IP-KL

IP6		1.50 mm	170 mm	10	BE-6990-IP6-KL
IP7		1.99 mm	170 mm	10	BE-6990-IP7-KL
IP8		2.31 mm	170 mm	10	BE-6990-IP8-KL
IP9		2.50 mm	170 mm	10	BE-6990-IP9-KL
IP10		2.74 mm	170 mm	10	BE-6990-IP10-KL
IP15		3.27 mm	170 mm	10	BE-6990-IP15-KL

Spare blade for TORX® head screws



BE-6990-IP20-KL

IP20		4.5 mm	90 mm	20 g	10	BE-6990-IP20-KL

Spare blade for TORX® head screws



BE-6990TX-T20KL

T20		4.5 mm	92 mm	20 g	10	BE-6990TX-T20KL

MULTIPLIERS

Hand Torque Multiplier with Offset and Straight Reaction Arms



89049TM-1000

1000 Nm - 3/4 in	4.8:1/4.9:1*	208/204 Nm - 1/2 in	1	89049TM-1000

Hand Torque Multiplier with Offset and Straight Reaction Arms



8905-TM/9505-TM

1300 Nm - 3/4 in	5:1	260 Nm - 1/2 in	1	8905-TM
2700 Nm - 1 in	5:1	540 Nm - 3/4 in	1	9505-TM



Hand Torque Multiplier with Reaction Plate



9505/9605/9525/9625

□ in	⚙️	□ in	📦	🐟
3400 Nm - 1 in	5:1	680 Nm - 3/4 in	1	9505-3400
3400 Nm - 1 in	25:1	136 Nm - 1/2 in	1	9525-3400
9500 Nm - 1.1/2 in	25:1	380 Nm - 3/4 in	1	9625-9500

Hand Torque Multiplier with Straight Reaction Arm



95155B/9526B

□ in	⚙️	□ in	📦	🐟
3000 Nm - 1 in	15.5:1	193 Nm - 1/2 in	1	95155B-3000
4500 Nm - 1 in	26:1	173 Nm - 1/2 in	1	9526B-4500

Compact Hand Torque Multiplier with Offset Reaction Arm



89222CR/96255CR

□ in	⚙️	□ in	📦	🐟
1000 Nm - 3/4 in	22.2:1	45 Nm - 1/2 in	1	89222CR-1000
2000 Nm - 1 in	27:1	74 Nm - 1/2 in	1	9527CR-2000
4000 Nm - 1 in	25:1	160 Nm - 1/2 in	1	9525CR-4000
7000 Nm - 1.1/2 in	25.5:1	274 Nm - 1/2 in	1	96255CR-7000

TORQUE TESTERS

Multifunctional Testers for torque screwdrivers and wrenches



TEA003-TEA030

□ Nm	⚙️	□ Nm	📦	🐟
0.1-3.0 Nm N-m	1/4 in	0,01 Nm	1	TEA003
0.5-10 Nm N-m	1/4 in	0,01 Nm	1	TEA010
1.5-30 Nm N-m	10 mm	0,1 Nm	1	TEA030

Joint Simulators for Torque Testing Equipment



TJS

max □	⚙️	□	📦	🐟
3 N-m	1/4 in	31 mm	1	TJS003
10 N-m	1/4 in	31 mm	1	TJS010
30 N-m	1/4 in	31 mm	1	TJS030

Multifunctional tester for torque wrenches



TEA065-TEA2100

□ Nm	⚙️	□ in	📦	🐟
3-65 Nm N-m	- mm	3/8 in	1	TEA065
10-350 Nm N-m	- mm	1/2 in	1	TEA350
50-1100 Nm N-m	27 mm	3/4 in	1	TEA1100
200-2100 Nm N-m	27 mm		1	TEA2100

TORQUE ANGLE ADAPTORS

Electronic Torque and Angle Meter



TAM

Size	Range (Nm)	Accuracy	Part No.
1/4 in	1,5-30 Nm	±4%	TAM1430
3/8 in	6,8-135 Nm	±4%	TAM38135
1/2 in	6,8-135 Nm	±4%	TAM12135
1/2 in	10-200 Nm	±4%	TAM12200
1/2 in	17-340 Nm	±4%	TAM12340

Electronic Angle Meter



MAM

Range	Size	Part No.
0-360°	56 mm	1 MAM50M

Angle Meter with Magnet



7851-M/8951-M

Size	Range	Length	Part No.
1/2 in	0-360	490 mm	1 7851-M
3/4 in	0-360	490 mm	1 8951-M

Angle Meter with Clamp



7851-G

Size	Range	Length	Part No.
1/2 in	0-360	555 mm	1 7851-G

INSERT TOOLS

Round Ratchet Head with Rectangular Connector



9/14/24/27R

Size	Width (mm)	Max Torque (Nm)	Part No.
1/4 in	9x12 mm	30 Nm	1 9R-1/4
3/8 in	9x12 mm	135 Nm	1 9R-3/8
1/2 in	9x12 mm	160 Nm	1 9R-1/2
1/2 in	14x18 mm	340 Nm	1 14R-1/2
3/4 in	14x18 mm	420 Nm	1 14R-3/4
3/4 in	24x32 mm	1000 Nm	1 24R-3/4
1 in	24x32 mm	1200 Nm	1 24R-1
1 in	27x36 mm	2500 Nm	1 27R-1

Push-Through Square Ratchet Head with Rectangular Connector



9/14/24/27T





Size	Width (mm)	Max Torque (Nm)	Part No.
1/4 in	9x12 mm	30 Nm	1 9T-1/4
3/8 in	9x12 mm	135 Nm	1 9T-3/8
1/2 in	9x12 mm	160 Nm	1 9T-1/2
1/2 in	14x18 mm	340 Nm	1 14T-1/2
3/4 in	14x18 mm	420 Nm	1 14T-3/4
3/4 in	24x32 mm	1000 Nm	1 24T-3/4
1 in	24x32 mm	1200 Nm	1 24T-1
1 in	27x36 mm	2500 Nm	1 27T-1



Fixed Square Head with Rectangular Connector





9/14/24/27F

				
1/4 in	9x12 mm	30 Nm	1	9F-1/4
3/8 in	9x12 mm	135 Nm	1	9F-3/8
1/2 in	9x12 mm	160 Nm	1	9F-1/2
1/2 in	14x18 mm	340 Nm	1	14F-1/2
3/4 in	14x18 mm	420 Nm	1	14F-3/4
3/4 in	24x32 mm	1000 Nm	1	24F-3/4
1 in	24x32 mm	1200 Nm	1	24F-1
1 in	27x36 mm	2500 Nm	1	27F-1

Ratchet Head for Screwdriver Bits with Rectangular Connector







9B

			
1/4 in	9x12 mm	1	9B-1/4
5/16 in	9x12 mm	1	9B-5/16

Pear Ratchet Head with Rectangular Connector







9/14P

				
1/4 in	9x12 mm	30 Nm	1	9P-1/4
3/8 in	9x12 mm	135 Nm	1	9P-3/8
1/2 in	9x12 mm	160 Nm	1	9P-1/2
1/2 in	14x18 mm	340 Nm	1	14P-1/2

Pear Ratchet Head with Quick-Release and Rectangular Connector







9/14Q





				
1/4 in	9x12 mm	30 Nm	1	9Q-1/4
3/8 in	9x12 mm	135 Nm	1	9Q-3/8
1/2 in	9x12 mm	160 Nm	1	9Q-1/2
1/2 in	14x18 mm	340 Nm	1	14Q-1/2

Open-End Metric Wrench with Rectangular Connector



9/14/24/27T





				
7 mm	9x12 mm	9 Nm	1	97-7
8 mm	9x12 mm	13 Nm	1	97-8
9 mm	9x12 mm	18 Nm	1	97-9
10 mm	9x12 mm	24 Nm	1	97-10
11 mm	9x12 mm	32 Nm	1	97-11
12 mm	9x12 mm	41 Nm	1	97-12
13 mm	9x12 mm	51 Nm	1	97-13
14 mm	9x12 mm	63 Nm	1	97-14
15 mm	9x12 mm	77 Nm	1	97-15
16 mm	9x12 mm	92 Nm	1	97-16
17 mm	9x12 mm	109 Nm	1	97-17
18 mm	9x12 mm	125 Nm	1	97-18
19 mm	9x12 mm	145 Nm	1	97-19
21 mm	9x12 mm	160 Nm	1	97-21
22 mm	9x12 mm	160 Nm	1	97-22
24 mm	9x12 mm	160 Nm	1	97-24
27 mm	9x12 mm	160 Nm	1	97-27
30 mm	9x12 mm	160 Nm	1	97-30
32 mm	9x12 mm	160 Nm	1	97-32
13 mm	14x18 mm	51 Nm	1	147-13
14 mm	14x18 mm	63 Nm	1	147-14
15 mm	14x18 mm	77 Nm	1	147-15
16 mm	14x18 mm	92 Nm	1	147-16
17 mm	14x18 mm	109 Nm	1	147-17
18 mm	14x18 mm	125 Nm	1	147-18
19 mm	14x18 mm	145 Nm	1	147-19
21 mm	14x18 mm	190 Nm	1	147-21
22 mm	14x18 mm	220 Nm	1	147-22
24 mm	14x18 mm	280 Nm	1	147-24
25 mm	14x18 mm	320 Nm	1	147-25
27 mm	14x18 mm	360 Nm	1	147-27
30 mm	14x18 mm	360 Nm	1	147-30
32 mm	14x18 mm	360 Nm	1	147-32
33 mm	14x18 mm	360 Nm	1	147-33
34 mm	14x18 mm	360 Nm	1	147-34
35 mm	14x18 mm	360 Nm	1	147-35
36 mm	14x18 mm	360 Nm	1	147-36
37 mm	14x18 mm	360 Nm	1	147-37
38 mm	14x18 mm	360 Nm	1	147-38
39 mm	14x18 mm	360 Nm	1	147-39
41 mm	14x18 mm	360 Nm	1	147-41
45 mm	14x18 mm	360 Nm	1	147-45

				
mm	mm	Nm		
46 mm	14x18 mm	360 Nm	1	147-46
50 mm	14x18 mm	360 Nm	1	147-50
55 mm	14x18 mm	360 Nm	1	147-55
60 mm	14x18 mm	360 Nm	1	147-60
68 mm	14x18 mm	360 Nm	1	147-68
70 mm	14x18 mm	360 Nm	1	147-70
75 mm	14x18 mm	360 Nm	1	147-75
90 mm	14x18 mm	360 Nm	1	147-90
24 mm	24x32 mm	1200 Nm	1	247-24
27 mm	24x32 mm	1200 Nm	1	247-27
30 mm	24x32 mm	1200 Nm	1	247-30
32 mm	24x32 mm	1200 Nm	1	247-32
34 mm	24x32 mm	1200 Nm	1	247-34
36 mm	24x32 mm	1200 Nm	1	247-36
41 mm	24x32 mm	1200 Nm	1	247-41
46 mm	24x32 mm	1200 Nm	1	247-46
50 mm	24x32 mm	1200 Nm	1	247-50
55 mm	24x32 mm	1200 Nm	1	247-55
60 mm	24x32 mm	1200 Nm	1	247-60
30 mm	27x36 mm	3000 Nm	1	277-30
32 mm	27x36 mm	3000 Nm	1	277-32
34 mm	27x36 mm	3000 Nm	1	277-34
36 mm	27x36 mm	3000 Nm	1	277-36
41 mm	27x36 mm	3000 Nm	1	277-41
46 mm	27x36 mm	3000 Nm	1	277-46
50 mm	27x36 mm	3000 Nm	1	277-50
55 mm	27x36 mm	3000 Nm	1	277-55
60 mm	27x36 mm	3000 Nm	1	277-60

Open-End Imperial Wrench with Rectangular Connector







9/14/24/277"

				
in	mm	Nm		
1/4 in	9x12 mm	6 Nm	1	97-1/4
5/16 in	9x12 mm	13 Nm	1	97-5/16
3/8 in	9x12 mm	24 Nm	1	97-3/8
7/16 in	9x12 mm	32 Nm	1	97-7/16
1/2 in	9x12 mm	51 Nm	1	97-1/2
17/32 in	9x12 mm	63 Nm	1	97-17/32
9/16 in	9x12 mm	77 Nm	1	97-9/16
5/8 in	9x12 mm	92 Nm	1	97-5/8
11/16 in	9x12 mm	125 Nm	1	97-11/16
3/4 in	9x12 mm	145 Nm	1	97-3/4
13/16 in	9x12 mm	160 Nm	1	97-13/16
7/8 in	9x12 mm	160 Nm	1	97-7/8
15/16 in	9x12 mm	160 Nm	1	97-15/16
1 in	9x12 mm	160 Nm	1	97-1
7/16 in	14x18 mm	32 Nm	1	147-7/16
1/2 in	14x18 mm	51 Nm	1	147-1/2
9/16 in	14x18 mm	77 Nm	1	147-9/16
5/8 in	14x18 mm	92 Nm	1	147-5/8
11/16 in	14x18 mm	109 Nm	1	147-11/16
3/4 in	14x18 mm	145 Nm	1	147-3/4
13/16 in	14x18 mm	190 Nm	1	147-13/16
7/8 in	14x18 mm	220 Nm	1	147-7/8
15/16 in	14x18 mm	280 Nm	1	147-15/16
1 in	14x18 mm	360 Nm	1	147-1
1 1/8 in	14x18 mm	360 Nm	1	147-1.1/8
1 1/4 in	14x18 mm	360 Nm	1	147-1.1/4

Ring End Metric Wrench with Rectangular Connector



9/14/24/278





				
mm	mm	Nm		
7 mm	9x12 mm	25 Nm	1	98-7
8 mm	9x12 mm	34 Nm	1	98-8
9 mm	9x12 mm	45 Nm	1	98-9
10 mm	9x12 mm	58 Nm	1	98-10
11 mm	9x12 mm	47 Nm	1	98-11
12 mm	9x12 mm	89 Nm	1	98-12
13 mm	9x12 mm	105 Nm	1	98-13
14 mm	9x12 mm	125 Nm	1	98-14
15 mm	9x12 mm	145 Nm	1	98-15
16 mm	9x12 mm	160 Nm	1	98-16
17 mm	9x12 mm	160 Nm	1	98-17
18 mm	9x12 mm	160 Nm	1	98-18
19 mm	9x12 mm	160 Nm	1	98-19
21 mm	9x12 mm	160 Nm	1	98-21
22 mm	9x12 mm	160 Nm	1	98-22
13 mm	14x18 mm	105 Nm	1	148-13
14 mm	14x18 mm	125 Nm	1	148-14
15 mm	14x18 mm	150 Nm	1	148-15
16 mm	14x18 mm	175 Nm	1	148-16
17 mm	14x18 mm	200 Nm	1	148-17
18 mm	14x18 mm	230 Nm	1	148-18
19 mm	14x18 mm	260 Nm	1	148-19
21 mm	14x18 mm	330 Nm	1	148-21
22 mm	14x18 mm	360 Nm	1	148-22
24 mm	14x18 mm	360 Nm	1	148-24
27 mm	14x18 mm	360 Nm	1	148-27
28 mm	14x18 mm	360 Nm	1	148-28
30 mm	14x18 mm	360 Nm	1	148-30
32 mm	14x18 mm	360 Nm	1	148-32
34 mm	14x18 mm	360 Nm	1	148-34
36 mm	14x18 mm	360 Nm	1	148-36
41 mm	14x18 mm	360 Nm	1	148-41
24 mm	24x32 mm	1200 Nm	1	248-24
27 mm	24x32 mm	1200 Nm	1	248-27
30 mm	24x32 mm	1200 Nm	1	248-30
32 mm	24x32 mm	1200 Nm	1	248-32
34 mm	24x32 mm	1200 Nm	1	248-34
36 mm	24x32 mm	1200 Nm	1	248-36
41 mm	24x32 mm	1200 Nm	1	248-41
46 mm	24x32 mm	1200 Nm	1	248-46
50 mm	24x32 mm	1200 Nm	1	248-50
55 mm	24x32 mm	1200 Nm	1	248-55
60 mm	24x32 mm	1200 Nm	1	248-60
30 mm	27x36 mm	3000 Nm	1	278-30
32 mm	27x36 mm	1240 Nm	1	278-32
34 mm	27x36 mm	3000 Nm	1	278-34
36 mm	27x36 mm	3000 Nm	1	278-36
41 mm	27x36 mm	3000 Nm	1	278-41
46 mm	27x36 mm	3000 Nm	1	278-46
50 mm	27x36 mm	3000 Nm	1	278-50
55 mm	27x36 mm	3000 Nm	1	278-55
60 mm	27x36 mm	3000 Nm	1	278-60



Ring End Imperial Wrench with Rectangular Connector







9/14/24/278"

	 mm	 max		
1/4 in	9x12 mm	25 Nm	1	98-1/4
5/16 in	9x12 mm	34 Nm	1	98-5/16
3/8 in	9x12 mm	58 Nm	1	98-3/8
7/16 in	9x12 mm	72 Nm	1	98-7/16
1/2 in	9x12 mm	105 Nm	1	98-1/2
9/16 in	9x12 mm	125 Nm	1	98-9/16
5/8 in	9x12 mm	160 Nm	1	98-5/8
11/16 in	9x12 mm	160 Nm	1	98-11/16
3/4 in	9x12 mm	57 Nm	1	98-3/4
13/16 in	14x18 mm	330 Nm	1	148-13/16
13/16 in	9x12 mm	160 Nm	1	98-13/16
7/8 in	9x12 mm	160 Nm	1	98-7/8
1/2 in	14x18 mm	105 Nm	1	148-1/2
9/16 in	14x18 mm	150 Nm	1	148-9/16
5/8 in	14x18 mm	175 Nm	1	148-5/8
11/16 in	14x18 mm	230 Nm	1	148-11/16
3/4 in	14x18 mm	260 Nm	1	148-3/4
15/16 in	14x18 mm	360 Nm	1	148-15/16
7/8 in	14x18 mm	360 Nm	1	148-7/8
1 in	14x18 mm	360 Nm	1	148-1

Flare Nut End Wrench with Rectangular Connector







99

	 mm	 max		
10 mm	9x12 mm	14 Nm	1	99-10
11 mm	9x12 mm	19 Nm	1	99-11
12 mm	9x12 mm	24 Nm	1	99-12
13 mm	9x12 mm	30 Nm	1	99-13
14 mm	9x12 mm	37 Nm	1	99-14
16 mm	9x12 mm	46 Nm	1	99-16
17 mm	9x12 mm	55 Nm	1	99-17
18 mm	9x12 mm	65 Nm	1	99-18
19 mm	9x12 mm	74 Nm	1	99-19
21 mm	9x12 mm	87 Nm	1	99-21
22 mm	9x12 mm	96 Nm	1	99-22
24 mm	9x12 mm	96 Nm	1	99-24

Increasing and Reducing Rectangular Connector Adaptors







9/14/24/27A

 mm	 mm	 max		
9x12 mm	14x18 mm	160 Nm	1	9A-14
14x18 mm	9x12 mm	160 Nm	1	14A-9
14x18 mm	24x32 mm	360 Nm	1	14A-32
24x32 mm	14x18 mm	360 Nm	1	24A-14
24x32 mm	27x36 mm	1200 Nm	1	24A-27
27x36 mm	24x32 mm	1200 Nm	1	27A-24

Flare Nut End Wrench with Rectangular Connector







99 in

	 mm	 max		
3/8 in	9x12 mm	9 Nm	1	99-3/8
7/16 in	9x12 mm	16 Nm	1	99-7/16
1/2 in	9x12 mm	28 Nm	1	99-1/2
9/16 in	9x12 mm	31 Nm	1	99-9/16
5/8 in	9x12 mm	46 Nm	1	99-5/8
11/16 in	9x12 mm	65 Nm	1	99-11/16
3/4 in	9x12 mm	74 Nm	1	99-3/4

Weld-On Adaptor with Rectangular Connector







9/14/24W

 mm	 L		
9x12 mm	23 mm	1	9W
14x18 mm	39 mm	1	14W
24x32 mm	65 mm	1	24W

Round Ratchet Head with Spigot Connector







16R/22R

				
1/4" in	16 mm	20 Nm	1	16R-1/4
3/8" in	16 mm	160 Nm	1	16R-3/8
1/2" in	16 mm	420 Nm	1	16R-1/2
3/4" in	22 mm	1200 Nm	1	22R-3/4

Fixed Square Head with Spigot Connector







16F/22F





				
1/4" in	16 mm	20 Nm	1	16F-1/4
3/8" in	16 mm	160 Nm	1	16F-3/8
1/2" in	16 mm	420 Nm	1	16F-1/2
3/4" in	22 mm	1200 Nm	1	22F-3/4

Open End Metric Wrench with Spigot Connector



167/227





				
7 mm	16 mm	9 Nm	1	167-7
8 mm	16 mm	13 Nm	1	167-8
9 mm	16 mm	18 Nm	1	167-9
10 mm	16 mm	24 Nm	1	167-10
11 mm	16 mm	32 Nm	1	167-11
12 mm	16 mm	41 Nm	1	167-12

				
13 mm	16 mm	51 Nm	1	167-13
14 mm	16 mm	63 Nm	1	167-14
15 mm	16 mm	77 Nm	1	167-15
16 mm	16 mm	92 Nm	1	167-16
17 mm	16 mm	109 Nm	1	167-17
18 mm	16 mm	125 Nm	1	167-18
19 mm	16 mm	145 Nm	1	167-19
20 mm	16 mm	160 Nm	1	167-20
21 mm	16 mm	190 Nm	1	167-21
22 mm	16 mm	220 Nm	1	167-22
23 mm	16 mm	250 Nm	1	167-23
24 mm	16 mm	280 Nm	1	167-24
25 mm	16 mm	320 Nm	1	167-25
26 mm	16 mm	360 Nm	1	167-26
27 mm	16 mm	360 Nm	1	167-27
28 mm	16 mm	360 Nm	1	167-28
30 mm	16 mm	360 Nm	1	167-30
32 mm	16 mm	360 Nm	1	167-32
36 mm	16 mm	360 Nm	1	167-36
22 mm	22 mm	1200 Nm	1	227-22
24 mm	22 mm	1200 Nm	1	227-24
27 mm	22 mm	1200 Nm	1	227-27
30 mm	22 mm	1200 Nm	1	227-30
32 mm	22 mm	1200 Nm	1	227-32
34 mm	22 mm	1200 Nm	1	227-34
36 mm	22 mm	1200 Nm	1	227-36
41 mm	22 mm	1200 Nm	1	227-41
46 mm	22 mm	1200 Nm	1	227-46

Open-End Imperial Wrench with Spigot Connector



167





				
5/16 in	16 mm	34 Nm	1	167-5/16
3/8 in	16 mm	45 Nm	1	167-3/8
7/16 in	16 mm	72 Nm	1	167-7/16
1/2 in	16 mm	51 Nm	1	167-1/2
9/16 in	16 mm	77 Nm	1	167-9/16
5/8 in	16 mm	92 Nm	1	167-5/8
11/16 in	16 mm	109 Nm	1	167-11/16
3/4 in	16 mm	145 Nm	1	167-3/4
13/16 in	16 mm	190 Nm	1	167-13/16
7/8 in	16 mm	220 Nm	1	167-7/8
15/16 in	16 mm	280 Nm	1	167-15/16
1 in	16 mm	360 Nm	1	167-1
1.1/16 in	16 mm	360 Nm	1	167-1.1/16
1.1/8 in	16 mm	360 Nm	1	167-1.1/8
1.3/16 in	16 mm	360 Nm	1	167-1.3/16
1.1/4 in	16 mm	360 Nm	1	167-1.1/4



Ring End Metric Wrench with Spigot Connector







168/228





				
mm	mm	Nm		
7 mm	16 mm	25 Nm	1	168-7
8 mm	16 mm	34 Nm	1	168-8
9 mm	16 mm	45 Nm	1	168-9
10 mm	16 mm	58 Nm	1	168-10
11 mm	16 mm	72 Nm	1	168-11
12 mm	16 mm	89 Nm	1	168-12
13 mm	16 mm	105 Nm	1	168-13
14 mm	16 mm	125 Nm	1	168-14
15 mm	16 mm	150 Nm	1	168-15
16 mm	16 mm	175 Nm	1	168-16
17 mm	16 mm	200 Nm	1	168-17
18 mm	16 mm	230 Nm	1	168-18
19 mm	16 mm	260 Nm	1	168-19
20 mm	16 mm	290 Nm	1	168-20
21 mm	16 mm	330 Nm	1	168-21
22 mm	16 mm	360 Nm	1	168-22
23 mm	16 mm	360 Nm	1	168-23
24 mm	16 mm	360 Nm	1	168-24
26 mm	16 mm	360 Nm	1	168-26
27 mm	16 mm	360 Nm	1	168-27
22 mm	22 mm	1200 Nm	1	228-22
24 mm	22 mm	1200 Nm	1	228-24
27 mm	22 mm	1200 Nm	1	228-27
30 mm	22 mm	1200 Nm	1	228-30
32 mm	22 mm	1200 Nm	1	228-32
34 mm	22 mm	1200 Nm	1	228-34
36 mm	22 mm	1200 Nm	1	228-36
41 mm	22 mm	1200 Nm	1	228-41
46 mm	22 mm	1200 Nm	1	228-46

Ring End Imperial Wrench with Spigot Connector



168

				
in	mm	Nm		
5/16 in	16 mm	34 Nm	1	168-5/16
3/8 in	16 mm	58 Nm	1	168-3/8
7/16 in	16 mm	89 Nm	1	168-7/16
1/2 in	16 mm	105 Nm	1	168-1/2

				
in	mm	Nm		
9/16 in	16 mm	125 Nm	1	168-9/16
5/8 in	16 mm	125 Nm	1	168-5/8
11/16 in	16 mm	125 Nm	1	168-11/16
3/4 in	16 mm	260 Nm	1	168-3/4
13/16 in	16 mm	290 Nm	1	168-13/16
7/8 in	16 mm	360 Nm	1	168-7/8
15/16 in	16 mm	360 Nm	1	168-15/16
1 in	16 mm	360 Nm	1	168-1
1.1/16 in	16 mm	360 Nm	1	168-1.1/16
1.3/16 in	16 mm	360 Nm	1	168-1.3/16

Flare Nut End Metric Wrench with Spigot Connector



169

				
mm	mm	Nm		
7 mm	16 mm	6 Nm	1	169-7
8 mm	16 mm	8 Nm	1	169-8
9 mm	16 mm	10 Nm	1	169-9
10 mm	16 mm	12 Nm	1	169-10
11 mm	16 mm	16 Nm	1	169-11
12 mm	16 mm	16 Nm	1	169-12
13 mm	16 mm	28 Nm	1	169-13
14 mm	16 mm	31 Nm	1	169-14
15 mm	16 mm	38 Nm	1	169-15
16 mm	16 mm	46 Nm	1	169-16
17 mm	16 mm	53 Nm	1	169-17
18 mm	16 mm	65 Nm	1	169-18
19 mm	16 mm	74 Nm	1	169-19
20 mm	16 mm	86 Nm	1	169-20
21 mm	16 mm	100 Nm	1	169-21
22 mm	16 mm	115 Nm	1	169-22
23 mm	16 mm	125 Nm	1	169-23
24 mm	16 mm	145 Nm	1	169-24
27 mm	16 mm	160 Nm	1	169-27



Power Tool Accessories



HOLESAWS

Sandflex® Bi-Metal Holesaws for Metal/
Wood Boards 14 mm-210 mm



3830



14 mm	1	3830-14-C
16 mm	1	3830-16-C
17 mm	1	3830-17-C
19 mm	1	3830-19-C
20 mm	1	3830-20-C
21 mm	1	3830-21-C
22 mm	1	3830-22-C
24 mm	1	3830-24-C
25 mm	1	3830-25-C
27 mm	1	3830-27-C
29 mm	1	3830-29-C
30 mm	1	3830-30-C
32 mm	1	3830-32-C
33 mm	1	3830-33-C
35 mm	1	3830-35-C
37 mm	1	3830-37-C
38 mm	1	3830-38-C
40 mm	1	3830-40-C
41 mm	1	3830-41-C
43 mm	1	3830-43-C
44 mm	1	3830-44-C
46 mm	1	3830-46-C
48 mm	1	3830-48-C
50 mm	1	3830-50-C
51 mm	1	3830-51-C
52 mm	1	3830-52-C
54 mm	1	3830-54-C
55 mm	1	3830-55-C
56 mm	1	3830-56-C
57 mm	1	3830-57-C
59 mm	1	3830-59-C
60 mm	1	3830-60-C
64 mm	1	3830-64-C
65 mm	1	3830-65-C
67 mm	1	3830-67-C
68 mm	1	3830-68-C
70 mm	1	3830-70-C
73 mm	1	3830-73-C
76 mm	1	3830-76-C
79 mm	1	3830-79-C
83 mm	1	3830-83-C
86 mm	1	3830-86-C
89 mm	1	3830-89-C
92 mm	1	3830-92-C
95 mm	1	3830-95-C
98 mm	1	3830-98-C
102 mm	1	3830-102-C
105 mm	1	3830-105-C
108 mm	1	3830-108-C



111 mm	1	3830-111-C
114 mm	1	3830-114-C
121 mm	1	3830-121-C
127 mm	1	3830-127-C
133 mm	1	3830-133-C
140 mm	1	3830-140-C
146 mm	1	3830-146-C
152 mm	1	3830-152-C
14 mm	6	3830-14-VIP
16 mm	6	3830-16-VIP
17 mm	6	3830-17-VIP
19 mm	6	3830-19-VIP
20 mm	6	3830-20-VIP
21 mm	6	3830-21-VIP
22 mm	6	3830-22-VIP
24 mm	6	3830-24-VIP
25 mm	6	3830-25-VIP
27 mm	6	3830-27-VIP
29 mm	6	3830-29-VIP
30 mm	6	3830-30-VIP
32 mm	6	3830-32-VIP
33 mm	6	3830-33-VIP
35 mm	6	3830-35-VIP
37 mm	6	3830-37-VIP
38 mm	6	3830-38-VIP
40 mm	6	3830-40-VIP
41 mm	6	3830-41-VIP
43 mm	6	3830-43-VIP
44 mm	6	3830-44-VIP
46 mm	6	3830-46-VIP
48 mm	6	3830-48-VIP
50 mm	6	3830-50-VIP
51 mm	6	3830-51-VIP
52 mm	4	3830-52-VIP
54 mm	4	3830-54-VIP
55 mm	4	3830-55-VIP
56 mm	4	3830-56-VIP
57 mm	4	3830-57-VIP
59 mm	4	3830-59-VIP
60 mm	4	3830-60-VIP
62 mm	4	3830-62-VIP
64 mm	4	3830-64-VIP
65 mm	4	3830-65-VIP
67 mm	4	3830-67-VIP
68 mm	4	3830-68-VIP
70 mm	4	3830-70-VIP
73 mm	4	3830-73-VIP
76 mm	4	3830-76-VIP
79 mm	4	3830-79-VIP
83 mm	4	3830-83-VIP
86 mm	4	3830-86-VIP
89 mm	4	3830-89-VIP
92 mm	4	3830-92-VIP
95 mm	4	3830-95-VIP
98 mm	4	3830-98-VIP
102 mm	4	3830-102-VIP
105 mm	4	3830-105-VIP
108 mm	4	3830-108-VIP
111 mm	4	3830-111-VIP
114 mm	4	3830-114-VIP
121 mm	1	3830-121-VIP
127 mm	1	3830-127-VIP
133 mm	1	3830-133-VIP
140 mm	1	3830-140-VIP
146 mm	1	3830-146-VIP
152 mm	1	3830-152-VIP
168 mm	1	3830-168
177 mm	1	3830-177-HIGH
210 mm	1	3830-210

Sandflex® Bi-Metal Holesaws, 4 pack



3830-4P



4	19 mm	1	3830-19-4P
4	20 mm	1	3830-20-4P
4	22 mm	1	3830-22-4P
4	25 mm	1	3830-25-4P
4	27 mm	1	3830-27-4P
4	29 mm	1	3830-29-4P
4	30 mm	1	3830-30-4P
4	32 mm	1	3830-32-4P
4	35 mm	1	3830-35-4P

Sandflex® Bi-Metal Holesaw Set 20x4 mm + 25x4 mm - 11 pcs



3834-CP-20/25



600 g	1	3834-CP-20/25
-------	---	---------------

3830-20-Cx 4, 3830-25-Cx 4

3834-ARBR-930

3834-DRLx 2



Sandflex® Bi-Metal Holesaw Set 20–76 mm - 10 pcs



3834-PROMO-82

1188 g	1	3834-PROMO-82

- 3830-20-C, 3830-25-C, 3830-30-C, 3830-35-C, 3830-44-C, 3830-51-C, 3830-64-C, 3830-76-C
- 3834-ARBR-930
- 3834-ARBR-11152QC

Sandflex® Bi-Metal Holesaw Set 19–76 mm - 14 pcs



3834-PROMO-122-76

1441 g	1	3834-PROMO-122-76

- 3830-19-C, 3830-20-C, 3830-22-C, 3830-25-C, 3830-27-C, 3830-32-C, 3830-35-C, 3830-38-C, 3830-40-C, 3830-51-C, 3830-64-C, 3830-76-C
- 3834-ARBR-930
- 3834-ARBR-9100

Sandflex® Bi-Metal Holesaw Set 51 mm-111 mm - 6 Pcs



3834-42

2025 g	1	3834-SET-42

- 3830-51-VIP, 3830-76-VIP, 3830-86-VIP, 3830-111-VIP
- 3834-ARBR-9100
- 3834-ES

Sandflex® Bi-Metal Holesaw Set 16–44 mm - 14 pcs



3834-PROMO-122

1100 g	1	3834-PROMO-122

- 3830-16-C, 3830-20-Cx 2, 3830-22-C, 3830-25-Cx 2, 3830-29-C, 3830-32-C, 3830-35-Cx 2, 3830-38-C, 3830-44-C
- 3834-ARBR-930
- 3834-ARBR-11152QC

Sandflex® Bi-Metal Holesaw Set 35–83 mm - 9 pcs



3834-SET-72-35/83

1613 g	1	3834-SET-72-35/83

- 3830-35-C, 3830-40-C, 3830-44-C, 3830-51-C, 3830-57-C, 3830-68-C, 3830-83-C
- 3834-ARBR-9100
- 3834-DRL

Sandflex® Bi-Metal Holesaw Set 19 mm-79 mm - 13 Pcs



3834-53

2370 g	1	3834-SET-53

- 3830-19-VIP, 3830-22-VIP, 3830-25-VIP, 3830-29-VIP, 3830-30-VIP, 3830-35-VIP, 3830-37-VIP, 3830-41-VIP, 3830-52-VIP, 3830-60-VIP, 3830-79-VIP
- 3834-ARBR-930
- 3834-ARBR-9100



Sandflex® Bi-Metal Holesaw Set 51 mm-114 mm - 7 Pcs



3834-61



3145 g



1 3834-SET-61

3830-44-VIP, 3830-51-VIP, 3830-57-VIP,
3830-73-VIP, 3830-86-VIP, 3830-114-VIP



3834-ARBR-9100



Sandflex® Bi-Metal Holesaw Set 19 mm-48 mm - 8 Pcs



3834-62



1050 g



1 3834-SET-62

+ one brush

3830-19-VIP, 3830-21-VIP, 3830-22-VIP,
3830-29-VIP, 3830-38-VIP, 3830-48-VIP



3834-ARBR-930



3834-ARBR-9100



Sandflex® Bi-Metal Holesaw Set for Metal/Wood Boards 16 mm-50 mm - 8 Pcs



3834-62-16/50



1065 g



1 3834-SET-62-16/50

One brush

3830-16-VIP, 3830-20-VIP, 3830-25-VIP,
3830-32-VIP, 3830-40-VIP, 3830-50-VIP



3834-ARBR-9100



3834-ARBR-930



Sandflex® Bi-Metal Holesaw Set for Metal/Wood Boards 22 mm-64 mm - 9 Pcs



3834-65-22/64



1625 g



1 3834-SET-65-22/64

3830-22-VIP, 3830-29-VIP, 3830-35-VIP,
3830-44-VIP, 3830-51-VIP, 3830-64-VIP



3834-ARBR-1130



3834-ARBR-11152



3834-DRL



Sandflex® Bi-Metal Holesaw Set for Metal/Wood Boards 16 mm-51 mm - 9 Pcs



3834-65-16/51



1465 g



1 3834-SET-65-16/51

3830-16-VIP, 3830-20-VIP, 3830-25-VIP,
3830-32-VIP, 3830-40-VIP, 3830-51-VIP



3834-ARBR-1130



3834-ARBR-11152



3834-DRL



Sandflex® Bi-Metal Holesaw Set 19 mm-64 mm - 9 Pcs



3834-72



1080 g



1 3834-SET-72

3830-19-VIP, 3830-22-VIP, 3830-29-VIP, 3830-35-VIP,
3830-44-VIP, 3830-51-VIP, 3830-64-VIP



3834-ARBR-930



3834-ARBR-9100



Sandflex® Bi-Metal Holesaw Set 16 mm-92 mm - 9 Pcs



3834-73



2080 g



1 3834-SET-73

3830-16-VIP, 3830-22-VIP, 3830-51-VIP, 3830-57-VIP, 3830-73-VIP, 3830-76-VIP, 3830-92-VIP

3834-ARBR-930

3834-ARBR-9100

Sandflex® Bi-Metal Holesaw Set 22 mm-68 mm - 10 Pcs



3834-73-22/68



2170 g



1 3834-SET-73-22/68

3830-22-VIP, 3830-29-VIP, 3830-35-VIP, 3830-44-VIP, 3830-51-VIP, 3830-64-VIP, 3830-68-VIP

3834-ARBR-1130

3834-ARBR-11152

3834-DRL

Sandflex® Bi-Metal Holesaw Set 16 mm-86 mm - 13 Pcs



3834-SET-77



3325 g



1 3834-SET-77

3830-16-VIP, 3830-20-VIP, 3830-25-VIP, 3830-32-VIP, 3830-41-VIP, 3830-51-VIP, 3830-73-VIP, 3830-76-VIP, 3830-83-VIP, 3830-86-VIP

3834-ARBR-930

3834-ARBR-9100

3834-DRL

Sandflex® Bi-Metal Holesaw Set 25-114 mm - 12 pcs



3834-SET-84-ES



3600 g



1 3834-SET-84-ES

3830-25-C, 3830-30-C, 3830-35-C, 3830-51-C, 3830-54-C, 3830-76-C, 3830-92-C, 3830-114-C

3834-ARBR-930ESM, 3834-ARBR-9100ESM

3834-DRL-HSS-ES

3834-UPSIZ

Sandflex® Bi-Metal Holesaw Set 25 mm-114 mm - 12 Pcs



3834-86



2540 g



1 3834-SET-86

3830-25-VIP, 3830-32-VIP, 3830-35-VIP, 3830-51-VIP, 3830-54-VIP, 3830-76-VIP, 3830-92-VIP, 3830-114-VIP

3834-ARBR-1130

3834-ARBR-11152

3834-DRLx 2

3834-ADP

Sandflex® Bi-Metal Holesaw Set 19 mm-65 mm - 12 Pcs



3834-87



1925 g



1 3834-SET-87

3830-19-VIP, 3830-22-VIP, 3830-29-VIP, 3830-38-VIP, 3830-43-VIP, 3830-48-VIP, 3830-52-VIP, 3830-65-VIP

3834-ARBR-930

3834-ARBR-9100

3834-DRL

3834-ES



Sandflex® Bi-Metal Holesaw Set for Metal/
Wood Boards 16 mm-83 mm - 11 Pcs



3834-92



1440 g



1 3834-SET-92

3830-16-VIP, 3830-22-VIP, 3830-25-VIP,
3830-29-VIP, 3830-32-VIP, 3830-41-VIP,
3830-51-VIP, 3830-73-VIP, 3830-83-VIP



3834-ARBR-930



3834-ARBR-9100



Sandflex® Bi-Metal Holesaw Set 16-83
mm - 12 pcs



3834-93



2360 g



1 3834-SET-93

3830-16-VIP, 3830-20-VIP, 3830-25-VIP,
3830-32-VIP, 3830-40-VIP, 3830-51-VIP,
3830-67-VIP, 3830-76-VIP, 3830-83-VIP



3834-ARBR-930



3834-ARBR-9100QC



3834-DRL



Sandflex® Bi-Metal Holesaw Set for Metal/
Wood Boards 16 mm-67 mm - 11 Pcs



3834-94



1815 g



1 3834-SET-94

3830-16-VIP, 3830-19-VIP, 3830-22-VIP,
3830-25-VIP, 3830-30-VIP, 3830-35-VIP,
3830-41-VIP, 3830-51-VIP, 3830-67-VIP



3834-ARBR-1130



3834-ARBR-11152



Sandflex® Bi-Metal Holesaw Set 16 mm-67
mm - 11 Pcs



3834-103



2015 g



1 3834-SET-103

3830-16-VIP, 3830-19-VIP, 3830-24-VIP,
3830-29-VIP, 3830-38-VIP, 3830-44-VIP,
3830-57-VIP, 3830-67-VIP



3834-ARBR-1130



3834-ARBR-11152



3834-DRL



Sandflex® Bi-Metal Holesaw Set 16 mm-83
mm - 18 Pcs



3834-SET-152



3770 g



1 3834-SET-152

3830-16-VIP, 3830-19-VIP, 3830-22-VIP,
3830-25-VIP, 3830-32-VIP, 3830-35-VIP,
3830-44-VIP, 3830-51-VIP, 3830-57-VIP,
3830-60-VIP, 3830-65-VIP, 3830-68-VIP,
3830-73-VIP, 3830-76-VIP, 3830-83-VIP



3834-ARBR-930



3834-ARBR-9100



3834-DRLx 2



Superior™ Multi Construction Holesaws for Wood and Brick 19 mm-225 mm



3833

19 mm	1	3833-19-C
20 mm	1	3833-20-C
22 mm	1	3833-22-C
25 mm	1	3833-25-C
27 mm	1	3833-27-C
29 mm	1	3833-29-C
30 mm	1	3833-30-C
32 mm	1	3833-32-C
35 mm	1	3833-35-C
38 mm	1	3833-38-C
40 mm	1	3833-40-C
41 mm	1	3833-41-C
44 mm	1	3833-44-C
48 mm	1	3833-48-C
51 mm	1	3833-51-C
54 mm	1	3833-54-C
56 mm	1	3833-56-C
57 mm	1	3833-57-C
60 mm	1	3833-60-C
62 mm	1	3833-62-C
64 mm	1	3833-64-C
65 mm	1	3833-65-C
67 mm	1	3833-67-C
68 mm	1	3833-68-C
70 mm	1	3833-70-C
71 mm	1	3833-71-C
73 mm	1	3833-73-C
74 mm	1	3833-74-C
76 mm	1	3833-76-C
77 mm	1	3833-77-C
78 mm	1	3833-78-C
79 mm	1	3833-79-C
83 mm	1	3833-83-C
86 mm	1	3833-86-C
89 mm	1	3833-89-C
92 mm	1	3833-92-C
95 mm	1	3833-95-C
98 mm	1	3833-98-C
102 mm	1	3833-102-C
105 mm	1	3833-105-C
108 mm	1	3833-108-C
109 mm	1	3833-109-C
111 mm	1	3833-111-C
114 mm	1	3833-114-C
121 mm	1	3833-121-C
127 mm	1	3833-127-C
133 mm	1	3833-133-C
140 mm	1	3833-140-C
152 mm	1	3833-152-C
159 mm	1	3833-159-C
168 mm	1	3833-168
177 mm	1	3833-177
210 mm	1	3833-210
225 mm	1	3833-225

Superior™ Multi Construction Holesaw Set 32-83 mm - 6 pcs



3833-PROMO-42

1489 g	1	3833-PROMO-42
3833-32-C, 3833-51-C, 3833-76-C, 3833-83-C		
3834-ARBR-9100EL		
3834-UPSIZ		

Superior™ Multi Construction Holesaw Set 19 mm-64 mm - 10 Pcs



3833-SET-101

2.75 kg	1	3833-SET-101
3833-19-C, 3833-22-C, 3833-29-C, 3833-35-C, 3833-44-C, 3833-51-C, 3833-64-C		
3834-ARBR-930EL, 3834-ARBR-9100EL		
3834-DRL-EL		

Superior™ Multi Construction Holesaw Set 19 mm-86 mm - 14 Pcs



3833-SET-201

4.35 kg	1	3833-SET-201
3833-19-C, 3833-20-C, 3833-25-C, 3833-32-C, 3833-41-C, 3833-51-C, 3833-73-C, 3833-76-C, 3833-83-C, 3833-86-C		
3834-ARBR-930EL, 3834-ARBR-9100EL		
3834-DRL-EL		
3834-UPSIZ		

Superior™ Multi Construction Holesaw Set 19 mm-83 mm - 14 Pcs



3833-SET-202

4.1 kg	1	3833-SET-202
3833-19-C, 3833-20-C, 3833-25-C, 3833-32-C, 3833-41-C, 3833-51-C, 3833-57-C, 3833-60-C, 3833-73-C, 3833-83-C		
3834-ARBR-930EL, 3834-ARBR-9100EL		
3834-DRL-EL		
3834-UPSIZ		



Superior™ Multi Construction Holesaw Set
19 mm-78 mm - 14 Pcs



3833-SET-203

kg 4.65 kg 1 3833-SET-203

- 3833-19-C, 3833-22-C, 3833-54-C, 3833-56-C, 3833-57-C, 3833-62-C, 3833-68-C, 3833-71-C, 3833-74-C, 3833-78-C
- 3834-ARBR-930EL, 3834-ARBR-9100EL
- 3834-DRL-EL
- 3834-UPSIZE

Superior™ Multi Construction Holesaw Set
22 mm-67 mm - 9 Pcs



3833-SET-205

kg 2.81 kg 1 3833-SET-205

- 3833-22-C, 3833-35-C, 3833-44-C, 3833-51-C, 3833-67-C
- 3834-ARBR-930EL, 3834-ARBR-9100EL
- 3834-DRL-EL
- 3834-UPSIZE

Superior™ Multi Construction Holesaw Set
19 mm-76 mm - 15 Pcs



3833-SET-208

kg 3.72 kg 1 3833-SET-208

- 3833-19-C, 3833-22-C, 3833-25-C, 3833-32-C, 3833-35-C, 3833-38-C, 3833-44-C, 3833-51-C, 3833-57-C, 3833-68-C, 3833-76-C
- 3834-ARBR-930EL, 3834-ARBR-9100EL
- 3834-DRL-EL
- 3834-UPSIZE

Superior™ Multi Construction Holesaw Set
32 mm-86 mm - 10 Pcs



3833-SET-204

kg 3.88 kg 1 3833-SET-204

- 3833-32-C, 3833-41-C, 3833-51-C, 3833-73-C, 3833-76-C, 3833-83-C, 3833-86-C
- 3834-ARBR-9100EL
- 3834-DRL-EL
- 3834-UPSIZE

Superior™ Multi Construction Holesaw Set
19 mm-83 mm - 14 Pcs



3833-SET-207

kg 3.90 kg 1 3833-SET-207

- 3833-19-C, 3833-22-C, 3833-25-C, 3833-35-C, 3833-44-C, 3833-51-C, 3833-64-C, 3833-67-C, 3833-76-C, 3833-83-C
- 3834-ARBR-930EL, 3834-ARBR-9100EL
- 3834-DRL-EL
- 3834-UPSIZE

Superior™ Multi Construction Holesaw Set
25 mm-114 mm - 12 Pcs



3833-SET-301

kg 4.38 kg 1 3833-SET-301

- 3833-25-C, 3833-32-C, 3833-35-C, 3833-51-C, 3833-54-C, 3833-76-C, 3833-92-C, 3833-114-C
- 3834-ARBR-930EL, 3834-ARBR-9100EL
- 3834-DRL-EL
- 3834-UPSIZE

Superior™ Multi Construction Holesaw Set
51 mm-111 mm - 7 Pcs



3833-SET-302

kg		
3.51 kg	1	3833-SET-302

3833-51-C, 3833-76-C, 3833-86-C, 3833-111-C	
3834-ARBR-9100EL	
3834-DRL-EL	
3834-UPSIZE	

Superior™ Multi Construction Holesaw Set
35 mm-114 mm - 11 Pcs



3833-SET-303

kg		
4.17 kg	1	3833-SET-303

3833-35-C, 3833-40-C, 3833-51-C, 3833-57-C, 3833-60-C, 3833-74-C, 3833-83-C, 3833-105-C	
3834-ARBR-9100EL	
3834-DRL-EL	
3834-UPSIZE	

Superior™ Multi Construction Holesaw Set
19 mm-114 mm - 13 Pcs



3833-SET-304

kg		
4.20 kg	1	3833-SET-304

3833-19-C, 3833-25-C, 3833-32-C, 3833-35-C, 3833-51-C, 3833-54-C, 3833-76-C, 3833-92-C, 3833-114-C	
3834-ARBR-930EL, 3834-ARBR-9100EL	
3834-DRL-EL	
3834-UPSIZE	

Carbide Tipped Holesaws for Fibreglass/
Masonry 14 mm-152 mm



3832

kg		
14 mm	6	3832-14
16 mm	6	3832-16
17 mm	6	3832-17
19 mm	6	3832-19

20 mm	6	3832-20
21 mm	6	3832-21
22 mm	6	3832-22
24 mm	6	3832-24
25 mm	6	3832-25
27 mm	6	3832-27
29 mm	6	3832-29
30 mm	6	3832-30
32 mm	6	3832-32
33 mm	6	3832-33
35 mm	6	3832-35
37 mm	6	3832-37
38 mm	6	3832-38
40 mm	6	3832-40
41 mm	6	3832-41
43 mm	6	3832-43
44 mm	6	3832-44
46 mm	6	3832-46
48 mm	6	3832-48
51 mm	6	3832-51
52 mm	4	3832-52
54 mm	4	3832-54
56 mm	4	3832-56
57 mm	4	3832-57
59 mm	4	3832-59
60 mm	4	3832-60
64 mm	4	3832-64
65 mm	4	3832-65
67 mm	4	3832-67
68 mm	4	3832-68
70 mm	4	3832-70
73 mm	4	3832-73
76 mm	4	3832-76
79 mm	4	3832-79
83 mm	4	3832-83
86 mm	4	3832-86
89 mm	4	3832-89
92 mm	4	3832-92
95 mm	4	3832-95
98 mm	4	3832-98
102 mm	4	3832-102
105 mm	4	3832-105
108 mm	4	3832-108
111 mm	4	3832-111
114 mm	4	3832-114
121 mm	1	3832-121
127 mm	1	3832-127
133 mm	1	3832-133
140 mm	1	3832-140
146 mm	1	3832-146
152 mm	1	3832-152



Carbide Tipped Holesaws for Stainless Steel 16–127 mm



3832-C

Size (mm)	Quantity	Part Number
16 mm	1	3832-16-C
19 mm	1	3832-19-C
20 mm	1	3832-20-C
22 mm	1	3832-22-C
24 mm	1	3832-24-C
25 mm	1	3832-25-C
29 mm	1	3832-29-C
30 mm	1	3832-30-C
32 mm	1	3832-32-C
35 mm	1	3832-35-C
38 mm	1	3832-38-C
41 mm	1	3832-41-C
44 mm	1	3832-44-C
46 mm	1	3832-46-C
48 mm	1	3832-48-C
51 mm	1	3832-51-C
54 mm	1	3832-54-C
57 mm	1	3832-57-C
60 mm	1	3832-60-C
64 mm	1	3832-64-C
73 mm	1	3832-73-C
76 mm	1	3832-76-C
83 mm	1	3832-83-C
86 mm	1	3832-86-C
92 mm	1	3832-92-C
102 mm	1	3832-102-C
114 mm	1	3832-114-C
127 mm	1	3832-127-C

3832-25-C, 3832-30-C, 3832-35-C, 3832-51-C, 3832-54-C, 3832-76-C, 3832-92-C, 3832-114-C	
3834-ARBR-9100ESM, 3834-ARBR-930ESM	
3834-DRL-HSS-ES	
3834-UPSIZ	

Carbide Tipped Holesaw Sets for Stainless Steel 16 mm-114 mm - 20 Pcs



3832-SET-164-ES

4800 g	1	3832-SET-164-ES

3832-16-C, 3832-20-C, 3832-25-C, 3832-32-C, 3832-35-C, 3832-41-C, 3832-44-C, 3832-46-C, 3832-51-C, 3832-54-C, 3832-57-C, 3832-60-C, 3832-64-C, 3832-73-C, 3832-76-C, 3832-83-C, 3832-86-C, 3832-92-C, 3832-114-C	
3834-ARBR-9100ESM, 3834-ARBR-930ESM	
3834-DRL-HSS-ES	
3834-UPSIZ	

Holesaw Set, Mixed 35–114 mm - 10 pcs



3835-SET-64

10	3870 g	1 3835-SET-64

3830-35-C, 3830-73-C	
3833-35-C, 3833-73-C, 3833-76-C, 3833-114-C	
3834-ARBR-9100QC-C	
3834-ARBR-9100EL	
3834-DRL-EL	
3834-DRL	

Carbide Tipped Holesaw Sets for Stainless Steel 25 mm -114 mm - 12 Pcs



3832-SET-84-ES

3600 g	1	3832-SET-84-ES

Holesaw Set, Mixed 12–86 mm - 18 pcs



3835-SET-711

18	3680 g	1 3835-SET-711

3830-35-C, 3830-41-C, 3830-51-C, 3830-73-C, 3830-76-C, 3830-83-C, 3830-86-C	
9629-12, 9629-14, 9629-16, 9629-18, 9629-20, 9629-22, 9629-25, 9629-28, 9629-32	
3834-ARBR-9100ESM	
3834-DRL-HSS-ES	

Arbors with Quick-Eject Function - Saves time and energy



3834-ARBR-EL/ES

19-30 mm	8.5 mm	1 3834-ARBR-930EL
32-159 mm	8.5 mm	1 3834-ARBR-9100EL
16-30 mm	8.5 mm	1 3834-ARBR-930ESM
32-152 mm	8.5 mm	1 3834-ARBR-9100ESM

Pilot Drills for Long Quick-Eject Arbors



3834-DRL-EL

6.35 mm	202 mm	1 3834-DRL-EL

Pilot Drills for Short Quick-Eject Arbors



3834-DRL-HSS-ES

Ø	L	Icons	Part No.
6.35 mm	138 mm		1 3834-DRL-ES
6.35 mm	138 mm		1 3834-DRL-HSS-ES

Upsize Adaptors for Enlarging Existing Holes



3834-upsizer

L	Icons	Part No.
20,5 mm		1 3834-UPSIZER

Arbors for small holesaws 14-30mm



3834-ARBR

Ø	Length	Icons	Part No.
14-30 mm	6.4 mm		1 3834-ARBR-630
14-30 mm	6.4 mm		1 3834-ARBR-630-C
14-30 mm	6.4 mm		1 3834-ARBR-730
14-30 mm	6.4 mm		1 3834-ARBR-730-C
14-30 mm	8.5 mm		1 3834-ARBR-930
14-30 mm	8.5 mm		1 3834-ARBR-930-C
14-30 mm	11.1 mm		4 3834-ARBR-1130
14-30 mm	11.1 mm		1 3834-ARBR-1130-C

Arbors with Quick-Change function



3834-ARBR-QC

Ø	Length	Icons	Part No.
32-152 mm	8.5 mm		1 3834-ARBR-9100
32-152 mm	8.5 mm		1 3834-ARBR-9100-C
32-152 mm	8.5 mm		1 3834-ARBR-9100QC
32-152 mm	8.5 mm		1 3834-ARBR-9100QC-C
32-210 mm	11.1 mm		1 3834-ARBR-11152
32-210 mm	11.1 mm		1 3834-ARBR-11152-C
32-210 mm	11.1 mm		1 3834-ARBR-11152QC
32-210 mm	11.1 mm		1 3834-ARBR-11152QC-C
32-210 mm	15.4 mm		1 3834-ARBR-16152
32-210 mm	15.4 mm		1 3834-ARBR-16152QC

Arbors with SDS+ Drive



3834-ARBR-SD

Ø	Drive	Icons	Part No.
14-30 mm	SDS+ mm		1 3834-ARBR-SD30
32-210 mm	SDS+ mm		1 3834-ARBR-SD152QC

HSS Pilot Drills for Arbors



3834-DRL

Ø	L	Icons	Part No.
6.35 mm	81 mm		1 3834-DRL

Carbide Tipped Pilot Drills for Arbors



3834-DRL-CT/L

Ø	L	Icons	Part No.
6.35 mm	81 mm		1 3834-DRL-CT
6.35 mm	114 mm		1 3834-DRL-L

Arbor Extensions



3834-EXT

Ø	L	Icons	Part No.
11.1 mm	330 mm		1 3834-EXT-1
8.5 mm	330 mm		1 3834-EXT-2

Ejector Spring for arbors



3834-ES

Weight	Icons	Part No.
10 g		1 3834-ES



Arbor Adaptor for 3834-ARBR-630, 730, 930 and 1130



3834-ADP

20 g	1	3834-ADP

Spare Screws for Arbors



3834-SCREWS

9 g	1	3834-M6X29-SET
9 g	1	3834-M8X5-SET
9 g	1	3834-M8X6-SET
9 g	1	3834-M8X10-SET

SABRE SAWBLADES

Sandflex® Bi-Metal Sabre Sawblade Set for Metal



3940-M

100 mm	14	10	3940-100-14-ST-2P
100 mm	14	5	3940-100-14-ST-5P
100 mm	14	1	3940-100-14-ST-10P
100 mm	18	10	3940-100-18-ST-2P
100 mm	18	5	3940-100-18-ST-5P
100 mm	18	1	3940-100-18-ST-10P
150 mm	14	5	3940-150-14-ST-2P
150 mm	14	5	3940-150-14-ST-5P

150 mm	14	1	3940-150-14-ST-10P
150 mm	14	1	3940-150-14-ST-100P
150 mm	18	10	3940-150-18-ST-2P
150 mm	18	5	3940-150-18-ST-5P
150 mm	18	1	3940-150-18-ST-10P
150 mm	18	1	3940-150-18-ST-100P
228 mm	14	10	3940-228-14-ST-2P
228 mm	14	5	3940-228-14-ST-5P
228 mm	14	1	3940-228-14-ST-10P
228 mm	14	1	3940-228-14-ST-100P
228 mm	18	10	3940-228-18-ST-2P
228 mm	18	5	3940-228-18-ST-5P
228 mm	18	1	3940-228-18-ST-10P
228 mm	18	1	3940-228-18-ST-100P
300 mm	14	5	3940-300-14-ST-2P
300 mm	14	5	3940-300-14-ST-5P
300 mm	14	1	3940-300-14-ST-10P
300 mm	14	1	3940-300-14-ST-100P
300 mm	18	10	3940-300-18-ST-2P
300 mm	18	5	3940-300-18-ST-5P
300 mm	18	1	3940-300-18-ST-10P
300 mm	18	1	3940-300-18-ST-100P

Sandflex® Bi-Metal Sabre Sawblade Set for Heavy Metal



3940-HM

150 mm	8/12	10	3940-150-8/12-ST-2P
150 mm	8/12	5	3940-150-8/12-ST-5P
150 mm	8/12	1	3940-150-8/12-ST-10P
150 mm	8/12	1	3940-150-8/12-ST-100P
228 mm	8/12	10	3940-228-8/12-ST-2P
228 mm	8/12	5	3940-228-8/12-ST-5P
228 mm	8/12	1	3940-228-8/12-ST-10P
228 mm	8/12	1	3940-228-8/12-ST-100P
150 mm	10	10	3940-150-10-HST-2P
150 mm	10	5	3940-150-10-HST-5P
150 mm	10	1	3940-150-10-HST-10P
150 mm	10	1	3940-150-10-ST-100P
150 mm	10	10	3940-150-10-ST-2P
150 mm	10	5	3940-150-10-ST-5P
150 mm	10	1	3940-150-10-ST-10P
150 mm	14	10	3940-150-14-HST-2P
150 mm	14	5	3940-150-14-HST-5P
150 mm	14	1	3940-150-14-HST-10P
150 mm	18	10	3940-150-18-HST-2P
150 mm	18	5	3940-150-18-HST-5P
150 mm	18	1	3940-150-18-HST-10P
228 mm	10	10	3940-228-10-HST-2P
228 mm	10	5	3940-228-10-HST-5P
228 mm	10	1	3940-228-10-HST-10P
228 mm	10	1	3940-228-10-HST-100P
228 mm	10	10	3940-228-10-ST-2P
228 mm	10	5	3940-228-10-ST-5P
228 mm	10	1	3940-228-10-ST-10P
228 mm	10	1	3940-228-10-ST-100P
228 mm	14	10	3940-228-14-HST-2P

228 mm	14	5	3940-228-14-HST-5P
228 mm	14	1	3940-228-14-HST-10P
228 mm	18	10	3940-228-18-HST-2P
228 mm	18	5	3940-228-18-HST-5P
228 mm	18	1	3940-228-18-HST-10P
300 mm	10	10	3940-300-10-HST-2P
300 mm	10	5	3940-300-10-HST-5P
300 mm	10	1	3940-300-10-HST-10P
300 mm	14	10	3940-300-14-HST-2P
300 mm	14	5	3940-300-14-HST-5P
300 mm	14	1	3940-300-14-HST-10P
300 mm	18	10	3940-300-18-HST-2P
300 mm	18	5	3940-300-18-HST-5P
300 mm	18	1	3940-300-18-HST-10P

Sandflex® Bi-Metal Sabre Sawblade Set for Fine Metal



3940-FM

100 mm	24	10	3940-100-24-ST-2P
100 mm	24	5	3940-100-24-ST-5P
100 mm	24	1	3940-100-24-ST-10P
150 mm	24	5	3940-150-24-ST-2P
150 mm	24	5	3940-150-24-ST-5P
150 mm	24	1	3940-150-24-ST-10P
150 mm	24	1	3940-150-24-ST-100P

Sandflex® Bi-Metal Sabre Sawblade Set for Precision Metal



3940-PM

100 mm	14	10	3940-100-14-SC-2P
100 mm	14	5	3940-100-14-SC-5P
100 mm	18	10	3940-100-18-SC-2P
100 mm	18	5	3940-100-18-SC-5P
100 mm	24	10	3940-100-24-SC-2P
100 mm	24	5	3940-100-24-SC-5P

Sabre Saw Tungsten Carbide Tipped Blades for Heavy Duty Metal



3946-C HM

Length	Teeth	Quantity	Part Number
150 mm	8	10	3946-150-8-HST-1P
228 mm	8	10	3946-228-8-HST-1P
300 mm	8	10	3946-300-8-HST-1P

Sabre Saw Tungsten Carbide Tipped Blades for Stainless Steel



3946-C SS

Length	Teeth	Quantity	Part Number
150 mm	10	10	3946-150-10-HST-1P
228 mm	10	10	3946-228-10-HST-1P
300 mm	10	10	3946-300-10-HST-1P

Sabre Saw Diamond Grit Blades For Cast Iron And Ceramics



3946-D CI

Length	Grit	Quantity	Part Number
100 mm	Grit	10	3946-100-DG-ST-2P
150 mm	Grit	10	3946-150-DG-ST-2P

Car Body Sandflex® Bi-Metal Reciprocating Sawblades



3845

Length	Teeth	Quantity	Part Number
91,5 mm	18	1	3845-18-10P
91,5 mm	24	1	3845-24-10P
90 mm	32	1	3845-32-10P

Sandflex® Bi-Metal Sabre Sawblades for Wood and Metal



3940-WM

Length	Teeth	Quantity	Part Number
150 mm	4/6	10	3940-150-4/6-SC-2P
150 mm	4/6	5	3940-150-4/6-SC-5P
150 mm	4/6	1	3940-150-4/6-SC-10P
150 mm	5/8	10	3940-150-5/8-SL-2P
150 mm	5/8	5	3940-150-5/8-SL-5P
150 mm	5/8	1	3940-150-5/8-SL-10P
150 mm	5/8	1	3940-150-5/8-SL-100P
150 mm	6	10	3940-150-6-ST-2P
150 mm	6	5	3940-150-6-ST-5P
150 mm	6	1	3940-150-6-ST-10P
228 mm	6	10	3940-228-6-SL-2P
228 mm	6	5	3940-228-6-SL-5P
228 mm	6	1	3940-228-6-SL-10P
300 mm	6	10	3940-300-6-SL-2P
300 mm	6	5	3940-300-6-SL-5P
300 mm	6	1	3940-300-6-SL-10P
300 mm	8/12	5	3940-300-8/12-SL-2P
300 mm	8/12	5	3940-300-8/12-SL-5P
300 mm	8/12	1	3940-300-8/12-SL-10P
300 mm	8/12	1	3940-300-8/12-SL-100P

Sandflex® Bi-Metal Sabre Sawblades for Fire Fighters and Rescuers



3940-FR

Length	Teeth	Quantity	Part Number
228 mm	10	10	3940-228-10-DSL-2P
228 mm	10	5	3940-228-10-DSL-5P
228 mm	10	1	3940-228-10-DSL-10P
228 mm	10	1	3940-228-10-DSL-100P

Sandflex® Bi-Metal Sabre Sawblades for Demolition



3940-D

Length	Teeth	Quantity	Part Number
150 mm	5/8	10	3940-150-5/8-DSL-2P
150 mm	5/8	5	3940-150-5/8-DSL-5P
150 mm	5/8	1	3940-150-5/8-DSL-10P
228 mm	5/8	10	3940-228-5/8-DSL-2P
228 mm	5/8	5	3940-228-5/8-DSL-5P
228 mm	5/8	1	3940-228-5/8-DSL-10P
300 mm	5/8	10	3940-300-5/8-DSL-2P
300 mm	5/8	5	3940-300-5/8-DSL-5P
300 mm	5/8	1	3940-300-5/8-DSL-10P

Sandflex® Bi-Metal Sabre Sawblades for Pallet Repair



3940-PR

Length	Teeth	Quantity	Part Number
228 mm	10/14	1	3940-228-10/14-PR13-10P
228 mm	10/14	1	3940-228-10/14-PR09-10P
228 mm	10/14	1	3940-228-10/14-PR13-100P
228 mm	10/14	1	3940-228-10/14-PR13-100P
228 mm	8/12	1	3940-228-8/12-PR13-100P
228 mm	10	1	3940-228-10-PR09-100P



Sabre Saw Tungsten Carbide Tipped Blades for Wood & Nails



3946-C_WM

Length	Teeth	Quantity	Part Number
150 mm	6	10	3946-150-6-DSL-1P
228 mm	6	10	3946-228-6-DSL-1P
300 mm	6	10	3946-300-6-DSL-1P

Sabre Saw HCS Blades for Wood and Plastic



3942-WP

Length	Teeth	Quantity	Part Number
228 mm	11	10	3942-228-11-HSL-2P
228 mm	11	5	3942-228-11-HSL-5P
228 mm	11	1	3942-228-11-HSL-10P

Reciprocating Curved Saw Blade for Medium Cut



3943-C30-JT-M

Length	Teeth	Quantity	Part Number
323 mm	13 in	10	3943-C30-JT-M
373 mm	15 in	10	3943-C35-JT-M

Sabre Saw HCS Blades for Wood



3942-W

Length	Teeth	Quantity	Part Number
228 mm	7	10	3942-228-7-HSL-2P
228 mm	7	5	3942-228-7-HSL-5P
228 mm	7	1	3942-228-7-HSL-10P
300 mm	7	10	3942-300-7-HSL-2P
300 mm	7	5	3942-300-7-HSL-5P
300 mm	7	1	3942-300-7-HSL-10P

Sandflex® Bi-Metal Sabre Sawblades for Plaster and Boards



3942-PB

Length	Teeth	Quantity	Part Number
150 mm	7	10	3942-150-7-SL-2P
150 mm	7	5	3942-150-7-SL-5P
150 mm	7	1	3942-150-7-SL-10P
228 mm	7	10	3942-228-7-SL-2P
228 mm	7	5	3942-228-7-SL-5P
228 mm	7	1	3942-228-7-SL-10P
300 mm	7	10	3942-300-7-SL-2P
300 mm	7	5	3942-300-7-SL-5P
300 mm	7	1	3942-300-7-SL-10P

Reciprocating Long Curved Saw Blade for Coarse Cut



3943-C35-JT-C

Length	Teeth	Quantity	Part Number
373 mm	15 in	10	3943-C35-JT-C

Sabre Saw HCS Blades for Coarse Wood



3942-CW

Length	Teeth	Quantity	Part Number
228 mm	5	10	3942-228-5-HSL-2P
228 mm	5	5	3942-228-5-HSL-5P
228 mm	5	1	3942-228-5-HSL-10P
300 mm	5	10	3942-300-5-HSL-2P
300 mm	5	5	3942-300-5-HSL-5P
300 mm	5	1	3942-300-5-HSL-10P

Reciprocating Curved Saw Blade for Fine Cut



3943-C30-JT-F

Length	Teeth	Quantity	Part Number
323 mm	13 in	10	3943-C30-JT-F

Reciprocating Straight Saw Blade for Fine Cut



3943-S20-JT-F

Length	Teeth	Quantity	Part Number
228 mm	9 in	10	3943-S20-JT-F

Reciprocating Straight Saw Blade for Coarse Cut



3943-R28-UT-C-2P

300 mm	12 in	10	3943-R28-UT-C-2P

Sandflex® Bi-Metal Sabre Sawblades Set for Heavy Metal and Demolition - 5 Pcs



3940-HDD-SET-5P

5	222 g	5	3940-HDD-SET-5P

3940-150-5/8-DSL, 3940-228-5/8-DSL, 3940-228-10-DSL, 3940-150-14-HST, 3940-228-14-HS

Sabre Sawblades Set for Wood and Metal - 12 Pcs



3940-MIX-SET-12P

12	480 g	6	3940-MIX-SET-12P

3940-228-10-HST, 2 x 3940-228-14-ST, 3940-228-18-ST, 3940-150-10-ST, 3940-150-14-ST, 3940-150-18-ST, 3940-228-5/8-DSL, 3940-228-6-SL, 3942-150-7-SL, 3942-228-7-HSL, 3942-228-11-HSL

Sandflex® Bi-Metal Sabre Sawblades Set for Metal - 5 Pcs



3940-METAL-SET-5P

5	125 g	5	3940-METAL-SET-5P

3940-150-14-ST, 3940-150-18-ST, 3940-150-24-ST, 3940-228-18-ST, 3940-228-14-ST

Sabre Sawblades Set for Wood and Metal - 5 Pcs



3940-MIX-SET-5P

5	150 g	5	3940-MIX-SET-5P

3940-100-24-SC, 3940-150-18-ST, 3940-150-14-ST, 3940-228-6-SL, 3942-228-7-HSL

Sabre Sawblades Set for Wood - 5 Pcs



3942-WOOD-SET-5P

5	191 g	5	3942-WOOD-SET-5P

3940-228-6-SL, 3942-228-11-HSL, 2x 3942-228-7-HSL, 3942-150-7-SL

Sandflex® Bi-Metal Sabre Sawblades Set for Metal - 12 Pcs



3940-METAL-SET-12P

12	460 g	6	3940-METAL-SET-12P

3940-228-10-HST, 2 x 3940-228-14-ST, 3940-228-18-ST, 3940-150-10-ST, 3940-150-14-ST, 3940-150-18-ST, 3940-150-24-ST, 3946-150-8-HST, 3940-150-5/8-DSL, 3940-228-6-SL, 3942-228-7-HSL

Sabre Sawblades Set for Plaster Wood and Metal - 10 Pcs



3940-MIX-SET-10P

10	245 g	4	3940-MIX-SET-10P

3940-100-24-SC, 3940-100-18-SC, 3940-150-24-ST, 3940-150-18-ST, 3940-150-14-ST, 3940-150-10-ST, 3940-228-6-SL, 3942-228-11-HSL, 3942-228-7-HSL, 3942-150-7-SL

Sabre Sawblades Set for Wood - 12 Pcs



3942-WOOD-SET-12P

12	525 g	6	3942-WOOD-SET-12P

3940-228-14-ST, 3940-228-18-ST, 3940-150-14-ST, 3940-150-5/8-DSL, 3940-228-5/8-DSL, 3940-228-6-SL, 3946-228-6-DSL, 3942-150-7-SL, 3942-228-5-HSL, 2 x 3942-228-7-HSL, 3942-228-11-HSL



Sabre Saw Stainless Steel Blades for Meat and Ice



3944

Length	Teeth	Quantity	Product Code
300 mm	4	10	3944-300-3-MEAT-1P

Sabre Saw Tungsten Carbide Tipped Blades for Stone Materials



3946-CT

Length	Teeth	Quantity	Product Code
150 mm	6	5	3946-150-6-SL-1P
228 mm	3	5	3946-228-3-ST-1P
300 mm	6	5	3946-300-6-ST-1P

Sabre Saw Tungsten Carbide Tipped Blades for Bricks, LECA and Aerated Concrete



3946-C_B

Length	Teeth	Quantity	Product Code
300 mm	2	10	3946-300-2-CB-1P
457 mm	2	10	3946-457-2-CB-1P

JIGSAW BLADES

T-Shank Jigsaw Blades for Metal Cutting



91-M

Length	Teeth	Quantity	Product Code
100 mm	15/23	1	91-3PM-5P
100 mm	8	1	91-433-5P
77 mm	36	1	91-502-5P

Length	Teeth	Quantity	Product Code
77 mm	21	1	91-512-5P
77 mm	21	1	91-512-25P
77 mm	21	1	91-517-5P
77 mm	13	1	91-522-5P
132 mm	25	1	91-611-5P
77 mm	21	1	91-612-5P
77 mm	13	1	91-622-5P
132 mm	14	1	91-7V1-5P

T-Shank Jigsaw Blades for Wood and Metal Cutting



91-WM

Length	Teeth	Quantity	Product Code
132 mm	10/14	1	91-4PWM-5P
100 mm	10/14	1	91-623-5P

T-Shank Jigsaw Blades for Wood Cutting



91-W

Length	Teeth	Quantity	Product Code
117 mm	10	1	91-2PW-5P
132 mm	8	1	91-434-5P
105 mm	6	1	91-444-5P
100 mm	8	1	91-023-5P
77 mm	12	1	91-027-5P
100 mm	6	1	91-143-5P
100 mm	6	1	91-143-25P
100 mm	6	1	91-143-100P
100 mm	6	1	91-148-5P
100 mm	10	1	91-223-5P
100 mm	10	1	91-226-5P
132 mm	6	1	91-233-5P
100 mm	6	1	91-243-5P
77 mm	19	1	91-412-5P
100 mm	6	1	91-443-5P

Jigsaw Blade Set for Metal - 10 pcs



91-METAL-10P

Quantity	Product Code
10	91-METAL-10P

x3 91-512 (T118A), x3 91-522 (T118B), x1 91-433 (T127DF), x1 91-502 (T118G), x2 91-4PWM (T111HF)

Jigsaw Blade Set for Wood and Plastic - 10 pcs



91-WOOD-10P

Quantity	Product Code
10	91-WOOD-10P

x4 91-143 (T144D), x2 91-223 (T101B), x2 91-023 (T111C), x1 91-148 (T244D), x1 91-226 (T101BR)

Jigsaw Blade Set for Wood and Metal - 10 pcs



91-MIXED-10P

Quantity	Product Code
10	91-MIXED-10P

x3 91-143 (T144D), x1 91-223 (T101B), x1 91-148 (T244D), x2 91-512 (T118A), x2 91-522 (T118B), x1 91-623 (T111HF)

MULTI TOOL ACCESSORIES

Multi-Tool Standard Blade for Wood Cutting



92-S_W



1	35 x 50 x 97 mm	70	92-133-1P
3	35 x 50 x 97 mm	46	92-133-3P
25	35 x 50 x 97 mm	25	92-133-25

Multi-Tool Standard Blade for Precision Wood Cutting



92-P_W



1	30 x 50 x 97 mm	70	92-205-1P
3	30 x 50 x 97 mm	46	92-205-3P
25	30 x 50 x 97 mm	25	92-205-25
1	65 x 50 x 97 mm	70	92-229-1P

Multi-Tool Curved Standard Blade for Wood Cutting



92-C_W



1	65 x 50 x 97 mm	70	92-225-1P
25	65 x 50 x 97 mm	25	92-225-25

Multi-Tool Standard Blade for Universal Cutting of Wood with Nails



92-U_WN



1	35 x 50 x 97 mm	70	92-160-1P
3	35 x 50 x 97 mm	46	92-160-3P
25	35 x 50 x 97 mm	25	92-160-25

Multi-Tool Long-Life Standard Blade for Cutting Wood with Nails



92-LF_WN



1	50 x 50 x 97 mm	70	92-221-1P
1	65 x 50 x 97 mm	70	92-228-1P
25	65 x 50 x 97 mm	25	92-228-25

Multi-Tool Standard Blade for Universal Cutting of Wood with Metal



92-U_WM



1	28 x 55 x 100 mm	70	92-222-1P
3	28 x 55 x 100 mm	46	92-222-3P
25	28 x 55 x 100 mm	25	92-222-25
1	44 x 55 x 100 mm	70	92-223-1P
3	44 x 55 x 100 mm	46	92-223-3P

Multi-Tool Carbide Tipped Blade with TiN Coating for Metal Cutting



92-C_M



1	35 x 42 x 82 mm	70	92-236-1P
---	-----------------	----	-----------

Multi-Tool Standard Blade for Fine Cutting in Metal



92-FM



1	30 x 50 x 97 mm	70	92-157-1P
25	30 x 50 x 97 mm	25	92-157-25

Multi-Tool Segment Blade for Metal Cutting



92-M_S



1	85 mm	90	92-106-1P
---	-------	----	-----------



Multi-Tool Segment Blade for Wood Cutting



92-SP

1	85 mm	90	92-113-1P

Multi-Tool Segment Blade for Slots and Reworking



92-CG_S

1	75 mm	90	92-118-1P

Multi-Tool Standard Knife for Soft Materials



92-MFK

1	41 x 42 x 87 mm	70	92-251-1P

Multi-Tool Circular Blade for Metal Cutting



92-M_R

115	85 mm	90	92-174-1P

Multi-Tool Segment Blade for Marble and Epoxy



92-DG_S

1	90 mm	50	92-166-1P

Multi-Tool Standard Scraper Blades



92-SC

1	52 x 38 x 83 mm	90	92-165-1P
1	50 x 38 x 83 mm	90	92-226-1P

Multi-Tool Standard Blade Set for Wood and Metal Cutting - 8 pcs



92-Universal_WM_Set

8	32 x 160 x 195 mm	34	92-WM-SET-8P

- 92-222-1Px 2, 92-223-1Px 2
- 92-228-1Px 2
- 92-160-1Px 2

Multi-Tool Triangular Blade for Rasping and Reworking



92-CR_T

1	80 mm	90	92-001-1P

Multi-Tool Mushroom Shape Cutting Blade



92-CM

1	70 x 30 x 75 mm	90	92-245-1P

Multi-Tool Triangular Sanding Pads



92-Sanding

1	80 mm	20	92-136-1P	
5	82 mm	10	92-136-G40-5P	
5	82 mm	10	92-136-G80-5P	
5	82 mm	10	92-136-G120-5P	
5	82 mm	10	92-136-G240-5P	
1	93 mm	50	92-137-1P	
5	94 mm	10	92-137-G40-5P	
5	94 mm	10	92-137-G80-5P	
5	94 mm	10	92-137-G120-5P	
5	94 mm	10	92-137-G240-5P	

CIRCULAR SAW BLADES

Circular Saw blades for Cordless Saws in Wood



8501-C

136 mm	24	1	8501-136-10-24C	
136 mm	24	1	8501-136-20-24C	
150 mm	24	1	8501-150-10-24C	
160 mm	24	1	8501-160-20-24C	
165 mm	24	1	8501-165-20-24C	
184 mm	24	1	8501-184-20-24C	
190 mm	24	1	8501-190-30-24C	

Circular Saw blades for Portable-/Table Saws in Wood



8501-P/T

125 mm	16	1	8501-2	
130 mm	16	1	8501-3	
140 mm	16	1	8501-4	
140 mm	24	1	8501-4F	
140 mm	30	1	8501-4XF	
150 mm	18	1	8501-5	
150 mm	30	1	8501-5F	
160 mm	18	1	8501-7	
160 mm	30	1	8501-7F	
170 mm	18	1	8501-10	
170 mm	30	1	8501-10F	
180 mm	20	1	8501-12	
180 mm	40	1	8501-12F	
184 mm	24	1	8501-13	
184 mm	40	1	8501-13F	
184 mm	24	1	8501-184-16-24	
184 mm	40	1	8501-184-16-40	
190 mm	20	1	8501-15	
190 mm	40	1	8501-15F	
190 mm	60	1	8501-190-30-60XF	
200 mm	20	1	8501-16	
200 mm	40	1	8501-16F	
210 mm	20	1	8501-17	
210 mm	40	1	8501-17F	
210 mm	60	1	8501-210-30-60XF	
230 mm	20	1	8501-22	
230 mm	40	1	8501-22F	
230 mm	60	1	8501-230-30-60XF	
235 mm	30	1	8501-23	
235 mm	40	1	8501-23F	
235 mm	60	1	8501-235-30-60XF	
250 mm	24	1	8501-28	
250 mm	40	1	8501-28F	
250 mm	60	1	8501-28XF	

Circular Saw blades for Mitre Saws in Wood



8501-M

210 mm	48	1	8501-210-30-48SW	
216 mm	24	1	8501-16SW	
216 mm	48	1	8501-18SW	
216 mm	60	1	8501-216-60SW	
250 mm	60	1	8501-28SW	
260 mm	24	1	8501-260-24SW	
260 mm	40	1	8501-260-40SW	
260 mm	60	1	8501-260-60SW	
300 mm	60	1	8501-30SW	
305 mm	40	1	8501-305-30-40SW	
305 mm	60	1	8501-305-30-60SW	

Circular Saw blades for Site Saws in Wood



8501-S

300 mm	30	1	8501-30	
300 mm	40	1	8501-30F	
300 mm	60	1	8501-30XF	
315 mm	30	1	8501-31	
315 mm	40	1	8501-31F	
400 mm	40	1	8501-40	

Circular Saw blades for Plunge Saws in Wood



8501-P

160 mm	48	1	8501-160-20-48XF	
165 mm	48	1	8501-165-20-48XF	



Circular Saw blades for Mitre Saws in Aluminium and Plastic



8501-AP

Ø	W	Q	Material
210 mm	48	1	8501-17S
216 mm	48	1	8501-18S
250 mm	80	1	8501-28S
260 mm	80	1	8501-260-30-80S
300 mm	96	1	8501-30S
305 mm	96	1	8501-305-30-96S

ABRASIVE CUTTING DISCS

Abrasive High-Performance Cutting Discs for General Purpose Inox & Metal



391-T41_IM

Ø	W	Q	Material
115x1.6 mm	50	3911-115-T41-IM	
115x1.0 mm	50	3911-115T41-IM	
125x1.6 mm	50	3911-125-T41-IM	
180x2.0 mm	50	3911-180-T41-IM	
230x2.5 mm	50	3911-230-T41-IM	
115x1.0 mm	50	3912-115-T41-IM	
125x1.0 mm	50	3912-125-T41-IM	
125x1.0 mm	25	3911-125T41-IM	
180x1.6 mm	50	3911-180T41-IM	
230x1.9 mm	50	3911-230T41-IM	
230x3.0 mm	50	3911-2303T41-IM	
115x1 mm	10	3911-115-IM-10P	
125x1 mm	10	3911-125-IM-10P	

Abrasive High-Performance Cutting Discs for Aluminium



391-T41_ALU

Ø	W	Q	Material
115 mm	22,23 mm	25	3911-115-T41-AL
125 mm	22,23 mm	25	3911-125-T41-AL

Abrasive High-Performance Cutting Discs for Inox



391-T41-I

Ø	W	Q	Material
115x1.0 mm	25	3911-115-T41-I	
125x1.0 mm	25	3911-125-T41-I	
150x1.0 mm	50	3911-150-T41-I	
180x1.6 mm	50	3911-180-T41-I	
230x1.9 mm	50	3911-230-T41-I	

Abrasive High-Performance Cutting Discs for Stainless Steel & Metal



391-T41_CS

Ø	W	Q	Material
356 mm	25,4 mm	35	3911-350-X2TM
400 mm	25,4 mm	15	3911-400-F2TM
400 mm	25,4 mm	15	3911-400-X2TM

Abrasive High-Performance Cutting Discs for Metal



391-T42_M

Ø	W	Q	Material
115x2.5 mm	25	3911-115-T42-M	
125x2.5 mm	25	3911-125-T42-M	
150x2.5 mm	25	3911-150-T42-M	
180x3.2 mm	25	3911-180-T42-M	
230x3.2 mm	50	3911-230-T42-M	

Abrasive High-Performance Cutting Discs for Building & Stone



391-T42_ST

Ø	W	Q	Material
115x3.2 mm	25	3912-115-T42-ST	
125x3.2 mm	25	3912-125-T42-ST	
180x3.2 mm	25	3912-180-T42-ST	
230x3.2 mm	50	3912-230-T42-ST	

Abrasive High-Performance Grinding Discs for Inox & Metal



392-T27_IM

Ø	W	Q	Material
115x6.4 mm	25	3921-115-T27-IM	
125x6.4 mm	25	3921-125-T27-IM	
150x6.4 mm	25	3921-150-T27-IM	
180x6.5 mm	25	3921-180-T27-IM	
230x6.5 mm	25	3921-230-T27-IM	

Abrasive Conical Flap Grinding Discs for
Inox & Metal



392-FLAP_C

Ø	Icons	Quantity	Product Code
115 mm		20	3926-115IM-C40
115 mm		20	3926-115IM-C60
115 mm		20	3926-115IM-C80
115 mm		20	3926-115IM-C120
125 mm		20	3926-125IM-C40
125 mm		20	3926-125IM-C60
125 mm		20	3926-125IM-C80
125 mm		20	3926-125IM-C120

Abrasive Flap Grinding Discs for Inox &
Metal



392-FLAP_P

Ø	Icons	Quantity	Product Code
115 mm		20	3927-115IM-P40
115 mm		20	3927-115IM-P60
115 mm		20	3927-115IM-P80
115 mm		20	3927-115IM-P120
125 mm		20	3927-125IM-P40
125 mm		20	3927-125IM-P60
125 mm		20	3927-125IM-P80
125 mm		20	3927-125IM-P120
125 mm		12	3927-125-40-3P
125 mm		12	3927-125-60-3P
125 mm		12	3927-125-80-3P
125 mm		12	3927-125-120-3P

Abrasive Diamond Cutting Discs for
Ceramic & tiles



391-DIAM_C

Ø	Icons	Quantity	Product Code
115 mm		100	3916-115-10P-CE
125 mm		100	3916-125-10P-CE
115 mm		100	3917-115-7S-C
125 mm		100	3917-125-7S-C

Abrasive Diamond Cutting Discs for
General Purpose Stone



391-DIAM_U

Ø	Icons	Quantity	Product Code
115 mm		100	3916-115-10S-UE
125 mm		100	3916-125-10S-UE
150 mm		50	3916-150-10S-UE
180 mm		50	3916-180-10S-UE
230 mm		25	3916-230-10S-UE
115 mm		100	3917-115-7S-U
125 mm		100	3917-125-7S-U
230 mm		25	3917-230-7S-U

Abrasive Diamond Cutting Discs for
Reinforced Concrete



391-DIAM_RC

Ø	Icons	Quantity	Product Code
230 mm		25	3916-230-10L-RC

BANDSAW BLADES

Easy-Cut Bandsaw Blades with Portaband



3857 Easy-Cut Portaband

Icons	Icons	Quantity	Product Code
S	EZ	1	3857-13-0.6-EZ-S-3P690
S	EZ	1	3857-13-0.6-EZ-S-3P730
S	EZ	1	3857-13-0.6-EZ-S-3P835
S	EZ	1	3857-13-0.6-EZ-S-3P900
S	EZ	1	3857-13-0.6-EZ-S-3P1140



CARBIDE ROTARY BURRS

Tungsten Carbide Cylindrical Rotary Burrs for Metal



A

Ø	Grain	Profile	Part No.
3 mm	Medium	1	A0313M03
3 mm	Medium	1	A0313M03E
3 mm	Medium	1	A0313M03X
3 mm	Medium	1	A0313M03XE
3 mm	Medium	1	A0313M03XE-60
3 mm	Medium	1	A0313M03XE-80
6.3 mm	Medium	1	A0613M03X
6 mm	Medium	1	A0616M06
6 mm	Medium	1	A0616M06E
6 mm	Medium	1	A0616M06X
6 mm	Medium	1	A0616M06XE
8 mm	Medium	1	A0820M06
8 mm	Medium	1	A0820M06E
8 mm	Medium	1	A0820M06X
8 mm	Medium	1	A0820M06XE
10 mm	Medium	1	A1020M06
10 mm	Medium	1	A1020M06E
9.6 mm	Medium	1	A1020M06X
9.6 mm	Medium	1	A1020M06XE
12 mm	Medium	1	A1225M06
12.7 mm	Medium	1	A1225M06E
12 mm	Medium	1	A1225M06X
12.7 mm	Medium	1	A1225M08
12.7 mm	Medium	1	A1225M08E
12.7 mm	Medium	1	A1225M08X
12.7 mm	Medium	1	A1225M08XE
16 mm	Medium	1	A1625M06
16 mm	Medium	1	A1625M06X
16 mm	Medium	1	A1625M06XE
16 mm	Medium	1	A1625M08
16 mm	Medium	1	A1625M08E
16 mm	Medium	1	A1625M08X
16 mm	Medium	1	A1625M08XE

* non stock standard

Tungsten Carbide Cylindrical Round Nose Rotary Burrs for Metal



C

Ø	Grain	Profile	Part No.
3 mm	Medium	1	C0313M03
3 mm	Medium	1	C0313M03X
6.3 mm	Medium	1	C0616M03X
6 mm	Medium	1	C0616M06
6 mm	Medium	1	C0616M06X
8 mm	Medium	1	C0820M06
8 mm	Medium	1	C0820M06X

Ø	Grain	Profile	Part No.
9.6 mm	Medium	1	C1020M06
10 mm	Medium	1	C1020M06X
12 mm	Medium	1	C1225M06
12 mm	Medium	1	C1225M06X
12.7 mm	Medium	1	C1225M08X
16 mm	Medium	1	C1625M06
16 mm	Medium	1	C1625M06X
16 mm	Medium	1	C1625M08
16 mm	Medium	1	C1625M08X

* non stock standard

Tungsten Carbide Spherical Rotary Burrs for Metal



D

Ø	Grain	Profile	Part No.
3 mm	Medium	1	D0303M03
3 mm	Medium	1	D0303M03X
6.3 mm	Medium	1	D0605M03X
6 mm	Medium	1	D0606M06
6 mm	Medium	1	D0606M06X
8 mm	Medium	1	D0807M06
8 mm	Medium	1	D0807M06X
9.6 mm	Medium	1	D1009M06
9.6 mm	Medium	1	D1009M06X
12.7 mm	Medium	1	D1211M06
12.7 mm	Medium	1	D1211M06X
16 mm	Medium	1	D1614M06
16 mm	Medium	1	D1614M06X
16 mm	Medium	1	D1614M08
16 mm	Medium	1	D1614M08X

* non stock standard

Tungsten Carbide Oval Rotary Burrs for Metal



E

Ø	Grain	Profile	Part No.
3 mm	Medium	1	E0308M03
3 mm	Medium	1	E0308M03X
6 mm	Medium	1	E0614M06
8 mm	Medium	1	E0816M06
8 mm	Medium	1	E0816M06X
9.6 mm	Medium	1	E1018M06
9.6 mm	Medium	1	E1018M06X
12.7 mm	Medium	1	E1222M06
12.7 mm	Medium	1	E1222M06X
12.7 mm	Medium	1	E1222M08
12.7 mm	Medium	1	E1222M08X
16 mm	Medium	1	E1625M06

Ø	Grain	Profile	Part No.
16 mm	Medium	1	E1625M06X
16 mm	Medium	1	E1625M08
16 mm	Medium	1	E1625M08X

* non stock standard

Tungsten Carbide Arch Round Nose Rotary Burrs for Metal



F

Ø	Grain	Profile	Part No.
3 mm	Medium	1	F0313M03
3 mm	Medium	1	F0313M03X
6.3 mm	Medium	1	F0613M03X
6 mm	Medium	1	F0618M06
6 mm	Medium	1	F0618M06X
8 mm	Medium	1	F0820M06
8 mm	Medium	1	F0820M06X
9.6 mm	Medium	1	F1020M06
9.6 mm	Medium	1	F1020M06X
12.7 mm	Medium	1	F1225M06
12.7 mm	Medium	1	F1225M06X
12.7 mm	Medium	1	F1225M08
12.7 mm	Medium	1	F1225M08X
16 mm	Medium	1	F1625M06
16 mm	Medium	1	F1625M06X
16 mm	Medium	1	F1625M08

* non stock standard

Tungsten Carbide Arch Pointed Nose Rotary Burrs for Metal



G

Ø	Grain	Profile	Part No.
3 mm	Medium	1	G0313M03
3 mm	Medium	1	G0313M03X
6.3 mm	Medium	1	G0613M03X
6 mm	Medium	1	G0618M06
6 mm	Medium	1	G0618M06X
8 mm	Medium	1	G0820M06
8 mm	Medium	1	G0820M06X
9.6 mm	Medium	1	G1020M06
9.6 mm	Medium	1	G1020M06X
12.7 mm	Medium	1	G1225M06
12.7 mm	Medium	1	G1225M06X
12 mm	Medium	1	G1225M08
12 mm	Medium	1	G1225M08X
16 mm	Medium	1	G1625M06
16 mm	Medium	1	G1625M06X
16 mm	Medium	1	G1625M08
16 mm	Medium	1	G1625M08X

* non stock standard

Tungsten Carbide Flame Rotary Burrs for Metal



H

6 mm	Medium	1	H0613M03X	
10 mm	Medium	1	H1025M06	
10 mm	Medium	1	H1025M06X	
12.7 mm	Medium	1	H1232M06	
12.7 mm	Medium	1	H1232M06X	
16 mm	Medium	1	H1635M06X	
16 mm	Medium	1	H1635M06	
16 mm	Medium	1	H1635M08	
16 mm	Medium	1	H1635M08X	

* non stock standard

Tungsten Carbide 60° Cone Rotary Burrs for Metal



J

6 mm	Medium	1	J0604M06	
9.6 mm	Medium	1	J1010M06	
12.7 mm	Medium	1	J1212M06	
16 mm	Medium	1	J1616M06	
16 mm	Medium	1	J1616M08	

* non stock standard

Tungsten Carbide 90° Cone Rotary Burrs for Metal



K

6 mm	Medium	1	K0602M06	
9.6 mm	Medium	1	K1008M06	
12.7 mm	Medium	1	K1210M06	
16 mm	Medium	1	K1612M06	
16 mm	Medium	1	K1612M08	

* non stock standard

Tungsten Carbide Conical Round Nose Rotary Burrs for Metal



L

10 mm	Medium	1	L1020M06	
10 mm	Medium	1	L1020M06X	
12.7 mm	Medium	1	L1225M06	
12.7 mm	Medium	1	L1225M06X	
12.7 mm	Medium	1	L1230M06	
12.7 mm	Medium	1	L1230M06X	
16 mm	Medium	1	L1630M06	
16 mm	Medium	1	L1630M06X	
16 mm	Medium	1	L1630M08	
16 mm	Medium	1	L1630M08X	

* non stock standard

Tungsten Carbide Conical Pointed Nose Rotary Burrs for Metal



M

3 mm	Medium	1	M0310M03	
3 mm	Medium	1	M0310M03X	
6.3 mm	Medium	1	M0613M03X	
6 mm	Medium	1	M0618M06	
6 mm	Medium	1	M0618M06X	
9.5 mm	Medium	1	M1022M06	
9.5 mm	Medium	1	M1022M06X	
12.7 mm	Medium	1	M1227M06	
12.7 mm	Medium	1	M1227M06X	
12.7 mm	Medium	1	M1227M08	
16 mm	Medium	1	M1630M06	
16 mm	Medium	1	M1630M06X	
16 mm	Medium	1	M1630M08	
16 mm	Medium	1	M1630M08X	

* non stock standard

Tungsten Carbide Inverted Cone Nose Rotary Burrs for Metal



N

3 mm	Medium	1	N0306M03	
3 mm	Medium	1	N0306M03E	
6 mm	Medium	1	N0607M06	
12.7 mm	Medium	1	N1213M06	
12.7 mm	Medium	1	N1213M06X	
16 mm	Medium	1	N1613M06	
16 mm	Medium	1	N1613M06X	
16 mm	Medium	1	N1613M08	

* non stock standard

Tungsten Carbide Cylindrical Nose Rotary Burrs for Aluminium



A-AL

6 mm	AL	1	A0616AL06E	
12.7 mm	AL	1	A1225AL06E	
12.7 mm	AL	1	A1225AL08E	
16 mm	AL	1	A1625AL08XE	

Tungsten Carbide Cylindrical Round Nose Rotary Burrs for Aluminium



C-AL

6 mm	AL	1	C0616AL06	
12.7 mm	AL	1	C1225AL06	



Tungsten Carbide Spherical Nose Rotary Burrs for Aluminium



D-AL

Ø	Material	Qty	Part No.
12.7 mm	AL	1	D1211AL06
12.7 mm	AL	1	D1211AL08

* non stock standard

Tungsten Carbide Cylindrical Rotary Special Burrs for Repairing Tyre



A/G

Ø	Material	Qty	Part No.
6 mm	TR	1	A0625M06X

* non stock standard

Tungsten Carbide Spherical Rotary Burrs for High Alloy Steel



D-S

Ø	Material	Qty	Part No.
6 mm	Steel	5	D0606S06
9.6 mm	Steel	5	D1010S06
12.7 mm	Steel	5	D1212S06

Tungsten Carbide Arch Round Nose Rotary Burrs for Aluminium



F-AL

Ø	Material	Qty	Part No.
6 mm	AL	1	F0618AL06
12.7 mm	AL	1	F1225AL06
12.7 mm	AL	1	F1225AL08

Tungsten Carbide Cylindrical Rotary Burrs for High Alloy Steel



A-S

Ø	Material	Qty	Part No.
6 mm	Steel	5	A0618S06E
9.6 mm	Steel	5	A1020S06
9.6 mm	Steel	5	A1020S06E
12.7 mm	Steel	5	A1225S06
12.7 mm	Steel	5	A1225S06E

Tungsten Carbide Arch Round Nose Rotary Burrs for High Alloy Steel



F-S

Ø	Material	Qty	Part No.
6 mm	Steel	5	F0618S06
9.6 mm	Steel	5	F1020S06
12.7 mm	Steel	5	F1225S06

Tungsten Carbide Conical Round Nose Rotary Burrs for Aluminium



L-AL

Ø	Material	Qty	Part No.
12.7 mm	AL	1	L1230AL06
12.7 mm	AL	1	L1230AL08

* non stock standard

Tungsten Carbide Cylindrical Round Nose Rotary Burrs for High Alloy Steel



C-S

Ø	Material	Qty	Part No.
6 mm	Steel	5	C0618S06
9.6 mm	Steel	5	C1020S06
12.7 mm	Steel	5	C1225S06

Tungsten Carbide Arch Pointed Nose Rotary Burrs for High Alloy Steel



G-S

Ø	Material	Qty	Part No.
9.6 mm	Steel	5	G1020S06
12.7 mm	Steel	5	G1225S06

Tungsten Carbide Conical Round Nose Rotary Burrs for High Alloy Steel



L-S

Ø	Material	Quantity	Part Number
9.6 mm	Steel	5	L1020S06
12.7 mm	Steel	5	L1228S06

Tungsten Carbide Spherical Rotary Burrs for Stainless Steel



D-I

Ø	Material	Quantity	Part Number
3 mm	Inox	5	D0303I03
6 mm	Inox	5	D0606I06
9.6 mm	Inox	5	D1010I06
12.7 mm	Inox	5	D1212I06

Tungsten Carbide Arch Pointed Nose Rotary Burrs for Stainless Steel



G-I

Ø	Material	Quantity	Part Number
9.6 mm	Inox	5	G1020I06
12.7 mm	Inox	5	G1225I06

Tungsten Carbide Cylindrical Rotary Burrs for Stainless Steel



A-I

Ø	Material	Quantity	Part Number
3 mm	Inox	5	A0314I03
6 mm	Inox	5	A0618I06
9.6 mm	Inox	5	A1020I06
12.7 mm	Inox	5	A1225I06

Tungsten Carbide Oval Rotary Burrs for Stainless Steel



E-I

Ø	Material	Quantity	Part Number
9.6 mm	Inox	5	E1015I06
12.7 mm	Inox	5	E1220I06

Tungsten Carbide Flame Rotary Burrs for Stainless Steel



H-I

Ø	Material	Quantity	Part Number
9.6 mm	Inox	5	H1020I06
12.7 mm	Inox	5	H1232I06

Tungsten Carbide Cylindrical Round Nose Rotary Burrs for Stainless Steel



C-I

Ø	Material	Quantity	Part Number
3 mm	Inox	5	C0312I03
6 mm	Inox	5	C0618I06
9.6 mm	Inox	5	C1020I06
12.7 mm	Inox	5	C1225I06

Tungsten Carbide Arch Round Nose Rotary Burrs for Stainless Steel



F-I

Ø	Material	Quantity	Part Number
3 mm	Inox	5	F0312I03
6 mm	Inox	5	F0618I06
9.6 mm	Inox	5	F1020I06
12.7 mm	Inox	5	F1225I06

Tungsten Carbide Conical Round Nose Rotary Burrs for Stainless Steel



L-I

Ø	Material	Quantity	Part Number
9.6 mm	Inox	5	L1020I06
12.7 mm	Inox	5	L1228I06



Tungsten Carbide Arch Pointed Nose Rotary Burrs for Tire Repair



TR

Size	Application	Qty	Part No.
3 mm	Tire Repair	5	TR0325M03X-50
4.5 mm	Tire Repair	5	TR0636M06X-65
6 mm	Tire Repair	5	TR0650M06X-80
8 in	Tire Repair	5	TR0860M08X-110
8 mm	Tire Repair	5	TR4.530M06X-90

Tungsten Carbide Rotary Burrs Set for Metal 10 and 12 mm - 5 Pcs



ST-1-5P

Icon	Weight (g)	Qty	Part No.
X	376 g	1	RB-SET1-M06X-5P

A1020M06XE	
C1225M06X	
F1225M06X	
G1020M06X	
L1230M06X	

Tungsten Carbide Rotary Burrs Set for Metal 10 mm - 5 Pcs



ST-2-5P

Icon	Weight (g)	Qty	Part No.
X	313 g	1	RB-SET2-M06X-5P

BAHCO

A1020M06XE	
C1020M06X	
D1009M06X	
F1020M06X	
L1020M06X	

Tungsten Carbide Rotary Burrs Set for Metal - 10 Pcs



ST-10P

Icon	Weight (g)	Qty	Part No.
X	542 g	1	RB-SET-M06X-10P

A1020M06XE, A1225M06X	
C1020M06X, C1225M06X	
D1211M06X	
E1018M06X	
F1225M06X	
G1020M06X, G1225M06X	
L1230M06X	

Tungsten Carbide Rotary Burrs Set for Aluminium - 5 pcs



ALU-5P

Icon	Weight (g)	Qty	Part No.
X	380 g	1	RB-SET-AL06-5P

A1225AL06E	
C1225AL06	
D1211AL06	
F1225AL06	
L1230AL06	

DRILL BITS

SDS Max Drill Bits 4-cutter for Reinforced Concrete



4656

Icon	Length (mm)	Qty	Part No.
	12.0 mm 340 mm	1	4656-12-340
	12.0 mm 540 mm	1	4656-12-540
	14.0 mm 340 mm	1	4656-14-340
	14.0 mm 540 mm	1	4656-14-540
	15.0 mm 340 mm	1	4656-15-340
	16.0 mm 340 mm	1	4656-16-340
	16.0 mm 540 mm	1	4656-16-540
	16.0 mm 940 mm	1	4656-16-940
	16.0 mm 1320 mm	1	4656-16-1320
	18.0 mm 340 mm	1	4656-18-340
	18.0 mm 540 mm	1	4656-18-540
	18.0 mm 940 mm	1	4656-18-940
	18.0 mm 1320 mm	1	4656-18-1320
	20.0 mm 320 mm	1	4656-20-320
	20.0 mm 520 mm	1	4656-20-520
	20.0 mm 920 mm	1	4656-20-920
	20.0 mm 1320 mm	1	4656-20-1320
	22.0 mm 320 mm	1	4656-22-320
	22.0 mm 520 mm	1	4656-22-520
	22.0 mm 920 mm	1	4656-22-920
	22.0 mm 1320 mm	1	4656-22-1320
	24.0 mm 320 mm	1	4656-24-320
	24.0 mm 520 mm	1	4656-24-520
	25.0 mm 320 mm	1	4656-25-320
	25.0 mm 520 mm	1	4656-25-520
	25.0 mm 920 mm	1	4656-25-920
	25.0 mm 1320 mm	1	4656-25-1320
	26.0 mm 520 mm	1	4656-26-520
	28.0 mm 370 mm	1	4656-28-370
	28.0 mm 570 mm	1	4656-28-570
	28.0 mm 670 mm	1	4656-28-670
	28.0 mm 920 mm	1	4656-28-920
	30.0 mm 370 mm	1	4656-30-370
	30.0 mm 570 mm	1	4656-30-570
	32.0 mm 370 mm	1	4656-32-370
	32.0 mm 570 mm	1	4656-32-570
	32.0 mm 920 mm	1	4656-32-920
	32.0 mm 1320 mm	1	4656-32-1320
	35.0 mm 370 mm	1	4656-35-370
	35.0 mm 570 mm	1	4656-35-570
	35.0 mm 670 mm	1	4656-35-670
	37.0 mm 370 mm	1	4656-37-370
	37.0 mm 570 mm	1	4656-37-570
	37.0 mm 920 mm	1	4656-37-920
	38.0 mm 370 mm	1	4656-38-370
	38.0 mm 570 mm	1	4656-38-570
	40.0 mm 370 mm	1	4656-40-370
	40.0 mm 570 mm	1	4656-40-570
	40.0 mm 920 mm	1	4656-40-920
	40.0 mm 1320 mm	1	4656-40-1320
	45.0 mm 570 mm	1	4656-45-570
	45.0 mm 920 mm	1	4656-45-920
	50.0 mm 570 mm	1	4656-50-570
	52.0 mm 570 mm	1	4656-52-570

SDS+ Drill Bits 4-cutter for Reinforced Concrete



4651



Ø	L		
5.0 mm	115 mm	1	4651-5-110
5.0 mm	110 mm	1	4651-5-110-10P
5.0 mm	165 mm	1	4651-5-160
5.0 mm	160 mm	1	4651-5-160-10P
5.0 mm	265 mm	1	4651-5-260
5.5 mm	110 mm	10	4651-5,5-110-10P
5.5 mm	160 mm	1	4651-5,5-160-10P
5.5 mm	115 mm	1	4651-5,5-110
5.5 mm	165 mm	1	4651-5,5-160
6.0 mm	115 mm	1	4651-6-110
6.0 mm	110 mm	1	4651-6-110-10P
6.0 mm	165 mm	1	4651-6-160
6.0 mm	160 mm	1	4651-6-160-10P
6.0 mm	215 mm	1	4651-6-210
6.0 mm	265 mm	1	4651-6-260
6.0 mm	315 mm	1	4651-6-310
6.5 mm	110 mm	50	4651-6,5-110
6.5 mm	165 mm	1	4651-6,5-160
6.5 mm	160 mm	1	4651-6,5-160-10P
6.5 mm	215 mm	1	4651-6,5-210
6.5 mm	265 mm	1	4651-6,5-260
6.5 mm	315 mm	1	4651-6,5-310
7.0 mm	115 mm	1	4651-7-110
7.0 mm	165 mm	1	4651-7-160
8.0 mm	115 mm	1	4651-8-110
8.0 mm	165 mm	1	4651-8-160
8.0 mm	160 mm	1	4651-8-160-10P
8.0 mm	215 mm	1	4651-8-210
8.0 mm	210 mm	1	4651-8-210-10P
8.0 mm	265 mm	1	4651-8-260
8.0 mm	315 mm	1	4651-8-310
8.0 mm	465 mm	1	4651-8-460
10.0 mm	115 mm	1	4651-10-110
10.0 mm	165 mm	1	4651-10-160
10.0 mm	160 mm	1	4651-10-160-10P
10.0 mm	215 mm	1	4651-10-210
10.0 mm	210 mm	1	4651-10-210-10P
10.0 mm	265 mm	1	4651-10-260
10.0 mm	315 mm	1	4651-10-310
10.0 mm	455 mm	1	4651-10-450
10.0 mm	600 mm	1	4651-10-600
10.0 mm	1000 mm	1	4651-10-1000
12.0 mm	160 mm	1	4651-12-160
12.0 mm	160 mm	1	4651-12-160-10P
12.0 mm	210 mm	1	4651-12-210
12.0 mm	210 mm	1	4651-12-210-10P
12.0 mm	260 mm	1	4651-12-260
12.0 mm	310 mm	1	4651-12-310
12.0 mm	450 mm	1	4651-12-450
12.0 mm	600 mm	1	4651-12-600
12.0 mm	1000 mm	1	4651-12-1000
14.0 mm	160 mm	1	4651-14-160
14.0 mm	210 mm	1	4651-14-210
14.0 mm	260 mm	1	4651-14-260
14.0 mm	310 mm	1	4651-14-310
14.0 mm	450 mm	1	4651-14-450
14.0 mm	600 mm	1	4651-14-600
14.0 mm	1000 mm	1	4651-14-1000
15.0 mm	160 mm	1	4651-15-160
15.0 mm	260 mm	1	4651-15-260
15.0 mm	450 mm	1	4651-15-450
16.0 mm	160 mm	1	4651-16-160
16.0 mm	210 mm	1	4651-16-210
16.0 mm	260 mm	1	4651-16-260
16.0 mm	310 mm	1	4651-16-310
16.0 mm	450 mm	1	4651-16-450
16.0 mm	600 mm	1	4651-16-600
16.0 mm	1000 mm	1	4651-16-1000

Ø	L		
18.0 mm	250 mm	1	4651-18-250
18.0 mm	450 mm	1	4651-18-450
20.0 mm	250 mm	1	4651-20-250
20.0 mm	450 mm	1	4651-20-450
22.0 mm	250 mm	1	4651-22-250
22.0 mm	450 mm	1	4651-22-450
24.0 mm	250 mm	1	4651-24-250
24.0 mm	450 mm	1	4651-24-450
25.0 mm	250 mm	1	4651-25-250
25.0 mm	450 mm	1	4651-25-450
28.0 mm	250 mm	1	4651-28-250
28.0 mm	450 mm	1	4651-28-450
30.0 mm	250 mm	1	4651-30-250
30.0 mm	450 mm	1	4651-30-450
32.0 mm	450 mm	1	4651-32-450

Drill Set for Reinforced Concrete SDS + 4C - 5 pcs



4651-SET-5



Ø	L		
5		1	4651-SET-5

4651-5-110, 4651-6-110, 4651-6-160, 4651-8-160, 4651-10-160

Drill Set for Reinforced Concrete SDS + 4C - 7 pcs



4651-SET-7



Ø	L		
7		1	4651-SET-7

4651-5-110, 4651-6-110, 4651-8-110, 4651-6-160, 4651-8-160, 4651-10-160, 4651-12-160

SDS+ Drill Bits 2-cutter for Concrete



4652



Ø	L		
3.0 mm	110 mm	50	4652-3-110
3.5 mm	110 mm	50	4652-3,5-110
4.0 mm	110 mm	1	4652-4-110
4.0 mm	160 mm	1	4652-4-160
5.0 mm	110 mm	1	4652-5-110
5.0 mm	160 mm	1	4652-5-160
5.0 mm	110 mm	1	4652-5-110-10P
5.0 mm	160 mm	1	4652-5-160-10P
5.0 mm	210 mm	1	4652-5-210
5.5 mm	110 mm	1	4652-5,5-110
5.5 mm	110 mm	10	4652-5,5-110-10P
5.5 mm	160 mm	1	4652-5,5-160
5.5 mm	160 mm	1	4652-5,5-160-10P
5.5 mm	210 mm	50	4652-5,5-210
6.0 mm	110 mm	1	4652-6-110
6.0 mm	110 mm	1	4652-6-110-10P
6.0 mm	160 mm	50	4652-6-160
6.0 mm	160 mm	1	4652-6-160-10P
6.0 mm	210 mm	1	4652-6-210
6.0 mm	260 mm	1	4652-6-260
6.5 mm	110 mm	1	4652-6,5-110
6.5 mm	160 mm	1	4652-6,5-160
6.5 mm	160 mm	1	4652-6,5-160-10P
7.0 mm	110 mm	1	4652-7-110
7.0 mm	160 mm	1	4652-7-160
8.0 mm	110 mm	1	4652-8-110
8.0 mm	160 mm	1	4652-8-160
8.0 mm	160 mm	1	4652-8-160-10P
8.0 mm	210 mm	1	4652-8-210
8.0 mm	210 mm	1	4652-8-210-10P
8.0 mm	260 mm	1	4652-8-260
8.0 mm	460 mm	1	4652-8-460
9.0 mm	160 mm	1	4652-9-160
9.0 mm	210 mm	1	4652-9-210
10.0 mm	110 mm	1	4652-10-110
10.0 mm	160 mm	1	4652-10-160
10.0 mm	160 mm	1	4652-10-160-10P
10.0 mm	210 mm	1	4652-10-210
10.0 mm	210 mm	1	4652-10-210-10P
10.0 mm	260 mm	1	4652-10-260
10.0 mm	310 mm	1	4652-10-310
10.0 mm	450 mm	1	4652-10-450
10.0 mm	600 mm	1	4652-10-600
11.0 mm	160 mm	1	4652-11-160
11.0 mm	260 mm	1	4652-11-260
12.0 mm	160 mm	1	4652-12-160
12.0 mm	160 mm	1	4652-12-160-10P
12.0 mm	210 mm	1	4652-12-210
12.0 mm	210 mm	1	4652-12-210-10P
12.0 mm	260 mm	1	4652-12-260
12.0 mm	310 mm	1	4652-12-310
12.0 mm	450 mm	1	4652-12-450
12.0 mm	600 mm	1	4652-12-600
12.0 mm	1000 mm	1	4652-12-1000



Ø	L		
13.0 mm	310 mm	1	4652-13-310
14.0 mm	160 mm	1	4652-14-160
14.0 mm	210 mm	1	4652-14-210
14.0 mm	260 mm	1	4652-14-260
14.0 mm	310 mm	1	4652-14-310
14.0 mm	450 mm	1	4652-14-450
14.0 mm	600 mm	1	4652-14-600
14.0 mm	1000 mm	1	4652-14-1000
15.0 mm	260 mm	1	4652-15-260
16.0 mm	210 mm	1	4652-16-210
16.0 mm	260 mm	1	4652-16-260
16.0 mm	310 mm	1	4652-16-310
16.0 mm	450 mm	1	4652-16-450
16.0 mm	600 mm	1	4652-16-600
16.0 mm	1000 mm	1	4652-16-1000
18.0 mm	200 mm	1	4652-18-200
18.0 mm	300 mm	1	4652-18-300
18.0 mm	450 mm	1	4652-18-450
18.0 mm	1000 mm	1	4652-18-1000
20.0 mm	200 mm	1	4652-20-200
20.0 mm	300 mm	1	4652-20-300
20.0 mm	450 mm	1	4652-20-450
20.0 mm	600 mm	1	4652-20-600
20.0 mm	1000 mm	1	4652-20-1000
22.0 mm	250 mm	1	4652-22-250
22.0 mm	450 mm	1	4652-22-450
22.0 mm	600 mm	1	4652-22-600
22.0 mm	1000 mm	1	4652-22-1000
24.0 mm	250 mm	1	4652-24-250
24.0 mm	450 mm	1	4652-24-450
25.0 mm	250 mm	1	4652-25-250
25.0 mm	450 mm	1	4652-25-450
25.0 mm	1000 mm	1	4652-25-1000
26.0 mm	250 mm	1	4652-26-250
26.0 mm	450 mm	1	4652-26-450

Drill Set for Reinforced Concrete SDS + 2C - 7 pcs



4652-SET-7

X		
7	1	4652-SET-7

4652-5-110, 4652-6-110, 4652-8-110,
4652-6-160, 4652-8-160, 4652-10-160,
4652-12-160

Drill Bits for Concrete with Carbide Tip



4641

Ø	L		
3.0 mm	60 mm	1	4641-3-60
4.0 mm	75 mm	1	4641-4-75
5.0 mm	85 mm	1	4641-5-85
5.0 mm	150 mm	1	4641-5-150
5.5 mm	85 mm	1	4641-5.5-85
6.0 mm	100 mm	1	4641-6-100
6.0 mm	150 mm	1	4641-6-150
6.0 mm	400 mm	1	4641-6-400
6.5 mm	100 mm	1	4641-6.5-100
7.0 mm	100 mm	1	4641-7-100
8.0 mm	120 mm	1	4641-8-120
8.0 mm	200 mm	1	4641-8-200
8.0 mm	400 mm	1	4641-8-400
9.0 mm	120 mm	1	4641-9-120
10.0 mm	120 mm	1	4641-10-120
10.0 mm	200 mm	1	4641-10-200
10.0 mm	400 mm	1	4641-10-400
10.0 mm	600 mm	1	4641-10-600
11.0 mm	150 mm	1	4641-11-150
12.0 mm	150 mm	1	4641-12-150
12.0 mm	200 mm	1	4641-12-200
12.0 mm	400 mm	1	4641-12-400
12.0 mm	600 mm	1	4641-12-600
13.0 mm	150 mm	1	4641-13-150
14.0 mm	150 mm	1	4641-14-150
14.0 mm	400 mm	1	4641-14-400
14.0 mm	600 mm	1	4641-14-600
16.0 mm	150 mm	1	4641-16-150
16.0 mm	400 mm	1	4641-16-400

Drill Set for Reinforced Concrete SDS + 2C - 5 pcs



4652-SET-5

X		
5	1	4652-SET-5

4652-5-110, 4652-6-110, 4652-6-160,
4652-8-160, 4652-10-160

Ø	L		
16.0 mm	600 mm	1	4641-16-600
18.0 mm	400 mm	1	4641-18-400
18.0 mm	600 mm	1	4641-18-600
20.0 mm	400 mm	1	4641-20-400
20.0 mm	600 mm	1	4641-20-600
22.0 mm	400 mm	1	4641-22-400
24.0 mm	400 mm	1	4641-24-400
25.0 mm	400 mm	1	4641-25-400

Drill Set for Concrete with Carbide Tip - 5 Pcs



4641-PB

X	g	
5	185 g	1 4641-PB

4641-4-75, 4641-5-85, 4641-6-100, 4641-8-120,
4641-10-120

Drill Set for Masonry with Carbide Tip - 5 pcs



4643-PB

X	g	
5	150 g	1 4643-PB

4mm, 5mm, 6mm, 8mm and 10mm 1pc x Ø 4, 5, 6, 8, 10 mm

SDS Max Chisel Drill Bits for Reinforced Concrete



4659



Ø	L	Icon	Icon
- mm	280 mm	1	4659-POINT-28
- mm	400 mm	1	4659-POINT-40
- mm	600 mm	1	4659-POINT-60
24.0 mm	280 mm	1	4659-FLAT-28
24.0 mm	400 mm	1	4659-FLAT-40
24.0 mm	600 mm	1	4659-FLAT-60
80.0 mm	300 mm	1	4659-WIDE-30-8
50.0 mm	360 mm	1	4659-WIDE-36-5
50.0 mm	300 mm	1	4659-TILE-30-5
80.0 mm	300 mm	1	4659-TILE-30-8

SDS+ Chisel Drill Bits for Reinforced Concrete



4655



Ø	L	Icon	Icon
20.0 mm	250 mm	1	4655-FLAT-250
22.0 mm	240 mm	1	4655-HOLLOW-240
- mm	250 mm	1	4655-POINT-250
32.0 mm	200 mm	1	4655-SLOT-25032
38.0 mm	200 mm	1	4655-TILE-20040
38.0 mm	200 mm	1	4655-WIDE-20040
22.0 mm	250 mm	1	4655-WING-C-250

Cobalt HSS-E Drill Bits for Metal



4411



Ø	L	Icon	Icon
1.00 mm	34 mm	1	4411-1.00
1.50 mm	40 mm	1	4411-1.50
2.00 mm	49 mm	1	4411-2.00
2.50 mm	57 mm	1	4411-2.50
3.00 mm	61 mm	1	4411-3.00
3.25 mm	65 mm	1	4411-3.25
3.30 mm	65 mm	1	4411-3.30
3.50 mm	70 mm	1	4411-3.50
4.00 mm	75 mm	1	4411-4.00
4.20 mm	75 mm	1	4411-4.20
4.25 mm	75 mm	1	4411-4.25
4.50 mm	80 mm	1	4411-4.50
5.00 mm	86 mm	1	4411-5.00
5.50 mm	93 mm	1	4411-5.50
6.00 mm	93 mm	1	4411-6.00
6.50 mm	101 mm	1	4411-6.50

Ø	L	Icon	Icon
6.80 mm	109 mm	1	4411-6.80
7.00 mm	109 mm	1	4411-7.00
7.50 mm	109 mm	1	4411-7.50
8.00 mm	117 mm	1	4411-8.00
8.50 mm	117 mm	1	4411-8.50
9.00 mm	125 mm	1	4411-9.00
9.50 mm	125 mm	1	4411-9.50
10.00 mm	125 mm	1	4411-10.00
10.20 mm	133 mm	1	4411-10.20
10.50 mm	133 mm	1	4411-10.50
11.00 mm	142 mm	1	4411-11.00
11.50 mm	142 mm	1	4411-11.50
12.00 mm	151 mm	1	4411-12.00
12.50 mm	151 mm	1	4411-12.50
13.00 mm	151 mm	1	4411-13.00

Size 1 mm up to 4 mm, two drills in each tube

Cobalt HSS-E Drill Bits for Metal with Industrial Pack



4511

Ø	L	Icon	Icon
0.50 mm	22 mm	1	4511-0.50-10P
0.75 mm	28 mm	1	4511-0.75-10P
1.00 mm	34 mm	1	4511-1.00-10P
1.50 mm	40 mm	1	4511-1.50-10P
1.75 mm	46 mm	1	4511-1.75-10P
2.00 mm	49 mm	1	4511-2.00-10P
2.50 mm	57 mm	1	4511-2.50-10P
2.70 mm	61 mm	1	4511-2.70-10P
2.90 mm	61 mm	1	4511-2.90-10P
3.00 mm	61 mm	1	4511-3.00-10P
3.10 mm	65 mm	1	4511-3.10-10P
3.25 mm	65 mm	1	4511-3.25-10P
3.30 mm	65 mm	1	4511-3.30-10P
3.50 mm	70 mm	1	4511-3.50-10P
3.80 mm	75 mm	1	4511-3.80-10P
4.00 mm	75 mm	1	4511-4.00-10P
4.20 mm	75 mm	1	4511-4.20-10P
4.50 mm	80 mm	1	4511-4.50-10P
4.80 mm	86 mm	1	4511-4.80-10P
5.00 mm	86 mm	1	4511-5.00-10P
5.20 mm	86 mm	1	4511-5.20-10P
5.50 mm	93 mm	1	4511-5.50-10P
6.00 mm	93 mm	1	4511-6.00-10P
6.20 mm	101 mm	1	4511-6.20-10P
6.50 mm	101 mm	1	4511-6.50-10P
6.80 mm	109 mm	1	4511-6.80-10P
7.00 mm	109 mm	1	4511-7.00-10P
7.20 mm	109 mm	1	4511-7.20-10P
7.50 mm	109 mm	1	4511-7.50-10P
7.80 mm	117 mm	1	4511-7.80-10P
8.00 mm	117 mm	1	4511-8.00-10P
8.50 mm	117 mm	1	4511-8.50-10P
8.60 mm	125 mm	1	4511-8.60-10P
8.80 mm	125 mm	1	4511-8.80-10P
9.00 mm	125 mm	1	4511-9.00-10P
9.20 mm	125 mm	1	4511-9.20-10P
9.50 mm	125 mm	1	4511-9.50-10P
9.60 mm	133 mm	1	4511-9.60-10P
10.00 mm	133 mm	1	4511-10.00-5P
10.20 mm	133 mm	1	4511-10.20-5P
10.30 mm	133 mm	1	4511-10.30-5P
10.50 mm	133 mm	1	4511-10.50-5P
10.80 mm	142 mm	1	4511-10.80-5P
11.00 mm	142 mm	1	4511-11.00-5P
11.50 mm	142 mm	1	4511-11.50-5P
12.00 mm	151 mm	1	4511-12.00-5P
12.50 mm	151 mm	1	4511-12.50-5P
12.80 mm	151 mm	1	4511-12.80-5P

Ø	L	Icon	Icon
13.00 mm	151 mm	1	4511-13.00-5P
13.50 mm	160 mm	1	4511-13.50-1P
14.00 mm	160 mm	1	4511-14.00-1P
14.50 mm	169 mm	1	4511-14.50-1P
15.00 mm	169 mm	1	4511-15.00-1P
15.50 mm	169 mm	1	4511-15.50-1P
16.00 mm	178 mm	1	4511-16.00-1P
16.50 mm	184 mm	1	4511-16.50-1P
17.00 mm	184 mm	1	4511-17.00-1P
17.50 mm	191 mm	1	4511-17.50-1P
18.00 mm	191 mm	1	4511-18.00-1P
18.50 mm	198 mm	1	4511-18.50-1P
19.00 mm	198 mm	1	4511-19.00-1P
19.50 mm	205 mm	1	4511-19.50-1P
20.00 mm	205 mm	1	4511-20.00-1P

Cobalt HSS-E Drill Bit Set for Metal - 6 Pcs



4511-SET-6

Icon	g	Icon	Icon
6	150 g	1	4511-SET-6

2.0 to 8.0 mm x 1.0 mm (excl. 7.0 mm)

4411-2.00, 4411-3.00, 4411-4.00, 4411-5.00, 4411-6.00, 4411-8.00

Cobalt HSS-E Drill Bit Set for Metal - 19 Pcs



4511-SET-19

Icon	g	Icon	Icon
19	600 g	1	4511-SET-19

1.0 to 10.0 mm x 0.5 mm

4411-1.00, 4411-1.50, 4411-2.00, 4411-2.50, 4411-3.00, 4411-3.50, 4411-4.00, 4411-4.50, 4411-5.00, 4411-5.50, 4411-6.00, 4411-6.50, 4411-7.00, 4411-7.50, 4411-8.00, 4411-8.50, 4411-9.00, 4411-9.50, 4411-10.00



Cobalt HSS-E Drill Bit Set for Metal - 25 Pcs



4511-SET-25

25	1200 g	1	4511-SET-25

1x 1.0, 1.5; 2.0; 2.5; 3.0; 3.5; 4.0; 4.5; 5.0; 5.5; 6.0; 6.5; 7.0; 7.5; 8.0; 8.5; 9.0; 9.5; 10.0; 10.5; 11.0; 11.5; 12; 12.5; 13.0mm



HSS-G Drill Bits for Metal



4413

1.00 mm	34 mm	1	4413-1.00
1.50 mm	40 mm	1	4413-1.50
2.00 mm	49 mm	1	4413-2.00
2.50 mm	57 mm	1	4413-2.50
3.00 mm	61 mm	1	4413-3.00
3.25 mm	65 mm	1	4413-3.25
3.30 mm	65 mm	1	4413-3.30
3.50 mm	70 mm	1	4413-3.50
4.00 mm	75 mm	1	4413-4.00
4.20 mm	75 mm	1	4413-4.20
4.25 mm	75 mm	1	4413-4.25
4.50 mm	80 mm	1	4413-4.50
5.00 mm	86 mm	1	4413-5.00
5.50 mm	93 mm	1	4413-5.50
6.00 mm	93 mm	1	4413-6.00
6.50 mm	101 mm	1	4413-6.50
6.80 mm	109 mm	1	4413-6.80
7.00 mm	109 mm	1	4413-7.00
7.50 mm	109 mm	1	4413-7.50
8.00 mm	117 mm	1	4413-8.00
8.50 mm	117 mm	1	4413-8.50
9.00 mm	125 mm	1	4413-9.00
9.50 mm	125 mm	1	4413-9.50
10.00 mm	133 mm	1	4413-10.00
10.20 mm	133 mm	1	4413-10.20
10.50 mm	133 mm	25	4413-10.50
11.00 mm	142 mm	1	4413-11.00
11.50 mm	142 mm	25	4413-11.50
12.00 mm	151 mm	1	4413-12.00
12.50 mm	151 mm	25	4413-12.50
13.00 mm	151 mm	1	4413-13.00



Size 1 mm up to 4 mm, two drills in each tube

HSS-G Drill Bits for Metal with Industrial Pack



4513

1.00 mm	34 mm	1	4513-1.00-10P
1.50 mm	40 mm	1	4513-1.50-10P
1.75 mm	46 mm	1	4513-1.75-10P
2.00 mm	49 mm	1	4513-2.00-10P
2.50 mm	57 mm	1	4513-2.50-10P
2.70 mm	61 mm	1	4513-2.70-10P
2.90 mm	61 mm	1	4513-2.90-10P
3.00 mm	61 mm	1	4513-3.00-10P
3.10 mm	65 mm	1	4513-3.10-10P
3.25 mm	65 mm	1	4513-3.25-10P
3.30 mm	65 mm	1	4513-3.30-10P
3.50 mm	70 mm	1	4513-3.50-10P
3.80 mm	75 mm	1	4513-3.80-10P
4.00 mm	75 mm	1	4513-4.00-10P
4.20 mm	75 mm	1	4513-4.20-10P
4.50 mm	80 mm	1	4513-4.50-10P
4.80 mm	86 mm	1	4513-4.80-10P
5.00 mm	86 mm	1	4513-5.00-10P
5.20 mm	86 mm	1	4513-5.20-10P
5.50 mm	93 mm	1	4513-5.50-10P
6.00 mm	93 mm	1	4513-6.00-10P
6.20 mm	101 mm	1	4513-6.20-10P
6.50 mm	101 mm	1	4513-6.50-10P
6.80 mm	109 mm	1	4513-6.80-10P
7.00 mm	109 mm	1	4513-7.00-10P
7.20 mm	109 mm	1	4513-7.20-10P
7.50 mm	109 mm	1	4513-7.50-10P
7.80 mm	117 mm	1	4513-7.80-10P
8.00 mm	117 mm	1	4513-8.00-10P
8.50 mm	117 mm	1	4513-8.50-10P
8.60 mm	125 mm	1	4513-8.60-10P
8.80 mm	125 mm	1	4513-8.80-10P
9.00 mm	125 mm	1	4513-9.00-10P
9.20 mm	125 mm	1	4513-9.20-10P
9.50 mm	125 mm	1	4513-9.50-10P
9.60 mm	133 mm	1	4513-9.60-10P
10.00 mm	133 mm	1	4513-10.00-5P
10.20 mm	133 mm	1	4513-10.20-5P
10.30 mm	133 mm	1	4513-10.30-5P
10.50 mm	133 mm	1	4513-10.50-5P
10.80 mm	142 mm	1	4513-10.80-5P
11.00 mm	142 mm	1	4513-11.00-5P
11.50 mm	142 mm	1	4513-11.50-5P
12.00 mm	151 mm	1	4513-12.00-5P
12.50 mm	151 mm	1	4513-12.50-5P
12.80 mm	151 mm	1	4513-12.80-5P
13.00 mm	151 mm	1	4513-13.00-5P
13.50 mm	160 mm	1	4513-13.50-1P
14.00 mm	160 mm	1	4513-14.00-1P
14.50 mm	169 mm	1	4513-14.50-1P
15.00 mm	169 mm	1	4513-15.00-1P
15.50 mm	178 mm	1	4513-15.50-1P
16.00 mm	178 mm	1	4513-16.00-1P
16.50 mm	184 mm	1	4513-16.50-1P
17.00 mm	184 mm	1	4513-17.00-1P
17.50 mm	191 mm	1	4513-17.50-1P
18.00 mm	191 mm	1	4513-18.00-1P

18.50 mm	198 mm	1	4513-18.50-1P
19.00 mm	198 mm	1	4513-19.00-1P
19.50 mm	205 mm	1	4513-19.50-1P
20.00 mm	205 mm	1	4513-20.00-1P

HSS-G Drill Bit Set for Metal - 6 Pcs



4513-SET-6

6	150 g	1	4513-SET-6

2.0 to 8.0 mm x 1.0 mm (excl. 7.0 mm)

4413-2.00, 4413-3.00, 4413-4.00, 4413-5.00, 4413-6.00, 4413-8.00



HSS-G Drill Bit Set for Metal - 19 Pcs



4513-SET-19

19	600 g	1	4513-SET-19

1.0 to 10.0 mm x 0.5 mm

4413-1.00, 4413-1.50, 4413-2.00, 4413-2.50, 4413-3.00, 4413-3.50, 4413-4.00, 4413-4.50, 4413-5.00, 4413-5.50, 4413-6.00, 4413-6.50, 4413-7.00, 4413-7.50, 4413-8.00, 4413-8.50, 4413-9.00, 4413-9.50, 4413-10.00



HSS-G Drill Bit Set for Metal - 25 Pcs



Ø	L	Icon	Part No.
12.50 mm	151 mm	1	4415-12.50
13.00 mm	151 mm	1	4415-13.00
13.50 mm	160 mm	1	4415-13.50
14.00 mm	160 mm	1	4415-14.00
14.50 mm	169 mm	1	4415-14.50
15.00 mm	169 mm	1	4415-15.00
15.50 mm	178 mm	1	4415-15.50
16.00 mm	178 mm	1	4415-16.00
16.50 mm	184 mm	1	4415-16.50
17.00 mm	184 mm	1	4415-17.00
17.50 mm	191 mm	1	4415-17.50
18.00 mm	191 mm	1	4415-18.00
18.50 mm	198 mm	1	4415-18.50
19.00 mm	198 mm	1	4415-19.00
19.50 mm	205 mm	1	4415-19.50
20.00 mm	205 mm	1	4415-20.00

Size 1 mm up to 4 mm, two drills in each tube

4513-SET-25



25	1200 g	1	4513-SET-25
----	--------	---	-------------

1x 1.0, 1.5; 2.0; 2.5; 3.0; 3.5; 4.0; 4.5; 5.0; 5.5; 6.0; 6.5; 7.0; 7.5; 8.0; 8.5; 9.0; 9.5; 10.0; 10.5; 11.0; 11.5; 12; 12.5; 13.0 mm

HSS-R Drill Bits for Metal



4515

Ø	L	Icon	Part No.
1.00 mm	34 mm	1	4515-1.00-10P
1.50 mm	40 mm	1	4515-1.50-10P
2.00 mm	49 mm	1	4515-2.00-10P
2.50 mm	57 mm	1	4515-2.50-10P
3.00 mm	61 mm	1	4515-3.00-10P
3.25 mm	65 mm	1	4515-3.25-10P
3.50 mm	70 mm	1	4515-3.50-10P
4.00 mm	75 mm	1	4515-4.00-10P
4.25 mm	75 mm	1	4515-4.25-10P
4.50 mm	80 mm	1	4515-4.50-10P
5.00 mm	86 mm	1	4515-5.00-10P
5.50 mm	93 mm	1	4515-5.50-10P
6.00 mm	93 mm	1	4515-6.00-10P
6.50 mm	101 mm	1	4515-6.50-10P
7.00 mm	109 mm	1	4515-7.00-10P
7.50 mm	109 mm	1	4515-7.50-10P
8.00 mm	117 mm	1	4515-8.00-10P
8.50 mm	117 mm	1	4515-8.50-10P
9.00 mm	125 mm	1	4515-9.00-10P
9.50 mm	125 mm	1	4515-9.50-10P
10.00 mm	133 mm	1	4515-10.00-10P
10.50 mm	133 mm	1	4515-10.50-5P
11.00 mm	142 mm	1	4515-11.00-5P
11.50 mm	142 mm	1	4515-11.50-5P
12.00 mm	151 mm	1	4515-12.00-5P
12.50 mm	151 mm	1	4515-12.50-5P
13.00 mm	151 mm	1	4515-13.00-5P

4415



Ø	L	Icon	Part No.
1.00 mm	34 mm	1	4415-1.00
1.50 mm	40 mm	1	4415-1.50
2.00 mm	49 mm	1	4415-2.00
2.50 mm	57 mm	1	4415-2.50
3.00 mm	61 mm	1	4415-3.00
3.25 mm	65 mm	1	4415-3.25
3.50 mm	70 mm	1	4415-3.50
4.00 mm	75 mm	1	4415-4.00
4.25 mm	75 mm	1	4415-4.25
4.50 mm	80 mm	1	4415-4.50
5.00 mm	86 mm	1	4415-5.00
5.50 mm	93 mm	1	4415-5.50
6.00 mm	93 mm	1	4415-6.00
6.50 mm	101 mm	1	4415-6.50
7.00 mm	109 mm	1	4415-7.00
7.50 mm	109 mm	1	4415-7.50
8.00 mm	117 mm	1	4415-8.00
8.50 mm	117 mm	1	4415-8.50
9.00 mm	125 mm	1	4415-9.00
10.00 mm	125 mm	1	4415-10.00
10.50 mm	133 mm	1	4415-10.50
11.00 mm	142 mm	1	4415-11.00
11.50 mm	142 mm	1	4415-11.50
12.00 mm	151 mm	1	4415-12.00

HSS-R Drill Bit Set for Metal - 19 Pcs



4515-SET-19



19	600 g	1	4515-SET-19
----	-------	---	-------------

1x 1.0mm; 1.5mm; 2.0mm; 2.5mm; 3.0mm; 3.5mm; 4.0mm; 4.5mm; 5.0mm; 5.5mm; 6.0mm; 6.5mm; 7mm; 7.5mm; 8mm; 8.5mm; 9.0mm; 9.5mm; 10mm

HSS-R Drill Bit Set for Metal - 25 pcs



4515-SET-25



25	1200 g	1	4515-SET-25
----	--------	---	-------------

1x 1.0; 1.5; 2.0; 2.5; 3.0; 3.5; 4.0; 4.5; 5.0; 5.5; 6.0; 6.5; 7; 7.5; 8; 8.5; 9.0; 9.5; 10; 10.5; 11; 11.5; 12; 12.5; 13 mm 1pc Ø 13.0mm

Step Drills for Metal Sheet 4 mm-12 mm



228-SD

6.35 mm	4-5-6-7-8-9-10-11-12 mm	24	228-SD
---------	-------------------------	----	--------



Flat Drill Bits for Wood



9629

Ø	L		
6.0 mm	152 mm	1	9629-6
8.0 mm	152 mm	1	9629-8
10.0 mm	152 mm	1	9629-10
12.0 mm	152 mm	1	9629-12
13.0 mm	152 mm	1	9629-13
14.0 mm	152 mm	1	9629-14
16.0 mm	152 mm	1	9629-16
17.0 mm	152 mm	1	9629-17
18.0 mm	152 mm	1	9629-18
19.0 mm	152 mm	1	9629-19
20.0 mm	152 mm	1	9629-20
22.0 mm	152 mm	1	9629-22
24.0 mm	152 mm	1	9629-24
25.0 mm	152 mm	1	9629-25
26.0 mm	152 mm	1	9629-26
28.0 mm	152 mm	1	9629-28
30.0 mm	152 mm	1	9629-30
32.0 mm	152 mm	1	9629-32
35.0 mm	152 mm	1	9629-35
36.0 mm	152 mm	1	9629-36
38.0 mm	152 mm	1	9629-38
40.0 mm	152 mm	1	9629-40
6.0 mm	400 mm	1	9631-6-400
8.0 mm	400 mm	1	9631-8-400
10.0 mm	400 mm	1	9631-10-400
12.0 mm	400 mm	1	9631-12-400
13.0 mm	400 mm	1	9631-13-400
14.0 mm	400 mm	1	9631-14-400
16.0 mm	400 mm	1	9631-16-400
18.0 mm	400 mm	1	9631-18-400
19.0 mm	400 mm	1	9631-19-400
20.0 mm	400 mm	1	9631-20-400
22.0 mm	400 mm	1	9631-22-400
24.0 mm	400 mm	1	9631-24-400
25.0 mm	400 mm	1	9631-25-400
28.0 mm	400 mm	1	9631-28-400
30.0 mm	400 mm	1	9631-30-400
32.0 mm	400 mm	1	9631-32-400
35.0 mm	400 mm	1	9631-35-400
38.0 mm	400 mm	1	9631-38-400

Flat Drill Bit Set for Wood - 8 pcs



9629-SET-8

X	g		
8	630 g	10	9629-SET-8

9629-12, 9629-16, 9629-18, 9629-20, 9629-22, 9629-25, 9629-28, 9629-32



Brad Point Drill Bit Set for Wood - 6 Pcs



9656-SET-6

X	g		
6	720 g	1	9656-SET-6

Brad Point Drill Bits for Wood



9646

Ø			
3 mm		1	9646-3
4 mm		1	9646-4
5 mm		1	9646-5
6 mm		1	9646-6
7 mm		1	9646-7
8 mm		1	9646-8
9 mm		1	9646-9
10 mm		1	9646-10
11 mm		1	9646-11
12 mm		1	9646-12
13 mm		1	9646-13
14 mm		1	9646-14
15 mm		1	9646-15
16 mm		1	9646-16
18 mm		1	9646-18
20 mm		1	9646-20
6 mm		1	9646-6-250
8 mm		1	9646-8-250
10 mm		1	9646-10-250
12 mm		1	9646-12-250

Brad Point Drill Bit Set for Wood - 5 pcs



9646-SET-5

X	g		
5	110 g	1	9646-SET-5

9646-4, 9646-5, 9646-6, 9646-8, 9646-10

Brad Point Drill Bit Set for Wood - 8 pcs



9646-SET-8

X	g		
8	230 g	1	9646-SET-8

9646-3, 9646-4, 9646-5, 9646-6, 9646-7, 9646-8, 9646-9, 9646-10

Expansive Drill Bits for Wood



9528

Ø			
15-45 mm		10	9528-MD-15-45
22-76 mm		10	9528-MD-22-76



Drill Bits for Tiles



4626

Ø	L	Icons	Part No.
4 mm	58 mm		1 4626-4.0
5 mm	58 mm		1 4626-5.0
6 mm	58 mm		1 4626-6.0
8 mm	78 mm		1 4626-8.0
10 mm	98 mm		1 4626-10.0

Multi-Purpose Drill Bits for Tiles, Natural Stone, Wood and Plastic



4629

Ø	L	Icons	Part No.
4.0 mm	75 mm		1 4629-4.0
5.0 mm	85 mm		1 4629-5.0
6.0 mm	100 mm		1 4629-6.0
8.0 mm	120 mm		1 4629-8.0
10.0 mm	120 mm		1 4629-10.0

Drill Set Multi-Purpose with Carbide Tip - 5 pcs



4629-SET-5

Icons	Weight	Quantity	Part No.
	165 g	10	4629-SET-5

4629-8.0, 4629-10.0, 4629-4.0, 4629-5.0, 4629-6.0

Extension Shaft 305 mm 1/4" Quick-Change



9625-6.35QC

Ø	L	Icons	Part No.
6.35 mm	305 mm		1 9625-6.35QC

Extension Shafts 330 mm



9525

Ø	L	Icons	Part No.
14-19 mm			1 9525-7
20-32 mm			1 9525-10

SCREWDRIVER BITS

1/4" Diamond Torsion Screwdriver Bits for Phillips Head Screws 25 mm



63D/PH

Icons	Quantity	Part No.
	3	63D/PH3

1/4" Diamond Torsion Screwdriver Bits for Phillips Dry Wall Head Screws 25 mm



63D/PH2G

Icons	Quantity	Part No.
	5	63D/PH2G

1/4" Diamond Torsion Screwdriver Bits for Pozidriv Head Screws 25 mm



63D/PZ

Icons	Quantity	Part No.
	2	63D/PZ2

1/4" Diamond Torsion Screwdriver Bits for TORX® Head Screws 25 mm



63D/T

Icons	Quantity	Part No.
	5	T10
	5	T15
	5	T40

1/4" Diamond Torsion Screwdriver Bits for Pozidriv Head Screws 50 mm - 5 Pcs/ Plastic Box



63D/50PZ

5	1	1	63D/50PZ1	
5	2	1	63D/50PZ2	
5	3	1	63D/50PZ3	

1/4" Tin Torsion Screwdriver Bits for Pozidriv Head Screws 25 mm



62TIN/PZ

10	1	1	62TIN/PZ1
10	2	1	62TIN/PZ2
10	3	1	62TIN/PZ3

1/4" Tin Torsion Screwdriver Bits for Pozidriv Head Screws 50 mm



62TIN/50PZ

5	1	1	62TIN/50PZ1
5	2	1	62TIN/50PZ2
5	3	1	62TIN/50PZ3

1/4" Diamond Torsion Screwdriver Bits Set with Bit Holder for Phillips/Pozidriv/TORX® Head Screws



63D/7

7			20 x 50 x 80 mm	1 63D/7-1

1 adaptor

63D/PH2		
63D/PZ2		
63D/T10, 63D/T15, 63D/T25, 63D/T30		

1/4" Tin Torsion Screwdriver Bits for TORX® Head Screws 25 mm



62TIN/T

10	T15	1	62TIN/T15
10	T20	1	62TIN/T20
10	T25	1	62TIN/T25
10	T30	1	62TIN/T30

1/4" Tin Torsion Bit Set for Phillips/Pozidriv/TORX® Head Screws



62TIN/7

7	22 x 65 x 75 mm	1 62TIN/7-1

includes a bit holder

62TIN/PH2		
62TIN/PZ2		
62TIN/T15, 62TIN/T20, 62TIN/T25, 62TIN/T30		

1/4" Tin Torsion Screwdriver Bits for Phillips Head Screws 25 mm



62TIN/PH

10	1	1	62TIN/PH1

1/4" Tin Torsion Screwdriver Bits for Phillips Head Screws 50 mm



62TIN/50PH

5	1	1	62TIN/50PH1
5	3	1	62TIN/50PH3

1/4" ACR Torsion Screwdriver Bits for Phillips Head Screws 25 mm



64A/PH

10	1	1	64A/PH1
10	3	1	64A/PH3



1/4" ACR Torsion Screwdriver Bits for Pozidriv Head Screws 25 mm



64A/PZ

X	+	+	
10	1	1	64A/PZ1
10	3	1	64A/PZ3

1/4" Torsion Screwdriver Bits for Phillips Head Screws 25 mm



60T/PH

X	+	+	
10	1	1	60T/PH1
10	2	1	60T/PH2
10	3	1	60T/PH3

1/4" Torsion Screwdriver Bits for Pozidriv Head Screws 25 mm



60T/PZ

X	+	+	
10	1	1	60T/PZ1
10	2	1	60T/PZ2
10	3	1	60T/PZ3

1/4" Torsion Screwdriver Bits for TORX® Head Screws 25 mm



60T/T

X	+	+	
10		1	60T/T7
10		1	60T/T9
10		1	60T/T15
10		1	60T/T20
10		1	60T/T25
10		1	60T/T27
10		1	60T/T40

1/4" Torsion Bit Set for Phillips/Pozidriv/TORX® head screws - 7 Pcs



60T/7

X	+	+	
7		1	60T/7-1

includes a bit holder

60T/PH2	+	+	
60T/PZ2	+	+	
60T/T10, 60T/T15, 60T/T20, 60T/T30	+	+	

1/4" Torsion Bit Set for Phillips/TORX® head screws - 17 Pcs



60T/17

X	+	+	
17		1	60T/17-1

includes a bit holder of 50mm

60T/PH1, 60T/PH2	+	+	
60T/T7, 60T/T8, 60T/T9, 60T/T10, 60T/T15x 2, 60T/T20x 2, 60T/T25x 2, 60T/T27, 60T/T30x 2, 60T/T40	+	+	

1/4" Torsion Bit Set for Slotted/Phillips/Pozidriv/TORX®/Hex head screws - 31 Pcs



60T/31

X	+	+	
31		12	60T/31-1

includes a bit holder of 50mm

59S/0.6-4.5, 59S/0.8-5.5	+	+	
60T/PH1, 60T/PH2x 3, 60T/PH3	+	+	
59S/PH2Gx 2	+	+	
60T/PZ1, 60T/PZ2x 3, 60T/PZ3	+	+	
60T/T10, 60T/T15x 3, 60T/T20x 3, 60T/T25x 2, 60T/T27, 60T/T30x 2	+	+	
59S/H3, 59S/H4, 59S/H5, 59S/H6	+	+	

1/4" Extra Hard Torsion Screwdriver Bits for Phillips Head Screws 25 mm



61H/PH

X	+	+	
10	1	1	61H/PH1
10	2	1	61H/PH2
5	3	1	61H/PH3

1/4" Extra Hard Torsion Screwdriver Bits for Phillips Head Screws 50 mm



61H/50PH

X	+	PH	Part Number
5	1	1	61H/50PH1

1/4" Extra Hard Torsion Screwdriver Bits for TORX® Head Screws 50 mm



61H/50T

X	T	PH	Part Number
5	T10	1	61H/50T10
5	T15	1	61H/50T15
5	T25	1	61H/50T25
5	T30	1	61H/50T30

1/4" Impact Torsion Screwdriver Bits for Pozidriv Head Screws 25 mm



66IM/PZ

X	+	PH	Part Number
2	1	1	66IM/PZ1-2P
2	2	1	66IM/PZ2-2P
2	3	1	66IM/PZ3-2P

1/4" Extra Hard Torsion Screwdriver Bits for Pozidriv Head Screws 25 mm



61H/PZ

X	+	PH	Part Number
5	3	1	61H/PZ3

1/4" Extra Hard Torsion Screwdriver Bits for TORX® Head Screws 25 mm



61H/T

X	T	PH	Part Number
10	T10	1	61H/T10
10	T20	1	61H/T20
10	T25	1	61H/T25
5	T40	1	61H/T40

1/4" Impact Torsion Screwdriver Bits for TORX® Head Screws 25 mm



66IM/T

X	T	PH	Part Number
2	T10	1	66IM/T10C-2P
2	T15	1	66IM/T15C-2P
2	T20	1	66IM/T20C-2P
2	T25	1	66IM/T25C-2P
2	T27	1	66IM/T27C-2P
2	T20	1	66IM/T30C-2P
2	T40	1	66IM/T40C-2P

1/4" Extra Hard Torsion Screwdriver Bits for Pozidriv Head Screws 50 mm



61H/50PZ

X	+	PH	Part Number
5	1	1	61H/50PZ1
5	2	1	61H/50PZ2
5	3	1	61H/50PZ3

1/4" Impact Torsion Screwdriver Bits for Phillips Head Screws 25 mm



66IM/PH

X	+	PH	Part Number
2	1	1	66IM/PH1-2P
2	2	1	66IM/PH2-2P
2	3	1	66IM/PH3-2P

1/4" Impact Torsion Screwdriver Bits for Phillips Head Screws 50 mm



66IM/50PH

X	+	PH	Part Number
2	1	1	66IM/50PH1-2P
2	2	1	66IM/50PH2-2P
2	3	1	66IM/50PH3-2P



1/4" Impact Torsion Screwdriver Bits for Pozidriv Head Screws 50 mm



66IM/50PZ

X	+	+	+
2	1	1	66IM/50PZ1-2P
2	2	1	66IM/50PZ2-2P
2	3	1	66IM/50PZ3-2P

1/4" Impact Torsion Bit Set for Phillips/Pozidriv/TORX® with Soft Plastic Holder, 25 mm bits- 10 Pcs



66IM/10C-1

X	+	+	+
10	10 x 50 x 140 mm	40	66IM/10C-1

66IM/50PH2-2Px 2, 66IM/50PH3-2P	+	
66IM/50PZ2-2Px 2, 66IM/50PZ3-2P	+	
66IM/50T20C-2Px 2, 66IM/50T25C-2P, 66IM/50T30C-2P	+	

1/4" Standard Screwdriver Bits for Slotted Head Screws 25 mm



66IM/50TC

X	+	+	+
2	10	1	66IM/50T10C-2P
2	15	1	66IM/50T15C-2P
2	20	1	66IM/50T20C-2P
2	25	1	66IM/50T25C-2P
2	27	1	66IM/50T27C-2P
2	30	1	66IM/50T30C-2P
2	40	1	66IM/50T40C-2P



1/4" Impact Torsion Bit Set for Phillips/Pozidriv/TORX® with Soft Plastic Holder, 50 mm bits - 11 Pcs



66IM/11C-1

X	+	+	+
11	25 x 37 x 140 mm	40	66IM/11C-1

66IM/PH2-2Px 2, 66IM/PH3-2P	+	
66IM/PZ2-2Px 2, 66IM/PZ3-2P	+	
66IM/T20C-2Px 2, 66IM/T25C-2P, 66IM/T30C-2P	+	
KMT753-QR-1P	○	

59S/

X	+	+	+
10	3.0 mm	1	59S/0.5-3.0
3	3.0 mm	50	59S/0.5-3.0-3P
10	4.0 mm	1	59S/0.5-4.0
3	4.0 mm	50	59S/0.5-4.0-3P
10	3.5 mm	1	59S/0.6-3.5
3	3.5 mm	50	59S/0.6-3.5-3P
10	4.5 mm	1	59S/0.6-4.5
3	4.5 mm	1	59S/0.6-4.5-3P
10	5.5 mm	1	59S/0.8-5.5
3	5.5 mm	1	59S/0.8-5.5-3P
10	5.5 mm	1	59S/1.0-5.5
3	5.5 mm	50	59S/1.0-5.5-3P
10	6.5 mm	1	59S/1.2-6.5
3	6.5 mm	50	59S/1.2-6.5-3P
10	8.0 mm	1	59S/1.2-8.0
3	8.0 mm	1	59S/1.2-8.0-3P
10	9.0 mm	1	59S/1.6-9.0
10	10 mm	1	59S/1.6-10
3	9.0 mm	50	59S/1.6-9.0-3P
3	10.0 mm	50	59S/1.6-10-3P

1/4" Standard Screwdriver Bits for Phillips Head Screws 25 mm



59S/PH

X	+	+	+
10	0	1	59S/PH0
3	0	50	59S/PH0-3P
10	1	1	59S/PH1
3	1	1	59S/PH1-3P
30	1	1	59S/PH1-30P
100	*1	100	59S/PH1-IP
500	1	500	59S/PH1-IPB
10	2	1	59S/PH2
3	2	1	59S/PH2-3P
30	2	1	59S/PH2-30P
100	*2	100	59S/PH2-IP
500	*2	500	59S/PH2-IPB
10	3	1	59S/PH3
3	3	1	59S/PH3-3P
30	3	1	59S/PH3-30P
500	3	500	59S/PH3-IPB
10	4	1	59S/PH4
3	4	25	59S/PH4-3P

1/4" Standard Screwdriver Bits for Phillips Dry Wall Head Screws 25 mm



59S/PH2G

X	+	+	+
10	PH 2G	1	59S/PH2G
3	PH 2G	50	59S/PH2G-3P
30	PH2G	1	59S/PH2G-30P

1/4" Standard Screwdriver Bits for Pozidriv Head Screws 25 mm



59S/PZ

X	+		
10	0	1	59S/PZ0
3	0	50	59S/PZ0-3P
10	1	1	59S/PZ1
3	1	1	59S/PZ1-3P
30	1	1	59S/PZ1-30P
100	*1	100	59S/PZ1-IP
500	*1	500	59S/PZ1-IPB
10	2	1	59S/PZ2
3	2	1	59S/PZ2-3P
30	2	1	59S/PZ2-30P
100	*2	100	59S/PZ2-IP
500	*2	500	59S/PZ2-IPB
10	3	1	59S/PZ3
3	3	1	59S/PZ3-3P
30	3	1	59S/PZ3-30P
500	3	500	59S/PZ3-IPB
10	4	1	59S/PZ4

1/4" Standard Screwdriver Bits for TORX® Head Screws 25 mm



59S/T

X	T		
5	T3	1	59S/T3
3	T3	50	59S/T3-3P
5	T4	1	59S/T4
3	T4	50	59S/T4-3P
5	T5	1	59S/T5
3	T5	50	59S/T5-3P
10	T6	1	59S/T6
3	T6	50	59S/T6-3P
10	T7	1	59S/T7
3	T7	50	59S/T7-3P
10	T8	1	59S/T8
3	T8	50	59S/T8-3P
10	T9	1	59S/T9
3	T9	50	59S/T9-3P
10	T10	1	59S/T10
3	T10	1	59S/T10-3P
30	T10	1	59S/T10-30P
10	T15	1	59S/T15

X	T		
3	T15	1	59S/T15-3P
30	T15	1	59S/T15-30P
10	T20	1	59S/T20
3	T20	1	59S/T20-3P
30	T20	1	59S/T20-30P
10	T25	1	59S/T25
3	T25	1	59S/T25-3P
30	T25	1	59S/T25-30P
10	T27	1	59S/T27
3	T27	1	59S/T27-3P
5	T30	1	59S/T30
3	T30	1	59S/T30-3P
30	T30	1	59S/T30-30P
5	T40	1	59S/T40
3	T40	1	59S/T40-3P
30	T40	1	59S/T40-30P
5	T45	1	59S/T45
3	T45	50	59S/T45-3P
5	T50	1	59S/T50
3	T50	50	59S/T50-3P

1/4" Standard Screwdriver Conical Bits for Torx® Head Screws 25 mm



59S/TCS

X	T		
10	T10	20	59S/T10CS
10	T15	20	59S/T15CS
10	T20	20	59S/T20CS
10	T25	20	59S/T25CS
10	T27	20	59S/T27CS
10	T30	20	59S/T30CS
10	T40	20	59S/T40CS

1/4" Standard Screwdriver Bits for TORX® Tamper-Resistant Screws 25 mm



59S/TR

X	T		
5	TR7	1	59S/TR7
3	TR7	50	59S/TR7-3P

X	T		
5	TR8	1	59S/TR8
3	TR8	50	59S/TR8-3P
5	TR9	1	59S/TR9
3	TR9	50	59S/TR9-3P
5	TR10	1	59S/TR10
3	TR10	1	59S/TR10-3P
5	TR15	1	59S/TR15
3	TR15	1	59S/TR15-3P
5	TR20	1	59S/TR20
3	TR20	1	59S/TR20-3P
5	TR25	1	59S/TR25
3	TR25	1	59S/TR25-3P
5	TR27	1	59S/TR27
3	TR27	1	59S/TR27-3P
5	TR30	1	59S/TR30
3	TR30	1	59S/TR30-3P
5	TR40	1	59S/TR40
3	TR40	1	59S/TR40-3P

1/4" Standard Screwdriver Bits for Metric Hex Head Screws 25 mm



59S/H mm

X	H		
5	1.5	1	59S/H1.5
3	1.5	50	59S/H1.5-3P
5	2	1	59S/H2
3	2	50	59S/H2-3P
5	2.5	1	59S/H2.5
3	2.5	50	59S/H2.5-3P
5	3	1	59S/H3
3	3	1	59S/H3-3P
5	4	1	59S/H4
3	4	1	59S/H4-3P
500	4	500	59S/H4-IPB
5	5	1	59S/H5
3	5	1	59S/H5-3P
5	6	1	59S/H6
3	6	1	59S/H6-3P
5	8	1	59S/H8
3	8	1	59S/H8-3P
5	10	1	59S/H10
3	10	25	59S/H10-3P



1/4" Standard Screwdriver Bits for Imperial Hex Head Screws 25 mm



59S/H "

Quantity	Size	Part Number
5	1/16 in	1 59S/H1/16
3	1/16 in	50 59S/H1/16-3P
5	5/64 in	1 59S/H5/64
3	5/64 in	50 59S/H5/64-3P
5	3/32 in	1 59S/H3/32
3	3/32 in	50 59S/H3/32-3P
5	7/64 in	1 59S/H7/64
3	7/64 in	50 59S/H7/64-3P
5	1/8 in	1 59S/H1/8
3	1/8 in	50 59S/H1/8-3P
5	9/64 in	1 59S/H9/64
3	9/64 in	1 59S/H9/64-3P
5	5/32 in	1 59S/H5/32
3	5/32 in	50 59S/H5/32-3P
5	3/16 in	1 59S/H3/16
3	3/16 in	1 59S/H3/16-3P
5	7/32 in	1 59S/H7/32
3	7/32 in	50 59S/H7/32-3P
5	1/4 in	1 59S/H1/4
3	1/4 in	50 59S/H1/4-3P
5	5/16 in	1 59S/H5/16
3	5/16 in	50 59S/H5/16-3P
5	3/8 in	1 59S/H3/8
3	3/8 in	25 59S/H3/8-3P

1/4" Standard Screwdriver Bits for Robertson Head Screws 25 mm



59S/R

Quantity	Size	Part Number
10	#1	1 59S/R1
3	#1	1 59S/R1-3P
10	#2	1 59S/R2
3	#2	1 59S/R2-3P
10	#3	1 59S/R3
3	#3	1 59S/R3-3P
10	#4	1 59S/R4

1/4" Standard Screwdriver Bits for TORQ-SET Security Head Screws 25 mm - 5 Pcs/ Plastic Box



59S/TS

Quantity	Size	Part Number
5	0	1 59S/TS-0
5	1	1 59S/TS-1
5	2	1 59S/TS-2
5	3	1 59S/TS-3
5	4	1 59S/TS-4
5	5	1 59S/TS-5
5	6	1 59S/TS-6
5	8	1 59S/TS-8
5	10	1 59S/TS-10

1/4" Imperial Standard Screwdriver Bits for TORQ-SET® Head Screws 25 mm



59S/TS "

Quantity	Size	Part Number
5	1/4"	1 59S/TS-1/4

1/4" Standard Screwdriver Bits for Tri-Wing Head Screws 25 mm - 5 Pcs/Plastic Box



59S/TW

Quantity	Size	Part Number
5	TW 0	1 59S/TW0
5	TW 1	1 59S/TW1
5	TW 2	1 59S/TW2
5	TW 3	1 59S/TW3
5	TW 4	1 59S/TW4
5	TW 5	1 59S/TW5

1/4" Standard Screwdriver Bits for XZN Head Screws 25 mm



59S/M

Quantity	Size	Part Number
10	M3	1 59S/M3
3	M3	50 59S/M3-3P
10	M4	1 59S/M4
3	M4	50 59S/M4-3P
10	M5	1 59S/M5
3	M5	50 59S/M5-3P
10	M6	1 59S/M6
3	M6	50 59S/M6-3P
10	M8	1 59S/M8
3	M8	50 59S/M8-3P

1/4" Standard Screwdriver Bits for Slotted Head Screws 50 mm



59S/50

Quantity	Size	Part Number
5	3.5 mm	1 59S/50/0.6-3.5
5	4.0 mm	1 59S/50/0.8-4.0
5	5.5 mm	1 59S/50/0.8-5.5
5	6.0 mm	1 59S/50/1.0-6.0
5	6.5 mm	1 59S/50/1.2-6.5
2	3.5 mm	50 59S/50/3.5-2P
2	4.0 mm	50 59S/50/4.0-2P
2	5.5 mm	50 59S/50/5.5-2P
2	6.0 mm	1 59S/50/6.0-2P
2	6.5 mm	50 59S/50/6.5-2P

1/4" Standard Screwdriver Bits for Phillips Head Screws 50 mm



59S/50PH

Quantity	Size	Part Number
5	1	1 59S/50PH1
2	1	1 59S/50PH1-2P
5	2	1 59S/50PH2
2	2	1 59S/50PH2-2P
5	3	1 59S/50PH3
2	3	1 59S/50PH3-2P

1/4" Standard Screwdriver Bits for Pozidriv Head Screws 50 mm



59S/50PZ

X	+		
5	1	1	59S/50PZ1
2	1	1	59S/50PZ1-2P
5	2	1	59S/50PZ2
2	2	1	59S/50PZ2-2P
5	3	1	59S/50PZ3
2	3	1	59S/50PZ3-2P

1/4" Standard Screwdriver Bits for TORX® Head Screws 50 mm



59S/50T

X	*		
5	T 8	1	59S/50T8
2	T 8	50	59S/50T8-2P
5	T 10	1	59S/50T10
2	T10	1	59S/50T10-2P
5	T 15	1	59S/50T15
2	T15	1	59S/50T15-2P
5	T 20	1	59S/50T20
2	T20	1	59S/50T20-2P
5	T 25	1	59S/50T25
2	T25	1	59S/50T25-2P
5	T 27	1	59S/50T27
5	T 30	1	59S/50T30
2	T30	1	59S/50T30-2P
5	T 40	1	59S/50T40
2	T40	50	59S/50T40-2P

1/4" Standard Screwdriver Bits for Metric Hex Head Screws 50 mm



59S/50H

X	⊕		
5	2	1	59S/50H2
2	2	50	59S/50H2-2P
5	2.5	1	59S/50H2.5

X	⊕		
2	2.5	50	59S/50H2.5-2P
5	3	1	59S/50H3
2	3	50	59S/50H3-2P
5	4	1	59S/50H4
2	4	50	59S/50H4-2P
5	5	1	59S/50H5
2	5	50	59S/50H5-2P
5	6	1	59S/50H6
2	6	50	59S/50H6-2P
5	8	1	59S/50H8
2	8	50	59S/50H8-2P

1/4" Standard Screwdriver Bits for Imperial Hex Head Screws 50 mm



59S/50H "

X	⊕		
5	1/1 in	1	59S/50H1/16
5	5/64 in	1	59S/50H5/64
5	3/32 in	1	59S/50H3/32
5	7/64 in	1	59S/50H7/64
5	1/8 in	1	59S/50H1/8
5	9/64 in	1	59S/50H9/64
5	5/32 in	1	59S/50H5/32
5	3/16 in	1	59S/50H3/16
5	7/32 in	1	59S/50H7/32
5	1/4 in	1	59S/50H1/4
5	5/16 in	1	59S/50H5/16
5	3/8 in	1	59S/50H3/8

1/4" Standard Screwdriver Bits for Robertson Head Screws 50 mm



59S/50R

X	⊕		
5	#1	1	59S/50R1
2	#1	50	59S/50R1-2P
5	#2	1	59S/50R2
2	#2	50	59S/50R2-2P
5	#3	1	59S/50R3
2	#3	50	59S/50R3-2P

1/4" Standard Screwdriver Bits for Phillips Head Screws 70 mm



59S/70PH

X	+		
5	1	1	59S/70PH1
2	1	1	59S/70PH1-2P
5	2	1	59S/70PH2
2	2	25	59S/70PH2-2P

1/4" Standard Screwdriver Bits for Pozidriv Head Screws 70 mm



59S/70PZ

X	+		
5	1	1	59S/70PZ1
2	1	1	59S/70PZ1-2P
5	2	1	59S/70PZ2
2	2	1	59S/70PZ2-2P
5	3	1	59S/70PZ3
2	3	1	59S/70PZ3-2P

1/4" Standard Screwdriver Bits for TORX® Head Screws 70 mm



59S/70T

X	*		
5	T10	1	59S/70T10
2	T10	1	59S/70T10-2P
5	T15	1	59S/70T15
2	T15	25	59S/70T15-2P
2	T20	1	59S/70T20-2P
5	T20	1	59S/70T20
2	T25	25	59S/70T25-2P
5	T25	1	59S/70T25
2	T27	1	59S/70T27-2P
5	T27	1	59S/70T27
2	T30	1	59S/70T30-2P
5	T30	1	59S/70T30
2	T40	1	59S/70T40-2P
5	T40	1	59S/70T40



1/4" Standard Screwdriver Bits for TORX®
Tamper-Resistant Screws 70 mm



59S/70TR

5	TR15	1	59S/70TR15
2	TR15	1	59S/70TR15-2P
5	TR20	1	59S/70TR20
2	TR20	25	59S/70TR20-2P
5	TR25	1	59S/70TR25
2	TR25	25	59S/70TR25-2P
5	TR27	1	59S/70TR27
2	TR27	25	59S/70TR27-2P
5	TR30	1	59S/70TR30
2	TR30	25	59S/70TR30-2P
5	TR40	1	59S/70TR40
2	TR40	25	59S/70TR40-2P

1/4" Standard Screwdriver Bits for Hex
with Ball Point Screws 89 mm



59S/H BALL

5	3	1	59S/H3BALL
2	3	1	59S/H3BALL-2P
5	4	1	59S/H4BALL
2	4	1	59S/H4BALL-2P
5	5	1	59S/H5BALL
2	5	1	59S/H5BALL-2P
5	6	1	59S/H6BALL
2	6	1	59S/H6BALL-2P
5	8	1	59S/H8BALL
2	8	1	59S/H8BALL-2P
3	5,6,8	1	59S/HBALL-3P

1/4" Standard Screwdriver Bits for Phillips
Head Screws 125 mm



59S/125PH

5	1	1	59S/125PH1
2	1	25	59S/125PH1-2P
5	2	1	59S/125PH2
2	2	25	59S/125PH2-2P
100	2	100	59S/125PH2-1P
2	3	25	59S/125PH3-2P
5	3	1	59S/125PH3

1/4" Standard Screwdriver Bits for Pozidriv
Head Screws 125 mm



59S/125PZ

5	1	1	59S/125PZ1
2	1	25	59S/125PZ1-2P
5	2	1	59S/125PZ2
2	2	25	59S/125PZ2-2P
5	3	1	59S/125PZ3
2	3	25	59S/125PZ3-2P

1/4" Standard Screwdriver Bits for Plus-
Minus/Phillips Head Screws 125 mm



59S/PH COMBI

2	5.0/PH1	1	59S/PH1COMBI-2P
2	6.0/PH2	1	59S/PH2COMBI-2P
2	8.0/PH3	1	59S/PH3COMBI-2P

1/4" Standard Screwdriver Bits for TORX®
Head Screws 150 mm



59S/150T

5	T15	1	59S/150T15
2	T15	1	59S/150T15-2P
5	T20	1	59S/150T20
2	T20	1	59S/150T20-2P
5	T25	1	59S/150T25
2	T25	1	59S/150T25-2P
5	T30	1	59S/150T30
2	T30	1	59S/150T30-2P

7/16" Screwdriver Bits for Hex Head
Screws 35 mm



74S/H

5	4 mm	1	74S/H4
2	4 mm	25	74S/H4-2P
5	5 mm	1	74S/H5
2	5 mm	25	74S/H5-2P
5	6 mm	1	74S/H6
2	6 mm	25	74S/H6-2P
5	7 mm	1	74S/H7
2	7 mm	25	74S/H7-2P
5	8 mm	1	74S/H8
2	8 mm	25	74S/H8-2P
5	10 mm	1	74S/H10
2	10 mm	25	74S/H10-2P
5	12 mm	1	74S/H12
2	12 mm	25	74S/H12-2P
5	14 mm	1	74S/H14
2	14 mm	1	74S/H14-2P
5	17 mm	1	74S/H17
2	17 mm	25	74S/H17-2P

5/32" Standard Screwdriver Bits for Phillips Head Screws 25 mm



45S/PH

5	1	1	45S/PH1
2	1	50	45S/PH1-2P
5	2	1	45S/PH2
2	2	50	45S/PH2-2P

5/32" Standard Screwdriver Bits for Hex Head Screws 25 mm



45S/H

5	1.5 mm	1	45S/H1.5
2	1.5 mm	50	45S/H1.5-2P
5	2 mm	1	45S/H2
2	2 mm	50	45S/H2-2P
5	2.5 mm	1	45S/H2.5
2	2.5 mm	50	45S/H2.5-2P
5	3 mm	1	45S/H3
2	3 mm	50	45S/H3-2P

1/4" Bit Set for Phillips/Pozidriv/TORX® Head Screws - 7 Pcs



59S/7-1

7	22 x 65 x 75 mm	1	59S/7-1

includes a bit holder of 50mm

59S/PH1, 59S/PH2		
59S/PZ1, 59S/PZ2		
59S/T15, 59S/T20		

1/4" Bit Set for Phillips/TORX® Head Screws - 7 Pcs



59S/7-2

7	22 x 65 x 75 mm	1	59S/7-2

includes a bit holder of 50mm

59S/PH2		
59S/T15x 2, 59S/T20x 2, 59S/T25		

1/4" Bit Set for TORX® Tamper Resistant Screws - 7 Pcs



59S/7-3

7	22 x 65 x 75 mm	1	59S/7-3

includes a bit holder of 50mm

59S/TR10, 59S/TR15, 59S/TR20, 59S/TR25, 59S/TR30, 59S/TR40		
--	--	--

1/4" Bit Set for TORX® Head Screws - 7 Pcs



59S/7-4

7	22 x 65 x 75 mm	1	59S/7-4

59S/T10, 59S/T15, 59S/T20, 59S/T25, 59S/T30, 59S/T40		
--	--	--

1/4" Bit Set for Phillips/Pozidriv/Torx® Head Screws in a Plastic Holder with Belt Clip - 10 pcs



59S/10BC

10	23 x 68 x 168 mm	1	59S/10BC

1/4" Conical Bit Set for Torx® Head Screws - 11 pcs



59S/TCS11-1

11	108 x 68 x 31 mm	10	59S/TCS11-1

59S/T10CS, 59S/T15CS, 59S/T20CSx 3, 59S/T25CSx 2, 59S/T30CSx 2, 59S/T40CS		
KM653-QR-1P		

1/4" Bit Set for Slotted/Phillips/Pozidriv/Hex Head Screws - 17 Pcs



59S/17-1

17	27 x 73 x 82 mm	1	59S/17-1

includes a bit holder of 50mm

59S/0.5-3.0, 59S/0.6-4.5, 59S/0.8-5.5		
59S/PH1, 59S/PH2x 3		
59S/PH2Gx 2		
59S/PZ1, 59S/PZ2x 2		
59S/H3, 59S/H4, 59S/H5, 59S/H6		



1/4" Bit Set for TORX® Head Screws - 17 Pcs



59S/17-2

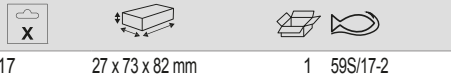

17 27 x 73 x 82 mm 1 59S/17-2

includes a bit holder of 50mm

59S/T7, 59S/T8, 59S/T9, 59S/T10, 59S/T15x 2, 59S/T20x 3, 59S/T25x 3, 59S/T27, 59S/T30x 2, 59S/T40

1/4" Bit Set for Phillips/ Pozidriv/TORX®/ Hex Head Screws - 17 Pcs



59S/17-3

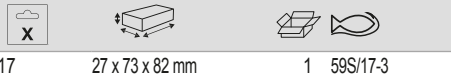

17 27 x 73 x 82 mm 1 59S/17-3

includes a bit holder of 50mm

59S/PH1, 59S/PH2x 2
59S/PZ1, 59S/PZ2, 59S/PZ3
59S/T10, 59S/T15, 59S/T20, 59S/T25, 59S/T27, 59S/T30, 59S/T40
59S/H3, 59S/H4, 59S/H5

1/4" bit set for Slotted/Phillips/Pozidriv/ TORX® Head Screw - 22 Pcs



59S/22-1

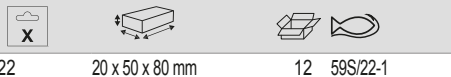

22 20 x 50 x 80 mm 12 59S/22-1

includes a bit holder of 50mm

59S/0.5-3.0, 59S/0.6-4.5, 59S/0.8-5.5		
59S/PH1, 59S/PH2, 59S/PH3		
59S/PH2G		
59S/PZ1, 59S/PZ2, 59S/PZ3		
59S/T6, 59S/T8, 59S/T9, 59S/T10, 59S/T15, 59S/T20, 59S/T25, 59S/T27, 59S/T30, 59S/T40		
K6650-1/4		

1/4" bit set for Phillips/ Hex/ TORX® Head Screw - 22 Pcs



59S/22-2



22 20 x 50 x 80 mm 12 59S/22-2

includes a bit holder of 50mm

59S/PH2x 3		
59S/PH2Gx 3		
59S/PZ2x 2		
59S/T10, 59S/T15x 4, 59S/T20x 3, 59S/T25x 2		
59S/H2.5, 59S/H3		
K6650-1/4		

1/4" Bit set for Slotted/ Phillips/ TORX®/ Hex/ TORQ-SET head screw - 28 Pcs



59S/28



28 30 x 58 x 110 mm 1 59S/28-4

59S/0.6-4.5, 59S/1.2-6.5, 59S/1.2-8.0		
59S/PH1x 2, 59S/PH2x 2, 59S/PH3		
59S/T6, 59S/T15		
59S/H5/64, 59S/H3/32, 59S/H7/64, 59S/H1/8, 59S/H9/64, 59S/H5/32, 59S/H3/16, 59S/H7/32		
59S/TS-4x 2, 59S/TS-6x 2, 59S/TS-8x 2, 59S/TS-10x 2		
K6625-1/4		
KM653		

1/4" Bit Set for Slotted/Phillips/Pozidriv/ TORX®/Hex Head Screw - 31 Pcs



59S/31B

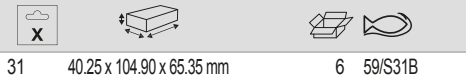

31 40.25 x 104.90 x 65.35 mm 6 59S/31B

59S/0.6-4.5, 59S/1.0-5.5		
59S/PH1, 59S/PH2x 3, 59S/PH3		
59S/PH2Gx 2		
59S/PZ1, 59S/PZ2x 3, 59S/PZ3		
59S/T10, 59S/T15x 3, 59S/T20x 3, 59S/T25x 2, 59S/T27, 59S/T30		
59S/H3, 59S/H4, 59S/H5, 59S/H6		
K6625-1/4-1P		
KM653-QR-1P		

1/4" Bit Set for Slotted/Phillips/Pozidriv/ TORX®/Hex Head Screw - 31 Pcs/12 Pcs Carton Display



59S/31B-IP



280 x 375 x 210 mm 12 59S/31B-IP

Order 12 pieces of the ref. 59S/31B-IP to receive 1 display

1/4" bit set for Slotted/ Phillips/ Pozidriv/ Hex/ TORX® screw - 31 Pcs



59S/31-1

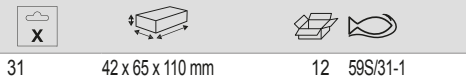

31 42 x 65 x 110 mm 12 59S/31-1

59S/0.5-3.0, 59S/0.6-4.5, 59S/0.8-5.5		
59S/PH1, 59S/PH2x 3, 59S/PH3		
59S/PH2Gx 2		
59S/PZ1, 59S/PZ2x 3, 59S/PZ3		
59S/T10, 59S/T15x 3, 59S/T20x 3, 59S/T25x 2, 59S/T27, 59S/T30		
59S/H3, 59S/H4, 59S/H5, 59S/H6		
KM653-QR		

1/4" Bit Set for Phillips/Pozidriv/TORX® Screws - 31 Pcs



59S/31-2			
31	42 x 65 x 110 mm	1	59S/31-2

Includes a bit holder of 50mm

59S/PH2x 4		
59S/PH2Gx 4		
59S/PZ2x 4		
59S/T10x 2, 59S/T15x 4, 59S/T20x 5, 59S/T25x 5, 59S/T30x 2		
KM653-QR		

1/4" Bit Set for Phillips/Pozidriv/TORX® Tamper Resistant Screws - 31 Pcs



59S/31-3			
31	42 x 65 x 110 mm	12	59S/31-3

59S/PH1x 2, 59S/PH2x 2, 59S/PH3		
59S/PZ1x 2, 59S/PZ2x 2, 59S/PZ3		
59S/TR10x 2, 59S/TR15x 3, 59S/TR20x 5, 59S/TR25x 4, 59S/TR27, 59S/TR30x 4, 59S/TR40		
KM653-QR		

1/4" bit set for Phillips/ Pozidriv/ Hex/ TORX® head screw - 35 Pcs



59/S35BC			
35	50 x 110 x 180 mm	1	59/S35BC

1/4" Bit Set for Slotted/Phillips/Pozidriv/ Hex/TORX®/TORX® Tamper/Robertson Screw - 54 Pcs



59/S54BC			
54	50 x 110 x 184 mm	10	59/S54BC

TORX bits are colored to easy identify the size of the tipSocket adaptor 1/4"

1/4" Bit Set for Slotted/Phillips/Pozidriv/ Hex/TORX®/TORX® Tamper/Robertson Screw - 54 Pcs/8 Pcs Carton Display



59/S54BC-IP			
54	300 x 190 x 280 mm	8	59/S54BC-IP

Order 8 pieces of the re. 59/S54BC-IP to receive 1 display TORX bits are colored to easy identify the size of the tip

1/4" Bit Set for Slotted/Phillips/Pozidriv/ Hex/ TORX®/TORX® Tamper/Robertson Screw - 100 Pcs



59/S100BC			
100	50 x 110 x 184 mm	1	59/S100BC

TORX bits are coloredMagnetic universal bit holder KM653

1/4" Bit Set for Slotted/Phillips/Pozidriv/ Hex/ TORX®/TORX® Tamper/Robertson Screw - 100 Pcs/8 Pcs Carton Display



59/S100BC-IP			
100	300 x 190 x 280 mm	8	59/S100BC-IP

Order 8 pieces of the re. 59/S100BC-IP to receive 1 display TORX bits are colored to easy identify the size of the tipMagnetic universal bit holder KM653



1/4" Standard Bit and Socket Set for Slotted/Phillips/Pozidriv/TORX®/Hex Head Screw - 26 Pcs



2058/S26

26	80 x 100 x 35 mm	30	2058/S26
26	35 x 85 x 105 mm	1	SB-2058/S26

SB: Retail pack on a plastic info card

2058-BR	
K6625-1/4-1P	
59S/H6, 59S/H5, 59S/H4, 59S/H3	
59S/T15, 59S/T10, 59S/T30, 59S/T25, 59S/T20	
59S/PZ3, 59S/PZ1, 59S/PZ2	
59S/PH1, 59S/PH2, 59S/PH3	
59S/0.8-5.5, 59S/0.5-4.0	
6700SM-8, 6700SM-7, 6700SM-6, 6700SM-13, 6700SM-10	
KM753-QR-1P	

1/4" Small Bit and Socket Set for Slotted/Phillips/Pozidriv/TORX®/Hex Head Screw - 26 Pcs



2058/S26-2

80 x 100 x 35 mm	1	2058/S26-2

2058-BR	
6700SM-8, 6700SM-7, 6700SM-6, 6700SM-5, 6700SM-4	
KM753-QR-1P	
K6625-1/4	
59S/0.5-3.0, 59S/0.8-5.5, 59S/0.5-4.0	
59S/T8, 59S/T7, 59S/T6, 59S/T5, 59S/T4	
59S/PZ1, 59S/PZ0, 59S/PZ2	
59S/H2, 59S/H2.5, 59S/H1.5, 59S/H3	
59S/PH1, 59S/PH0, 59S/PH2	

1/4" Standard Screwdriver Bit Set for PH2 Head Screws 25 mm - 5 Pcs



59S/PH2PEN

5	13 x 17 x 132 mm	10	59S/PH2PEN

1/4" Standard Screwdriver Bit Set for PZ2 Head Screws 25 mm - 5 Pcs



59S/PZ2PEN

5	13 x 17 x 132 mm	10	59S/PZ2PEN

1/4" Standard Screwdriver Bit Set for Torx® Tamper-Resistant Screws 25 mm - 5 Pcs



59S/TORXPEN

5	13 x 17 x 132 mm	10	59S/T15PEN
5	13 x 17 x 132 mm	10	59S/T20PEN
5	13 x 17 x 132 mm	10	59S/T25PEN

1/4" Bit Pocket Set for Phillips/Pozidriv/Torx® Head Screws - 60 Pcs/Counter Display



59S/60PEN/DISP

60	140 x 125 x 215 mm	1	59S/60PEN/DISP

59S/T15PENx 5, 59S/T20PENx 30, 59S/T25PENx 5	
59S/PH2PENx 10	
59S/PZ2PENx 10	

5/16" Screwdriver Bits for Slotted Head Screws 41 mm



70S/PH

5	8.0 mm	1	70S/1.2-8.0
2	8.0 mm	25	70S/1.2-8.0-2P
5	9.0 mm	1	70S/1.6-9.0
2	9.0 mm	25	70S/1.6-9.0-2P
5	10.0 mm	1	70S/1.6-10.0
2	10.0 mm	25	70S/1.6-10.0-2P
5	12.0 mm	1	70S/2.0-12.0
2	12.0 mm	25	70S/2.0-12.0-2P
5	14.0 mm	1	70S/2.5-14.0
2	14.0 mm	25	70S/2.5-14.0-2P

5/16" Screwdriver Bits for Phillips Head Screws 32 mm-38 mm



70S/PH

5	1	1	70S/PH1
2	1	25	70S/PH1-2P
5	2	1	70S/PH2
2	2	25	70S/PH2-2P
5	3	1	70S/PH3
2	3	25	70S/PH3-2P
5	4	1	70S/PH4
2	4	25	70S/PH4-2P

5/16" Screwdriver Bits for Pozidriv Head Screws 32 mm-38 mm



70S/PZ

5	1	1	70S/PZ1
2	1	25	70S/PZ1-2P
5	2	1	70S/PZ2
2	2	25	70S/PZ2-2P
5	3	1	70S/PZ3
2	3	25	70S/PZ3-2P
5	4	1	70S/PZ4
2	4	25	70S/PZ4-2P

5/16" Screwdriver Bits for TORX® Head Screws 35 mm



70S/T

5	T20	1	70S/T20
2	T20	25	70S/T20-2P
5	T25	1	70S/T25
2	T25	25	70S/T25-2P
5	T27	1	70S/T27
2	T27	1	70S/T27-2P
5	T30	1	70S/T30
2	T30	25	70S/T30-2P
5	T40	1	70S/T40
2	T40	25	70S/T40-2P
5	T45	1	70S/T45
2	T45	25	70S/T45-2P
5	T50	1	70S/T50
2	T50	25	70S/T50-2P
5	T55	1	70S/T55
2	T55	25	70S/T55-2P

5/16" Screwdriver Bits for TORQ-SET® Head Screws 32 mm



70S/TS

5	8 mm	1	70S/TS8
2	8 mm	25	70S/TS8-2P
5	10 mm	1	70S/TS10
2	10 mm	25	70S/TS10-2P

5/16" Imperial Screwdriver Bits for TORQ-SET® Head Screws 32 mm



70S/TS"

5	1/4"	1	70S/TS1/4
2	1/4"	25	70S/TS1/4-2P
5	5/16"	1	70S/TS5/16
2	5/16"	25	70S/TS5/16-2P

5/16" Screwdriver Bits for Hex Socket Head Screws 30 mm



70S/H

5	4 mm	1	70S/H4
2	4 mm	25	70S/H4-2P
5	5 mm	1	70S/H5
2	5 mm	25	70S/H5-2P
5	6 mm	1	70S/H6
2	6 mm	25	70S/H6-2P

5	7 mm	1	70S/H7
2	7 mm	25	70S/H7-2P
5	8 mm	1	70S/H8
2	8 mm	25	70S/H8-2P
5	10 mm	1	70S/H10
2	10 mm	25	70S/H10-2P
5	12 mm	1	70S/H12
2	12 mm	25	70S/H12-2P
5	14 mm	1	70S/H14
2	14 mm	25	70S/H14-2P

5/16" Hand Operated Impact Driver with 1/2" Square Drive 125 mm



5521

125 mm	1	5521

1/2" Square screwdriver adaptor for bits 5/16"



54640

40 mm	1	54640



5/16" Bit Set for Slotted/ Phillips/Hex/
TORX® Head Screws - 23 Pcs



7823

23	45 x 70 x 197 mm	16	7823

5521

54640

70S/1.2-8.0, 70S/1.6-10.0, 70S/2.0-12.0

70S/PH2, 70S/PH3, 70S/PH4

70S/T20, 70S/T25, 70S/T27, 70S/T30,
70S/T40, 70S/T45, 70S/T50, 70S/T55

70S/H4, 70S/H5, 70S/H6, 70S/H7,
70S/H8, 70S/H10, 70S/H12, 70S/H14

5/16" Bit Set for Slotted/Phillips/Hex Head
Screws - 14 Pcs



7865

15	55 x 90 x 220 mm	1	7865

Including 1 adaptor, hexagon 5/16" to 3/8" square drive/Included 1 Adaptor (hexagon 5/16" to 3/8" square drive) and 2 slotted bits (5, 6 mm) also included in the set

5521

54640

70S/1.2-8.0, 70S/1.6-10.0

70S/PH1, 70S/PH2, 70S/PH3, 70S/PH4

70S/H4, 70S/H5, 70S/H6, 70S/H8

Threaded Screwdriver Bits for Phillips
Head Screws



K18

1	2	5	K18NF-2
1	2	5	K18PH-2M5
1	2	5	K18PH-2M6

Threaded Screwdriver Bits for Pozidriv
Head Screws



K19PZD-2NF

1	2	1	K19PZD-2NF
1	2	1	K19PZD-2M5

Threaded Screwdriver Bits for TORX®
Head Screws 44.5 mm



K20TORX

1	T25	10	K20TORX-T25

1/4" Hex Head Non-Magnetic Power Nut
Drivers



K6750

1	1/4 in	1	K6750-6
1	1/4 in	1	K6750-7
1	1/4 in	1	K6750-8
1	1/4 in	1	K6750-10
1	1/4 in	1	K6750-13
1	1/4 in	1	K6750-1/4
1	1/4 in	1	K6750-3/8

1/4" Hex Head Magnetic Power Nut
Drivers



KM6750

1		1	KM6750-6
1		1	KM6750-7
1		1	KM6750-8
1		20	KM6750-10
1		1	KM6750-11
1		1	KM6750-13
1		1	KM6750-1/4
1		1	KM6750-3/8

1/4" Hex Universal Magnetic Bit Holders
with Quick Release 60 mm



KM653-QR

5	1/4"	1	KM653-QR
1	1/4"	50	KM653-QR-1P

1/4" Hex Universal Magnetic Bit Holders with Quick Release 75 mm



KM753-QR

1	1/4 in	1	KM753-QR-1P

1/4" Hex Universal Magnetic Bit Holders 60 mm



KM653

1	1/4"	25	KM653-1P
5	1/4"	1	KM653

1/4" Hex Universal Magnetic Bit Holders with Retaining Ring 60 mm



KMR653

1	1/4 in	1	KMR653-1P
5	1/4 in	1	KMR653

1/4" Hex Magnetic Screw Holding Universal bit holder 82 mm



KM100-SH

1	1/4"	1	KM100-SH

1/4" Heavy-Duty Torsion Screwdriver Bit Holders



KMT753-QR-1P

1/4 in	1/4 in	50	KMT753-QR-1P		

1/4" Hex Universal Magnetic Bit Holders with Retaining Ring 75 mm



KMR753

1	1/4 in	1	KMR753-1P
5	1/4 in	1	KMR753

1/4" Hex Universal Bit Holders with Retaining Ring 60 mm



KR653

1	1/4 in	25	KR653-1P
5	1/4 in	1	KR653

1/4" Hex Universal magnetic bit holder with Swivel Function 65 mm



KM653-SF

1	1/4" in	1	KM653-SF

1/4" Hex Copper-Beryllium Universal bit holder with Retaining Ring 75 mm



KCB753

1	1/4 in	1	KCB753



1/4" Hex Universal Magnetic Bit Holders with Retaining Ring 150 mm



KMR150

1	1/4 in	1	KMR150-1P
5	1/4 in	1	KMR150

1/4" Hex drive Universal Magnetic Bit Holder for 5/16" bits 70 mm



KM1/4-5/16-1P

1	1/4 in	50	KM1/4-5/16-1P

1/4" Hex Drive to 1/4" Socket adaptors 25 mm



K6625

1	1/4 in	1	K6625-1/4-1P
5	1/4 in	1	K6625-1/4

1/4" Hex Drive to 3/8" Socket Adaptors 38 mm



K6638

1	1/4 in	25	K6638-3/8-1P
5	1/4 in	1	K6638-3/8

1/4" Hex Drive to 1/4", 3/8", 1/2" Socket Adaptors 50 mm



K6650

1	1/4 in	1	K6650-1/4-1P
5	1/4 in	1	K6650-1/4
1	1/4 in	1	K6650-3/8-1P
5	1/4 in	1	K6650-3/8
1	1/4 in	1	K6650-1/2-1P
5	1/4 in	1	K6650-1/2

1/4" Hex Drive to 1/4", 3/8" Socket Adaptors 100 mm



K66100

1	1/4 in	25	K66100-1/4-1P
5	1/4 in	1	K66100-1/4
1	1/4 in	25	K66100-3/8-1P
5	1/4 in	1	K66100-3/8

1/4" Hex Drive to 1/4" Socket Adaptor with Quick Release 60 mm



K6660-QR

1	1/4 in	1	K6660-QR-1P

IMPACT TOOLS

1/4" Square Drive Impact Sockets with Metric Hex Profile and Phosphate Finish



K6701M



6 mm	1	K6701M-6
7 mm	1	K6701M-7
8 mm	1	K6701M-8
9 mm	1	K6701M-9
10 mm	1	K6701M-10
11 mm	1	K6701M-11
12 mm	1	K6701M-12
13 mm	1	K6701M-13
14 mm	1	K6701M-14

1/4" Square Drive Impact Sockets with Metric Hex Profile and Phosphate Finish - Retail Pack



SBK6701M



6 mm	1	SBK6701M-6
7 mm	1	SBK6701M-7
8 mm	1	SBK6701M-8

	 
9 mm	1 SBK6701M-9
10 mm	1 SBK6701M-10
11 mm	1 SBK6701M-11
12 mm	1 SBK6701M-12
13 mm	1 SBK6701M-13
14 mm	1 SBK6701M-14

3/8" Square Drive Impact Sockets with Metric Hex Profile and Phosphate Finish





K7401M

	 
7 mm	1 K7401M-7
8 mm	1 K7401M-8
9 mm	1 K7401M-9
10 mm	1 K7401M-10
11 mm	1 K7401M-11
12 mm	1 K7401M-12
13 mm	1 K7401M-13
14 mm	1 K7401M-14
15 mm	1 K7401M-15
16 mm	1 K7401M-16
17 mm	1 K7401M-17
18 mm	1 K7401M-18
19 mm	1 K7401M-19
20 mm	1 K7401M-20
21 mm	1 K7401M-21
22 mm	1 K7401M-22
24 mm	1 K7401M-24

3/8" Square Drive Deep Impact Sockets with Metric Hex Profile and Phosphate Finish



K7406M

	 
10 mm	1 K7406M-10
13 mm	1 K7406M-13
17 mm	1 K7406M-17

1/4" Square Drive Magnetic Impact Sockets with Metric Hex Profile and Phosphate Finish



KM6701M

	 
7 mm	1 KM6701M-7
8 mm	1 KM6701M-8
10 mm	1 KM6701M-10

3/8" Square Drive Impact Sockets with Imperial Hex Profile







K7401Z

	 
3/8 in	1 K7401Z-3/8
7/16 in	1 K7401Z-7/16
1/2 in	1 K7401Z-1/2
9/16 in	1 K7401Z-9/16
5/8 in	1 K7401Z-5/8
11/16 in	1 K7401Z-11/16
3/4 in	1 K7401Z-3/4
13/16 in	1 K7401Z-13/16
7/8 in	1 K7401Z-7/8

Safety Clamping Springs for 1/4" Impact Socket





K560F-1

		 
1/4 in	6-14 mm	5 K560F-1

3/8" Square Drive Impact Sockets with Metric Hex Profile and Phosphate Finish - Retail Pack





SBK7401M

	 
7 mm	1 SBK7401M-7
8 mm	1 SBK7401M-8
9 mm	1 SBK7401M-9
10 mm	1 SBK7401M-10
11 mm	1 SBK7401M-11
12 mm	1 SBK7401M-12
13 mm	1 SBK7401M-13
14 mm	1 SBK7401M-14
15 mm	1 SBK7401M-15
16 mm	1 SBK7401M-16
17 mm	1 SBK7401M-17
18 mm	1 SBK7401M-18
19 mm	1 SBK7401M-19
20 mm	1 SBK7401M-20
21 mm	1 SBK7401M-21
22 mm	1 SBK7401M-22
24 mm	1 SBK7401M-24

3/8" Square Drive to 1/4" Bit Holder Power Adaptors



K172

	 
1/4"	1 K172



3/8" Square Drive Bit Holder Adaptors with Phosphate Finish



7407H-7409H

1/4"	3/8"	1	7407H
5/16"	3/8"	1	7408H
11	3/8"	1	7409H



3/8 in	1	KS7401M-16
3/8 in	1	KS7401M-17
3/8 in	1	KS7401M-18
3/8 in	1	KS7401M-19
3/8 in	1	KS7401M-22

3/8" Square Drive Ball Joint Sockets with Phosphate Finish



K7767S

3/8"	3/8"	1	K7767S
3/8"	3/8"	1	K7767S

3/8" Square Drive Adaptors with Phosphate Finish



K6964C

1/4"	3/8"	1	K6964C
1/4"	3/8"	1	K6964C

3/8" Square Drive Impact Sockets with TORX® Head Profile and Phosphate Finish



K7401TORX-E

E5	M4	1	K7401TORX-E5
E6	M5	1	K7401TORX-E6
E7	M6	1	K7401TORX-E7
E8	M6, M7	1	K7401TORX-E8
E10	M6, M8	1	K7401TORX-E10
E12	M8, M10	1	K7401TORX-E12
E14	M10, M12	1	K7401TORX-E14



3/8" Square Drive Extensions with Phosphate Finish



K7760C

75 mm	1	K7760C-1
150 mm	1	K7760C-2

Safety Clamping Springs for 3/8" Impact Socket



K560F-2/3

3/8"	7-12	5	K560F-2
3/8"	13-24	5	K560F-3

3/8" Square Drive Impact Power Swivel Sockets with Metric Hex Profile



KS7401M

3/8 in	1	KS7401M-9
3/8 in	1	KS7401M-10
3/8 in	1	KS7401M-11
3/8 in	1	KS7401M-12
3/8 in	1	KS7401M-13
3/8 in	1	KS7401M-14
3/8 in	1	KS7401M-15

3/8" Square Drive Adaptors with Phosphate Finish



K8164C

1/2"	3/8"	1	K8164C
1/2"	3/8"	1	K8164C

Impact Hexagon Sockets Set with Metric Hex Profile -10 Pcs



K7401M/10

10	1	K7401M/10
10	1	K7401M/10

K7401M-10, K7401M-11, K7401M-12, K7401M-13, K7401M-14, K7401M-15, K7401M-16, K7401M-17, K7401M-18, K7401M-19

3/8" Square Drive Impact Socket Set with TORX® Head Profile and Phosphate Finish - 7 Pcs



K7401TORX-E-S7



7 1 K7401TORX-E-S7

K7401TORX-E5, K7401TORX-E6, K7401TORX-E7, K7401TORX-E8, K7401TORX-E10, K7401TORX-E12, K7401TORX-E14



1/2" Square Drive Ultrashort Impact Sockets with Metric Hex Profile and Phosphate Finish



K7800M



10 mm	1	K7800M-10
11 mm	1	K7800M-11
12 mm	1	K7800M-12
13 mm	1	K7800M-13
14 mm	1	K7800M-14
15 mm	1	K7800M-15
16 mm	1	K7800M-16
17 mm	1	K7800M-17
18 mm	1	K7800M-18
19 mm	1	K7800M-19
21 mm	1	K7800M-21
22 mm	1	K7800M-22
24 mm	1	K7800M-24

1/2" Square Drive Impact Sockets with Metric Hex Profile and Phosphate Finish



K7801M



8 mm	1	K7801M-8
9 mm	1	K7801M-9
10 mm	1	K7801M-10
11 mm	1	K7801M-11
12 mm	1	K7801M-12
13 mm	1	K7801M-13
14 mm	1	K7801M-14
15 mm	1	K7801M-15
16 mm	1	K7801M-16
17 mm	1	K7801M-17
18 mm	1	K7801M-18
19 mm	1	K7801M-19
20 mm	1	K7801M-20
21 mm	1	K7801M-21
22 mm	1	K7801M-22
23 mm	1	K7801M-23
24 mm	1	K7801M-24
25 mm	1	K7801M-25
26 mm	1	K7801M-26
27 mm	1	K7801M-27
28 mm	1	K7801M-28
29 mm	1	K7801M-29
30 mm	1	K7801M-30
32 mm	15	K7801M-32
34 mm	1	K7801M-34
36 mm	1	K7801M-36

1/2" Square Drive Impact Sockets with Metric Hex Profile and Phosphate Finish - Retail Pack



SBK7801M



8 mm	1	SBK7801M-8
9 mm	1	SBK7801M-9
10 mm	1	SBK7801M-10
11 mm	1	SBK7801M-11



12 mm	1	SBK7801M-12
13 mm	1	SBK7801M-13
14 mm	1	SBK7801M-14
15 mm	1	SBK7801M-15
16 mm	1	SBK7801M-16
17 mm	1	SBK7801M-17
18 mm	1	SBK7801M-18
19 mm	1	SBK7801M-19
20 mm	1	SBK7801M-20
21 mm	1	SBK7801M-21
22 mm	1	SBK7801M-22
23 mm	1	SBK7801M-23
24 mm	1	SBK7801M-24
25 mm	1	SBK7801M-25
26 mm	1	SBK7801M-26
27 mm	1	SBK7801M-27
28 mm	1	SBK7801M-28
29 mm	1	SBK7801M-29
30 mm	1	SBK7801M-30
32 mm	1	SBK7801M-32
34 mm	1	SBK7801M-34
36 mm	1	SBK7801M-36

1/2" Square Drive Deep Impact Sockets with Metric Hex Profile and Phosphate Finish



K7806M



10 mm	1	K7806M-10
11 mm	1	K7806M-11
12 mm	1	K7806M-12
13 mm	1	K7806M-13
14 mm	1	K7806M-14
15 mm	1	K7806M-15
16 mm	1	K7806M-16
17 mm	1	K7806M-17
18 mm	1	K7806M-18
19 mm	1	K7806M-19
21 mm	1	K7806M-21
22 mm	1	K7806M-22
23 mm	1	K7806M-23
24 mm	1	K7806M-24
27 mm	1	K7806M-27
30 mm	1	K7806M-30
32 mm	1	K7806M-32
36 mm	1	K7806M-36

SB: Retail pack on a plastic info card



1/2" Square Drive Deep Impact Sockets with Metric Hex Profile and Phosphate Finish - Retail Pack



SBK7806M

Hex Size	Quantity	Part Number
10 mm	1	SBK7806M-10
11 mm	1	SBK7806M-11
12 mm	1	SBK7806M-12
13 mm	1	SBK7806M-13
14 mm	1	SBK7806M-14
15 mm	1	SBK7806M-15
16 mm	1	SBK7806M-16
17 mm	1	SBK7806M-17
18 mm	1	SBK7806M-18
19 mm	1	SBK7806M-19
21 mm	1	SBK7806M-21
22 mm	1	SBK7806M-22
23 mm	1	SBK7806M-23
24 mm	1	SBK7806M-24
27 mm	1	SBK7806M-27
30 mm	1	SBK7806M-30
32 mm	1	SBK7806M-32
36 mm	1	SBK7806M-36

SB: Retail pack on a plastic info card

1/2" Square Drive Reinforced Impact Sockets with Metric Hex Profile and Phosphate Finish



SBK7801Z

Hex Size	Quantity	Part Number
17 mm	1	K7801VM-17
19 mm	1	K7801VM-19
22 mm	1	K7801VM-22
24 mm	1	K7801VM-24

1/2" Square Drive Impact Sockets with Imperial Hex Profile and Phosphate Finish



K7801Z

Imperial Size	Quantity	Part Number
3/8 in	1	K7801Z-3/8
7/16 in	1	K7801Z-7/16
1/2 in	1	K7801Z-1/2
9/16 in	1	K7801Z-9/16
5/8 in	1	K7801Z-5/8
11/16 in	1	K7801Z-11/16
3/4 in	1	K7801Z-3/4
13/16 in	1	K7801Z-13/16
7/8 in	1	K7801Z-7/8
15/16 in	1	K7801Z-15/16
1 in	1	K7801Z-1
1 1/16 in	1	K7801Z-1.1/16
1 1/8 in	1	K7801Z-1.1/8
1 1/4 in	1	K7801Z-1.1/4
1 5/16 in	5	K7801Z-1.5/16
1 3/8 in	5	K7801Z-1.3/8
1 7/16 in	5	K7801Z-1.7/16
1 1/2 in	5	K7801Z-1.1/2

1/2" Square Drive Impact Sockets with Imperial Hex Profile and Phosphate Finish - Retail Pack



SBK7801Z

Imperial Size	Quantity	Part Number
3/8 in	1	SBK7801Z-3/8
7/16 in	1	SBK7801Z-7/16
1/2 in	1	SBK7801Z-1/2
9/16 in	1	SBK7801Z-9/16
5/8 in	1	SBK7801Z-5/8
11/16 in	1	SBK7801Z-11/16
3/4 in	1	SBK7801Z-3/4
13/16 in	1	SBK7801Z-13/16
7/8 in	1	SBK7801Z-7/8
15/16 in	1	SBK7801Z-15/16
1 in	1	SBK7801Z-1
1 1/16 in	1	SBK7801Z-1.1/16
1 1/8 in	1	SBK7801Z-1.1/8
1 1/4 in	1	SBK7801Z-1.1/4
1 5/16 in	1	SBK7801Z-1.5/16
1 3/8 in	1	SBK7801Z-1.3/8
1 7/16 in	1	SBK7801Z-1.7/16
1 1/2 in	1	SBK7801Z-1.1/2

SB: Retail pack on a plastic info card

1/2" Square Drive Deep Impact Sockets with Imperial Hex Profile and Phosphate Finish



K7806Z

Imperial Size	Quantity	Part Number
3/8 in	10	K7806Z-3/8
7/16 in	5	K7806Z-7/16
1/2 in	10	K7806Z-1/2
9/16 in	10	K7806Z-9/16
5/8 in	5	K7806Z-5/8
11/16 in	5	K7806Z-11/16
3/4 in	5	K7806Z-3/4
13/16 in	5	K7806Z-13/16
7/8 in	5	K7806Z-7/8
15/16 in	5	K7806Z-15/16
1 in	5	K7806Z-1
1 1/16 in	5	K7806Z-1.1/16
1 1/8 in	5	K7806Z-1.1/8
1 1/4 in	5	K7806Z-1.1/4
1 5/16 in	5	K7806Z-1.5/16
1 3/8 in	5	K7806Z-1.3/8
1 7/16 in	5	K7806Z-1.7/16
1 1/2 in	5	K7806Z-1.1/2

SB: Retail pack on a plastic info card

1/2" Square Drive Deep Impact Sockets with Imperial Hex Profile and Phosphate Finish - Retail pack



SBK7806Z

Imperial Size	Quantity	Part Number
3/8 in	10	SBK7806Z-3/8
7/16 in	10	SBK7806Z-7/16
1/2 in	10	SBK7806Z-1/2
9/16 in	10	SBK7806Z-9/16
5/8 in	5	SBK7806Z-5/8
11/16 in	1	SBK7806Z-11/16
3/4 in	1	SBK7806Z-3/4
13/16 in	1	SBK7806Z-13/16
7/8 in	1	SBK7806Z-7/8
15/16 in	1	SBK7806Z-15/16
1 in	1	SBK7806Z-1
1 1/16 in	1	SBK7806Z-1.1/16
1 1/8 in	5	SBK7806Z-1.1/8
1 1/4 in	1	SBK7806Z-1.1/4
1 5/16 in	1	SBK7806Z-1.5/16
1 3/8 in	5	SBK7806Z-1.3/8
1 7/16 in	5	SBK7806Z-1.7/16
1 1/2 in	1	SBK7806Z-1.1/2

SB: Retail pack on a plastic info card

1/2" Square Drive Impact Socket Drivers for Hex Head Screws Phosphate Finish



7993S



5 mm	1	7993S0050
6 mm	1	7993S0060
8 mm	1	7993S0080
10 mm	1	7993S0100
12 mm	1	7993S0120
14 mm	1	7993S0140
17 mm	1	7993S0170
18 mm	1	7993S0180
19 mm	1	7993S0190

1/2" Square Drive Impact Socket Drivers for TORX® Head Screws Phosphate Finish



7994S



T20	1	7994S0200
T25	1	7994S0250
T27	1	7994S0270
T-30	1	7994S0300
T-40	1	7994S0400
T-45	1	7994S0450
T-50	1	7994S0500
T-55	1	7994S0550
T-60	1	7994S0600

1/2" Square Drive Impact Sockets with TORX® Head Profile and Phosphate Finish



K7801TORX-E



E10	1	K7801TORX-E10
E12	1	K7801TORX-E12



E14	1	K7801TORX-E14
E16	1	K7801TORX-E16
E18	1	K7801TORX-E18
E20	1	K7801TORX-E20
E24	1	K7801TORX-E24

1/2" Square Drive Bit Holders with Phosphate Finish



7807H-7809H



1/2"	1/4 in	1	7807H
1/2"	5/16 in	1	7808H
1/2"	11.2 mm	1	7809H
1/2"	1/4 in	1	SB7807H
1/2"	5/16 in	1	SB7808H
1/2"	7/16 in	1	SB7809H

1/2" Square Drive Extensions with Phosphate Finish



K8160D



75 mm	1	K8160D-1
125 mm	1	K8160D-2
250 mm	1	K8160D-3
75 mm	1	SBK8160D-1
125 mm	1	SBK8160D-2
250 mm	1	SBK8160D-3

1/2" Square Drive Ball Joint Sockets with Phosphate Finish



K8167S



1/2"	1/2"	1	K8167S
------	------	---	--------

1/2" Square Drive Adaptors with Phosphate Finish



K7764D/SBK7764D



M 3/8"	F 1/2"	1	K7764D
M 3/8"	F 1/2"	1	SBK7764D

SB: Retail pack

1/2" Square Drive to 3/4" Increasing Adaptor with Phosphate Finish



K8964D/SBK8964D



3/4"	1/2"	1	K8964D
M 3/4"	F 1/2"	1	SBK8964D

SB: Retail pack on a plastic info card



Safety Clamping Springs for 1/2" Impact Socket



K560F-4/5

1/2"	10-14 mm	5	K560F-4
1/2"	15-32 mm	5	K560F-5

1/2" Square Drive Ultrashort impact socket set, 1/2" - 13 Pcs



K7800M/13

43 x 128 x 195 mm	1	K7800M/13

K7800M-10, K7800M-11, K7800M-12, K7800M-13, K7800M-14, K7800M-15, K7800M-16, K7800M-17, K7800M-18, K7800M-19, K7800M-21, K7800M-22, K7800M-24

4750IB-A5

1/2" Square Drive Deep Impact Socket Set in Case with Metric Hex Profile and Phosphate Finish - 4 Pcs



K7806M/S4

4	1	K7806M/S4

K7806M-19, K7806M-22, K7806M-17, K7806M-24

4750IB-A5

1/2" Square Drive Reinforced Impact Socket Set with Metric Hex Profile and Phosphate Finish - 4 Pcs



K7801VM/S4

4	1	K7801VM/S4

K7801VM-22, K7801VM-19, K7801VM-17, K7801VM-24

1/2" Square Drive Impact Socket Set with Imperial Hex Profile and Phosphate Finish - 10 Pcs



K7801Z/10

10	60 x 220 x 280 mm	1	K7801Z/10

K7801Z-7/16, K7801Z-1/2, K7801Z-11/16, K7801Z-5/8, K7801Z-13/16, K7801Z-3/4, K7801Z-15/16, K7801Z-7/8, K7801Z-1, K7801Z-9/16

1/2" Square Drive Deep Impact Socket Set with Imperial Hex Profile and Phosphate Finish - 10 Pcs



K7806Z/10

10	60 x 220 x 280 mm	1	K7806Z/10

K7806Z-7/16, K7806Z-1/2, K7806Z-9/16, K7806Z-3/4, K7806Z-13/16, K7806Z-11/16, K7806Z-1, K7806Z-7/8, K7806Z-15/16, K7806Z-5/8

1/2" Square Drive Deep Impact Socket Set with Metric Hex Profile and Phosphate Finish - 14 Pcs



DD/S14

14	4	DD/S14

K7806M-10, K7806M-11, K7806M-12, K7806M-13, K7806M-14, K7806M-15, K7806M-16, K7806M-17, K7806M-18, K7806M-19, K7806M-21, K7806M-22, K7806M-24, K7806M-27

1/2" Square Drive Mixed Impact Socket Set with Metric Hex Profile and Phosphate Finish - 20 Pcs



D-DD/

20	4	D-DD/S20

K7801M-14, K7801M-15, K7801M-16, K7801M-11, K7801M-10, K7801M-13, K7801M-12, K7801M-18, K7801M-19, K7801M-17

K7806M-19, K7806M-17, K7806M-18, K7806M-14, K7806M-16, K7806M-12, K7806M-13, K7806M-10, K7806M-11

1/2" Square Drive Impact Socket Set with Metric Hex Profile and Phosphate Finish - 10 Pcs



D/

10	6	D/S10

K7801M-10, K7801M-11, K7801M-12, K7801M-13, K7801M-14, K7801M-15, K7801M-16, K7801M-17, K7801M-18, K7801M-19

1/2" Square Drive Impact Socket Set with Metric Hex Profile and Phosphate Finish - 14 Pcs



D/S14

14	6	D/S14

K7801M-10, K7801M-11, K7801M-12, K7801M-13, K7801M-14, K7801M-15, K7801M-16, K7801M-17, K7801M-18, K7801M-19, K7801M-21, K7801M-22, K7801M-24, K7801M-27

1/2" Square Drive Deep Impact Socket Set with Metric Hex Profile and Phosphate Finish - 10 Pcs



DD/

10	6	DD/S10

K7806M-10, K7806M-11, K7806M-12, K7806M-13, K7806M-14, K7806M-15, K7806M-16, K7806M-17, K7806M-18, K7806M-19

3/4" Square Drive Impact Sockets with Metric Hex Profile and Phosphate Finish



K8901M

17 mm	1	K8901M-17
18 mm	1	K8901M-18
19 mm	1	K8901M-19
21 mm	1	K8901M-21
22 mm	1	K8901M-22
23 mm	1	K8901M-23
24 mm	1	K8901M-24
27 mm	1	K8901M-27
28 mm	1	K8901M-28
29 mm	1	K8901M-29
30 mm	1	K8901M-30
32 mm	1	K8901M-32
33 mm	1	K8901M-33
34 mm	1	K8901M-34
36 mm	1	K8901M-36
38 mm	1	K8901M-38
41 mm	1	K8901M-41
46 mm	1	K8901M-46
50 mm	1	K8901M-50
55 mm	1	K8901M-55
60 mm	1	K8901M-60

SB: Retail pack on a plastic info card

3/4" Square Drive Impact Sockets with Metric Hex Profile Hang sell



SBK8901M

17 mm	1	SBK8901M-17
18 mm	1	SBK8901M-18
19 mm	1	SBK8901M-19
21 mm	1	SBK8901M-21
22 mm	1	SBK8901M-22
23 mm	1	SBK8901M-23
24 mm	1	SBK8901M-24
27 mm	1	SBK8901M-27
28 mm	1	SBK8901M-28
29 mm	1	SBK8901M-29
30 mm	1	SBK8901M-30
32 mm	1	SBK8901M-32
33 mm	1	SBK8901M-33
34 mm	1	SBK8901M-34
36 mm	1	SBK8901M-36
38 mm	1	SBK8901M-38
41 mm	1	SBK8901M-41
46 mm	1	SBK8901M-46
55 mm	1	SBK8901M-55
60 mm	1	SBK8901M-60
50 mm	1	SBK8901M-50

SB: Retail pack on a plastic info card

3/4" Square Drive Deep Impact Sockets with Metric Hex Profile and Phosphate Finish



K8906M

17 mm	1	K8906M-17
19 mm	1	K8906M-19
21 mm	1	K8906M-21
22 mm	1	K8906M-22
24 mm	1	K8906M-24
27 mm	1	K8906M-27
30 mm	1	K8906M-30
32 mm	1	K8906M-32
33 mm	1	K8906M-33
34 mm	1	K8906M-34
36 mm	1	K8906M-36
41 mm	1	K8906M-41
46 mm	1	K8906M-46

SB: Retail pack on a plastic info card



3/4" Square Drive Impact Sockets with Imperial Hex Profile and Phosphate Finish



K8901Z



11/16 in	1	K8901Z-11/16
3/4 in	1	K8901Z-3/4
13/16 in	1	K8901Z-13/16
7/8 in	1	K8901Z-7/8
15/16 in	1	K8901Z-15/16
1 in	1	K8901Z-1
1 1/16 in	1	K8901Z-1.1/16
1 1/8 in	1	K8901Z-1.1/8
1 3/16 in	1	K8901Z-1.3/16
1 1/4 in	1	K8901Z-1.1/4
1 5/16 in	1	K8901Z-1.5/16
1 3/8 in	1	K8901Z-1.3/8
1 7/16 in	1	K8901Z-1.7/16
1 1/2 in	1	K8901Z-1.1/2
1 9/16 in	1	K8901Z-1.9/16
1 5/8 in	1	K8901Z-1.5/8
1 11/16 in	1	K8901Z-1.11/16
1 3/4 in	1	K8901Z-1.3/4
1 13/16 in	1	K8901Z-1.13/16
1 7/8 in	1	K8901Z-1.7/8
1 15/16 in	1	K8901Z-1.15/16
2 in	1	K8901Z-2
2 1/16 in	1	K8901Z-2.1/16
2 3/16 in	1	K8901Z-2.3/16
2 1/4 in	1	K8901Z-2.1/4
2 3/8 in	1	K8901Z-2.3/8

SB: Retail pack on a plastic info card

3/4" Square Drive Deep Impact Sockets with Imperial Hex Profile and Phosphate Finish



K8906Z



3/4 in	1	K8906Z-3/4
13/16 in	1	K8906Z-13/16
7/8 in	1	K8906Z-7/8
15/16 in	1	K8906Z-15/16



1 mm	1	K8906Z-1
1 1/16 in	1	K8906Z-1.1/16
1/8 in	1	K8906Z-1.1/8
1.1/4 in	1	K8906Z-1.1/4
1.5/16 in	1	K8906Z-1.5/16
1.3/8 in	1	K8906Z-1.3/8
1.7/16 in	1	K8906Z-1.7/16
1.1/2 in	1	K8906Z-1.1/2
1.5/8 in	1	K8906Z-1.5/8
1.3/4 in	1	K8906Z-1.3/4
2 mm	1	K8906Z-2

SB: Retail pack on a plastic info card

3/4" Square Drive Impact Socket Drivers for Hex Head Screws Phosphate Finish



7993T



12 mm	1	7993T0120
14 mm	1	7993T0140
17 mm	1	7993T0170
19 mm	1	7993T0190
22 mm	1	7993T0220
24 mm	1	7993T0240

3/4" Square Drive Bit Holders with Phosphate Finish



K8909H



22 mm	3/4"	1	K8909H-5
-------	------	---	----------

3/4" Square Drive Ball Joint Sockets with Phosphate Finish



K8967S



3/4"	3/4"	1	K8967S
------	------	---	--------

3/4" Square Drive Adaptors with Phosphate Finish



K8164F



1/2"	3/4"	1	K8164F
------	------	---	--------

3/4" Square Drive to 1" Socket Increasing Adaptors with Phosphate Finish



K9564F



1"	3/4"	1	K9564F
----	------	---	--------

3/4" Square Drive Extensions with Phosphate Finish



K8960F



175 mm	1	K8960F-2
250 mm	1	K8960F-3
325 mm	1	K8960F-4

Safety Clamping Springs for 3/4" Impact Socket



K560F-6



3/4"	17-46 mm	5	K560F-6
------	----------	---	---------

3/4" Square Drive Impact Socket Set with Metric Hex Profile and Phosphate Finish - 8 Pcs



K8901M/8



8	65 x 240 x 350 mm	1	K8901M/8
---	-------------------	---	----------

K8901M-27, K8901M-24, K8901M-21, K8901M-22, K8901M-30, K8901M-32, K8901M-36, K8901M-41

3/4" Square Drive Deep Impact Socket Set with Metric Hex Profile and Phosphate Finish - 8 Pcs



K8906M/8



8	80 x 250 x 315 mm	1	K8906M/8
---	-------------------	---	----------

K8906M-24, K8906M-27, K8906M-30, K8906M-41, K8906M-36, K8906M-21, K8906M-22, K8906M-32

3/4" Square Drive Impact Socket Set with Imperial Hex Profile and Phosphate Finish - 8 Pcs



K8901Z/8



8	80 x 250 x 310 mm	1	K8901Z/8
---	-------------------	---	----------

K8901Z-1.1/16, K8901Z-1, K8901Z-1.3/8, K8901Z-1.5/16, K8901Z-1.1/4, K8901Z-1.1/2, K8901Z-1.7/16, K8901Z-1.1/8

3/4" Square Drive Impact Socket Set with Imperial Hex Profile and Phosphate Finish - 18 Pcs



K8901Z/18



18	100 x 210 x 595 mm	1	K8901Z/18
----	--------------------	---	-----------

K8901Z-11/16, K8901Z-3/4, K8901Z-13/16, K8901Z-7/8, K8901Z-15/16, K8901Z-1, K8901Z-1.1/16, K8901Z-1.1/8, K8901Z-1.3/16, K8901Z-1.1/4, K8901Z-1.5/16, K8901Z-1.3/8, K8901Z-1.7/16, K8901Z-1.1/2, K8901Z-1.9/16, K8901Z-1.5/8, K8901Z-1.11/16, K8901Z-1.3/4

3/4" Square Drive Deep Impact Socket Set with Imperial Hex Profile and Phosphate Finish - 8 Pcs



K8906Z/8



8	125 x 250 x 110 mm	1	K8906Z/8
---	--------------------	---	----------

K8906Z-1, K8906Z-1.1/16, K8906Z-1.1/8, K8906Z-1.1/4, K8906Z-1.5/16, K8906Z-1.3/8, K8906Z-1.7/16, K8906Z-1.1/2



1" Square Drive Impact Sockets with Metric Hex Profile and Phosphate Finish



K9501M



22 mm	1	K9501M-22
24 mm	1	K9501M-24
27 mm	1	K9501M-27
30 mm	1	K9501M-30
32 mm	1	K9501M-32
33 mm	1	K9501M-33
34 mm	1	K9501M-34
36 mm	1	K9501M-36
38 mm	1	K9501M-38
41 mm	1	K9501M-41
42 mm	1	K9501M-42
46 mm	1	K9501M-46
50 mm	1	K9501M-50
55 mm	1	K9501M-55
60 mm	1	K9501M-60
65 mm	1	K9501M-65
70 mm	1	K9501M-70
75 mm	1	K9501M-75
80 mm	1	K9501M-80
85 mm	1	K9501M-85

1" Square Drive Impact Sockets with Imperial Hex Profile and Phosphate Finish



K9501Z



1 in	1	K9501Z-1
1 1/16 in	1	K9501Z-1.1/16
1 1/8 in	1	K9501Z-1.1/8
1 3/16 in	1	K9501Z-1.3/16
1 1/4 in	1	K9501Z-1.1/4
1 5/16 in	1	K9501Z-1.5/16
1 3/8 in	1	K9501Z-1.3/8
1 7/16 in	1	K9501Z-1.7/16
1 1/2 in	1	K9501Z-1.1/2
1 9/16 in	1	K9501Z-1.9/16
1 5/8 in	1	K9501Z-1.5/8
1 11/16 in	1	K9501Z-1.11/16
1 3/4 in	1	K9501Z-1.3/4
1 13/16 in	1	K9501Z-1.13/16
1 7/8 in	1	K9501Z-1.7/8
1 15/16 in	1	K9501Z-1.15/16
2 in	1	K9501Z-2
2 1/8 in	1	K9501Z-2.1/8
2 3/16 in	1	K9501Z-2.3/16
2 1/4 in	1	K9501Z-2.1/4
2 5/16 in	1	K9501Z-2.5/16
2 9/16 in	1	K9501Z-2.9/16
2 3/4 in	1	K9501Z-2.3/4

1" Square Drive Bit Holders with 22 mm Male Hex Drive with Phosphate Finish



K9509H5



22 mm	1"	1	K9509H5
-------	----	---	---------

1" Square Drive Deep Impact Sockets with Metric Hex Profile and Phosphate Finish



K9506M



22 mm	1	K9506M-22
24 mm	1	K9506M-24
27 mm	1	K9506M-27
30 mm	1	K9506M-30
32 mm	1	K9506M-32
33 mm	1	K9506M-33
34 mm	1	K9506M-34
36 mm	1	K9506M-36
38 mm	1	K9506M-38
41 mm	1	K9506M-41
46 mm	1	K9506M-46
50 mm	1	K9506M-50
55 mm	1	K9506M-55
60 mm	1	K9506M-60

1" Square Drive Deep Impact Sockets with Imperial Hex Profile and Phosphate Finish



K9506Z



1 in	1	K9506Z-1
1 1/16 in	1	K9506Z-1.1/16
1 3/16 in	1	K9506Z-1.3/16
1 1/4 in	1	K9506Z-1.1/4
1 7/16 in	1	K9506Z-1.7/16
1 1/2 in	1	K9506Z-1.1/2
1 5/8 in	1	K9506Z-1.5/8
1 13/16 in	1	K9506Z-1.13/16
1 7/8 in	1	K9506Z-1.7/8

1" Square Drive Socket Drivers for Hex Head Screws Phosphate Finish



7993M



17 mm	1	7993M0170
19 mm	1	7993M0190
22 mm	1	7993M0220
27 mm	1	7993M0270

1" Square Drive Adaptors with Phosphate Finish



K8964G



3/4"	1"	1	K8964G
------	----	---	--------

1" to 1-1/2" Square Drive Adaptor with Phosphate Finish



K9895G

1 1/2"	1"	1	K9895G

1" Square Drive Extensions with Phosphate Finish



K9560G

100 mm	1	K9560G-0
125 mm	1	K9560G-1
175 mm	1	K9560G-2
325 mm	1	K9560G-3
300 mm	1	K9560G-4
400 mm	1	K9560G-5

1" Square Drive Ball Joint Sockets with Phosphate Finish



K9567S

1"	1"	1	K9567S

Bits with 22 mm Male Hex Drive



K8909ML/K9509ML

12 mm	1	K8909ML-12
14 mm	1	K8909ML-14
17 mm	1	K8909ML-17
19 mm	1	K9509ML-19
22 mm	1	K9509ML-22
24 mm	1	K9509ML-24

Safety Clamping Springs for 1" and 1-1/2" Impact Socket



K560F-7/8

1"	19-70 mm	5	K560F-7
1 & 1 1/2"	75-80 & 46-90 mm	5	K560F-8

1-1/2" Square Drive Impact Sockets with Metric Hex Profile and Phosphate Finish



K9801M

46 mm	1	K9801M-46
50 mm	1	K9801M-50
55 mm	1	K9801M-55

60 mm	1	K9801M-60
65 mm	1	K9801M-65
70 mm	1	K9801M-70
75 mm	1	K9801M-75
80 mm	1	K9801M-80
85 mm	1	K9801M-85
90 mm	1	K9801M-90
95 mm	1	K9801M-95
100 mm	1	K9801M-100
105 mm	1	K9801M-105
110 mm	1	K9801M-110
115 mm	1	K9801M-115
120 mm	1	K9801M-120
125 mm	1	K9801M-125
130 mm	1	K9801M-130
135 mm	1	K9801M-135
140 mm	1	K9801M-140
145 mm	1	K9801M-145
150 mm	1	K9801M-150
155 mm	1	K9801M-155

1-1/2" Square Drive Deep Impact Sockets with Metric Hex Profile and Phosphate Finish



K9806M

41 mm	1	K9806M-41
46 mm	1	K9806M-46
50 mm	1	K9806M-50
55 mm	1	K9806M-55
60 mm	1	K9806M-60
65 mm	1	K9806M-65
70 mm	1	K9806M-70
75 mm	1	K9806M-75
80 mm	1	K9806M-80
85 mm	1	K9806M-85
90 mm	1	K9806M-90
95 mm	1	K9806M-95
100 mm	1	K9806M-100
105 mm	1	K9806M-105
110 mm	1	K9806M-110
115 mm	1	K9806M-115
120 mm	1	K9806M-120



1-1/2" Square Drive Impact Sockets with Imperial Hex Profile and Phosphate Finish



K9801Z



1 3/8 in	1	K9801Z-1.3/8
1 7/16 in	1	K9801Z-1.7/16
1 1/2 in	1	K9801Z-1.1/2
1 9/16 in	1	K9801Z-1.9/16
1 5/8 in	1	K9801Z-1.5/8
1 11/16 in	1	K9801Z-1.11/16
1 3/4 in	1	K9801Z-1.3/4
1 13/16 in	1	K9801Z-1.13/16
1 7/8 in	1	K9801Z-1.7/8
1 15/16 in	1	K9801Z-1.15/16
2 in	1	K9801Z-2
2 1/16 in	1	K9801Z-2.1/16
2 1/8 in	1	K9801Z-2.1/8
2 3/16 in	1	K9801Z-2.3/16
2 1/4 in	1	K9801Z-2.1/4
2 5/16 in	1	K9801Z-2.5/16
2 3/8 in	1	K9801Z-2.3/8
2 7/16 in	1	K9801Z-2.7/16
2 1/2 in	1	K9801Z-2.1/2
2 9/16 in	1	K9801Z-2.9/16
2 5/8 in	1	K9801Z-2.5/8
2 11/16 in	1	K9801Z-2.11/16
2 3/4 in	1	K9801Z-2.3/4
2 13/16 in	1	K9801Z-2.13/16
2 7/8 in	1	K9801Z-2.7/8
2 15/16 in	1	K9801Z-2.15/16
3 in	1	K9801Z-3
3 1/16 in	1	K9801Z-3.1/16
3 1/8 in	1	K9801Z-3.1/8
3 1/4 in	1	K9801Z-3.1/4
3 5/16 in	1	K9801Z-3.5/16
3 3/8 in	1	K9801Z-3.3/8
3 7/16 in	1	K9801Z-3.7/16
3 1/2 in	1	K9801Z-3.1/2
3 9/16 in	1	K9801Z-3.9/16
3 5/8 in	1	K9801Z-3.5/8
3 11/16 in	1	K9801Z-3.11/16
3 3/4 in	1	K9801Z-3.3/4
3 13/16 in	1	K9801Z-3.13/16
3 7/8 in	1	K9801Z-3.7/8
3 15/16 in	1	K9801Z-3.15/16
4 in	1	K9801Z-4
4 1/16 in	1	K9801Z-4.1/16
4 1/8 in	1	K9801Z-4.1/8
4 1/4 in	1	K9801Z-4.1/4
4 5/16 in	1	K9801Z-4.5/16
4 3/8 in	1	K9801Z-4.3/8
4 7/16 in	1	K9801Z-4.7/16
4 1/2 in	1	K9801Z-4.1/2
4 5/8 in	1	K9801Z-4.5/8
4 3/4 in	1	K9801Z-4.3/4

1-1/2" Square Drive Deep Impact Sockets with Imperial Hex Profile and Phosphate Finish



K9806Z



1 3/8 in	1	K9806Z-1.3/8
1 7/16 in	1	K9806Z-1.7/16
1 1/2 in	1	K9806Z-1.1/2
1 5/8 in	1	K9806Z-1.5/8
1 11/16 in	1	K9806Z-1.11/16
2 in	1	K9806Z-2
2 1/16 in	1	K9806Z-2.1/16
2 3/16 in	1	K9806Z-2.3/16
2 1/4 in	1	K9806Z-2.1/4
2 5/16 in	1	K9806Z-2.5/16
2 3/8 in	1	K9806Z-2.3/8
2 7/16 in	1	K9806Z-2.7/16
2 1/2 in	1	K9806Z-2.1/2
2 9/16 in	1	K9806Z-2.9/16
2 5/8 in	1	K9806Z-2.5/8
2 11/16 in	1	K9806Z-2.11/16
2 3/4 in	1	K9806Z-2.3/4
2 13/16 in	1	K9806Z-2.13/16
2 7/8 in	1	K9806Z-2.7/8
2 15/16 in	1	K9806Z-2.15/16
3 in	1	K9806Z-3
3 1/16 in	1	K9806Z-3.1/16
3 1/8 in	1	K9806Z-3.1/8
3 3/16 in	1	K9806Z-3.3/16
3 1/4 in	1	K9806Z-3.1/4
3 5/16 in	1	K9806Z-3.5/16
3 3/8 in	1	K9806Z-3.3/8
3 7/16 in	1	K9806Z-3.7/16
3 1/2 in	1	K9806Z-3.1/2
3 9/16 in	1	K9806Z-3.9/16
3 5/8 in	1	K9806Z-3.5/8
3 11/16 in	1	K9806Z-3.11/16
3 3/4 in	1	K9806Z-3.3/4
3 13/16 in	1	K9806Z-3.13/16
3 7/8 in	1	K9806Z-3.7/8
3 15/16 in	1	K9806Z-3.15/16
4 in	1	K9806Z-4
4 1/16 in	1	K9806Z-4.1/16
4 1/8 in	1	K9806Z-4.1/8
4 1/4 in	1	K9806Z-4.1/4
4 5/16 in	1	K9806Z-4.5/16
4 3/8 in	1	K9806Z-4.3/8
4 1/2 in	1	K9806Z-4.1/2
4 5/8 in	1	K9806Z-4.5/8
4 3/4 in	1	K9806Z-4.3/4

1-1/2" Square Drive Ball Joints with Phosphate Finish



K9867S



1 1/2	1 1/2	1	K9867S
-------	-------	---	--------

1-1/2" Square Drive Extensions with Phosphate Finish



K9860H



255 mm	1	K9860H-1
380 mm	1	K9860H-2
510 mm	1	K9860H-3

1-1/2" Square Drive Adaptors with Phosphate Finish



K9598H



1	1 1/2	1	K9598H
---	-------	---	--------

1.1/2" Square Drive to 2.1/2" Socket
Increasing Adaptors with Phosphate Finish



K9998H



2 1/2



1 1/2



1 K9998H

2.1/2" Square Drive to 1.1/2" Socket
Reducing Adaptor with Phosphate Finish



K9899H



1 1/2



2 1/2



1 K9899H

Safety Clamping Springs for 1-1/2" Impact
Socket



K560F-9



1 1/2"



95-120 mm



5 K560F-9



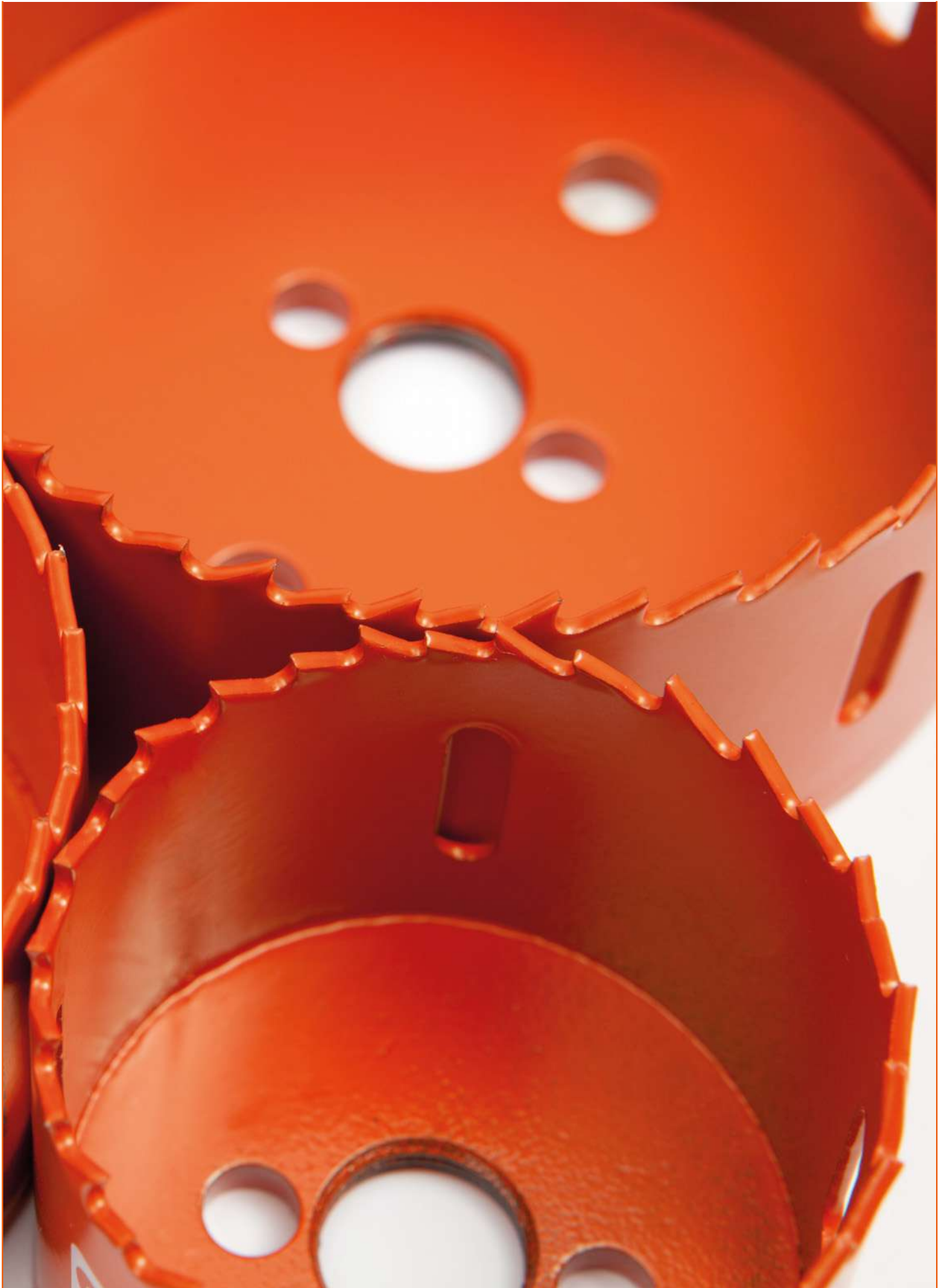

BAHCO



Screwdrivers



ERGO™ SCREWDRIVERS WITH RIGGED RUBBER GRIP & COLOUR ID

ERGO™ Slotted Straight Screwdrivers with Rubber Grip 2.0-6.5 mm



ergo



BE-8002 - BE-8252



2.0 mm	60 mm	17 mm	103 mm	5	BE-8002
2.5 mm	60 mm	17 mm	103 mm	5	BE-8010
2.5 mm	75 mm	17 mm	103 mm	5	BE-8210
3.0 mm	60 mm	17 mm	103 mm	5	BE-8020
3.0 mm	75 mm	17 mm	103 mm	5	BE-8020L
3.0 mm	100 mm	17 mm	103 mm	5	BE-8022
3.0 mm	125 mm	17 mm	103 mm	5	BE-8220
3.0 mm	200 mm	17 mm	103 mm	5	BE-8225
3.5 mm	75 mm	17 mm	103 mm	5	BE-8030
3.5 mm	125 mm	17 mm	103 mm	5	BE-8230
3.5 mm	200 mm	17 mm	103 mm	5	BE-8235
4.0 mm	100 mm	20 mm	122 mm	5	BE-8040
4.0 mm	175 mm	20 mm	122 mm	5	BE-8240
5.5 mm	125 mm	27 mm	122 mm	5	BE-8241
5.5 mm	150 mm	27 mm	122 mm	5	BE-8242
5.5 mm	200 mm	27 mm	122 mm	5	BE-8250L
6.0 mm	150 mm	36 mm	122 mm	5	BE-8251
6.5 mm	150 mm	36 mm	122 mm	5	BE-8252

ERGO™ Slotted Flat Screwdrivers with Rubber Grip 5.5-10 mm



ergo



BE-8150 - BE-8258



5.5 mm	100 mm	27 mm	122 mm	5	BE-8150
5.5 mm	150 mm	27 mm	122 mm	5	BE-8250
6.5 mm	125 mm	36 mm	122 mm	5	BE-8155
6.5 mm	150 mm	36 mm	122 mm	5	BE-8255
8 mm	150 mm	36 mm	122 mm	5	BE-8256
8 mm	175 mm	36 mm	122 mm	5	BE-8257
10 mm	200 mm	36 mm	161 mm	5	BE-8258

ERGO™ Hex Bolster Slotted Flat Screwdrivers with Rubber Grip 5.5-8 mm



ergo



BE-8158 - BE-8890



5.5 mm	125 mm	27 mm	122 mm	5	BE-8158
6.5 mm	150 mm	36 mm	122 mm	5	BE-8159
8 mm	125 mm	36 mm	122 mm	5	BE-8160
8 mm	175 mm	36 mm	122 mm	5	BE-8260
8 mm	175 mm	36 mm	161 mm	5	BE-8865
10 mm	175 mm	36 mm	161 mm	5	BE-8870
12 mm	200 mm	36 mm	161 mm	5	BE-8880
14 mm	200 mm	36 mm	161 mm	5	BE-8890

ERGO™ Stubby Slotted Straight Screwdrivers with Rubber Grip 3.5-8.0 mm



ergo



BE-8330 - BE-8360



3.5 mm	25 mm	36 mm	58 mm	5	BE-8330
4.0 mm	25 mm	36 mm	58 mm	5	BE-8340
5.0 mm	25 mm	36 mm	58 mm	5	BE-8350
5.0 mm	45 mm	36 mm	58 mm	5	BE-8450
6.5 mm	25 mm	36 mm	58 mm	5	BE-8355
6.0 mm	45 mm	36 mm	58 mm	5	BE-8455
8.0 mm	25 mm	36 mm	58 mm	5	BE-8360

ERGO™ Phillips Screwdrivers with Rubber Grip PH0-PH4



ergo



BE-8600 - BE-8624



PH 0	60 mm	17 mm	103 mm	5	BE-8600
PH 0	100 mm	17 mm	103 mm	5	BE-8605
PH 0	200 mm	17 mm	103 mm	5	BE-8608
PH 1	75 mm	27 mm	122 mm	5	BE-8610
PH 1	75 mm	20 mm	122 mm	5	BE-8611
PH 1	* 200 mm	27 mm	122 mm	5	BE-8610L

PH 2	100 mm	36 mm	122 mm	5	BE-8620	
PH 2	100 mm	27 mm	122 mm	5	BE-8621	
PH 2	150 mm	36 mm	122 mm	5	BE-8622	
PH 2	* 200 mm	36 mm	122 mm	5	BE-8620L	
PH 3	150 mm	36 mm	122 mm	5	BE-8623	
PH 4	200 mm	36 mm	161 mm	5	BE-8624	

ERGO™ Hex Bolster Phillips Screwdrivers with Rubber Grip PH1-PH4



BE-8628 - BE-8640



PH 1	100 mm	27 mm	122 mm	5	BE-8628	
PH 2	125 mm	36 mm	122 mm	5	BE-8629	
PH 3	150 mm	36 mm	122 mm	5	BE-8630	
PH 4	200 mm	36 mm	161 mm	5	BE-8640	

ERGO™ Stubby Phillips Screwdrivers with Rubber Grip PH1-PH2



BE-8601/BE-8602



PH 1	25 mm	36 mm	58 mm	5	BE-8601	
PH 2	25 mm	36 mm	58 mm	5	BE-8602	

ERGO™ Pozidriv Screwdrivers with Rubber Grip PZ0-PZ4



BE-8800 - BE-8824



PZ 0	60 mm	17 mm	103 mm	5	BE-8800	
PZ 1	75 mm	27 mm	122 mm	5	BE-8810	

PZ 1	75 mm	20 mm	122 mm	5	BE-8811	
PZ 1	200 mm	27 mm	122 mm	5	BE-8810L	
PZ 2	100 mm	36 mm	122 mm	5	BE-8820	
PZ 2	100 mm	27 mm	122 mm	5	BE-8821	
PZ 2	200 mm	36 mm	122 mm	5	BE-8820L	
PZ 3	150 mm	36 mm	122 mm	5	BE-8823	
PZ 4	200 mm	36 mm	161 mm	5	BE-8824	

ERGO™ Hex Bolster Pozidriv Screwdrivers with Rubber Grip PZ1-PZ4



BE-8828 - BE-8840



PZ 1	100 mm	27 mm	122 mm	5	BE-8828	
PZ 2	125 mm	36 mm	122 mm	5	BE-8829	
PZ 3	150 mm	36 mm	122 mm	5	BE-8830	
PZ 4	200 mm	36 mm	161 mm	5	BE-8840	

ERGO™ Stubby Pozidriv Screwdrivers with Rubber Grip PZ1-PZ2



BE-8801/BE-8802



PZ 1	25 mm	36 mm	58 mm	5	BE-8801	
PZ 2	25 mm	36 mm	58 mm	5	BE-8802	



ERGO™ TORX® Screwdrivers with Rubber Grip T4-T45



BE-8904 - BE-8945



T 4	75 mm	17 mm	103 mm	5	BE-8904	
T 5	75 mm	17 mm	103 mm	5	BE-8905	
T 6	75 mm	17 mm	103 mm	5	BE-8906	
T 7	75 mm	17 mm	103 mm	5	BE-8907	
T 8	75 mm	17 mm	103 mm	5	BE-8908	
T 9	75 mm	17 mm	103 mm	5	BE-8909	
T 10	75 mm	20 mm	122 mm	5	BE-8910	
T 15	100 mm	27 mm	122 mm	5	BE-8915	
T 20	100 mm	27 mm	122 mm	5	BE-8920	
T 25	125 mm	27 mm	122 mm	5	BE-8925	
T 27	125 mm	27 mm	122 mm	5	BE-8927	
T 30	150 mm	36 mm	122 mm	5	BE-8930	
T 40	150 mm	36 mm	161 mm	5	BE-8940	
T 45	150 mm	36 mm	161 mm	5	BE-8945	

ERGO™ TORX® Tamper-Resistant Screwdrivers with Rubber Grip TR7-TR40



BE-7907 - BE-7940



TR 7	75 mm	17 mm	103 mm	5	BE-7907	
TR 8	75 mm	17 mm	103 mm	5	BE-7908	
TR 9	75 mm	17 mm	103 mm	5	BE-7909	
TR 10	75 mm	20 mm	122 mm	5	BE-7910	
TR 15	100 mm	27 mm	122 mm	5	BE-7915	
TR 20	100 mm	27 mm	122 mm	5	BE-7920	
TR 25	125 mm	27 mm	122 mm	5	BE-7925	
TR 27	125 mm	27 mm	122 mm	5	BE-7927	
TR 30	150 mm	36 mm	122 mm	5	BE-7930	
TR 40	150 mm	36 mm	161 mm	5	BE-7940	

ERGO™ TORX® Ball End Screwdrivers with Rubber Grip T15-T40



BE-7515 - BE-7540



T 15	100 mm	27 mm	122 mm	5	BE-7515	
T 20	100 mm	27 mm	122 mm	5	BE-7520	
T 25	125 mm	27 mm	122 mm	5	BE-7525	
T 27	125 mm	27 mm	122 mm	5	BE-7527	
T 30	150 mm	36 mm	122 mm	5	BE-7530	
T 40	150 mm	36 mm	122 mm	5	BE-7540	

ERGO™ TORX® Plus Screwdrivers with Rubber Grip T15-T40



BE-7715 - BE-7740



T 15	100 mm	27 mm	122 mm	5	BE-7715	
T 20	100 mm	27 mm	122 mm	5	BE-7720	
T 25	125 mm	27 mm	122 mm	5	BE-7725	
T 27	125 mm	27 mm	122 mm	5	BE-7727	
T 30	150 mm	36 mm	122 mm	5	BE-7730	
T 40	150 mm	36 mm	122 mm	5	BE-7740	

ERGO™ Hex Screwdrivers with Rubber Grip Hex2-3 mm



BE-6902 - BE-6903



2 mm	75 mm	17 mm	103 mm	5	BE-6902	
2.5 mm	75 mm	17 mm	103 mm	5	BE-6925	
3 mm	75 mm	20 mm	122 mm	5	BE-6903	

ERGO™ Hex Ball End Screwdrivers with Rubber Grip, metric 1.5-10 mm



BE-8715 - BE-8710



Size	Length	Tip	Shaft	Weight	Part No.
1.5 mm	60 mm	17 mm	103 mm	5	BE-8715
2 mm	100 mm	17 mm	103 mm	5	BE-8702
2.5 mm	100 mm	17 mm	103 mm	5	BE-8725
3 mm	100 mm	20 mm	122 mm	5	BE-8703
4 mm	100 mm	27 mm	122 mm	5	BE-8704
5 mm	100 mm	36 mm	122 mm	5	BE-8705
6 mm	125 mm	36 mm	122 mm	5	BE-8706
8 mm	150 mm	36 mm	122 mm	5	BE-8708
10 mm	150 mm	36 mm	161 mm	5	BE-8710

ERGO™ Hex Ball End Screwdrivers with Rubber Grip, inches 7/64-3/8"



BE-8700-7/64 - BE-8700-5/16



Size	Length	Tip	Shaft	Weight	Part No.
7/64 in	100 mm	20 mm	122 mm	5	BE-8700-7/64
5/32 in	100 mm	27 mm	122 mm	5	BE-8700-5/32
3/16 in	100 mm	27 mm	122 mm	5	BE-8700-3/16
7/32 in	100 mm	36 mm	122 mm	5	BE-8700-7/32
1/4 in	125 mm	36 mm	122 mm	5	BE-8700-1/4
5/16 in	150 mm	36 mm	122 mm	5	BE-8700-5/16
3/8 in	150 mm	36 mm	161 mm	5	BE-8700-3/8

ERGO™ Robertson -Square Screwdrivers with Rubber Grip #1-#3



BE-9001 - BE-9003



Size	Length	Tip	Shaft	Weight	Part No.
# 1	80 mm	27 mm	122 mm	5	BE-9001
# 2	80 mm	27 mm	122 mm	5	BE-9002
# 3	100 mm	27 mm	122 mm	5	BE-9003

ERGO™ TRI-WING® Security Screwdrivers with Rubber Grip #0-#5



BE-9100 - BE-9105



Size	Length	Tip	Shaft	Weight	Part No.
0	80 mm	20 mm	122 mm	5	BE-9100
1	80 mm	20 mm	122 mm	5	BE-9101
2	80 mm	27 mm	122 mm	5	BE-9102
3	80 mm	27 mm	122 mm	5	BE-9103
4	100 mm	27 mm	122 mm	5	BE-9104
5	100 mm	27 mm	122 mm	5	BE-9105

ERGO™ TORQ-SET® Security Screwdrivers with Rubber Grip #1-#10



BE-8080



Size	Length	Tip	Shaft	Weight	Part No.
1	75 mm	27 mm	122 mm	5	BE-8080-1
2	75 mm	27 mm	122 mm	5	BE-8080-2
3	75 mm	27 mm	122 mm	5	BE-8080-3
4	75 mm	27 mm	122 mm	5	BE-8080-4
5	75 mm	27 mm	122 mm	5	BE-8080-5
6	75 mm	27 mm	122 mm	5	BE-8080-6
8	100 mm	27 mm	122 mm	5	BE-8080-8
10	100 mm	27 mm	122 mm	5	BE-8080-10

ERGO™ Round Tip Awl Screwdriver with Rubber Grip



BE-8985

Size	Length	Tip	Shaft	Weight	Part No.
6 mm	100 mm	27 mm	122 mm	5	BE-8985



ERGO™ Stubby Round Tip Awl Screwdriver with Rubber Grip 6 mm



BE-8986

4 mm	36 mm	50 mm	58 mm	5	BE-8986

ERGO™ Square Tip Reamer Screwdriver with Rubber Grip 6 mm



BE-8980

6 mm	100 mm	27 mm	122 mm	5	BE-8980

ERGO™ Hex Head Nut Drivers with Rubber Grip 4-7 mm



BE-6400M

4 mm	100 mm	20 mm	122 mm	5	BE-6400M-4
5 mm	100 mm	20 mm	122 mm	5	BE-6400M-5
5.5 mm	100 mm	20 mm	122 mm	5	BE-6400M-5.5
7 mm	100 mm	20 mm	122 mm	5	BE-6400M-7

ERGO™ Long Bore Hex Head Nut Drivers with Rubber Grip 3-14 mm



BE-78

3 mm	125 mm	20 mm	122 mm	5	BE-7803
3.5 mm	125 mm	20 mm	122 mm	5	BE-7835
4 mm	125 mm	20 mm	122 mm	5	BE-7804
4.5 mm	125 mm	20 mm	122 mm	5	BE-7845
5 mm	125 mm	20 mm	122 mm	5	BE-7805
5.5 mm	125 mm	20 mm	122 mm	5	BE-7855
6 mm	125 mm	20 mm	122 mm	5	BE-7806
7 mm	125 mm	27 mm	122 mm	5	BE-7807
8 mm	125 mm	27 mm	122 mm	5	BE-7808
9 mm	125 mm	36 mm	122 mm	5	BE-7809
10 mm	125 mm	36 mm	122 mm	5	BE-7810
11 mm	125 mm	36 mm	122 mm	5	BE-7811
12 mm	125 mm	36 mm	122 mm	5	BE-7812
13 mm	125 mm	36 mm	161 mm	5	BE-7813
14 mm	125 mm	36 mm	161 mm	5	BE-7814

ERGO™ Flexible Shaft Hex Head Nut Drivers with Rubber Grip 6-8 mm



BE-76

6 mm	150 mm	27 mm	122 mm	5	BE-7606
7 mm	150 mm	27 mm	122 mm	5	BE-7607
8 mm	150 mm	27 mm	122 mm	5	BE-7608

ERGO™ TORX® Screwdriver Set with Rubber Grip - 5 Pcs



BE-9885



5

1 BE-9885

BE-8910, BE-8930, BE-8915, BE-8920, BE-8925



ERGO™ Slotted/Phillips Screwdriver Set with Rubber Grip - 6 Pcs



BE-9881



6

1 BE-9881

BE-8020, BE-8040



BE-8150, BE-8155



BE-8620, BE-8610



ERGO™ Slotted/Pozidriv Screwdriver Set with Rubber Grip - 6 Pcs



BE-9882



6

1 BE-9882

BE-8020, BE-8040



BE-8155, BE-8150



BE-8810, BE-8820



ERGO™ Slotted-Straight/Phillips/Pozidriv Screwdriver Set with Rubber Grip - 6 Pcs



BE-9884



6

1 BE-9884

BE-8611, BE-8621



BE-8040, BE-8241



BE-8811, BE-8821



ERGO™ Slotted/Phillips/Pozidriv Screwdriver Set with Rubber Grip - 6 Pcs



BE-9886



6

1 BE-9886

BE-8030



BE-8150



BE-8621, BE-8611



BE-8821, BE-8811



ERGO™ Slotted/Phillips/Pozidriv/TORX® Screwdriver Set with Rubber Grip - 6 Pcs



BE-9871

6 1 BE-9871

BE-8220S		
BE-8920, BE-8925		
BE-8820		
BE-8611, BE-8620		

ERGO™ Slotted/Phillips/Pozidriv/Torx® Screwdriver Set with Rubber Grip - 8 pcs



BE-9872

8 45 x 170 x 340 mm 595 g 1 BE-9872

BE-8925, BE-8920, BE-8915		
BE-8030		
BE-8821, BE-8811		
BE-8621, BE-8611		

ERGO™ Slotted/Phillips/Pozidriv/TORX® Screwdriver Set with Rubber Grip - 13 Pcs



BE-9875

13 1 BE-9875

BE-8040		
BE-8150, BE-8155		
BE-8621		
BE-8811, BE-8821		
BE-8910, BE-8915, BE-8920, BE-8925		
BE-8010S, BE-8230S		
BE-8811S		

ERGO™ Slotted/Phillips/Pozidriv/TORX® Screwdriver Set with Rubber Grip - 13 Pcs



BE-9879

13 1 BE-9879

BE-8010, BE-8040		
BE-8150		
BE-8611, BE-8621		
BE-8811, BE-8821		
BE-8910, BE-8915, BE-8920, BE-8925		
BE-8220SL		
BE-8620SL		

ERGO™ Slotted/Phillips/Pozidriv/TORX® Screwdriver Set with Rubber Grip - 15 Pcs



BE-9877



15

1 BE-9877

BE-8030



BE-8150



BE-8611, BE-8621



BE-8811, BE-8821



BE-8910, BE-8915, BE-8920, BE-8925



BE-8220S, BE-8040S, BE-8050S



BE-8611S, BE-8621S



ERGO™ Bit Holder with Rubber Grip for 1/4" Hex Bit



BE-8577



1/4 in

118 mm

36 mm

122 mm

5 BE-8577

ERGO™ Bit Holder Screwdriver with quick release system for 1/4" Hex Blades



BE-8575



1/4 in

122 mm

1 BE-8575

1/4" Hex Blades for Slotted Head Screw - 100 mm



8020-2P - 8252-2P

Hex Size	Hex Size	Quantity	Part Number
3.0 mm	0.5 mm	1	8020-2P
3.5 mm	0.6 mm	1	8030-2P
4.0 mm	0.8 mm	1	8040-2P
5.5 mm	1.0 mm	1	8242-2P
6.5 mm	1.2 mm	1	8252-2P

1/4" Hex Blades for Phillips Head Screw - 100 mm



8600-2P - 8630-2P

Hex Size	Quantity	Part Number
0	1	8600-2P
1	1	8610-2P
2	1	8620-2P
3	1	8630-2P

1/4" Hex Blades for Pozidriv Head Screw - 100 mm



8800-2P - 8830-2P

Hex Size	Quantity	Part Number
0	1	8800-2P
1	1	8810-2P
2	1	8820-2P
3	1	8830-2P



1/4" Hex Blades for TORX® Head Screw - 100 mm



8910-2P - 8940-2P



10	1	8910-2P	
15	1	8915-2P	
20	1	8920-2P	
25	1	8925-2P	
27	1	8927-2P	
30	1	8930-2P	
40	1	8940-2P	

1/4" Hex Blades for Phillips Head Screw - 300 mm



8610L-2P - 8620L-2P



1	1	8610L-2P	
2	1	8620L-2P	

1/4" Hex Blades for Hex Ball Head Screw - 100 mm



8703-2P - 8706-2P



3 mm	1	8703-2P	
4 mm	1	8704-2P	
5 mm	1	8705-2P	
6 mm	1	8706-2P	

1/4" Hex Blades for Pozidriv Head Screw - 300 mm



8810L-2P - 8820L-2P



1	1	8810L-2P	
2	1	8820L-2P	

1/4" Hex Blades for Slotted Head Screw - 300 mm



8040L-2P - 8252L-2P



0.8 mm	4.0 mm	1	8040L-2P
1.0 mm	5.5 mm	1	8242L-2P
1.2 mm	6.5 mm	1	8252L-2P

1/4" Hex Blades for TORX® Head Screw - 300 mm



8915L-2P - 8930L-2P



T15	1	8915L-2P	
T20	1	8920L-2P	
T25	1	8925L-2P	
T27	1	8927L-2P	
T30	1	8930L-2P	

1/4" Hex Blades for Phillips Head Screw - 400 mm



8620XL-1P - 8252XL-1P



2	1	8620XL-1P
3	1	8630XL-1P

1/4" Hex Blades for Pozidriv Head Screw - 400 mm



8820XL-1P - 8830XL-1P



2	1	8820XL-1P
3	1	8830XL-1P

1/4" Hex Blades for Slotted Head Screw - 400 mm



8252XL-1P - 8256XL-1P



1.2 mm	6.5 mm	1	8252XL-1P
--------	--------	---	-----------

ERGO™ Bit Holder Screwdrivers with quick release system and Interchangeable Blades Set - 7 Pcs



BE-8571



7	85 x 85 x 210 mm	1	BE-8571
---	------------------	---	---------

BE-8575

8242-2P, 8252-2P

8610-2P, 8620-2P

8810-2P, 8820-2P



ERGO™ Bit Holder Screwdriver with quick release system and Interchangeable Blades Set - 9 Pcs



BE-8572

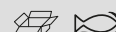

9	85 x 80 x 210 mm	1	BE-8572
---	------------------	---	---------

BE-8575

8242-2P, 8252-2P

8610-2P, 8620-2P

8810-2P, 8820-2P

8910-2P, 8915-2P



ERGO™ Bit Holder Screwdrivers with quick release system and TORX® Interchangeable Blades Set - 8 Pcs



BE-8573



8	85 x 85 x 210 mm	1	BE-8573

BE-8575		
8910-2P, 8915-2P, 8920-2P, 8925-2P, 8927-2P, 8930-2P, 8940-2P		

ERGO™ Bit Holder Screwdrivers with quick release bit holder and Interchangeable Blades Set - 8 Pcs



BE-8574



8	85 x 85 x 210 mm	1	BE-8574

BE-8575		
8610-2P, 8620-2P		
8040-2P		
8820-2P		
8920-2P, 8925-2P, 8930-2P		

ERGO™ Bit Holder Screwdriver with quick release system and Interchangeable Blades/Bits Set - 22 Pcs



BE-8576

23	1	BE-8576

BE-8575		
8030-2P, 8040-2P, 8242-2P, 8252-2P		
8810-2P, 8820-2P, 8830-2P		
8610-2P, 8620-2P, 8630-2P		
8910-2P, 8915-2P, 8925-2P, 8930-2P, 8940-2P		
59S/H2, 59S/H3, 59S/H5, 59S/H4, 59S/H6, 59S/H8		

ERGO™ SCREWDRIVERS WITH IMPACT GRIP

ERGO™ Through Blade Slotted Screwdrivers with Impact Grip 3.5-6.5 mm



BE-8135TB - BE-8262TB



3.5 mm	75 mm	27 mm	122 mm	10	BE-8135TB	
4.5 mm	100 mm	27 mm	122 mm	10	BE-8145TB	
5.5 mm	100 mm	27 mm	122 mm	10	BE-8150TB	
6.5 mm	125 mm	36 mm	122 mm	5	BE-8155TB	
8 mm	150 mm	36 mm	122 mm	10	BE-8256TB	
10 mm	175 mm	36 mm	122 mm	10	BE-8258TB	
12 mm	200 mm	36 mm	122 mm	10	BE-8262TB	
3.5 mm	75 mm	27 mm	122 mm	1	SBE-8135TB	
4.5 mm	100 mm	27 mm	122 mm	1	SBE-8145TB	
5.5 mm	100 mm	27 mm	122 mm	1	SBE-8150TB	
6.5 mm	125 mm	36 mm	122 mm	1	SBE-8155TB	

ERGO™ Through Blade Phillips Screwdrivers with Impact Grip PH1-PH4



BE-8610TB - BE-8624TB



PH 1	100 mm	27 mm	122 mm	10	BE-8610TB
PH 2	125 mm	36 mm	122 mm	10	BE-8620TB
PH 3	150 mm	36 mm	122 mm	10	BE-8623TB
PH 4	175 mm	36 mm	122 mm	10	BE-8624TB
PH 1	100 mm	27 mm	122 mm	1	SBE-8610TB
PH 2	125 mm	36 mm	122 mm	1	SBE-8620TB

ERGO™ Through Blade Pozidriv Screwdrivers with Impact Grip PZ1-PZ4



BE-8810TB - BE-8824TB

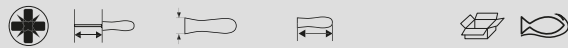

PZ 1	100 mm	27 mm	122 mm	10	BE-8810TB
PZ 2	125 mm	36 mm	122 mm	10	BE-8820TB
PZ 3	150 mm	36 mm	122 mm	10	BE-8823TB
PZ 4	175 mm	36 mm	122 mm	10	BE-8824TB
PZ 1	100 mm	27 mm	122 mm	1	SBE-8810TB
PZ 2	125 mm	36 mm	122 mm	1	SBE-8820TB

ERGO™ Through Blade TORX® Screwdrivers with Impact Grip T10-T40



BE-8910TB - BE-8940TB



T 10	75 mm	27 mm	122 mm	5	BE-8910TB
T 15	100 mm	27 mm	122 mm	5	BE-8915TB
T 20	100 mm	27 mm	122 mm	5	BE-8920TB

T 25	100 mm	27 mm	122 mm	5	BE-8925TB
T 27	125 mm	27 mm	122 mm	5	BE-8927TB
T 30	150 mm	36 mm	122 mm	5	BE-8930TB
T 40	150 mm	36 mm	122 mm	5	BE-8940TB
T 15	100 mm	27 mm	122 mm	1	SBE-8915TB
T 20	100 mm	27 mm	122 mm	1	SBE-8920TB
T 25	100 mm	27 mm	122 mm	1	SBE-8925TB
T 30	150 mm	36 mm	122 mm	1	SBE-8930TB
T 40	150 mm	36 mm	122 mm	1	SBE-8940TB

ERGO™ Through Blade Slotted/Phillips/Hex Screwdriver Set with Impact Grip - 6 Pcs



BE-9881TB



6

1 BE-9881TB

BE-8135TB, BE-8145TB, BE-8150TB, BE-8155TB



BE-8610TB, BE-8620TB



ERGO™ Through Blade Slotted/Pozidriv/Hex Screwdriver Set with Impact Grip - 6 Pcs



BE-9882TB



6

1 BE-9882TB

BE-8135TB, BE-8145TB, BE-8150TB, BE-8155TB



BE-8610TB, BE-8620TB



ERGO™ Through Blade TORX®/Hex Screwdriver Set with Impact Grip - 5 Pcs



BE-9885TB



5

1 BE-9885TB

BE-8915TB, BE-8920TB, BE-8925TB, BE-8930TB, BE-8940TB



BAHCOFIT SCREWDRIVERS WITH GROOVED RUBBER GRIP

BahcoFit Slotted Flat Screwdrivers with Rubber Grip 4.0-14 mm



B190



4 mm	75 mm	24,5 mm	95 mm	10	B190.040.075
4 mm	100 mm	24,5 mm	95 mm	10	B190.040.100
5.5 mm	100 mm	30 mm	105 mm	10	B190.055.100
5.5 mm	125 mm	30 mm	105 mm	10	B190.055.125
6.5 mm	125 mm	34 mm	117 mm	10	B190.065.125
6.5 mm	150 mm	34 mm	117 mm	10	B190.065.150
8 mm	150 mm	34 mm	117 mm	10	B190.080.150
8 mm	175 mm	34 mm	117 mm	10	B190.080.175
10 mm	200 mm	34 mm	117 mm	10	B190.100.200
12 mm	250 mm	34 mm	117 mm	10	B190.120.250
14 mm	250 mm	34 mm	117 mm	10	B190.140.250
4 mm	75 mm	24,5 mm	95 mm	1	SB190.040.075
4 mm	100 mm	24,5 mm	95 mm	1	SB190.040.100
5.5 mm	100 mm	30 mm	105 mm	1	SB190.055.100
5.5 mm	125 mm	30 mm	105 mm	1	SB190.055.125
6.5 mm	125 mm	34 mm	117 mm	1	SB190.065.125
6.5 mm	150 mm	34 mm	117 mm	1	SB190.065.150
8 mm	150 mm	34 mm	117 mm	1	SB190.080.150
8 mm	175 mm	34 mm	117 mm	1	SB190.080.175
10 mm	200 mm	34 mm	117 mm	1	SB190.100.200
12 mm	250 mm	34 mm	117 mm	1	SB190.120.250
14 mm	250 mm	34 mm	117 mm	1	SB190.140.250

BahcoFit Slotted Straight Screwdrivers with Rubber Grip 2.5-6.5 mm



B191



2.5 mm	75 mm	24,5 mm	95 mm	10	B191.025.075
3 mm	75 mm	24,5 mm	95 mm	10	B191.030.075
3 mm	100 mm	24,5 mm	95 mm	10	B191.030.100
3 mm	200 mm	24,5 mm	95 mm	10	B191.030.200
3.5 mm	100 mm	24,5 mm	95 mm	10	B191.035.100
4 mm	100 mm	24,5 mm	95 mm	10	B191.040.100
4 mm	125 mm	24,5 mm	95 mm	10	B191.040.125
4 mm	250 mm	24,5 mm	95 mm	10	B191.040.250
5.5 mm	125 mm	30 mm	105 mm	10	B191.055.125
5.5 mm	150 mm	30 mm	105 mm	10	B191.055.150
5.5 mm	300 mm	30 mm	105 mm	10	B191.055.300
6.5 mm	150 mm	34 mm	117 mm	10	B191.065.150
6.5 mm	300 mm	34 mm	117 mm	10	B191.065.300
2.5 mm	75 mm	24,5 mm	95 mm	1	SB191.025.075
3 mm	75 mm	24,5 mm	95 mm	1	SB191.030.075
3 mm	100 mm	24,5 mm	95 mm	1	SB191.030.100
3 mm	200 mm	24,5 mm	95 mm	1	SB191.030.200
3.5 mm	100 mm	24,5 mm	95 mm	1	SB191.035.100
4 mm	100 mm	24,5 mm	95 mm	1	SB191.040.100
4 mm	125 mm	24,5 mm	95 mm	1	SB191.040.125
4 mm	250 mm	24,5 mm	95 mm	1	SB191.040.250
5.5 mm	125 mm	30 mm	105 mm	1	SB191.055.125
5.5 mm	150 mm	30 mm	105 mm	1	SB191.055.150
5.5 mm	300 mm	30 mm	105 mm	1	SB191.055.300
6.5 mm	150 mm	34 mm	117 mm	1	SB191.065.150
6.5 mm	300 mm	34 mm	117 mm	1	SB191.065.300

BahcoFit Stubby Slotted Straight Screwdrivers with Rubber Grip 4.0-6.0 mm



B195



4 mm	25 mm	33 mm	60 mm	10	B195.040.025
5.0 mm	25 mm	33 mm	60 mm	10	B195.050.025
6 mm	25 mm	33 mm	60 mm	10	B195.060.025
4 mm	25 mm	33 mm	60 mm	1	SB195.040.025
5 mm	25 mm	33 mm	60 mm	1	SB195.050.025
6 mm	25 mm	33 mm	60 mm	1	SB195.060.025

BahcoFit Phillips Screwdrivers with Rubber Grip PH0-PH4



B192



PH0	75 mm	24,5 mm	95 mm	10	B192.000.075
PH0	200 mm	24,5 mm	95 mm	10	B192.000.200
PH1	100 mm	30 mm	105 mm	10	B192.001.100
PH1	250 mm	30 mm	105 mm	10	B192.001.250
PH2	125 mm	34 mm	117 mm	10	B192.002.125
PH2	150 mm	34 mm	117 mm	10	B192.002.150
PH2	300 mm	34 mm	117 mm	10	B192.002.300
PH3	150 mm	34 mm	117 mm	10	B192.003.150
PH4	200 mm	34 mm	117 mm	10	B192.004.200
PH0	75 mm	24,5 mm	95 mm	1	SB192.000.075
PH0	200 mm	24,5 mm	95 mm	1	SB192.000.200
PH1	100 mm	30 mm	105 mm	1	SB192.001.100
PH1	250 mm	30 mm	105 mm	1	SB192.001.250
PH2	125 mm	34 mm	117 mm	1	SB192.002.125
PH2	300 mm	34 mm	117 mm	1	SB192.002.300
PH3	150 mm	34 mm	117 mm	1	SB192.003.150
PH4	200 mm	34 mm	117 mm	1	SB192.004.200

BahcoFit Pozidriv Screwdrivers with Rubber Grip PZ0-PZ4



B193



PZ0	75 mm	24,5 mm	95 mm	10	B193.000.075
PZ1	100 mm	30 mm	105 mm	10	B193.001.100
PZ2	125 mm	34 mm	117 mm	10	B193.002.125
PZ3	150 mm	34 mm	117 mm	10	B193.003.150
PZ4	200 mm	34 mm	117 mm	10	B193.004.200
PZ0	75 mm	24,5 mm	95 mm	1	SB193.000.075
PZ1	100 mm	30 mm	105 mm	1	SB193.001.100
PZ2	125 mm	34 mm	117 mm	1	SB193.002.125
PZ3	150 mm	34 mm	117 mm	1	SB193.003.150
PZ4	200 mm	34 mm	117 mm	1	SB193.004.200

BahcoFit Stubby Phillips Screwdrivers with Rubber Grip PH1-PH2



B195PH



PH1	25 mm	33 mm	60 mm	10	B195.001.025
PH2	25 mm	33 mm	60 mm	10	B195.002.025
PH1	25 mm	33 mm	60 mm	1	SB195.001.025
PH2	25 mm	33 mm	60 mm	1	SB195.002.025

BahcoFit Stubby Pozidriv Screwdrivers with Rubber Grip PZ1-PZ2



B195PZ



PZ1	25 mm	33 mm	60 mm	10	B195.901.025
PZ2	25 mm	33 mm	60 mm	10	B195.902.025
PZ1	25 mm	33 mm	60 mm	1	SB195.901.025
PZ2	25 mm	33 mm	60 mm	1	SB195.902.025



BahcoFit TORX® Screwdrivers with Rubber Grip T4-T45



B194

T4	75 mm	24,5 mm	95 mm	10	B194.004.075	
T5	75 mm	24,5 mm	95 mm	10	B194.005.075	
T6	75 mm	24,5 mm	95 mm	10	B194.006.075	
T7	75 mm	24,5 mm	95 mm	10	B194.007.075	
T8	75 mm	24,5 mm	95 mm	10	B194.008.075	
T9	75 mm	24,5 mm	95 mm	10	B194.009.075	
T10	75 mm	24,5 mm	95 mm	10	B194.010.075	
T15	100 mm	24,5 mm	95 mm	10	B194.015.100	
T20	100 mm	24,5 mm	95 mm	10	B194.020.100	
T25	125 mm	30 mm	105 mm	10	B194.025.125	
T27	125 mm	30 mm	105 mm	10	B194.027.125	
T30	150 mm	34 mm	117 mm	10	B194.030.150	
T40	150 mm	34 mm	117 mm	10	B194.040.150	
T45	150 mm	34 mm	117 mm	5	B194.045.150	
T4	75 mm	24,5 mm	95 mm	1	SB194.004.075	
T5	75 mm	24,5 mm	95 mm	1	SB194.005.075	
T6	75 mm	24,5 mm	95 mm	1	SB194.006.075	
T7	75 mm	24,5 mm	95 mm	1	SB194.007.075	
T8	75 mm	24,5 mm	95 mm	1	SB194.008.075	
T9	75 mm	24,5 mm	95 mm	1	SB194.009.075	
T10	75 mm	24,5 mm	95 mm	1	SB194.010.075	
T15	100 mm	24,5 mm	95 mm	1	SB194.015.100	
T20	100 mm	24,5 mm	95 mm	1	SB194.020.100	
T25	125 mm	30 mm	105 mm	1	SB194.025.125	
T27	125 mm	30 mm	105 mm	1	SB194.027.125	
T30	150 mm	34 mm	117 mm	1	SB194.030.150	
T40	150 mm	34 mm	117 mm	1	SB194.040.150	
T45	150 mm	34 mm	117 mm	1	SB194.045.150	

BahcoFit Tamper-Resistant TORX® Screwdrivers with Rubber Grip TR7-TR40



B141

TR7	75 mm	24,5 mm	95 mm	5	B141.007.075	
TR8	75 mm	24,5 mm	95 mm	5	B141.008.075	
TR9	75 mm	24,5 mm	95 mm	5	B141.009.075	
TR10	75 mm	24,5 mm	95 mm	5	B141.010.075	
TR15	100 mm	24,5 mm	95 mm	5	B141.015.100	
TR20	100 mm	24,5 mm	95 mm	5	B141.020.100	
TR25	125 mm	30 mm	105 mm	5	B141.025.125	
TR27	125 mm	30 mm	105 mm	5	B141.027.125	
TR30	150 mm	34 mm	117 mm	5	B141.030.150	
TR40	150 mm	34 mm	117 mm	5	B141.040.150	

TR7	75 mm	24,5 mm	95 mm	1	SB141.007.075	
TR8	75 mm	24,5 mm	95 mm	1	SB141.008.075	
TR9	75 mm	24,5 mm	95 mm	1	SB141.009.075	
TR10	75 mm	24,5 mm	95 mm	1	SB141.010.075	
TR15	100 mm	24,5 mm	95 mm	1	SB141.015.100	
TR20	100 mm	24,5 mm	95 mm	1	SB141.020.100	
TR25	125 mm	30 mm	105 mm	1	SB141.025.125	
TR27	125 mm	30 mm	105 mm	1	SB141.027.125	
TR30	150 mm	34 mm	117 mm	1	SB141.030.150	
TR40	150 mm	34 mm	117 mm	1	SB141.040.150	

BahcoFit Hex Ball End Screwdrivers with Rubber Grip Hex2-8 mm



B143

2	100 mm	24,5 mm	95 mm	5	B143.020.100	
2,5	100 mm	24,5 mm	95 mm	10	B143.025.100	
3	100 mm	24,5 mm	95 mm	10	B143.030.100	
4	100 mm	24,5 mm	95 mm	10	B143.040.100	
5	100 mm	30 mm	105 mm	10	B143.050.100	
6	125 mm	34 mm	117 mm	10	B143.060.125	
8	150 mm	34 mm	117 mm	5	B143.080.150	
2	100 mm	24,5 mm	95 mm	1	SB143.020.100	
2,5	100 mm	24,5 mm	95 mm	1	SB143.025.100	
3	100 mm	24,5 mm	95 mm	1	SB143.030.100	
4	100 mm	24,5 mm	95 mm	1	SB143.040.100	
5	100 mm	30 mm	105 mm	1	SB143.050.100	
6	125 mm	34 mm	117 mm	1	SB143.060.125	
8	150 mm	34 mm	117 mm	1	SB143.080.150	

BahcoFit Robertson Square Screwdrivers with Rubber Grip #1-#3



B144

#1	100 mm	24,5 mm	95 mm	5	B144.001.100	
#2	125 mm	30 mm	105 mm	5	B144.002.125	
#3	150 mm	34 mm	117 mm	5	B144.003.150	
#1	100 mm	24,5 mm	95 mm	1	SB144.001.100	
#2	125 mm	30 mm	105 mm	1	SB144.002.125	
#3	150 mm	34 mm	117 mm	1	SB144.003.150	

BahcoFit Awl with Rubber Grip for Pre-Punching/Drilling Holes 6 mm



B145

Ø	Length	Tip Length	Tip Dia	Weight	Part No.
6 mm	100 mm	30 mm	105 mm	5	B145.006.100
6 mm	100 mm	30 mm	105 mm	1	SB145.006.100

BahcoFit Reamers with Rubber Grip for Enlarging/Drilling Holes 6 mm



B146

Ø	Length	Tip Length	Tip Dia	Weight	Part No.
6 mm	100 mm	30 mm	105 mm	5	B146.006.100
6 mm	100 mm	30 mm	105 mm	1	SB146.006.100

BahcoFit Stubby Awl with Rubber Grip 6 mm



B195Awl

Ø	Length	Tip Length	Tip Dia	Weight	Part No.
4 mm	50 mm	33 mm	60 mm	5	B195.006.050
4 mm	50 mm	33 mm	60 mm	1	SB195.006.050

BahcoFit Hex Head Nut Drivers with Rubber Grip 4-14 mm



B198

Hex Size	Length	Tip Length	Tip Dia	Weight	Part No.
4 mm	125 mm	24,5 mm	95 mm	5	B198.040.125
4,5 mm	125 mm	24,5 mm	95 mm	5	B198.045.125
5 mm	150 mm	30 mm	105 mm	5	B198.050.150
5,5 mm	150 mm	30 mm	105 mm	5	B198.055.150
6 mm	150 mm	30 mm	105 mm	5	B198.060.150
6 mm	150 mm	34 mm	117 mm	5	B198.060.150F
7 mm	150 mm	34 mm	117 mm	5	B198.070.150
7 mm	150 mm	34 mm	117 mm	5	B198.070.150F
8 mm	150 mm	34 mm	117 mm	5	B198.080.150
8 mm	150 mm	34 mm	117 mm	5	B198.080.150F
9 mm	150 mm	34 mm	117 mm	5	B198.090.150
10 mm	150 mm	34 mm	117 mm	5	B198.100.150
11 mm	150 mm	34 mm	117 mm	5	B198.110.150
12 mm	150 mm	34 mm	117 mm	5	B198.120.150
13 mm	150 mm	34 mm	117 mm	5	B198.130.150
14 mm	150 mm	34 mm	117 mm	5	B198.140.150
4 mm	125 mm	24,5 mm	95 mm	1	SB198.040.125
4,5 mm	125 mm	24,5 mm	95 mm	1	SB198.045.125
5 mm	150 mm	30 mm	105 mm	1	SB198.050.150
5,5 mm	150 mm	30 mm	105 mm	1	SB198.055.150
6 mm	150 mm	30 mm	105 mm	1	SB198.060.150
6 mm	150 mm	34 mm	117 mm	1	SB198.060.150F
7 mm	150 mm	34 mm	117 mm	1	SB198.070.150
7 mm	150 mm	34 mm	117 mm	1	SB198.070.150F
8 mm	150 mm	34 mm	117 mm	1	SB198.080.150
8 mm	150 mm	34 mm	117 mm	1	SB198.080.150F
9 mm	150 mm	34 mm	117 mm	1	SB198.090.150
10 mm	150 mm	34 mm	117 mm	1	SB198.100.150
11 mm	150 mm	34 mm	117 mm	1	SB198.110.150
12 mm	150 mm	34 mm	117 mm	1	SB198.120.150
13 mm	150 mm	34 mm	117 mm	1	SB198.130.150
14 mm	150 mm	34 mm	117 mm	1	SB198.140.150

BahcoFit Slotted/Phillips Screwdriver Set with Rubber Grip - 2 Pcs



B219.002

Icon	Weight	Part No.
X	2	B219.002

B191.040.100

B192.001.100



BahcoFit Slotted/Phillips Screwdriver Set with Rubber Grip - 2 Pcs



B219.012



2

1 B219.012

B190.055.125



B192.002.125



BahcoFit Slotted/Phillips Screwdriver Set with Rubber Grip - 4 Pcs



B219.004



4

1 B219.004

B191.030.100, B191.055.125



B192.001.100, B192.002.125



BahcoFit Slotted/Phillips Screwdriver Set with Rubber Grip - 5 Pcs



B219.005



5

1 B219.005

B191.030.075, B191.040.100



B190.055.125



B192.001.100, B192.002.125



BahcoFit Slotted/Pozidriv Screwdriver Set with Rubber Grip - 5 Pcs



B219.015



5

1 B219.015

B191.030.075, B191.040.100



B190.055.125



B193.001.100, B193.002.125



BahcoFit TORX® Screwdriver Set with Rubber Grip - 5 Pcs



B219.025



5

1 B219.025

B194.010.075, B194.015.100, B194.020.100, B194.025.125,
B194.030.150



BahcoFit Tamper-Resistant TORX® Screwdriver Set with Rubber Grip - 5 Pcs



B219.035



5

1 B219.035

B141.010.075, B141.015.100, B141.020.100, B141.025.125, B141.030.150



BahcoFit Slotted/Phillips Screwdriver Set with Rubber Grip - 6 Pcs



B219.006



6

1 B219.006

B191.030.075, B191.040.100



B190.055.125, B190.065.125



B192.001.100, B192.002.125



BahcoFit Slotted/Pozidriv Screwdriver Set with Rubber Grip - 6 Pcs



B219.016



6

1 B219.016

B191.030.075, B191.040.100



B190.055.125, B190.065.125



B193.001.100, B193.002.125



BahcoFit Slotted/Phillips/Pozidriv Screwdriver Set with Rubber Grip - 6 Pcs



B219.026



6

1 B219.026

B191.030.075, B191.040.100



B192.001.100, B192.002.125

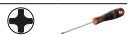

B193.001.100, B193.002.125



BahcoFit Pozidriv/TORX® Screwdriver Set with Rubber Grip - 7 Pcs



B219.007



7

1 B219.007

B193.001.100, B193.002.125



B194.010.075, B194.015.100, B194.020.100, B194.025.125, B194.030.150



BahcoFit Slotted/Phillips Screwdriver Set with Rubber Grip - 7 Pcs



B219.017



7

1 B219.017

B191.035.100, B191.040.100



B190.055.125, B190.065.150, B190.080.175



B192.001.100, B192.002.125



BahcoFit TORX® Screwdriver Set with Rubber Grip - 7 Pcs



B219.027



7

1 B219.027

B194.010.075, B194.015.100, B194.020.100, B194.025.125,
B194.027.125, B194.030.150, B194.040.150



BahcoFit Slotted/Phillips Screwdriver Set with Rubber Grip - 8 Pcs



B219.008



8

1 B219.008

B191.040.100, B191.055.125



B190.065.150, B190.080.175



B192.001.100, B192.002.125



B195.060.025



B195.002.025



BahcoFit Slotted/Phillips/Pozidriv/TORX® Screwdriver Set with Rubber Grip - 10 Pcs



B219.110



10

1 B219.110

B190.055.100



B192.002.125



B193.002.125



B194.010.075, B194.015.100, B194.020.100



B196.025.075, B196.040.100



B142.001.080



806-1-1



BahcoFit Torx® Screwdriver Set with Rubber Grip - 10 pcs



B219.210



10	4.5 x 33 x 17 mm	1	B219.210

B194.006.075, B194.008.075, B194.009.075, B194.010.075,
B194.015.100, B194.020.100, B194.025.125, B194.027.125,
B194.030.150, B194.040.150



BahcoFit Slotted/Phillips/Pozidriv/Robertson Screwdriver Set with Rubber Grip - 10 Pcs



B219.010



10	1	B219.010

B191.030.075



B190.055.100, B190.065.125, B190.080.150



B192.001.100, B192.002.125, B192.003.150

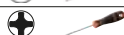

B195.902.025



B144.001.100, B144.002.125



SCREWDRIVERS WITH RUBBERED GRIP

Slotted Flat Screwdrivers with Rubber Grip 3.5-10 mm



611



3.5 mm	75 mm	25 mm	80 mm	10	611-3.5-75
3.5 mm	100 mm	25 mm	80 mm	10	611-3.5-100
4.0 mm	75 mm	25 mm	80 mm	10	611-4-75
4.0 mm	100 mm	25 mm	80 mm	10	611-4-100
5.5 mm	100 mm	30 mm	97 mm	10	611-5.5-100
5.5 mm	125 mm	30 mm	97 mm	10	611-5.5-125
6.5 mm	25 mm	35 mm	60 mm	10	611-6.5-25
6.5 mm	125 mm	35 mm	110 mm	10	611-6.5-125
6.5 mm	150 mm	35 mm	110 mm	10	611-6.5-150
8.0 mm	150 mm	35 mm	110 mm	10	611-8-150
8.0 mm	175 mm	35 mm	110 mm	10	611-8-175
10.0 mm	200 mm	35 mm	110 mm	10	611-10-200

Slotted Straight Screwdrivers with Rubber Grip 3.0 -6.5 mm



613



3.0 mm	75 mm	25 mm	80 mm	10	613-3-75
3.0 mm	100 mm	25 mm	80 mm	10	613-3-100
3.5 mm	100 mm	25 mm	80 mm	10	613-3.5-100
4.0 mm	100 mm	25 mm	80 mm	10	613-4-100
4.0 mm	125 mm	25 mm	80 mm	10	613-4-125
5.5 mm	150 mm	30 mm	97 mm	10	613-5.5-150
6.5 mm	150 mm	35 mm	110 mm	10	613-6.5-150



Phillips Screwdrivers with Rubbered Grip PH0-PH3



615



PH 0	75 mm	25 mm	80 mm	10	615-0-75
PH 1	100 mm	30 mm	97 mm	10	615-1-100
PH 2	25 mm	35 mm	60 mm	10	615-2-25
PH 2	125 mm	35 mm	110 mm	10	615-2-125
PH 3	150 mm	35 mm	110 mm	10	615-3-150

Pozidriv Screwdrivers with Rubbered Grip PZ0-PZ3



616



PZ 0	75 mm	25 mm	80 mm	10	616-0-75
PZ 1	100 mm	30 mm	97 mm	10	616-1-100
PZ 2	125 mm	35 mm	110 mm	10	616-2-125
PZ 3	150 mm	35 mm	110 mm	10	616-3-150

TORX® Screwdrivers with Rubber Grip T10-T40



618



T 10	75 mm	25 mm	80 mm	10	618-10-75
T 15	100 mm	25 mm	80 mm	10	618-15-100
T 20	100 mm	25 mm	80 mm	10	618-20-100
T 25	125 mm	30 mm	97 mm	10	618-25-125
T 27	125 mm	30 mm	97 mm	10	618-27-125
T 30	150 mm	35 mm	110 mm	10	618-30-150
T 40	150 mm	35 mm	110 mm	10	618-40-150

Slotted/Phillips Screwdriver Set with Rubber Grip - 3 Pcs



600-3



3	1	600-3

613-3-100



611-5.5-125



615-1-100



Slotted/Phillips Screwdriver Set with Rubber Grip - 4 Pcs



602-4-LA



4	1	602-4-LA

613-3-100



611-5.5-100



615-1-100, 615-2-125



Slotted/Phillips Screwdriver Set with Rubber Grip - 5 Pcs



604-5



5	1	604-5

613-3-100



611-4-100, 611-6.5-125



615-1-100, 615-2-125



TORX® Screwdriver Set with Rubber Grip - 5 Pcs



612-5



5

1 612-5

618-10-75, 618-15-100, 618-20-100, 618-25-125, 618-30-150



Slotted/Phillips/Pozidriv Screwdriver Set with Rubber Grip 3-4 mm/ PH1-PH2/PZ1-PZ2 - 6 Pcs



605-6



6

1 605-6

613-3-75, 613-4-100



615-1-100, 615-2-125



616-1-100, 616-2-125

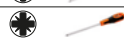

Slotted/Phillips Screwdriver Set with Rubber Grip 5.5-6.5 mm/3-4 mm/ PH1-PH2 - 6 Pcs



606-6



6

1 606-6

611-5.5-100, 611-6.5-125



613-3-75, 613-4-100



615-1-100, 615-2-125



Slotted/Pozidriv Screwdriver Set with Rubber Grip - 6 Pcs



610-6



6

1 610-6

611-5.5-100, 611-6.5-125



613-3-75, 613-4-100



616-1-100, 616-2-125

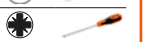

Slotted/Phillips/Robertson Screwdriver Set with Rubber Grip - 10 Pcs



605-10-PC-AU

10			1 605-10-PC-AU

Robertson R1x100; R2x100; Stubby PZ2 X 25

611-5.5-100, 611-6.5-125, 611-8-150	
613-3-75	
615-1-100, 615-2-125, 615-3-150	

SCREWDRIVERS WITH RATCHETING GRIP

1/4" Bit Holder Ratcheting Screwdrivers



808050

1/4"	125 mm	41,6 mm 123 mm
		50 808050

1/4" Heavy-Duty Bit Set for Nut Drivers & Slotted/Phillips/Pozidriv/Torx®/Hex Bits with Ratcheting Screwdriver Holder - 36 pcs



59/S36BCR

36	43 x 135 x 215 mm		6 59/S36BCR

Phillips/Pozidriv/Slotted LED Light Ratcheting Screwdriver with Ratcheting Grip



808050L

1/4 in	10x35 mm		25 808050L
		808050L	1 808050L-SP1

1/4" Ratcheting Bit Screwdriver with Pistol Handle



808050P

1/4 in	135 mm	40 mm 125 mm	50 808050P

1/4" Ratcheting Bit Screwdriver Set with Pistol Handle - 25 Pcs



808050P-



70 x 158 x 285 mm



10 808050P-25

1/4" Bit Holder Stubby T-Handle Ratcheting Screwdrivers



808050TS



1/4 in 68 mm 91 mm 63.5 mm 1 808050TS

1/4" Bit Holder Stubby Ratcheting Screwdrivers



808050S



1/4 in 68 mm 41 mm 69 mm 25 808050S

Stubby Ratcheting Screwdriver Set - 18 Pcs



808050S-18



46 x 130 x 195 mm

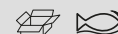

30 808050S-18

Stubby Ratcheting Screwdriver Set - 22-Pcs



808050S-22



46 x 130 x 195 mm



30 808050S-22



SCREWDRIVERS WITH PRECISION GRIP

Slotted Screwdrivers with Precision Grip 1.0-4.0 mm



700

Tip Size	Length	Shaft Dia	Tip Length	Part No.
1 mm	50 mm	14 mm	87 mm	5 700-1-50
1.2 mm	50 mm	14 mm	87 mm	5 700-1.2-50
1.5 mm	50 mm	14 mm	87 mm	5 700-1.5-50
1.8 mm	50 mm	14 mm	87 mm	5 700-1.8-50
2 mm	50 mm	14 mm	87 mm	5 700-2-50
2.5 mm	50 mm	14 mm	87 mm	5 700-2.5-50
3 mm	50 mm	14 mm	87 mm	5 700-3-50
3 mm	100 mm	14 mm	87 mm	5 700-3-100
3 mm	200 mm	14 mm	87 mm	5 700-3-200
3.5 mm	75 mm	14 mm	87 mm	5 700-3.5-75
4 mm	75 mm	14 mm	87 mm	5 700-4-75
4 mm	250 mm	14 mm	87 mm	5 700-4-250

Phillips Screwdrivers with Precision Grip PH00-PH1



701

Tip Size	Length	Shaft Dia	Tip Length	Part No.
PH 00	50 mm	14 mm	87 mm	5 701-00-50
PH 0	50 mm	14 mm	87 mm	5 701-0-50
PH 0	200 mm	14 mm	87 mm	5 701-0-200
PH 1	75 mm	14 mm	87 mm	5 701-1-75
PH 1	250 mm	14 mm	87 mm	5 701-1-250

Pozidriv Screwdrivers with Precision Grip PZ0-PZ1



702

Tip Size	Length	Shaft Dia	Tip Length	Part No.
PZ 0	50 mm	14 mm	87 mm	5 702-0-50
PZ 1	75 mm	14 mm	87 mm	5 702-1-75

TORX® Screwdrivers with Precision Grip T4-T20



703

Tip Size	Length	Shaft Dia	Tip Length	Part No.
T 4	50 mm	14 mm	87 mm	5 703-4-50
T 5	50 mm	14 mm	87 mm	5 703-5-50
T 6	50 mm	14 mm	87 mm	5 703-6-50
T 7	50 mm	14 mm	87 mm	5 703-7-50
T 8	50 mm	14 mm	87 mm	5 703-8-50
T 9	50 mm	14 mm	87 mm	5 703-9-50
T 10	50 mm	14 mm	87 mm	5 703-10-50
T 15	75 mm	14 mm	87 mm	5 703-15-75
T 20	75 mm	14 mm	87 mm	5 703-20-75

Hex Ball Screwdrivers with Precision Grip 1.5-3 mm 3/32"



704

Tip Size	Length	Shaft Dia	Tip Length	Part No.
1.5	50 mm	14 mm	87 mm	5 704-1.5-50
2	50 mm	14 mm	87 mm	5 704-2-50
2.5	50 mm	14 mm	87 mm	5 704-2.5-50
3	75 mm	14 mm	87 mm	5 704-3-75
3/32	75 mm	14 mm	87 mm	5 704Z-3/32

Slotted/Phillips Screwdriver Set with Precision Grip 1.5-3.0mm/PH0-PH1 - 6 Pcs



706-1

Tip Size	Length	Shaft Dia	Tip Length	Part No.
X	50 mm	14 mm	87 mm	5 706-1-50

6

1 706-1

Slotted/Phillips/TORX® Screwdriver Set with Precision Grip - 7 Pcs



706-4

☒ X
📦
🐟
⊕
⊖
⊛

7 1 706-4

700-2.5-50, 700-3.5-75, 700-1.5-50

701-1-75, 701-0-50

703-8-50, 703-6-50

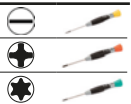

Slotted/Phillips/Pozidriv/TORX/Hex Screwdriver Set with Precision Grip - 24 Pcs



706-5

☒ X
📦
🐟
⊕
⊖
⊛
⊞

24 1 706-5

700-3-50, 700-2-50, 700-3.5-75, 700-4-75, 700-1.5-50, 700-1.2-50, 700-1-50, 700-1.8-50

701-00-50, 701-0-50, 701-1-75

702-1-75, 702-0-50

703-6-50, 703-9-50, 703-10-50, 703-7-50, 703-8-50, 703-15-75, 703-20-75

704-2.5-50, 704-3-75, 704-1.5-50, 704-2-50

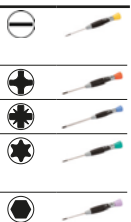

700-2-50, 700-2.5-50, 700-1.5-50, 700-3-50

701-0-50, 701-1-75



Slotted/Phillips Screwdriver Set with Precision Grip 1.0-1.8 mm/PH00-PH0 - 6 Pcs



706-2

☒ X
📦
🐟
⊕
⊖

6 1 706-2

700-1.5-50, 700-1.2-50, 700-1-50, 700-1.8-50

701-00-50, 701-0-50

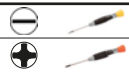

Slotted Screwdriver Set with Precision Grip 1.0 - 2.5 mm - 6 Pcs



706-3

☒ X
📦
🐟
⊖

6 1 706-3

700-2.5-50, 700-2-50, 700-1.8-50, 700-1.5-50, 700-1.2-50, 700-1-50



Watchmakers Slotted Screwdrivers with Precision Grip and 4 Interchangeable Blades



510034

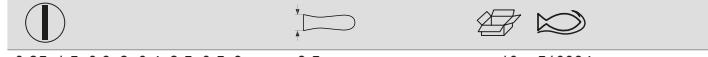

0.25x1.5; 0.3x2; 0.4x2.5; 0.5x3 8,5 mm 10 510034

0.25x1.5; 0.3x2.0; 0.4x2.5; 0.5x3.0mm

Watchmakers Slotted Screwdrivers with Precision Grip 2.5-4.5 mm



2784



2.5 mm	6 mm	100 mm	1	2784-2.5
3.5 mm	6 mm	104 mm	1	2784-3.5
4.5 mm	10 mm	110 mm	1	2784-4.5

Watchmakers Slotted Screwdriver Set with Precision Grip 0.6-2.5 mm - 5 Pcs



98505

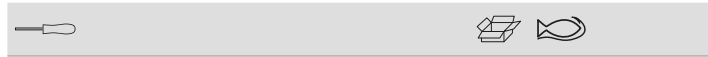

5 5 98505

0.6; 0.8; 1.0; 1.5; 2.5

Watchmakers Slotted Screwdriver Set with Precision Grip 1.0-3.5 mm - 6 Pcs



510031

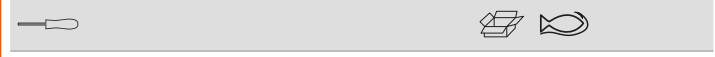

6 5 510031

1.0; 1.5; 2.0; 2.5; 3.0; 3.5

Watchmakers Phillips Screwdriver Set with Precision Grip PH000-PH0 - 3 Pcs



510033

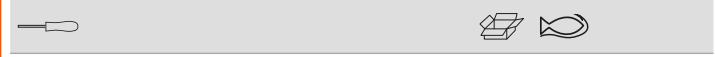

3 5 510033

PH000; PH00; PH0

SCREWDRIVERS WITH T-HANDLE GRIP

Hex Screwdrivers with T-Handle Grip 2-10 mm



900T



2 mm	100 mm	50 mm	85 mm	5	900T-020-100
2.5 mm	100 mm	50 mm	85 mm	5	900T-025-100
3 mm	100 mm	50 mm	85 mm	5	900T-030-100
4 mm	138 mm	50 mm	85 mm	5	900T-040-150

5 mm	138 mm	60 mm	105 mm	5	900T-050-150
6 mm	185 mm	60 mm	105 mm	5	900T-060-200
8 mm	185 mm	60 mm	105 mm	5	900T-080-200
10 mm	185 mm	60 mm	105 mm	5	900T-100-200

TORX® Screwdrivers with T-Handle Grip T6-T50



901T

T 6	100 mm	50 mm	85 mm	5	901T-006-100
T 7	100 mm	50 mm	85 mm	5	901T-007-100
T 8	100 mm	50 mm	85 mm	5	901T-008-100
T 9	100 mm	50 mm	85 mm	5	901T-009-100
T 10	100 mm	50 mm	85 mm	5	901T-010-100
T 15	138 mm	50 mm	85 mm	5	901T-015-150
T 20	138 mm	50 mm	85 mm	5	901T-020-150
T 25	138 mm	60 mm	105 mm	5	901T-025-150
T 27	138 mm	60 mm	105 mm	5	901T-027-150
T 30	185 mm	60 mm	105 mm	5	901T-030-200
T 40	185 mm	60 mm	105 mm	5	901T-040-200
T 45	185 mm	60 mm	105 mm	5	901T-045-200
T 50	185 mm	60 mm	105 mm	5	901T-050-200

Hex Head Nut Drivers with T-Handle Grip 5-13 mm



902T

5 mm	136 mm	50 mm	85 mm	5	902T-050-150
5.5 mm	136 mm	50 mm	85 mm	5	902T-055-150
6 mm	136 mm	50 mm	85 mm	5	902T-060-150
7 mm	160 mm	60 mm	105 mm	5	902T-070-175
8 mm	160 mm	60 mm	105 mm	5	902T-080-175
9 mm	160 mm	60 mm	105 mm	5	902T-090-175
10 mm	160 mm	60 mm	105 mm	5	902T-100-175
11 mm	160 mm	60 mm	105 mm	5	902T-110-175
12 mm	160 mm	60 mm	105 mm	5	902T-120-175
13 mm	160 mm	60 mm	105 mm	5	902T-130-175

Socket Drivers with T-Handle Grip 1/4"



905T

1/4"	45 mm	60 mm	105 mm	5	905T-060-100

Hex Screwdriver Set with T-Handle Grip - 6 Pcs



903T-1

6	X	1 903T-1

900T-030-100, 900T-040-150, 900T-050-150, 900T-060-200, 900T-080-200, 900T-100-200

TORX® Screwdriver Set with T-Handle Grip - 6 Pcs



903T-2

6	X	1 903T-2

901T-015-150, 901T-020-150, 901T-010-100, 901T-030-200, 901T-040-200, 901T-025-150



Hex Nut Driver Set with T-Handle Grip - 6 Pcs



903T-3

6	1	903T-3

902T-060-150, 902T-070-175, 902T-050-150, 902T-080-175, 902T-100-175, 902T-130-175

SCREWDRIVERS WITH 1/4" BIT HOLDERS

1/4" x 125 mm Magnetic Bit Holders



B705

1/4" in	125 mm	30 mm	105 mm	5	B705.1/4.125
1/4" in	125 mm	30 mm	105 mm	1	SB705.1/4.125

1/4" Hex Head T-Handle Bit Holders



904T

1/4 in	150 mm	5	904T-060-150

1/4" Bit Holder Screwdrivers for Phillips/Pozidriv/Slotted/TORX® Head Screw



808050A/TORX

1/4 in	115 mm	40 mm	115 mm	1	808050A
1/4 in	115 mm	40 mm	115 mm	50	808050TORX

SCREWDRIVERS WITH WOODEN OR PLASTIC GRIP

Slotted Flat Screwdrivers with Wooden Handle 3.5-10 mm



9710

3.5 mm	75 mm	22 mm	95 mm	10	9710-3.5-75
5.5 mm	100 mm	24 mm	100 mm	10	9710-5.5-100
6.5 mm	125 mm	27 mm	110 mm	10	9710-6.5-125
8.0 mm	150 mm	30 mm	120 mm	5	9710-8-150
10.0 mm	175 mm	32 mm	125 mm	5	9710-10-175

Phillips Screwdrivers with Wooden Handle PH1-PH3



9778

PH 1	80 mm	24 mm	100 mm	10	9778-1
PH 2	110 mm	27 mm	110 mm	10	9778-2
PH 3	150 mm	30 mm	120 mm	5	9778-3

Pozidriv Screwdrivers with Wooden Handle PZ1-PZ2



9778PZD

PZ 1	80 mm	24 mm	100 mm	10	9778PZD-1	
PZ 2	110 mm	27 mm	110 mm	10	9778PZD-2	

Slotted/Phillips Reversible blade Screwdriver with Plastic Handle 6.0 mm/PH2



8052

PH 2	80 mm	28 mm	110 mm	5	8052

Slotted/Phillips Screwdriver Set with Wooden Handle - 6 Pcs



9710/S6

6	1	9710/S6

0,8x4,5x90

Stubby Slotted and Phillips Reversible Blade Screwdrivers



1016

6 mm	PH 2	10	1016

- 9710-4.5-90
- 9710-5.5-100, 9710-6.5-125, 9710-8-150
- 9778-1, 9778-2

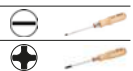

Reversible Blade Phillips/Slotted Screwdriver Set



PH 0, PH 1, PH 2	3,5-5,0-6,5 mm	1	6

Slotted and Phillips Reversible Blade Screwdrivers



1019/1067

4,5 mm	PH 1	10	1067
6 mm	PH 2	10	1019



Slotted Straight Tipped Screwdrivers with Impact Grip 2.5 x 250 mm



9715



14.0 mm	250 mm	32 mm	140 mm	5	9715-14-250

Precision Slotted Screwdrivers with Plastic Handle 2.0-3.0 mm



7372I



2.0 mm	63 mm	13 mm	80 mm	10	7372I-2-63
2.5 mm	75 mm	13 mm	80 mm	10	7372I-2.5-75
3.0 mm	80 mm	13 mm	80 mm	10	7372I-3-80

ELECTRICAL TESTERS

150-250 V Voltage Testers with neon indicator



806



3.0 mm	65 mm	16 mm	75 mm	6	806-1-1
3.5 mm	100 mm	17,5 mm	90 mm	6	806-1-2

6-24V Auto Tester with neon light

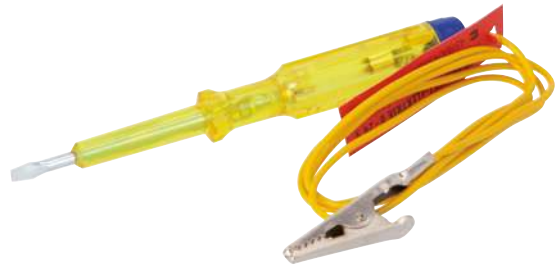

806-1-3



3 mm	45 mm	16 mm	75 mm	6	806-1-3

150-250 V Voltage Tester, 3.5 mm, 77 mm blade with neon indicator



8045VDE



3.5 mm	77 mm	14 mm	92 mm	10	8045VDE

150-250 V Voltage Tester, 3.5 mm, 42 mm blade with neon indicator



8045LVDE



3.5 mm	42 mm	16 mm	90 mm	10	8045LVDE

ACCESSORIES

Magnetising and Demagnetising Boxes for Screwdriver Blades/
Tweezers



M780



29 x 52 x 50 mm



1 M780

Magnetizer and Demagnetizer for Screwdriver Blades/Tweezers/
Scissors



M781



22 x 125 x 40 mm



5 M781





BAHCO



L-Keys



HEXAGONAL TIPPED

Metric Hex L-Keys with Nickel Finish



1998M

Hex Size	Length (mm)	Quantity	Part No.
1.5 mm	47 mm	10	1998M-1.5
2 mm	52 mm	10	1998M-2
2.5 mm	59 mm	10	1998M-2.5
3.0 mm	66 mm	10	1998M-3
4.0 mm	74 mm	10	1998M-4
5.0 mm	85 mm	10	1998M-5
6.0 mm	96 mm	10	1998M-6
7.0 mm	102 mm	10	1998M-7
8.0 mm	108 mm	10	1998M-8
9.0 mm	114 mm	5	1998M-9
10 mm	122 mm	10	1998M-10
12.0 mm	137 mm	5	1998M-12
14.0 mm	154 mm	1	1998M-14
17.0 mm	177 mm	1	1998M-17
19.0 mm	199 mm	1	1998M-19
22.0 mm	222 mm	1	1998M-22

Metric Hex L-Key Set with Nickel Finish - 6 Pcs



1998M/6T

Hex Size	Quantity	Part No.
2, 2.5, 3, 4, 5, 6 mm	6	1998M/6T

1998M-4, 1998M-5, 1998M-6, 1998M-2.5, 1998M-2, 1998M-3

Metric Hex L-Key Set with Nickel Finish - 8 Pcs



1998M/8T

Hex Size	Quantity	Part No.
2, 2.5, 3, 4, 5, 6, 7, 8 mm	8	1998M/8T

1998M-3, 1998M-2, 1998M-6, 1998M-7, 1998M-4, 1998M-5, 1998M-8, 1998M-2.5

Metric Hex L-Key Set with Nickel Finish - 10 Pcs



1998M/10T

Hex Size	Quantity	Part No.
2, 2.5, 3, 4, 5, 6, 7, 8, 9, 10 mm	10	1998M/10T

1998M-5, 1998M-4, 1998M-7, 1998M-6, 1998M-2, 1998M-3, 1998M-2.5, 1998M-8, 1998M-9, 1998M-10

Metric Hex L-Key Set with Nickel Finish - 11 Pcs



1998M/11T

Hex Size	Quantity	Part No.
2, 2.5, 3, 4, 5, 6, 7, 8, 9, 10, 12 mm	11	1998M/11T

1998M-5, 1998M-4, 1998M-7, 1998M-6, 1998M-2, 1998M-3, 1998M-2.5, 1998M-8, 1998M-9, 1998M-10, 1998M-12

Metric Hex L-Key Set with Nickel Finish - 15 Pcs



1998M/15T

Hex Size	Quantity	Part No.
2, 2.5, 3, 4, 5, 6, 7, 8, 9, 10, 12, 14, 17, 19, 22 mm	15	1998M/15T

1998M-2, 1998M-5, 1998M-4, 1998M-7, 1998M-6, 1998M-3, 1998M-2.5, 1998M-14, 1998M-17, 1998M-19, 1998M-22, 1998M-8, 1998M-9, 1998M-10, 1998M-12

Metric Hex L-Key Set with Nickel Finish and Two-Component Compact Holder - 9 Pcs



BE-9878

Hex Size	Quantity	Part No.
1.5, 2, 2.5, 3, 4, 5, 6, 8, 10 mm	9	BE-9878

1998M-1.5, 1998M-2.5, 1998M-2, 1998M-3, 1998M-4, 1998M-5, 1998M-6, 1998M-8, 1998M-10

Metric Hex L-Key Ring Set with Nickel Finish - 8 Pcs



1998M/8R

Hex Size	Quantity	Part No.
2, 2.5, 3, 4, 5, 6, 7, 8 mm	8	1998M/8R

Metric Hex Folding L-Key Set with Zinc Finish - 7 Pcs



1999M/7H

Hex Size	Quantity	Part No.
2.5, 3, 4, 5, 6, 8, 10 mm	7	1999M/7H

Imperial Long Ball End Hex L-Key Set with Nickel Finish - 12 Pcs



BE-9880



0.050; 1/16; 5/64; 3/32; 7/64; 1/8; 9/64; 5/32; 3/16; 7/32; 1/4; 5/16 in 12 3 BE-9880

0.050; 1/16; 5/64; 3/32; 7/64; 1/8; 9/64; 5/32; 3/16; 7/32; 1/4; 5/16

Size	Length (L)	Quantity	Part No.
1/8 in	66 mm	10	1995Z-1/8
5/32 in	74 mm	10	1995Z-5/32
3/16 in	85 mm	10	1995Z-3/16
7/32 in	91 mm	10	1995Z-7/32
1/4 in	96 mm	10	1995Z-1/4
5/16 in	108 mm	10	1995Z-5/16
3/8 in	122 mm	10	1995Z-3/8
7/16 in	129 mm	10	1995Z-7/16
1/2 in	145 mm	10	1995Z-1/2
5/8 in	168 mm	10	1995Z-5/8
3/4 in	199 mm	10	1995Z-3/4

Metric Hex L-Key Set with Phosphate Finish - 10 Pcs



1995M/10T



2, 2.5, 3, 4, 5, 6, 7, 8, 9, 10 mm 10 1 1995M/10T

1995M-2,5, 1995M-2, 1995M-6, 1995M-5, 1995M-4, 1995M-3, 1995M-9, 1995M-10, 1995M-7, 1995M-8

Metric Hex L-Key Set with Phosphate Finish - 6 Pcs



1995M/6T



2, 2.5, 3, 4, 5, 6 mm 6 1 1995M/6T

1995M-2, 1995M-2.5, 1995M-6, 1995M-5, 1995M-4, 1995M-3

Metric Hex L-Keys with Phosphate Finish



1995M



Size	Length (L)	Quantity	Part No.
0.9 mm	33 mm	10	1995M-0.9
1.5 mm	47 mm	10	1995M-1.5
2.0 mm	52 mm	10	1995M-2
2.5 mm	59 mm	10	1995M-2.5
3.0 mm	66 mm	10	1995M-3
4.0 mm	74 mm	10	1995M-4
5.0 mm	85 mm	10	1995M-5
6.0 mm	96 mm	10	1995M-6
7.0 mm	102 mm	10	1995M-7
8.0 mm	108 mm	10	1995M-8
9.0 mm	114 mm	10	1995M-9
10 mm	122 mm	10	1995M-10
12 mm	137 mm	10	1995M-12
14 mm	154 mm	10	1995M-14
17 mm	177 mm	10	1995M-17
19 mm	199 mm	10	1995M-19
22 mm	222 mm	10	1995M-22

Metric Hex L-Key Set with Phosphate Finish - 11 Pcs



1995M/11T



2, 2.5, 3, 4, 5, 6, 7, 8, 9, 10, 12 mm 11 1 1995M/11T

1995M-2, 1995M-6, 1995M-5, 1995M-4, 1995M-2.5, 1995M-3, 1995M-9, 1995M-10, 1995M-7, 1995M-8, 1995M-12

Metric Hex L-Key Set with Phosphate Finish - 8 Pcs



1995M/8T



2, 2.5, 3, 4, 5, 6, 7, 8 mm 8 1 1995M/8T

1995M-2.5, 1995M-2, 1995M-6, 1995M-5, 1995M-4, 1995M-3, 1995M-7, 1995M-8

Imperial Hex L-Keys with Phosphate Finish



1995Z



Size	Length (L)	Quantity	Part No.
1/16 in	47 mm	10	1995Z-1/16
5/64 in	52 mm	10	1995Z-5/64
3/32 in	59 mm	10	1995Z-3/32

Metric Hex L-Key Set with Phosphate Finish - 15 Pcs



1995M/15T



2, 2.5, 3, 4, 5, 6, 7, 8, 9, 10, 12, 14, 17, 19, 22 mm 15 1 1995M/15T

1995M-2.5, 1995M-2, 1995M-6, 1995M-5, 1995M-4, 1995M-3, 1995M-9, 1995M-10, 1995M-7, 1995M-8, 1995M-17, 1995M-19, 1995M-12, 1995M-14, 1995M-22



Metric Hex L-Key Set with Phosphate Finish and Two-Component Holder - 9 Pcs



BE-9578

1.5, 2, 2.5, 3, 4, 5, 6, 8, 10 mm	9	1	BE-9578

1995M-2,5, 1995M-2, 1995M-1.5, 1995M-6, 1995M-5, 1995M-4, 1995M-3, 1995M-8, 1995M-10

Metric Hex Folding L-Key Set with Two-Component Handle 2.5 mm - 10 mm - 7 Pcs



BE-9777B

2.5 3 4 5 6 8 10 mm	7	6	BE-9777B

2.5, 3, 4, 5, 6, 8, 10 mm

Metric Hex Folding L-Key Set 1.5 mm-6 mm - 7 Pcs



BE-9776

1.5 2 2.5 3 4 5 6 mm	6	6	BE-9776

1.5, 2, 2.5, 3, 4, 5, 6 mm

Metric Hex Folding L-Key Set 2.5 mm-10 mm - 7 Pcs



BE-9777

2.5 3 4 5 6 8 10 mm	7	6	BE-9777

2.5, 3, 4, 5, 6, 8, 10 mm

Imperial Hex L-Key Set with Phosphate Finish - 10 Pcs



1995Z/

1/16, 5/64, 3/32, 1/8, 5/32, 3/16, 7/32, 1/4, 5/16, 3/8 in	10	1	1995Z/10T

1995Z-1/16, 1995Z-5/64, 1995Z-3/32, 1995Z-1/8, 1995Z-5/32, 1995Z-3/16, 1995Z-3/8, 1995Z-7/32, 1995Z-1/4, 1995Z-5/16

Imperial Hex L-Key Set with Phosphate Finish - 12 Pcs



1995Z/12T

1/16, 5/64, 3/32, 1/8, 5/32, 3/16, 7/32, 1/4, 5/16, 3/8, 7/16, 1/2 in	12	1	1995Z/12T

1995Z-1/16, 1995Z-5/64, 1995Z-3/32, 1995Z-1/8, 1995Z-5/32, 1995Z-3/16, 1995Z-1/2, 1995Z-7/16, 1995Z-3/8, 1995Z-7/32, 1995Z-1/4, 1995Z-5/16

Imperial Hex Folding L-Key Set 3/32" - 3/8" - 7 Pcs



BE-9787

3/32 1/8 5/32 3/16 1/4 5/16 3/8 in	7	6	BE-9787

Metric Long Hex L-Keys with Phosphate Finish



1995LM

1.5 mm	91 mm	10	1995LM-1.5
2 mm	102 mm	10	1995LM-2
2.5 mm	114 mm	10	1995LM-2,5
3.0 mm	129 mm	10	1995LM-3
4.0 mm	144 mm	10	1995LM-4
5.0 mm	165 mm	10	1995LM-5
6.0 mm	186 mm	10	1995LM-6
7.0 mm	197 mm	10	1995LM-7
8.0 mm	208 mm	10	1995LM-8
9.0 mm	219 mm	10	1995LM-9
10 mm	234 mm	10	1995LM-10
12 mm	262 mm	10	1995LM-12
14 mm	294 mm	10	1995LM-14

Metric Long Hex L-Key Set with Phosphate Finish and Two-Component Holder - 6 Pcs



BE-9586

1.5, 2, 2.5, 3, 4, 5 mm	6	1	BE-9586

1995LM-1.5, 1995LM-3, 1995LM-2,5, 1995LM-2, 1995LM-4, 1995LM-5

Metric Long Hex L-Key Set with Phosphate Finish and Two-Component Holder - 9 Pcs



BE-9588

1.5, 2, 2.5, 3, 4, 5, 6, 8, 10 mm 9 1 BE-9588

1995LM-1.5, 1995LM-2, 1995LM-2.5, 1995LM-3, 1995LM-4, 1995LM-5, 1995LM-6, 1995LM-8, 1995LM-10

Metric Long Ball End Hex L-Keys with Phosphate Finish



1996M

1.5 mm	91 mm	10	1996M-1.5
2.0 mm	102 mm	10	1996M-2
2.5 mm	114 mm	10	1996M-2.5
3.0 mm	129 mm	10	1996M-3
4.0 mm	144 mm	10	1996M-4
5.0 mm	165 mm	10	1996M-5
6.0 mm	186 mm	10	1996M-6
8.0 mm	208 mm	10	1996M-8
10 mm	234 mm	10	1996M-10
12 mm	262 mm	10	1996M-12

Metric Long Ball End Coloured Hex L-Key Set - 9 Pcs



C1997LM/9P

1.5, 2, 2.5, 3, 4, 5, 6, 8, 10 mm 9 1 C1997LM/9P

Metric Long Ball End Hex L-Key Set with Phosphate Finish - 6 Pcs



BE-9765

1.5, 2, 2.5, 3, 4, 5 mm 6 3 BE-9765

1996M-1.5, 1996M-2.5, 1996M-2, 1996M-4, 1996M-3, 1996M-5

Metric Long Ball End Hex L-Key Set with Phosphate Finish - 9 Pcs



BE-9770

1.5, 2, 2.5, 3, 4, 5, 6, 8, 10 mm 9 3 BE-9770

1996M-1.5, 1996M-2.5, 1996M-2, 1996M-4, 1996M-3, 1996M-5, 1996M-6, 1996M-10, 1996M-8

Metric Long Ball End Hex L-Key Set with Phosphate Finish and Two-Component Holder - 9 Pcs



BE-9676

1.5, 2, 2.5, 3, 4, 5 mm 6 1 BE-9676

1996M-5, 1996M-4, 1996M-3, 1996M-2.5, 1996M-2, 1996M-1.5

Metric Long Ball End Hex L-Key Set with Phosphate Finish and Two-Component Holder - 9 Pcs



BE-9678

1.5, 2, 2.5, 3, 4, 5, 6, 8, 10 mm 9 1 BE-9678

1996M-4, 1996M-5, 1996M-2.5, 1996M-3, 1996M-10, 1996M-6, 1996M-8, 1996M-2, 1996M-1.5

Metric Long Ball End Hex L-Key Set with Phosphate Finish and Two-Component Magnetiser Holder - 9 Pcs



BE-9688

1.5, 2, 2.5, 3, 4, 5, 6, 8, 10 mm 9 1 BE-9688

1996M-1.5, 1996M-2, 1996M-2.5, 1996M-3, 1996M-4, 1996M-5, 1996M-6, 1996M-8, 1996M-10

Metric Ball End Hex Folding L-Key Set with Two-Component Handle 2.5 mm - 10 mm - 7 Pcs



BE-9776B

2.5, 3, 4, 5, 6, 8, 10 mm 7 6 BE-9776B

2.5, 3, 4, 5, 6, 8, 10 mm



Imperial Long Ball End Hex L-Key Set with Phosphate Finish - 7 Pcs



BE-9775

1/16, 5/64, 3/32, 1/8, 5/32, 3/16, 1/4 in	7	3	BE-9775
5/64 3/32 1/4 1/8 1/16 5/32 3/16			

Imperial Long Ball End Hex L-Key Set with Phosphate Finish - 12 Pcs



BE-9780

0.05 1/16 5/64 3/32 7/64 1/8 9/64 5/32 3/16 7/32 1/4 5/16 in	12	3	BE-9780
0.05 1/16 5/64 3/32 7/64 1/8 9/64 5/32 3/16 7/32 1/4 5/16			

Imperial Long Ball End Hex L-Key Set with Phosphate Finish - 13 Pcs



BE-9785

0.05 1/16 5/64 3/32 7/64 1/8 9/64 5/32 3/16 7/32 1/4 5/16 3/8 in	13	3	BE-9785
0.05 1/16 5/64 3/32 7/64 1/8 9/64 5/32 3/16 7/32 1/4 5/16 3/8			

TORX® TIPPED

Long TORX® L-Keys with Black Oxide Finish



1995TORX

T 6	75 mm	5	1995TORX-T6
T 7	80 mm	5	1995TORX-T7
T 8	80 mm	5	1995TORX-T8
T 9	80 mm	5	1995TORX-T9
T 10	86 mm	5	1995TORX-T10
T 15	90 mm	5	1995TORX-T15
T 20	95 mm	5	1995TORX-T20
T 25	100 mm	5	1995TORX-T25
T 27	105 mm	5	1995TORX-T27
T 30	114 mm	5	1995TORX-T30
T 40	124 mm	5	1995TORX-T40
T 45	133 mm	5	1995TORX-T45
T 50	152 mm	5	1995TORX-T50
T 55	184 mm	5	1995TORX-T55
T 60	204 mm	5	1995TORX-T60

Long TORX® Coloured L-Key Set - 9 Pcs



C1997TORX/9P

8, 9, 10, 15, 20, 25, 27, 30, 40	9	1	C1997TORX/9P

Long TORX® L-Key Set with Black Oxide Finish - 4 Pcs



1995TORX/

10, 20, 30, 40	4	1	1995TORX/4T

1995TORX-T40, 1995TORX-T30, 1995TORX-T10, 1995TORX-T20



Long TORX® L-Key Set with Black Oxide Finish - 7 Pcs



1995TORX/7T

10, 15, 20, 25, 27, 30, 40	7	1	1995TORX/7T

1995TORX-T20, 1995TORX-T10, 1995TORX-T15, 1995TORX-T27, 1995TORX-T25, 1995TORX-T30, 1995TORX-T40



Long TORX® L-Key Set with Black Oxide Finish - 11 Pcs



1995TORX/11T

7, 9, 10, 15, 20, 25, 27, 30, 40, 45, 50	11	1	1995TORX/11T

1995TORX-T7, 1995TORX-T9, 1995TORX-T10, 1995TORX-T15, 1995TORX-T20, 1995TORX-T25, 1995TORX-T27, 1995TORX-T30, 1995TORX-T40, 1995TORX-T45, 1995TORX-T50



Long TORX® L-Key Set with Black Oxide Finish - 13 Pcs



1995TORX/13T

6, 7, 8, 9, 10, 15, 20, 25, 27, 30, 40, 45, 50	13	1	1995TORX/13T

1995TORX-T45, 1995TORX-T40, 1995TORX-T30, 1995TORX-T27, 1995TORX-T25, 1995TORX-T20, 1995TORX-T15, 1995TORX-T10, 1995TORX-T50, 1995TORX-T8, 1995TORX-T9, 1995TORX-T6, 1995TORX-T7

Long TORX® L-Key Set with Black Oxide Finish - 8 Pcs



BE-9575

T9, T10, T15, T20, T25, T27, T30, T40	8	1	BE-9575

1995TORX-T40, 1995TORX-T30, 1995TORX-T27, 1995TORX-T25, 1995TORX-T20, 1995TORX-T15, 1995TORX-T10, 1995TORX-T9

Long TORX® L-Key Set with Black Oxide Finish - 8 Pcs



BE-9585

T9, T10, T15, T20, T25, T27, T30, T40	8	1	BE-9585

1995TORX-T30, 1995TORX-T27, 1995TORX-T25, 1995TORX-T20, 1995TORX-T15, 1995TORX-T10, 1995TORX-T9, 1995TORX-T40

Folding TORX® L-Key Set with Two Component Handle T9 - T40 - 8 Pcs



BE-8975B

T9 - T10 - T15 - T20 - T25 - T27 - T30 - T40	8	6	BE-8975B

Folding TORX® L-Key Set T9 - T40 - 8 Pcs



BE-8975

T9 T10 15 20 25 27 30 40	8	6	BE-8975

Long Ball End TORX® L-Keys with Black Oxide Finish



1996TORX

T9 T10 T15	80 mm 86 mm 90 mm	5 5 5	1996TORX-T9 1996TORX-T10 1996TORX-T15

T20 T25 T27 T30 T40 T45 T50	95 mm 100 mm 105 mm 114 mm 124 mm 133 mm 152 mm	5 5 5 5 5 5 5	1996TORX-T20 1996TORX-T25 1996TORX-T27 1996TORX-T30 1996TORX-T40 1996TORX-T45 1996TORX-T50

Long Ball End TORX® L-Key Set with Black Oxide Finish - 5 Pcs



1996TORX/

T10, T20, T25, T30, T40	5	1	1996TORX/5T

1996TORX-T10, 1996TORX-T20, 1996TORX-T25, 1996TORX-T30, 1996TORX-T40

Long Ball End TORX® L-Key Set with Black Oxide Finish - 8 Pcs



BE-9675

T9, T10, T15, T20, T25, T27, T30, T40	8	1	BE-9675

1996TORX-T10, 1996TORX-T9, 1996TORX-T15, 1996TORX-T20, 1996TORX-T25, 1996TORX-T27, 1996TORX-T30, 1996TORX-T40



Long Tamper-Resistant TORX® L-Keys with Black Oxide Finish



1986TORX

TR 9	80 mm	5	1986TORX-T9
TR 10	86 mm	5	1986TORX-T10
TR 15	90 mm	5	1986TORX-T15
TR 20	95 mm	5	1986TORX-T20
TR 25	100 mm	5	1986TORX-T25
TR 27	105 mm	5	1986TORX-T27
TR 30	114 mm	5	1986TORX-T30
TR 40	124 mm	5	1986TORX-T40

1986TORX-T10, 1986TORX-T9,
1986TORX-T20, 1986TORX-T15,
1986TORX-T30, 1986TORX-T40,
1986TORX-T25, 1986TORX-T27



Folding TORX® Tamper L-Key Set with Two Component Handle T9 - T40 - 8 Pcs



Long Tamper-Resistant TORX® L-Key Set with Black Oxide Finish - 7 Pcs



1986TORX/

TR10, TR15, TR20, TR25, TR27, TR30, TR40	7	1	1986TORX/7T

1986TORX-T10, 1986TORX-T15,
1986TORX-T20, 1986TORX-T25,
1986TORX-T27, 1986TORX-T30,
1986TORX-T40



Long Tamper-Resistant TORX® L-Key Set with Black Oxide Finish - 8 Pcs



BE-8675

T9, T10, T15, T20, T25, T27, T30, T40	8	1	BE-8675

BE-8976B

T9, T10, T15, T20, T25, T27, T30, T40	8	6	BE-8976B

Long TORX® Plus L-Keys with Black Oxide Finish



1976TORX

IP 6	75 mm	5	1976TORX-T6
IP 7	80 mm	5	1976TORX-T7
IP 8	80 mm	5	1976TORX-T8
IP 9	80 mm	5	1976TORX-T9
IP 10	86 mm	5	1976TORX-T10
IP 15	90 mm	5	1976TORX-T15
IP 20	95 mm	5	1976TORX-T20
IP 25	100 mm	5	1976TORX-T25
IP 27	105 mm	5	1976TORX-T27
IP 30	114 mm	5	1976TORX-T30
IP 40	124 mm	5	1976TORX-T40

Long TORX® Plus L-Key Set with Black Oxide Finish - 5 Pcs



1976TORX/

IP 10, IP 20, IP 25, IP 30, IP 40	5	1	1976TORX/5T

1976TORX-T10, 1976TORX-T20,
1976TORX-T25, 1976TORX-T40,
1976TORX-T30



Long TORX® Plus L-Key Set with Black Oxide Finish - 8 Pcs



BE-7675

IP9, IP10, IP15, IP20, IP25, IP27, IP30, IP40	8	1	BE-7675

1976TORX-T10, 1976TORX-T9,
1976TORX-T15, 1976TORX-T20,
1976TORX-T25, 1976TORX-T30,
1976TORX-T40, 1976TORX-T27

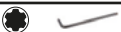

DOUBLE OFFSET

Double Offset Slotted L-Keys



2047

Width	Length (L)	Quantity	Part Number
4.0 mm	100 mm	5	2047-0.8-4
5.5 mm	125 mm	5	2047-1-5.5
8.0 mm	150 mm	5	2047-1.2-8
10.0 mm	175 mm	1	2047-1.6-10
12.0 mm	200 mm	1	2047-2-12

Double Offset Pozidriv L-Keys



2047PZ

Tip Type	Length (L)	Quantity	Part Number
PZ1, PZ2	100 mm	5	2047PZ-1-2

MULTITOOLS

Mixed Bicycle Folding Tool Set with Pouch



Double Offset Phillips L-Keys



2047PR

Tip Type	Length (L)	Quantity	Part Number
PH 1 & 2	100 mm	5	2047PR-1-2
PH 3 & 4	200 mm	5	2047PR-3-4

BKE850901N

Dimensions	Quantity	Part Number
200 x 35 x 170 mm	10	BKE850901N





BAHCO



Pliers



CUTTING PLIERS

ERGO™ Side Cutting Pliers with Self Opening Dual-Component Handle and Phosphate Finish



ergo



2101G

Cu	Fe+	Piano	L	Icons
3.5 mm	1.8 mm	1.6 mm	125 mm	5 2101G-125
3.7 mm	2.0 mm	1.8 mm	140 mm	5 2101G-140
3.8 mm	2.5 mm	2.0 mm	160 mm	5 2101G-160
4.0 mm	2.7 mm	2.3 mm	180 mm	5 2101G-180
3.5 mm	1.8 mm	1.6 mm	125 mm	5 2101G-125IP
3.7 mm	2.0 mm	1.8 mm	140 mm	5 2101G-140IP
3.8 mm	2.5 mm	2.0 mm	160 mm	5 2101G-160IP
4.0 mm	2.7 mm	2.3 mm	180 mm	5 2101G-180IP

ERGO™ Side Cutting Pliers with Dual-Component Handle and Phosphate Finish



ergo



2101G D

Cu	Fe+	Piano	L	Icons
3.5 mm	1.8 mm	1.6 mm	125 mm	5 2101G-125IPD
3.7 mm	2.0 mm	1.8 mm	140 mm	5 2101G-140IPD
3.8 mm	2.5 mm	2.0 mm	160 mm	5 2101G-160IPD
4.0 mm	2.7 mm	2.3 mm	180 mm	5 2101G-180IPD

ERGO™ Side Cutting Pliers with Self Opening Dual-Component Handle and Phosphate Finish for Plastic



ergo



2101PG

L	Icons
160 mm	5 2101PG-160

ERGO™ Side Cutting Pliers with Self Opening Dual-Component Handle and Nickel-Chrome Finish



ergo



2101GC

Cu	Fe+	Piano	L	Icons
3.5 mm	1.8 mm	1.6 mm	125 mm	5 2101GC-125IP
3.7 mm	2.0 mm	1.8 mm	140 mm	5 2101GC-140IP
3.8 mm	2.5 mm	2.0 mm	160 mm	5 2101GC-160IP
4.0 mm	2.7 mm	2.3 mm	180 mm	5 2101GC-180IP

Side Cutting Pliers with Mono Material Handles and Phosphate Finish



2101D

Cu	Fe+	Piano	L	Icons
3.5 mm	1.8 mm	1.6 mm	125 mm	5 2101D-125
3.7 mm	2.0 mm	1.8 mm	140 mm	5 2101D-140
3.8 mm	2.5 mm	2.0 mm	160 mm	5 2101D-160
4.0 mm	2.7 mm	2.3 mm	180 mm	5 2101D-180
3.5 mm	1.8 mm	1.6 mm	125 mm	5 2101D-125IP
3.7 mm	2.0 mm	1.8 mm	140 mm	5 2101D-140IP
3.8 mm	2.5 mm	2.0 mm	160 mm	5 2101D-160IP
4.0 mm	2.7 mm	2.3 mm	180 mm	5 2101D-180IP

ERGO™ Heavy Duty Side Cutting Pliers with Self Opening Dual-Component Handle and Phosphate Finish



ergo



21HDG

Fe+	Piano	L	Icons
2.3 mm	2.1 mm	140 mm	5 21HDG-140
2.7 mm	2.3 mm	160 mm	5 21HDG-160
3.3 mm	2.8 mm	180 mm	5 21HDG-180
3.3 mm	2.8 mm	200 mm	5 21HDG-200
2.3 mm	2.1 mm	140 mm	5 21HDG-140IP
2.7 mm	2.3 mm	160 mm	5 21HDG-160IP
3.3 mm	2.8 mm	180 mm	5 21HDG-180IP
3.3 mm	2.8 mm	200 mm	5 21HDG-200IP

ERGO™ 14° Side Cutting Pliers with Self Opening Dual-Component Handle and Phosphate Finish



ergo



21HDG-A

Fe ₂	Plano	L	Icons
2.2 mm	2.0 mm	140 mm	5 21HDG-140A
2.5 mm	2.3 mm	160 mm	5 21HDG-160A
2.7 mm	2.5 mm	180 mm	5 21HDG-180A
3.2 mm	3.0 mm	200 mm	5 21HDG-200A

ERGO™ Heavy Duty Side Cutting Pliers with Self Opening Dual-Component Handle and Chrome Finish



ergo



21HDGC

Fe ₂	Plano	L	Icons
2.2 mm	2.2 mm	140 mm	5 21HDGC-140IP
2.5 mm	2.5 mm	160 mm	5 21HDGC-160IP
2.8 mm	2.8 mm	180 mm	5 21HDGC-180IP
3.2 mm	3.0 mm	200 mm	5 21HDGC-200IP

Heavy Duty Side Cutting Pliers with Mono Material Handles and Phosphate Finish



21HDD

Fe ₂	Plano	L	Icons
2.2 mm	2.2 mm	140 mm	5 21HDD-140
2.5 mm	2.5 mm	160 mm	5 21HDD-160
2.8 mm	2.8 mm	180 mm	5 21HDD-180
3.2 mm	3.0 mm	200 mm	5 21HDD-200
2.2 mm	2.2 mm	140 mm	5 21HDD-140IP
2.5 mm	2.5 mm	160 mm	5 21HDD-160IP
2.8 mm	2.8 mm	180 mm	5 21HDD-180IP
3.2 mm	3.0 mm	200 mm	5 21HDD-200IP

Power Cutters with Dual-Component Handle and Phosphate Finish



1520G

Plano	L	Icons
3.8 mm	210 mm	5 1520 G
3.8 mm	210 mm	5 1520 G IP

Power Cutters with PVC Coated Handles and Phosphate Finish



1520D

Plano	L	Icons
3.8 mm	205 mm	5 1520 D

ERGO™ Compact Side Cutting Pliers with Dual-Component Handle and Phosphate Finish



ergo



4130, 4131





Fe ₂	L	Icons
0.3-1.5 mm	120 mm	3 4130
0.3-1.5 mm	120 mm	3 4131



Compact Oval Head Side Cutters with Orange PVC Handle





C3140

			
0,4-2,0 mm	130 mm	10	C3140
0,4-2,0 mm	130 mm	10	C3140IP

Side Cutting Pliers with PVC Coated Handles and Phosphate Finish



2100PD





				
1.8 mm	3.0 mm	150 mm	5	2100PD-150

PLASTIC

Compact Side Cutting Pliers with Orange PVC Handle









C3330

			
0,3-1,6 mm	115 mm	10	C3330
0,3-1,6 mm	115 mm	10	C3330IP

Side Cutting Pliers with Dual-Component Handle and Polished Finish







2171G

					
2.5 mm	1.6 mm	1.5 mm	150 mm	5	2171G-140
2.5 mm	1.6 mm	1.5 mm	160 mm	5	2171G-160
2.5 mm	1.6 mm	1.5 mm	185 mm	5	2171G-180

Compact Tapered and Relieved Head Side Cutters with Orange PVC Handle





C3330R/C3340R

			
0,3-1,25 mm	115 mm	10	C3330R
0,4-1,6 mm	130 mm	10	C3340R
0,3-1,25 mm	115 mm	10	C3330R IP
0,4-1,6 mm	130 mm	10	C3340R IP

Side Cutting Pliers with Cellulose Acetate Handles and Nickel-Chrome Finish For Steel Wire



2666NB-2676NB

				
2.7 mm	2.0 mm	160 mm	1	2674 NB

Side Cutting Pliers with Cellulose Acetate Handles and Nickel-Chrome Finish For Piano wire



2667B-2678B

Cu	Fe+	Piano	L		
3.7 mm	2.0 mm	2.0 mm	160 mm	1	2676 B
4.0 mm	2.5 mm	2.5 mm	200 mm	1	2678 B

		L		
0.1-1.0 mm	Ultra-flush	110 mm	1	2646 AK
0.2-1.25 mm	Ultra-flush	112,5 mm	1	2666 FK
0.4-2.0 mm	Micro-bevel	125 mm	1	2648
0.3-1.6 mm	Ultra-flush	125 mm	1	2648 A

Diagonal Cutters with Oval Head



2646M - 2649

		L		
0.1-0.8 mm	Flush	108 mm	1	2646 M
0.2-1.25 mm	Micro-bevel	110 mm	1	2646 R
0.2-1.25 mm	Micro-bevel	110 mm	1	2646 RK
0.1-1.0 mm	Flush	110 mm	1	2646 RA
0.3-1.6 mm	Micro-bevel	112,5 mm	1	2666
0.4-2.0 mm	Micro-bevel	125 mm	1	2649

Diagonal Cutters with Tapered Head



2646 - 2648A

		L		
0.2-1.25 mm	Micro-bevel	110 mm	1	2646
0.2-1.25 mm	Micro-bevel	110 mm	1	2646 K
0.1-1.0 mm	Ultra-flush	110 mm	1	2646 A

ERGO™ 20° Oblique Cutters



4231

	L		
0.3-1.25 mm	119 mm	3	4231

ERGO™ 45° Oblique Cutters



4239

	L		
0.3-1.0 mm	129 mm	3	4239



45° Oblique Cutters with PVC Coated Handles and Phosphate Finish



2145PD

3.0 mm	1.8 mm	154 mm	5	2145PD-150

PLASTIC

End Cutting Pliers with Bi-Material Handles and Chrome Finish



527 GC

2.0 mm	160 mm	3	527 GC-160
2.5 mm	200 mm	3	527 GC-200

45° Oblique Cutters with Long Head



2787F

0.2-1.0 mm	Flush	117,5 mm	1	2787 F

End Cutting Pliers with PVC Handles and Phosphate Finish



527D

2 mm	160 mm	5	527 D-160
2.5 mm	200 mm	5	527 D-200

45° Oblique Cutters with Relieved Long Head



2787G

0.2-0.8 mm	Flush	117,5 mm	1	2787 G

High Leverage End Cutting/Fencing Pliers with PVC Coated Handles and Black Epoxy Finish



2339D

2.2 mm	220 mm	3	2339 D
2.2 mm	220 mm	5	2339 DIP
4.5 mm	300 mm	5	2339D-300
4.5 mm	300 mm	6	2339D-300IP

High Leverage End Cutting/Fencing Pliers with Black Epoxy Finish



2339

2.2 mm	220 mm	5	2339-220
2.2 mm	220 mm	5	2339-220IP
2.5 mm	250 mm	5	2339-250IP
3.0 mm	280 mm	5	2339-280IP
4.5 mm	300 mm	6	2339-300IP

Compact End Cutting Pliers with Orange PVC Handle



C3230

109 mm	10	C3230
109 mm	10	C3230IP

Pincers with PVC Handles and Black Epoxy Finish



541D

2.0 mm	150 mm	5	541 D-150
2.0 mm	180 mm	5	541D-180
2.5 mm	200 mm	5	541 D-200
2.5 mm	225 mm	5	541D-225
2.5 mm	250 mm	5	541 D-250

90° Side Cutting Pliers with PVC Coated Handles and Phosphate Finish



2190PD

1.8 mm	3.0 mm	143 mm	5	2190PD-150

High Leverage End Cutting/Fencing Pliers with Phosphate Finish



1519D

2.5 mm	230 mm	3	1519 D
		1	1519-9

End Cutters with Synthetic Handles and Mirror Finish



2656/2656A

0.35 - 0.8 mm	Micro	115 mm	1	2656



Cable Cutting/Stripping Pliers with PVC Coated Handles for Cu and Al Cables



2233D

Icon	Icon	Icon	Icon	Icon
10 mm	50/35 mm	160 mm	5	2233 D-160
13 mm	70/50 mm	200 mm	5	2233 D-200
16 mm	95/70 mm	240 mm	5	2233 D-240
10 mm	50/35 mm	160 mm	5	2233D-160IP
13 mm	70/50 mm	200 mm	5	2233D-200IP
16 mm	95/70 mm	240 mm	5	2233D-240IP

Cable Cutters with Epoxy Painted Handles for Cu, Al and Steel Cables



2720

Icon	Icon	Icon	Icon
42 mm	600 mm	1	2720
	163 mm	1	2720-SH

Cable Cutters with Epoxy Painted Handles for Cu and Al Cables 30 mm



2520

Icon	Icon	Icon	Icon
550 mm		1	2520
220 mm		1	2520-SH

Cable Cutters with Elastomer Handles for Solid Materials and Multi Wire Cables



2235-160

Icon	Icon	Icon
165 mm		1 2235-160

Cable Cutters with Epoxy Painted Handles for Cu and Al Cables 42 mm



2620-80

Icon	Icon	Icon	Icon
42 mm	800 mm	1	2620-80

Cable Cutters with PVC Coated Handles for Cu and Al Cables



2804-2805

Icon	Icon	Icon	Icon	Icon
16 mm	34 mm	250 mm	1	2804
22 mm	52 mm	280 mm	1	2805-280

Cable Cutters with PVC Coated Handles for Multi Wire and Flexible Conductors



2800N-2801N

Icon	Length (mm)	Weight (g)	Model
	170 mm	1	2800 N
	230 mm	1	2801 N

Bolt Cutters with Comfort Grip Handles and Phosphate Finish



4559

Icon	Ø Fe	Ø Plano	Length (mm)	Weight (g)	Model
	6 mm	4 mm	330 mm	1	4559-12
	8 mm	6 mm	430 mm	8	4559-18
	10 mm	8 mm	600 mm	6	4559-24
	13 mm	10 mm	750 mm	5	4559-30
	15 mm	12 mm	900 mm	3	4559-36
	15 mm	12 mm	1060 mm	2	4559-42

Spare Cutting Heads for 4559 Range Bolt Cutters



4559 JC

Weight (g)	Quantity	Model
285 g	1	4559-12A JC
600 g	1	4559-18B JC
930 g	1	4559-24B JC
1260 g	1	4559-30B JC
2180 g	1	4559-36B JC
3025 g	1	4559-42A JC

Diagonal Bolt Cutters with Phosphate Finish



4560-210

Length (mm)	Quantity	Model
250 mm	1	4560-210

COMBINATION PLIERS

ERGO™ Combination Pliers with Self-Opening Dual-Component Handles and Phosphate Finish



2628G

Icon	Icon	Length (mm)	Quantity	Model
		160 mm	5	2628 G-160
		180 mm	5	2628 G-180
		200 mm	5	2628 G-200
		160 mm	5	2628 G-160IP
		180 mm	5	2628 G-180IP
		200 mm	5	2628G-200IP

ERGO™ Combination Pliers with Self-Opening Dual-Component Handles and Chrome Finish



2628GC

Icon	Icon	Length (mm)	Quantity	Model
		160 mm	5	2628 GC-160IP
		180 mm	5	2628 GC-180IP
		200 mm	5	2628 GC-200IP



ERGO™ Reinforced Combination Pliers with Self-Opening Dual-Component Handles and Chrome Finish



ergo



2630GC

Plano	Fe+	L	Icons
1.8 mm	2.0 mm	160 mm	5 2630GC-160IP
2.0 mm	2.5 mm	180 mm	5 2630GC-180IP
2.5 mm	3.0 mm	200 mm	5 2630GC-200IP

Reinforced Combination Pliers with Monomaterial Handles and Chrome Finish



2630DC

Fe+	Plano	L	Icons
2.0 mm	1.8 mm	160 mm	5 2630DC-160IP
2.5 mm	2.0 mm	180 mm	5 2630DC-180IP
3.0 mm	2.5 mm	200 mm	5 2630DC-200IP

ERGO™ Combi-Snipe Pliers with Self-Opening Dual-Component Handles and Phosphate Finish



ergo



2629G

L	Fe+	Plano	Icons
160 mm	2.0 mm	1.8 mm	5 2629G-160
180 mm	3.0 mm	2.5 mm	5 2629G-180
200 mm	2.5 mm	2.0 mm	5 2629G-200
160 mm	2.5 mm	2.0 mm	5 2629G-160IP
180 mm	2.0 mm	1.8 mm	5 2629G-180IP
200 mm	3.0 mm	2.5 mm	5 2629G-200IP

Universal Combination Pliers with PVC Coated Handles



2640D

Cu	Fe	Fe+	L	Icons
3.0 mm	2.7 mm	2.5 mm	160 mm	10 2640D-160
3.0 mm	2.7 mm	2.5 mm	180 mm	5 2640D-180
3.5 mm	3.0 mm	2.5 mm	200 mm	5 2640D-200

Combination Pliers with Monomaterial Handles and Phosphate Finish



2628D

Fe+	Plano	L	Icons
2.0 mm	1.8 mm	160 mm	5 2628 D-160
2.5 mm	2.0 mm	180 mm	5 2628 D-180
3.0 mm	2.5 mm	200 mm	5 2628 D-200

High Leverage Universal Combination Pliers with PVC Coated Handles



2688D

Fe+	Fe	Cu	L	Icons
2.5 mm	3.0 mm	3.5 mm	250 mm	3 2688D-250

Combination Pliers with Dual-Component Handles



2678G

1.7 mm	1.3 mm		160 mm	5	2678 G-160
2.0 mm	1.4 mm		180 mm	5	2678 G-180
2.5 mm	1.5 mm		205 mm	5	2678 G-200

2 Position Combination Pliers with Lacquered Finish



2970 G-200

200 mm	5	2970G-200

GRIPPING PLIERS

ERGO™ Long Snipe Nose Pliers with Self-Opening Dual-Component Handles and Phosphate Finish



2430G

2.5 mm	1.8 mm	1.4 mm	140 mm	5	2430 G-140
3.0 mm	1.8 mm	1.6 mm	160 mm	5	2430 G-160
3.0 mm	1.8 mm	1.6 mm	200 mm	5	2430 G-200
2.5 mm	1.8 mm	1.4 mm	140 mm	5	2430 G-140 IP
3.0 mm	1.8 mm	1.6 mm	160 mm	5	2430 G-160 IP
3.0 mm	1.8 mm	1.6 mm	200 mm	5	2430 G-200 IP

ERGO™ Long Snipe Nose Pliers with Self-Opening Dual-Component Handles and Chrome Finish



2430GC

2.5 mm	1.8 mm	1.4 mm	140 mm	5	2430 GC-140 IP
3.0 mm	1.8 mm	1.6 mm	160 mm	5	2430 GC-160 IP
3.0 mm	1.8 mm	1.6 mm	200 mm	5	2430 GC-200 IP

Long Snipe Nose Pliers with Monomaterial Handles and Phosphate Finish



2430D

2.5 mm	1.8 mm	1.4 mm	140 mm	5	2430 D-140
3.0 mm	1.8 mm	1.6 mm	160 mm	5	2430 D-160
3.0 mm	1.8 mm	1.6 mm	200 mm	5	2430 D-200
2.5 mm	1.8 mm	1.4 mm	140 mm	5	2430 D-140 IP
3.0 mm	1.8 mm	1.6 mm	160 mm	5	2430 D-160 IP
3.0 mm	1.8 mm	1.6 mm	200 mm	5	2430 D-200 IP

ERGO™ Long Snipe Nose Pliers without Cutting Edge, with Self-Opening Dual-Component Handles and Phosphate Finish



2431G

125 mm	5	2431G-125
140 mm	5	2431G-140
160 mm	5	2431G-160
180 mm	5	2431G-180
125 mm	5	2431G-125IP
140 mm	5	2431G-140IP
160 mm	5	2431G-160IP
180 mm	5	2431G-180IP



ERGO™ Compact Snipe Nose Pliers with Dual-Component Handles and Phosphate Finish



ergo



4830, 4831

135 mm	3	4830
135 mm	3	4831

Snipe Nose Pliers with Synthetic Handles and Mirror Polish Finish



2656S

132 mm	1	2656 S	

Compact Snipe Nose Pliers with Orange PVC Handle



C3830/C3840

121 mm	10	C3830
144 mm	10	C3840
121 mm	10	C3830IP
144 mm	10	C3840IP

Snipe Nose Pliers with Dual-Component Handles and Lacquered Finish



2470G

3.0 mm	1.5 mm	1.0 mm	165 mm	5	2470 G-160
3.0 mm	1.5 mm	1.0 mm	210 mm	5	2470 G-200

Compact Snipe Needle Nose Pliers with Orange PVC Handle



C3630/C3640

130 mm	10	C3630
145 mm	10	C3640
130 mm	10	C3630IP
145 mm	10	C3640IP

Extra Long Snipe Nose Pliers with PVC Coated Handles and Fine Polish Finish



158-N

280 mm	12	158-N

ERGO™ 45° Bent Tip Snipe Nose Pliers with Self-Opening Dual-Component Handles and Phosphate Finish



2427G

3.0 mm	1.8 mm	1.6 mm	160 mm	5	2427 G-160
3.0 mm	1.8 mm	1.6 mm	200 mm	5	2427 G-200
3.0 mm	1.8 mm	1.6 mm	160 mm	5	2427 G-160 IP
3.0 mm	1.8 mm	1.6 mm	200 mm	5	2427 G-200 IP

ERGO™ 60° Bent Tip Snipe Nose Pliers with Dual-Component Handles and Phosphate Finish



4833

130 mm	3	4833

ERGO™ 45° Bent Tip Snipe Nose Pliers with Self-Opening Dual-Component Handles and Chrome Finish



2427GC

3.0 mm	1.8 mm	1.6 mm	160 mm	5	2427 GC-160IP
3.0 mm	1.8 mm	1.6 mm	200 mm	5	2427 GC-200IP

Compact Needle Snipe Nose Pliers with 45° Bent Tip and Orange PVC Handle



C3745

141 mm	10	C3745
141 mm	10	C3745IP

45° Bent Tip Snipe Nose Pliers with Monomaterial Handles and Phosphate Finish



2427D

3.0 mm	1.8 mm	1.6 mm	160 mm	5	2427 D-160
3.0 mm	1.8 mm	1.6 mm	200 mm	5	2427 D-200

Compact 90° Bent Tip Snipe Nose Pliers with Orange PVC Handle



C3790

125 mm	10	C3790
125 mm	10	C3790IP



60° Bent Tip Snipe Nose Pliers with Synthetic Handles and Mirror Polished Finish



2656R

129 mm	1	2656 R

45° Bent Tip Snipe Nose Pliers with Dual-Component Handles and Lacquered Finish



2477G-200

3.0 mm	1.5 mm	1 mm	210 mm	5	2477 G-200

35° Bent Tip Extra Long Snipe Nose Pliers with PVC Coated Handles and Fine Polished Finish



158-NB

270 mm	12	158-NB

ERGO™ Short Flat Nose Pliers with Self-Opening Dual-Component Handles and Phosphate Finish



2420G

125 mm	5	2420 G-125
125 mm	5	2420G-125IP

ERGO™ Long Flat Nose Pliers with Self-Opening Dual-Component Handles and Phosphate Finish



2421G

140 mm	5	2421 G-140
160 mm	5	2421 G-160
180 mm	5	2421 G-180
140 mm	5	2421 G-140IP
160 mm	5	2421 G-160 IP
180 mm	5	2421 G-180 IP

ERGO™ Long Flat Nose Pliers with Self-Opening Dual-Component Handles and Chrome Finish



2421GC

140 mm	5	2421GC-140IP
160 mm	5	2421GC-160IP
180 mm	5	2421GC-180IP

Long Flat Nose Pliers with Monomaterial Handles and Phosphate Finish



2421D

140 mm	5 2421 D-140IP
160 mm	5 2421 D-160IP
180 mm	5 2421 D-180IP

Compact Flat Nose Pliers with Orange PVC Handle



C3430

129 mm	10 C3430
129 mm	10 C3430IP

ERGO™ Connector Pliers with Self-Opening Dual-Component Handles and Phosphate Finish



7835G

3.0 mm 1.8 mm 1.6 mm	160 mm	5 7835 G-160

Flat Nose Pliers with Synthetic Handles and Mirror Polish Finish



2646MF

120 mm	1 2646 MF

ERGO™ Flat Nose Pliers with Dual-Component Handles and Phosphate Finish



4430

135 mm	3 4430

Long Flat Nose Pliers with Dual-Component Handles and Lacquered Finish



2471G

165 mm	5 2471 G-160



Flat Nose Nut Pliers with PVC Coated Handles and Phosphate Finish



2979D



180 mm



5 2979 D-180

ERGO™ Compact Round Nose Pliers with Dual-Component Handles and Phosphate Finish



4530



135 mm



3 4530

ERGO™ Round Nose Pliers with Self-Opening Dual-Component Handles and Phosphate Finish



2521G



140 mm

160 mm

140 mm

160 mm



5 2521 G-140

5 2521G-160

5 2521G-140IP

5 2521 G-160 IP

Compact Round Nose Pliers with Orange PVC Handle



C3530



127 mm

127 mm



10 C3530

10 C3530IP

Round Nose Pliers with Monomaterial Handles and Phosphate Finish



2521D



140 mm

160 mm



5 2521D-140IP

5 2521D-160IP

Chain Nose Pliers with Synthetic Handle



2646MS



120 mm



1 2646 MS

WATERPUMP PLIERS

ERGO™ Slip Joint Water Pump Pliers with Dual-Component Handles and Phosphate Finish



ergo®



8223 - 8226



max	L	Icon 1	Icon 2
210 mm		4	8223
250 mm		4	8224
315 mm		4	8225
400 mm		1	8226
210 mm		4	8223 IP
250 mm		4	8224 IP
315 mm		4	8225 IP

ERGO™ Slip Joint Water Pump Pliers with Dual-Component Handles and Chrome Finish



ergo®



8224/8225C



max	L	Icon 1	Icon 2
250 mm		4	8224CIP
315 mm		4	8225CIP

ERGO™ Extra Wide Jaw Slip Joint Water Pump Pliers with Dual-Component Handles and Phosphate finish



ergo®



8231



max	L	Icon 1	Icon 2
51 mm	225 mm	4	8231
51 mm	225 mm	4	8231 IP

Quick Adjust Slip Joint Water Pump Pliers with Phosphate Finish



7223-7225

max	L	Icon 1	Icon 2
45 mm	200 mm	4	7223
63 mm	250 mm	4	7224
70 mm	300 mm	4	7225
45 mm	200 mm	8	7223IP
63 mm	250 mm	4	7224IP
70 mm	300 mm	4	7225IP

Quick-Adjust Water Pump Pliers with PVC Handle



7223D 7225D

max	L	Icon 1	Icon 2
16	200 mm	8	7223D
22	250 mm	4	7224D
25	300 mm	4	7225D
16	200 mm	8	7223D IP
22	250 mm	4	7224D IP
25	300 mm	4	7225D IP

Box Joint Water Pump Pliers with Dual-Component Handle



6224

max	L	Icon 1	Icon 2
11	250 mm	4	6224



Box Joint Water Pump Pliers with PVC Handle



6221D-6225D

6	125 mm	10	6221D
8	150 mm	10	6222D
10	200 mm	8	6223D
11	250 mm	5	6224D
13	300 mm	5	6225D
6	125 mm	10	6221D IP
8	150 mm	10	6222D IP
10	200 mm	8	6223D IP
11	250 mm	5	6224D IP
13	300 mm	5	6225D IP

Box Joint Water Pump Pliers with Dual-Component Handles and Phosphate Finish



2971G

35 mm	250 mm	5	2971G-250

Screw Joint Water Pump Pliers with PVC Coated Handles and Phosphate Finish



221 D - 225 D

117 mm	5	221 D
150 mm	5	222 D
192 mm	5	223 D
240 mm	5	224 D
305 mm	5	225 D

Connector Pliers with PVC Coated Handles and Chrome Finish



2650

65 mm	235 mm	1	2650
	235 mm	1	2650 B

Box Joint Water Pump Pliers Set - 3 Pcs



622-3P

110 x 50 x 390 mm	3	1260 g	1	622-3P

6223D, 6224D, 6225D



Water Pump Pliers Set - 3 Pcs



7224-622XD-3P

75 x 50 x 260 mm	3	813 g	1	7224-622XD-3P

6221D, 6224D

7224



CIRCLIP PLIERS

Internal Circlip Pliers with Straight Jaws and Phosphate Finish



2800

Internal Circlip Size	Jaw Width	Length (L)	Quantity	Model
8-13 mm	0.8 mm	140 mm	3	2800-140
12-25 mm	1.2 mm	150 mm	3	2800-150
19-60 mm	1.7 mm	180 mm	3	2800-180
40-100 mm	2.2 mm	225 mm	3	2800-225
85-165 mm	3.1 mm	310 mm	1	2800-300

Internal Circlip Pliers with 90° Offset Jaws and Phosphate Finish



2890

Internal Circlip Size	Jaw Width	Length (L)	Quantity	Model
8-15 mm	0.8 mm	125 mm	3	2890-125
12-25 mm	1.2 mm	140 mm	3	2890-140
19-60 mm	1.7 mm	180 mm	3	2890-180
40-100 mm	2.2 mm	210 mm	3	2890-210
85-165 mm	3.1 mm	300 mm	1	2890-300

Internal Circlip Pliers with Straight Jaws and Chrome Finish



2461

Internal Circlip Size	Jaw Width	Length (L)	Quantity	Model
8-25 mm	1.0-2.0 mm	140 mm	1	2461 C8
19-60 mm	2.0-2.5 mm	180 mm	1	2461 C19
40-100 mm	2.5-3.5 mm	255 mm	1	2461 C40

Internal Circlip Pliers with 90° Offset Jaws and Chrome Finish



2463

Internal Circlip Size	Jaw Width	Length (L)	Quantity	Model
8-25 mm	1.0-2.0 mm	130 mm	1	2463 D8
19-60 mm	2.0-2.5 mm	170 mm	1	2463 D19
40-100 mm	2.5-3.5 mm	210 mm	1	2463 D40

External Circlip Pliers with Straight Jaws and Phosphate Finish



2900

External Circlip Size	Jaw Width	Length (L)	Quantity	Model
3-10 mm	0.8 mm	140 mm	3	2900-140
10-25 mm	1.2 mm	150 mm	3	2900-150
19-60 mm	1.7 mm	180 mm	3	2900-180
40-100 mm	2.2 mm	215 mm	3	2900-215
85-165 mm	3.1 mm	300 mm	1	2900-300

External Circlip Pliers with 90° Offset Jaws and Phosphate Finish



2990

External Circlip Size	Jaw Width	Length (L)	Quantity	Model
3-10 mm	0.8 mm	125 mm	3	2990-125
10-25 mm	1.2 mm	140 mm	3	2990-140
19-60 mm	1.7 mm	180 mm	3	2990-180
40-100 mm	2.2 mm	200 mm	3	2990-200
85-165 mm	3.1 mm	300 mm	1	2990-300



External Circlip Pliers with Straight Jaws and Chrome Finish



2464

3-10 mm	1.0-1.5 mm	120 mm	1	2464 A3
10-25 mm	1.5-2.0 mm	120 mm	1	2464 A10
19-60 mm	2.0-2.5 mm	180 mm	1	2464 A19
40-100 mm	2.5-3.0 mm	210 mm	1	2464 A40



Spare Tips for 2928 Series Resettable Circlips Pliers



2928-1 - 4

2928-160	1	2928-1
2928-200	1	2928-2
2928-250	1	2928-3
2928-250	1	2928-4

External Circlip Pliers with 90° Offset Jaws and Chrome Finish



2466

3-10 mm	1.0-1.5 mm	130 mm	1	2466 B3
10-25 mm	1.5-2.0 mm	130 mm	1	2466 B10
19-60 mm	2.0-2.5 mm	165 mm	1	2466 B19
40-100 mm	2.5-3.0 mm	190 mm	1	2466 B40



External Horseshoe Circlip Pliers with Chrome Finish



2460

175 mm	1	2460



Internal and External Circlips Resettable Pliers



2928

7-26 mm	3-26 mm	160 mm	1	2928-160
10-51 mm	7-51 mm	200 mm	1	2928-200
46-102 mm	32-102 mm	250 mm	1	2928-250



External Horseshoe Circlip Pliers with Nickel-Chrome Finish and PVC Coated Handles



2465D

200 mm	1	2465D-200



Internal and External Circlip Pliers Set - 4 Pcs



28-29/S4

740 g	1	28-29/S4

2900-180		
2800-180		
2990-180		
2890-180		

Resettable Circlip Pliers Set - 3 Pcs



9938

1640 g	1	9938

2928-160, 2928-200, 2928-250		
------------------------------	--	--

WIRE STRIPPERS & DISMANTLING TOOLS

ERGO™ Wire Stripping Pliers with Self-Opening Dual-Component Handles and Phosphate Finish



2223G

0.5-5 mm	165 mm	5	2223 G-150

Wire Stripping Pliers with Monomaterial Handles and Phosphate Finish



2223D

0.5-5 mm	165 mm	5	2223 D-150

Automatic Wire Stripping Pliers



3416 B

0,02-10 mm²	34-8 AWG	10	3416 B
		10	3416 B SH



Automatic Wire Stripping Pliers



3416 A

0,2-6 mm ²	24-10 AWG	1 3416 A	1 3416 A SH

Automatic Wire Stripping Pliers with Built in Side Cutter and Integrated Scale



3418 A

20-10 AWG	0,5-6 mm ²	3 mm	160 mm	1 3418 A

Rotating dismantling tool



3520 B

4,5-40 mm	167 mm	10 3520 B 10 3520 B SH

Rotating dismantling tool



3520 A

0,5-6 mm ²	1 3520 A 1 3520 A SH

Rotating dismantling tool. 3518ASH spare blade



3518 A

4-28 mm	185 mm	1 3518 A 1 3518 A SH

Universal dismantling tool with hidden knife



3518 B

0,5-6 mm ²	125 mm	1 3518 B

Wire Stripping Pliers with Anti-Slip Handle



3517 A

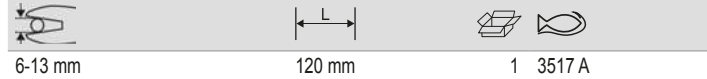

6-13 mm 120 mm 1 3517 A

Stripping Tool for PVC Data Cables



3717 A

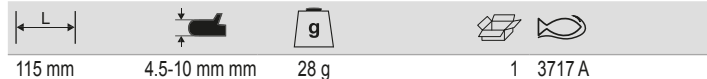

115 mm 4.5-10 mm mm 28 g 1 3717 A

Wire Stripping Tools for Coaxial Cables



3417 A

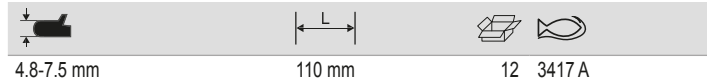

4.8-7.5 mm 110 mm 12 3417 A

Precision stripping pliers for data cables



3619 A

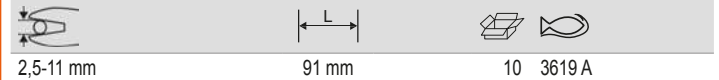

2,5-11 mm 91 mm 10 3619 A
10 3619 A SH

Precision Stripping Tool



3719 A

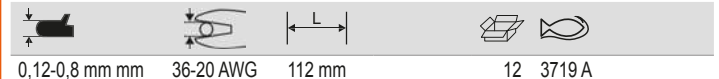

0,12-0,8 mm mm 36-20 AWG 112 mm 12 3719 A

Insertion Tool for LSA Blocks



3718 A



185 mm 0,7-2,6 mm 60 g 12 3718 A



Self-Adjusting Automatic Wire Stripping Pliers with Built in Wire Cutter



3419 B



0.25-6.00 mm



1 3419 B
1 3419 B SH

Crimping/Cutting/Stripping Pliers with Green Handle



CR B 03



0.75-6.00 mm² 1.50-6.00 mm² 14-10 AWG 220 mm



5 CR B 03

CRIMPING PLIERS

Crimping/Cutting/Stripping Pliers with Yellow Handle



CR B 01



0.50-6.00 mm² 20-10 AWG 0.75-6.00 mm² 220 mm



10 CR B 01

Crimping Pliers for Round Pattern Cable Connections 0.5-2.5 mm²



CR B 05



0.5-2.5 mm²



20-14 AWG



140 mm



2 CR B 05

Crimping/Cutting/Stripping Pliers with Red Handle



CR B 02



0.75-6.00 mm² 1.50-6.00 mm² 14-10 AWG 220 mm



10 CR B 02

Crimping Pliers for Round Pattern Cable Connections 0.5-16 mm²



CR B 06



0.5-16 mm²



20-6 AWG



220 mm



2 CR B 06

Ratcheting Crimping Pliers for Insulated Connectors - Oval Profile



CR OV 01

0.5-6.0 mm ²	20-10 AWG	256 mm	1	CR OV 01

Ratcheting Crimping Pliers for Open Plug Type Connectors



CR W 03

0.5-6.0 mm ²	20-10 AWG	225 mm	1	CR W 03

Ratcheting Crimping Pliers for Insulated Connectors



CR W 01

0.5-6.0 mm ²	20-10 AWG	225 mm	1	CR W 01

Ratcheting Crimping Pliers for High Quality Crimping Connections



CR W 04

RG 58-59-62 mm ²	225 mm	1	CR W 04

Ratcheting Crimping Pliers for Non-insulated Connectors



CR W 02

0.5-6.0 mm ²	20-10 AWG	225 mm	1	CR W 02

Ratcheting Crimping Pliers for Tubular Connectors 0.5 AWG-4.0 AWG



CR W 05

0.5-4.0 AWG	225 mm	1	CR W 05



Ratcheting Crimping Pliers for Tubular Connectors 6 AWG-16 AWG



CR W 06

6-16 AWG	225 mm	1 CR W 06

Self-Adjusting Crimping Pliers - Trapezoidal Profile



CR SA T01

0.14-10 mm ²	26-8 AWG 180 mm	1 CR SA T01

Self-Adjusting Crimping Pliers - Square Profile



CR SA S01

0.14-10 mm ²	26-8 AWG 176 mm	1 CR SA S01

Heavy Duty Crimping Pliers for Non-insulated Connectors 600 mm



CR L 01

10-120 mm ²	10-95 mm ² 600 mm	1 CR L 01

Self-Adjusting Crimping Pliers - Hexagonal Profile



CR SA H01

0.14-10 mm ²	26-8 AWG 176 mm	1 CR SA H01
0.14-16 mm ²	26-6 AWG 176 mm	1 CR SA H16

Heavy Duty Crimping Pliers for Non-insulated Connectors 360 mm



CR L 02

6-50 mm	360 mm	1 CR L 02

Heavy Duty Crimping Pliers for Non-insulated Connectors 650 mm



CR L 03

25-150 mm ²	650 mm	1	CR L 03

PLIERS SETS

ERGO™ Fine Mechanical Cutters and Pliers Set - 8 Pcs



9733

30 x 215 x 215 mm	8	1	9733

4130, 4131	
4239	
4830	
4530	
4231	
4430	
4833	

Compact Cutters and Pliers Set C3140, C3640 and C3830 - 3 Pcs



C3901/3

3	1	C3901/3

C3140IP	
C3640IP	
C3830IP	

Compact Cutters and Pliers Set C3330R, C3840 and C3745 - 3 Pcs



C3902/3

3	1	C3902/3

C3330R	
C3840	
C3745	



Compact Pliers and Screwdrivers Set - 8 pcs



C3903/2-6

8	1	C3903/2-6

C3330R	
C3840	
700-1.5-50, 700-2-50, 700-2.5-50, 700-3-50	
701-0-50, 701-1-75	

ERGO™ Plumber's Set with 9031 Adjustable Wrench - 2 Pcs



9031-8224

2	693 g	3	9031-8224

9031	
8224	

ERGO™ Plumber's Set with 9072P Adjustable Wrench - 2 Pcs



9873

25 x 190 x 280 mm	2	1	9873

9072 P	
8224	

All Round Tool Set - 3 Pcs



9853

25 x 252 x 292 mm	3	1	9853

9071	
2101G-160	
8224	

ERGO™ All Round Pliers Tool Set - 4 Pcs



9897

4	1030 g	1	9897

8224	
2628 G-180	
2101G-160	
2430 G-160	

ERGO™ All-Round Pliers Tool Set - 3 pcs



9897G/3

3	50 x 180 x 400 mm	788 g	1	9897G/3

2628 G-180

2101G-160

2430 G-200



LOCKING PLIERS

Grip Locking Pliers with Curved Jaws



2951

Size	Length (L)	Quantity	Part Number
1.2 mm	140 mm	1	2951-140
2 mm	190 mm	1	2951-180
3 mm	235 mm	1	2951-250
4 mm	300 mm	1	2951-300

Self Grip Locking Pliers with Curved Jaws



2953

Length (L)	Quantity	Part Number
140 mm	1	2953-140
190 mm	1	2953-200
235 mm	1	2953-250
300 mm	1	2953-300

Grip Locking Pliers with Straight Jaws



2958

Length (L)	Quantity	Part Number
135 mm	1	2958-140
190 mm	1	2958-200
235 mm	1	2958-250

Grip Locking Pliers with Flat Jaws and Longitudinal Section



2968

Length (L)	Quantity	Part Number
205 mm	1	2968-190
235 mm	1	2968-235

Grip and Welding Pliers with Multipurpose Jaws



2957

Length (L)	Quantity	Part Number
250 mm	1	2957-250

Grip Locking Pliers with Long and Slim Jaws



2952

Length (L)	Quantity	Part Number
155 mm	1	2952-165
230 mm	1	2952-235



Special Grips for Sheet Metals with Nickel Finish



2967



180 mm



1 2967-180

Chain Pipe Cutters with Chrome Finish



2998



330 mm
240 mm



1 2998-SHN
1 2998-250

Grip Locking Pliers with Parallel Jaws



2955



235 mm



1 2955-250

Table Locking Clamp



2960



280 mm



1 2960-280

Locking Chain Clamps with Nickel Finish



2999



500 mm
230 mm



1 2999-SHN
1 2999-250

Grip Locking Clamps with C-Clamp



2963



283 mm
458 mm
580 mm



1 2963-280
1 2963-450
1 2963-630

Self Adjusting Grip Locking Clamps with Parallel C-Clamp



2964



175 mm
280 mm
436 mm
625 mm



1 2964-160
1 2964-280
1 2964-450
1 2964-600

Stepped C Clamps



2962



290 mm
290 mm
290 mm



1 2962-8-150
1 2962-8-230
1 2962-8-300

Self Adjusting Parallel Grip Pliers with Swivel Pads



2950



235 mm



1 2950-250

Special Grip and Locking U-Clamps



2965



228 mm
290 mm



1 2965-200
1 2965-280

Steel Clamp, Swivel Pads, Slim



2956



282 mm



1 2956-290

Special Grips for Tubes and Pipes



2966



290 mm



1 2966-280



Locking Pliers Spare Parts



2951-S

🔍	L	g	📦	🐟
	43 mm	15 g	1	2951-S05
	46 mm	25 g	1	2951-S07
	62 mm	50 g	1	2951-S10
	87 mm	70 g	1	2951-S12

Automatic Hand Vices with Phosphate Finish



2949

L	📦	🐟
193 mm	1	2949-190IP
196 mm	1	2949-200IP
240 mm	1	2949-240IP
240 mm	1	2949-250IP

Universal Grip Pliers with 4 Positions Long Jaws



2997

L	📦	🐟
255 mm	5	2997-300

Hand Vices Spare Bolt



2949-L

🔧	L	📦	🐟
2949-190IP	75 mm	1	2949-L075
2949-200IP, 2949-240IP	120 mm	1	2949-L120
2949-250IP	200 mm	1	2949-L200

Universal Grip Pliers with 4 Positions Short Jaws



2997-250

L	📦	🐟
235 mm	1	2997-250

RIVETING TOOLS

Hand Riveters with 360° Swivel Head



2681

L	📦	🐟
285 mm	12	2681

Hand Riveters with Exchangeable Heads



1467-250



255 mm



1 1467-250

Notching pliers.



2690

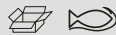

10 2690

Long Arm Riveters with Transparent Tube Collects



1467-520



530 mm



1 1467-520

Extensible Riveters for Cu/Al and Stainless Steel



1467-320-850



320-850 mm



1 1467-320-850

Spare Parts for 1467 Series Riveter



1467



- 10 g
- 10 g
- 10 g
- 5 g
- 5 g
- 5 g
- 5 g
- 5 g
- 5 g
- 5 g
- 5 g
- 10 g



- 1 1467-LJ
- 1 1467-SJ
- 1 1467-L3,2
- 1 1467-S2,4
- 1 1467-L4
- 1 1467-S3,2
- 1 1467-L5
- 1 1467-S4
- 1 1467-L6
- 1 1467-S5
- 1 1467-L6,4
- 1 1467-B14

Long Arm Riveters with Transparent Tube Collects



1467-520



530 mm



1 1467-520

Spare Part Set for 2681 Series Riveter - 4 Pcs



2681-1



15 g



1 2681-1



SPECIAL PLIERS

Automatic Wire Tie Tensioning Tools for Electric Nylon Ties



790450A

2.2x5 mm	1 790450A

Wire Tie Tensioning Tools for Electric Nylon Ties



790455A

9.5x2.3 mm	1 790455A

Wire Twisting Pliers with Phosphate Finish



2855

236 mm	1 2855	
287 mm	1 2855 D	

Wire Twisting Pliers, One-hand Operation



2856

203 mm	1 2856-8	
268 mm	1 2856-10	



Pipe Wrenches & Tubing Tools



PIPE WRENCHES

ERGO™ Quick-Adjust Pipe Wrenches



ergo



1610/1620

L	max		
320 mm	1 in	1	1610
430 mm	1 1/2 in	1	1620

10 times faster vs standard model

ERGO™ Swedish Model 90° Pipe Wrenches



ergo



1410/1420

L	max		
320 mm	1 in	1	1410
430 mm	1 1/2 in	1	1420

ERGO™ Swedish Model 90° Pipe Wrenches with Soft-Touch Shank



ergo



1410D/1420D

L	max		
320 mm	1 in	1	1410D
430 mm	1 1/2 in	1	1420D

Swedish Model 90° Pipe Wrenches



140-147

L	max		
210 mm	3/4 in	1	140
320 mm	1 in	1	141
426 mm	1 1/2 in	1	142
557 mm	2 1/2 in	1	143
722 mm	3 1/2 in	1	144
1060 mm	5 in	1	147

Spare Nuts for Quick-Adjust Pipe Wrenches



1610-nut/1620-nut

Ø	g		
11 mm	34 g	1	1610-NUT
11.5 mm	48 g	1	1620-NUT

Swedish Model 90° Pipe Wrench with Green Powder Coat



DOW175

L	max		
310 mm	1 in	1	DOW 175-1
420 mm	1 1/2 in	1	DOW 175-11/2
560 mm	2 in	1	DOW 175-2
630 mm	3 in	1	DOW 175-3

Corner Pipe Wrench



442 B-444 B

L	max		
320 mm	1 in	1	442 B
430 mm	2 in	1	443 B
545 mm	2 1/2 in	1	444 B

Swedish Model Corner Combination Pipe Wrench



341-344

L	max		
230 mm	1/2 in	1	341
330 mm	1 in	1	342
420 mm	1 1/2 in	1	343
530 mm	2 in	1	344

Swedish Model Corner Combination Pipe Wrench with Green Powder Coat



DOW177

L	max		
325 mm	1 in	1	DOW 177-1/2-1
425 mm	1 1/2 in	1	DOW 177-11/2
534 mm	2 in	1	DOW 177-2

Swedish Model 45° Corner Pipe Wrench with Green Powder



DOW176

L	max		
330 mm	1 in	1	DOW 176-1
415 mm	1 1/2 in	1	DOW 176-11/2
530 mm	2 in	1	DOW 176-2

Spare Fixed Jaw for Aluminium Pipe Wrenches



8100F

	g		
380-18	90 g	1	8100F0180
380-24	180 g	1	8100F0240
380-36	226 g	1	8100F0360

Mobil Jaws for Stillson Wrench



8060B

	g		
361-8	80 g	1	8060B0080
361-10	200 g	1	8060B0100
361-12	270 g	1	8060B0120
361-14	330 g	1	8060B0140
361-18	520 g	1	8060B0180
361-24	970 g	1	8060B0240
361-36	1630 g	1	8060B0360

Multipurpose Aluminium Pipe Wrenches



380

L	max		
253 mm	1.1/2 in	1	380-10
320 mm	2 in	1	380-14
455 mm	2.1/2 in	1	380-18
607 mm	3 in	1	380-24
910 mm	4 in	1	380-36
1210 mm	6 in	1	380-48

Spare Nuts for Aluminium Pipe Wrench



8100T

	g		
380-10	30 g	1	8100T0100
380-14	45 g	1	8100T0140
380-18	70 g	1	8100T0180
380-24	110 g	1	8100T0240
380-36	220 g	1	8100T0360

Spare Nut for Stillson Wrench



8060T

	g		
361-8	20 g	1	8060T0080
361-10	20 g	1	8060T0100
361-14	40 g	1	8060T0140
361-18	70 g	1	8060T0180
361-24	90 g	1	8060T0240
361-36	250 g	1	8060T0360

Spare Mobil Jaws for Aluminium Pipe Wrenches



8100B

	g		
380-14	430 g	1	8100B0140
380-24	1000 g	1	8100B0240
380-36	1810 g	1	8100B0360

Stillson Pipe Wrenches



361

L	max		
185 mm	1 in	1	361-8
230 mm	1.1/2 in	1	361-10
265 mm	1.3/4 in	1	361-12
315 mm	2 in	1	361-14
450 mm	2.1/2 in	1	361-18
535 mm	3 in	1	361-24
900 mm	4 in	4	361-36

Heavy Duty Chain Pipe Wrenches



372

L			
1,1 in		1	372-1.1/2
2,1 in		1	372-2.1/2
4 in		1	372-4
6 in		1	372-6
8 in		1	372-8
12 in		1	372-12



Spare Chains For Special Pipe Wrenches



3074

L	Icon	Icon	Icon
340 mm			1 307401B
475 mm			1 307411B
560 mm			1 307421B
830 mm			1 307431B
1000 mm			1 307441
1400 mm			1 307451

Chain Pipe Wrenches with Steel Handle



370

L	Icon	Icon	Icon
300 mm			1 370-4

Special Pipe Wrenches with Nylon Strap and Steel Handle



375

L	Icon	Icon	Icon
300 mm			50 375-8

Telescopic Basin Wrenches with 4 Positionings



363

L	Icon	Icon	Icon
280 mm			1 363-32

TUBE CUTTING TOOLS

Pipe Cutters



401-16

Icon	Icon	Icon	Icon
			12 401-16

Pipe Cutters 3 mm-28 mm



401-28

Icon	Icon	Icon	Icon
			12 401-28

Pipe Cutters 3 mm-35 mm



402-35

Icon	Icon	Icon	Icon
			6 402-35

Pipe Cutters with Quick Adjust System



402-76

Icon	Icon	Icon	Icon
			6 402-76

Automatic Tube Cutter 10-22 mm



306-

Icon	Icon	Icon	Icon
			1 306-10
			1 306-12
			12 306-15
			12 306-22

Compact Tube Cutter 3-16 mm



301-16

3-16 mm	72 mm	12	301-16

Tube Cutter 35-75 mm



302-76

	1	302-76-95

Spare Wheels Set and Pin for 301/302 Pipe Cutters



302-95-SET

30 g	1	302-95-SET

Compact Tube Cutter 3-22 mm



301-22

3-28 mm	12	301-22

Tube Cutter with Quick Adjust System 12-76 mm



302-76N

12-76 mm	318 mm	6	302-76N

Spare Cutting Wheels for 306 Series Tube Cutters

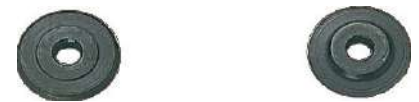

306-15-95

10 g	1	306-15-95

Tube Cutter 8-35 mm



302-35

3-35 mm	6	302-35

Spare Cutting Wheels for 301/302 & 401/402 Series Tube Cutters



302/402-15-95

301/302 Pipe Cutters	5 g	100	302-15-95
401/402 Pipe Cutters	5 g	1	402-15-95

Spare Wheels and Pins for 401/402 Pipe Cutters



402-95-SET

30 g	1	402-95-SET



Plastic Tube Cutter



311-32

32 mm	6	311-32

Plastic Pipe Scissors for PEX



412-28-PEX

28 mm	5	412-28-PEX

Spare Blades for 412-28-PEX Pipe Scissors



412-28-PEX-95

1	35 g	30	412-28-PEX-95

Geared Plastic Tube Cutter



311-42

0-42 mm	6	311-42

Plastic Pipe Scissors for Multilayer



412-26-MULTI

26 mm	5	412-26-MULTI

Spare Blades for 412-26-MULTI Plastic Pipe Cutters



412-26-MULTI-95

1	10 g	150	412-26-MULTI-95

Plastic Pipe Scissors



411

26 mm	4	411-26
35 mm	4	411-35
42 mm	6	411-42
63 mm	5	411-63

Spare Blades for Plastic Pipe Scissors



411-95

1	39 g	50	411-26-95
1	37 g	50	411-35-95
1	41 g	50	411-42-95
1	48 g	30	411-63-95

BENDING & FORMING TOOLS

Multipurpose Tube Bender



1084

250 mm	6, 8, 10 mm	5	1084

Standard Task Tube Bender Kit



1084-KIT



10,12,14,15,16,18,20 & 22 mm

1 1084-KIT

Tube Bender



500



12 mm	1	500-12
14 mm	1	500-14
15 mm	1	500-15
16 mm	1	500-16
18 mm	1	500-18
22 mm	1	500-22

Tube Flaring Tool In Metric Sizes



4480MM



45° 4, 6, 8, 10, 12, 14, 16, 18 mm

1 4480MM

Imperial Tube Flaring Tool



4480IM



45° 5/8, 3/16, 1/4, 5/16, 3/8, 7/16, 1/2, 3/4 in

1 4480IM

Tube Cutter and Double Flaring Tool Set



4480/



45 x 140 x 330 mm

1 4480/2-ZD

DEBURRING TOOLS

Aluminium Pen Reamer



316-1



143 mm

12 316-1

Plastic Pen Reamer



316-2



150 mm

12 316-2

Spare Blade for 316-2 Pen Reamer



316-2-95



3 g

1 316-2-95

Aluminium Wheel Reamer



318-38/318-54



8-38 mm

1 318-38

10-54 mm

1 318-54

Plastic Wheel Reamer



317-40



3-40 mm

12 317-40







Air Tools



IMPACT WRENCHES

3/8" Square Drive Mini Impact Wrenches



BP704

BAR



6.3 bar 1500 min 1 BP704

3/8" Square Drive Lightweight Impact Wrenches with Twin Hammer Mechanism



BP815

BAR



7,000 min 6.3 bar 1 BP815

BPC816

BAR

12.000 min

6.3 bar



10 BPC816

1/2" Square Drive Angle Impact Wrenches with Jumbo Hammer Mechanism



BP814A

BAR

7000 min

6.2 bar



10 BP814A

1/2" Impact Wrenches with Twin Hammer Mechanism 360 N.m



BP814

BAR

10,000 min

6.3 bar



10 BP814

1/2" Impact Wrenches with Twin Hammer Mechanism 620 N.m



BP815

BAR



7,000 min 6.3 bar 1 BP815

1/2" Impact Wrench Kit - 13 Pcs



BP815K1

BAR

7,000 min

6.3 bar



1 BP815K1

BP815

K7800M-10, K7800M-11, K7800M-12, K7800M-13, K7800M-14, K7800M-15, K7800M-17, K7800M-19, K7800M-22, K7800M-24, K7800M-21

PM5142



1/2" Impact Wrench Kit - 3 Pcs



BP815K2

BAR

7,000 min

6.3 bar



1 BP815K2

1/2" Square Drive Micro Impact Wrenches with Twin Hammer Mechanism



BPC813

BAR

10000 min

6.3 bar



10 BPC813

1/2" Square Drive Micro Impact Wrench Set with Ultra Short Sockets



BPC813K1



1/2 in 65 x 162 x 215 mm 1 BPC813K1

BPC813

K7800M-13, K7800M-14, K7800M-16, K7800M-17, K7800M-19, K7800M-21, K7800M-22, K7800M-24



1/2" Composite Impact Wrenches with Twin Hammer Mechanism 338 N.m



BPC814



BAR



12000 min 6,3 bar 10 BPC814

1/2" Composite Impact Wrenches with Twin Hammer Mechanism 786 N.m



BPC815



BAR



8000 min 6,3 bar 1 BPC815

1/2" Square Drive Impact Wrench Set with 11 Metric Sockets



BPC815K1



1/2 in 90 x 230 x 390 mm 1 BPC815K1

BPC815

K7801M-10, K7801M-11, K7801M-12, K7801M-13, K7801M-14, K7801M-15, K7801M-17, K7801M-19, K7801M-21, K7801M-22, K7801M-24



1/2" Square Drive Impact Wrench Set with 5 Metric Sockets



BPC815K2



1/2 in 90 x 230 x 320 mm 1 BPC815K2

BPC815

K7801M-19, K7801M-22, K7801M-24, K7801M-17, K7801M-13



1/2" Square Drive Impact Wrench Set with 5 Imperial Sockets



BPC815K3



1/2 in 90 x 230 x 320 mm 1 BPC815K3

BPC815

K7801Z-1/2, K7801Z-5/8, K7801Z-3/4, K7801Z-7/8, K7801Z-15/16



1/2" Square Drive Impact Wrench Set with 5 Wheel Metric Sockets



BPC815K4



1/2 in 90 x 230 x 320 mm 1 BPC815K4

BPC815

BWSS12P5



1/2" Square Drive Impact Wrench Set with 2 Wheel Metric Sockets



BPC815K6



1/2 in 90 x 230 x 320 mm 1 BPC815K6

BPC815

BWSS12P319, BWSS12P317



3/4" Impact Wrenches with Twin Hammer Mechanism 950 N.m



BP817



BAR



4,500 min 6,3 bar 1 BP817

3/4" Square Drive Lightweight Impact Wrenches with Twin Hammer Mechanism



BPC817



BAR



5000 min 6,2 bar 4 BPC817



3/4" Square Drive Impact Wrench Set with 4 Metric Sockets



BPC817K1

3/4 in	105 x 295 x 390 mm	1	BPC817K1

BPC817
K8901M-24, K8901M-27, K8901M-32, K8901M-30

3/4" Square Drive Impact Wrench Set with 4 Imperial Sockets



BPC817K2

3/4 in	105 x 295 x 390 mm	1	BPC817K2

BPC817
K8901Z-15/16, K8901Z-1, K8901Z-1.1/16, K8901Z-1.1/8

1" Square Drive Lightweight Impact Wrenches with Durable Rocking Dog Mechanism



BP901

3800 min ⁻¹	6.2 bar	1	BP901

1" Square Drive Lightweight Impact Wrenches with Durable Rocking Dog Mechanism and 9" Anvil



BP901L

3800 min ⁻¹	6.2 bar	1	BP901L

1" Square Drive Lightweight Impact Wrenches with Twin Hammer Clutch Mechanism



BP905P

6000 min ⁻¹	6.2 bar	2	BP905P

1" Square Drive Lightweight Impact Wrenches with Twin Hammer Mechanism and Short Anvil



BP905S

6000 min ⁻¹	6.2 bar	2	BP905S

1" Square Drive Lightweight Impact Wrenches with Twin Hammer Mechanism and Long Anvil



BP905L

6000 min ⁻¹	6.2 bar	2	BP905L

Impact Wrench Boots with Rubber Protection



BPM91B

85 x 80 x 180 mm	162 g	1	BPM91BBOOT

Impact Wrench Silencer Kit



BPM91MK

30 x 25 x 25 mm	5 g	1	BPM91MK1
30 x 25 x 50 mm	10 g	1	BPM91MK2

RATCHETS

1/4" Mini Air Ratchets with Power Regulator



BP700

	BAR		
300 min	6.3 bar	20	BP700

1/2" Ratchets with Rubber Grip



BP821

	BAR		
150 min	6.3 bar	1	BP821

GRINDERS, SANDERS & POLISHERS

Angle Die Grinders with Rubber Grip



BP115

	BAR		
20,000 min	6.3 bar	1	BP115

3/8" Square Drive Stubby Air Ratchets



BP721

	BAR		
350 min	6.3 bar	1	BP721

1/2" Square Drive Reactionless Impact Ratchet



BPR821

	BAR		
600 min	6.3 bar	1	BPR821

Low Revolution Air Grinder/Tyre Buffers with Hex Quick Change Chuck



BP117

	BAR		
2500 min	6.3 bar	1	BP117

3/8" Air Ratchets with Power Regulator



BP820

	BAR		
270 min	6.3 bar	1	BP820

Air Ratchet Boots for 1/4" Ratchets



BP91B

35 x 40 x 60 mm	12 g	1	BP91BL
30 x 30 x 45 mm	6 g	1	BP91BS

Low Speed Air Grinder/Tyre Buffers with Keyed Chuck



BP118

	BAR		
2500 min	6.3 bar	1	BP118



Die Grinders with Rubber Grip



BP822

	BAR		
25,000 min	6.3 bar	1	BP822

Coarse Grinding Bullet Abrasive Wheels with 6 mm Shank - 2 Pcs/Blister Pack



BP421M

53 mm	14 mm	1	BP421M

Coarse Grinding 90° Cone Abrasive Wheels with 6 mm Shank - 2 Pcs/Blister Pack



BP424M

57 mm	19 mm	1	BP424M

Air Die Grinders with 6 mm Shank, Long Anvil and Rubber Grip



BP822E

	BAR		
25000 min	6.3 bar	10	BP822E

Coarse Grinding Cylindrical Abrasive Wheels with 6 mm Shank - 2 Pcs/Blister Pack



BP422M

46 mm	26 mm	1	BP422M

Fine Grinding Conical Round Nose Abrasive Wheels with 3 mm Shank - 2 Pcs/Blister Pack



BP430M

55 mm	12 mm	1	BP430M

Coarse Grinding Conical Round Nose Abrasive Wheels with 6 mm Shank - 2 Pcs/Blister Pack



BP420M

67 mm	25 mm	1	BP420M

Coarse Grinding Spherical Abrasive Wheels with 6 mm Shank - 2 Pcs/Blister Pack



BP423M

53 mm	25 mm	1	BP423M

Fine Grinding Small Bullet Abrasive Wheels with 3 mm Shank - 2 Pcs/Blister Pack



BP431M

54 mm	13 mm	1	BP431M

BAHCO

Fine Grinding Small 90° Cone Abrasive
Wheels with 3 mm Shank - 2 Pcs/Blister
Pack



BP432M

44 mm	15 mm	1	BP432M

Reversible Cut-Off Tools



BP110

	BAR		
18,000 min	6.3 bar	1	BP110

Exhaust Hoses for BP117 Low Revolution
Grinder/Tyre Buffers



BP117EH

50 x 100 x 50 mm	1 kg	1	BP117EH

Fine Grinding Small Tapered Ball Abrasive
Wheels with 3 mm Shank - 2 Pcs/Blister
Pack



BP433M

43 mm	14 mm	1	BP433M

Disc Grinders with Rubber Grip and Safety
Trigger



BP823

	BAR		
10,000 min	6.3 bar	1	BP823

Surface Cleaners with 19 Needles



BP127

	BAR		
3700 min	6.3 bar	1	BP127

Fine Grinding Small Cylindrical Abrasive
Wheels with 3 mm Shank - 2 Pcs/Blister
Pack



BP434M

45 mm	13 mm	1	BP434M

4"/102 mm Extended Air Cut-Off Tools



BP111E

	BAR		
15000 min	6.3 bar	12	BP111E

Pistol Grip Surface Cleaners with 19
Needles



BP127P

	BAR		
3800 min	6.3 bar	1	BP127P



Needle Set



BP12718



BP127, BP127P 3 mm 1 BP12718

Rubber Dish Solvent Based



BP830ESB

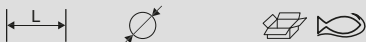

30 mm 105 mm 1 BP830ESB

Straight Bristles Adaptor



BP830SBA

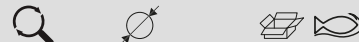

BP830K 105 mm 1 BP830SBA

Coarse Inclined Steel Bristles



BP830CISB



BP830K 105 mm 1 BP830CISB

Rubber Eraser, Water Based



BP830EWB



BP830K 105 mm 1 BP830EWB

Straight Steel Bristles



BP830SSB

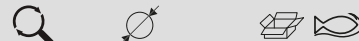

BP830K 105 mm 1 BP830SSB

Air Blaster Kit



BP830K



4000 min⁻¹ 6.3 bar 4 BP830K

Straight Steel Bristles

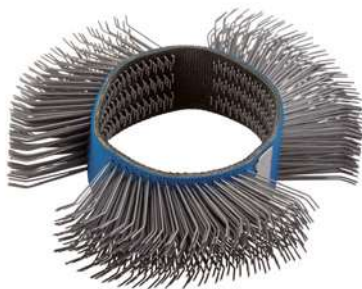

BP830MISB

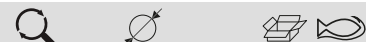

BP830K 105 mm 1 BP830MISB

Stripping Wheel



BP830SW

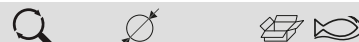

BP830K 105 mm 1 BP830SW

Pistol-Grip Air Sander Set - 71 Pcs



BP204K

	BAR		
15000 min	6.3 bar	1	BP204K

BP20425180, BP20410800, BP20410320,
BP20425220

BP204

Sanding Pads for BP204 Pistol-Grip Sander



BP204PAD

77 mm	-	1	BP204PAD

Belt Sanders with Quick Belt Release Button



BP212

	BAR		
16,000 min	6.3 bar	1	BP212

Orbital Sander Pads with Velcro Pad



BP51137

152 mm	x	1	BP51137

5 mm Palm Orbital Sanders with Velcro Pad



BP601

	BAR		
152 mm	6.3 bar	1	BP601

Velcro Pad 53 Holes



BP60102

BP601	152 mm	1	BP60102

3" Pistol Grip Orbital Air Sanders with Rubber Grip



BP204

	BAR		
15000 min	6.3 bar	1	BP204

Sanding Discs for 3" Wheel Sanders



BP204xxxxyy

77 mm	1	BP20410320
77 mm	1	BP20410800
77 mm	1	BP20425180
77 mm	1	BP20425220

20 mm Belt Sanders with Quick Belt Release Button



BP222

	BAR		
16,000 min	6.3 bar	1	BP222



2.5 mm Palm Orbital Sanders with Velcro Pad



BP610

	BAR		
152 mm	6.3 bar	1	BP610

7" Vertical Air Polishers with Rubber Grip



BP810

	BAR		
2500 min	6.3 bar	1	BP810

1/2" Reversible Air Drills 800 rpm



BPC825

	BAR		
800 min	6.3 bar	1	BPC825

Pack of 25 Belts for Belt Sanders



BPN22201/21201

10 mm	15 g	1	BPN21201
20 mm		1	BPN22201

7" Wool Bonnets



BP80950

178 mm	15 g	1	BP80950

3/8" Compact Reversible Air Drills 2,000 rpm



BPC823

	BAR		
2000 min	6.3 bar	1	BPC823

DRILLS & SCREWDRIVERS

7" Air Angle Polishers with Rubber Grip and Spindle Lock



BP809

	BAR		
2500 min	6.3 bar	1	BP809

1/2" Reversible Drills with Rubber Grip 13 mm



BP825

	BAR		
450 min	6.3 bar	1	BP825

3/8" Compact Angle Air Drills 1,400 rpm



BPA823

	BAR		
1400 min	6.3 bar	1	BPA823

1/4" Air Screwdrivers 1800 rpm



BP826

	BAR		
1800 min	6.3 bar	1	BP826

Reciprocating Saws with Safety Trigger



BP824

	BAR		
10,000 min	6.3 bar	1	BP824

Flat and Jagged Straight Blades



BPBG

15 mm	1	BPBG3515
25 mm	1	BPBG3525A
25 mm	1	BPBG3525B

1/4" Air Screwdrivers 800 rpm



BP827

	BAR		
800 min	6.3 bar	1	BP827

Geared Reciprocating Saws with Safety Trigger



BPG824

	BAR		
7400 min	6.3 bar	10	BPG824

Offset Comma Shaped Blades - 2 Pcs/Blister Pack



BPBK

30 mm	1	BPBK30

CUTTING TOOLS

Compact Reciprocating Saws with Safety Trigger



BP828

	BAR		
10000 min	6.3 bar	1	BP828

Windscreen Removers with Low Vibration



BP233

	BAR		
20	6.3 bar	1	BP233

Scrapers - 2 Pcs/Blister Pack



BPBSC

15 mm	1	BPBSC156



U Shaped Blades - 2 Pcs/Blister Pack



BPBU

Length (mm)	Quantity	Part Number
18 mm	1	BPBU18
24 mm	1	BPBU24
36 mm	1	BPBU36
60 mm	1	BPBU60
90 mm	1	BPBU90

Air Metal Shears with Rubber Grip and Safety Trigger



BP811

Speed (min ⁻¹)	Pressure (bar)	Quantity	Part Number
2,600 min ⁻¹	6.3 bar	1	BP811

Straight Offset Blades - 2 Pcs/Blister Pack



BPBG5725/9057

Length (mm)	Quantity	Part Number
57 mm	1	BPBG5725
90 mm	1	BPBG9057

HAMMERS, RIVETERS & MARKERS

Air Hammers 3200 bpm



BP910

Pressure (bar)	Speed (bpm)	Quantity	Part Number
6.3 bar	3200	5	BP910

Rotating Tapered Punch Chisels with 10.2 mm Shank



BP909TTP

Length (mm)	Quantity	Part Number
165 mm	1	BP909TTP

Rotating Flat Chisels with 10.2 mm Shank



BP909TF

Length (mm)	Quantity	Part Number
170 mm	1	BP909TF

Rotating Edging Chisels with 10.2 mm Shank



BP909TE

Length (mm)	Quantity	Part Number
139 mm	1	BP909TE

Rotating Wide Flat Chisels with 10.2 mm Shank



BP909TWF

Length (mm)	Quantity	Part Number
170 mm	1	BP909TWF

Rotating Hammer Chisels with 10.2 mm Shank



BP909TH

Length (mm)	Quantity	Part Number
108 mm	1	BP909TH

Rotating Straight Punch Chisels with 10.2 mm Shank



BP909TSP



165 mm



1 BP909TSP

Non-Rotating Flat Chisels with 10.2 mm Shank



BP909NF



190,5 mm



1 BP909NF

Non-Rotating Edging Chisels with 10.2 mm Shank



BP909NE



173 mm



1 BP909NE

Air Riveters 880 kg pulling force



BP277K

BAR



6.3 bar

14



8 BP277K

Air Riveters 1600 kg pulling force



BP125A

BAR



6.3 bar

19



6 BP125A

Carbide Tips for Air Engraving Pen



BP79912



10 g



1 BP79912

Air Caulking Guns with 300 ml Cartridge Applicator



BP215A

BAR

3.5-4.8 bar



10 BP215A

PAINT GUNS

HVLP Spray Painting Guns



Air Engraving Markers with Low Vibration



BP799



13,000 min

BAR

6.3 bar



1 BP799

BPHVLP01



0.7 kg

BAR

2-2.8 bar



1 BPHVLP01



Nozzle Set for BPHVLP01 HVLP Painting Spray Guns



BPHVLP



1.2 mm	1 BPHVLP0112
1.4 mm	1 BPHVLP0114
1.7 mm	1 BPHVLP0117
2.0 mm	1 BPHVLP0120

Air Blow Guns with Brass Inlet and Removable Safety Tip Long Nozzle



BP219L

BAR



6.3 bar	1 BP219L
---------	----------

Cleaning Guns with Steel Nozzle



BPN010

BAR



6.2 bar	6000-7500 min	1 BPN010
---------	---------------	----------

BLOWING & CLEANING TOOLS

Air Blow Guns with Brass Inlet



BP218

BAR



6.3 bar	1 BP218
---------	---------

Air Blow Guns with Brass Inlet 1 m Extra Long Nozzle



BP219XL

BAR



6.3 bar	100 l/min	10 BP219XL
---------	-----------	------------

AIR TOOLS ACCESSORIES & EQUIPMENT

Magnetic Holders for Impact and Torque Wrenches



BP500



0.380 kg	1 BP500
----------	---------

Air Blow Guns with Brass Inlet and Removable Safety Tip



BP219

BAR



6.3 bar	1 BP219
---------	---------

Air Blow Vacuum Guns with Removable Safety Tip



BP219V

BAR



6.3 bar	1 BP219V
---------	----------

1/2" Filter Regulator Units



BP254



BAR



max 3800 L/min	l/min	1-8.5 bar	1 BP254
----------------	-------	-----------	---------

1/2" Filter Regulator and Lubricator Units



BP255

	BAR		
max 3,800 l/min	1-8.5 bar	1	BP255

Additional clean dry air outlet for 1/2" filter regulator and lubricator units with type T clean dry air outlet



BP255T-1

	BAR		
max 3800 l/min	1-8.5 bar	1	BP255T-1

Spiral Air Hoses with Threaded Connector 13 mm



BPH1310

1/2"-1/2" in	10 m	1	BPH1310A

1/4" Inline Lubricators



BPN251

1/4" in	0.100 kg	1	BPN251

Spiral Air Hoses with Threaded Connector 10 mm



BPH1010

1/4"-1/4" NPT in	10 m	1	BPH1010A
1/4"-1/4" BSP in	10 m	1	BPH1010B

Speed Control Adaptors for Rewinding Speed Control



BPHRSC

76 x 88 x 114 mm	1	BPHRSC

1/2" Filter Regulator and Lubricator Units with Type T Clean Dry Air Outlet



BP255T

	BAR		
max 3800 l/min	1-8.5 bar	1	BP255T

Air Hose Reels with 145° Swivel Steel Bracket and Optional Speed Control Adaptor



BPHRC815/1015

8 mm	15 m	1	BPHRC815
10 mm	14+1 m	1	BPHRC1015

Air Hose Reels with 145° Swivel Steel Bracket



BPHRC1020/1316

10 mm	20 m	1	BPHRC1020
13 mm	15+1 m	1	BPHRC1316



Air Hose Reels with 90° Swivel Base



BPHRO1315



13 mm 13+2 mm 1 BPHRO1315

1/4" Swivel Air Connectors



BPSJ



1/4" in 1 BPSJ

Quick Air Connectors 1/4" Female



BPQCF14



1/4" in 10 BPQCF14

1/4" Swivel Air Connectors with Rotation Lock System



BPSJL



1/4" in 1 BPSJL



Cordless Power Tools



IMPACT WRENCHES

12 V 1/4" Square Drive Cordless Impact Wrenches



BCL31IW1



12 V 1/4" 1 BCL31IW1

12 V 1/4" Square Drive Cordless Impact Wrench Kit



BCL31IW1K1



110 x 310 x 390 mm 3.1 kg 1 BCL31IW1K1

BCL31B1x 2



BCL31C1



BCL31IW1



14.4 V 3/8" Square Drive Cordless Brushless Impact Wrenches



BCL32IW1



14.4 V 3/8" 1 BCL32IW1

14.4 V 3/8" Square Drive Cordless Brushless Impact Wrench Kit



BCL32IW1K1

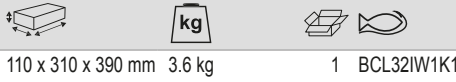

110 x 310 x 390 mm 3.6 kg 1 BCL32IW1K1

BCL32IW1



BCL32B1x 2



BCL31C1



18 V 1/2" Square Drive Cordless Impact Wrench Kit



BCL33IW1K1

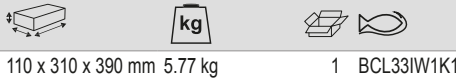

110 x 310 x 390 mm 5.77 kg 1 BCL33IW1K1

BCL33C1



BCL33IW1



BCL33B3x 2



18 V 1/2" Square Drive Cordless Impact Wrenches



BCL33IW1



18 V 1/2" 1 BCL33IW1

18 V 1/2" Square Drive Cordless Brushless Impact Wrench Kit



BCL33IW2K1

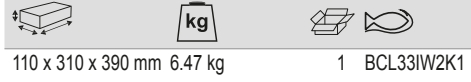

110 x 310 x 390 mm 6.47 kg 1 BCL33IW2K1

BCL33IW2



BCL33C1



BCL33B3x 2



RATCHETS

12 V 1/4" Cordless Square Drive Ratchet Wrenches



BCL31R1



12 V 1/4" 1 BCL31R1

12 V 1/4" Cordless Square Drive Ratchet Wrench Kit



BCL31R1K1

110 x 310 x 390 mm	3.1 kg	1	BCL31R1K1

BCL31B1x 2	
BCL31C1	
BCL31R1	

DRILLS & SCREWDRIVERS

18 V 1/2"-13 mm Cordless Brushless Drill Drivers



BCL33D1

18 V	1/2 in	1	BCL33D1

18 V 1/2"-13 mm Cordless Drill Driver Kit



BCL33D1K1

110 x 310 x 390 mm	3.7 kg	1	BCL33D1K1

BCL33C1	
BCL33D1	
BCL33B1x 2	

12 V 3/8"-10 mm Cordless Drill Drivers



BCL31D1

12 V	360/1550 min ⁻¹	1	BCL31D1

12 V 3/8"-10 mm Cordless Drill Driver Kit



BCL31D1K1

110 x 310 x 390 mm	3.15 kg	1	BCL31D1K1

BCL31B1x 2	
BCL31C1	
BCL31D1	

12 V 1/4" Cordless Compact Impact Drivers with Quick Release Hex Drive



BCL31IS1

12 V	1/4 in	1	BCL31IS1

12 V 1/4" Cordless Compact Impact Driver with Quick Release Hex Drive Kit



BCL31IS1K1

110 x 310 x 390 mm	3.1 kg	1	BCL31IS1K1

BCL31B1x 2	
BCL31IS1	
BCL31C1	

12 V 1/4" Cordless Two Speed Drivers



BCL31SD1

12 V	1/4 in	1	BCL31SD1

12 V 1/4" Cordless Two Speed Driver Kit



BCL31SD1K1

110 x 310 x 390 mm	2.99 kg	1	BCL31SD1K1

BCL31SD1	
BCL31B1x 2	
BCL31C1	



GRINDERS, SANDERS & POLISHERS

14.4 V Cordless 2" Sanders and 3" Polishers



BCL32SP1

V			
14,4 V	1900/6900 min	1	BCL32SP1

18 V Cordless Orbital Angle Polishers with 5" Pad



BCL33AP1

V			
18 V	1100-3500 min	1	BCL33AP1

14.4 V Cordless 2" Sanders and 3" Polishers Kit



BCL32SP1K1

	kg		
265 x 290 x 480 mm	3.29 kg	1	BCL32SP1K1

BCL32SP1	
BCL32B1x 2	
BCL31C1	

18 V Cordless Orbital Angle Polisher Kit with 5" Pad



BCL33AP1K1

	kg		
265 x 290 x 480 mm	5.78 kg	1	BCL33AP1K1

BCL33AP1	
BCL33B3x 2	
BCL33C1	

14.4 V 6 mm Cordless Collet Die Grinders



BCL32DG1

V			
14,4 V	21000 min	1	BCL32DG1

14.4 V 6 mm Cordless Collet Die Grinder Kit



BCL32DG1K1

	kg		
110 x 310 x 390 mm	3.2 kg	1	BCL32DG1K1

BCL32DG1	
BCL32B1	
BCL31C1	

14.4 V Cordless Greaser Kit with GR-400 Container



BCL32G1K1

	kg		
265 x 290 x 480 mm	5.22 kg	1	BCL32G1K1

BCL32G1	
BCL31C1	
BCL32B1x 2	

CUTTING TOOLS

14.4 V Cordless Reciprocating Saws



BCL32RS1

V			
14,4 V	3000 min	1	BCL32RS1

14.4 V Cordless Reciprocating Saw Kit



BCL32RS1K1

	kg		
265 x 290 x 480 mm	3.5 kg	1	BCL32RS1K1

BCL32RS1
 BCL32B1x 2
 BCL31C1



GREASERS

14.4 V Cordless Greasers with GR-400 Container Capacity



BCL32G1

V 14,4 V 400 g 1 BCL32G1

BATTERIES & CHARGERS

12 V 2 Ah Lithium-Ion Batteries



BCL31B1

V 12 V 2 A·h 1 BCL31B1

14.4 V 2 Ah Lithium-Ion Batteries



BCL32B1

V 14,4 V 2 A·h 1 BCL32B1

18 V 2 Ah Lithium-Ion Batteries



BCL33B1

V 18 V 2 A·h 1 BCL33B1

18 V 5 Ah Lithium-Ion Batteries



BCL33B3

V 18 V 2 A·h 1 BCL33B3

12 V-14.4 V 3 A Battery Chargers



BCL31C1

V_{in} 220 V **V**_{out} 12/14.4 V 1 BCL31C1

18 V 2.3 A Battery Chargers



BCL33C1

V_{in} 220 V **V**_{out} 18 V 1 BCL33C1

18 V 3.4 A Quick Battery Chargers



BCL33C2

V_{in} 220 V **V**_{out} 18 V 1 BCL33C2





BAHCO

ENGINE TOOLS

Timing kit for FCA Group 1.4 Multiair engines



BE501101



68 x 225 x 280 mm

1 BE501101

BE50110101



BE50110102



BE50110103



BE50110104



Timing kit for FCA Group 0.9 petrol Twinair



BE501102



68 x 225 x 280 mm

1 BE501102

BE50110202



BE50110203



Timing kit for FCA Group 1.6-1.9-2.0-2.4 diesel



BE501203



68 x 225 x 280 mm

1 BE501203

BE50120301



BE50120302



BE50120303



BE50120305



BE50110103



BMW crankshaft harmonic balancer holder



BE502104



60 x 98 x 269 mm

1726 g

8 BE502104

BMW crankshaft holding tool



BE502106



80 x 70 x 260 mm

10 BE502106

BE50110202



BE50110203



Timing kit for FCA Group 1.3 JTD MJ



BE501204



68 x 225 x 280 mm

1 BE501204

BE50120401



BE50120402



BE50120403



BE50120404



BE50120405



Timing kit for BMW 1.8-2.0 petrol

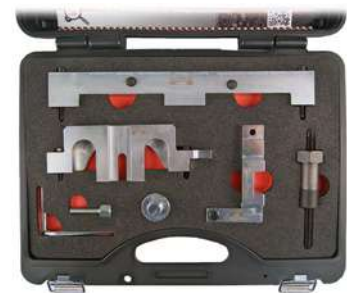

BE502101



95 x 270 x 350 mm

1 BE502101

BE50210101



BE50210102



BE50210103



BE50210104



BE50210105



BE50210106



BE50210107



Timing kit for BMW 1.6 petrol

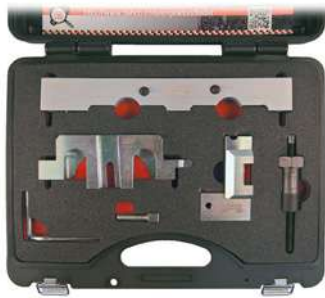

BE502102



270 x 95 x 355 mm



1 BE502102

BE50210103	
BE50210105	
BE50210107	
BE50210201	
BE50210202	
BE50210203	

Timing kit for BMW 1.6-2.0 petrol

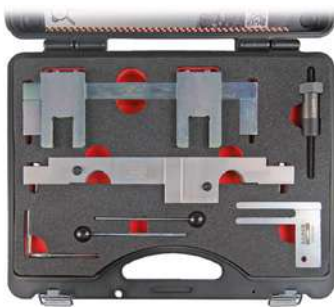

BE502103



80 x 300 x 375 mm



1 BE502103

BE50210301	
BE50210302	
BE50210303	
BE50210305	
BE50210105	
BE50210107	

Timing kit for BMW 2.0 - 2.5 - 3.0 diesel



BE502204



68 x 225 x 280 mm



1 BE502204

BE50220401	
BE50220403	
BE50220404	
BE50220405	
BE50210305	

Timing kit for BMW Mini 1.6-2.0 diesel



BE503201



68 x 225 x 280 mm



1 BE503201

BE50320101	
BE50320102	
BE50320103	
BE50320105	
BE50210305	

Timing kit for MINI-PSA 1.4-1.6 petrol



BE504102



95 x 270 x 350 mm



1 BE504102

BE50410201	
BE50410202	
BE50410203	
BE50410204	
BE50410206	
BE50210105	

Timing kit for MINI-PSA 1.6 diesel



BE504201



50 x 50 x 220 mm



1 BE504201

BE50420101	
BE50420102	
BE50420103	
BE50420104	
BE50210305	



Timing kit for Ford 1.25-1.4-1.6 petrol



BE505101

68 x 225 x 280 mm 1 BE505101

- BE50510101
- BE50510102
- BE50510103
- BE50510104
- BE50510105
- BE50510106

Timing kit for Ford 1.0 EcoBoost petrol



BE505102

95 x 270 x 350 mm 1 BE505102

- BE50510201
- BE50510202
- BE50510203
- BE50510204
- BE50420102
- BE50510102

Timing kit for Ford 2.0 - 2.2 - 2.4 Duratorq TDCI 16v diesel



BE505203

95 x 270 x 350 mm 1 BE505203

- BE50520301
- BE50520302
- BE50520303
- BE50520304
- BE50520305
- BE50520306
- BE50520307

Timing kit for Ford 1.4-1.6-1.8-2.0-2.2-2.5 diesel



BE505204

95 x 270 x 350 mm 1 BE505204

- BE50520401
- BE50520402
- BE50520403
- BE50520404
- BE50520405
- BE50520407
- BE50520411
- BE50520412
- BE50520413
- BE50510104
- BE50420102
- BE50420103
- BE50420104
- BE50510106

Timing kit for Opel 1.0-1.2-1.4 petrol



BE506101

50 x 50 x 160 mm 1 BE506101

- BE50610101
- BE50610102
- BE50610103
- BE50610104
- BE50610105

Timing kit for Opel 1.4-1.6-1.8 petrol



BE506102

68 x 225 x 280 mm 1 BE506102

- BE50610201
- BE50610202
- BE50610203
- BE50610204
- BE50610205
- BE50610206

Timing kit for Opel 1.0-1.2-1.4 Ecoflex petrol



BE506103

95 x 270 x 350 mm 1 BE506103

- BE50610302
- BE50610304
- BE50610102
- BE50610103
- BE50610105

Timing kit for Opel 2.0 diesel



BE506204

85 x 300 x 375 mm 1 BE506204

- BE50620401
- BE50620402
- BE50620403
- BE50620404
- BE50620405

Timing kit for PSA 1.0-1.1-1.4-1.6-1.8-2.0-2.2 petrol



BE507101

95 x 270 x 350 mm 1 BE507101

- BE50710103
- BE50710104
- BE50710105
- BE50710106
- BE50710107
- BE50710108
- BE50710109
- BE50710110
- BE50710111
- BE50710112
- BE50710101
- BE50710102
- BE50710113
- BE50710114
- BE50710116
- BE50710117
- BE50710118
- BE50710119
- BE50420104

Timing kit for PSA 1.0-1.2 petrol



BE507102

68 x 225 x 280 mm 1 BE507102

- BE50710201
- BE50710202

Timing kit for PSA 1.4-1.5-1.6-1.9-2.0-2.2-2.5 diesel



BE507203

85 x 300 x 375 mm 1 BE507203

- BE50720302
- BE50720304
- BE50720305
- BE50720307
- BE50720308
- BE50720310
- BE50720314
- BE50720317
- BE50720318
- BE50720319
- BE50720320
- BE50720321
- BE50720322
- BE50720323
- BE50520404
- BE50520411
- BE50710107
- BE50710104
- BE50710113
- BE50710110
- BE50710102
- BE50710106
- BE50420102
- BE50420103



Timing kit for Renault/Dacia 1.2-1.4-1.6-1.8-2.0 petrol

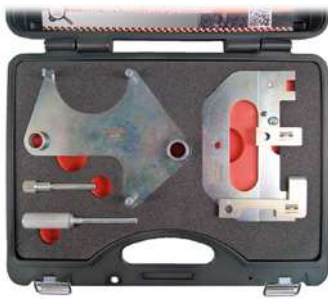

BE508101



95 x 270 x 350 mm

1 BE508101

- BE50810101
- BE50810103
- BE50810104
- BE50810106

Timing kit for Renault 1.5-1.9-2.2-2.5 diesel



BE508202



80 x 300 x 375 mm

1 BE508202

- BE50820201
- BE50820202
- BE50820203
- BE50820204
- BE50820205
- BE50820206
- BE50820207
- BE50820208
- BE50820209
- BE50820211
- BE50810103
- BE50810104

Timing kit for Renault 2.0 diesel



BE508203



68 x 225 x 280 mm

1 BE508203

- BE50820301
- BE50820302
- BE50820303
- BE50820304
- BE50210305

Timing set for Renault-Nissan 1.6 diesel



BE508204



95 x 270 x 350 mm

1 BE508204

- BE50820402
- BE50820403
- BE50820404
- BE50820302

Timing kit for VW Group 1.4-1.6-1.8-2.0 petrol



BE509101



80 x 300 x 375 mm

1 BE509101

- BE50910101
- BE50910102
- BE50910103
- BE50910104
- BE50910105
- BE50910106
- BE50910107
- BE50910108
- BE50910109
- BE50910110
- BE50910111
- BE50910112
- BE50910114
- BE50520302

Timing kit for VW Group 1.2-1.4-1.6 petrol



BE509102



68 x 225 x 280 mm

1 BE509102

- BE50910201
- BE50910202
- BE50910203
- BE50910205
- BE50910206
- BE50910207
- BE50520302

Timing kit for VW Group 1.2 TSI petrol



BE509103



50 x 50 x 210 mm

1 BE509103

BE50910302



BE50910203



Timing kit for VW Group 1.0 petrol



BE509104



68 x 225 x 280 mm

1 BE509104

BE50910401



BE50910402



BE50910403



BE50910404



BE50910203



Timing kit for VW Group 1.2-1.4-1.6-1.9-2.0 diesel



BE509205_1



60 x 60 x 220 mm

1 BE509205

BE50910103



BE50920602



BE50920603



Timing kit for VW Group 1.9-2.0 diesel



BE509206



60 x 60 x 220 mm

1 BE509206

BE50920602



BE50910103



BE50920703



Timing kit for VW Group 1.2-1.4-1.6-1.9-2.0 diesel



BE509207



95 x 270 x 350 mm

1 BE509207

BE50920703



BE50920707



BE50920708



BE50920709



BE50920710



BE50910103



BE50910112



BE50920602



BE50920603



BE50910109



BE50510102



Timing kit for Volvo 1.6 - 1.8 - 1.9 - 2.0 - 2.3 - 2.4 - 2.5 petrol



BE510101



60 x 60 x 355 mm

1 BE510101

BE51010101



BE51010102



BE51010103



Timing kit for Volvo 1.6 - 1.8 - 2.0 16v petrol



BE510102



50 x 50 x 220 mm

1 BE510102

BE51010201



BE51010202



BE50510102



BE50510105



BE50510106



Timing kit for Volvo 1.6 - 2.0 diesel



BE510203



68 x 225 x 280 mm

1 BE510203

BE50420102



BE50420103



BE50420104



BE50520407



BE50520411



BE50510104



Crankshaft pulley holding tool for Volvo



BE510304



50 x 145 x 265 mm

1 BE510304

Timing kit for Saab 1.8i petrol



BE511101



50 x 50 x 220 mm

1 BE511101

BE51110101



BE51110102



BE50610201



BE50610204



Timing kit for Saab 1.6t petrol



BE511102



50 x 50 x 207 mm

1 BE511102

BE50610201



BE50610202



BE50610205



BE50610203



Timing kit for Saab 1.9 - 2.0 - 2.2 Tid diesel



BE511203



80 x 300 x 375 mm

1 BE511203

BE51120301



BE51120302



BE51120303



BE51120304



BE51120305



BE50120302



BE50120303



BE50120305



BE50610201



Universal set for removing broken glow plugs



BE513201



95 x 270 x 350 mm

2.10 kg

1 BE513201

BE51320101



BE51320102



BE51320103



BE51320104



BE51320105



BE51320106



BE51320107



BE51320108



BE51320109



BE51320110



BE51320111



BE51320112



BE51320113



BE51320114



Sprocket holding wrench universal



BE523106



0.41 m

1 BE523106

Adjustable Universal Camshaft Locking Tool



BE5100



345 x 150 x 85 mm

1 BE5100

Stretch belt installer/remover



BE230



35 x 145 x 155 mm

1 BE230

Alternator extractor 24 pcs set



BE500P24



55 x 270 x 370 mm

- 5 BE500P24
- 1 BE500P2401
- 1 BE500P2402
- 1 BE500P2403
- 1 BE500P2404
- 1 BE500P2405
- 1 BE500P2406
- 1 BE500P2407
- 1 BE500P2408



- 1 BE500P2409
- 1 BE500P2410
- 1 BE500P2411
- 1 BE500P2412
- 1 BE500P2413
- 1 BE500P2414
- 1 BE500P2415
- 1 BE500P2416
- 1 BE500P2417
- 1 BE500P2418
- 1 BE500P2419
- 1 BE500P2420
- 1 BE500P2421
- 1 BE500P2422
- 1 BE500P2423
- 1 BE500P2424

Diesel compression tester



BE5401D



105 x 325 x 410 mm

1 BE5401D

Digital petrol engine compressor tester



BE5400P



70 x 160 x 260 mm

1 BE5400P

Belt tension tester



BE239



38 x 82 x 95 mm

95 mm

1 BE239

Electronic belt tension tester



BE240



60 x 270 x 315 mm

315 mm

1 BE240

Alternator extractor 24 pcs set



BE500P24



55 x 270 x 370 mm

- 5 BE500P24
- 1 BE500P2401
- 1 BE500P2402
- 1 BE500P2403
- 1 BE500P2404
- 1 BE500P2405
- 1 BE500P2406
- 1 BE500P2407
- 1 BE500P2408

Digital petrol engine compressor tester



BE5400P



70 x 160 x 260 mm

1 BE5400P

Data book of tension values for timing and accessory belts, synchronous, V&V and ribbed shape.



BE240-CAT



710 g

1 BE240-CAT



Laser thermometer



BLT550





-50 +550 °C 40 x 95 x 145 mm 10 BLT550

UV flexible leak detection lamp



BLUVF





450 mm 70 x 98 x 295 mm 1 BLUVF

Quick fluid stopper and injector hose separator set



BE257





68 x 225 x 280 mm
 8 BE257
 1 BE25710
 1 BE25718
 1 BE2572
 1 BE2576

Universal injector removal tool kit



BE512201





140 x 415 x 600 mm 1 BE512201

BE51220101	
BE51220102	
BE51220103	
BE51220104	
BE51220105	
BE51220106	
BE51220107	
BE51220108	
BE51220109	
BE51220110	
BE51220111	
BE51220112	
BE51220113	
BE51220114	
BE51220115	
BE51220116	
BE51220117	
BE51220118	
BE51220119	
BE51220120	

Injector puller set



BE1311P13





80 x 355 x 445 mm 1 BE1311P13

Injection nozzle socket set; 25, 27, 29 & 30 mm



BE1310P4





68 x 225 x 225 mm 1 BE1310P4

1/2" impact socket for removing Bosch and Siemens injection nozzles



BE1310P425-BE1310P430



25 mm	1/2 in	1	BE1310P425
27 mm	1/2 in	1	BE1310P427
29 mm	1/2 in	1	BE1310P429
30 mm	1/2 in	1	BE1310P430

Diesel injector seat cleaner set



BE1320S17





76 x 266 x 355 mm 10 BE1320S17

Diesel injector seat cutter



BE1315P7



68 x 225 x 280 mm	1	BE1315P7
25 x 180 x 275 mm	1	BE1315P71
20 x 93 x 175 mm	1	BE1315P72
19 x 93 x 140 mm	1	BE1315P73
16 x 93 x 140 mm	1	BE1315P74
20 x 56 x 96 mm	1	BE1315P75
20 x 56 x 96 mm	1	BE1315P76
23 x 56 x 96 mm	1	BE1315P77

Slide hammer / Washer and wiper puller



BE1300SH



235 mm	50 x 50 x 235 mm	10	BE1300SH
--------	------------------	----	----------

Valve seat removal tool for DENSO injectors



BE1310DNS



36.4 x 24 x 24 mm	12	BE1310DNS
-------------------	----	-----------

Special Internal Valve Seat Removal Tool for Denso Common Rail Injectors



BE1312DNS



12 BE1312DNS

Diesel injector washer puller



BE1300



230 mm	35 x 35 x 260 mm	1	BE1300
--------	------------------	---	--------

Valve lapper set



BE762



30 x 90 x 315 mm	12	BE762
------------------	----	-------

Valve spring compressor removal tools



BE76101



40 x 200 x 290 mm	1	BE76101
-------------------	---	---------

Copper injector sealing ring set



BE1305P450



40 x 140 x 205 mm	1	BE1305P450
-------------------	---	------------

Sets of 30 washers for injectors

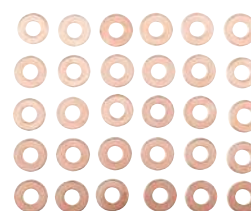

BE1305P450B



- 1 BE1305P450WS01
- 1 BE1305P450WS02
- 1 BE1305P450WS03
- 1 BE1305P450WS04
- 1 BE1305P450WS05
- 1 BE1305P450WS06
- 1 BE1305P450WS07
- 1 BE1305P450WS08
- 1 BE1305P450WS09
- 1 BE1305P450WS10
- 1 BE1305P450WS11
- 1 BE1305P450WS12
- 1 BE1305P450WS13
- 1 BE1305P450WS14
- 1 BE1305P450WS15



Common rail 8 injectors fuel return tester



BE5350

84 x 341 x 447 mm	5	BE5350
10 x 56 x 96 mm	1	BE5350C1
10 x 56 x 96 mm	1	BE5350C2
10 x 56 x 96 mm	1	BE5350C3
10 x 56 x 96 mm	1	BE5350C4
115 x 65 x 205 mm	1	BE5350C5

Tamper Torx® Bit/Socket Set, 1/4"



BE5008

40 x 20 x 175 mm	1	BE5008

BE5008-45, BE5008-27, BE5008-25, BE5008-40, BE5008-30, BE5008-10, BE5008-20, BE5008-15

Glow plug socket set



BE1GP5

1/4 in	110 x 240 x 40 mm	1 BE1GP5

BE1GP514, BE1GP510, BE1GP512, BE1GP58, BE1GP59

Diesel injector tester



BE13ZL11

480 x 230 x 280 mm	4.24 kg	1 BE13ZL11

Tamper Torx socket



BE5008-10/BE5008-45

10	1 BE5008-10
15	1 BE5008-15
20	1 BE5008-20
25	1 BE5008-25
27	1 BE5008-27
30	1 BE5008-30
40	1 BE5008-40
45	1 BE5008-45

Glow plug puller



BE1205

130 mm	35 x 35 x 130 mm	1 BE1205

1/2" diesel injection socket



7807

29	80 mm
1	7807

Glow plug tester



BE100

160 mm	35 x 65 x 160 mm	1 BE100

Sets of 5 inserts/coils for repairing/restoring damaged glow plug threads



BE1210P110x

M8x1	50 g	1 BE1210P1101
M10x1	50 g	1 BE1210P1102
M10x1,25	50 g	1 BE1210P1103

Glow plug chamber cleaning set



BE1200P6



50 x 115 x 260 mm



1 BE1200P6

Glow plug flex sockets



BE1GP58/BE1GP514

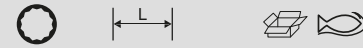

8 mm	70 mm	1	BE1GP58
9 mm	70 mm	1	BE1GP59
10 mm	70 mm	1	BE1GP510
12 mm	70 mm	1	BE1GP512
14 mm	70 mm	1	BE1GP514

Spark Plug Articulated Extension Tool



BE1SP1F



30 mm



21 x 330 x 330 mm



12 BE1SP1F

Reamer for BE1200P6



BE1200P6AC1



50 x 158 x 192 mm



1 BE1200P6AC1

Glow plug thread repair set



BE1210P11



50 x 120 x 260 mm
112 x 13 x 95 mm



1 BE1210P11
1 BE1210P9AC1

Spark plug sockets with magnet, 3/8"



7406ZZ

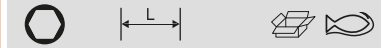

16 mm	65 mm	1	7406ZZ-16
21 mm	64 mm	1	7406ZZ-21

T-handle for glow plug sockets



BE1GP5-T



1/4 in



400 mm



10 BE1GP5-T

Spark Plug Pliers



BE1P



290 mm



20 x 50 x 290 mm



1 BE1P

1/2" Square Drive Spark Plug Sockets



7805GPR

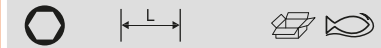

16 mm	64 mm	120	7805GPR-16
21 mm	64 mm	100	7805GPR-21



3/8" Square Drive Spark Plug Sockets



7402GPR

Size	Quantity	Part Number
16 mm	120	7402GPR-16
18 mm	120	7402GPR-18
21 mm	100	7402GPR-21

Spark plug wrench



BE1SP

Size	Length	Quantity	Part Number
3/8 in	252 mm	10	BE1SP16L
3/8 in	252 mm	1	BE1SP14L

Spark plug wrenches



BE1T14/BE1T16/BE1T21

Size	Length	Quantity	Part Number
14 mm	65/310 mm	1	BE1T14
16 mm	63/450 mm	1	BE1T16
21 mm	67/450 mm	1	BE1T21

BE110014 / Tap: M14x1.25P



BE110014/BE110015

Weight	Quantity	Part Number
55 g	1	BE110014
55 g	1	BE110015

Insert coils for repairing spark plug threads



BE1100AC1/BE1100AC2

Length	Quantity	Part Number
15 mm	1	BE1100AC1
15 mm	1	BE1100AC2

Ribe 1/2" socket with bit, suitable for engines



BE5102

Dimensions	Quantity	Part Number
65 x 225 x 225 mm	1	BE5102

BE51026, BE51025, BE510210,
BE510211, BE510212, BE510213,
BE51027, BE51028, BE51029

1/2" socket drivers with Ribe bits



BE51025-BE510213

Size	Length	Quantity	Part Number
RM5	100 mm	1	BE51025
RM6	100 mm	1	BE51026
RM7	100 mm	1	BE51027
RM8	100 mm	1	BE51028
RM9	100 mm	1	BE51029
RM10	100 mm	1	BE510210
RM11	100 mm	1	BE510211
RM12	100 mm	1	BE510212
RM13	100 mm	1	BE510213

XZN 1/2" socket with bit, suitable for engines



BE5103

Dimensions	Quantity	Part Number
65 x 225 x 225 mm	1	BE5103

BE51036, BE51038, BE510310,
BE510312, BE51035, BE510314

1/2" socket drivers with XZN bits



BE51035-BE510314

Size	Length	Quantity	Part Number
M5	140 mm	1	BE51035
M6	140 mm	1	BE51036
M8	140 mm	1	BE51038
M10	140 mm	1	BE510310
M12	140 mm	1	BE510312
M14	140 mm	1	BE510314

Spark plug wire brush



52



150 mm

12 52

General purpose utility wire brush



782-U

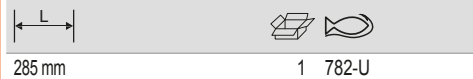

285 mm

1 782-U

Terminal brush



2555



85 mm

1 2555

Spark plug thread restorer set



BE1100

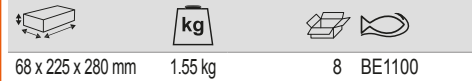

68 x 225 x 280 mm

1.55 kg

8 BE1100

Milling cutter



BE110001



60 g

1 BE110001

Piston Ring Tongs



BE74-55100/BE74-80120

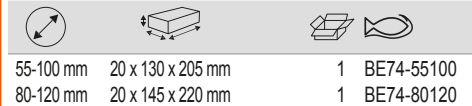

55-100 mm 20 x 130 x 205 mm

1 BE74-55100

80-120 mm 20 x 145 x 220 mm

1 BE74-80120

Piston ring tightener



BE74-57125/BE74-90175

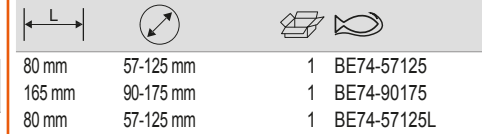

80 mm 57-125 mm

1 BE74-57125

165 mm 90-175 mm

1 BE74-90175

80 mm 57-125 mm

1 BE74-57125L

Refractometer



3046-REF

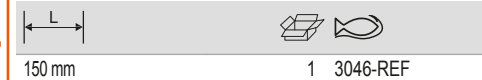

150 mm

1 3046-REF

Antifreeze liquid tester



BE401

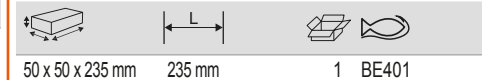

50 x 50 x 235 mm

235 mm

1 BE401



Cooling system pressure tester set



BE400P24



127 x 435 x 510 mm

1 BE400P24

Radiator cap test connector R123/R125



BE400P243



0.06 kg

1 BE400P243

Radiator cap tester for cooling system



BE400P2402



65 mm

1 BE400P2402

Radiator pressure pump with gauge for testing cooling or heating systems



BE400P241

BAR PSI



1 BE400P241

0-2,5 bar

0-36 psi

Thermometer 0-200°C



BE400P244



0.02 kg

1 BE400P244

Radiator cap tester for cooling system



BE400P2403



43,5 mm

1 BE400P2403

Radiator cap test connector R124/R123



BE400P242



0.035 kg

1 BE400P242

Radiator cap tester for cooling system



BE400P2401



65 mm

1 BE400P2401

Adaptor for testing the cooling system



BE400P2404



0.055 kg

1 BE400P2404

Adaptor for testing the cooling system



BE400P2405



0.065 kg



1 BE400P2405

Adaptor for testing the cooling system



BE400P2408



0.075 kg



1 BE400P2408

Adaptor for testing the cooling system



BE400P2411



0.11 kg



1 BE400P2411

Adaptor for testing the cooling system



BE400P2406



0.065 kg



1 BE400P2406

Adaptor for testing the cooling system



BE400P2409



0.11 kg



1 BE400P2409

Adaptor for testing the cooling system



BE400P2412



0.085 kg



1 BE400P2412

Adaptor for testing the cooling system



BE400P2407



0.065 kg



1 BE400P2407

Adaptor for testing the cooling system



BE400P2410



0.085 kg



1 BE400P2410

Adaptor for testing the cooling system



BE400P2413



0.065 kg



1 BE400P2413



Adaptor for testing the cooling system



BE400P2414



0.11 kg

1 BE400P2414

Adaptor for testing the cooling system



BE400P2417



0.11 kg

1 BE400P2417

Plastic wrench for radiator cap



BE400P2420



0.005 kg

1 BE400P2420

Adaptor for testing the cooling system



BE400P2415



0.075 kg

1 BE400P2415

Adaptor for testing the cooling system



BE400P2418



0.045 kg

1 BE400P2418

Cooling system purging and filling set



BE410



80 x 300 x 375 mm

4 BE410

45 x 45 x 105 mm

1 BE4101

Adaptor for testing the cooling system



BE400P2416



0.065 kg

1 BE400P2416

Adaptor for testing the cooling system



BE400P2419



0.075 kg

1 BE400P2419

Gasket joints separator set



BE700



90 x 200 x 43 mm

1 BE700

1 BE700BP2

1 BE700SP15

10 mm bit set



BE5032

	65 x 225 x 225 mm		1	BE5032
--	-------------------	--	---	--------

BE5049M5, BE5049M6, BE5049M8, BE5049M10, BE5049M12, BE5032M14		
BE5049T20, BE5049T25, BE5049T27, BE5049T30, BE5049T40, BE5049T45, BE5049T50, BE5049T55, BE5049T60		
BE5049H5, BE5049H6, BE5049H8, BE5049H10, BE5049H12, BE5032H14		
BE5032SQ8, BE5032SQ10		
BE5049H6L, BE5049H8L, BE5032H10EL		
BE5049T45L, BE5032T55EL		
BE5049M8L, BE5049M10L, BE5049M12L		
BE504901		

Bit for Robertson Metric Head Screws, 10 mm



BE5032SQ

	#8 mm	30 mm	1	BE5032SQ8
	#10 mm	30 mm	1	BE5032SQ10

1/2" socket drivers with Tamper Torx bits



BE510125-BE510160

		TR25	100 mm	1	BE510125
		TR27	100 mm	1	BE510127

TR30	100 mm	1	BE510130	
TR40	100 mm	1	BE510140	
TR45	100 mm	1	BE510145	
TR50	100 mm	1	BE510150	
TR55	100 mm	1	BE510155	
TR60	100 mm	1	BE510160	

Crankshaft and camshaft seal installation set



BE5150P27

	80 x 270 x 375 mm	1	BE5150P27
	56 x 56 x 96 mm	1	BE5150P271
	80 x 80 x 195 mm	1	BE5150P272
	170 x 160 x 385 mm	1	BE5150P273

A/C repair tool set



BE800P12

	43 x 90 x 200 mm	1	BE800P12
--	------------------	---	----------

Adaptor set for disconnection of A/C hoses



BAC007

	240 mm		0.075 kg		1	BAC007
--	--------	--	----------	--	---	--------

Engine support bar

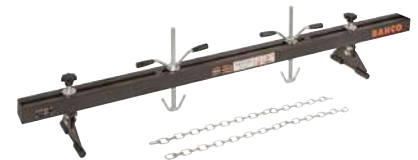

BH8AC1-500

	150 x 165 x 1800 mm		20.71 kg		1	BH8AC1-500
--	---------------------	--	----------	--	---	------------

500 kg geared engine stand



BH8AC2-500

	500 kg		1	BH8AC2-500
--	--------	--	---	------------



Angle hose clamp pliers 45°



BE250

190 mm	245 g	1	BE250

Standard Space Saver & Hose Clamp Ratcheting Tool



BE254A

18-53 mm		1	BE254A

Cable

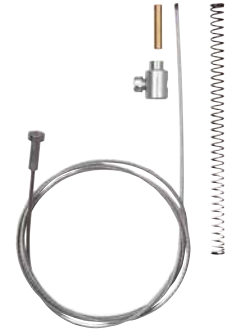

BE2542

630 mm	20 g	1	BE2542

Hose clamp pliers



BE251

210 mm	180 g	1	BE251

Spare Cable for BE254A Pliers



BE254A-01

590 mm	130 g	1	BE254A-01

Hose clamp metallic



BE256M

40 x 45 x 310 mm		1	BE256M

EGR type hose clamp pliers



BE253

870 mm		1	BE253

Repair kit for BE254



BE2541

	100 g	1	BE2541

Elastic hose clamp pliers



BE258

12-55 mm	285 mm	1	BE258

Oetiker™ Clamp Pliers



BPOC15



275 mm



12 BPOC15

Slotted Sockets



BE5500-10/BE-5500-19



3/8	10	1	BE550010
3/8	11	1	BE550011
3/8	12	1	BE550012
3/8	14	1	BE550014
1/2	17	1	BE550017
1/2	19	1	BE550019

Fuel line disconnecting pliers



BE1FLD1/BE1FLD3



10 mm
8 mm
18.5 mm



1 BE1FLD1
1 BE1FLD2
1 BE1FLD3

Hose clamp pliers set



BE256P3



40 x 93 x 330 mm
15 x 55 x 155 mm
20 x 45 x 185 mm
10 x 55 x 250 mm



1 BE256P3
1 BE256-155
1 BE256-178
1 BE256-250

In-Line Fuel Filter Connection Pliers



BE6FCP

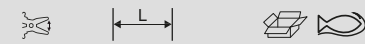

104 mm 218 mm 30 BE6FCP

Fuel gauge puller



BE1FTW



75-160 mm



1 BE1FTW

Slotted socket set



BE5500



10/11/12/14/17/19



25 BE5500

Fuel line disconnecting pliers set



BE1FLDS



8-10 mm 1 BE1FLDS

Fuel Filter Wrench Ford 2.2TDCi



BE1FFWF



5 x 142 x 169 mm



12 BE1FFWF

BE1FLD2, BE1FLD3, BE1FLD1



Seal and soft hose removal and picking tool set



2633HD/S6



80 x 270 x 375 mm	1	2633HD/S6
42 x 93 x 290 mm	1	2633HD1
30 x 85 x 215 mm	1	2633HD2
30 x 93 x 200 mm	1	2633HD3
20 x 87 x 165 mm	1	2633HD4
10 x 60 x 120 mm	1	2633HD5
10 x 10 x 155 mm	1	2633HD6

T-Handle Set with Hex Metric Tips - 5 pcs



BE1TH-S5

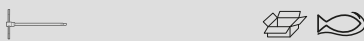

5	1	BE1TH-S5
---	---	----------

Set of 6 T-Bar Handles for Allen Hex Socket Head Screws 2.5, 3, 4, 5, 6 & 8 mm



BE1TH-S6

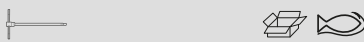

6	30	BE1TH-S6
---	----	----------

BE1TH-4, BE1TH-8, BE1TH-2.5, BE1TH-3, BE1TH-6, BE1TH-5



T-bar handle for Allen - Hexagonal head screws



BE1TH

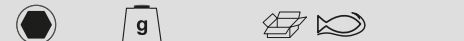

mm	g	
10 mm	385 g	5 BE1TH-10
12 mm	571 g	5 BE1TH-12
14 mm	801 g	5 BE1TH-14
2 mm	15 g	10 BE1TH-2
2,5 mm	20 g	10 BE1TH-2.5
3 mm	23 g	10 BE1TH-3
3,5 mm	23 g	10 BE1TH-3.5
4 mm	60 g	10 BE1TH-4
4,5 mm	60 g	10 BE1TH-4.5
5 mm	60 g	10 BE1TH-5
6 mm	127 g	10 BE1TH-6
7 mm	205 g	10 BE1TH-7
8 mm	205 g	10 BE1TH-8
9 mm	385 g	10 BE1TH-9

Set of 7 T-Bar Handles with Swivel Sockets 7, 8, 10, 12, 13, 14 & 17 mm 500 mm long

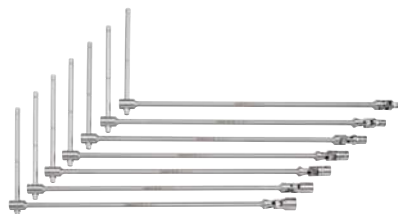

BE1TS-S7

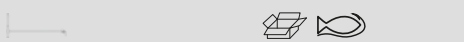

7	1	BE1TS-S7
---	---	----------

BE1TS-17, BE1TS-13, BE1TS-14, BE1TS-12, BE1TS-7, BE1TS-8, BE1TS-10



T-bar handle with swivel socket 500 mm long



BE1TS

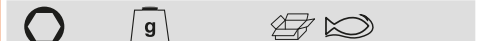

mm	g	
10 mm	485 g	10 BE1TS-10
11 mm	485 g	10 BE1TS-11
12 mm	475 g	10 BE1TS-12
13 mm	485 g	10 BE1TS-13
14 mm	485 g	10 BE1TS-14
15 mm	485 g	10 BE1TS-15
16 mm	495 g	10 BE1TS-16
17 mm	495 g	10 BE1TS-17
18 mm	510 g	10 BE1TS-18
19 mm	495 g	10 BE1TS-19
20 mm	730 g	8 BE1TS-20
21 mm	765 g	8 BE1TS-21
22 mm	745 g	8 BE1TS-22
24 mm	745 g	8 BE1TS-24
6 mm	475 g	10 BE1TS-6
7 mm	475 g	10 BE1TS-7
8 mm	485 g	10 BE1TS-8
9 mm	475 g	10 BE1TS-9

T handle bar with rotating aluminium holder



1945W

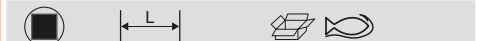

mm	L	
1/2 in	311 mm	6 1945W12
1/4 in	311 mm	8 1945W14
3/8 in	311 mm	6 1945W38

Bit set 49 pcs with Torx tamper bits



BE5049

55 x 190 x 320 mm	3.56 kg	5	BE5049



Bit for XZN Head Screws, 10 mm



BE5049M

M5	30 mm	1 BE5049M5
M6	30 mm	1 BE5049M6
M8	30 mm	1 BE5049M8
M10	30 mm	1 BE5049M10
M12	30 mm	1 BE5049M12
M14	30 mm	1 BE5032M14

TR45	30 mm	1 BE5049T45H
TR50	30 mm	1 BE5049T50H
TR55	30 mm	1 BE5049T55H
TR60	30 mm	1 BE5049T60H

Torx® Tamper 1/2" socket with bit, suitable for engines



BE5101

65 x 225 x 225 mm	1	BE5101

1/2" adaptor for 10 mm bits



BE504901

10 mm	36 mm	1 BE504901

Bit for Torx® Head Screws, 10 mm



BE5049T

T20	30 mm	1 BE5049T20
T25	30 mm	1 BE5049T25
T27	30 mm	1 BE5049T27
T30	30 mm	1 BE5049T30
T40	30 mm	1 BE5049T40
T45	30 mm	1 BE5049T45
T50	30 mm	1 BE5049T50
T55	30 mm	1 BE5049T55
T60	30 mm	1 BE5049T60

BE510150, BE510145, BE510160, BE510155, BE510127, BE510125, BE510140, BE510130	1	BE5101

Bit for Hexagon Metric Head Screws, 10 mm



BE5049H

4 mm	30 mm	1 BE5049H4
5 mm	30 mm	1 BE5049H5
6 mm	30 mm	1 BE5049H6
7 mm	30 mm	1 BE5049H7
8 mm	30 mm	1 BE5049H8
10 mm	30 mm	1 BE5049H10
12 mm	30 mm	1 BE5049H12
14 mm	30 mm	1 BE5032H14

Bit for Torx® Tamper Head Screws, 10 mm



BE5049T_H

TR20	30 mm	1 BE5049T20H
TR25	30 mm	1 BE5049T25H
TR27	30 mm	1 BE5049T27H
TR30	30 mm	1 BE5049T30H
TR40	30 mm	1 BE5049T40H

Engine oil pressure tester set



BE5200

85 x 355 x 445 mm	1	BE5200
25 x 105 x 195 mm	1	BE530001
	1	BE52001
	1	BE52002
	1	BE52003



3/8" adaptor for 10 mm bits



BE504902

10 mm	28 mm	1	BE504902

Bit for Hexagon Metric Head Screws, 10 mm



BE5049H_L

4	75 mm	1	BE5049H4L
5	75 mm	1	BE5049H5L
6	75 mm	1	BE5049H6L
7	75 mm	1	BE5049H7L
8	75 mm	1	BE5049H8L
10	75 mm	1	BE5049H10L
10	115 mm	1	BE5032H10EL
12	75 mm	1	BE5049H12L

Bit for XZN Head Screws, 10 mm



BE5049M_L

M5	75 mm	1	BE5049M5L
M6	75 mm	1	BE5049M6L
M8	75 mm	1	BE5049M8L
M10	75 mm	1	BE5049M10L
M12	75 mm	1	BE5049M12L

Bit set 49 pcs with regular Torx bits



BE5049t

55 x 190 x 320 mm	3.54 kg	1	BE5049T

Bit for Torx® Tamper Head Screws, 10 mm



BE5049T_HL

TR20 mm	75 mm	1	BE5049T20HL
TR25 mm	75 mm	1	BE5049T25HL
TR27 mm	75 mm	1	BE5049T27HL
TR30 mm	75 mm	1	BE5049T30HL
TR40 mm	75 mm	1	BE5049T40HL
TR45 mm	75 mm	1	BE5049T45HL
TR50 mm	75 mm	1	BE5049T50HL
TR55 mm	75 mm	1	BE5049T55HL
TR60 mm	75 mm	1	BE5049T60HL
TR70 mm	100 mm	1	BE5049T70HL
TR80 mm	70 mm	1	BE5049T80HL
TR30 mm	200 mm	1	BE5049T30HXL
TR40 mm	200 mm	1	BE5049T40HXL
TR45 mm	200 mm	1	BE5049T45HXL

Bit for Torx® Head Screws, 10 mm



BE5049T_L

T20	75 mm	1	BE5049T20L
T25	75 mm	1	BE5049T25L
T27	75 mm	1	BE5049T27L
T30	75 mm	1	BE5049T30L

T40	75 mm	1	BE5049T40L
T45	75 mm	1	BE5049T45L
T50	75 mm	1	BE5049T50L
T55	75 mm	1	BE5049T55L
T55	115 mm	1	BE5032T55EL

EXHAUST TOOLS

Exhaust Fume Extractor



BUCPE

5000 mm	1263 x 306 x 300 mm	1	BUCPE
105 mm	15 x 105 x 105 mm	1	BUCPEF1
121 mm	60 x 121 x 121 mm	1	BUCPEF

Tube extension for BUCPE



BUCPE3SH

3000 mm	63,5 mm	1	BUCPE3SH

A dual exhaust pipe for BUCPE



BUCPE3SDH

420 x 530 x 3000 mm	3000 mm	1	BUCPE3SDH

Exhaust clamp pliers



BUC50

65 mm	305 mm	1	BUC50

OIL SERVICE TOOLS & EQUIPMENT

Fuel Filter Cover Wrench



BE60F108

3/8 in	108 mm	50	BE60F108

Lambda sensor tester



BELT10

35 x 65 x 160 mm	1	BELT10

Universal exhaust removal tool



BUC110

360 mm	50 x 65 x 360 mm	1	BUC110

Oil & Fuel Filter Remover



BE60FW

57-120 mm	18 x 95 x 325 mm	5	BE60FW

1/2" Lambda service socket



7812

22 mm	78 mm	100	7812

Universal exhaust puller



BUC100

34-54 mm	320 mm	1	BUC100

Oil filter strap wrench



BE611

65-105 mm	25 x 55 x 210 mm	12	BE6110
65-105 mm	1 x 12 x 382 mm	100	BE6110-1
100-155 mm	37 x 75 x 275 mm	12	BE61155
100-155 mm	1 x 12 x 529 mm	1	BE61155-1



Oil filter strap wrench with rubber handle



BE62

Icon	Icon	Icon	Icon
65-105 mm	42.5 x 57 x 249 mm	10	BE62110
110-155 mm	42.5 x 85 x 314 mm	10	BE62155

Oil filter chain wrench



BE64520/BE64350

Icon	Icon	Icon	Icon
350 mm	60-105 mm	1	BE64350
350 mm	60-105 mm	1	BE64350CH
520 mm	60-160 mm	1	BE64520
520 mm	60-160 mm	1	BE64520CH

Rubber belt wrench



BE66152A

Icon	Icon	Icon	Icon
150 mm	95 x 170 x 220 mm	6	BE66152A

3-jaw oil filter wrench



BE65F65120

Icon	Icon	Icon	Icon
3/8 in	65-120 mm	12	BE65F65120

Magnetic 3-jaw oil filter wrenches



BE65R

Icon	Icon	Icon	Icon
3/8-1/2 in	65-120 mm	1	BE65R65120
3/8-1/2 in	80-119 mm	1	BE65R80120
1/2 in	105-160 mm	1	BE65R106160

Oil filter cup set



BE630



Icon	Icon	Icon	Icon
87 x 505 x 610 mm		3	BE630

Individual filter cups



BE630 Parts

Icon	Icon	Icon	Icon
66 mm	Fiat, Renault	1	BE630666F
64 mm	Daihatsu, Fiat, Nissan, Toyota	12	BE6306514F
65-66 mm	Daihatsu, Toyota	12	BE630656714F
66 mm	Ford, Mazda, Subaru	1	BE6306814F
73 mm	Alfa Romeo, Lexus, Toyota	1	BE6307314F
74 mm	Audi, Chrysler, GM, Rover	1	BE6307415F
74-76 mm	Audi, Ford, Mercedes Benz, Opel, VW	12	BE630747615F
74-75 mm	Audi, Ford, Isuzu, Mercedes Benz, Opel, VW	1	BE630757715F
76 mm	Fiat, Mercedes Benz, Renault	12	BE6307612F
74 mm	Audi, BMW, Mercedes Benz, Opel, Porsche, VW	12	BE6307614F
74 mm	Ford	1	BE6307630F
74 mm	Fiat, Lancia	1	BE630768F
78 mm	Ford, Honda, Nissan, Toyota	12	BE6307815F
80 mm	Honda, Isuzu, Mazda, Nissan, Opel, Subaru, Toyota	1	BE6308015F
80-82 mm	Acura, Honda, Mazda, Nissan, Subaru, Toyota	1	BE630808215F
86 mm	Volvo	1	BE6308616F
86 mm	Audi, Citroen, Peugeot, Renault, VW	1	BE6308618F
89 mm	Honda, Isuzu, Mitsubishi	1	BE6309015F
92 mm	Fiat, Lancia	1	BE6309210F
92 mm	Audi, Ford, Honda, Mazda, Mitsubishi, Nissan, Opel, Porsche, Renault, Volvo, VW	1	BE6309315F
93 mm	Ford	1	BE6309336F
93 mm	Audi, VW	1	BE6309345F
95 mm	Alfa Romeo, Chrysler, Ford, Toyota	1	BE6309515F
96 mm	Audi, Renault, VW	1	BE6309618F
101 mm	Isuzu, Mitsubishi	25	BE63010015F
24 mm	BMW	50	BE630246F
106 mm	Fiat, MAN, Scania	1	BE63010615F
27 mm	Mercedes Benz	50	BE630276F
107 mm	Volvo	1	BE63010815F

			
32 mm	GM, Mercedes Benz, Opel, Saab	50	BE630326F
108 mm	Renault	1	BE63010818F
36 mm	BMW, Ford, Mercedes Benz, Opel, Rover, VW	100	BE630366F
38 mm	BMW, Opel, Volvo	50	BE630386F
66.5 mm	Daihatsu, Toyota	25	BE63066514F

27 mm oil filter wrench for Ford and PSA Group





BE6302712F

			
1/2 in	27 mm	5	BE6302712F

Oil Filter Wrench Toyota, Lexus, Subaru, Daihatsu with 4 Cylinders (1.8 to 2.0 litre)





BE63064514F1

			
Toyota, Lexus, Subaru, Daihatsu 4 cylinders (1.8-2.0l)	64,5 mm	1	BE63064514F1

Oil Filter Wrench Toyota, Lexus, Subaru, Daihatsu with 4, 6 or 8 Cylinders (2.5 to 5.7 litre)



BE63064514F2

			
64.5 mm	Toyota, Lexus, Subaru, Daihatsu 4, 6, 8 cylinders (2.5 -5,7L)	1	BE63064514F2

Oil Filter Cup 74 mm 14 Flutes





BE6307414F

#		
14	1	10 BE6307414F

Carter wrenches



BE68

		
8 in	265 mm	12 BE6810Z
8 in	235 mm	1 BE68
8 x 10 mm	270 mm	1 BE6810

1/4" Oil sump plug removal bit for VAG engine 2 litre 4 cylinders



BE6701VAG

		
10 x 50 x 125 mm	0.02 kg	1 BE6701VAG

Oil drain plug socket set





BE6217

	
55 x 105 x 220 mm	1 BE6217

3/8" Oil Plug Socket



BE621701-1717

#	mm		
6	8 mm	1	BE621701
6	9 mm	1	BE621702
6	10 mm	1	BE621703
6	12 mm	1	BE621704
6	13 mm	1	BE621705
6	14 mm	1	BE621706
6	17 mm	1	BE621707
4	8 mm	1	BE621708
4	9.5 mm	1	BE621709
4	10 mm	1	BE621710
4	10.5 mm	1	BE621711
4	11 mm	1	BE621712
4	12 mm	1	BE621713
4	13.1 mm	1	BE621714
4	10 mm	1	BE621715
3	10 mm	1	BE621716
xZN	M16 mm	1	BE621717



Oil drain plug restorer set



BOD10P64



68 x 225 x 280 mm



1 BOD10P64

Mini oil drain plug restorer sets



BOD10



34 x 93 x 105 mm
35 x 95 x 105 mm
33 x 93 x 105 mm
33 x 93 x 105 mm
33 x 93 x 105 mm
95 x 105 x 35 mm



1 BOD101
1 BOD102
1 BOD103
1 BOD104
1 BOD105
1 BOD106

Oil drain plug and washer set



BOD10XNWS



M13x1.25
M13x1.5
M15x1.5



1 BOD101NWS
1 BOD102NWS
1 BOD103NWS



M17x1.5
M20x1.5
M22x1.5



1 BOD104NWS
1 BOD105NWS
1 BOD106NWS

2 in 1 oil drainer with tank capacity 90L and inspection chamber



BOD8903A



1700 x 419 x 608 mm



1 BOD8903A

2 in 1 oil drainer with tank capacity 90L



BOD8902



1000 x 413 x 632 mm



38 kg



1 BOD8902

Gravity oil drainer with tank capacity 90L



BOD8901



1000 x 413 x 630 mm



32 kg



1 BOD8901

Extension funnel for oil drainers



BOD8901AC1



620 x 620 x 150 mm



1 BOD8901AC1

Automatic transmission fluid refiller



BOD6080P12



595 x 255 x 330 mm



1 BOD6080P12

Adaptor for BOD6080P12 set



BOD6080P12-01

35 g	1	BOD6080P12-01

Adaptor for BOD6080P12 set



BOD6080P12-05

25 g	1	BOD6080P12-05

Adaptor for BOD6080P12 set



BOD6080P12-09

15 g	1	BOD6080P12-09

Adaptor for BOD6080P12 set



BOD6080P12-02

55 g	1	BOD6080P12-02

Adaptor for BOD6080P12 set



BOD6080P12-06

25 g	1	BOD6080P12-06

Adaptor for BOD6080P12 set



BOD6080P12-10

85 g	1	BOD6080P12-10

Adaptor for BOD6080P12 set



BOD6080P12-03

45 g	1	BOD6080P12-03

Adaptor for BOD6080P12 set



BOD6080P12-07

45 g	1	BOD6080P12-07

Adaptor for BOD6080P12 set



BOD6080P12-11

105 g	1	BOD6080P12-11

Adaptor for BOD6080P12 set



BOD6080P12-04

6 g	1	BOD6080P12-04

Adaptor for BOD6080P12 set



BOD6080P12-08

45 g	1	BOD6080P12-08

Oil cans



BOD4200/BOD4500

0.2l	158 x 86 x 128 mm	1 BOD4200
0.5l	158 x 86 x 128 mm	1 BOD4500



Oil funnel



BOD301200



225 x 165 x 165 mm

1 BOD301200

For tapping damaged oil plug thread slightly oversize, then fitting a new drain plug and washer



BOD10XT



92 mm	M13x1.25	1	BOD101T
70 mm	M13x1.5	1	BOD102T
70 mm	M15x1.5	1	BOD103T
70 mm	M17x1.5	1	BOD104T
70 mm	M20x1.5	1	BOD105T
70 mm	M22x1.5	1	BOD106T

Lever Action Barrel Pump



BOD60



875 x 57 x 245 mm

1 BOD60

Oil drain tank



BOD2008



8 l

115 x 325 x 590 mm

1 BOD2008

2L Can with Flexible Spout



BOD2FS



2 l

330 x 130 x 380 mm

20 BOD2FS

Heavy duty cartridge grease pump



BOD5HD400



60 x 115 x 360 mm

1 BOD5HD400

Oil drain pan



BOD1016



16 l

170 x 450 x 570 mm

1 BOD1016

Rotary barrel pump



BOD70



230 x 250 x 1330 mm

1 BOD70

Cartridge grease pump



BOD5400/BOD5450



55 x 120 x 390 mm

1 BOD5400

65 x 125 x 385 mm

1 BOD5450

Grease flex hoses



BOD54-1 / -2

4.1 mm	10.8 mm	1	BOD54-1
4.1 mm	10.8 mm	1	BOD54-2

Grease coupler



BOD54-3

37 mm	1	BOD54-3

BRAKE SYSTEM TOOLS & EQUIPMENT

Brake fluid tester pen



BBR100

20 x 20 x 150 mm	1	BBR100

Brake fluid tester moisture check



BBR110

35 x 65 x 160 mm	1	BBR110

Brake Nipple Spanners



BBR501011-BBR50121314

10 / 11 mm	3/8 in	50	BBR501011
12 / 14 mm	3/8 in	50	BBR50121314

Air brake system bleeder



BBR350

1/4" in	300 x 125 x 125 mm	1	BBR350

12V Electrical Brake Bleeder



BBRBB12

895 x 390 x 395 mm	14.6 kg	1	BBRBB12

Brake bleeder master cylinder cap adapter kit



BBRAS14

PN5 in	85 x 350 x 445 mm	4	BBRAS14



Brake Bleeder Master Cylinder Cap Adapter Kit Contents



BBRAS14-01/BBRAS14-14

Part No.	Vehicle/Description	Quantity	Part No.
PN5 in	Universal	1	BBRAS14-01
PN5 in	Honda	1	BBRAS14-02
PN5 in	Honda Accord	1	BBRAS14-03
PN5 in	Universal	1	BBRAS14-04
PN5 in	Chrysler, Jeep, Plymouth	1	BBRAS14-05
PN5 in	Chrysler, Jeep, Plymouth, Dodge	1	BBRAS14-06
PN5 in	Nissan	1	BBRAS14-07
PN5 in	Alfa Romeo, Fiat, Peugeot, Citroën, Audi, BMW, Jaguar, Land-Rover, Mercedes, Porsche, Renault, Saab, VW, Volvo, Chrysler, Daewoo, Ford, Kia, Mazda, Mini, etc	1	BBRAS14-08
PN5 in	Hyundai, Mitsubishi, Nissan, Subaru, Chrysler, Dodge, Ford, etc.	1	BBRAS14-09
PN5 in	GM Models and Mazda	1	BBRAS14-10
PN5 in	Toyota and Lexus	1	BBRAS14-11
N/A in	Holder for universal adaptor	1	BBRAS14-12
N/A in	Syringe	1	BBRAS14-13
N/A in	Hooks, chains and roulettes for BBRAS14-01 and BBRAS14-04	1	BBRAS14-14

Micrometer with magnetic base



1154

230 x 50 x 75 mm	1	1154
------------------	---	------

1154-DG

1154-MB

Dial indicator



1154-DG

0-10 mm	0.01 mm	1	1154-DG
---------	---------	---	---------

Magnetic base holder



1154-MB

70 x 96 x 297 mm	230 + 150 mm	1	1154-MB
------------------	--------------	---	---------

Aluminium caliper



BBR400

6 x 89 x 120 mm	1	BBR400
-----------------	---	--------

Digital caliper for brake discs



BBR420

0-60 mm	35 x 104 x 176 mm	50	BBR420
---------	-------------------	----	--------

Brake pad thickness gauge



BBRPTG1

68 g	10	BBRPTG1
------	----	---------

Caliper for measuring brake disc and brake shoe diameters



BBR410

20 x 210 x 280 mm	0.610 kg	24	BBR410
-------------------	----------	----	--------

Digital Brake Caliper



BBR405

460 mm	20	BBR405

Brake brush, steel



783

223 mm	1	783

Brake caliper wind-back air tool



BBR320

3/8"	1/4" in	1	BBR320

Universal brake caliper tool set 50 pieces



BBR300P50

82 x 350 x 425 mm	5.56 kg	1	BBR300P50

Torx® 1/2" impact socket bit set for brakes



BBR203P9

68 x 225 x 225 mm	1	BBR203P9

BBR203P925, BBR203P960,
BBR203P930, BBR203P927,
BBR203P920, BBR203P945,
BBR203P955, BBR203P940,
BBR203P950

1/2" impact socket drivers with Torx bits for brakes



BBR203P920-BBR203P960

T20	78 mm	1	BBR203P920
T25	78 mm	1	BBR203P925
T27	78 mm	1	BBR203P927

T30	78 mm	1	BBR203P930
T40	78 mm	1	BBR203P940
T45	78 mm	1	BBR203P945
T50	78 mm	1	BBR203P950
T55	78 mm	1	BBR203P955
T60	78 mm	1	BBR203P960

XZN 1/2" impact socket bit set for brakes



BBR201P6

68 x 225 x 225 mm	8	BBR201P6

BBR201P67814, BBR201P67816,
BBR201P67818, BBR201P64018,
BBR201P64014, BBR201P64016

1/2 impact socket driver XZN



BBR201P64014-BB201P67818

M14	40 mm	1	BBR201P64014
M16	40 mm	1	BBR201P64016
M18	40 mm	1	BBR201P64018
M14	78 mm	1	BBR201P67814
M16	78 mm	1	BBR201P67816
M18	78 mm	1	BBR201P67818



1/2" pentagon socket and bit set for hand brake



BBR202P4

43 x 90 x 200 mm	1 BBR202P4	
	1 BBR202P410	
	1 BBR202P414	
	1 BBR202P419	
	1 BBR202P455	

Shoe brake springs removal and installation set



BBR210P3

80 x 270 x 375 mm	1 BBR210P3	
25 x 59 x 182 mm	1 BBRS210P	
75 x 270 x 350 mm	1 BBRS210P2	

Brake spring pliers with pivoting head



BBR6135

335 mm	1 BBR6135	

Brake spring pliers



BBR6131

210 mm	1 BBR6131	

Hand Brake Cable Pliers



BBR204

235 mm	21,9 mm	6 BBR204

Brake Circuit Clamps



BBR150i

13.5 mm	10 x 52 x 165 mm	24 BBR150i

Flaring Kit



BBRFKM1

141 x 115 x 195 mm	1551 g	12	BBRFKM1

TRANSMISSION & WHEEL TOOLS

Wheel wrenches



29-B/BWXW1/BWXW2

17, 19, 21 mm	1/2"	1	29-B
17, 19, 22 mm	1/2"	1	BWXW1
24, 27, 32 mm	3/4"	1	BWXW2
17, 19, 21, 22 mm	-	1	BWXW3
24, 27, 32, 38 mm	-	1	BWXW4

17, 19 and 21 mm impact wheel socket set



BWSS12P3

17, 19, 21 mm	45 x 125 x 145 mm	20	BWSS12P3

BWSS12P317, BWSS12P319, BWS-
S12P321

17, 19, 21, 22 and 24 mm impact wheel socket set



BWSS12P5

17, 19, 21, 22, 24 mm	175 x 240 x 50 mm		1		BWSS12P5	

BWSS12P319, BWSS12P317, BWSS12P524, BWSS12P522, BWS-12P321

Wheel socket sets



BWSS12P

1/2 in	17 mm	19 mm	21 mm	22 mm	24 mm	1	BWSS12P317
1/2 in	19 mm	21 mm	22 mm	24 mm		1	BWSS12P319
1/2 in	21 mm	22 mm	24 mm			1	BWSS12P321
1/2 in	22 mm					1	BWSS12P522
1/2 in	24 mm					1	BWSS12P524

15 mm impact wheel socket



BWSMB15

15 mm	25	BWSMB15

17 mm impact socket for Mercedes anti-theft wheel nut



BWSMB17

17 mm	1	BWSMB17

21 mm anti-theft impact socket for Hyundai and KIA



BWSHK21

1/2" in	21 mm	25	BWSHK21

17, 19 and 21 mm long reach impact wheel socket set



BWSS12P3L

17, 19, 21 mm	68 x 225 x 225 mm		1	BWSS12P3L

BWSS12P317L, BWSS12P319L, BWSS12P321L

1/2" long reach impact wheel socket



BWSS12PL

1/2 in	17 mm	19 mm	21 mm	1	BWSS12P317L
1/2 in	19 mm	21 mm		1	BWSS12P319L
1/2 in	21 mm			1	BWSS12P321L

Long twist socket set 1/2" 17, 19 and 21 mm



BWTSP3L

68 x 225 x 150 mm	1 BWTSP3L

BWTSP317L, BWTSP319L, BWT-SP321L

Deep 1/2" Twist Sockets 150 mm long



BWTSP317L-BWTSP321L

1/2 in	17 mm	19 mm	21 mm	1	BWTSP317L
1/2 in	19 mm	21 mm		1	BWTSP319L
1/2 in	21 mm			1	BWTSP321L



Twist socket set 1/2" 17, 19, 21, 22, 24 mm



BWTSP6



55 x 105 x 217 mm



1 BWTSP6

BWTSP619, BWTSP617, BWTSP622, BWTSP621, BWTSP624



Deep Twist Sockets



BWTSP617-BWTSP624



17 mm	1/2 in	1 BWTSP617
19 mm	1/2 in	1 BWTSP619
21 mm	1/2 in	1 BWTSP621
22 mm	1/2 in	1 BWTSP622
24 mm	1/2 in	1 BWTSP624

Twist socket set



BWTSP7



52 x 117 x 207 mm



1 BWTSP7

1/2": 22, 24, 27, 32 mm & 3/4": 36, 41 mm

Twist socket sets



BWTSP16



48 x 125 x 245 mm



1 BWTSP16

3/8": 8, 10, 11, 12, 13, 14, 16, 17, 18, 19 mm & 1/2": 21, 22, 24, 27 mm

Twist socket



BWTSP



8 mm	3/8 in	1 BWTSP1608
10 mm	3/8 in	1 BWTSP1610
11 mm	3/8 in	1 BWTSP1611
12 mm	3/8 in	1 BWTSP1612
13 mm	3/8 in	1 BWTSP1613
14 mm	3/8 in	1 BWTSP1614
16 mm	3/8 in	1 BWTSP1616
17 mm	3/8 in	1 BWTSP1617
18 mm	3/8 in	1 BWTSP1618
19 mm	3/8 in	1 BWTSP1619
21 mm	1/2 in	1 BWTSP1621
22 mm	1/2 in	1 BWTSP1622
24 mm	1/2 in	1 BWTSP1624
27 mm	1/2 in	1 BWTSP1627
32 mm	1/2 in	1 BWTSP732
36 mm	3/4 in	1 BWTSP736
41 mm	3/4 in	1 BWTSP741

Set of 5 torsion bars with 1/2" drive designed for tightening wheel nuts with an impact wrench without exceeding the recommended torque



BWTB12P5



68 x 225 x 280 mm



1.74 kg



1 BWTB12P5

BWTB12P90, BWTB12P100, BWTB12P110, BWTB12P120, BWTB12P135

Torsion bars with 1/2" drive designed for tightening wheel nuts with an impact wrench without exceeding the recommended torque



BWTB12P90-BWTB12P200



Nm



200 mm	100 Nm	1 BWTB12P100
200 mm	110 Nm	1 BWTB12P110
200 mm	120 Nm	1 BWTB12P120
200 mm	135 Nm	1 BWTB12P135
200 mm	150 Nm	1 BWTB12P150
200 mm	160 Nm	1 BWTB12P160
200 mm	175 Nm	1 BWTB12P175
200 mm	190 Nm	1 BWTB12P190
200 mm	200 Nm	1 BWTB12P200
200 mm	90 Nm	1 BWTB12P90

1" impact torsion bars



BZWTB

	MAX		
32	450 Nm	1	BZWTB0132450
32	600 Nm	1	BZWTB0132600
33	600 Nm	1	BZWTB0133600

Tyre lever



38-8 - 38-24

L		
200 mm	5	38-8
300 mm	5	38-12
400 mm	5	38-16
500 mm	2	38-20
600 mm	1	38-24

Tyre lever, special bent form



39-24

L		
605 mm	1	39-24

Wheel bolt bag



BWBB

kg			
0.023 kg	180 x 1 x 300 mm	200	BWBB

Tyre levers



38A

L		
200 mm	25	38A-08
240 mm	25	38A-10
304 mm	1	38A-12
382 mm	25	38A-15
537 mm	1	38A-21
655 mm	1	38A-26

Wheel Chocks



BWC1

75 x 77 x 110 mm	25	BWC1

Thread Tapping Set



BWHTRS12

	g		
225 x 67 x 225 mm	1350 g	15	BWHTRS12

Tyre lever for commercial vehicles and trucks



38C

L		
645 mm	1	38C-26

Wheel balancing pliers



BWP150

20 x 87 x 255 mm	1	BWP150



Digital tyre tread depth gauge



BWTDG1

0 - 25 mm	30 x 76 x 156 mm	50	BWTDG1

Tire valve core tool with 0.45 Nm max torque



BWTVCTT355

0.45 Nm	0.33 lb-ft lbf-ft	1	BWTVCTT355

1/2" impact socket with bihex profile



BT15P524-BT15P536

1/2 in	24 mm	1	BT15P524
1/2 in	30 mm	1	BT15P530
1/2 in	32 mm	1	BT15P532
1/2 in	36 mm	1	BT15P536

Tyre pressure gauge



BWTPG1

20 x 90 x 394 mm	10	BWTPG1

Tyre Nozzle Deflation Caps



BWTPMSS4C

27 x 59 x 108 mm	60 g	25	BWTPMSS4C

3/4" heavy vehicle impact sockets Scania, Volvo



BHVIS08

3/4 in	95 mm	1	BHVIS0895
3/4 in	100 mm	1	BHVIS08100
3/4 in	115 mm	1	BHVIS08115
	109 mm	1	BHVIS109BPW12
	120 mm	1	BHVIS120BPW16

Tire Pressure Monitoring System Maintenance Tool Set



BWTPMSS9

68 x 225 x 225 mm	1049 g	8	BWTPMSS9

1/2" impact socket and bit set



BT15P5

60 x 85 x 255 mm	1	BT15P5

1" thin wall impact sockets



BHVIS12 / BHVIS06

12	68 mm	1	BHVIS1265
6	70 mm	1	BHVIS0670
6	77 mm	1	BHVIS0677
6	80 mm	1	BHVIS0680
6	85 mm	1	BHVIS0685
6	90 mm	1	BHVIS0690
6	95 mm	1	BHVIS0695
6	100 mm	1	BHVIS06100
6	105 mm	1	BHVIS06105

Impact sockets BPW



BHVISxxBPW

3/4 in	111 mm	1	BHVIS111BPW12
3/4 in	80 mm	1	BHVIS80BPW12
3/4 in	95 mm	1	BHVIS95BPW9

Set of wheel hub plate and slide hammer



BWHEPSH8

#4-5 / 116-135 mm	960 x 150 x 150 mm	1	BWHEPSH8

5 kg slide hammer



BWSH5

100 x 100 x 985 mm	2	BWSH5

Wheel hub plate with slide hammer and hydraulic spindle



BWHEPSSH8

12 t / 265-282 mm	#4-5/116-135 mm	1	BWHEPSSH8

Wheel hub plate



BWHEP

#4-5 / 116-135 mm	90 x 147 x 147 mm	1	BWHEP

Slide hammer, 8 kg



BWSH8

960 x 100 x 100 mm	1	BWSH8

Wheel hub hydraulic puller



BWHEPS

12	#4-5/116-135 mm	1	BWHEPS

12 T hydraulic spindle



BWHEHS

12 to	265-282 mm	1	BWHEHS

3.5 kg mass



BSSHE3

60 mm	100 mm	1	BSSHE3

BWHEP	
BWHEHS	



M18 adaptor



BWSH51



M38 mm

M18x38

1 BWSH51

Stainless steel strap pliers



BE251200



170 mm

1 BE251200

Steering Arm Inner Tie Rod Removal Tool Set.



BS52



110 x 315 x 380 mm

3.08 kg

1 BS52

Steering Arm Inner Tie Rod Removal Tool Cages



BS5228-BS523945



28-34 mm

1 BS5228341

34-40 mm

1 BS5234401

39-35 mm

1 BS5239451

CV boot installation pneumatic tool



BPCVB1



25-110 mm 138 x 138 x 455 mm

6 BPCVB1

Axle joint tool



BS54



57 x 57 x 70 mm

1 BS54

Stainless strap and buckles



BE2512005



5 mm 12 m

1 BE2512005

Stainless strap and buckles



BE2512008



8 mm 15 m

1 BE2512008

Tie Rod End Extractor



BS56



1/2 in 57 x 57 x 57 mm

6 BS56

Rear Axle Eccentric Socket



BS45BMW

1/2 in	40 x 43 x 43 mm	20	BS45BMW

Bearing removal and installation set



BT20P26

150 x 310 x 535 mm	1	BT20P26

Ball joint extractor set with 12T hydraulic spindle



BWHPJ12

12 to 70 mm	4	BWHPJ12

Camber Adjusting Tool



BS40VAG

22 mm	52 x 92 x 150 mm	20	BS40VAG

Hydraulic Bearing Removal and Installation Set



BT20P49

164 x 520 x 890 mm	1	BT20P49

VW T4 Supporting Joint Tool



4594VWT4

245 x 112 x 320 mm	5	4594VWT4

Wheel Bearing Tool Set



BWB14

80 x 300 x 525 mm	2	BWB14

Ball joint fork puller



BS6

18 mm	400 mm	1	BS618
23 mm	400 mm	1	BS623

Ball joint socket puller for PSA



BS100PSA1

56 mm	52 mm	1	BS100PSA1



SAC Clutch Tool Set



BE301

80 x 395 x 430 mm	2	BE301	

Centring Mandrels Set for SAC Clutches



BE301CM-SET

26 x 81.5 x 200 mm	50	BE301CM	

BE301CM-02 – Diameter range: 20/26,6 mm

BE301CM-01, BE301CM-02

Centring Mandrels for SAC Clutches



BE301CM

15,19 mm	174 mm	20	BE301CM-01
20,26 mm	174 mm	20	BE301CM-02

Clutch alignment rectifier



BE310

68 x 225 x 280 mm	1.14 kg	8	BE310

SUSPENSION TOOLS & EQUIPMENT

Suspension arm lever bar



BS25

20 Nm	200 kg	1	BS25

MacPherson spring compressor



BS15

125 x 425 x 510 mm		1	BS15
43 x 110 x 160 mm		1	BS15125
165 x 160 x 385 mm		1	BS15125C

42 x 160 x 160 mm	1	BS15160
42 x 160 x 170 mm	1	BS15160C
42 x 160 x 212 mm	1	BS15212
24 x 160 x 215 mm	1	BS15212C
45 x 56 x 95 mm	1	BS1550

Double Pneumatic Piston Shock Absorber Compressor with Protective Screen



BS30PG

1180 x 500 x 625 mm	24 kN	1	BS30PG

Universal Shock Absorber Blocking System



BS10AC2

400 x 400 x 200 mm	1 kg	1	BS10AC2

Moving height extension



BS30AC1



336 x 545 x 450 mm

1 BS30AC1

Turnbuckle shock absorber



BS1000



70 x 405 x 575 mm

- 1 BS1000
- 1 BS100001
- 1 BS100002
- 1 BS100003
- 1 BS100004
- 1 BS100005
- 1 BS100006
- 1 BS100007
- 1 BS100008
- 1 BS100009
- 1 BS100010
- 1 BS100011
- 1 BS100012
- 1 BS100013
- 1 BS100014
- 1 BS100015
- 1 BS100016
- 1 BS100017
- 1 BS100018
- 1 BS100019
- 1 BS100020
- 1 BS100021
- 1 BS100022
- 1 BS100023
- 1 BS100024



- 1 BS100025
- 1 BS100026
- 1 BS100027
- 1 BS100028
- 1 BS100029
- 1 BS100030
- 1 BS100031
- 1 BS100032
- 1 BS100033
- 1 BS100034
- 1 BS100035
- 1 BS100036
- 1 BS100037
- 1 BS100038
- 1 BS100039

BATTERY MANAGEMENT & ELECTRICAL TOOLS

On Board Diagnostic Memory Saver Detector



BELMS12OBDL



40 x 70 x 140 mm

8 BELMS12OBDL

Booster 12V 1,200 CA



BBA12-1200



CA



12V

1200A

1 BBA12-1200

Booster 12/24V 1,700 / 900 CA



BBA1224-1700

V CA



12/24 V

1700/900 A

1 BBA1224-1700

12V/24V Heavy Duty Booster



BBA1224-3200

V CA



12/24 V

3200/1600 A

1 BBA1224-3200

12V Hybrid Booster with Capacitors



BBH12-1200

V CA



12V

1200 A

1 BBH12-1200



Spare battery for 12V boosters



BB1200A

V			
12V	28 Ah	1	BB1200A

3 Amp Fully Automatic Charger/Maintainer for 12V Lead-acid and Lithium LiFePO4 Batteries



BBCE12-3

V	A		
12V	3A	2	BBCE12-3

15 Amp Fully Automatic Charger/Maintainer for 12V Batteries with Supply Mode



BBCE12-15S

V	A		
12V	10/15 A	2	BBCE12-15S

Jumper leads



BBJL

16 mm ²	3 m	5	BBJL1630
25 mm ²	3.5 m	1	BBJL2535
35 mm ²	4.5 m	1	BBJL3545

6 Amp Fully Automatic Charger/Maintainer for 12V Batteries



BBCE12-6

V	A		
12V	6A	2	BBCE12-6

10 Amp Fully Automatic Charger/Maintainer for 24V Batteries



BBCE24-10

V	A		
24V	10A	2	BBCE24-10

2 Amp Fully Automatic Charger/Maintainer for 6V/12V Batteries



BBCE612-2

V	A		
6-12V	2A	2	BBCE612-2

10 Amp Fully Automatic Charger/Maintainer for 12V Batteries



BBCE12-10

V	A		
12V	10A	1	BBCE12-10

100A Battery Charger/Power Supply



BBCE12-F100

V	A		
12V	4/20/70/100AA	1	BBCE12-F100

Mobile charger/starter



BBC420-BBC620

230 V	20/1000 A-h	1	BBC420
230 V	20/1550 A-h	1	BBC620

12V Digital Battery Tester



BBT60A

27 x 95 x 135 mm	36	BBT60A

1000V Voltage Absence Tester, Non-Contact Voltage Tester



BMVAT1000

310 x 50 x 100 mm	0.302 kg	50	BMVAT1000

Hydrometer battery tester



BB10

50 x 50 x 285 mm	1	BB10

6V & 12V Digital Battery Tester with Printer



BBT80

64 x 130 x 251 mm	6	BBT80

1000A AC/DC True RMS Digital Clamp Meter



BDACM1000

60 x 143 x 250 mm	0.551 kg	30	BDACM1000

12V digital battery tester



BBT20

90 x 160 x 345 mm	1	BBT20

Digital multimeter, autoranging, true RMS 1000V, with port for connection to PC



BMMTRMS1

155 x 60 x 225 mm	0.8 kg	1	BMMTRMS1

IR & RF key tester



BELTKEY

35 x 63 x 160 mm	1	BELTKEY



Socket tester 7 pin 12V



BELT127



35 x 63 x 160 mm



1 BELT127

Socket tester 7 Pin 24V (24N)



BELT247N



55 x 63 x 160 mm



1 BELT247N

Terminal set 16 pcs



BELTRP16



58 x 215 x 265 mm



- 1 BELTRP16
- 1 BELTRP1601
- 1 BELTRP1602
- 1 BELTRP1603
- 1 BELTRP1604
- 1 BELTRP1605
- 1 BELTRP1606
- 1 BELTRP1607
- 1 BELTRP1608
- 1 BELTRP1609
- 1 BELTRP1610
- 1 BELTRP1611
- 1 BELTRP1612
- 1 BELTRP1613
- 1 BELTRP1614
- 1 BELTRP1615
- 1 BELTRP1616

12V Vehicle Lamps Operation Plug Socket Tester



BELT1213A



40 x 138 x 205 mm



1.726 kg



20 BELT1213A

Socket tester 7 pin 24V (24S)



BELT247S



35 x 63 x 155 mm



1 BELT247S

24V Vehicle Lamps Operation Plug Socket Tester



BELT2415A



40 x 138 x 205 mm



1.897 kg



20 BELT2415A

Professional gas soldering iron



BGIS125



25-125 W 46 x 88 x 295 mm



20 BGIS125

Memory saver 12V



BELS12



35 x 63 x 160 mm



1 BELS12

12V/24V peak protector



BLP1224



35 x 63 x 160 mm



1 BLP1224

Battery Clamps (quick connect) for Battery Clamps (quick connect) for BBCE12-10 and BBCE24-10 chargers



BBCEC2



68 g



1 BBCEC2

Booster charger cables - spares



BBBCAB



50 x 125 x 50 mm
50 x 125 x 50 mm
50 x 50 x 50 mm



1 BBBCAB-AUZ
1 BBBCAB-EU
1 BBBCAB-UK

Battery clamps (quick connect) for BBCE612-2, BBCE12-3 and BBCE12-6 chargers



BBCEC1



68 g



1 BBCEC1

Ring connectors (quick connect) for BBCE12-10 and BBCE24-10 chargers



BBCER2



100 g



1 BBCER2

Fuse 16A for booster



BBS70206



14 x 115 x 160 mm



15 g



15 BBS70206

Ring connectors (quick connect) for BBCE612-2, BBCE12-3 and BBCE12-6 chargers



BBCER1



100 g



1 BBCER1

Automatic electronic booster chargers



BBBC



55 x 85 x 165 mm
55 x 85 x 166 mm



1 BBBC2A
1 BBBC4A

Fuse 500A for booster



BBS702028



9 x 120 x 168 mm



500 A



1 BBS702028



12V cigarette lighter charging cable for booster BBA12-1200, BBA1224-1700



BBSNL4FX001

26 x 50 x 50 mm	12 V	1	BBSNL4FX001

Spare Booster 12V Charging Cable



BBACCC12V

	1	BBACCC12V

PRESSES & ACCESSORIES

Bench Press, 15 Tonne



BH715

15.000 kg	1	BH715

Press, 20T, 30T and 50T

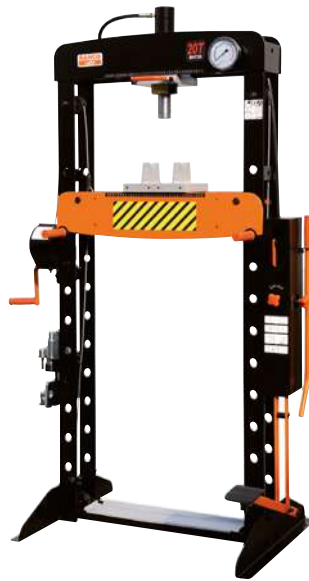

BH720/BH730/BH750

20.000 kg	1	BH720
30.000 kg	1	BH730
50.000 kg	1	BH750

Hydro-pneumatic press 100T



BH7100

100000 kg	1	BH7100A

Universal Press Supports 30 t



BH7PS30

225 x 100 x 275 mm	2	BH7PS30

Press pins set for presses



BH715-13

7.09 kg	1	BH715-13
7.09 kg	1	BH720-22

Safety grids for presses 15, 20, 30 and 50T

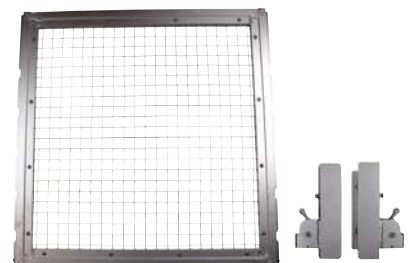

BH7 SG

530 mm	20 mm	1	BH720SG
590 mm	20 mm	1	BH730SG
625 mm	20 mm	1	BH750SG

Safety grid for press 100ton



BH7100SG

150 x 593 x 625 mm	5.54 kg	1 BH7100SG

GENERAL AUTOMOTIVE TOOLS AND EQUIPMENT

Multi-Purpose Tables



BLEMAT1

860 x 155 x 780 mm	28.7 kg	1 BLEMAT1

Multi-Purpose Table Bottom Trays



BLEMAT1BT

50 x 760 x 890 mm	10.5 kg	1 BLEMAT1BT

Set of 4 Storage/Protection Bags for Wheels and Tyres



BWB1418S4/BWB1922S4

355 - 470 mm	6 BWB1418S4
470 - 560 mm	6 BWB1922S4

Magnetic dish



1419-MD

150 mm	1 1419-MD

Round magnetic dish



BMD150

160 mm	1 BMD150

Rectangular magnetic tray



BMR240

250 mm	1 BMR240

Pneumatic stool



BLE305

430 x 410 x 430 mm	1 BLE305

Pneumatic stool



BLE300

380 x 380 x 550 mm	136 kg	1 BLE300



Creepers and stool combo



BLE302

135 x 490 x 1010 mm	136 kg	1	BLE302

Seat cover



5750

1390 mm	1	5750

Dual Laser Headlamp Tester



BLBT100

1650 x 500 x 565 mm	1	BLBT100

Low profile creeper



BLE301

120 x 590 x 1020 mm	136 kg	1	BLE301

Multipurpose Vehicle Front Body Protector



5770

350 x 300 x 85 mm	990 g	12	5770

Rail track for BLBT100



BLBT100AC1

150 x 150 x 1025 mm	7.77 kg	1	BLBT100AC1

Creepers and stool set



BLE304

460 x 1020 x 135 mm	116 / 100 kg	1	BLE304

Car panel protector



BBS50

900 mm	1,2 mm	1	BBS50

Multi-position ratcheting pry bar set



BT10P3

80 x 270 x 375 mm	1	BT10P3

Multi Position Prybar



BT10P325-BT10P338

250 mm	40	BT10P325
300 mm	1	BT10P330
380 mm	1	BT10P338

Long Pry Bar Set with Rubber Grip



BPBLS4

78 x 255 x 1000 mm	9050 g	2	BPBLS4

BPBL00900, BPBL30900, BPBL70600, BPBL90600

Long Pry Bars with Rubber Grip



BPBL

930 mm	5	BPBL00900
925 mm	5	BPBL30900
610 mm	5	BPBL70600
628 mm	5	BPBL90600

BODY SHOP TOOLS

Universal holder with rubber vacuum pads



BBS3BH1

955 mm	1	BBS3BH1

Vacuum Pad for Universal Holder



BBS3BH1-VP

60 x 95 x 95 mm	40	BBS3BH1-VP

Holder for bodywork shop



BBS3UH

950 x 800 x 1200 mm	20 kg	1	BBS3UH

Rubber suction cup



BBS075

160 mm	175 mm	12	BBS075

Two double suction cups and belt



BBS150

120 mm	400 mm	1	BBS150

Glass run channel cleaner



BBS106

25 x 25 x 332 mm	0.145 kg	1	BBS106

Wire starter



BBS103

25 x 25 x 345 mm	1	BBS103



T-handle wire pushing tool



BBS102



265 mm



1 BBS102

Wire grip handle set



BBS101



30 x 80 x 115 mm



1 BBS101

Windscreen cut-out wires



BBS150S



50 m
50 m
50 m



1 BBS150R
1 BBS150S
1 BBS150T

Windscreen cut-out tool



BBS105



20 x 90 x 200 mm



1 BBS105

Urethane cutting knife



BBS10450



10 x 30 x 450 mm 0.240 kg



1 BBS10450

Blades for windscreen cut-out tool



BBS107



1 x 18 x 125 mm



1 BBS107

Blades for windscreen cut-out tool



BBS108



20 x 19 x 88 mm



1 BBS108

WIPER ARM PULLER SET



BBS165



117 x 25 x 78 mm



10 BBS165

Wiper puller set



BBS170P13



80 x 275 x 375 mm



1 BBS170P13
1 BBS170P131
1 BBS170P132
1 BBS170P133
1 BBS170P134
1 BBS170P135
1 BBS170P136
1 BBS170P137
1 BBS170P138
1 BBS170P139
50 BBS165SP4

12 kg slide hammer



BBS12SH



800 mm 12 kg 1 BBS12SH

Bodywork angled pein & finishing hammer



BBSH2CA

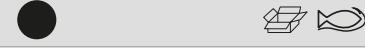

40 mm 12 BBSH2CA

Bodywork shop light bumping hammer



BBSH3CF30



30 mm 25 mm 6 BBSH3CF30

Bodywork dressing hammer



BBSH1F

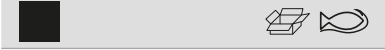

50x30 mm 1 BBSH1F

Bodywork pick & finishing hammer



BBSH2CP

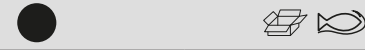

40 mm 6 BBSH2CP

Bodywork light shrinking hammer



BBSH3FS



37 mm 40 mm 6 BBSH3FS

Bodywork dressing hammer



BBSH1M

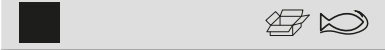

50x30 mm 1 BBSH1M

Bodywork pein & finishing hammer



BBSH2F

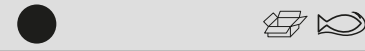

40 mm 6 BBSH2F

Bodywork shrinking hammer



BBSH3MF



30 mm 27 mm 1 BBSH3MF

Bodywork pein & finishing hammer



BBSH2C

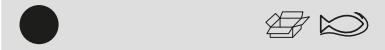

40 mm 1 BBSH2C

Bodywork bumping hammer



BBSH3CF



40 mm 37 mm 6 BBSH3CF

Spare handle for BBSH hammers



BBSHWH1



160 g 1 BBSHWH1



Bodywork American dolly



BBSDA



30 x 63 x 83 mm



1 BBSDA

Bodywork toe dolly



BBSDT



26 x 58 x 120 mm



6 BBSDT

Bodywork double spoon short



BBSS2



150 x 60 x 410 mm



8 BBSS2

Bodywork comma dolly



BBSDC



40 x 58 x 128 mm



6 BBSDC

Bodywork wedge dolly



BBSDW



25 x 64 x 112 mm



6 BBSDW

Bodywork double spoon long



BBSS2L



175 x 60 x 520 mm



2.3 kg



1 BBSS2L

Bodywork diablo dolly



BBSDD



55 x 55 x 55 mm



1 BBSDD

Rubber heel dolly



BBSDHR



40 x 62 x 75 mm



1 BBSDHR

Trim pad remover



2485



240 mm



1 2485

Bodywork heel dolly



BBSDH



30 x 60 x 79 mm



1 BBSDH

Bodywork single spoon



BBSS1



25 x 56 x 390 mm



1 BBSS1

Trip pud removal pliers



BBS200



240 mm



1 BBS200

Trim remover



BBS20P12



35 x 355 x 585 mm



1 BBS20P12

Plastic repair set



BBS210



100 x 280 x 360 mm
 22 x 64 x 106 mm
 22 x 64 x 106 mm
 22 x 64 x 106 mm
 22 x 64 x 106 mm
 22 x 64 x 106 mm
 22 x 64 x 106 mm
 22 x 64 x 106 mm
 22 x 64 x 106 mm
 22 x 64 x 106 mm



1 BBS210
 1 BBS210U06
 1 BBS210U08
 1 BBS210UA06
 1 BBS210UA08
 1 BBS210V06
 1 BBS210V08
 1 BBS210W06
 1 BBS210W08

Airbag removal tool set 12 pcs



BBS100



55 x 160 x 275 mm



1 BBS100
 1 BBS10001



1 BBS10002
 1 BBS10003
 1 BBS10004
 1 BBS10005
 1 BBS100057
 1 BBS10006
 1 BBS10007
 1 BBS10008
 1 BBS10009
 1 BBS10010

Bodywork scraper set, 4 pcs



2220



125 g



1 22209004B

Nut riveter



1468-M6



20 x 110 x 265 mm



1 1468-M6

Nut riveter



1468-M10



50 x 210 x 575 mm



1 1468-M10

1468-M6 nut riveter inserts



1468-6M



15 x 15 x 50 mm
 13 x 13 x 50 mm
 25 x 25 x 55 mm
 20 x 20 x 55 mm



1 1468-6M3
 1 1468-6M4
 1 1468-6M5
 1 1468-6M6

1468-M10 Nut Riveter inserts



1468-10M



17 x 17 x 90 mm
 17 x 17 x 90 mm
 20 x 20 x 90 mm
 20 x 20 x 85 mm
 20 x 20 x 85 mm



1 1468-10M4
 1 1468-10M5
 1 1468-10M6
 1 1468-10M8
 1 1468-10M10



1468-M10 sleeve seat



1468-10-1

70 g	1	1468-10-1

Portable ram sets 4T and 10T



BH8PR

220 x 480 x 1030 mm 168 x 345 x 575 mm	31 kg 18.65 kg	1 BH8PR10000 1 BH8PR4000

Body clamps



BH8BC2

51 x 150 x 220 mm	1	BH8BC2

Body clamps



BH8BC3

90 x 65 x 240 mm	10	BH8BC3

Body clamps



BH8BC1

45 x 135 x 230 mm	1	BH8BC1

Body clamps



BH8BC4

80 x 120 x 175 mm	6	BH8BC4

Body clamps



BH8BC5

45 x 155 x 230 mm	6	BH8BC5

LIFTING EQUIPMENT

Welded bottle jack



BH4S

2000 kg 4000 kg 6000 kg 8000 kg 12000 kg 20000 kg 50000 kg	180 x 83 x 93 mm 190 x 91 x 100 mm 215 x 96 x 114 mm 230 x 103 x 120 mm 235 x 117 x 135 mm 240 x 145 x 153 mm 240 x 315 x 220 mm	6 BH4S2 6 BH4S4 4 BH4S6 4 BH4S8 3 BH4S12 1 BH4S20 1 BH4S50

Premium quality welded bottle jack



BH4

2000 kg 5000 kg	180 x 103 x 103 mm 210 x 110 x 110 mm	1 BH42 1 BH45

10000 kg	220 x 124 x 128 mm	1	BH410
15000 kg	235 x 140 x 140 mm	2	BH415
20000 kg	240 x 165 x 160 mm	1	BH420
30000 kg	245 x 185 x 175 mm	2	BH430

Air Hydraulic Welded Bottle Jacks



BH4HP50

50000 kg	300 x 210 x 310 mm	1	BH4HP50

1.5 T Aluminium Trolley Jack



BH1A1500A

1500 kg	170 x 370 x 660 mm	1	BH1A1500A

2.5 T Aluminium Trolley Jack



BH1A2500A

2500 kg	205 x 385 x 800 mm	1	BH1A2500A

Trolley jack, 3T



BH1EU3000

3000 kg	1400 x 340 x 617 mm	1	BH1EU3000

Trolley jack, 1T



BH1M1000

1000 kg	1280 x 478 x 700 mm	1	BH1M1000

Extra low entry, extra long reach



BH11500

1500 kg	1270 x 364 x 945 mm	1	BH11500

Extra low entry



BH12000

2000 kg	1270 x 364 x 780 mm	1	BH12000

Trolley jack 3T



BH13000

3000 kg	1280 x 364 x 825 mm	1	BH13000



3T trolley jack with Quick Approach



BH13000QA

3000 kg	220 x 395 x 900 mm	1	BH13000QA

Cross beam adaptor, 1 T



BH1CB1000

1000 kg	145 x 125 x 710 mm	1	BH1CB1000

3T long chassis high elevation trolley jack



BH13000L

3000 kg	1310 x 530 x 1370 mm	1	BH13000L

Extra Long Trolley Jack, 5T



BH15000B

5000 kg	330 x 520 x 1670 mm	1	BH15000B

10T Extra Long Trolley Jack



BH110000B

10000 kg	270 x 520 x 1670 mm	1	BH110000B

120 mm extensions for jacks ref. BH15000A and ref. BH110000A



BH15000A-EXT/BH110000A-EXT

108 mm		1	BH15000A-EXT
151 mm		1	BH110000A-EXT

Scissor jack, 4T - 5T



BH1S45

4000 kg	1194 x 212 x 680 mm	1	BH1S45

Spare rubber saddle



BH1RS

BH1A1500A	40	BH1A1500A-05
BH1EU3000	1	BH1EU3000-03
BH11500, BH12000, BH13000, BH13000QA, BH13000L, BH1M1000, BH1A2500A	1	BH11500-04
BH15000A	1	BH15000A-04
BH110000A	1	BH110000A-04

Spare front wheels for jacks



BH1 FW

BH1A2500	1	BH1A2500-03
BH13000	1	BH13000-02
BH1EU3000	1	BH1EU3000-01
BH1M1000, BH11500, BH12000	1	BH11500-02
BH1S45	1	BH1S45-03
BH15000A	1	BH15000A-02
BH110000A	1	BH110000A-02

2 step balloon jacks



BH9BJ22SSH

2000 kg	345 x 265 x 265 mm	1	BH9BJ22SSH

3 step balloon jacks



BH9BJ23

2000 kg	1000 x 250 x 250 mm	1	BH9BJ23SLH

Compact air hydraulic jack, 15T - 30T



BH23015C

30000 kg	1350 x 290 x 430 mm	1	BH23015C

2 step balloon jacks



BH9BJ22

2000 kg	1000 x 265 x 265 mm	1	BH9BJ22SLH

Extensions for pneumatic stage jacks



BH9BJ260_80

970 g 1180 g	1 BH9BJ260 1 BH9BJ280	

Air-hydraulic jack 30T/15T



BH23015

30000 kg	1250 x 282 x 810 mm	1	BH23015

3 step balloon jacks



BH9BJ23SSH

2000 kg	490 x 250 x 250 mm	1	BH9BJ23SSH

Air hydraulic jack, 30T



BH230

360 mm 627 mm	1	BH230	

Extra low entry air-hydraulic



BH2402010

40000 kg	1225 x 302 x 825 mm	1	BH2402010



Air-hydraulic



BH2604020

60000 kg	1250 x 295 x 875 mm	1	BH2604020

Heavy duty saddles



BH2AC60

0.97 kg	78 x 70 x 110 mm	1	BH2AC60V110
2.96 kg	80 x 140 x 140 mm	1	BH2AC60-140

Auto-rising jack stands



BH3A

3000 kg	1	BH3A3000
5000 kg	1	BH3A5000
10000 kg	1	BH3A10000

Air Hydraulic Jacks 80/50T



BH28050

80000 kg	380 x 470 x 1200 mm	1	BH28050

Pair of aluminium of jack stands, 2,500kg capacity



BH3AL2500

2500 kg	1	BH3AL2500

Square base jack stand



BH3SQ

7000 kg	2	BH3SQ7000
15000 kg	2	BH3SQ15000

Adaptor set



BH2AC

67 mm	45-75 mm	1	BH2AC1
75 mm	45-75 mm	1	BH2AC2

Jack stands (pair)



BH33000/BH36000

3000 kg	1	BH33000
6000 kg	1	BH36000

Heavy duty jack stand



BH3HD8000

8000 kg	2	BH3HD8000

Heavy duty jack stand



BH3HD12000

12000 kg		1 BH3HD12000

Hydraulic transmission jack single piston
500kg capacity



BH5SP500QA

500 kg	2041 x 660 x 660 mm	1 BH5SP500QA

Car dolly for vehicle manoeuvring



BH1CD680

16.22 kg	610 x 240 x 220 mm	1 BH1CD680

Heavy duty jack stand



BH3HD16000

16000 kg		1 BH3HD16000

Hydraulic transmission jack double piston
1000kg capacity



BH5DP1000QA

1000 kg	1954 x 759 x 759 mm	1 BH5DP1000QA

Storage rack for car dollies



BH1CD680ST

135 kg	715 x 130 x 155 mm	1 BH1CD680ST

20T Heavy Duty Jack Stand



BH3HD20000A

20000 kg		1 BH3HD20000A

Universal saddle for transmission jacks



BH5US1000

	250 x 340 x 420 mm 260-510 mm	1 BH5US1000

Hydraulic Wheel Dolly 600kg capacity



BH8AC3-600

93.5 kg	1030 x 1050 x 1020 mm	1 BH8AC3-600



Hydraulic Wheel Dolly



BH8AC3-1500



 1730 x 1235 x 1425 mm 174 kg 1 BH8AC3-1500

Hydraulic Wheel Dolly, 1.5T



BH8AC3-1500A





 310 x 1070 x 1345 mm 132 kg 1 BH8AC3-1500A

Foldable europallet crane, 600 kg



BH6PC600





 2315 x 1040 x 1480 mm 96 kg 1 BH6PC600

Foldable crane 1T



BH6FC1000





 2175 x 1030 x 1480 mm 85 kg 1 BH6FC1000

Foldable crane, 2T



BH6FC2000





 2640 x 1220 x 1845 mm 170 kg 1 BH6FC2000

Engine Hoist Load Balancer



BH6AC1-680A









 565 x 12 x 774 mm 1 BH6AC1-680A

Electrical Two-Speed Lifting Table



RS1000







 821 x 800 x 1821 mm 430 kg 1 RS1000

Ball Bearing Top Adaptor for Electrical Lifting Table



RS1000TOP1





 400 x 770 x 1430 mm 110 kg 1 RS1000TOP1

Ball Bearing Platforms for RS1000 Lift Table with M10 Threaded Holes



RS1000TOP2









 400 x 765 x 1524 mm 110 kg 1 RS1000TOP2

Tops for Ball Bearing RS1000TOP1 Platform



RS1000PS0









 8 x 700 x 1400 mm 8.03 kg 1 RS1000PS0

Tops for Ball Bearing RS1000TOP2 Platform



RS1000PS1

 8 x 762 x 1524 mm 12.22 kg 1 RS1000PS1

Hydraulic ISO VG15 oil spare can 250 ml



BHVG15-250









 160 x 60 x 60 mm 220 g 12 BHVG15-250

Spare rear wheels for jacks



BH1_RW

 BH1A1500 1 BH1A1500-04
 BH1A2500 1 BH1A2500-04
 BH1M1000, BH11500,
 BH12000, BH13000 1 BH11500-01
 BH1EU3000 1 BH1EU3000-08
 BH13000L 1 BH13000L-01
 BH1S45-01 1 BH1S45-01
 BH15000A, BH110000A 1 BH15000A-01



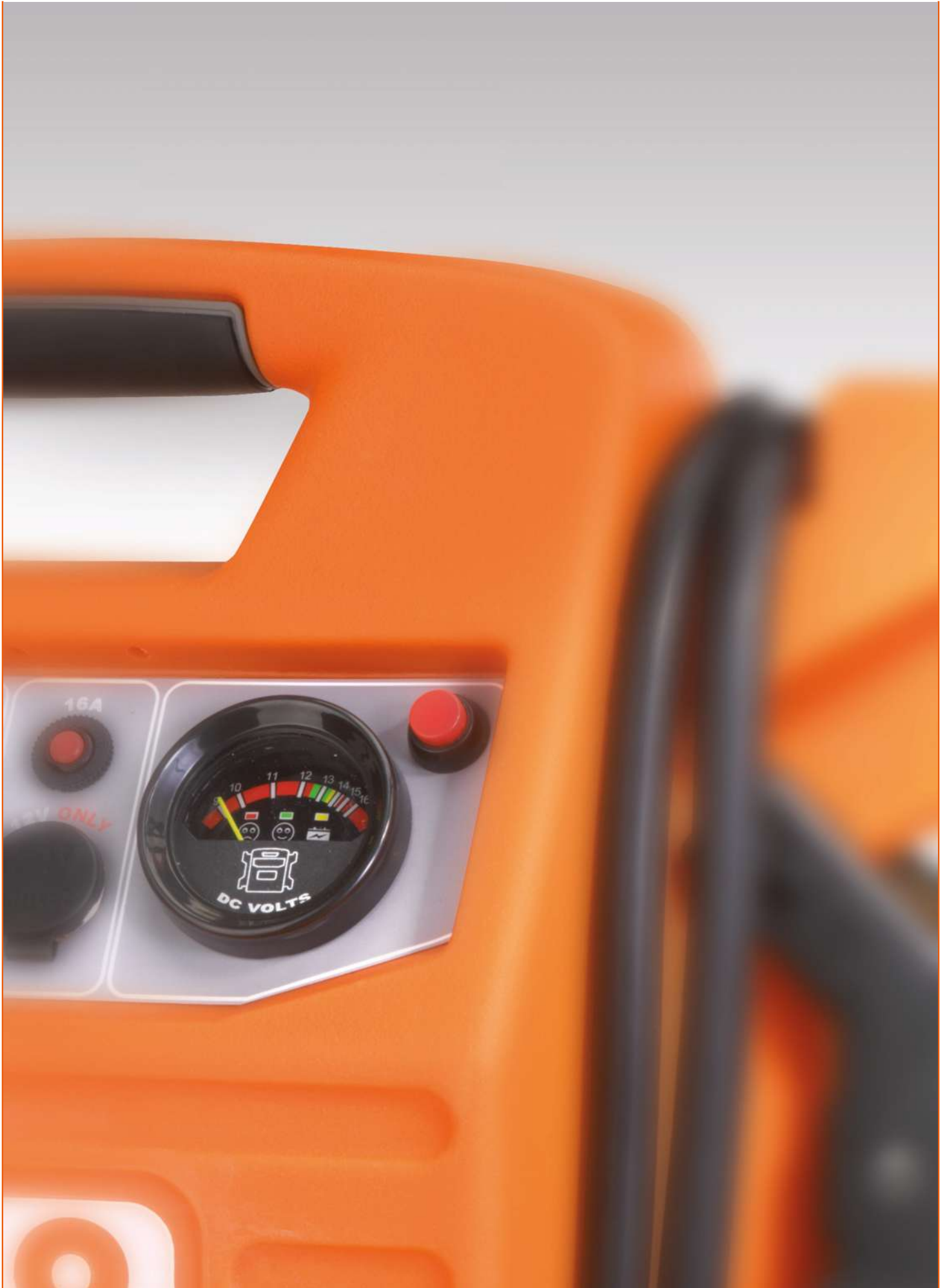

BAHCO



Lighting Equipment



HAND LIGHTS

Pocket Lamps with Torch



BLTS7P

45 lm	58	BLTS7P

Aluminium Flex Work Lights with Torch



BLTFC1

180 lm	20	BLTFC1

360° Cordless Work LED Lamps



BLS128

575 lm	20	BLS128

Slim Lights with Torch



BLTS10

400 lm	20	BLTS10

HEAD LIGHTS

Head Lights with Elastic Strap



BFRL11

260 lm	1	BFRL11

CABLE REELS

2-Phase 230 VAC Cable Reels without Lamp



BLCR230

230 V	800/2000 W	1	BLCR230FR
230 V	800/2000 W	1	BLCR230SC

Lamps with Cable Reels



BLCR24V

230/24 V	60 W	1	BLCR24VCL
230/24 V	60 W	1	BLCR24VLL

3-Phase 400 VAC Cable Reels without Lamp



BLCR400E

400 V	2800/5000 W	1	BLCR400E

Speed Control Adaptors for Cable Reels



BLCRSC

BLCR			
230PL,FR,SC	76 x 91 x 117 mm	1	BLCRSC1
24VCL,VLL	76 x 91 x 117 mm	1	BLCRSC2



Inspection Tools



ENDOSCOPES

Handheld Videoscopes with 3.5" LCD Screen



BE210

Dimensions (mm)	Weight (kg)	Accessories
105 x 325 x 400	2.67	1 BE210
5 x 50 x 56	0.04	1 ZHVIDEOBAT
40 x 44 x 75	0.17	1 ZHVIDEOCHA

Fibre Optic Lens Cables for Endoscopes



BE200C

Probe Diameter (mm)	Length (m)	Accessories
25	10	1 BE200CAB250SH10
25	25	1 BE200CAB250SH25
25	3	1 BE200CAB250SH3
4	1	1 BE200CAB40F1
5.5	1	1 BE200CAB55F1
5.5	3	1 BE200CAB55F3
5.8	1	1 BE200CAB58SR1
5.8	3	1 BE200CAB58SR3
8	1	1 BE200CAB80SR1
8	3	1 BE200CAB80SR3

Mirrored and Magnetic Tips for Endoscopes



BE200M

Angle (°)	Length (mm)	Accessories
0°	4	1 BE200MAG4
0°	5.5, 5.8, 8	1 BE200MAG55 1 BE200MAG80
35°	5.5, 5.8	1 BE200MIR5535
45°	5.5, 5.8	1 BE200MIR5545
55°	5.5, 5.8	1 BE200MIR5555
35°	8	1 BE200MIR8035
45°	8	1 BE200MIR8045
55°	8	1 BE200MIR8055
35°	4	1 BE200MIR4035
45°	4	1 BE200MIR4045
55°	4	1 BE200MIR4055

STETHOSCOPES

Garage Stethoscope Set



BE220

Dimensions (mm)	Weight (kg)	Accessories
130 x 370 x 340	2.94	1 BE220

Stethoscopes with Steel Probe



5050

Length (mm)	Accessories
1050	1 5050

MIRRORS

Magnifying Swivel Head Mirrors



5515GV

Length (mm)	Head Diameter (mm)	Accessories
215	30	1 5515GV

Telescopic Swivel Head Mirrors 52 mm



5515T-52

Length (mm)	Head Diameter (mm)	Accessories
255-450	52	25 5515T-52

Pivoting Inspection Mirror with LED and Insulated Semi-rigid Cable



5515FL

Length (mm)	Cable Dimensions (mm)	Accessories
550	62 x 38	10 5515FL

Plastic Repair Mirrors



5515B

220 mm	28,5 mm	25	5515B

Magnifying Small and Light Mirrors 18 mm



5515L

160 mm	21 mm	1	5515L

Repair Mirrors with Metal Handle 30 mm



5515M

210 mm	30 mm	1	5515M

Swivel Head Telescopic Pocket Mirrors



5515T

180-690 mm	30 mm	25	5515T





BAHCO

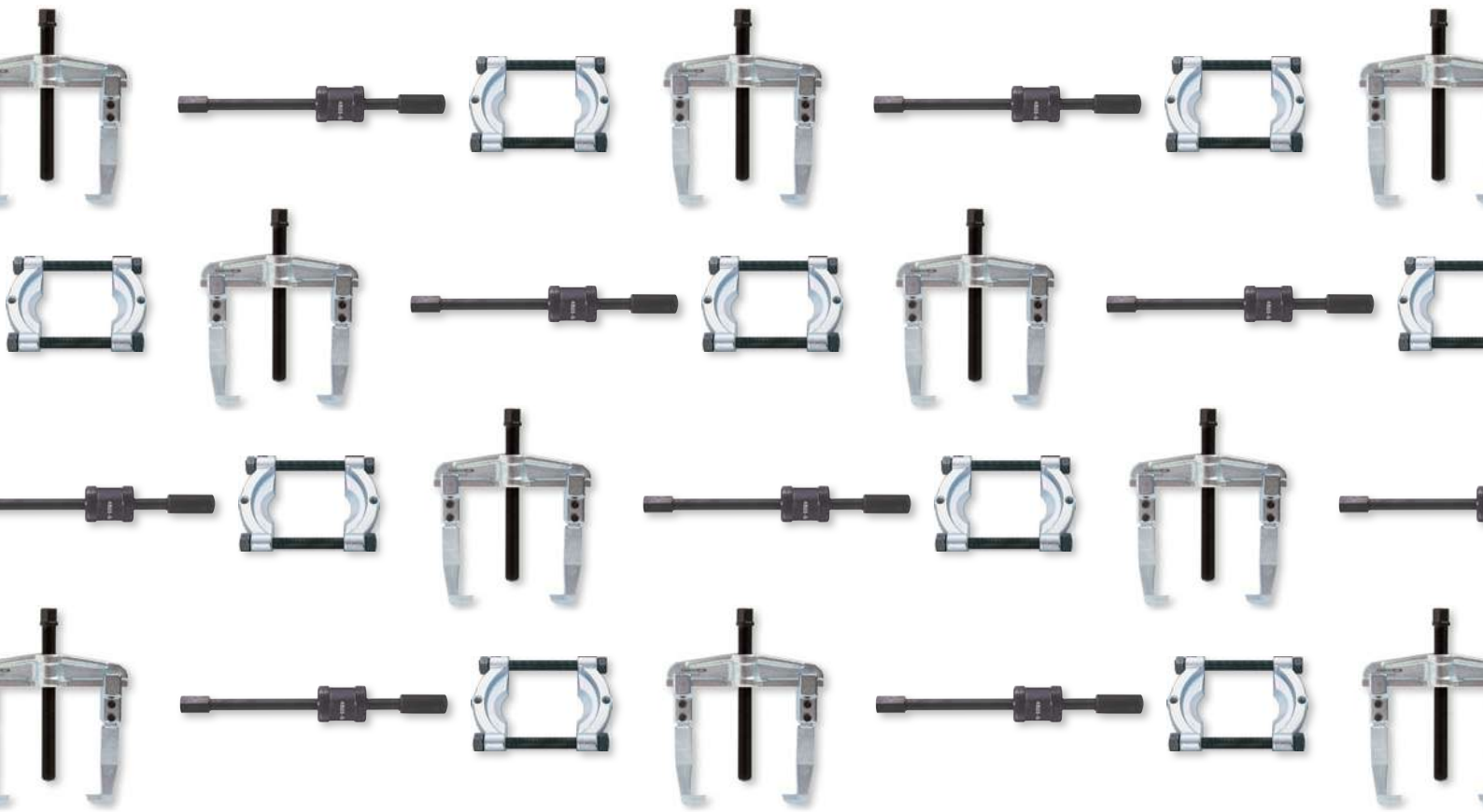

Extractors & Pullers







MECHANICAL

2-Arm Universal Pullers with Induction Hardened Spindle and Galvanized Finish



4532

   			
25-80 mm	100 mm	1	4532-A
25-80 mm	200 mm	1	4532-AL
25-130 mm	100 mm	1	4532-B
25-130 mm	200 mm	1	4532-BL
50-160 mm	150 mm	1	4532-C
50-160 mm	300 mm	1	4532-CL
60-200 mm	150 mm	1	4532-D
80-250 mm	200 mm	1	4532-E
80-350 mm	200 mm	1	4532-F
110-520 mm	200 mm	1	4532-G
110-520 mm	300 mm	1	4532-G-SO
170-640 mm	225 mm	1	4532-H
	100 mm	1	4532K1
	150 mm	1	4532K2
	200 mm	1	4532K3
	225 mm	1	4532K4
	200 mm	1	4532LK1
	300 mm	1	4532LK2
	300 mm	1	4532LK3
	400 mm	1	4532LK4
	500 mm	1	4532LK5
		1	4532-OAB/S
		1	4532-CD/S
		1	4532-EFG/S
		1	4532-H/S

4532/B: Spare body 4532K: Pair of spare arms 4532LK: Pair of long spare arms 4532/S: Spare spindles

2-Arm Universal Pullers with Galvanized Finish



4532-0

   			
20-90 mm	100 mm	1	4532-0

4532-0/B: Spare body 4532K0: Pair of spare arms

2-Arm Universal Pullers with Long Arms/ Spindle and Galvanized Finish





3115

   			
80-250 mm	300 mm	1	3115

2-Arm Universal Puller Set Displays with Galvanized Finish



4532ST/5





  		
16700 g	1	4532ST/5

4532-A, 4532-B, 4532-C, 4532-D, 4532-E

3-Leg and Multi Arm Pullers



4533

   			
150-700 mm	185 mm	1	4533HP
150-700 mm	200 mm	1	4533M
	185 mm	1	4533HPK
	200 mm	1	4533MK
		1	4533HP/S
		1	4533M/S

4533HP: hydraulic 4533M: mechanical 4533/S: Spare spindle 4533/K: Set of 3 spare arms

Hydraulic Rams with Galvanized Finish







4529

   			
8 to 15 to	60 Nm 70 Nm	1	4529-8 4529-15

3-Arm Hydraulic Extractors



4528

   			
50-350 mm	135 mm	1	4528-1
350 mm		1	4528-1/B
	135 mm	1	4528K1
	235 mm	1	4528K2
	285 mm	1	4528K3
	335 mm	1	4528K4
	385 mm	1	4528K5





4528K: Set of 3 spare arms 4528/B: Spare body 4533HP/S: Spare hydraulic spindle

2-/3-Arm Heavy Duty Pullers with Galvanized Finish



4544

   			
10-100 mm	80 mm	1	4544-1
10-120 mm	120 mm	1	4544-2





			
20-160 mm	160 mm	1	4544-3
20-200 mm	200 mm	1	4544-4
10-100 mm	80 mm	1	4544-10
10-120 mm	120 mm	1	4544-20
20-160 mm	160 mm	1	4544-30
100 mm		1	4544-1/B
120 mm		1	4544-2/B
160 mm		1	4544-3/B
200 mm		1	4544-4/B
100 mm		1	4544-10/B
120 mm		1	4544-20/B
160 mm		1	4544-30/B
	80 mm	1	4544K110
	120 mm	1	4544K220
	160 mm	1	4544K330
	200 mm	1	4544K440
		1	4544-110/S
		1	4544-220/S
		1	4519-1/S
		1	4544-440/S

4544-1/4:w/2 arms 4544-10/30:w/3 arms 4544/B: spare body 4544K: spare arm
4544/S: spare spindle

2-/3-Arm Light Duty Pullers with Galvanized Finish



4543





			
10-60 mm	40 mm	1	4543-1
10-70 mm	74 mm	1	4543-2
10-90 mm	84 mm	1	4543-3
10-60 mm	40 mm	1	4543-10
10-70 mm	74 mm	1	4543-20
10-90 mm	84 mm	1	4543-30
70 mm		1	4543-12/B
90 mm		1	4543-3/B
70 mm		1	4543-1020/B
100 mm		1	4543-30/B
	40 mm	1	4543K110
	74 mm	1	4543K220
	84 mm	1	4543K330
		1	4543-1/S
		1	4543-2/S
		1	4543-3/S

4543-1/3:w/2 arms 4543-10/30:w/3 arms 4543/B: Spare body 4543K: Spare arm
4543/S: Spare spindle

2-Arm Pullers with Galvanized Finish



4541





			
20-150 mm	85 mm	1	4541-A
40-220 mm	130 mm	1	4541-B
150 mm		1	4541-A/B
220 mm		1	4541-B/B
	85 mm	1	4541KA
	130 mm	1	4541KB

4541/B: Spare body 4541K: Spare arm 4532-4519/S: Spare spindle

3-Arm Pullers with Galvanized Finish



4542





			
20-150 mm	85 mm	1	4542-A
40-220 mm	130 mm	1	4542-B
150 mm		1	4542-A/B
220 mm		1	4542-B/B





4542/B: Spare body 4541K: Spare arm 4532-4519/S: Spare spindle

2-Arm Puller with Galvanized Finish



4537

			
20-170 mm	130 mm	1	4537-1
20-230 mm	200 mm	1	4537-2
50-300 mm	250 mm	1	4537-3
50-350 mm	350 mm	1	4537-4
170 mm		1	4537-1/B
230 mm		1	4537-2/B





			
350 mm		1	4537-34/B
	130 mm	1	4537K1
	200 mm	1	4537K2
	250 mm	1	4537K3
	350 mm	1	4537K4

4537/B: Spare body 4537K: Spare arm 4532-4519/S: Spare spindle

3-Arm Pullers for 4528M1/4528M2/4528M3 Extractors



4528M





			
		1	4528M1/P
		1	4528M2/P
		1	4528M3/P
20-170 mm	130 mm	1	4528M1
20-230 mm	200 mm	1	4528M2
50-300 mm	250 mm	1	4528M3
50-350 mm	350 mm	1	4528M4
50-400 mm	400 mm	1	4528M5
170 mm		1	4528M1/B
230 mm		1	4528M2/B
400 mm		1	4528M345/B
	400 mm	1	4528MK5

4528M/B: Spare body 4537K-4528MK: Spare arm 4532/S-4519/S: Spare spindle

2-Arm Pullers with Clamp and Galvanized Finish



4519

			
20-110 mm	80-170 mm	1	4519-1
40-150 mm	90-270 mm	1	4519-2
40-150 mm	90-330 mm	1	4519-3
110 mm		1	4519-1/B
150 mm		1	4519-23/B
	170 mm	1	4519K1
	270 mm	1	4519K2
	330 mm	1	4519K3
		1	4519-2/S

4519/B: spare body 4519K: spare arm 4519/S: spare spindle



Scissor-Type Pullers with Galvanized Finish



4614

6-100 mm	70-85 mm	1	4614-1		
10-140 mm	85-120 mm	1	4614-2		
100 mm		1	4614-1/B		
140 mm		1	4614-2/B		
	80 mm	1	4614K1		
	120 mm	1	4614K2		

4614/B: spare body 4614K: pair of spare arms 4543-4532/S: spare spindle

Multiple Extractors - 5 Pcs



4540

30-170 mm	65-140 mm	1	4540-17		
		1	4540-17/S		
75-250 mm	77-180 mm	1	4540-25		
		1	4540-25/S		

Extractors for Separators



4552

4551-A-B		1	4552-1		
4551-C		1	4552-2		
4551-D		1	4552-3		



- 1 4552-1/B
- 1 4552-2/B
- 1 4552-3/B
- 1 4552K1
- 1 4552K2
- 1 4552K3

4552/B: Spare body 4552K: Spare tie rod 4532/S: Spare spindle

Separators with Galvanized Finish



4551

4552-1		1	4551-A		
4552-1		1	4551-B		
4552-2		1	4551-C		
4552-3		1	4551-D		
		1	4551-A/S		
		1	4551-B/S		
		1	4551-C/S		
		1	4551-D/S		

4551/S: spare spindle

Pullers and Separator Set with Galvanized Finish



4574

105 x 300 x 360 mm		1	4574

4532-A, 4532-C, 4532LK1, 4532LK2	
4551-C	
4529-15	

Ball Bearing Extractors without Arms



4581N-4583N

4581NA, 4581NB		1	4581N-1
4581NB2, 4581NC, 4582NA		1	4582N-1
4581NC, 4582NA, 4582NB		1	4582N-2
4582NA, 4583NA, 4583NB		1	4583N-1
4582NA, 4582NB, 4583NB		1	4583N-2

Extractors Spare Arms Set



4581NA-4583NB

145 mm	4581N-1	1	4581NA		
120 mm	4581N-1	1	4581NB		
130 mm	4582N-1	1	4581NB2		
130 mm	4582N-1, 4582N-2	1	4581NC		
150 mm	4582N-1, 4583N-2	1	4582NA		
150 mm	4582N-2, 4583N-2	1	4582NB		
190 mm	4583N-1	1	4583NA		
235 mm	4583N-1, 4583N-2	1	4583NB		

Ball Bearing Puller Set with Galvanized Finish



4580N/7

66 x 192 x 287 mm		1	4580N/7

4581N-1, 4582N-1, 4582N-2, 4583N-1, 4583N-2, 4581NA to 4583NB

Ball Bearing Extractor Set with Galvanized Finish



4578

75 x 235 x 285 mm	1 4578

4581N-1, 4582N-2, 4581NA, 4581NB, 4581NB2, 4581NC

Ball Bearing Internal Extractors with Gunmetal Finish



4521N

5-7 mm	1 4521N-00
7-9 mm	1 4521N-0
9-12 mm	1 4521N-A
10-13 mm	1 4521N-B
13-17 mm	1 4521N-C
14-19 mm	1 4521N-D
16-21 mm	1 4521N-E
18-23 mm	1 4521N-F
20-25 mm	1 4521N-G
25-30 mm	1 4521N-H
30-37 mm	1 4521N-I
35-42 mm	1 4521N-K
38-45 mm	1 4521N-L
43-50 mm	1 4521N-M
40-75 mm	1 4521N-S
70-115 mm	1 4521N-T

2-Arm Counter Stay Extractors with Galvanized Finish



4522

35-75 mm	1 4522-1
60-130 mm	1 4522-2
35-75 mm	1 4522-1/B
60-130 mm	1 4522-2/B
136 mm	1 4522K1
160 mm	1 4522K2
136 mm	1 4522-1/S
160 mm	1 4522-2/S

4522/B: Spare body 4522K: Spare arm 4522/S: Spare spindle

Sliding Hammer Pulling Bars with Gunmetal Finish



4523G

Ø10x170 mm	1 4523G

Sliding Hammer Pulling Bars with Galvanized Finish



4524G

Ø16 x 250 mm	1 4524G

Complete Workshop Puller Assortment Set - 9 Pcs



4521N/7

95 x 360 x 310 mm	6800 g	1 4521N/7

4521N-B, 4521N-D, 4521N-H, 4521N-I, 4521N-L, 4521N-S, 4521N-G
4522-2, 4522-1

Universal Ball Joint Pullers with Galvanized Finish



4545-N

Max 50 mm	18-22 mm	1 4545-N1
Max 90 mm	27-36 mm	1 4545-N11
Max 50 mm	26 mm	1 4545-N2
60-80 mm	26 mm	1 4545-N21
		1 4545-N1/S
		1 4545-N2/S

4545/S: Spare spindle

Universal Hub Pullers with Galvanized Finish



4518

225 mm	140 mm	1 4518-3
225 mm	140 mm	1 4518-4
225 mm	140 mm	1 4518-5



Ball Joint Extractors with Galvanized Finish



4545

Icon	Icon	
18 mm	1	4545-1
25 mm	1	4545-2
29 mm	1	4545-3
40 mm	1	4545-4
45 mm	1	4545-5

Extractors Set for Car Maintenance



4577

Icon	Icon	
70 x 340 x 425 mm	1	4577

4545-N2	
4532-B	
4614-1	
4521N-D, 4521N-B, 4521N-H, 4521N-I, 4521N-G, 4521N-L	
4522-1	

Internal and External Extractor with Sliding Hammer Set



4590SHS5

Icon	Icon	
79 x 230 x 500 mm	4	4590SHS5

Mini Puller Set with Galvanized Finish



4579

Icon	Icon	
65 x 210 x 275 mm	1	4579

4543-2, 4543-3, 4543-1020/B, 4543-30/B, 4543K220, 4543K330

Hydraulic Nut Splitters with Galvanized and Gunmetal Finish



4610

Icon	Icon	
M4-M14	1	4610-1

Mechanical Nut Splitters with Galvanized and Gunmetal Finish



4611

Icon	Icon	
to M16	1	4611-2
to M24	1	4611-3

4611/S: spare spindles 4611/B: spare blades

Spare Blades for Nut Splitters



4611/B

Icon	Icon	
60 g	1	4611-2/B
60 g	1	4611-3/B

Spare Spindles for 4611-2 and 4611-3 Nut Splitters



4611/S

Icon	Icon	
90 g	1	4611-2/S
130 g	1	4611-3/S

Stud Removers with Chromed Plated



4553

5-20 mm	1	4553

Stud Removers with Galvanised and Gunmetal Finish



4591-4593

10-19 mm	1	4592
5-15 mm	1	4591
18-28 mm	1	4593

Stud Extractors Rolled Thread



1420-1424

M 3-6	1	1420-1.4
M 6-8	1	1421-2.1
M 8-11	1	1422-3.1
M11-14	1	1423-4.8
M14-18	1	1424-6.2

Stud Extractors - 5 Pcs



1435/5

15 x 50 x 90 mm	110 g	1 1435/5

1423-4.8, 1420-1.4, 1422-3.1, 1421-2.1, 1424-6.2

Stud Extractors - 8 Pcs



1435/8

29 x 110 x 118 mm	700 g	1 1435/8

M18-24 + M24-33 + M33-45

1420-1.4, 1421-2.1, 1422-3.1, 1423-4.8, 1424-6.2

Stud Extractors for Broken-Off Screws/ Bolts/Studs M5-M24



1419-M5/1419-M16

M5-M10	1	1419-M5
M8-M14	1	1419-M8
M12-M20	1	1419-M12
M16-M24	1	1419-M16

Stud Extractor Set for Broken-Off Screws/ Bolts/Studs - 4 Pcs



1419/4

M5-M24	430 g	1 1419/4

M5-M10; M8-M14; M12-M20; M16-M24

Multi Spline Extractors Set - 15 Pcs



BWMSP15

43 x 90 x 200 mm	0.54 kg	1 BWMSP15

Stud Extraction Bits with Blasted Finish



BWMSP15

3 mm	13 mm	1 BWMSP1501
4 mm	13 mm	1 BWMSP1502
5 mm	13 mm	1 BWMSP1503
5.5 mm	13 mm	1 BWMSP1504
6 mm	13 mm	1 BWMSP1505
8 mm	13 mm	1 BWMSP1506
10 mm	13 mm	1 BWMSP1507
1/8 in	13 mm	1 BWMSP1508
3/16 in	13 mm	1 BWMSP1509
1/4 in	13 mm	1 BWMSP1510
3/8 in	13 mm	1 BWMSP1511
11 mm	16 mm	1 BWMSP1512
12 mm	16 mm	1 BWMSP1513
14 mm	16 mm	1 BWMSP1514
1/2 in	16 mm	1 BWMSP1515



Stud Extractors for Broken-Off Screws/
Bolts/Studs M5-M16



1418S

25 x 127 x 162 mm M6-M16	1	1418S

G220 HSS-M: 3.2, 4.8, 6.4, 8, 8.7 mm DIN 338RN

1411-3.2, 1412-4.8, 1413-6.4, 1414-8, 1415-8.7

Stud Extractors with Alloy Steel



1418

M5-M8	1 1418-4
M8-M10	1 1418-5
D11-M12	1 1418-6
M12-M14	1 1418-7.5
M14-M16	1 1418-8.5

Flat Head Pinch Bars with Hexagon Shank



3684

406 mm	1 3684-16
457 mm	1 3684-18
609 mm	1 3684-24
760 mm	1 3684-30

Flat Head Pry Bar Set with PP Handle



2484/S4

42 x 145 x 693 mm	10 2484/S4

2484-20, 2484-30, 2484-45, 2484-60



Flat Head Pry Bar with Through Blade for
Hammering



2484T-20/2484T-60

210 mm	1 2484T-20
312 mm	1 2484T-30
450 mm	1 2484T-45
600 mm	1 2484T-60



Flat Head Pinch Bars with Flat Shank



3680

400 mm	1 3680

PRY BARS

Combination Pinch Bars with Hexagon
Shank



2632

170 mm	1 2632

Flat Head Pry Bars with PP Handle



2484-20/2484-60

205 mm	1 2484-20
305 mm	1 2484-30
465 mm	1 2484-45
615 mm	1 2484-60

4 pcs Flat Head Pry Bars with Through
Blade for Hammering



2484T/S4

42 x 145 x 693 mm	1950 g	1 2484T/S4

2484T-20, 2484T-30, 2484T-45,
2484T-60



Rolling Head Pry Bar



3683



400 mm



1 3683

BahcoFit Flexible Magnetic Pullers with Rubber Grip 10-18 mm



B147



13 mm
19 mm



400 mm
400 mm



1 B147.001.400
1 B147.003.400

Flexible Pick-Up Tools with Steel Core



2509



555 mm



50 2509

Rolling Head Pry Bars with Phosphated Body



3681



304 mm
406 mm
503 mm



1 3681-11
1 3681-16
1 3681-20

Magnetic pick-up ERGO™



ergo®



2535F



10 mm
10 mm
17 mm



400 mm
400 mm
400 mm



1 2535F1
1 2535F2
1 2535F3

Claw Pick-Up Tools with Steel Core



2530



605 mm



1 2530

PICKING TOOLS

ERGO™ Neodymium Magnetic Pick-Up Tool 4 mm x 290 mm



ergo®

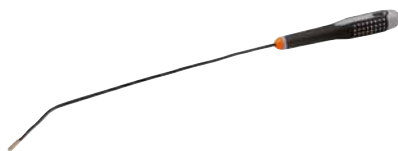

2535F0



5.5 mm



515 mm



1 2535F0

Magnetic pick-up tool with light



2535L



20 mm



40-670 mm



12 2535L

THREAD TOOLS

Thread Cutting Toolset - 37 Pcs



1460M/1



53 x 407 x 220 mm M5-M12



1 1460M/1



Thread Cutting Toolset - 55 Pcs



1460M/2

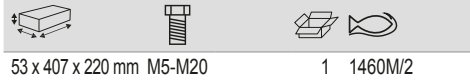

53 x 407 x 220 mm M5-M20

1 1460M/2

Tap Wrenches with Chrome Finish



600

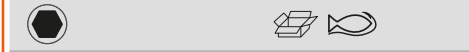

3-10 mm
5-12 mm

1 600.003.010
1 600.005.012

Imperial Double Thread Restorers



1450D-WW



230 mm

1 1450D-WW

Thread Cutting Toolset - 54 Pcs



1460Z/2

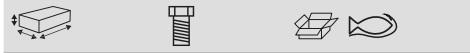

53 x 407 x 220 mm 1/4-3/4

1 1460Z/2

Metric Double Thread Restorers



1450D-ISO



230 mm

1 1450D-ISO

Double Thread Restorers Set in Wooden Box



1450D/2

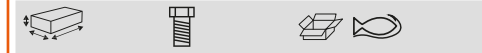

40 x 70 x 270 mm M5-M27

1 1450D/2

1450D-ISO

1450D-WW





Tool Storage & Toolkits



TOOL TROLLEYS

26" E77 Premium Storage HUB Tool Trolleys with 6 Drawers



1477K6



976 x 510 x 820 mm	1	1477K6
976 x 510 x 820 mm	1	1477K6BLACK
976 x 510 x 820 mm	1	1477K6GREY
976 x 510 x 820 mm	1	1477K6WHITE
976 x 510 x 820 mm	1	1477K6RED

26" E77 Premium Storage HUB Tool Trolleys with 7 Drawers



1477K7



976 x 510 x 820 mm	1	1477K7
976 x 510 x 820 mm	1	1477K7BLACK
976 x 510 x 820 mm	1	1477K7GREY
976 x 510 x 820 mm	1	1477K7WHITE
976 x 510 x 820 mm	1	1477K7RED

26" E77 Premium Storage HUB Tool Trolleys with 8 Drawers



1477K8



976 x 510 x 820 mm	1	1477K8
976 x 510 x 820 mm	1	1477K8BLACK



976 x 510 x 820 mm	1	1477K8GREY
976 x 510 x 820 mm	1	1477K8WHITE
976 x 510 x 820 mm	1	1477K8RED

26" E77 Premium Storage HUB Tool Trolleys with 9 Drawers



1477K9



976 x 510 x 820 mm	1	1477K9
976 x 510 x 820 mm	1	1477K9BLACK
976 x 510 x 820 mm	1	1477K9GREY
976 x 510 x 820 mm	1	1477K9WHITE
976 x 510 x 820 mm	1	1477K9RED

26" E72 Storage HUB Tool Trolleys with 5 Drawers



1472K5



952 x 510 x 782 mm	1	1472K5
952 x 510 x 782 mm	1	1472K5BLACK
952 x 510 x 782 mm	1	1472K5GREY
952 x 510 x 782 mm	1	1472K5WHITE
952 x 510 x 782 mm	1	1472K5RED
952 x 510 x 782 mm	1	1472K5BLUE

26" E72 Storage HUB Tool Trolleys with 6 Drawers



1472K6



952 x 510 x 782 mm	1	1472K6
952 x 510 x 782 mm	1	1472K6BLACK
952 x 510 x 782 mm	1	1472K6GREY
952 x 510 x 782 mm	1	1472K6WHITE
952 x 510 x 782 mm	1	1472K6RED
952 x 510 x 782 mm	1	1472K6BLUE

26" E72 Storage HUB Tool Trolleys with 7 Drawers



1472K7



952 x 510 x 782 mm	1	1472K7
952 x 510 x 782 mm	1	1472K7BLACK
952 x 510 x 782 mm	1	1472K7GREY
952 x 510 x 782 mm	1	1472K7WHITE
952 x 510 x 782 mm	1	1472K7RED
952 x 510 x 782 mm	1	1472K7BLUE

26" E72 Storage HUB Tool Trolleys with 8 Drawers



1472K8



952 x 510 x 782 mm	1	1472K8
952 x 510 x 782 mm	1	1472K8BLACK

BAHCO

BLACK GREY WHITE RED BLUE



952 x 510 x 782 mm	1	1472K8GREY
952 x 510 x 782 mm	1	1472K8WHITE
952 x 510 x 782 mm	1	1472K8RED
952 x 510 x 782 mm	1	1472K8BLUE

Premium E87 Storage HUB Top Chests with 4-Drawers



1487K4



402 x 510 x 692 mm	1	1487K4
402 x 510 x 692 mm	1	1487K4BLACK
402 x 510 x 692 mm	1	1487K4GREY

26" E72 Storage HUB Top Chests with 4 Drawers



1482K4



386 x 510 x 692 mm	1	1482K4
386 x 510 x 692 mm	1	1482K4BLACK
386 x 510 x 692 mm	1	1482K4GREY
386 x 510 x 692 mm	1	1482K4WHITE
386 x 510 x 692 mm	1	1482K4RED
386 x 510 x 692 mm	1	1482K4BLUE

Premium E87 Storage HUB Top Chests on Wheels with 4 Drawers



1487K4W



564 x 510 x 692 mm	1	1487K4W
564 x 510 x 692 mm	1	1487K4BKW

26" E72 Storage HUB Top Chests on Wheels with 4 Drawers



1482K4W



542 x 515 x 699 mm	1	1482K4W
542 x 515 x 699 mm	1	1482K4BKW

26" E72 Storage HUB Top Chests on Wheels with 5 Drawers



1482K5W



542 x 515 x 699 mm	1	1482K5W
--------------------	---	---------

Top Tool Panels for 1477K Storage HUB Tool Trolleys



1477K-AC12



396 x 25 x 610 mm	1	1477K-AC12
-------------------	---	------------

Top Side Tool Panels for 1477K Storage HUB Tool Trolleys



1477K-AC13



400 x 25 x 365 mm	1	1477K-AC13
-------------------	---	------------

Work Document Boards for 1477K Storage HUB Tool Trolleys



1477K-AC14



327 x 25 x 240 mm	1	1477K-AC14
-------------------	---	------------



Laptop Boards for 1477K Storage HUB Tool Trolleys



1477K-AC15



80 x 298 x 424 mm



1 1477K-AC15

Windshield Supports for 1477K Storage HUB Tool Trolleys



1477K-AC16



106 x 115 x 208 mm



1 1477K-AC16

Roll Holders for 1477K and 1472K Storage HUB Tool Trolleys



1477K-AC18



33 x 265 x 313 mm



1 1477K-AC18

Jacket Holders for 1477K Storage HUB Tool Trolleys



1477K-AC17



68 x 65 x 435 mm



1 1477K-AC17

Removable Long Guiding Poles for 1477K Storage HUB Tool Trolleys



1477K-AC28



455 x 25 x 25 mm



1 1477K-AC28

Document Holders for 1477K and 1472K Storage HUB Tool Trolleys



1477K-AC19



241 x 65 x 300 mm



1 1477K-AC19

Solid Claw and Ring Mountings for 1477K Storage HUB Tool Trolleys



1477K-AC11



30 x 39 x 68 mm



1 1477K-AC11

Removable Short Guiding Poles for 1477K Storage HUB Tool Trolleys



1477K-AC29



130 x 25 x 25 mm



1 1477K-AC29

Spray Canister Holders for 1477K and 1472K Storage HUB Tool Trolleys



1477K-AC20



125 x 105 x 307 mm



1 1477K-AC20

Power Tool Holders for 1477K and 1472K Storage HUB Tool Trolleys



1477K-AC21



115 x 175 x 302 mm

1 1477K-AC21

Removable Drawer Dividers for 1477K Storage HUB Tool Trolleys



1477K-AC26

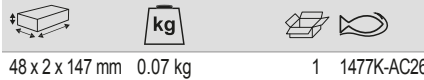

48 x 2 x 147 mm 0.07 kg

1 1477K-AC26

Mifare Locking Systems for 1477K Storage HUB Tool Trolleys



1477K-AC25



135 x 36 x 62 mm

1 1477K-AC25

Side Tool Panels for 1477K and 1472K Storage HUB Tool Trolleys



1477K-AC22



659 x 18 x 300 mm

1 1477K-AC22

Bottom Drawers for 1477K Storage HUB Tool Trolleys



1477K-AC10



110 x 390 x 495 mm

1 1477K-AC10

Stainless Steel Top Middle Parts for 1477K & 1487K Storage HUB Tool Trolleys



1477K-ACTSS



20 x 510 x 550 mm

1 1477K-ACTSS

Folding Tray for 1472K and 1477K Trolleys



1477K-AC30



22 x 430 x 460 mm

1 1477K-AC30

Pin Code Locking Systems for 1477K Storage HUB Tool Trolleys



1477K-AC24



135 x 36 x 62 mm

1 1477K-AC24

Wooden Top Middle Parts for 1477K & 1487K Storage HUB Tool Trolleys



1477K-ACTW



20 x 510 x 550 mm

1 1477K-ACTW



Composite Bench Tops for 1477K Storage HUB Tool Trolley



1477K-ACTP

20 x 510 x 550 mm	1	1477K-ACTP

Chestnut Wood Tops for 1472K & 1482K Storage HUB Tool Trolley



1472K-ACTW

30 x 501 x 680 mm	1	1472K-ACTW

Sheet of Tags for 1477K/1472K/1475K Storage HUB Tool Trolleys



1477K-AC23

1 x 210 x 300 mm	1	1477K-AC23

MDF Top Middle Parts for 1477K Storage HUB Tool Trolleys



1477K-ACTD

20 x 510 x 550 mm	1	1477K-ACTD

MDF Tops for 1472K & 1482K Storage HUB Tool Trolley



1472K-ACTD

30 x 501 x 682 mm	1	1472K-ACTD

26" Low Height Tool Trolleys with 7 Drawers



1470K7LH

755 x 501 x 760 mm	1	1470K7LH
755 x 501 x 760 mm	1	1470K7LHBLUE
755 x 501 x 760 mm	1	1470K7LHGREY
755 x 501 x 760 mm	1	1470K7LHRED

Stainless Steel Tops for 1472K & 1482K Storage HUB Tool Trolley



1472K-ACTSS

30 x 501 x 682 mm	1	1472K-ACTSS

Leather Key Rings for Trolley Keys



KEYRING

10 x 30 x 70 mm	0.20 kg	50 KEYRING

26" Classic C75 Tool Trolleys with 6 Drawers



1475K6

956 x 501 x 763 mm	1	1475K6
956 x 501 x 763 mm	1	1475K6BLACK
956 x 501 x 763 mm	1	1475K6BLUE
956 x 501 x 763 mm	1	1475K6RED

26" Classic C75 Tool Trolleys with 7 Drawers



1475K7

956 x 501 x 763 mm	1	1475K7
956 x 501 x 763 mm	1	1475K7BLACK
956 x 501 x 763 mm	1	1475K7BLUE
956 x 501 x 763 mm	1	1475K7RED

26" Classic C75 Tool Trolleys with 8 Drawers



1475K8

956 x 501 x 763 mm	1	1475K8
956 x 501 x 763 mm	1	1475K8BLACK
956 x 501 x 763 mm	1	1475K8BLUE
956 x 501 x 763 mm	1	1475K8RED

40" Classic C75 Tool Trolleys with 6 Drawers



1475KXL6

986 x 501 x 1100 mm	1	1475KXL6
986 x 501 x 1100 mm	1	1475KXL6BLACK
986 x 501 x 1100 mm	1	1475KXL6BLUE
986 x 501 x 1100 mm	1	1475KXL6RED

40" Classic C75 Tool Trolleys with 6 Drawers and Side Cabinet



1475KXL6C

986 x 501 x 1100 mm	1	1475KXL6C
986 x 501 x 1100 mm	1	1475KXL6CBLACK

40" Classic C75 Tool Trolleys with 7 Drawers



1475KXL7

986 x 501 x 1100 mm	1	1475KXL7
986 x 501 x 1100 mm	1	1475KXL7BLACK
986 x 501 x 1100 mm	1	1475KXL7BLUE
986 x 501 x 1100 mm	1	1475KXL7RED

40" Classic C75 Tool Trolleys with 8 Drawers



1475KXL8

986 x 501 x 1100 mm	1	1475KXL8
986 x 501 x 1100 mm	1	1475KXL8BLACK
986 x 501 x 1100 mm	1	1475KXL8BLUE
986 x 501 x 1100 mm	1	1475KXL8RED

40" Classic C75 Tool Trolleys with 12 Drawers



1475KXL12

986 x 501 x 1100 mm	1	1475KXL12
986 x 501 x 1100 mm	1	1475KXL12BLACK
986 x 501 x 1100 mm	1	1475KXL12RED

53" Special Tool Trolley with 8 Drawers and Side Cabinet



1475KXXL8CWTS

1218 x 500 x 1505 mm	1089 kg	1 1475KXXL8CWTS

53" Double Bank Tool Trolleys with 12 Drawers



1471KXXL12BKTSS

1016 x 501 x 1440 mm	1	1471KXXL12BKTSS



53" Tool Trolleys with 7 Drawers



1476KXXL7BK



986 x 501 x 1430 mm

1 1476KXXL7BK

Foldable Trays for 1470 and 1475 Drawers



1470K-AC1



9 x 455 x 395 mm

1 1470K-AC1

Document Holders for 1470 and 1475 Drawers



1470K-AC4



180 x 83 x 360 mm

1 1470K-AC4

26" Classic C85 Top Chests with 4 Drawers



1485K4



417 x 500 x 677 mm
417 x 500 x 677 mm
417 x 500 x 677 mm
417 x 500 x 677 mm

1 1485K4
1 1485K4BLACK
1 1485K4BLUE
1 1485K4RED

Tool Holders for 23 Pcs Screwdrivers/Pry Bars

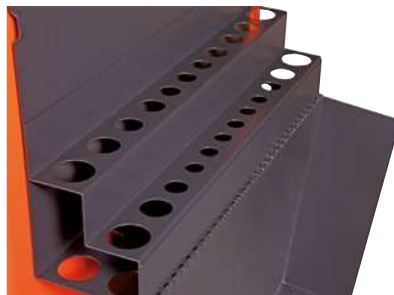

1470K-AC2



280 x 100 x 428 mm

1 1470K-AC2

Metallic Side Panels with Slots and Dots



1470K-ACSIDE



822 x 20 x 418 mm

1 1470K-ACSIDE

40" Classic C85 Top Chests with 4 Drawers



1485KXL4



417 x 500 x 1016 mm
417 x 500 x 1016 mm
417 x 500 x 1016 mm
417 x 500 x 1016 mm

1 1485KXL4
1 1485KXL4BLACK
1 1485KXL4BLUE
1 1485KXL4RED

Can Holders for 1470 and 1475 Drawers



1470K-AC3



140 x 90 x 457 mm

1 1470K-AC3

26" ABS Tops for 26" Trolleys



1470K-AC7



45 x 497 x 674 mm

1 1470K-AC7

Metallic Side Panels for 1495TP Hook System



1475K-ACSIDE



822 x 20 x 418 mm

1 1475K-ACSIDE

Side Cabinet with Lock for 1475KXXL Trolley



1475KXXL-AC20BK



820 x 503 x 419 mm

1 1475KXXL-AC20BK

MDF Top for Tool Trolleys 40 mm



1470K-ACTD



40 x 495 x 1012 mm
40 x 497 x 674 mm

1 1470KXXL-ACTD
1 1470K-ACTD

Tool Panels for 1475K 26" Trolleys

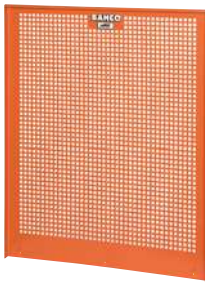

1470K-AC8



850 x 25 x 680 mm
850 x 25 x 680 mm

1 1470K-AC8
1 1470K-AC8GR

Stainless Steel Tops for Tool Trolleys 40 mm



1475KXXL-ACTSS



45 x 495 x 1347 mm

1 1475KXXL-ACTSS

Metallic Adjustable Trays for Side Cabinet



1470KXXLC-TRAY



470 x 10 x 310 mm

1 1470KXXLC-TRAY

Chestnut Tops for Tool Trolleys 40 mm



1470K-ACTW



40 x 500 x 1012 mm
40 x 497 x 674 mm

1 1470KXXL-ACTW
1 1470K-ACTW

Chestnut Wood Tops for 1475KXXL Tool Trolley



1475KXXL-ACTW



45 x 495 x 1347 mm

1 1475KXXL-ACTW

Drawer Liner Set - 7 Pcs



1470KAC1



100 x 445 x 543 mm

1 1470KAC01



Two Tray Steel Roll Carts



1470KC2



1051 x 435 x 764 mm



1 1470KC2

Middle Trays for 1470KC2 Roll Cart

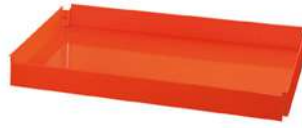

1470KCTRAY



750 mm



420 mm



1 1470KCTRAY

Three Tray Steel Roll Carts



1470KC3A



1051 x 435 x 764 mm



1 1470KC3A

Folding Transport Trolleys with Aluminium Tray



1430FT120



1077 x 520 x 487 mm 6.4 kg



1 1430FT120

Multifunctional Two Tray Aluminium Roll Carts



1470KC5



1051 x 435 x 1381 mm



1 1470KC5

1051 x 435 x 1381 mm

1 1470KC5PC

Fit&Go 1/3 Foam Inlay 4 Slotted/3 Phillips Screwdriver Set - 7 Pcs



FF1E1001



38 x 181 x 445 mm



1 FF1E1001

BE-8030, BE-8040, BE-8242, BE-8252



BE-8610, BE-8620, BE-8623



Fit&Go 1/3 Foam Inlay 5 Slotted/2 Phillips Screwdriver Set - 7 Pcs



FF1E1002



39 x 181 x 445 mm



1 FF1E1002

BE-8242, BE-8040, BE-8030



BE-8257, BE-8255



BE-8611, BE-8621



Fit&Go 1/3 Foam Inlay Slotted/Pozidriv Screwdriver Set - 6 Pcs



FF1E1003



38 x 181 x 445 mm



1 FF1E1003

BE-8240



BE-8150, BE-8255, BE-8256



BE-8810, BE-8820



Fit&Go 1/3 Foam Inlay Slotted/Phillips/Pozidriv Screwdriver Set - 8 Pcs









FF1E1004



40 x 181 x 445 mm



1 FF1E1004









- BE-8340, BE-8350  
- BE-8600, BE-8610  
- BE-8811, BE-8800, BE-8820L, BE-8821  

Fit&Go 1/3 Foam Inlay Slotted/Phillips/
Pozidriv/Hex Screwdriver Set - 7 Pcs



FF1E1005

 40 x 181 x 445 mm  1 FF1E1005









- BE-8210, BE-8010  
- BE-8811, BE-8821, BE-8800  
- BE-8600  
- BE-8830  

Fit&Go 1/3 Foam Inlay Slotted/Phillips/
Pozidriv Screwdriver Set - 6 Pcs



FF1E1006

 40 x 181 x 445 mm  1 FF1E1006



- BE-8210  
- BE-8610, BE-8620  
- BE-8630  
- BE-8811, BE-8820  

Fit&Go 1/3 Foam Inlay TORX® Screwdriver
Set T10-T40 - 6 Pcs



FF1E1007

 40 x 181 x 445 mm  1 FF1E1007



- BE-8910, BE-8915, BE-8920, BE-8925,
BE-8930, BE-8940  

Fit&Go 1/3 Foam Inlay TORX® Tamper-
Resistant Screwdriver Set TR10-TR40 - 6
Pcs



FF1E1008

 38 x 181 x 445 mm  1 FF1E1008



- BE-7910, BE-7930, BE-7925, BE-7920,
BE-7915, BE-7940  

Fit&Go 1/3 Foam Inlay TORX® Screwdriver
Set T8-T30 - 6 Pcs



FF1E1009

 38 x 181 x 445 mm  1 FF1E1009





- BE-8908, BE-8910, BE-8915, BE-8920,
BE-8925, BE-8930  

Fit&Go 1/3 Foam Inlay Slotted/Phillips
Insulated Screwdriver Set 39 mm x 181
mm x 445 mm - 6 Pcs



FF1E1010

 39 x 181 x 445 mm  1 FF1E1010





- BE-8010S, BE-8230S, BE-8050S,
BE-8255S  
- BE-8610S, BE-8620S  

Fit&Go 1/3 Foam Inlay Slotted/Phillips
Insulated Screwdriver Set 45 mm x 181
mm x 445 mm - 6 Pcs



FF1E1011

 45 x 181 x 445 mm  1 FF1E1011

- BE-8040S, BE-8050S, BE-8255S,
BE-8065S  
- BE-8610S, BE-8620S  



Fit&Go 1/3 Foam Inlay 1/4" Socket and Pear Head Ratchet Set - 37 Pcs



FF1E2001



38 x 181 x 445 mm

1 FF1E2001

6700SM-10, 6700SM-11, 6700SM-14, 6700SM-13, 6700SM-12, 6700SM-4, 6700SM-9, 6700SM-8, 6700SM-7, 6700SM-6, 6700SM-5.5, 6700SM-5		
6700TORX-E10, 6700TORX-E8, 6700TORX-E7, 6700TORX-E6, 6700TORX-E5, 6700TORX-E4		
6709M-8, 6709M-6, 6709M-5, 6709M-4, 6709M-3		
6709TORX-T20, 6709TORX-T15, 6709TORX-T10, 6709TORX-T40, 6709TORX-T30, 6709TORX-T27, 6709TORX-T25, 6709TORX-T8, 6709TORX-T9		
6950SL		
6954		
6956		
6960		
6966		

Fit&Go 1/3 Foam Inlay 1/4" Socket and Pear Head Ratchet Set - 45 Pcs



FF1E2002



38 x 181 x 445 mm

1 FF1E2002

6700SM-4, 6700SM-4.5, 6700SM-5, 6700SM-5.5, 6700SM-6, 6700SM-7, 6700SM-8, 6700SM-9, 6700SM-10, 6700SM-11, 6700SM-12, 6700SM-13, 6700SM-14		
6709PZ-1, 6709PZ-3, 6709PZ-2		
6709PH-1, 6709PH-2, 6709PH-3		
6709TORX-T10, 6709TORX-T15, 6709TORX-T20, 6709TORX-T25, 6709TORX-T30, 6709TORX-T40		
6709F-4.5, 6709F-5.5, 6709F-8		
6709M-3, 6709M-4, 6709M-5, 6709M-6, 6709M-8		
1998M-3, 1998M-2.5, 1998M-2, 1998M-1.5		
6950SL		
6962-W		
6966		
6956		
6960, 6961		
7765		
6954		

Fit&Go 1/3 Foam Inlay 1/4" Socket and Pear Head Ratchet Set - 19 Pcs



FF1E2003



38 x 181 x 445 mm

1 FF1E2003

6700SM-14, 6700SM-13, 6700SM-12, 6700SM-11, 6700SM-10, 6700SM-9, 6700SM-8, 6700SM-7, 6700SM-6, 6700SM-5.5, 6700SM-5		
BE-9778		
6950SL		
6956		
6962		
6966		
7765		
6954		
1998M-12		

Fit&Go 1/3 Foam Inlay 1/4" Socket and Pear Head Ratchet Set - 48 Pcs



FF1E2004



44 x 181 x 445 mm

1 FF1E2004

A6700DM-14, A6700DM-13, A6700DM-12, A6700DM-11, A6700DM-10, A6700DM-9, A6700DM-8, A6700DM-7, A6700DM-6, A6700DM-5.5, A6700DM-5		
808050S		
6950SL		
6966		
6972H		
6962		
7765		
59S/31-1		

Fit&Go 1/3 Foam Inlay 1/4" Socket and Pear Head Ratchet Set - 17 Pcs



FF1E2005



35 x 181 x 445 mm

1 FF1E2005

6700SM-14, 6700SM-13, 6700SM-12, 6700SM-11, 6700SM-10, 6700SM-9, 6700SM-8, 6700SM-7, 6700SM-6, 6700SM-5.5		
6950RN		
6962, 6960		
6966		
6954		
6956		
6972H		

Fit&Go 1/3 Foam Inlay 1/4" Socket and Round Head Ratchet Set - 35 Pcs



FF1E2006

39 x 181 x 445 mm	1	FF1E2006

6700SZ-5/16, 6700SZ-5/32, 6700SZ-11/32, 6700SZ-7/16, 6700SZ-9/32, 6700SZ-3/16, 6700SZ-3/8, 6700SZ-7/32, 6700SZ-1/4, 6700SZ-1/2, 6700SZ-9/16		
6709PZ-1, 6709PZ-2, 6709PZ-3		
6709PH-1, 6709PH-2, 6709PH-3		
6709TORX-T8, 6709TORX-T10, 6709TORX-T15, 6709TORX-T20, 6709TORX-T25, 6709TORX-T30		
6709F-4.5, 6709F-6.5, 6709F-8		
6950RN		
6954		
6972H		
6960, 6962		
6963		
6966		
6956		
7765		

Fit&Go 1/3 Foam Inlay 1/4" Socket and Round Head Ratchet Set - 24 Pcs



FF1E2007

35 x 181 x 445 mm	1	FF1E2007

6700SZ-9/32, 6700SZ-3/16, 6700SZ-3/8, 6700SZ-1/4, 6700SZ-7/16, 6700SZ-7/32, 6700SZ-1/2, 6700SZ-11/32		
1995Z-5/64, 1995Z-5/32, 1995Z-3/8, 1995Z-3/32, 1995Z-7/32, 1995Z-1/8, 1995Z-5/16, 1995Z-3/16, 1995Z-1/4		
6950RN		
6954		
6972H		
6960, 6962		
6956		
6966		

Fit&Go 1/3 Foam Inlay 1/4" Socket and Round Head Ratchet Set - 26 Pcs



FF1E2008

35 x 181 x 445 mm	1	FF1E2008

6700SM-5.5, 6700SM-8, 6700SM-7, 6700SM-6, 6700SM-12, 6700SM-11, 6700SM-10, 6700SM-9, 6700SM-14, 6700SM-13		
1995M-3, 1995M-2, 1995M-7, 1995M-6, 1995M-5, 1995M-4, 1995M-10, 1995M-9, 1995M-8		
6950RN		
6960, 6962		
6966		
6954		
6956		
6972H		

Fit&Go 1/3 Foam Inlay 3/8" Socket and Pear Head Ratchet Set - 24 Pcs



FF1E2101

40 x 181 x 445 mm	1	FF1E2101

7400SM-8, 7400SM-7, 7400SM-6, 7400SM-12, 7400SM-11, 7400SM-10, 7400SM-9, 7400SM-22, 7400SM-16, 7400SM-15, 7400SM-14, 7400SM-13, 7400SM-20, 7400SM-19, 7400SM-18, 7400SM-17		
7750SL		
7760, 7761, 7762		
7764		
7766		
7754		
8164-1/2		

Fit&Go 1/3 Foam Inlay 3/8" Socket and Pear Head Ratchet Set - 25 Pcs



FF1E2102

38 x 181 x 445 mm	1	FF1E2102

7400SM-8, 7400SM-7, 7400SM-6, 7400SM-12, 7400SM-11, 7400SM-10, 7400SM-9, 7400SM-16, 7400SM-15, 7400SM-14, 7400SM-13, 7400SM-19, 7400SM-18, 7400SM-17		
7409M-5, 7409M-4, 7409M-10, 7409M-8, 7409M-6		
7750SL		
7760, 7762		
7754		
7768		
8164-1/2		

Fit&Go 1/3 Foam Inlay 3/8" Socket and Pear Head Ratchet Set - 28 Pcs



FF1E2103

38 x 181 x 445 mm	1	FF1E2103

7400SM-8, 7400SM-7, 7400SM-12, 7400SM-11, 7400SM-10, 7400SM-9, 7400SM-22, 7400SM-21, 7400SM-16, 7400SM-15, 7400SM-14, 7400SM-13, 7400SM-20, 7400SM-19, 7400SM-18, 7400SM-17		
7400TORX-E10, 7400TORX-E8, 7400TORX-E18, 7400TORX-E16, 7400TORX-E14, 7400TORX-E12		
7750SL		
7760, 7762		
7768		
7766		
SBS705		



Fit&Go 1/3 Foam Inlay 3/8" Socket and Round Head Ratchet Set - 20 Pcs



FF1E2104



38 x 181 x 445 mm

1 FF1E2104

7400SM-8, 7400SM-6, 7400SM-12, 7400SM-11, 7400SM-10, 7400SM-9, 7400SM-22, 7400SM-16, 7400SM-15, 7400SM-14, 7400SM-13, 7400SM-20, 7400SM-19, 7400SM-18, 7400SM-17



7750RN



7761, 7762



7766



7768



Fit&Go 1/3 Foam Inlay 3/8" Socket and Bit Driver Set - 28 Pcs



FF1E2105



35 x 181 x 445 mm

1 FF1E2105

7400TORX-E18, 7400TORX-E10, 7400TORX-E8, 7400TORX-E16, 7400TORX-E14, 7400TORX-E12, 7400TORX-E11



7409TORX-T50, 7409TORX-T45, 7409TORX-T40, 7409TORX-T30, 7409TORX-T25

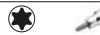

7409TORX-T25-L, 7409TORX-T50-L, 7409TORX-T45-L, 7409TORX-T40-L, 7409TORX-T30-L



7409M-5, 7409M-4, 7409M-10, 7409M-8, 7409M-6

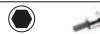

7409F-10, 7409F-8, 7409F-6.5



7409PH-3, 7409PH-2, 7409PH-1



Fit&Go 1/3 Foam Inlay 1/2" Socket and Round Head Ratchet Set - 21 Pcs



FF1E2201



44 x 181 x 445 mm

1 FF1E2201

7800SM-11, 7800SM-10, 7800SM-15, 7800SM-13, 7800SM-12, 7800SM-19, 7800SM-17, 7800SM-14, 7800SM-18, 7800SM-22, 7800SM-21, 7800SM-20, 7800SM-27, 7800SM-24



7805SM-16, 7805SM-21



8150SL



8160-5, 8160-10



8166



8171



Fit&Go 1/3 Foam Inlay 1/2" Socket and Pear Head Ratchet Set - 21 Pcs



FF1E2202



45 x 181 x 445 mm

1 FF1E2202

7800SM-9, 7800SM-8, 7800SM-10, 7800SM-11, 7800SM-12, 7800SM-15, 7800SM-14, 7800SM-13, 7800SM-19, 7800SM-17, 7800SM-16, 7800SM-18, 7800SM-23, 7800SM-21, 7800SM-20, 7800SM-27, 7800SM-24



8150-1/2



8160-5, 8160-10



8166



Fit&Go 1/3 Foam Inlay 1/2" Socket and Round Head Ratchet Set - 22 Pcs



FF1E2203



50 x 181 x 445 mm

1 FF1E2203

7800SM-8, 7800SM-9, 7800SM-11, 7800SM-10, 7800SM-15, 7800SM-14, 7800SM-13, 7800SM-12, 7800SM-19, 7800SM-18, 7800SM-17, 7800SM-16, 7800SM-22, 7800SM-21, 7800SM-27, 7800SM-24, 7800SM-32, 7800SM-30



8150RN-1/2



8160-5, 8160-10



8166



Fit&Go 1/3 Foam Inlay 1/2" Socket and Round Head Ratchet Set - 15 Pcs



FF1E2204



45 x 181 x 445 mm

1 FF1E2204

7800DZ-1/2, 7800DZ-3/4, 7800DZ-19/32, 7800DZ-7/8, 7800DZ-7/16, 7800DZ-11/16, 7800DZ-9/16, 7800DZ-13/16, 7800DZ-3/8, 7800DZ-5/8, 7800DZ-15/16



8150RN-1/2



8160-5, 8160-10



8166



Fit&Go 1/3 Foam Inlay 1/2" Socket Set - 28 Pcs



FF1E2205



50 x 181 x 445 mm

1 FF1E2205

7800DM-10, 7800DM-11, 7800DM-12, 7800DM-13, 7800DM-14, 7800DM-15, 7800DM-16, 7800DM-17, 7800DM-18, 7800DM-19, 7800DM-20, 7800DM-21, 7800DM-22, 7800DM-23, 7800DM-24, 7800DM-25, 7800DM-26, 7800DM-27, 7800DM-28, 7800DM-30, 7800DM-32



7809M-6, 7809M-7, 7809M-8, 7809M-9, 7809M-10, 7809M-12, 7809M-14



Fit&Go 1/3 Foam Inlay 1/2" Socket Set - 27 Pcs



FF1E2206



50 x 181 x 445 mm

1 FF1E2206

7800SM-11, 7800SM-10, 7800SM-15, 7800SM-14, 7800SM-13, 7800SM-12, 7800SM-19, 7800SM-18, 7800SM-17, 7800SM-16, 7800SM-23, 7800SM-22, 7800SM-21, 7800SM-20, 7800SM-27, 7800SM-26, 7800SM-25, 7800SM-24, 7800SM-28, 7800SM-32, 7800SM-30



7809XZN-8, 7809XZN-10



7809PZ-3, 7809PZ-2



7809F-10, 7809F-8



Fit&Go 1/3 Foam Inlay 1/2" Socket Set/Bit Set/Key Set - 25 Pcs



FF1E2207



40 x 181 x 445 mm

1 FF1E2207

7809TORX-T60, 7809TORX-T55, 7809TORX-T25, 7809TORX-T20, 7809TORX-T40, 7809TORX-T30, 7809TORX-T27, 7809TORX-T50, 7809TORX-T45



7800TORX-E18, 7800TORX-E16, 7800TORX-E14, 7800TORX-E12, 7800TORX-E24, 7800TORX-E20, 7800TORX-E10, 7800TORX-E8



BE-9675



Fit&Go 1/3 Foam Inlay 1/2" Bit Driver Set - 12 Pcs



FF1E2208



35 x 181 x 445 mm

1 FF1E2208

7809M-9, 7809M-8, 7809M-6, 7809M-7, 7809M-17, 7809M-14, 7809M-12, 7809M-10



7809M-5-180, 7809M-6-140, 7809M-8-120, 7809M-10-140



Fit&Go 1/3 Foam Inlay 1/2" Bit Driver Set - 20 Pcs



FF1E2209



35 x 181 x 445 mm

1 FF1E2209

7809M-5, 7809M-8, 7809M-7, 7809M-6, 7809M-17, 7809M-14, 7809M-12, 7809M-10



7809TORX-T27, 7809TORX-T25, 7809TORX-T60, 7809TORX-T40, 7809TORX-T30, 7809TORX-T55, 7809TORX-T50, 7809TORX-T45



7809XZN-10, 7809XZN-12, 7809XZN-6, 7809XZN-8



Fit&Go 1/3 Foam Inlay 1/2" Bit Driver Set/Impact Socket Set - 14 Pcs



FF1E2210



38 x 181 x 445 mm

1 FF1E2210

7809M-5, 7809M-8, 7809M-7, 7809M-6, 7809M-19, 7809M-17, 7809M-14, 7809M-12, 7809M-10



BE-7606, BE-7607



BWSS12P319, BWSS12P321, BWSS12P317



Fit&Go 1/3 Foam Inlay 1/2" Socket Set - 21 Pcs



FF1E2211



50 x 181 x 445 mm

1 FF1E2211

7993S0050, 7993S0060, 7993S0080,
7993S0100, 7993S0120, 7993S0140,
7993S0170, 7993S0190



7994S0300, 7994S0400, 7994S0450,
7994S0500, 7994S0550, 7994S0600



K7801TORX-E10, K7801TORX-E12,
K7801TORX-E14, K7801TORX-E16,
K7801TORX-E18, K7801TORX-E20,
K7801TORX-E24



Fit&Go 1/3 Foam Inlay 1/2" Socket Set - 12 Pcs



FF1E2212



40 x 181 x 445 mm

1 FF1E2212

K7801M-17, K7801M-18, K7801M-19,
K7801M-21, K7801M-22, K7801M-24,
K7801M-10, K7801M-12, K7801M-13,
K7801M-14, K7801M-15, K7801M-16



Fit&Go 1/3 Foam Inlay 1/2" Power Deep Socket Set - 15 Pcs



FF1E2213



45 x 181 x 445 mm

1 FF1E2213

K7806M-13, K7806M-14, K7806M-16,
K7806M-17, K7806M-18, K7806M-19,
K7806M-21, K7806M-22, K7806M-24,
K7806M-27, K7806M-30, K7806M-32,
K7806M-10, K7806M-15, K7806M-12



Fit&Go 1/3 Foam Inlay 1/2" Socket Set - 13 Pcs



FF1E2501



35 x 181 x 445 mm

1 FF1E2501

A7402DM-14, A7402DM-13,
A7402DM-12, A7402DM-11,
A7402DM-10



7805SM-16, 7805SM-15, 7805SM-14,
7805SM-13, 7805SM-19, 7805SM-18,
7805SM-17, 7805SM-12



Fit&Go 1/3 Foam Inlay 1/2" to 3/4" Power Socket Set - 7 Pcs



FF1E2502



45 x 181 x 445 mm

1 FF1E2502

K560F-4, K560F-5



K8167S



K8160D-1, K8160D-2



K7764D



K8964D



Fit&Go 1/3 Foam Inlay Socket/Extractor Set - 35 Pcs



FF1E5005



36 x 181 x 445 mm

1 FF1E5005

BWTSP16



1418S



Fit&Go 1/3 Foam Inlay Socket/Torsion Bar Set - 6 Pcs



FF1E5006



42 x 181 x 445 mm

1 FF1E5006

D/S14



BWSS12P3



BWTB12P120, BWTB12P110



Fit&Go 1/3 Foam Inlay Mix Oil Plug Socket Set - 17 Pcs



FF1E5009



36 x 181 x 445 mm

1 FF1E5009

BE6217

Fit&Go 1/3 Foam Inlay Double Open End Wrench Set - 8 Pcs



FF1E3001

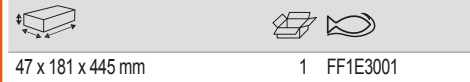

47 x 181 x 445 mm

1 FF1E3001

6M-6-7, 6M-8-9, 6M-10-11, 6M-12-13, 6M-14-15, 6M-16-17, 6M-18-19, 6M-21-23, 6M-22-24

Fit&Go 1/3 Foam Inlay Double Open End Wrench Set - 3 Pcs



FF1E3002



35 x 181 x 445 mm

1 FF1E3002

6M-25-28, 6M-27-29, 6M-30-32

Fit&Go 1/3 Foam Inlay Double Open End Wrench Set - 9 Pcs



FF1E3003

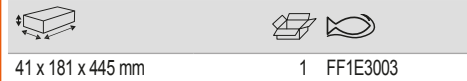

41 x 181 x 445 mm

1 FF1E3003

6Z-1/2-9/16, 6Z-15/16-1, 6Z-5/16-11/32, 6Z-5/8-3/4, 6Z-3/8-7/16, 6Z-25/32-13/16, 6Z-19/32-11/16, 6Z-1/4-5/16, 6Z-3/4-7/8

Fit&Go 1/3 Foam Inlay Combination Ratcheting Wrench Set - 10 Pcs



FF1E3004

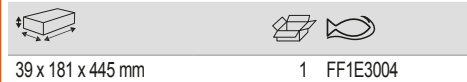

39 x 181 x 445 mm

1 FF1E3004

1RM-10, 1RM-9, 1RM-8, 1RM-14, 1RM-13, 1RM-12, 1RM-11, 1RM-17, 1RM-16, 1RM-15

Fit&Go 1/3 Foam Inlay Combination Ratcheting Wrench Set - 40 Pcs



FF1E3005



42 x 181 x 445 mm

1 FF1E3005

59S/31-1

6966

41RM-14, 41RM-13, 41RM-12, 41RM-10, 41RM-8, 41RM-19, 41RM-17

8166

Fit&Go 1/3 Foam Inlay Ratcheting Wrench Set - 8 Pcs



FF1E3006

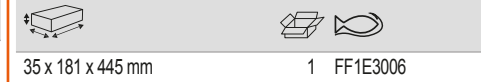

35 x 181 x 445 mm

1 FF1E3006

1320RM-6-7, 1320RM-8-9, 1320RM-10-11, 1320RM-12-13, 1320RM-14-15, 1320RM-16-17, 1320RM-18-19, 1320RM-22-24

Fit&Go 1/3 Foam Inlay Double Open Ring Offset Wrench Set - 7 Pcs



FF1E3007

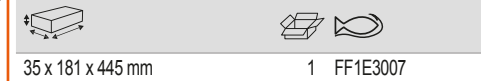

35 x 181 x 445 mm

1 FF1E3007

2M-6-7, 2M-8-9, 2M-10-11, 2M-12-13, 2M-14-15, 2M-16-17, 2M-18-19

Fit&Go 1/3 Foam Inlay Double Open End Pipe Wrench Set - 9 Pcs



FF1E3008



50 x 181 x 445 mm

1 FF1E3008

27M-8-9, 27M-10-11, 27M-12-13, 27M-14-15, 27M-16-17, 27M-18-19, 27M-20-22, 27M-21-23, 27M-24-27



Fit&Go 1/3 Foam Inlay Pliers Set - 4 Pcs



FF1E4001



35 x 181 x 445 mm 1 FF1E4001

- 2628 G-180IP
- 8231 IP
- 2430 G-200 IP
- 2101G-160IP

Fit&Go 1/3 Foam Inlay Circlip Pliers Set - 4 Pcs



FF1E4002



35 x 181 x 445 mm 1 FF1E4002

- 2900-180
- 2890-180
- 2990-180
- 2800-180

Fit&Go 1/3 Foam Inlay Wrench and Pliers Set - 3 Pcs



FF1E5007



38 x 181 x 445 mm 1 FF1E5007

- 1410
- 9033
- 8225

Fit&Go 1/3 Foam Inlay Measuring Tool Set - 7 Pcs



FF1E5001



45 x 181 x 445 mm 1 FF1E5001

- MTB-5-25
- 8045LVDE
- WR2-MM
- 1544
- 1178-SCRIBE
- 5515T
- 1150D

Fit&Go 1/3 Foam Inlay Hammer/Punch/Impact Driver Set - 35 Pcs



FF1E5004



36 x 181 x 445 mm 1 FF1E5004

- 481-400
- 3734S/6
- 7865

Fit&Go 1/3 Foam Inlay Hammer/Flat Chisel/Cotter Pin Punch Set - 11 Pcs



FF1E5002



35 x 181 x 445 mm 1 FF1E5002

- 3740-175, 3740-150, 3740-200
- 3734-5, 3734-4, 3734-3, 3734-2, 3734-8, 3734-6
- 481-100
- 1157

Fit&Go 1/3 Foam Inlay Hammer/Flat Chisel/Drift Punch Set - 11 Pcs



FF1E5003



35 x 181 x 445 mm 1 FF1E5003

- 481-300
- 3735-5-120
- 3739-300
- 3740-125, 3740-100, 3740-150, 3740-200
- 3733-5, 3733-4, 3733-3, 3733-2

Fit&Go 1/3 Foam Inlay Spark Plug Socket and Pliers Set - 4 Pcs



FF1E5008



37 x 181 x 445 mm 1 FF1E5008

- 7805ZZ-16, 7805ZZ-21
- BE1P
- BE61110

Fit&Go 1/3 Foam Inlay ERGO™ Blade Screwdriver Set - 6 pcs Retail Pack



FF1E1012EH



55 x 185 x 480 mm

1 FF1E1012EH

BE-8030		
BE-8150		
BE-8621, BE-8611		
BE-8811, BE-8821		

Fit&Go 1/3 Foam Inlay Torx® Screwdriver Set T8-T30 - 6 pcs Retail Pack



FF1E1009EH



55 x 185 x 480 mm

1 FF1E1009EH

BE-8908, BE-8910, BE-8915, BE-8920, BE-8925, BE-8930		
--	--	--

Fit&Go 1/3 Foam Inlay ERGO™ Through Blade Screwdriver Set - 6 pcs Retail Pack



FF1E1013EH



55 x 1852 x 480 mm

1 FF1E1013EH

BE-8135TB, BE-8145TB, BE-8150TB, BE-8155TB		
BE-8810TB, BE-8820TB		

Fit&Go 1/3 Foam Inlay 1/4" Socket Set & Bit Set - 46 pcs Retail Pack



FF1E2009EH



55 x 185 x 480 mm

1 FF1E2009EH

59/S31B-IP		
6700SM-4, 6700SM-4.5, 6700SM-5, 6700SM-5.5, 6700SM-6, 6700SM-7, 6700SM-8, 6700SM-9, 6700SM-10, 6700SM-11, 6700SM-12, 6700SM-13		
6962-W		
6972H		
6950SL		

Fit&Go 1/3 Foam Inlay 1/4" Deep Socket Set - 11 pcs Retail Pack



FF1E2010EH



55 x 185 x 480 mm

1 FF1E2010EH

S0810L		
1419-MD		

Fit&Go 1/3 Foam Inlay 3/8" Socket Set - 18 pcs Retail Pack



FF1E2106EH

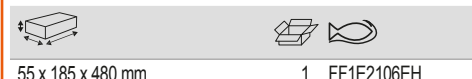

55 x 185 x 480 mm

1 FF1E2106EH

7400SM-10, 7400SM-11, 7400SM-12, 7400SM-13, 7400SM-14, 7400SM-15, 7400SM-16, 7400SM-17, 7400SM-18, 7400SM-19, 7400SM-20, 7400SM-22		
7760, 7761		
7766		
SBS750		
SBS71-16, SBS71-21		

Fit&Go 1/3 Foam Inlay 1/2" Socket Set - 21 pcs Retail Pack



FF1E2214EH



55 x 185 x 480 mm

1 FF1E2214EH

7800SM-10, 7800SM-11, 7800SM-12, 7800SM-13, 7800SM-14, 7800SM-15, 7800SM-16, 7800SM-17, 7800SM-18, 7800SM-19, 7800SM-20, 7800SM-21, 7800SM-22, 7800SM-23, 7800SM-24, 7800SM-27, 7800SM-30, 7800SM-32		
8150SL		
8174A		
8166		

Fit&Go 1/3 Foam Inlay 3/8" Deep Socket Set - 14 pcs Retail Pack



FF1E2107EH



55 x 185 x 480 mm

1 FF1E2107EH

SBA7402DM-11, SBA7402DM-10, SBA7402DM-13, SBA7402DM-12, SBA7402DM-7, SBA7402DM-9, SBA7402DM-8, SBA7402DM-19, SBA7402DM-18, SBA7402DM-15, SBA7402DM-14, SBA7402DM-17, SBA7402DM-16		
---	--	--



Fit&Go 1/3 Foam Inlay 1/2" Deep Socket Set - 12 pcs Retail Pack



FF1E2215EH

55 x 185 x 480 mm 1 FF1E2215EH

S1612L

Fit&Go 1/3 Foam Inlay Bit Set - 49 pcs Retail Pack



FF1E2503EH

55 x 185 x 480 mm 1 FF1E2503EH

BE5049

Fit&Go 1/3 Foam Inlay Combination Spanners Set - 11 pcs Retail Pack



FF1E3009EH

55 x 185 x 480 mm 1 FF1E3009EH

111M-8, 111M-10, 111M-11, 111M-12, 111M-13, 111M-14, 111M-15, 111M-16, 111M-17, 111M-18, 111M-19

Fit&Go 1/3 Foam Inlay 1RM Ratcheting Spanners Set - 5 pcs Retail Pack



FF1E3010EH

55 x 185 x 480 mm 1 FF1E3010EH

1RM-8, 1RM-10, 1RM-13, 1RM-17, 1RM-19

Fit&Go 1/3 Foam Inlay Magnetic Dish & Adjustable Spanners Set - 4 pcs Retail Pack



FF1E3011EH

55 x 185 x 480 mm 1 FF1E3011EH

8070 IP, 8071 IP, 8072 IP

1419-MD

Fit&Go 1/3 Foam Inlay Pliers Set - 3 pcs Retail Pack



FF1E4003EH

55 x 185 x 480 mm 1 FF1E4003EH

8224 IP

2101G-160IP

2430 G-160 IP

Fit&Go 1/3 Foam Inlay Rivet Gun & Metal Shears Set - 4 pcs Retail Pack



FF1E4004EH

55 x 185 x 480 mm 1 FF1E4004EH

2681

MA401

MA411

1178-SCRIBE

Fit&Go 1/3 Foam Inlay Hammer, Pin Punches & Impact Driver Set - 23 pcs Retail Pack



FF1E5010EH

55 x 185 x 480 mm 1 FF1E5010EH

481-400

3734-2, 3734-3, 3734-4, 3734-5, 3734-6, 3734-8

3735-5-120

7865

Fit&Go 1/3 Foam Inlay Circlip Pliers Set - 4 pcs Retail Pack



FF1E4005EH

55 x 185 x 480 mm 1 FF1E4005EH

2800-150, 2800-180

2900-150, 2900-180

Fit&Go 1/3 Foam Inlay Awls, Hooks & Knives - 11 pcs Retail Pack



FF1E5011EH

55 x 185 x 480 mm 1 FF1E5011EH

- 2633/S4, 2633L/S4
- 2489
- 2485
- KE18-01

Fit&Go 1/3 Foam Inlay L-Keys, Bit Set & Magnetic Dish - 36 pcs Retail Pack



FF1E5013EH

55 x 185 x 480 mm 1 FF1E5013EH

- BE-9770
- 2058/S26
- 1419-MD

Fit&Go 1/3 Foam Inlay 1/4" Socket Set - 25 pcs Retail Pack



FF1E2011EH

55 x 185 x 480 mm 1 FF1E2011EH

- SL25

Fit&Go 1/3 Foam Inlay 1/2" Ratchet & Accessories Set - 24 pcs Retail Pack



FF1E2216EH

55 x 185 x 480 mm 1 FF1E2216EH

- SBS81

Fit&Go 1/3 Foam Inlay 1/4" & 3/8" Socket Set - 33 pcs Retail Pack



FF1E2504EH

55 x 185 x 480 mm 1 FF1E2504EH

- S330

Fit&Go 1/3 Foam Inlay 1/4" & 3/8" Socket Set - 34 pcs Retail Pack



FF1E2505EH

55 x 185 x 480 mm 1 FF1E2505EH

- S330AF

Fit&Go 1/3 Foam Inlay Adjustable Spanner, Slip Joint Pliers & Metal Cutting Set - 8 pcs Retail Pack



FF1E5014EH

55 x 185 x 480 mm 1 FF1E5014EH

- 9031P
- 8224
- 208
- 3906-300-24-5P

1/3 Empty Foam with Cavities and Hanger



FF1E5016EH

35 x 181 x 445 mm 1 FF1E5016EH

Fit&Go 1/3 Foam Inlay ERGO™ Files Set - 4 pcs Retail Pack



FF1E5015EH

55 x 185 x 480 mm 1 FF1E5015EH

- 1-100-08-2-2
- 1-210-08-2-2
- 4-138-08-1-2
- 4-272-05-3-2



Fit&Go 2/3 Foam Inlay Slotted Screwdriver Set - 8 Pcs



ergo



FF1F1001

Fit go



40 x 362 x 445 mm



1 FF1F1001

BE-8210, BE-8030, BE-8040, BE-8240, BE-8242, BE-8252, BE-8250L



BE-8255, BE-8257



Fit&Go 2/3 Foam Inlay Phillips Screwdriver Set - 11 Pcs



ergo



FF1F1002

Fit go



40 x 362 x 445 mm



1 FF1F1002

BE-8020, BE-8040, BE-8242, BE-8252



BE-8330



BE-8256, BE-8258



BE-8610, BE-8620, BE-8623



BE-8602



Fit&Go 2/3 Foam Inlay Slotted/Phillips Screwdriver Set - 11 Pcs



ergo



FF1F1003

Fit go



38 x 362 x 445 mm



1 FF1F1003

BE-8030, BE-8242, BE-8252



BE-8155



BE-8870



BE-8600, BE-8610, BE-8620, BE-8623, BE-8624



808050TS



Fit&Go 2/3 Foam Inlay TORX® Screwdriver Set - 10 Pcs



ergo



FF1F1004

Fit go



38 x 362 x 445 mm



1 FF1F1004

BE-8904, BE-8907, BE-8908



BE-7910, BE-7915, BE-7920, BE-7925, BE-7927, BE-7930, BE-7940



Fit&Go 2/3 Foam Inlay TORX®/Bit Screwdriver Set - 12 Pcs



FF1F1005

Fit go



43 x 362 x 445 mm



1 FF1F1005

BE-8908, BE-8909, BE-8910, BE-8915, BE-8920, BE-8925, BE-8927, BE-8930



K6650-1/4-1P



808050S



808050



59S/31-3



Fit&Go 2/3 Foam Inlay Insulated Slotted/Phillips/Pozidriv Screwdriver Set - 8 Pcs



ergo



FF1F1006



40 x 362 x 445 mm



1 FF1F1006

BE-8230S, BE-8040S, BE-8050S, BE-8255S



BE-8810S, BE-8820S



BE-8610S, BE-8620S



Fit&Go 2/3 Foam Inlay TORX® T-Handle Screwdriver Set - 7 Pcs



FF1F1007

Fit go



35 x 362 x 445 mm



1 FF1F1007

901T-010-100, 901T-015-150, 901T-020-150, 901T-025-150, 901T-027-150, 901T-030-200, 901T-040-200



Fit&Go 2/3 Foam Inlay Screwdriver/Hex Key/Bit Set - 49 Pcs



FF1F1008



Fit & Go

38 x 362 x 445 mm

1 FF1F1008

B219.026		
B705.1/4.125		
B146.006.100		
B145.006.100		
BE-9770		
59S/31-1		

Fit&Go 2/3 Foam Inlay Slotted/Phillips/Pozidriv/TORX Screwdriver Set - 14 Pcs



FF1F1009



Fit & Go

38 x 362 x 445 mm

1 FF1F1009

B219.026		
B219.025		
B196.030.100		
B195.002.025		
B195.050.025		

Fit&Go 2/3 Foam Inlay 1/4" Socket and Pear Head Ratchet Set - 44 Pcs



FF1F2001



Fit & Go

37 x 362 x 445 mm

1 FF1F2001

A6800DM-11, A6800DM-10, A6800DM-9, A6800DM-8, A6800DM-13, A6800DM-12, A6800DM-4, A6800DM-7, A6800DM-6, A6800DM-5.5, A6800DM-5

6700SM-8, 6700SM-7, 6700SM-6, 6700SM-5.5, 6700SM-12, 6700SM-11, 6700SM-10, 6700SM-9, 6700SM-14, 6700SM-5, 6700SM-13

6709PH-2, 6709PH-1, 6709PH-3

6709PZ-2, 6709PZ-1

6709M-5, 6709M-4, 6709M-3, 6709M-8, 6709M-6

6709F-5.5, 6709F-4.5, 6709F-8

BE-9778

6950SL

7765

6954

6962

6966

6972H

6956

1998M-12

Fit&Go 2/3 Foam Inlay Socket/Bit Set with Magnetic Dish - 53 Pcs



FF1F2002



Fit & Go

45 x 362 x 445 mm

1 FF1F2002

SL25L

2058/S26

6956

1419-MD

Fit&Go 2/3 Foam Inlay 3/8" Socket and Pear Head Ratchet Set - 36 Pcs



FF1F2101



Fit & Go

37 x 362 x 445 mm

1 FF1F2101

7400SM-8, 7400SM-7, 7400SM-12, 7400SM-11, 7400SM-10, 7400SM-9, 7400SM-22, 7400SM-21, 7400SM-16, 7400SM-15, 7400SM-14, 7400SM-13, 7400SM-20, 7400SM-19, 7400SM-18, 7400SM-17

7409M-8, 7409M-4, 7409M-6, 7409M-10

A7402DM-13, A7402DM-12, A7402DM-11, A7402DM-10

A7410DZ-5/16, A7410DZ-7/16, A7410DZ-9/16, A7410DZ-3/8, A7410DZ-5/8

7750SL

7762

7754

7766

7764

8164-1/2

7756

Fit&Go 2/3 Foam Inlay 3/8" Standard/Deep Socket Set - 34 Pcs



FF1F2102



Fit & Go

40 x 362 x 445 mm

1 FF1F2102

S330L



Fit&Go 2/3 Foam Inlay 3/8" Socket Set - 38 Pcs



FF1F2103



35 x 362 x 445 mm

1 FF1F2103

S380



Fit&Go 2/3 Foam Inlay 1/2" Socket and Round Head Ratchet Set - 35 Pcs



FF1F2201



50 x 362 x 445 mm

1 FF1F2201

7800SM-13, 7800SM-12, 7800SM-19, 7800SM-18, 7800SM-10, 7800SM-17, 7800SM-22, 7800SM-21, 7800SM-20, 7800SM-27, 7800SM-24, 7800SM-32, 7800SM-30



7800DM-16, 7800DM-15, 7800DM-14, 7800DM-13, 7800DM-19, 7800DM-18, 7800DM-17, 7800DM-12, 7800DM-11, 7800DM-10



7809M-5, 7809M-6, 7809M-7, 7809M-8, 7809M-12, 7809M-10



8150SL



8160-5, 8160-10



8166



8154-11



8171



Fit&Go 2/3 Foam Inlay 1/2" Socket and Pear Head Ratchet Set - 24 Pcs



FF1F2202



50 x 362 x 445 mm

1 FF1F2202

S240



S81SL



Fit&Go 2/3 Foam Inlay Bit Set/Magnetic Dish Set - 50 Pcs



FF1F5004



35 x 362 x 445 mm

1 FF1F5004

BE5049

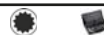

1419-MD



Fit&Go 2/3 Foam Inlay Turnbuckle Shock Absorber Set - 39 Pcs



FF1F5013



35 x 362 x 445 mm

1 FF1F5013

BS1000



Fit&Go 2/3 Foam Inlay 1/2" Deep Impact Socket Set - 27 Pcs



FF1F2203



50 x 362 x 445 mm

1 FF1F2203

K7801M-17, K7801M-18, K7801M-19, K7801M-21, K7801M-22, K7801M-24, K7801M-10, K7801M-12, K7801M-13, K7801M-14, K7801M-15, K7801M-16



K7806M-13, K7806M-14, K7806M-16, K7806M-17, K7806M-18, K7806M-19, K7806M-21, K7806M-22, K7806M-24, K7806M-27, K7806M-30, K7806M-32, K7806M-10, K7806M-15, K7806M-12



Fit&Go 2/3 Foam Inlay Double Open End Wrench Set - 11 Pcs



FF1F3001



40 x 362 x 445 mm

1 FF1F3001

6M-6-7, 6M-8-9, 6M-10-11, 6M-12-13, 6M-14-15, 6M-16-18, 6M-17-19, 6M-20-22, 6M-21-23, 6M-24-27, 6M-30-32



Fit&Go 2/3 Foam Inlay Combination Wrench Set - 18 Pcs



FF1F3002



41 x 362 x 445 mm

1 FF1F3002

111M-24, 111M-22, 111M-27, 111M-17,
111M-16, 111M-15, 111M-14, 111M-21,
111M-19, 111M-18, 111M-9, 111M-8,
111M-7, 111M-6, 111M-13, 111M-12,
111M-11, 111M-10



Fit&Go 2/3 Foam Inlay Combination
Wrench Set - 30 Pcs



FF1F3003



40 x 362 x 445 mm

1 FF1F3003

111M-6, 111M-7, 111M-8, 111M-9,
111M-17, 111M-16, 111M-15, 111M-14,
111M-19, 111M-18, 111M-13, 111M-12,
111M-11, 111M-10, 111M-21, 111M-20,
111M-22



1320SRM-14-19



1RMA-19-1/4-SQ



1RMA-13-10-BIT



BE-9778



Fit&Go 2/3 Foam Inlay Imperial
Combination Wrench Set - 13 Pcs



FF1F3004



42 x 362 x 445 mm

1 FF1F3004

111Z-3/8, 111Z-11/16, 111Z-1, 111Z-1/2,
111Z-13/16, 111Z-5/16, 111Z-5/8,
111Z-15/16, 111Z-7/16, 111Z-3/4,
111Z-1/4, 111Z-9/16, 111Z-7/8



Fit&Go 2/3 Foam Inlay Combination
Ratchet Wrench Set - 15 Pcs



FF1F3005



39 x 362 x 445 mm

1 FF1F3005

1RM-8, 1RM-19, 1RM-10, 1RM-14,
1RM-13, 1RM-12, 1RM-18, 1RM-17,
1RM-16, 1RM-15, 1RM-22, 1RM-21



1RMA-13-10-BIT



Fit&Go 2/3 Foam Inlay Combination
Ratchet Wrench Set - 17 Pcs



FF1F3006



35 x 362 x 445 mm

1 FF1F3006

1RM-19, 1RM-24, 1RM-22, 1RM-21,
1RM-27, 1RM-30

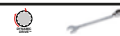

Fit&Go 2/3 Foam Inlay Double Open Ring
Offset Wrench Set - 10 Pcs



FF1F3007



47 x 362 x 445 mm

1 FF1F3007

2M-6-7, 2M-8-9, 2M-10-11, 2M-12-13,
2M-14-15, 2M-16-18, 2M-17-19,
2M-21-23, 2M-24-27, 2M-30-32



Fit&Go 2/3 Foam Inlay Double Socket
Head Wrench Set - 9 Pcs



FF1F3008



38 x 362 x 445 mm

1 FF1F3008

4040M-6-7, 4040M-8-9, 4040M-10-11,
4040M-12-13, 4040M-14-15,
4040M-16-17, 4040M-18-19,
4040M-20-22, 4040M-21-23



Fit&Go 2/3 Foam Inlay Flare Nut Wrench
Set - 8 Pcs



FF1F3009



35 x 362 x 445 mm

1 FF1F3009

1949M-8-9, 1949M-10-11,
1949M-12-13, 1949M-14-15,
1949M-17-19, 1949M-19-22,
1949M-24-27, 1949M-30-32



Fit&Go 2/3 Foam Inlay Combination Wrench Set - 17 Pcs



FF1F3010



35 x 362 x 445 mm

1 FF1F3010

1RM/S5

111M/SH12

Fit&Go 2/3 Foam Inlay Metric Combination Wrench and Ratcheting Ring Wrench Set - 13 Pcs



FF1F3011



35 x 362 x 445 mm

1 FF1F3011

S4RM/3T

111M/SH12

Fit&Go 2/3 Foam Inlay Wrench and Pliers Set - 8 Pcs



FF1F4001



35 x 362 x 445 mm

1 FF1F4001

- 2430 G-160 IP
- 2421 G-180 IP
- 2101G-160IP
- 2628 G-200
- 8224 IP
- 9029
- 2951-140, 2951-300

Fit&Go 2/3 Foam Inlay Scissors and Pliers Set - 8 Pcs



FF1F4002



35 x 362 x 445 mm

1 FF1F4002

2928-160

2951-250

SC127

2101G-160IP

2430 G-160 IP

2339 DIP

2628 G-180IP

8224 IP

Fit&Go 2/3 Foam Inlay Pliers Set - 4 Pcs



FF1F4003



35 x 362 x 445 mm

1 FF1F4003

2101G-160IP

8224 IP

2951-180

2430 G-200 IP

Fit&Go 2/3 Foam Inlay Circlip Pliers Set - 8 Pcs



FF1F4004



35 x 362 x 445 mm

1 FF1F4004

2800-140, 2800-180

2890-140, 2890-180

2900-140, 2900-180

2990-140, 2990-180

Fit&Go 2/3 Foam Inlay Insulated Cutter/Pliers Set - 5 Pcs



FF1F4005



38 x 362 x 445 mm

1 FF1F4005

2101S-160

2430 S-200

2427 S-200

8224 IP

2628 S-180

Fit&Go 2/3 Foam Inlay File/Measuring Tape/Pliers Set - 10 Pcs



FF1F5001

40 x 362 x 445 mm	1 FF1F5001

1-100-08-1-2	
1-160-08-1-2	
1-170-08-1-2	
1-210-08-1-2	
1-230-08-1-2	
2430 G-200 IP	
2628G-200IP	
7224	
2101G-160IP	
MTB-3-16	

Fit&Go 2/3 Foam Inlay Tin Snip/Rivet Gun/Measuring Tape Set - 5 Pcs



FF1F5002

38 x 362 x 445 mm	1 FF1F5002

2681	
MA401	
MA411	
1178-SCRIBE	
MTG-5-19	

Fit&Go 2/3 Foam Inlay Pliers/Adjustable Wrench Set - 5 Pcs



FF1F5003

35 x 362 x 445 mm	1 FF1F5003

8224	
2101G-160	
2430 G-160	
8071	
2951-250	

Fit&Go 2/3 Foam Inlay Cutting Tool Set - 8 Pcs



FF1F5005

40 x 362 x 445 mm	1 FF1F5005

317	
3906-300-24-5P	
268	
2446	

Fit&Go 2/3 Foam Inlay End Terminal Pliers/Multimeter Set - 4 Pcs



FF1F5006

50 x 362 x 445 mm	1 FF1F5006

CR W 01	
CR B 05	
3418 A	
BMMTRMS1	

Fit&Go 2/3 Foam Inlay Puller Set - 5 Pcs



FF1F5007

45 x 362 x 445 mm	1 FF1F5007

4543-1, 4543-2, 4543-3	
4545-2	
4541-A	

Fit&Go 2/3 Foam Inlay Knife/Awl/Hook Set - 11 Pcs



FF1F5008

37 x 362 x 445 mm	1 FF1F5008

2633/S4, 2633L/S4	
2489	
2485	
KE18-01	



Fit&Go 2/3 Foam Inlay Puller/Joint Fork Set - 5 Pcs



FF1F5009



60 x 362 x 445 mm

1 FF1F5009



BS618, BS623



4545-2



4545-N11



4532-0



Fit&Go 2/3 Foam Inlay Mix Brush/Ring Wrench Set - 9 Pcs



FF1F5010



45 x 362 x 445 mm

1 FF1F5010



BBR6135



BBR6131



BBR110



1949M-8-9, 1949M-10-11



7809M-6, 7809M-8, 7809M-10



783



Fit&Go 2/3 Foam Inlay 1/2" Impact Wrench Set - 7 Pcs



FF1F5011



100 x 362 x 445 mm

1 FF1F5011



BP815



BP821



BP822



BP823



Fit&Go 2/3 Foam Inlay 1/2" Mini Impact Wrench Set - 9 Pcs



FF1F5012



55 x 362 x 445 mm

1 FF1F5012



BWSS12P317, BWSS12P319, BWSS12P321



BPC814



BWTB12P120



GL008-10



783



8157-15



Fit&Go 3/3 Foam Inlay Screwdriver and Measuring Toolset - 66 Pcs



FF1A10



45 x 445 x 543 mm

1 FF1A10



BE-8020L, BE-8030



BE-8155



BE-8260



BE-8350



BE-8601, BE-8602



BE-8610, BE-8620



BE-8630



BE-8910, BE-8915, BE-8920, BE-8925, BE-8927, BE-8930, BE-8940



BE-9770



MTB-3-16



1150-1/2H/P



1177-SCRIBE



2820EF2



5515T-52



808050S



2047-0.8-4



2047PR-1-2



59S/31-1



Fit&Go 3/3 Foam Inlay Slotted/Phillips Screwdriver Set - 14 Pcs



FF1A1001



45 x 445 x 543 mm

1 FF1A1001



2509



2535F1



BE-8040, BE-8210, BE-8230, BE-8252



BE-8255



BE-8350



BE-8628, BE-8629, BE-8630



BE-8602



BE-8610L, BE-8620L



Fit&Go 3/3 Foam Inlay L-Key/Slotted/
Phillips/Pozidriv Screwdriver Set - 27 Pcs



FF1A1002

40 x 445 x 543 mm 1 FF1A1002

BE-8210, BE-8030, BE-8040, BE-8242, BE-8252	⊖	
BE-8350	⊖	
BE-8257, BE-8258	⊖	
BE-8880	⊖	
BE-8602	⊕	
BE-8610, BE-8620	⊕	
BE-8630, BE-8640	⊕	
BE-8800, BE-8810, BE-8820	⊕	
BE-8802	⊕	
BE-9578	⊙	

Fit&Go 3/3 Foam Inlay L-Key/Slotted/
Phillips/Pozidriv/TORX Screwdriver Set -
34 Pcs



FF1A1003

40 x 445 x 543 mm 1 FF1A1003

BE-8158, BE-8159, BE-8870, BE-8880	⊖	
BE-8350	⊖	
BE-8610	⊕	
BE-8602	⊕	
BE-8630	⊕	
BE-8908, BE-8909, BE-8910, BE-8915, BE-8920, BE-8925, BE-8927, BE-8930, BE-8940	⊕	
BE-9575	⊙	
BE-9578	⊙	

Fit&Go 3/3 Foam Inlay Screwdriver/L-Key/
Bit Set - 66 Pcs



FF1A1005

43 x 445 x 543 mm 1 FF1A1005

59S/31-1	⊖	
BE-8020, BE-8240	⊖	
BE-8250, BE-8255	⊖	
BE-8865	⊖	
BE-8602	⊕	
BE-8611, BE-8621	⊕	
BE-9585	⊙	
BE-8630	⊕	
BE-8800, BE-8811, BE-8821	⊕	
BE-8802	⊕	
BE-8830	⊕	
BE-8910, BE-8915, BE-8920, BE-8925	⊕	
BE-9678	⊙	

Fit&Go 3/3 Foam Inlay L-Key/Screwdriver
Set - 29 Pcs



FF1A1006

40 x 445 x 543 mm 1 FF1A1006

BE-8030, BE-8040	⊖	
BE-8155	⊖	
BE-8350	⊖	
BE-8602	⊕	
BE-8611, BE-8621	⊕	
BE-8630	⊕	
BE-8906, BE-8907, BE-8908, BE-8909, BE-8910, BE-8915, BE-8920, BE-8925, BE-8930, BE-8940	⊕	
BE-9688	⊙	
BE-7606, BE-7607	⊙	

Fit&Go 3/3 Foam Inlay Screwdriver/L-Key/
Bit Set - 63 Pcs



FF1A1007

44 x 445 x 543 mm 1 FF1A1007

5468-112	⊖	
5471 F-145	⊖	
BE-8040, BE-8220	⊖	
BE-8158, BE-8159, BE-8865	⊖	
BE-8340	⊖	
BE-8601	⊕	
BE-8628, BE-8629	⊕	
BE-8906, BE-8907, BE-8908, BE-8909, BE-8910, BE-8915, BE-8920, BE-8925, BE-8930	⊕	
BE-9770	⊙	
TL 124-SA	⊙	
5515FL	⊙	

Fit&Go 3/3 Foam Inlay Screwdriver/L-Key/
Bit Set - 60 Pcs



FF1A1008

49 x 445 x 543 mm 1 FF1A1008

BE-8020L, BE-8040	⊖	
59S/31-1	⊖	
808050	⊙	
BE-8150, BE-8255, BE-8256	⊖	
BE-8340	⊖	
BE-8601	⊕	
BE-8610, BE-8620	⊕	
BE-8925, BE-8927, BE-8930, BE-8940, BE-8945	⊕	
BE-9678	⊙	



Fit&Go 3/3 Foam Inlay Screwdriver/Bit Set - 60 Pcs



FF1A17



50 x 445 x 543 mm

1 FF1A17

BE-8020L, BE-8220		
BE-8150, BE-8155		
BE-8260		
BE-8350		
BE-8601, BE-8602		
BE-8610, BE-8620		
BE-8630		
BE-9780		
2047-1-5.5		
2047PR-1-2		
2058-BR		
706-2		
808050		
59/S28-4		

Fit&Go 3/3 Foam Inlay Screwdriver/L-Keys/Bit Set - 51 Pcs



FF1A21



48 x 445 x 543 mm

1 FF1A21

BE-8257, BE-8255		
BE-8242, BE-8040, BE-8030		
59S/31-1		
BE-8611, BE-8620		
BE-8910, BE-8915, BE-8920, BE-8925, BE-8927, BE-8930, BE-8940		
BE-9575		
BE-8577		
BE-8355		
BE-8602		
BE-9678		
2446		
7800SM-15		

Fit&Go 3/3 Foam Inlay Screwdriver/L-Key/Bit Set - 50 Pcs



FF1A27



45 x 445 x 543 mm

1 FF1A27

BE-8257, BE-8255		
BE-8242, BE-8040, BE-8030		
BE-8611, BE-8620		
59S/31-1		
BE-8910, BE-8915, BE-8920, BE-8925, BE-8927, BE-8930, BE-8940		
BE-9575		
BE-8577		
BE-8355		
BE-9678		
BE-8602		

Fit&Go 3/3 Foam Inlay Screwdriver/Bit/Socket Set - 54 Pcs



FF1A40



45 x 445 x 543 mm

1 FF1A40

BE-8020, BE-8040		
BE-8150, BE-8155		
BE-8611, BE-8621		
BE-8811, BE-8821		
BE-8910, BE-8915, BE-8920, BE-8925, BE-8930		
904T-060-150		
BE-9770		
59S/31-1		

Fit&Go 3/3 Foam Inlay Measuring Tape/Screwdriver Set - 20 Pcs



FF1A49



50 x 445 x 543 mm

1 FF1A49

808050P		
808050S		
6972H		
038.055.100, 038.065.125, 038.080.150		
039.001.100, 039.002.125		
59S/31-1		
BE-8040		
BE-8150, BE-8155		
BE-8010S, BE-8230S		
9045-B-250		
1150D		
426TOR9		
1179-FLX		
1178-SCRIBE		
MTS-5-25		

Fit&Go 3/3 Foam Inlay Pliers/Screwdriver Set - 19 Pcs



FF1A5001



40 x 445 x 543 mm

1 FF1A5001

2430 G-200 IP	
2101G-160IP	
2628 G-180IP	
2951-180	
7224	
BE-8150, BE-8155, BE-8256	
BE-8355	
BE-8611, BE-8620	
BE-8602	
BE-8910, BE-8915, BE-8920, BE-8925, BE-8930, BE-8940	
BE-9770	

Fit&Go 3/3 Foam Inlay ERGO™
Screwdrivers Set - 22 pcs



FF1A166



40 x 445 x 543 mm

1 FF1A166

9715-14-250		
BE-3529		
BE-8010, BE-8030		
BE-8150TB, BE-8256TB		
BE-8602		
BE-8611, BE-8621		
BE-8703, BE-8704, BE-8705, BE-8706, BE-8708		
BE-8811, BE-8821		
BE-8910, BE-8915, BE-8920, BE-8925, BE-8930		
BE-8986		

Fit&Go 3/3 Foam Laser Marked Inlay ERGO™ Screwdrivers, Precision Screwdrivers & L-Keys - 37 pcs



FF1A201LM



40 x 445 x 543 mm

1 FF1A201LM

BE-8256TB		
BE-8620TB, BE-8623TB		
700-2-50		
701-00-50, 701-0-50, 701-1-75		
703-10-50, 703-15-75, 703-6-50, 703-7-50, 703-8-50, 703-9-50		
BE-8040SL		
BE-8040		
BE-8150, BE-8155, BE-8256		
BE-8355		
BE-8600, BE-8611, BE-8621, BE-8623		
BE-8602		
BE-8811, BE-8821		
BE-8802		
BE-8870		
BE-9787		

Fit&Go 3/3 Foam Inlay 1/4" + 1/2"
Screwdriver/Socket Set - 77 Pcs



FF1A01



45 x 445 x 543 mm

1 FF1A01

A6800DM-6, A6800DM-7, A6800DM-8, A6800DM-9, A6800DM-10, A6800DM-11, A6800DM-12, A6800DM-13, A6800DM-4, A6800DM-5		
6700SM-4.5, 6700SM-5, 6700SM-5.5, 6700SM-6, 6700SM-7, 6700SM-8, 6700SM-9, 6700SM-10, 6700SM-11, 6700SM-12, 6700SM-13, 6700SM-4		
59S/22-1		
6950SL		
6954		
6956		
6960, 6961		
6966		
6972H		
7800SM-18, 7800SM-19, 7800SM-10, 7800SM-11, 7800SM-12, 7800SM-13, 7800SM-14, 7800SM-15, 7800SM-16, 7800SM-17, 7800SM-22, 7800SM-27, 7800SM-24, 7800SM-30, 7800SM-32		
7805ZZ-21		
7807H		
B191.040.100, B191.055.150		
B192.001.100, B192.002.125		
8150SL		
8154-11		
8160-3, 8160-10		
8166		

Fit&Go 3/3 Foam Laser Marked Inlay 1/2"
& 1/4" Sockets Ratcheting Screwdriver & Bit Set - 104 pcs



FF1A051



50 x 445 x 543 mm

1 FF1A051

BE-9678		
SBS60-5, SBS60-4.5, SBS60-6, SBS60-5.5, SBS60-4, SBS60-12, SBS60-11, SBS60-14, SBS60-13, SBS60-8, SBS60-7, SBS60-10, SBS60-9		
SBS61		
SBS63-2, SBS63-6, SBS63-4		
SBS65		
SBS67		
SBS69		
7800SM-22, 7800SM-24, 7800SM-19, 7800SM-18, 7800SM-21, 7800SM-32, 7800SM-30, 7800SM-27, 7800SM-15, 7800SM-14, 7800SM-17, 7800SM-16, 7800SM-11, 7800SM-10, 7800SM-13, 7800SM-12		
SBS88		
59S/31-1		
6956		
6972H		
7809M-5, 7809M-19, 7809M-6, 7809M-12, 7809M-17, 7809M-14, 7809M-10, 7809M-7, 7809M-8		
7809TORX-T60, 7809TORX-T50, 7809TORX-T55, 7809TORX-T40, 7809TORX-T45, 7809TORX-T25, 7809TORX-T20, 7809TORX-T30, 7809TORX-T27		
808050		
8150SL		
8154-11		
8160-W		
8160-10		
8166		
6954		



Fit&Go 3/3 Foam Inlay 1/4" + 1/2" + 3/8" Socket and Pear Head Ratchet Set - 138 Pcs



FF1A08



60 x 445 x 543 mm 1 FF1A08

A6800DM-6, A6800DM-7, A6800DM-8, A6800DM-9, A6800DM-10, A6800DM-11, A6800DM-12, A6800DM-13, A6800DM-5.5		
A7402DM-19, A7402DM-10, A7402DM-11, A7402DM-12, A7402DM-13, A7402DM-14, A7402DM-15, A7402DM-16, A7402DM-17, A7402DM-18		
1544		
2058-BR		
6700SM-5.5, 6700SM-6, 6700SM-7, 6700SM-8, 6700SM-9, 6700SM-10, 6700SM-11, 6700SM-12, 6700SM-13		
6709M-3, 6709M-4, 6709M-5, 6709M-6, 6709M-8		
6709PH-1, 6709PH-2, 6709PH-3		
6709TORX-T20, 6709TORX-T25, 6709TORX-T27, 6709TORX-T30, 6709TORX-T40, 6709TORX-T8, 6709TORX-T9, 6709TORX-T10, 6709TORX-T15		
6950SL		
6954		
6956		
6958		
6960, 6961, 6962, 6962L		
6966		
6972H		
7400SM-6, 7400SM-7, 7400SM-8, 7400SM-9, 7400SM-10, 7400SM-11, 7400SM-12, 7400SM-13, 7400SM-14, 7400SM-15, 7400SM-16, 7400SM-17, 7400SM-18, 7400SM-19, 7400SM-22		
7407H		
7409M-8, 7409M-10, 7409M-3, 7409M-4, 7409M-5, 7409M-6, 7409M-7		
7409TORX-T25, 7409TORX-T27, 7409TORX-T30, 7409TORX-T40, 7409TORX-T45, 7409TORX-T50		
7750SL		
7754		
7758		
7760, 7761, 7762		
7764		
7765		
7766		

7800SM-18, 7800SM-19, 7800SM-21, 7800SM-22, 7800SM-24, 7800SM-27, 7800SM-30, 7800SM-32, 7800SM-10, 7800SM-11, 7800SM-12, 7800SM-13, 7800SM-14, 7800SM-15, 7800SM-16, 7800SM-17		
7807H		
7809M-12, 7809M-14, 7809M-17, 7809M-19, 7809M-5, 7809M-6, 7809M-7, 7809M-8, 7809M-10		
7809TORX-T50, 7809TORX-T55, 7809TORX-T60, 7809TORX-T20, 7809TORX-T25, 7809TORX-T27, 7809TORX-T30, 7809TORX-T40, 7809TORX-T45		
8150SL		
8164-1/2		
8154-11		
8160-5, 8160-10		
8171		
8166		
8172		

Fit&Go 3/3 Foam Inlay Socket Set - 93 Pcs



FF1A106



55 x 543 x 445 mm 1 FF1A106

S87+7

Fit&Go 3/3 Foam Inlay 1/4" + 3/8" Socket and Pear Head Ratchet Set - 83 Pcs



FF1A13



55 x 445 x 543 mm 1 FF1A13

A6700DZ-1/2, A6700DZ-1/4, A6700DZ-11/32, A6700DZ-3/16, A6700DZ-3/8, A6700DZ-5/16, A6700DZ-7/16, A6700DZ-7/32, A6700DZ-9/16, A6700DZ-9/32		
--	--	--

A6710DZ-1/2, A6710DZ-1/4, A6710DZ-11/32, A6710DZ-3/16, A6710DZ-3/8, A6710DZ-5/16, A6710DZ-7/16, A6710DZ-7/32, A6710DZ-9/16, A6710DZ-9/32		
A6800DM-10, A6800DM-4		
A6800DZ-1/2, A6800DZ-1/4, A6800DZ-11/32, A6800DZ-3/16, A6800DZ-3/8, A6800DZ-5/16, A6800DZ-7/16, A6800DZ-7/32, A6800DZ-9/16, A6800DZ-9/32		
A7400DZ-1/2, A7400DZ-1/4, A7400DZ-11/16, A7400DZ-13/16, A7400DZ-17/32, A7400DZ-19/32, A7400DZ-3/4, A7400DZ-3/8, A7400DZ-5/8, A7400DZ-5/16, A7400DZ-7/8, A7400DZ-9/16		
A7402DZ-1/2, A7402DZ-1/4, A7402DZ-11/16, A7402DZ-13/16, A7402DZ-19/32, A7402DZ-3/4, A7402DZ-3/8, A7402DZ-5/16, A7402DZ-5/8, A7402DZ-7/16, A7402DZ-7/8, A7402DZ-9/16		
6700SZ-5/32		
6950SL		
6954		
6956		
6958		
6960, 6961, 6962, 6962L		
6966		
6972H		
7407H, 7408H		
7750SL		
7752		
7754		
7758		
7760, 7761, 7762		
7764		
7765		
7766		
8164-1/2		
8171		

Fit&Go 3/3 Foam Inlay Socket/Bit Set - 53 Pcs



FF1A130



45 x 445 x 543 mm 1 FF1A130

7800SM-18, 7800SM-19, 7800SM-21, 7800SM-22, 7800SM-23, 7800SM-24, 7800SM-27, 7800SM-30, 7800SM-32, 7800SM-8, 7800SM-9, 7800SM-10, 7800SM-11, 7800SM-12, 7800SM-13, 7800SM-14, 7800SM-15, 7800SM-16, 7800SM-17		
---	--	--

8150SL	
SBS87S, SBS87	
SBS83-3, SBS83-5, SBS83-10	
SBS85	
SBS86	
SBS88	
SBS89	
7809TORX-T50, 7809TORX-T55, 7809TORX-T60, 7809TORX-T20, 7809TORX-T25, 7809TORX-T27, 7809TORX-T30, 7809TORX-T40, 7809TORX-T45	
7809M-14, 7809M-17, 7809M-19, 7809M-5, 7809M-6, 7809M-7, 7809M-8, 7809M-9, 7809M-10, 7809M-12	
7809M-5-180, 7809M-6-140, 7809M-7-100, 7809M-8-120, 7809M-10-140	

Fit&Go 3/3 Foam Inlay Socket and Round Head Ratchet Set - 59 Pcs



FF1A137

50 x 445 x 543 mm	1 FF1A137

7800SM-18, 7800SM-19, 7800SM-21, 7800SM-22, 7800SM-23, 7800SM-24, 7800SM-27, 7800SM-30, 7800SM-32, 7800SM-8, 7800SM-9, 7800SM-10, 7800SM-11, 7800SM-12, 7800SM-13, 7800SM-14, 7800SM-15, 7800SM-16, 7800SM-17	
8150SL	
SBS87S, SBS87	
SBS83-3, SBS83-5, SBS83-10	
SBS85	
SBS86	
SBS88	
SBS89	
7809TORX-T50, 7809TORX-T55, 7809TORX-T60, 7809TORX-T20, 7809TORX-T25, 7809TORX-T27, 7809TORX-T30, 7809TORX-T40, 7809TORX-T45	
6700SM-4.5, 6700SM-5, 6700SM-5.5, 6700SM-6, 6700SM-7, 6700SM-8, 6700SM-9, 6700SM-10, 6700SM-11, 6700SM-12, 6700SM-13, 6700SM-14, 6700SM-4	
6950SL	
SBS67	
SBS69	
SBS65	
SBS63-2, SBS63-4, SBS63-6	
6954	

Fit&Go 3/3 Foam Inlay Measuring Tapes/ Socket/Bit Set - 71 Pcs



FF1A142

50 x 445 x 543 mm	1 FF1A142

7800SM-18, 7800SM-19, 7800SM-21, 7800SM-22, 7800SM-23, 7800SM-24, 7800SM-27, 7800SM-30, 7800SM-32, 7800SM-8, 7800SM-9, 7800SM-10, 7800SM-11, 7800SM-12, 7800SM-13, 7800SM-14, 7800SM-15, 7800SM-16, 7800SM-17	
8150SL	
BE-9678	
SBS87S, SBS87	
1547	
1150D	
59S/31-1	
8160-10, 8160-3, 8160-5	
8166	
8154-11	
8171	
8172	

Fit&Go 3/3 Foam Inlay 1/2" Socket/Pliers Set - 34 Pcs



FF1A146

50 x 445 x 543 mm	1 FF1A146

2628 G-180	
2430 G-160	
8224	
2101G-160	
FS-8	

7800SM-18, 7800SM-19, 7800SM-21, 7800SM-22, 7800SM-23, 7800SM-24, 7800SM-27, 7800SM-30, 7800SM-32, 7800SM-8, 7800SM-9, 7800SM-10, 7800SM-11, 7800SM-12, 7800SM-13, 7800SM-14, 7800SM-15, 7800SM-16, 7800SM-17	
8150SL	
SBS87S, SBS87	
8160-10, 8160-3, 8160-5	
8166	
8154-11	
8171	
8172	

Fit&Go 3/3 Foam Inlay Puller/Round Head Ratchet/Socket Set - 58 Pcs



FF1A22

50 x 445 x 543 mm	1 FF1A22

7800SM-18, 7800SM-19, 7800SM-21, 7800SM-22, 7800SM-23, 7800SM-24, 7800SM-27, 7800SM-30, 7800SM-32, 7800SM-10, 7800SM-12, 7800SM-13, 7800SM-14, 7800SM-16, 7800SM-17	
7805SM-27, 7805SM-13, 7805SM-30, 7805SM-16, 7805SM-32, 7805SM-17, 7805SM-18, 7805SM-19, 7805SM-21, 7805SM-22, 7805SM-24	
7809M-12, 7809M-14, 7809M-8, 7809M-5, 7809M-10, 7809M-6	
8150SL	
6700SM-4.5, 6700SM-5, 6700SM-5.5, 6700SM-6, 6700SM-7, 6700SM-8, 6700SM-9, 6700SM-10, 6700SM-11, 6700SM-12, 6700SM-13, 6700SM-4	
6958	
6954	
6960, 6962	
6966	
6950SL	
4532-A	
8157-15	
8154-11	
8160-3, 8160-5	
8166	



Fit&Go 3/3 Foam Inlay 3/4" Socket Set - 26 Pcs



FF1A2301



70 x 445 x 543 mm 1 FF1A2301

8900DM-19, 8900DM-26, 8900DM-25, 8900DM-24, 8900DM-23, 8900DM-29, 8900DM-28, 8900DM-27, 8900DM-22, 8900DM-34, 8900DM-33, 8900DM-32, 8900DM-30, 8900DM-36, 8900DM-41, 8900DM-46, 8900DM-55, 8900DM-50, 8900DM-60

8954	
8954A	
8958A	
8961	
8965	
8966	
8955N/B	

Fit&Go 3/3 Foam Inlay Socket and Round Head Ratchet Set - 50 Pcs



FF1A25

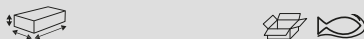

50 x 445 x 543 mm 1 FF1A25

7800SM-18, 7800SM-19, 7800SM-21, 7800SM-22, 7800SM-23, 7800SM-24, 7800SM-27, 7800SM-30, 7800SM-32, 7800SM-10, 7800SM-12, 7800SM-13, 7800SM-14, 7800SM-15, 7800SM-16, 7800SM-17

7805SM-27, 7805SM-13, 7805SM-30, 7805SM-32, 7805SM-16, 7805SM-17, 7805SM-18, 7805SM-19, 7805SM-21, 7805SM-22, 7805SM-24	
8150SL	

6700SM-4.5, 6700SM-5, 6700SM-5.5, 6700SM-6, 6700SM-7, 6700SM-8, 6700SM-9, 6700SM-10, 6700SM-11, 6700SM-12, 6700SM-13, 6700SM-4

6954	
6960, 6962	
6966	
6950SL	
2953-250	
8166	
8154-11	
8160-3, 8160-5	

Fit&Go 3/3 Foam Inlay 1/4" + 1/2" + 3/8" Socket and Pear/Round Head Ratchet Set - 83 Pcs



FF1A2501



50 x 445 x 543 mm 1 FF1A2501

6700SM-8, 6700SM-7, 6700SM-6, 6700SM-5.5, 6700SM-12, 6700SM-11, 6700SM-10, 6700SM-9, 6700SM-13, 6700SM-5, 6700SM-4

6700TORX-E10, 6700TORX-E8	
6709M-5, 6709M-4, 6709M-3, 6709M-8, 6709M-6	
6709TORX-T40, 6709TORX-T30, 6709TORX-T27, 6709TORX-T8, 6709TORX-T25, 6709TORX-T20, 6709TORX-T15, 6709TORX-T10	

6950SL	
6954	
6956	
6962	
6966	
7400SM-8, 7400SM-12, 7400SM-11, 7400SM-10, 7400SM-9, 7400SM-22, 7400SM-21, 7400SM-16, 7400SM-15, 7400SM-14, 7400SM-13, 7400SM-20, 7400SM-19, 7400SM-18, 7400SM-17	

7400TORX-E10, 7400TORX-E8, 7400TORX-E14, 7400TORX-E12	
7750SL	
7754	
7762	
7764	
7765	
7766	
7768	

7800SM-17, 7800SM-13, 7800SM-12, 7800SM-19, 7800SM-18, 7800SM-27, 7800SM-20, 7800SM-32, 7800SM-30, 7800SM-21, 7800SM-22, 7800SM-24

7809M-10, 7809M-12	
7809TORX-T40, 7809TORX-T55, 7809TORX-T25, 7809TORX-T50, 7809TORX-T20	
8150SL	
8164-1/2	
8154-11	
8160-10	
8171	
8166	
8172	

Fit&Go 3/3 Foam Inlay 1/2"-3/8" Socket Set - 101 Pcs



FF1A2503



55 x 445 x 543 mm 1 FF1A2503

6700SM-4.5, 6700SM-5, 6700SM-5.5, 6700SM-6, 6700SM-7, 6700SM-8, 6700SM-9, 6700SM-10, 6700SM-11, 6700SM-12, 6700SM-13, 6700SM-14, 6700SM-4

7800SM-18, 7800SM-19, 7800SM-21, 7800SM-22, 7800SM-23, 7800SM-24, 7800SM-26, 7800SM-27, 7800SM-28, 7800SM-30, 7800SM-32, 7800SM-10, 7800SM-11, 7800SM-12, 7800SM-13, 7800SM-14, 7800SM-15, 7800SM-16, 7800SM-17, 7800SM-8, 7800SM-9	
---	--

BE-9678	
7809M-10, 7809M-12, 7809M-14, 7809M-17, 7809M-19, 7809M-5, 7809M-7, 7809M-8, 7809M-9, 7809M-6	

59S/31-1	
7809M-10-140, 7809M-5-180, 7809M-6-140, 7809M-7-100, 7809M-8-120	

808050	
8155-1/2	

6950	
6954	
6956	
6960, 6962	
6966	
8154-11	
8160-5, 8160-10	
8166	

Fit&Go 3/3 Foam Inlay Socket and Wrench Set - 46 Pcs



FF1A37

35 x 445 x 543 mm 1 FF1A37

111M-6, 111M-7, 111M-8, 111M-9, 111M-10, 111M-11, 111M-12, 111M-13, 111M-14, 111M-15, 111M-16, 111M-17, 111M-18, 111M-19, 111M-21, 111M-22, 111M-24		
8071 IP		
2101G-160		
2430 G-160		
8224		
8150SL		

Fit&Go 3/3 Foam Inlay Socket and Wrench Set - 54 Pcs



FF1A39

45 x 445 x 543 mm 1 FF1A39

S410		
S1612L		
8071 IP		

Fit&Go 3/3 Foam Inlay 1/4" + 3/8" Socket and Combination Wrench Set - 91 Pcs



FF1A5003

45 x 445 x 543 mm 1 FF1A5003

111M-13, 111M-12, 111M-10, 111M-8, 111M-19, 111M-17, 111M-15		
6700SM-5.5, 6700SM-5, 6700SM-14, 6700SM-13, 6700SM-12, 6700SM-11, 6700SM-10, 6700SM-9, 6700SM-8, 6700SM-7, 6700SM-6		
6700TORX-E5, 6700TORX-E4, 6700TORX-E10, 6700TORX-E8, 6700TORX-E7, 6700TORX-E6		
6709TORX-T27, 6709TORX-T25, 6709TORX-T20, 6709TORX-T15, 6709TORX-T10, 6709TORX-T9, 6709TORX-T8, 6709TORX-T40, 6709TORX-T30		
6950		
6961, 6962		
6966		
7400SM-13, 7400SM-12, 7400SM-11, 7400SM-10, 7400SM-9, 7400SM-8, 7400SM-21, 7400SM-19, 7400SM-18, 7400SM-17, 7400SM-16, 7400SM-15, 7400SM-14, 7400SM-22		
7400TORX-E18, 7400TORX-E16, 7400TORX-E14, 7400TORX-E12, 7400TORX-E11, 7400TORX-E10, 7400TORX-E8		
7409TORX-T30, 7409TORX-T27, 7409TORX-T25, 7409TORX-T50, 7409TORX-T45, 7409TORX-T40		
7750		
7760, 7761, 7762		
7764		
7765		
7766		
A6800DM-8, A6800DM-7, A6800DM-6, A6800DM-14, A6800DM-13, A6800DM-12, A6800DM-11, A6800DM-10, A6800DM-9		
A7402DM-19, A7402DM-18, A7402DM-17, A7402DM-16, A7402DM-15, A7402DM-14, A7402DM-13, A7402DM-12, A7402DM-11, A7402DM-10		
8157-15		

Fit&Go 3/3 Foam Inlay Wrench/Socket Set - 38 Pcs



FF1A5004

55 x 445 x 543 mm 1 FF1A5004

1RM-19, 1RM-13, 1RM-12, 1RM-11, 1RM-10, 1RM-9, 1RM-8, 1RM-27, 1RM-7, 1RM-24, 1RM-6, 1RM-22, 1RM-17		
6700SM-13, 6700SM-12, 6700SM-11, 6700SM-10, 6700SM-9, 6700SM-8, 6700SM-7, 6700SM-6		
6950		

6960		
6966		
7800SM-19, 7800SM-17, 7800SM-32, 7800SM-30, 7800SM-13, 7800SM-27, 7800SM-24, 7800SM-22		
8155-1/2		
SBS86		
6954		
8160-5		
8166		

Fit&Go 3/3 Foam Inlay Standard Combination Wrench/Socket Set - 83 Pcs



FF1A5005

50 x 445 x 543 mm 1 FF1A5005

111M-17, 111M-15, 111M-13, 111M-19, 111M-8		
6700SM-8, 6700SM-7, 6700SM-6, 6700SM-12, 6700SM-11, 6700SM-10, 6700SM-9, 6700SM-14, 6700SM-13, 6700SM-5, 6700SM-4		
6709M-5, 6709M-4, 6709M-8, 6709M-6, 6709M-3		
6950SL		
6962		
6968		
7400SM-8, 7400SM-7, 7400SM-6, 7400SM-12, 7400SM-11, 7400SM-10, 7400SM-9, 7400SM-16, 7400SM-15, 7400SM-14, 7400SM-13, 7400SM-18, 7400SM-17		
7750SL		
7760-W		
7761		
7768		
7800SM-11, 7800SM-10, 7800SM-15, 7800SM-14, 7800SM-13, 7800SM-12, 7800SM-19, 7800SM-18, 7800SM-17, 7800SM-16, 7800SM-22, 7800SM-21, 7800SM-27, 7800SM-24, 7800SM-32, 7800SM-30, 7800SM-8, 7800SM-9		
7809M-17, 7809M-14, 7809M-12, 7809M-10, 7809M-5, 7809M-6, 7809M-7, 7809M-8		
7809TORX-T40, 7809TORX-T30, 7809TORX-T25, 7809TORX-T20, 7809TORX-T45		
8150SL		
A6709M-6, A6709M-5, A6709M-4, A6709M-3, A6709M-2.5		
K6650-1/4-1P		
6960W-2, 6960W-6		
8160-5, 8160-10		
8166		



Fit&Go 3/3 Foam Inlay Socket/
Combination Wrench Set - 41 Pcs



FF1A5013



50 x 445 x 543 mm

1 FF1A5013

111M-6, 111M-7, 111M-8, 111M-9,
111M-12, 111M-13, 111M-17, 111M-10,
111M-11, 111M-19, 111M-20, 111M-22,
111M-24, 111M-27, 111M-32, 111M-30

6700SM-6, 6700SM-7, 6700SM-8,
6700SM-9, 6700SM-10, 6700SM-11,
6700SM-12, 6700SM-13, 6700SM-14

6950

6960

6966

7800SM-19, 7800SM-17, 7800SM-13,
7800SM-22, 7800SM-27, 7800SM-24,
7800SM-30, 7800SM-32

8155-1/2

SBS86

6954

8160-5

8166

Fit&Go 3/3 Foam Inlay Socket and Wrench
Set - 75 Pcs



FF1A5032



55 x 445 x 543 mm

1 FF1A5032

6700SM-10, 6700SM-11, 6700SM-8,
6700SM-9, 6700SM-14, 6700SM-12,
6700SM-13, 6700SM-4, 6700SM-6,
6700SM-7, 6700SM-5, 6700SM-4.5,
6700SM-5.5

6950

6954

6956

6960, 6962

6966

7400SM-6, 7400SM-7, 7400SM-10,
7400SM-11, 7400SM-8, 7400SM-9,
7400SM-14, 7400SM-15, 7400SM-12,
7400SM-13, 7400SM-18, 7400SM-19,
7400SM-16, 7400SM-17, 7400SM-22,
7400SM-20, 7400SM-21

7754

7755-3/8

7760, 7761, 7762

7766

7800DM-11, 7800DM-14, 7800DM-15,
7800DM-12, 7800DM-13, 7800DM-18,
7800DM-19, 7800DM-16, 7800DM-17,
7800DM-22, 7800DM-23, 7800DM-20,
7800DM-21, 7800DM-26, 7800DM-27,
7800DM-24, 7800DM-30, 7800DM-32,
7800DM-28, 7800DM-8, 7800DM-9,
7800DM-10, 7800DM-25, 7800DM-29

8155-1/2

111M-19, 111M-17, 111M-18, 111M-15,
111M-16, 111M-14, 111M-20

8154-11

8160-5, 8160-10

8166

Fit&Go 3/3 Foam Inlay Wrench/Bit Set - 75
Pcs



FF1A55



40 x 445 x 543 mm

1 FF1A55

A6700DZ-1/2, A6700DZ-1/4,
A6700DZ-11/32, A6700DZ-3/16,
A6700DZ-3/8, A6700DZ-5/16,
A6700DZ-7/16, A6700DZ-7/32,
A6700DZ-9/16, A6700DZ-9/32

BE-9775

SBS61

SBS63-2, SBS63-6, SBS63-4

SBS65

SBS67

SBS81

6956

6972H

7800DZ-1, 7800DZ-1/2, 7800DZ-11/16,
7800DZ-13/16, 7800DZ-15/16,
7800DZ-19/32, 7800DZ-3/4,
7800DZ-3/8, 7800DZ-5/8, 7800DZ-7/8,
7800DZ-9/16, 7800DZ-7/16

808050

6954

8160-10, 8160-5

8166

8154-11

Fit&Go 3/3 Foam Inlay Automotive Bit Set
and Clamping Tip Set - 105 Pcs



FF1A70



42 x 445 x 543 mm

1 FF1A70

BE5049

S560

Fit&Go 3/3 Foam Inlay 1/4" + 3/8" Long
Socket Set - 75 Pcs



FF1A54



35 x 445 x 543 mm

1 FF1A54

S1612L

S0810L

S330L

Fit&Go 3/3 Foam Inlay 1/4" & 1/2" Socket
Set and Wrenches - 94 Pcs



FF1A153



335 x 445 x 543 mm

1 FF1A153

S87+7

Fit&Go 3/3 Foam Inlay 1/2" & 3/8" Socket Set & Bit Set - 177 pcs



FF1A165

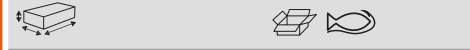

40 x 445 x 543 mm 1 FF1A165

- BE5049
- S1214L
- S1612L
- SBS71-16
- SBS87

Fit&Go 3/3 Foam Laser Marked Inlay 1/2" & 1/4" Socket Set & Bit Set - 139 pcs



FF1A195LM



40 x 445 x 543 mm 1 FF1A195LM

- A6800DZ-9/16, A6800DZ-1/2, A6800DZ-1/4, A6800DZ-11/32, A6800DZ-3/16, A6800DZ-3/8, A6800DZ-5/16, A6800DZ-7/16, A6800DZ-7/32, A6800DZ-9/32
- K6625-1/4-1P
- K6650-1/4-1P, K6650-3/8-1P
- 6954
- 6963
- 7767
- 8167
- 2058-BR
- 59/S31B
- SL25L
- S330L

Fit&Go 3/3 Foam Inlay 1/2" & 1/4" Socket Set & Torque Wrench - 51 pcs



FF1A194

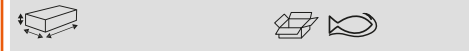

40 x 445 x 543 mm 1 FF1A194

- 6968
- 6700SM-14, 6700SM-13, 6700SM-12, 6700SM-11, 6700SM-10, 6700SM-9, 6700SM-8, 6700SM-7, 6700SM-6, 6700SM-5, 6700SM-4
- 6709M-3, 6709M-8, 6709M-6, 6709M-5, 6709M-4
- 6950SL
- 7800SM-24, 7800SM-23, 7800SM-22, 7800SM-13, 7800SM-12, 7800SM-11, 7800SM-10, 7800SM-9, 7800SM-8, 7800SM-21, 7800SM-19, 7800SM-18, 7800SM-17, 7800SM-16, 7800SM-15, 7800SM-14
- 7809M-8, 7809M-7, 7809M-10, 7809M-6, 7809M-5
- 7809TORX-T20, 7809TORX-T25, 7809TORX-T30, 7809TORX-T40
- 7455-200
- 8150SL
- 8168
- K6650-1/4-1P
- 6960W-2, 6960W-6
- 8160-10, 8160-5

Fit&Go 3/3 Foam Laser Marked Inlay 1/2" Socket Set & 1/2" Deep Socket Set - 67 pcs



FF1A196LM



40 x 445 x 543 mm 1 FF1A196LM

- 7800DZ-1.1/16, 7800DZ-1.1/4, 7800DZ-1.1/8, 7800DZ-1.3/16, 7800DZ-1/2, 7800DZ-11/16, 7800DZ-13/16, 7800DZ-15/16, 7800DZ-25/32, 7800DZ-3/4, 7800DZ-3/8, 7800DZ-5/8, 7800DZ-7/16, 7800DZ-7/8, 7800DZ-9/16, 7800DZ-19/32
- 7809M-10, 7809M-12, 7809M-14, 7809M-4, 7809M-5, 7809M-6, 7809M-7, 7809M-8

- 7809M-5-100, 7809M-6-100, 7809M-7-100, 7809M-8-120, 7809M-10-140
- K6650-1/2-1P
- S1612L
- 8967
- S240

Fit&Go 3/3 Foam Laser Marked Inlay 3/4" Socket Set - 17 pcs



FF1A206LM

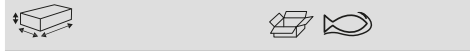

50 x 445 x 543 mm 1 FF1A206LM

- SLX 17

Fit&Go 3/3 Foam Laser Marked Inlay 1/4" & 3/8" Socket Set, T-Handle Screwdrivers, Caliper & Bit Set - 192 pcs



FF1A207LM

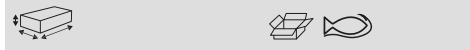

40 x 445 x 543 mm 1 FF1A207LM

- 1150-1/2H/P
- 59/S100BC
- 808050L
- 2058-BR
- K6650-1/4-1P, K6650-3/8-1P
- 6956
- 6963
- 8967/S3
- 6966
- 6954
- 696EX-08
- 904T-060-150
- 905T-060-100
- 6973A
- SL25L
- S330



Fit&Go 3/3 Foam Inlay 1/4" & 3/8" Socket Set & Torque Wrench - 85 pcs



FF1A213

52 x 445 x 543 mm 1 FF1A213

- 8150SL
- 7800SM-8, 7800SM-9, 7800SM-12, 7800SM-13, 7800SM-10, 7800SM-11, 7800SM-30, 7800SM-32, 7800SM-24, 7800SM-22, 7800SM-23, 7800SM-27, 7800SM-16, 7800SM-17, 7800SM-14, 7800SM-15, 7800SM-21, 7800SM-18, 7800SM-19
- 7455-200
- 7809TORX-T45, 7809TORX-T40, 7809TORX-T30, 7809TORX-T20, 7809TORX-T25
- 7809M-6, 7809M-5, 7809M-8, 7809M-7, 7809M-10, 7809M-14, 7809M-12
- 7809M-6-140, 7809M-5-180, 7809M-10-140, 7809M-8-120
- 6950SL
- 6962-W, 6960-W
- 6968
- 6700SM-9, 6700SM-10, 6700SM-7, 6700SM-8, 6700SM-13, 6700SM-14, 6700SM-11, 6700SM-12, 6700SM-4, 6700SM-6, 6700SM-5
- 6709M-6, 6709M-8, 6709M-4, 6709M-5, 6709M-3
- A6709M-2.5, A6709M-5, A6709M-6, A6709M-3, A6709M-4
- 6962L
- K6650-1/4-1P
- 7400SM-17, 7400SM-18, 7400SM-15, 7400SM-16, 7400SM-19, 7400SM-9, 7400SM-10, 7400SM-7, 7400SM-8, 7400SM-13, 7400SM-14, 7400SM-11, 7400SM-12, 7400SM-6
- 7760-W, 7761-W
- 7750SL
- 7768
- 8160-5, 8160-10
- 8166

Fit&Go 3/3 Foam Laser Marked Inlay 1/4" & 1/2" Socket Set, Pliers & Bit Set - 91 pcs



FF1A214LM

40 x 445 x 543 mm 1 FF1A214LM

- 2058-BR
- K6650-1/4-1P, K6650-1/2-1P
- 6956
- 6963
- SL25
- 8072
- 2971G-250
- 806-1-3
- 2171G-160
- 59/S31B
- S240

Fit&Go 3/3 Foam Laser Marked Inlay Window Click Torque Wrench, Spark Plug Sockets & 1/4" Socket Set - 79 pcs



FF1A218LM

45 x 445 x 543 mm 1 FF1A218LM

- 1178-SCRIBE
- 1547
- 74WR-200
- 7805ZZ-16, 7805ZZ-21
- BBR201P64014, BBR201P64016, BBR201P64018, BBR201P67814, BBR201P67816, BBR201P67818
- BWSS12P3
- MTC-3-13-C1
- 7800SM-34, 7800SM-36
- SL25L
- SR200-MM
- S240

Fit&Go 3/3 Foam Laser Marked Inlay 1/2" Deep Socket & Socket Hex Bits Set - 49 pcs



FF1A219LM

35 x 445 x 543 mm 1 FF1A219LM

- 1-100-08-2-2
- S1612L
- S18HEX
- S18TORX

Fit&Go 3/3 Foam Inlay T-Handle + L-Key Screwdriver Set - 19 Pcs



FF1A1004

38 x 445 x 543 mm 1 FF1A1004

- 900T-050-150, 900T-020-100, 900T-025-100, 900T-030-100, 900T-040-150, 900T-060-200, 900T-080-200, 900T-100-200
- BE-9777B

Fit&Go 3/3 T-Handle Screwdriver Set - 54 Pcs



FF1A1010

51 x 445 x 543 mm 1 FF1A1010

901T-010-100, 901T-015-150, 901T-020-150, 901T-025-150, 901T-027-150, 901T-030-200, 901T-040-200		
808050		
1419-MD		
7805DM-10, 7805DM-12, 7805DM-13, 7805DM-17, 7805DM-19		
BE-9678		
59S/31-1		

Fit&Go 3/3 Hex/TORX T-Handle Screwdriver Set - 12 Pcs

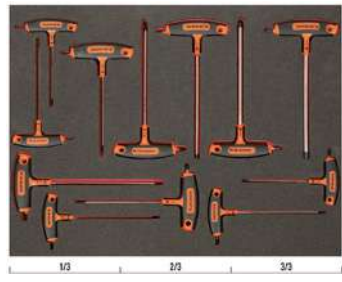

FF1A1011

35 x 445 x 543 mm 1 FF1A1011

903T-2		
903T-1		

Fit&Go 3/3 Foam Inlay Screwdriver Set - 17 Pcs



FF1A133

35 x 445 x 543 mm 1 FF1A133

900T-020-100, 900T-025-100, 900T-030-100, 900T-040-150, 900T-050-150, 900T-060-200, 900T-080-200, 900T-100-200		
B194.006.075, B194.007.075, B194.008.075, B194.009.075, B194.010.075, B194.015.100, B194.020.100, B194.025.125, B194.030.150		

Fit&Go 3/3 Foam Inlay Screwdriver Set - 18 Pcs



FF1A139

38 x 445 x 543 mm 1 FF1A139

808050		
900T-020-100, 900T-025-100, 900T-030-100, 900T-040-150, 900T-050-150, 900T-060-200, 900T-080-200, 900T-100-200		
B191.030.075, B191.040.100		
B190.055.100, B190.065.125, B190.080.150		
B195.050.025		
B195.001.025		
B192.001.100, B192.002.125		

Fit&Go 3/3 Foam Inlay Slotted/Phillips/T-Handle Screwdriver Set - 45 Pcs



FF1A71

41 x 445 x 543 mm 1 FF1A71

901T-010-100, 901T-015-150, 901T-020-150, 901T-027-150, 901T-030-200, 901T-040-200, 901T-025-150, 901T-045-200, 901T-050-200		
B190.055.125		
B191.030.075, B191.040.100		
B192.001.100, B192.002.125		
B705.1/4.125		
59/S31B		

Fit&Go 3/3 Foam Laser Marked Inlay ERGO™ Screwdrivers, T-Handle Screwdrivers & L-Keys - 39 pcs



FF1A202LM

40 x 445 x 543 mm 1 FF1A202LM

900T-025-100, 900T-030-100, 900T-040-150, 900T-050-150, 900T-060-200, 900T-080-200		
BE-8907, BE-8908, BE-8909, BE-8910, BE-8915, BE-8920, BE-8925, BE-8927, BE-8930		
BE-8702, BE-8725		
BE-9770		
BE-9785		

Fit&Go 3/3 Foam Laser Marked Inlay Ratcheting Screwdrivers, T-Handle Screwdrivers & Bit Set - 114 pcs



FF1A203LM

40 x 445 x 543 mm 1 FF1A203LM

59/S100BC		
808050L		
2058-BR		
901T-010-100, 901T-015-150, 901T-020-150, 901T-025-150, 901T-027-150, 901T-030-200, 901T-040-200		



Fit&Go 3/3 Foam Laser Marked Inlay ERGO™ Screwdrivers, T-Handle Screwdrivers & L-Keys - 35 pcs



ergo



FF1A211LM



40 x 445 x 543 mm



1 FF1A211LM

- 900T-025-100, 900T-030-100, 900T-040-150, 900T-050-150, 900T-060-200, 900T-080-200
- BE-8910, BE-8915, BE-8920, BE-8925, BE-8930
- BE-8020, BE-8040
- BE-8050SL
- BE-8150, BE-8155
- BE-8355
- BE-9787
- BE-9770

Fit&Go 3/3 Foam Inlay Combination and Double Open End Wrench Set - 19 Pcs



FF1A02



45 x 445 x 543 mm



1 FF1A02

- 111M-12, 111M-13, 111M-14, 111M-17, 111M-19, 111M-22, 111M-6, 111M-7, 111M-8, 111M-10
- 6M-6-7, 6M-8-9, 6M-10-11, 6M-12-13, 6M-14-15, 6M-16-17, 6M-18-19, 6M-20-22
- 808050L

Fit&Go 3/3 Foam Inlay Adjustable/Combination/Double Open End Wrench Set - 30 Pcs



FF1A04



50 x 445 x 543 mm



1 FF1A04

- S4RM-12-15, S4RM-16-19, S4RM-8-11
- 111M-30, 111M-32, 111M-6, 111M-7, 111M-8, 111M-9, 111M-10, 111M-11, 111M-12, 111M-13, 111M-14, 111M-15, 111M-16, 111M-17, 111M-18, 111M-19, 111M-21, 111M-22, 111M-24, 111M-27
- 6M-10-11, 6M-12-13, 6M-14-15, 6M-17-19, 6M-6-7, 6M-8-9
- 9071C

Fit&Go 3/3 Foam Inlay Adjustable/Combination/Double Open End Wrench Set - 34 Pcs



FF1A09



50 x 445 x 543 mm



1 FF1A09

- 111M-30, 111M-32, 111M-6, 111M-7, 111M-8, 111M-9, 111M-10, 111M-11, 111M-12, 111M-13, 111M-14, 111M-15, 111M-16, 111M-17, 111M-18, 111M-19, 111M-21, 111M-22, 111M-24, 111M-27
- 1320RM-10-11, 1320RM-12-13, 1320RM-8-9
- 6M-6-7, 6M-8-9, 6M-10-11, 6M-12-13, 6M-14-15, 6M-16-17, 6M-18-19, 6M-20-22, 6M-24-27, 6M-30-32
- 9071C

Fit&Go 3/3 Foam Inlay Wrench and Bits Set - 19 Pcs



FF1A104



35 x 445 x 543 mm



1 FF1A104

- 111M-32, 111M-7, 111M-8, 111M-9, 111M-10, 111M-11, 111M-12, 111M-13, 111M-14, 111M-15, 111M-16, 111M-17, 111M-18, 111M-19, 111M-21, 111M-22, 111M-24, 111M-27
- 59/S54BC

Fit&Go 3/3 Foam Inlay Wrench/Adjustable Wrench Set - 22 Pcs



FF1A112



35 x 445 x 543 mm



1 FF1A112

- S4RM/3T
- 111M-6, 111M-7, 111M-8, 111M-9, 111M-10, 111M-11, 111M-12, 111M-13, 111M-14, 111M-15, 111M-16, 111M-17, 111M-18, 111M-19, 111M-20, 111M-21, 111M-22, 111M-24, 111M-27
- 9031
- 9070

BAHCO

Fit&Go 3/3 Foam Inlay Combination Wrench Set - 16 Pcs



FF1A134



37 x 445 x 543 mm

1 FF1A134

111M-30, 111M-32, 111M-6, 111M-7, 111M-8, 111M-9, 111M-10, 111M-11, 111M-12, 111M-13, 111M-14, 111M-15, 111M-16, 111M-17, 111M-18, 111M-19, 111M-20, 111M-21, 111M-22, 111M-24, 111M-27



Fit&Go 3/3 Foam Inlay Wrench/Bit Set - 51 Pcs



FF1A135



40 x 445 x 543 mm

1 FF1A135

4040M-8-9, 4040M-10-11, 4040M-12-13, 4040M-14-15, 4040M-16-17, 4040M-18-19, 4040M-20-22, 4040M-21-23



59S/31-1



6M-6-7, 6M-8-9, 6M-10-11, 6M-12-13, 6M-14-15, 6M-16-17, 6M-18-19, 6M-20-22, 6M-21-23, 6M-24-27, 6M-25-28, 6M-30-32



Fit&Go 3/3 Foam Inlay Imperial Combination and Double Open End Wrench Set - 43 Pcs



FF1A14



46 x 445 x 543 mm

1 FF1A14

111Z-1, 111Z-1/2, 111Z-1/4, 111Z-11/16, 111Z-13/16, 111Z-15/16, 111Z-3/4, 111Z-3/8, 111Z-5/16, 111Z-5/8, 111Z-7/16, 111Z-7/8, 111Z-9/16



1320RZ-1/2-9/16, 1320RZ-1/4-5/16, 1320RZ-3/8-7/16, 1320RZ-5/16-11/32



1931Z-1/2, 1931Z-1/4, 1931Z-11/32, 1931Z-3/16, 1931Z-3/8, 1931Z-5/16, 1931Z-5/32, 1931Z-7/16, 1931Z-7/32, 1931Z-9/16, 1931Z-9/32



1950MZ-3/8



1952Z-11/32



6Z-1.1/16-1.1/4, 6Z-1-1.1/8, 6Z-1/2-9/16, 6Z-1/4-5/16, 6Z-15/16-1, 6Z-19/32-11/16, 6Z-25/32-13/16, 6Z-3/8-7/16, 6Z-5/16-11/32, 6Z-5/8-3/4, 6Z-7/8-15/16



8069 C IP



9070C



Fit&Go 3/3 Foam Inlay Adjustable/Combination/Double Open End Wrench Set - 33 Pcs



FF1A19



50 x 543 x 445 mm

1 FF1A19

111M-30, 111M-32, 111M-6, 111M-7, 111M-8, 111M-9, 111M-10, 111M-11, 111M-12, 111M-13, 111M-14, 111M-15, 111M-16, 111M-17, 111M-18, 111M-19, 111M-20, 111M-21, 111M-22, 111M-24, 111M-27



6M-6-7, 6M-8-9, 6M-10-11, 6M-12-13, 6M-14-15, 6M-16-17, 6M-18-19, 6M-20-22, 6M-21-23, 6M-24-27, 6M-30-32



92C



Fit&Go 3/3 Foam Inlay Double Ring End/Double Socket Head Ratchet Set - 18 Pcs



FF1A20



50 x 445 x 543 mm

1 FF1A20

2M-6-7, 2M-8-9, 2M-10-11, 2M-12-13, 2M-14-15, 2M-16-17, 2M-18-19, 2M-20-22, 2M-21-23, 2M-24-27, 2M-30-32



4040M-10-11, 4040M-12-13, 4040M-14-15, 4040M-16-17, 4040M-18-19, 4040M-21-23



2953-250



Fit&Go 3/3 Foam Inlay Combination Wrench Set - 21 Pcs



FF1A3001



40 x 445 x 543 mm

1 FF1A3001

111M-32, 111M-30, 111M-24, 111M-22, 111M-27, 111M-17, 111M-16, 111M-15, 111M-14, 111M-21, 111M-20, 111M-19, 111M-18, 111M-9, 111M-8, 111M-7, 111M-6, 111M-13, 111M-12, 111M-11, 111M-10



Fit&Go 3/3 Foam Inlay Combination Ratcheting Wrench Set - 7 Pcs



FF1A3002

35 x 445 x 543 mm 1 FF1A3002

111M-24, 111M-22, 111M-17, 111M-16, 111M-15, 111M-14, 111M-21, 111M-20, 111M-19, 111M-18, 111M-9, 111M-8, 111M-7, 111M-6, 111M-13, 111M-12, 111M-11, 111M-10

Fit&Go 3/3 Foam Inlay Combination Offset Wrench Set - 28 Pcs



FF1A3003

40 x 445 x 543 mm 1 FF1A3003

1952M-19, 1952M-18, 1952M-22, 1952M-13, 1952M-12, 1952M-11, 1952M-10, 1952M-17, 1952M-16, 1952M-15, 1952M-14, 1952M-9, 1952M-8, 1952M-7, 1952M-6

1952M-27, 1952M-21, 1952M-20, 1952M-19, 1952M-18, 1952M-24, 1952M-22, 1952M-13, 1952M-12, 1952M-11, 1952M-10, 1952M-17, 1952M-16, 1952M-15, 1952M-14, 1952M-9, 1952M-8, 1952M-7, 1952M-6

Fit&Go 3/3 Foam Inlay Standard Combination and Ratcheting Wrench Set - 30 Pcs



FF1A3004

48 x 445 x 543 mm 1 FF1A3004

111M-24, 111M-22, 111M-17, 111M-16, 111M-15, 111M-14, 111M-21, 111M-20, 111M-19, 111M-18, 111M-9, 111M-8, 111M-7, 111M-6, 111M-13, 111M-12, 111M-11, 111M-10

1RM-19, 1RM-10, 1RM-9, 1RM-8, 1RM-14, 1RM-13, 1RM-12, 1RM-11, 1RM-18, 1RM-17, 1RM-16, 1RM-15

Fit&Go 3/3 Foam Inlay Offset Combination and Ratcheting Wrench Set - 28 Pcs



FF1A3005

38 x 445 x 543 mm 1 FF1A3005

1952M-19, 1952M-18, 1952M-22, 1952M-13, 1952M-12, 1952M-11, 1952M-10, 1952M-17, 1952M-16, 1952M-15, 1952M-14, 1952M-9, 1952M-8, 1952M-7, 1952M-6

1RM-6, 1RM-10, 1RM-9, 1RM-8, 1RM-7, 1RM-24, 1RM-22, 1RM-19, 1RM-14, 1RM-13, 1RM-12, 1RM-11, 1RM-17

Fit&Go 3/3 Foam Inlay Wrench/Drift Punch Set - 27 Pcs



FF1A5002

50 x 445 x 543 mm 1 FF1A5002

111M-30, 111M-32, 111M-6, 111M-7, 111M-8, 111M-9, 111M-10, 111M-11, 111M-12, 111M-13, 111M-14, 111M-15, 111M-16, 111M-17, 111M-18, 111M-19, 111M-20, 111M-21, 111M-22, 111M-24, 111M-27

3734S/6

Fit&Go 3/3 Foam Inlay Files and Wrench Set - 27 Pcs



FF1A5006

54 x 445 x 543 mm 1 FF1A5006

1-100-08-2-2

1-210-08-2-2

1-230-06-2-2, 1-230-10-2-2

111M-7, 111M-8, 111M-9, 111M-10, 111M-11, 111M-12, 111M-13, 111M-14, 111M-15, 111M-16, 111M-17, 111M-18, 111M-19, 111M-21, 111M-22

1320RM-6-7, 1320RM-8-9, 1320RM-10-11, 1320RM-12-13, 1320RM-14-15, 1320RM-16-17, 1320RM-18-19, 1320RM-22-24

Fit&Go 3/3 Foam Inlay Socket/Wrench Set - 36 Pcs



FF1A5027

44 x 445 x 543 mm 1 FF1A5027

2M-20-22, 2M-21-23, 2M-24-27, 2M-25-28, 2M-30-32

4040M-10-11, 4040M-12-13, 4040M-14-15, 4040M-16-17, 4040M-18-19, 4040M-20-22, 4040M-21-23, 4040M-8-9

7400SM-6, 7400SM-7, 7400SM-12, 7400SM-13, 7400SM-14, 7400SM-15, 7400SM-8, 7400SM-9, 7400SM-10, 7400SM-11, 7400SM-20, 7400SM-21, 7400SM-22, 7400SM-16, 7400SM-17, 7400SM-18, 7400SM-19

7754

7755-3/8

7760, 7761, 7762

7766

Fit&Go 3/3 Foam Inlay Combination Wrench Set - 28 Pcs



FF1A56



63 x 445 x 543 mm

1 FF1A56

111Z-1, 111Z-1/2, 111Z-1/4, 111Z-11/16, 111Z-13/16, 111Z-15/16, 111Z-3/4, 111Z-3/8, 111Z-5/16, 111Z-5/8, 111Z-7/16, 111Z-7/8, 111Z-9/16

1320RZ-1/2-9/16, 1320RZ-1/4-5/16, 1320RZ-3/8-7/16, 1320RZ-5/16-11/32

6Z-1.1/16-1.1/4, 6Z-1-1.1/8, 6Z-1/2-9/16, 6Z-1/4-5/16, 6Z-15/16-1, 6Z-19/32-11/16, 6Z-25/32-13/16, 6Z-5/16-11/32, 6Z-5/8-3/4, 6Z-7/8-15/16

9031

Fit&Go 3/3 Foam Inlay Wrenches/Hand Hacksaw Set - 28 Pcs



FF1A65



50 x 445 x 543 mm

1 FF1A65

111M-19, 111M-17, 111M-18, 111M-24, 111M-21, 111M-22, 111M-7, 111M-8, 111M-6, 111M-11, 111M-12, 111M-9, 111M-10, 111M-15, 111M-16, 111M-13, 111M-14, 111M-20

1RM-8, 1RM-9, 1RM-12, 1RM-13, 1RM-10, 1RM-11, 1RM-17, 1RM-14, 1RM-19

319

Fit&Go 3/3 Foam Laser Marked Inlay Combination Spanners Set - 20 pcs



FF1A198LM



35 x 445 x 543 mm

1 FF1A198LM

111M-10, 111M-11, 111M-12, 111M-13, 111M-14, 111M-15, 111M-16, 111M-17, 111M-18, 111M-19, 111M-20, 111M-21, 111M-22, 111M-24, 111M-27, 111M-30, 111M-32, 111M-34, 111M-8, 111M-9

Fit&Go 3/3 Foam Laser Marked Inlay Adjustable, Ratcheting & Swivel Head Spanners Set - 23 pcs



FF1A199LM



35 x 445 x 543 mm

1 FF1A199LM

1RM-10, 1RM-11, 1RM-12, 1RM-13, 1RM-14, 1RM-15, 1RM-16, 1RM-17, 1RM-18, 1RM-19, 1RM-21, 1RM-22, 1RM-24, 1RM-8, 1RM-9

4040M-10-11, 4040M-12-13, 4040M-14-15, 4040M-16-17, 4040M-18-19, 4040M-8-9

9029, 9031

Fit&Go 3/3 Foam Laser Marked Inlay Combination Spanners & Magnetic Pick-Up with LED Light - 56 pcs



FF1A209LM



35 x 445 x 543 mm

1 FF1A209LM

111M-10, 111M-11, 111M-12, 111M-13, 111M-14, 111M-15, 111M-16, 111M-17, 111M-18, 111M-19, 111M-20, 111M-21, 111M-22, 111M-24, 111M-27, 111M-30, 111M-32, 111M-34, 111M-8, 111M-9

2535L

Fit&Go 3/3 Foam Laser Marked Inlay Combination Spanner Set & Adjustable Spanner - 21 pcs



FF1A220LM



35 x 445 x 543 mm

1 FF1A220LM

111M-10, 111M-11, 111M-12, 111M-13, 111M-14, 111M-15, 111M-16, 111M-17, 111M-18, 111M-19, 111M-20, 111M-21, 111M-22, 111M-23, 111M-24, 111M-27, 111M-30, 111M-32, 111M-8, 111M-9

8071

Fit&Go 3/3 Foam Inlay Spanners Set - 31 pcs



FF1A48



44 x 543 x 445 mm

1 FF1A48

1RM-6, 1RM-7, 1RM-8, 1RM-9, 1RM-10, 1RM-11, 1RM-12, 1RM-13, 1RM-14, 1RM-17, 1RM-19, 1RM-22, 1RM-24, 1RM-27

111M-6, 111M-7, 111M-8, 111M-9, 111M-10, 111M-11, 111M-12, 111M-13, 111M-14, 111M-15, 111M-16, 111M-17, 111M-18, 111M-19, 111M-20, 111M-21, 111M-22



Fit&Go 3/3 Foam Inlay Metric Double Head Offset Socket Spanners Set - 14 pcs



FF1A170

40 x 445 x 543 mm 1 FF1A170

28M-16, 28M-15, 28M-18, 28M-17, 28M-12, 28M-11, 28M-14, 28M-13, 28M-24, 28M-19, 28M-22, 28M-8, 28M-10, 28M-9

Fit&Go 3/3 Laser Marked Foam Inlay with Automotive Plug Socketry - 31 pcs



FF1A235

50 x 445 x 543 mm 4.10 kg 1 FF1A235

BE61110
 BE621702, BE621703, BE621701, BE621706, BE621707, BE621704, BE621705, BE621710, BE621711, BE621708, BE621709, BE621714, BE621715, BE621712, BE621713, BE621716, BE621717
 BE6810
 2M-6-7, 2M-8-9, 2M-12-13, 2M-18-19, 2M-16-17, 2M-10-11, 2M-14-15, 2M-24-26, 2M-21-23, 2M-27-29, 2M-20-22, 2M-30-32

Fit&Go 3/3 Foam Inlay Combination Wrenches and Pliers Set - 82 Pcs



FF1A102

40 x 445 x 543 mm 1 FF1A102

111M-32, 111M-8, 111M-9, 111M-10, 111M-11, 111M-12, 111M-13, 111M-14, 111M-15, 111M-16, 111M-17, 111M-18, 111M-19, 111M-21, 111M-22, 111M-24, 111M-27
 7224
 2800-180
 2900-180
 2890-180
 2990-180
 2101G-180
 2628 G-180IP

Fit&Go 3/3 Foam Inlay Pliers Set - 16 Pcs



FF1A11

43 x 543 x 445 mm 1 FF1A11

2101GC-125IP, 2101GC-160IP
 21HDGC-200IP
 2427 GC-200IP
 2430 GC-200 IP
 2628 GC-160IP
 2928-160, 2928-200, 2928-250
 2951-250
 2952-165
 8224CIP

Fit&Go 3/3 Foam Inlay Pliers and File Set - 14 Pcs



FF1A118

35 x 445 x 543 mm 1 FF1A118

1-100-08-2-2
 2430 G-160 IP

2628G-200IP
 2800-180
 2900-180
 2890-180
 2990-180
 5515T
 1-170-08-2-2
 1-210-08-2-2
 1-230-08-2-2
 2535F1
 8224 IP
 2101G-180IP

Fit&Go 3/3 Foam Inlay Mixed Wrench/ Pliers Set - 46 Pcs

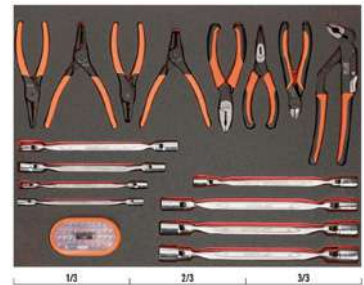

FF1A141

42 x 445 x 543 mm 1 FF1A141

2628 G-180
 2430 G-160
 8224
 2101G-160
 2800-180
 2890-180
 2900-180
 2990-180
 4040M-8-9, 4040M-10-11, 4040M-12-13, 4040M-14-15, 4040M-16-17, 4040M-18-19, 4040M-20-22, 4040M-21-23
 59S/31-1

Fit&Go 3/3 Foam Inlay Screwdriver/File/
Pliers Set - 20 Pcs



FF1A145

38 x 445 x 543 mm 1 FF1A145

- 2628 G-180
- 2430 G-160
- 8224
- 2101G-160
- 8045LVDE
- 808050
- 613-3-75
- 611-4-100, 611-5.5-100, 611-6.5-150,
611-8-150, 611-6.5-25
- 615-1-100, 615-2-125, 615-2-25
- 1-100-08-1-2
- 1-160-08-1-2
- 1-170-08-2-2
- 1-210-08-1-2
- 1-230-08-1-2

Fit&Go 3/3 Foam Inlay Cutters and Pliers
Set - 12 Pcs



FF1A15

40 x 445 x 543 mm 1 FF1A15

- 2101GC-125IP, 2101GC-160IP
- 2233D-240IP
- 2421GC-180IP
- 2427 GC-200IP
- 2430 GC-200 IP
- 2628 GC-160IP
- 2650
- 2855, 2855 D
- 2951-180
- 8224CIP

Fit&Go 3/3 Foam Inlay Pliers Set - 12 Pcs



FF1A4001

38 x 445 x 543 mm 1 FF1A4001

- 1520 D
- 2101G-160IP
- 21HDG-200IP
- 2223 G-150
- 2421 G-140IP, 2421 G-180 IP
- 2427 G-200 IP
- 2628 G-180IP
- 2681
- 2951-140, 2951-300
- 8224 IP

Fit&Go 3/3 Foam Inlay Pliers Set - 11 Pcs



FF1A4002

42 x 445 x 543 mm 1 FF1A4002

- 2101G-160IP
- 2430 G-200 IP
- 2465D-200
- 2628 G-160IP
- 2744
- 2951-140
- 2952-165
- 1520 G
- 527 D-160
- 7224
- 5515FL

Fit&Go 3/3 Foam Inlay Circlip Pliers Set
- 12 Pcs



FF1A4003

35 x 445 x 543 mm 1 FF1A4003

- 2800-150, 2800-180, 2800-225
- 2890-140, 2890-180, 2890-210
- 2900-150, 2900-180, 2900-215
- 2990-140, 2990-180, 2990-200

Fit&Go 3/3 Foam Inlay Pliers/Wrench Set
- 13 Pcs



FF1A50

45 x 445 x 543 mm 1 FF1A50

- 8223 IP, 8224 IP, 8225 IP
- 1420
- 2430 G-160 IP
- 2427 G-160 IP
- 8069
- 9070
- 9031
- 2101G-160IP
- 21HDG-180IP



Fit&Go 3/3 Foam Inlay File/Pliers/Punch Set - 23 Pcs



FF1A51



40 x 445 x 543 mm

1 FF1A51

1-100-08-1-2		
1-210-08-1-2		
1-230-08-1-2		
4-144-08-2-2		
1-170-08-1-2		
3735-4-120		
3733-4, 3733-2, 3733-6		
3734-2, 3734-3, 3734-4, 3734-5, 3734-6, 3734-8		
2800-180, 2800-150		
2890-140, 2890-180		
2900-150, 2900-180		
2990-140, 2990-180		

Fit&Go 3/3 Foam Inlay Files/Striking/Circlip Pliers/Hex Key Set - 30 Pcs



FF1A68



37 x 445 x 543 mm

1 FF1A68

1-100-08-1-2		
1-170-08-1-2		
1-210-08-1-2		
1-230-08-1-2		
2800-180		
2890-180		
2900-180		
2990-180		
3733-4, 3733-2, 3733-6		
3734-8, 3734-5, 3734-6, 3734-3, 3734-4, 3734-2		
3735-4-120		
4-144-08-2-2		
481-400		
BE-9770		

Fit&Go 3/3 Foam Laser Marked Inlay Pipe Wrench, Holding, Cutting & Circlip Pliers - 14 pcs



FF1A200LM



35 x 445 x 543 mm

1 FF1A200LM

1520 G		
1620		
2101G-160		
2223 S-150		
2233 D-160		
2430 G-190HD		
2628 G-180		
2890-180		
2990-180		
C3330R		
C3530		
C3230		
C3640		
8224		

Fit&Go 3/3 Foam Laser Marked Inlay Pliers & T-Type Hex Key Spanners - 15 pcs



FF1A223LM



35 x 445 x 543 mm

1 FF1A223LM

5226 DC		
158-N		
158-NB		
21HDG-200		
2430 G-190HD		
2628G-200IP		
2968-190		
8224 IP		
BE1P		
BE1TH-2.5, BE1TH-3, BE1TH-4, BE1TH-5, BE1TH-6, BE1TH-8		

Fit&Go 3/3 Foam Inlay Pliers/Striking/Measuring Toolset - 18 Pcs



FF1A03



50 x 445 x 543 mm

1 FF1A03

BE-9770		
MTB-5-25		
3734N-4-150, 3734N-6-150		
1-100-08-2-2		
2171G-160		
2971G-250		
481-400		
2678 G-160		
306		

Fit&Go 3/3 Foam Inlay Screwdriver/Pliers Set - 23 Pcs



FF1A06



45 x 445 x 543 mm

1 FF1A06

BE-8020L, BE-8040		
BE-8150, BE-8255, BE-8256		
BE-8350		
BE-8601		
BE-8610, BE-8620		
BE-8910, BE-8915, BE-8920, BE-8925, BE-8927, BE-8930		
MTB-3-16		
2101G-160IP		
2427 G-200 IP		
2535L		
2628 G-160IP		
2951-180		
5515T-52		
8224 IP		

Fit&Go 3/3 Foam Inlay File/Striking Toolset with Hacksaw Frame - 15 Pcs



FF1A07



40 x 445 x 543 mm

1 FF1A07

3734N-3-150, 3734N-5-150, 3734N-6-150	
3735N-4-120	
3740-175	
SQZ150003	
1-100-08-2-2	
1-210-08-2-2	
1-230-08-2-2	
2744	
3625W-35	
3745-150	
481-400	
782-U	
317	

Fit&Go 3/3 Foam Inlay Striking and Cutting Toolset - 11 Pcs



FF1A110



50 x 445 x 543 mm

1 FF1A110

2535L	
426TOR9	
9572-200	
MTB-8-25	
SQZ150003	
3875-LY3	
479-24	
481-400	
529-20-L	
225-PLUS	
208	

Fit&Go 3/3 Foam Inlay Pliers and Striking Toolset - 18 Pcs



FF1A114



42 x 445 x 543 mm

1 FF1A114

8224 IP	
2632	
3734-2, 3734-3, 3734-4, 3734-5, 3734-6, 3734-8	
2800-180	
2890-180	
2900-180	
2990-180	
4611-2	
479-24	
1435/5	
1178-SCRIBE	
2430 G-160 IP	
2101G-180IP	

Fit&Go 3/3 Foam Inlay Measuring and Cutting Toolset - 9 Pcs



FF1A115



35 x 445 x 543 mm

1 FF1A115

1-210-08-1-2	
9045-B-250	
406T-225	
MTB-5-25	
K-AP-1	
268	
5515T-52	
319	

Fit&Go 3/3 Foam Inlay Wrench and Screwdriver Set - 26 Pcs



FF1A117



35 x 445 x 543 mm

1 FF1A117

B191.040.100	
B190.055.125, B190.065.150	
B192.000.075, B192.001.100, B192.002.125	
111M-32, 111M-6, 111M-7, 111M-8, 111M-9, 111M-10, 111M-11, 111M-12, 111M-13, 111M-14, 111M-15, 111M-16, 111M-17, 111M-18, 111M-19, 111M-21, 111M-22, 111M-24, 111M-27	
8073 IP	

Fit&Go 3/3 Foam Inlay Striking and Cutting Toolset - 10 Pcs



FF1A119



47 x 445 x 543 mm

1 FF1A119

3734S/6	
481-300	
KGAU-01	
MTB-5-25-M-E	
137-10	
1150-1/2H/P	
426TOR9	
BLTS10	
375-8	
319	



Fit&Go 3/3 Laser Marked Foam Inlay for Automotive Body Shop - 13 pcs



FF1A236

55 x 445 x 543 mm
 9.5 kg
 1 FF1A236

3-330-14-2-0	
9-462-14-0-0	
1467-250	
BBSH2F	
BBSH2CA	
BBSDW	
BBSDA	
BBSDT	
BBSDH	
BBSDC	
BBSDHR	
BBSS1	
2485	

Fit&Go 3/3 Foam Inlay Striking and File Set - 19 Pcs



FF1A12

35 x 445 x 543 mm
 1 FF1A12

FS-8	
1-100-06-1-2, 1-100-06-2-2	
1-160-06-1-2	
1-210-06-1-2	
1-230-06-1-2	
2509	
2535F2	
3625W-35	
3734-3, 3734-5, 3734-8	
3735-4-120	

3740-150	
3745-150	
481-300, 481-500	
319	
8157-15	

Fit&Go 3/3 Foam Inlay Wrench/Pliers Set - 28 Pcs



FF1A121

40 x 445 x 543 mm
 1 FF1A121

111M-8, 111M-9, 111M-10, 111M-11, 111M-12, 111M-13, 111M-14, 111M-15, 111M-16, 111M-17, 111M-18, 111M-19, 111M-22	
2470 G-200	
7224	
2953-250	
6M-6-7, 6M-8-9, 6M-10-11, 6M-12-13, 6M-14-15, 6M-16-17, 6M-18-19, 6M-20-22	
2800-180	
2900-180	
2101G-160IP	

Fit&Go 3/3 Foam Inlay Wrench/ Screwdriver Set - 25 Pcs



FF1A124

45 x 445 x 543 mm
 1 FF1A124

B191.040.100	
B190.055.125, B190.065.150	
B192.000.075, B192.001.100, B192.002.125	

111M-32, 111M-6, 111M-7, 111M-8, 111M-9, 111M-10, 111M-11, 111M-12, 111M-13, 111M-14, 111M-15, 111M-16, 111M-17, 111M-18, 111M-19, 111M-21, 111M-22, 111M-24, 111M-27	
---	--

Fit&Go 3/3 Foam Inlay Striking/Cutting Toolset - 11 Pcs



FF1A127

35 x 445 x 543 mm
 1 FF1A127

3734S/6	
479-16	
3625W-35	
MTG-3-16	
KB18-01	
KSBG18-10DISPEN	
8224 IP	
2101G-160IP	
2628 G-180IP	
2430 G-200 IP	
2530	

Fit&Go 3/3 Foam Inlay Striking, Cutting & Pliers - 14 Pcs



FF1A185

40 x 445 x 543 mm
 1 FF1A185

479-16	
3625W-35	
KB18-01	
KSBG18-10DISPEN	
2101G-180IP	
2470 G-200	
2678 G-180	
8224 IP	
2530	

Fit&Go 3/3 Foam Inlay Wrench/File Set - 18 Pcs



FF1A128

65 x 445 x 543 mm 1 FF1A128

- 9029, 9031
- 111Z-1/4, 111Z-5/16, 111Z-3/8, 111Z-7/16, 111Z-1/2, 111Z-9/16, 111Z-5/8, 111Z-11/16, 111Z-3/4, 111Z-13/16, 111Z-7/8, 111Z-1
- 1-473-08-2-2
- 361-12
- 2633/S4
- S4RM/5T

Fit&Go 3/3 Foam Inlay Pliers/Screwdriver Set - 16 Pcs



FF1A129

45 x 445 x 543 mm 1 FF1A129

- 2171G-180
- 2470 G-200
- 2477 G-200
- 9033, 9035
- 1520 G
- 808050P
- B191.040.100
- B190.055.125, B190.065.150
- B192.000.075, B192.001.100, B192.002.125
- BE-9777B
- 2678 G-200
- 59S/31-1

Fit&Go 3/3 Foam Inlay Mixed Tightening/Measuring Toolset - 10 Pcs



FF1A131

40 x 445 x 543 mm 1 FF1A131

- SQZ150003
- FS-8
- SQZ150003-SBL
- 481-400
- 3734-2, 3734-4, 3734-5, 3734-6, 3734-8, 3734-3
- 3735-5-120
- 3740-175
- BE-9678
- 1547
- 319
- 208
- 3625N-32

Fit&Go 3/3 Foam Inlay Mixed Sockets/File Set - 31 Pcs



FF1A132

40 x 445 x 543 mm 1 FF1A132

- 7400SM-6, 7400SM-7, 7400SM-8, 7400SM-9, 7400SM-10, 7400SM-11, 7400SM-12, 7400SM-13, 7400SM-14, 7400SM-15, 7400SM-16, 7400SM-17, 7400SM-18, 7400SM-19
- 7750SL
- SBS705

- SBS755
- SBS723, SBS724
- SBS775
- SBS760, SBS761, SBS762
- 1-100-08-1-2
- 1-160-08-1-2
- 1-170-08-2-2
- 1-210-08-1-2
- 1-230-08-1-2
- 2635
- 1150D
- 2681

Fit&Go 3/3 Foam Inlay 1/4" Socket/Pliers/Screwdriver Set - 40 Pcs



FF1A136

40 x 445 x 543 mm 1 FF1A136

- 2628 G-180
- 2430 G-160
- 8224
- 2101G-160
- 6700SM-4.5, 6700SM-5, 6700SM-5.5, 6700SM-6, 6700SM-7, 6700SM-8, 6700SM-9, 6700SM-10, 6700SM-11, 6700SM-12, 6700SM-13, 6700SM-14, 6700SM-4
- 6950SL
- SBS67
- SBS69
- SBS65
- SBS63-2, SBS63-4, SBS63-6
- 2800-180
- 2890-180
- 2900-180
- 2990-180
- B191.030.075, B191.040.100
- B190.055.100, B190.065.125, B190.080.150
- B195.050.025
- B195.001.025
- B192.001.100, B192.002.125
- 808050
- 6954



Fit&Go 3/3 Foam Inlay Mixed Striking/
Cutting Toolset - 16 Pcs



FF1A138



40 x 445 x 543 mm

1 FF1A138

SQZ150003

FS-8

SQZ150003-SBL

481-400

3734-2, 3734-3, 3734-4, 3734-5,
3734-6, 3734-8

3735-5-120

3740-175

BE-9678

319

208

3625N-32

Fit&Go 3/3 Foam Inlay Mixed Striking/
Cutting Toolset - 15 Pcs



FF1A143



45 x 445 x 543 mm

1 FF1A143

SQZ150003

FS-8

SQZ150003-SBL

MTB-5-25

481-400

3734-2, 3734-3, 3734-4, 3734-5,
3734-6, 3734-8

3735-5-120

3740-175

319

208

3625N-32

Fit&Go 3/3 Foam Inlay Cutting/Striking/
Screwdriver Set - 16 Pcs



FF1A147



40 x 445 x 543 mm

1 FF1A147

2951-250, 2951-180

SQZ150003

SQZ150003-SBL

B191.030.075, B191.040.100

B190.055.100, B190.065.125,
B190.080.150

B195.050.025

B195.001.025

B192.001.100, B192.002.125

319

208

3625N-32

Fit&Go 3/3 Foam Inlay Mixed Toolset - 18
Pcs



FF1A16



40 x 445 x 543 mm

1 FF1A16

KE18-01

1150-1/2H/P

MTB-3-16

1177-SCRIBE

1544

2509

2535F2

2632

268

2744

2820EF2

3525HB

5471 F-145

5515T

5515T-52

5516

SR300-E

Fit&Go 3/3 Foam Inlay Striking/File Set -
24 Pcs



FF1A18



44 x 445 x 543 mm

1 FF1A18

1-476-04-3-2

2633/S4

3734S/6

3736S/6

481-200, 481-500

782-U

3625N-32

Fit&Go 3/3 Foam Inlay Measuring Tape/
Striking/Pliers Set - 21 Pcs



FF1A23



40 x 445 x 543 mm

1 FF1A23

3735-4-120

3734-2, 3734-3, 3734-4, 3734-5,
3734-6, 3734-8

2630GC-180IP

2430 GC-200 IP

2427 GC-200IP

2900-180

2890-180

2990-180

2800-180

7224

2101GC-160IP

479-16



1547

MTB-3-16	
SC127	
3625N-32	













Fit&Go 3/3 Foam Inlay Measuring Tape/
Striking/Pliers Set - 19 Pcs

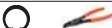

FF1A24



45 x 445 x 543 mm 1 FF1A24

3735-4-120	
3734-2, 3734-3, 3734-4, 3734-5, 3734-6, 3734-8	
2630GC-180IP	
2430 GC-200 IP	
2900-180	
2890-180	
2990-180	
2800-180	
7224	
2101GC-160IP	
479-16	
3625N-32	
MTB-3-16	
SC127	



Fit&Go 3/3 Foam Inlay Pliers and Wrench
Set - 27 Pcs







FF1A26

50 x 445 x 543 mm 1 FF1A26

111M-30, 111M-32, 111M-6, 111M-7, 111M-8, 111M-9, 111M-10, 111M-11, 111M-12, 111M-13, 111M-14, 111M-15, 111M-16, 111M-17, 111M-18, 111M-19, 111M-20, 111M-21, 111M-22, 111M-24, 111M-27	
2630GC-180IP	
2430 GC-200 IP	

7224	
2953-250	
2101GC-160IP	
SC127	















Fit&Go 3/3 Foam Inlay Socket and Striking
Set - 48 Pcs



FF1A28

50 x 445 x 543 mm 1 FF1A28

7800SM-18, 7800SM-19, 7800SM-21, 7800SM-22, 7800SM-23, 7800SM-24, 7800SM-27, 7800SM-30, 7800SM-32, 7800SM-10, 7800SM-12, 7800SM-13, 7800SM-14, 7800SM-15, 7800SM-16, 7800SM-17	
8150SL	
6700SM-4.5, 6700SM-5, 6700SM-5.5, 6700SM-6, 6700SM-7, 6700SM-8, 6700SM-9, 6700SM-10, 6700SM-11, 6700SM-12, 6700SM-13, 6700SM-4	
6954	
6960, 6962	
6966	
6950SL	
3735-4-120	
3734-2, 3734-3, 3734-4, 3734-5, 3734-6, 3734-8	
479-16	
MTB-3-16	
3625N-32	
8154-11	
8160-3, 8160-5	
8166	











Fit&Go 3/3 Foam Inlay Striking and File
Set - 24 Pcs



FF1A35

42 x 445 x 543 mm 1 FF1A35

317	
1-100-08-1-2	
1-210-08-1-2	
1-230-08-1-2	
MTB-3-16	
3625W-35	
481-300	
782-U	
BE-9770	
KG09-01	
4040M-8-9, 4040M-10-11, 4040M-12-13, 4040M-14-15, 4040M-16-17	















Fit&Go 3/3 Foam Inlay Screwdriver/Bit/
Socket Set - 89 Pcs



FF1A36

50 x 445 x 543 mm 1 FF1A36

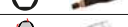
4040M-8-9, 4040M-10-11, 4040M-12-13, 4040M-14-15, 4040M-16-17	
808050S	
808050	
6972H	
K6650-1/4-1P	
6950SL	
59S/31-1	
59S/H2, 59S/H3, 59S/H4, 59S/H5, 59S/H6, 59S/H8	
8030-2P, 8040-2P, 8242-2P, 8252-2P	
8610-2P, 8620-2P, 8630-2P	
8810-2P, 8820-2P, 8830-2P	
8910-2P, 8915-2P, 8925-2P, 8930-2P, 8940-2P	
BE-8575	
SBS60-11, SBS60-12, SBS60-13, SBS60-4, SBS60-4.5, SBS60-5, SBS60-5.5, SBS60-6, SBS60-7, SBS60-8, SBS60-9, SBS60-10	
SB6963	
SBS64	



Fit&Go 3/3 Foam Inlay Striking and Saw Set - 9 Pcs



FF1A41

42 x 445 x 543 mm 1 FF1A41

2171G-160	
2470 G-160	
2971G-250	
MTB-3-16	
WR2-12	
3625W-35	
481-300	
218	
306	

Fit&Go 3/3 Foam Inlay Socket/Striking Toolset - 60 Pcs



FF1A5007

50 x 445 x 543 mm 1 FF1A5007

K6650-1/4-1P	
3734-2, 3734-3, 3734-4, 3734-5, 3734-6, 3734-8	
481-400	
6700SM-11, 6700SM-12, 6700SM-13, 6700SM-14, 6700SM-10, 6700SM-5, 6700SM-6, 6700SM-7, 6700SM-8, 6700SM-9, 6700SM-4	
6709F-8, 6709F-5.5	
6709M-3, 6709M-4, 6709M-5, 6709M-6	
6709PH-1, 6709PH-2	
6950SL	
6954	
6960, 6962	
6966	

7800SM-18, 7800SM-19, 7800SM-10, 7800SM-11, 7800SM-12, 7800SM-13, 7800SM-14, 7800SM-15, 7800SM-16, 7800SM-17, 7800SM-21, 7800SM-22, 7800SM-23, 7800SM-24, 7800SM-25, 7800SM-26, 7800SM-27, 7800SM-28, 7800SM-30, 7800SM-32

8072 IP	
B145.006.100	
8150SL	
8224 IP	
8154-11	
8160-5, 8160-10	
8166	

Fit&Go 3/3 Foam Inlay Adjustable Wrench/Striking/Measuring Toolset - 24 Pcs



FF1A5008

50 x 445 x 543 mm 1 FF1A5008

1-100-08-2-2	
1-160-08-2-2	
1-170-08-2-2	
1-210-08-2-2	
1-230-08-2-2	
1150D	
1450D-ISO	
1547	
3625N-40	
3734-2, 3734-3, 3734-4, 3734-5, 3734-6, 3734-8	
3735-4-120, 3735-5-150	
3740-125, 3740-150	
38-20	
5515T	
9029, 9031	
MTB-3-16	

Fit&Go 3/3 Foam Inlay Insulated Wrench/Pliers/Screwdriver Set - 17 Pcs



FF1A5009

38 x 445 x 543 mm 1 FF1A5009

2101S-160	1000 V ECLASS	
2223 S-150	1000 V ECLASS	
2250V-170	1000 V ECLASS	
2430 S-200	1000 V ECLASS	
2628 S-180	1000 V ECLASS	
8072V	1000 V ECLASS	
BE-8220S, BE-8040S, BE-8050S, BE-8255S, BE-8065S		
BE-8340		
BE-8601		
BE-8610S, BE-8620S		
BE-8810S, BE-8820S		

Fit&Go 3/3 Foam Inlay Adjustable Wrench/Striking/File/Pliers Set - 22 Pcs



FF1A5010

35 x 445 x 543 mm 1 FF1A5010

1-100-08-1-2	
1-160-08-1-2	
1-170-08-2-2	
1-210-08-1-2	
1-230-08-1-2	
2101G-180IP	
2427 G-200 IP	
2430 G-200 IP	
2628 G-180IP	
3733-2, 3733-4, 3733-6	
3734-2, 3734-3, 3734-4, 3734-5, 3734-6, 3734-8	
3735-4-120	
481-300	
8069 IP	
9031	

Fit&Go 3/3 Foam Inlay Pliers/Striking/File/ Screwdriver Set - 27 Pcs



FF1A5011

44 x 445 x 543 mm 1 FF1A5011

1-476-04-3-2		
1178-SCRIBE		
1547		
2101G-160IP		
2427 G-160 IP		
2430 G-160 IP		
3734-2, 3734-3, 3734-4, 3734-5, 3734-6, 3734-8		
3735-5-120		
481-500		
BE-8020L, BE-8040		
BE-8150, BE-8255, BE-8256		
BE-8610, BE-8620		
MTB-3-16		

Fit&Go 3/3 Foam Inlay Striking and Measuring Toolset - 13 Pcs



FF1A5012

48 x 445 x 543 mm 1 FF1A5012

141	
3734-2, 3734-3, 3734-4, 3734-5, 3734-6	
479-08	
481-1000, 481-300	
782-U	
MTS-5-25	
SQZ150003	
319	

Fit&Go 3/3 Foam Inlay Screwdriver/ Hacksaw Set - 17 Pcs



FF1A5015

45 x 445 x 543 mm 1 FF1A5015

319	
268	
208	
2509	
2444	
2744	
5515T	
BE-8020L, BE-8040	
BE-8150, BE-8255, BE-8256	
BE-8340	
BE-8601	
BE-8610, BE-8620	
MTB-5-25	

Fit&Go 3/3 Foam Inlay Screwdriver/ Wrench Set - 16 Pcs



FF1A5017

35 x 445 x 543 mm 1 FF1A5017

3734-2, 3734-3, 3734-4, 3734-5, 3734-6, 3734-8	
3735-5-120	
3740-175	
481-400	
111M-21, 111M-22, 111M-24, 111M-27, 111M-32, 111M-30	
3625N-32	

Fit&Go 3/3 Foam Inlay Wrench/Pliers/ Socket Set - 47 Pcs



FF1A5019

52 x 445 x 543 mm 1 FF1A5019

111M-17, 111M-18, 111M-19, 111M-20, 111M-6, 111M-7, 111M-8, 111M-13, 111M-14, 111M-15, 111M-16, 111M-9, 111M-10, 111M-11, 111M-12	
2101G-160IP	
2430 G-160 IP	
2628 G-180IP	
7800DM-12, 7800DM-13, 7800DM-14, 7800DM-15, 7800DM-10, 7800DM-11, 7800DM-20, 7800DM-21, 7800DM-22, 7800DM-23, 7800DM-16, 7800DM-17, 7800DM-18, 7800DM-19, 7800DM-28, 7800DM-30, 7800DM-32, 7800DM-24, 7800DM-25, 7800DM-26, 7800DM-27, 7800DM-8, 7800DM-9	
8155-1/2	
8224 IP	
8154-11	
8160-5, 8160-10	
8166	

Fit&Go 3/3 Foam Inlay Screwdriver/Cutting Tool Set - 17 Pcs



FF1A5021

45 x 445 x 543 mm 1 FF1A5021

BE-8020L, BE-8040	
BE-8150, BE-8255, BE-8256	
BE-8340	
BE-8601	
BE-8610, BE-8620	
319	
MTB-5-25	
2444	
268	
5515T	
2509	
2744	
208	



Fit&Go 3/3 Foam Inlay Pliers/Wrench/Socket Set - 26 Pcs



FF1A5022



50 x 445 x 543 mm



1 FF1A5022

6700SM-4.5, 6700SM-5, 6700SM-5.5, 6700SM-6, 6700SM-7, 6700SM-8, 6700SM-9, 6700SM-10, 6700SM-11, 6700SM-12, 6700SM-13, 6700SM-14, 6700SM-4

6950

6954

6956

6960, 6962

6966

8070

9031

9072 P

141

2101G-160IP

2430 G-160 IP

2628 G-180IP

8224 IP



Fit&Go 3/3 Foam Inlay Screwdriver/Cutting Tool Set - 16 Pcs



FF1A5023



45 x 445 x 543 mm



1 FF1A5023

208

2444

2509

268

2744

319

5515T

BE-8020L, BE-8040



BE-8150, BE-8255, BE-8256

BE-8340

BE-8601

BE-8610, BE-8620



Fit&Go 3/3 Foam Inlay Wrench and Pliers Set - 28 Pcs



FF1A5024



45 x 445 x 543 mm



1 FF1A5024

111M-12, 111M-13, 111M-6, 111M-7, 111M-8, 111M-9, 111M-10, 111M-11

1RM-17, 1RM-18, 1RM-19, 1RM-8, 1RM-9, 1RM-10, 1RM-11, 1RM-12, 1RM-13, 1RM-14, 1RM-15, 1RM-16

2101G-160IP

2430 G-160 IP

141

2628 G-180IP

9031

9072 P

8070

8224 IP



Fit&Go 3/3 Foam Inlay Socket/Wrench Set - 32 Pcs



FF1A5028



45 x 445 x 543 mm



1 FF1A5028

111M-6, 111M-7, 111M-8, 111M-9, 111M-10, 111M-11, 111M-14, 111M-15, 111M-16, 111M-17, 111M-18, 111M-19, 111M-20, 111M-12, 111M-13

1419-MD

BE-8906, BE-8907, BE-8908, BE-8909, BE-8910, BE-8915, BE-8920, BE-8925, BE-8927, BE-8930, BE-8940, BE-8945

7805DM-12, 7805DM-13, 7805DM-17, 7805DM-10, 7805DM-19



Fit&Go 3/3 Foam Inlay Pliers/Wrench Set - 29 Pcs



FF1A5029



40 x 445 x 543 mm



1 FF1A5029

2628 G-180IP

2101G-160IP

2430 G-160 IP

8224 IP

BBR201P6

BE5103

2M-10-11, 2M-12-13, 2M-14-15, 2M-16-17, 2M-18-19, 2M-6-7, 2M-8-9

7809TORX-T50, 7809TORX-T55, 7809TORX-T25, 7809TORX-T30, 7809TORX-T40, 7809TORX-T45



Fit&Go 3/3 Foam Inlay Socket/Wrench/ Grip Set - 45 Pcs



FF1A5030



52 x 445 x 543 mm



1 FF1A5030

111M-17, 111M-18, 111M-19, 111M-20, 111M-6, 111M-7, 111M-8, 111M-13, 111M-14, 111M-15, 111M-16, 111M-9, 111M-10, 111M-11, 111M-12

2951-180, 2951-250

7800DM-12, 7800DM-13, 7800DM-14, 7800DM-15, 7800DM-8, 7800DM-9, 7800DM-10, 7800DM-11, 7800DM-20, 7800DM-21, 7800DM-22, 7800DM-23, 7800DM-16, 7800DM-17, 7800DM-18, 7800DM-19, 7800DM-28, 7800DM-30, 7800DM-32, 7800DM-24, 7800DM-26, 7800DM-27

8155-1/2

3625N-32

8154-11

8160-5, 8160-10

8166



Fit&Go 3/3 Foam Inlay Screw/Socket Driver Set - 62 Pcs



FF1A5031



48 x 445 x 543 mm

1 FF1A5031



1419-MD

7809M-10, 7809M-12, 7809M-14,
7809M-17, 7809M-19, 7809M-7, 7809M-8,
7809M-5, 7809M-9, 7809M-6

BE-9678

7809M-10-140, 7809M-5-180, 7809M-6-140,
7809M-7-100, 7809M-8-120

59S/31-1

808050

7805DM-12, 7805DM-13, 7805DM-17,
7805DM-19, 7805DM-10

Fit&Go 3/3 Foam Inlay Hose Clamp Set - 6 Pcs



FF1A5036



38 x 445 x 543 mm

1 FF1A5036



BE258

BE250

BE256P3

BE254A

Fit&Go 3/3 Foam Inlay Calliper Set for Brake - 50 Pcs



FF1A5038



45 x 445 x 543 mm

1 FF1A5038



BBR300P50

Fit&Go 3/3 Foam Inlay Screwdriver/Key Set - 38 Pcs



FF1A53



45 x 445 x 543 mm

1 FF1A53



BE-8800, BE-8811, BE-8821

BE-8830

BE-8600, BE-8611, BE-8621

BE-8630

BE-8910, BE-8915, BE-8920, BE-8925

BE-9770

BE-9780

3625S-44

2800-225

2890-210

Fit&Go 3/3 Foam Inlay Measuring Tape and Screwdriver Set - 50 Pcs



FF1A66



50 x 445 x 543 mm

1 FF1A66



038.055.100, 038.065.125, 038.080.150

039.001.100, 039.002.125

1178-SCRIBE

426TOR9

6972H

9045-B-250

BE-8010S, BE-8230S

BE-8040

BE-8150, BE-8155

BE-8800, BE-8811, BE-8821

BE-8830

MTB-5-25

SQZ150003

59S/31-1

Fit&Go 3/3 Foam Inlay Screwdriver/Wrench/Pliers Set - 28 Pcs



FF1A67



39 x 445 x 543 mm

1 FF1A67



9031

2101G-160IP

21HDG-180IP

2427 G-160 IP

2430 G-160 IP

8224 IP

BE-8600, BE-8611, BE-8621

BE-8630

BE-8910, BE-8915, BE-8920, BE-8925

7865



Fit&Go 3/3 Foam Inlay Automotive Pliers Set - 18 Pcs



FF1A72



38 x 445 x 543 mm

1 FF1A72

2101GC-160IP	
2430 GC-200 IP	
2630GC-180IP	
2800-180	
2890-180	
2900-180	
2953-200	
2990-180	
3640-200-C	
3734N-10-150, 3734N-2-150, 3734N-3-150, 3734N-4-150, 3734N-5-150, 3734N-6-150, 3734N-8-150	
479-16	
3625W-35	

Fit&Go 3/3 Foam Inlay Mixed Striking/
Cutting/ Pliers Set - 13 Pcs



FF1A154



37 x 445 x 543 mm

1 FF1A154

2171G-160	
224 D	
2470 G-160	
317	
3625W-28	
3733-4	
3734-3, 3734-6	
3735-5-120	
481-400	
KB18-01	
KSBG18-10DISPEN	
2678 G-180	

Fit&Go 3/3 Foam Inlay 1/4" & 1/2" Socket
Set, Spanners & Pliers - 50 pcs



FF1A164



40 x 445 x 543 mm

1 FF1A164

1RM-10, 1RM-11, 1RM-12, 1RM-13, 1RM-14, 1RM-15, 1RM-16, 1RM-17, 1RM-18, 1RM-19, 1RM-8	
2058-BR	
S330	
111M-24, 111M-21, 111M-27, 111M-32	

Fit&Go 3/3 Foam Inlay Pliers, L-Keys,
Magnetic Dish and Picking - 23 pcs



FF1A167



45 x 445 x 543 mm

1 FF1A167

1178-SCRIBE	
1419-MD	
2101G-160IP	
2430 G-190HD	
2628 G-180IP	
2744	
2953-250	
8224	
9031	
BE-9770	
BWSS12P317, BWSS12P319, BWSS12P321	
CR B 02	
2530	

Fit&Go 3/3 Foam Inlay Cutting Tools, Files
& Impact Driver Set - 13 pcs



FF1A169



35 x 445 x 543 mm

1 FF1A169

2681	
3625W-28	
3733-4	
3734-3, 3734-4, 3734-6	
3735-5-120	
481-400	
BB10	
BE66152	
BT10P330	
MA321	
MTB-3-16	

Fit&Go 3/3 Foam Inlay Cutting Tools, Files
& Impact Driver Set - 36 pcs



FF1A168



40 x 445 x 543 mm

1 FF1A168

1-100-08-2-2	
1-210-08-2-2	
1-230-08-2-2	
2485	
2487	
319	
268	
3740-100, 3740-150	
5515T	
782-U	
7865	
KB18-01	
KSBG18-10DISPEN	

Fit&Go 3/3 Foam Inlay Striking, Pliers, Cutting & Pick-Up Tool - 25 pcs



FF1A189

40 x 445 x 543 mm	1	FF1A189

3734S/6	
479-16	
3625W-35	
MTG-3-16	
KB18-01	
KSBG18-10DISPEN	
2101G-180IPD	
2630GC-180IP	
2470 G-200	
8224 IP	
2530	

Fit&Go 3/3 Foam Laser Marked Inlay Striking & Files - 40 pcs



FF1A204LM

40 x 445 x 543 mm	1	FF1A204LM

1-100-08-2-2	
1-170-08-2-2	
1-210-08-2-2	
1-230-08-2-2	
1435/5	
3734-2, 3734-3, 3734-4, 3734-5, 3734-6, 3734-8	
3735-4-120, 3735-5-120	
3740-150, 3740-250	
481-400	
7865	
3625N-32	
1418-4, 1418-5, 1418-6, 1418-7.5	

Fit&Go 3/3 Foam Laser Marked Inlay 1/2" Socket Set, 1/2" Impact Socket Set & Cutting - 56 pcs



FF1A208LM

45 x 445 x 543 mm	1	FF1A208LM

2744	
7809M-10, 7809M-12, 7809M-14, 7809M-4, 7809M-5, 7809M-6, 7809M-7, 7809M-8	
K7801M-13, K7801M-15, K7801M-16, K7801M-17, K7801M-18, K7801M-19, K7801M-21, K7801M-22, K7801M-24	
K8160D-2	
KBGU-10P-DISPEN	
KERU-01	
319	
K6650-1/2-1P	
S240	

Fit&Go 3/3 Foam Laser Marked Inlay 1/2" Impact Socket Set, Cutting & Measuring - 36 pcs



FF1A197LM

40 x 445 x 543 mm	1	FF1A197LM

1150-1/2H/P	
2744	
426TOR9	
K7801M-13, K7801M-15, K7801M-16, K7801M-17, K7801M-18, K7801M-19, K7801M-21, K7801M-22, K7801M-24	
K8160D-2	
K7806M-13, K7806M-14, K7806M-16, K7806M-17, K7806M-18, K7806M-19, K7806M-21, K7806M-22, K7806M-24	
KBGU-10P-DISPEN	
KERU-01	
MTC-5-16-C1	
325	
1544	

Fit&Go 3/3 Foam Laser Marked Inlay Awls, Hooks, Inspection Mirrors & Rivet Gun - 14 pcs



FF1A205LM

35 x 445 x 543 mm	1	FF1A205LM

2484-45	
2633/S4	
2951-180	
5515T	
BE66152	
BE-8986	
BT10P330	
2681	
1450D-ISO	
806-1-3	
5515FL	

Fit&Go 3/3 Foam Laser Marked Inlay ERGO™ Screwdrivers, Spanners & Pliers - 24 pcs



FF1A210LM

40 x 445 x 543 mm	1	FF1A210LM

1RM-10, 1RM-11, 1RM-12, 1RM-13, 1RM-14, 1RM-15, 1RM-16, 1RM-17, 1RM-18, 1RM-19, 1RM-8, 1RM-9	
1520 G	
2101G-160	
2430 G-190HD	
2628 G-180	
BE-8602	
BE-8611, BE-8621	
BE-8811, BE-8821	
BE-8802	
8224	
9031	



Fit&Go 3/3 Foam Laser Marked Inlay ERGO™ Screwdrivers, T-Handle Screwdrivers & L-Keys - 18 pcs



FF1A212LM

35 x 445 x 543 mm 1 FF1A212LM

1-100-08-2-2	
1-210-08-2-2	
1-230-08-2-2	
3734-2, 3734-3, 3734-4, 3734-5, 3734-6, 3734-8	
3735-4-120	
3740-150, 3740-250	
426TOR9	
481-400	
BE-8986	
MTC-5-16-C1	
2446	
3625N-32	

Fit&Go 3/3 Foam Laser Marked Inlay ERGO™ Screwdrivers & Combination Spanners - 31 pcs



FF1A215LM

40 x 445 x 543 mm 1 FF1A215LM

111M-10, 111M-11, 111M-12, 111M-13, 111M-14, 111M-15, 111M-16, 111M-17, 111M-18, 111M-19, 111M-20, 111M-21, 111M-22, 111M-24, 111M-8, 111M-9	
BE-8910, BE-8915, BE-8920, BE-8925, BE-8930	
BE-8020, BE-8040	
BE-8155	
BE-8355	
BE-8602	
BE-8611, BE-8621	
BE-8811, BE-8821	
BE-8802	

Fit&Go 3/3 Foam Laser Marked Inlay Striking, Cutting, Files & L-Keys - 36 pcs



FF1A216LM

40 x 445 x 543 mm 1 FF1A216LM

1-100-08-2-2	
1-210-08-2-2	
1-230-08-2-2	
3734-3, 3734-4, 3734-5	
3735-4-120	
481-400	
BE-8986	
BE-9770	
S4RM-8-11, S4RM-12-15, S4RM-16-19	
KB18-01	
KSBG18-10DISPEN	
MTG-3-16	
WR2-MM	
3740-200	
317	

Fit&Go 3/3 Foam Laser Marked Inlay Ratcheting Combination Spanner, Swivel Head Spanner & L-Keys Sets - 42 pcs



FF1A221LM

40 x 445 x 543 mm 1 FF1A221LM

1RM-10, 1RM-11, 1RM-12, 1RM-13, 1RM-14, 1RM-17, 1RM-19, 1RM-8	
2681	
4040M-10-11, 4040M-12-13, 4040M-14-15, 4040M-16-17, 4040M-18-19, 4040M-8-9	
8045LVDE	
806-1-1	
808050	
808050S	
9715-14-250	
BE-9575	
BE-9770	

Fit&Go 3/3 Foam Laser Marked Inlay ERGO™ Screwdrivers, Caliper, Bit Set & 1/2" Impact Socket Set - 65 pcs



FF1A222LM

45 x 445 x 543 mm 1 FF1A222LM

BE-7805, BE-7806, BE-7807, BE-7808, BE-7809, BE-7810, BE-7811, BE-7813, BE-7855	
D/S14	
K8160D-1, K8160D-2	
K8167S	
BE-8135TB, BE-8145TB, BE-8150TB, BE-8155TB	
BE-8610TB, BE-8620TB, BE-8623TB	
1150-1/2H/P	
59/S31B	

Fit&Go 3/3 Foam Laser Marked Inlay Striking, Cutting & Hose Clamp Set - 26 pcs



FF1A224LM

40 x 445 x 543 mm 1 FF1A224LM

1435/8	
319	
3625S-35	
3734S/6	
3735-5-150	
3740-200	
3750	
3906-300-24-2P	
479-16	
KBFU-01	
BE256P3	

Fit&Go 3/3 Foam Laser Marked Inlay Awls, Hooks, Scraper, Magnetic Pick Up Tool & Torx Bits Set - 60 pcs



FF1A225LM

40 x 445 x 543 mm 1 FF1A225LM

- 2487
- 2535F1
- 2633/S4
- 2485
- 782-U
- BE5049T
- BE66152
- 2484-45
- 5515T-52

Fit&Go 3/3 Foam Inlay Circlip Pliers & Spanners Set - 17 pcs



FF1A230

40 x 445 x 543 mm 1 FF1A230

- 1RM-9, 1RM-8, 1RM-11, 1RM-10, 1RM-13, 1RM-12, 1RM-15, 1RM-14, 1RM-17, 1RM-16, 1RM-19, 1RM-18
- 28-29/S4
- 8072 C

Fit&Go 3/3 Foam Laser Marked Inlay Spanners, Pliers & Sockets - 45 pcs



FF1A29NB

50 x 445 x 543 mm 6.26 kg 1 FF1A29NB

- 111M-6, 111M-7, 111M-8, 111M-9, 111M-13, 111M-12, 111M-11, 111M-10, 111M-24, 111M-22, 111M-17, 111M-16, 111M-15, 111M-14, 111M-21, 111M-19, 111M-18
- 8071 IP
- 2470 G-160
- 2971G-250
- 2171G-160
- 8150SL
- SBS83-10, SBS83-5
- SBS87S
- SBS85
- 7800SM-27, 7800SM-22, 7800SM-23, 7800SM-24, 7800SM-18, 7800SM-19, 7800SM-20, 7800SM-21, 7800SM-14, 7800SM-15, 7800SM-16, 7800SM-17, 7800SM-10, 7800SM-11, 7800SM-12, 7800SM-13, 7800SM-30, 7800SM-32

Fit&Go 3/3 Foam Laser Marked Inlay ERGO™ Screwdrivers, Ratchet, Sockets & Bit Set - 22 pcs

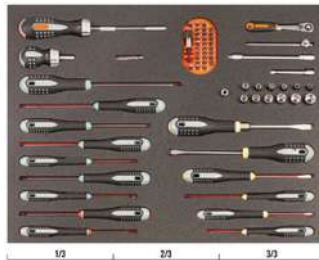

FF1A30NB

35 x 445 x 543 mm 2.8 kg 1 FF1A30NB

- BE-8020, BE-8030, BE-8040
- BE-8150, BE-8155
- BE-8160
- BE-8611, BE-8621
- BE-8811, BE-8821
- BE-8910, BE-8915, BE-8920, BE-8925, BE-8930
- 808050S
- 808050
- 6972H
- K6650-1/4-1P
- 6950SL
- 59S/31-1
- SBS64
- SB6963
- SBS60-4, SBS60-11, SBS60-12, SBS60-13, SBS60-7, SBS60-8, SBS60-9, SBS60-10, SBS60-4.5, SBS60-5, SBS60-5.5, SBS60-6

Fit&Go 3/3 Foam Laser Marked Inlay Striking, Cutting Tools, Files & L-Keys - 28 pcs



FF1A31NB

45 x 445 x 543 mm 2.69 kg 1 FF1A31NB

- 317
- 1-100-08-1-2
- 1-210-08-1-2
- 1-230-08-1-2
- MTB-3-16
- 3625W-35
- 481-300
- 782-U
- BE-9770
- KG09-01
- KSBG09-10DISPEN

Fit&Go 3/3 Foam Inlay Striking, Cutting, Pliers & Measuring Tape - 25 pcs



FF1A82

43 x 445 x 543 mm 1 FF1A82

- 3734S/6
- 479-16
- 3625W-35
- MTG-3-16
- KB18-01
- KSBG18-10DISPEN
- 2101G-180IP
- 2678 G-180
- 2470 G-200
- 720031
- 8224 IP



APPLICATION TOOLKITS

53" Tool Trolley General Purpose Tool Kit
- 488 Pcs



XXL



986 x 501 x 1430 mm



1 XXL

1476KXXL7BK	
2058-BR	
6700SM-10, 6700SM-11, 6700SM-12, 6700SM-13, 6700SM-14, 6700SM-4, 6700SM-4.5, 6700SM-5, 6700SM-5.5, 6700SM-6, 6700SM-7, 6700SM-8, 6700SM-9	
6700TORX-E10, 6700TORX-E4, 6700TORX-E5, 6700TORX-E6, 6700TORX-E7, 6700TORX-E8	
6950SL	
6954	
6956	
6960, 6962, 6962L	
6963	
6966	
696EX-11	
6972H	
7400SM-10, 7400SM-11, 7400SM-12, 7400SM-13, 7400SM-14, 7400SM-15, 7400SM-16, 7400SM-17, 7400SM-18, 7400SM-19, 7400SM-20, 7400SM-21, 7400SM-22, 7400SM-6, 7400SM-7, 7400SM-8, 7400SM-9	
7400TORX-E10, 7400TORX-E11, 7400TORX-E12, 7400TORX-E14, 7400TORX-E16, 7400TORX-E18, 7400TORX-E8	
7406ZZ-16, 7406ZZ-21	
7409BH-10, 7409BH-4, 7409BH-5, 7409BH-6, 7409BH-8	
7409F-10, 7409F-6.5, 7409F-8	
7409TORX-R-T27, 7409TORX-R-T30, 7409TORX-R-T40, 7409TORX-R-T45, 7409TORX-R-T50	
7409TORX-T25, 7409TORX-T27, 7409TORX-T30, 7409TORX-T40, 7409TORX-T45, 7409TORX-T50	
7750SL	
7757	
7758	
7759	
7760	
7761-W	
7764	

7765	
7766	
7767	
776EX-11	
7800SM-10, 7800SM-11, 7800SM-12, 7800SM-13, 7800SM-14, 7800SM-15, 7800SM-16, 7800SM-17, 7800SM-18, 7800SM-19, 7800SM-20, 7800SM-21, 7800SM-22, 7800SM-23, 7800SM-24, 7800SM-25, 7800SM-26, 7800SM-27, 7800SM-28, 7800SM-29, 7800SM-30, 7800SM-32, 7800SM-33, 7800SM-34, 7800SM-36, 7800SM-8, 7800SM-9	
7800TORX-E10, 7800TORX-E11, 7800TORX-E12, 7800TORX-E14, 7800TORX-E16, 7800TORX-E18, 7800TORX-E20, 7800TORX-E24, 7800TORX-E8	
7805SM-10, 7805SM-12, 7805SM-13, 7805SM-14, 7805SM-15, 7805SM-16, 7805SM-17, 7805SM-18, 7805SM-19, 7805SM-20, 7805SM-21, 7805SM-22, 7805SM-23, 7805SM-24, 7805SM-25, 7805SM-26, 7805SM-27, 7805SM-28, 7805SM-29, 7805SM-30, 7805SM-32	
7809M-10, 7809M-12, 7809M-14, 7809M-4, 7809M-5, 7809M-6, 7809M-7, 7809M-8	
7809M-10-140, 7809M-5-100, 7809M-6-100, 7809M-7-100, 7809M-8-120	
7809XZN-10, 7809XZN-10-100, 7809XZN-12, 7809XZN-12-100, 7809XZN-14, 7809XZN-14-100, 7809XZN-16, 7809XZN-18, 7809XZN-6, 7809XZN-8, 7809XZN-8-100	
8150SL	
8160-3, 8160-5	
8160W-10	
8164-1/2	
8171	
8166	
8167	
A6800DM-10, A6800DM-11, A6800DM-12, A6800DM-13, A6800DM-14, A6800DM-4, A6800DM-5, A6800DM-5.5, A6800DM-6, A6800DM-7, A6800DM-8, A6800DM-9	
A7402DM-10, A7402DM-11, A7402DM-12, A7402DM-13, A7402DM-14, A7402DM-15, A7402DM-16, A7402DM-17, A7402DM-18, A7402DM-19, A7402DM-21, A7402DM-7, A7402DM-8, A7402DM-9	
K6625-1/4-1P	
K6650-1/2-1P, K6650-1/4-1P, K6650-3/8-1P	
2101G-160	
2421 G-140IP, 2421 G-180	
2427 G-200	
2430 G-160	
2628 G-180	
2800-140, 2800-180, 2800-225	
2890-125, 2890-180, 2890-210	
2900-140, 2900-180, 2900-215	
2951-250	
2952-165	
2990-140, 2990-180, 2990-200	
3416 A	
4130	
7224	
BE256-155, BE256-178, BE256-250	

BLTS7P	
CR W 01	
1150-1/2H/P	
1544	
2633/S4x 4	
59/S100BCx 100	
806-1-3	
808050L	
BE-7607	
BE-8020L	
BE-8155TB, BE-8256TB, BE-8258TB	
BE-8355	
BE-8600	
BE-8602	
BE-8610TB, BE-8620TB, BE-8623TB, BE-8624TB	
BE-8802	
BE-8810TB, BE-8820TB, BE-8823TB, BE-8824TB	
BE-8907, BE-8908, BE-8909, BE-8910, BE-8915, BE-8920, BE-8925, BE-8927, BE-8930, BE-8940	
BE-8986	
BE-9770x 9	
BE-9785x 13	
MTC-5-16-C1	
1-170-08-2-2	
1-210-08-2-2	
1-230-08-2-2	
208	
2484T-30, 2484T-60	
2509	
2535L	
319	
3625N-32	
3681-16	
3734-2, 3734-3, 3734-4, 3734-5, 3734-6, 3734-8	
3735-4-120, 3735-5-120	
3740-150, 3740-250	
3906-300-32-5Px 5	
479-08	
481-1000, 481-400	
5515T	
782-U	
KBGU-5P-DISPENx 5	
KERU-01	
111M-10, 111M-11, 111M-12, 111M-13, 111M-14, 111M-15, 111M-16, 111M-17, 111M-18, 111M-19, 111M-20, 111M-21, 111M-22, 111M-23, 111M-24, 111M-25, 111M-26, 111M-27, 111M-28, 111M-29, 111M-30, 111M-32, 111M-33, 111M-34, 111M-36, 111M-6, 111M-7, 111M-8, 111M-9	
1RM-10, 1RM-11, 1RM-12, 1RM-13, 1RM-14, 1RM-15, 1RM-16, 1RM-17, 1RM-18, 1RM-19, 1RM-21, 1RM-22, 1RM-24, 1RM-27, 1RM-30, 1RM-32, 1RM-6, 1RM-7, 1RM-8, 1RM-9	
4040M-10-11, 4040M-12-13, 4040M-14-15, 4040M-16-17, 4040M-18-19, 4040M-8-9	
8069, 8071, 8073	

Tool Trolley General Purpose Tool Kit - 758 pcs



MONSTER



1370 x 501 x 1100 mm



1 MONSTER

FF1BSET-MONSTER

Tool Trolley General Purpose Tool Kit - 346 pcs



LARGE



952 x 510 x 782 mm



1 LARGE

FF1ASET-LARGE

Tool Trolley General Purpose Tool Kit - 560 pcs



XLARGE



1360 x 510 x 820 mm



1 XLARGE

FF1ASET-XLARGE

Tool Trolley General Purpose Tool Kit - 158 pcs



BASIC1



952 x 510 x 782 mm



1 BASIC

FF1ASET-BASIC

Tool Trolley General Purpose Tool Kit - 210 pcs



1475KXL6CBK-FF5



986 x 501 x 1100 mm



1 1475KXL6CBK-FF5

FF1A48



FF1A49



FF1A50



FF1A51



FF1A213



FF1A53



Tool Trolley General Purpose Tool Kit - 187 pcs



1475KXL6CBK-FF6



986 x 501 x 1100 mm



1 1475KXL6CBK-FF6

FF1A65



FF1A66



FF1A67



FF1A68



FF1A194



1 m Metal Wall Display General Purpose Tool Kit - 768 pcs



BAHCO-1MW-1



2250 x 520 x 1025 mm

1 BAHCO-1MW-1

111M-8x 10, 111M-10x 10, 111M-12x 10, 111M-11x 10, 111M-14x 10, 111M-13x 10, 111M-16x 10, 111M-17x 10, 111M-19x 10, 111M-22x 5, 111M-24x 5, 111M-27x 5, 111M-30x 5, 111M-32x 5

8072 Cx 5, 8073 Cx 5

2101G-160x 5

21HDG-180x 5

2628 G-200x 5

2430 G-200x 5

2427 G-200x 5

2223 G-150x 5

8224x 5

2101S-160x 3

2628 S-180x 3

2430 S-200x 3

2997-300x 5

28M-8x 5, 28M-10x 5, 28M-27x 3, 28M-30x 2, 28M-32x 2, 28M-20x 3, 28M-19x 3, 28M-22x 3, 28M-24x 3, 28M-12x 5, 28M-11x 5, 28M-14x 5, 28M-13x 5, 28M-16x 5, 28M-17x 5

S240x 4

B190.055.125x 10, B190.100.200x 10, B190.065.150x 10

B191.030.075x 10, B191.040.100x 10

B192.001.100x 10, B192.003.150x 10, B192.002.125x 10

B193.001.100x 10, B193.002.125x 10

B196.040.100x 10, B196.055.125x 10, B196.030.100x 10

B197.002.100x 10, B197.001.080x 10

806-1-1x 6

BE-9578x 4

BE-9678x 4

BE-9575x 4

B219.017x 4

B220.007x 4

482-40x 6

483-25x 6

3625S-35x 6

319x 5

3906-300-24-100x 100

MEE-SIGN-CARR-B

MEE-1S2L-B-I

MEE-ACCSS-005x 60

MEE-ACCSS-004x 10

MEE-ACCSS-009x 20

MEE-ACCSS-011x 3

1500 mm Tool Cabinets with Shutter General Purpose Toolkit - 110 Pcs



1495CS15TS1



900 x 170 x 1500 mm

1 1495CS15TS1

1495CS15

981001100

1495CS-AC1

1495TP-AC10

1800 mm Tool Cabinets with Shutter General Purpose Toolkit - 110 Pcs

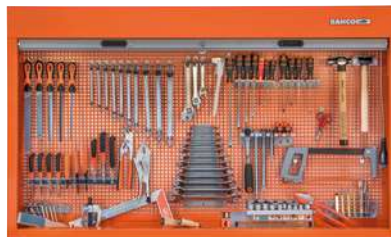

1495CS18TS1



900 x 170 x 1800 mm

1 1495CS18TS1

1495CS18

981001100

1495CS-AC1

1495TP-AC10

Tool Cabinets with 2 Doors General Purpose Toolkit - 110 Pcs



1495CD60TS1



900 x 250 x 602 mm

1 1495CD60TS1

1495CD60

981001100

1495CD-AC1

1495TP-AC10

Heavy Duty Rigid Case General Purpose Toolkit - 162 Pcs



4750RCWD4FF1



453 x 340 x 575 mm

1 4750RCWD4FF1

4750RCWD4

6700SM-10, 6700SM-9, 6700SM-12, 6700SM-11, 6700SM-6, 6700SM-8, 6700SM-7, 6700SM-13

A6800DM-13, A6800DM-12, A6800DM-9, A6800DM-8, A6800DM-11, A6800DM-10, A6800DM-5.5, A6800DM-7, A6800DM-6

6709M-3, 6709M-8, 6709M-6, 6709M-5, 6709M-4

6709PH-1, 6709PH-3, 6709PH-2

6709TORX-T30, 6709TORX-T27, 6709TORX-T40, 6709TORX-T15, 6709TORX-T10, 6709TORX-T25, 6709TORX-T20, 6709TORX-T9, 6709TORX-T8

6950SL

6954

6956

6958

6960, 6962, 6962L

6966

6972H

7764

7800SM-25, 7800SM-24, 7800SM-27,
7800SM-26, 7800SM-21, 7800SM-23,
7800SM-22, 7800SM-17, 7800SM-16,
7800SM-19, 7800SM-18, 7800SM-13,
7800SM-12, 7800SM-15, 7800SM-14,
7800SM-9, 7800SM-8, 7800SM-11,
7800SM-10, 7800SM-28, 7800SM-32,
7800SM-30

7809TORX-T45, 7809TORX-T25,
7809TORX-T50, 7809TORX-T30,
7809TORX-T27, 7809TORX-T40

8150RN-1/2

111M-30, 111M-32, 111M-27, 111M-29,
111M-24, 111M-19, 111M-18, 111M-21,
111M-15, 111M-14, 111M-17, 111M-16,
111M-11, 111M-10, 111M-13, 111M-12,
111M-7, 111M-6, 111M-9, 111M-8

9070C

BE-9770

2058-BR

1544

MTB-3-16

2101G-160IP

2427 G-200 IP

2430 G-200 IP

2628 G-160IP

8224 IP

1150-1/2H/P

5515T-52

2820EF2

481-300

3625W-35

3734-3, 3734-5, 3734-8

3735-4-120

1177-SCRIBE

8160-3, 8160-5, 8160-10

8166

8157-15

8154-11

Heavy Duty Rigid Case General Purpose Toolkit - 194 Pcs



4750RCHDW01FF3

250 x 345 x 545 mm 1 4750RCHDW01FF3

4750RCHDW01	
FF2B12	
FF2B13	
FF2B14	
FF2B15	
FF2B16	

Heavy Duty Rigid Case Insulated Tool Kit - 79 pcs



4750RCHDW02RF1V

290 x 480 x 630 mm 1 4750RCHDW02RF1V

4750RCHDW02RED	
8150-1/2V	1000 V IEC60900
BMMTRMS1	
28MV-10, 28MV-15, 28MV-16, 28MV-21, 28MV-22, 28MV-12, 28MV-13	1000 V IEC60900
2101S-160, 2101S-180	1000 V IEC60900
2101S-200	1000 V IEC60900
2223 S-150	1000 V IEC60900
2820VDE	1000 V IEC60900
BE-8040S, BE-8050S, BE-8010S, BE-8065S	1000 V IEC60900
BE-8703S, BE-8704S, BE-8725S, BE-8705S, BE-8706S, BE-8708S	1000 V IEC60900
BE-8910S, BE-8915S, BE-8920S, BE-8925S, BE-8930S	1000 V IEC60900
SC127V	1000 V IEC60900
1999MV-5, 1999MV-6, 1999MV-7, 1999MV-8, 1999MV-9, 1999MV-10, 1999MV-12	1000 V IEC60900
2430V-160, 2430V-200	1000 V IEC60900
2678V-180, 2678V-160, 2678V-200	1000 V IEC60900
3416 A	
806-1-1	
BE-8600S, BE-8610S, BE-8620S, BE-8630S, BE-8640S	1000 V IEC60900
527V-160	1000 V IEC60900
2427V-200	1000 V IEC60900
2MV-10, 2MV-11, 2MV-12, 2MV-13, 2MV-14, 2MV-15, 2MV-16, 2MV-17, 2MV-18, 2MV-19	1000 V IEC60900
WR1-MM	
7800DMV-8, 7800DMV-10, 7800DMV-11, 7800DMV-12, 7800DMV-13, 7800DMV-14, 7800DMV-15, 7800DMV-16, 7800DMV-17, 7800DMV-18, 7800DMV-19, 7800DMV-20, 7800DMV-21, 7800DMV-22	1000 V IEC60900
2820VPC	1000 V IEC60900
8162-1/2V	1000 V IEC60900
7224S	1000 V IEC60900

Metallic Tool Box General Purpose Toolkit - 193 Pcs



1483KHD3RB-FF3

335 x 260 x 565 mm 1 1483KHD3RB-FF3

1483KHD3RB	
FF3A09	
FF3A10	
FF3A11	
FF3A12	

Metallic Tool Box General Purpose Toolkit - 146 Pcs



1483KHD3RB-FF4

335 x 260 x 565 mm 1 1483KHD3RB-FF4

1483KHD3RB	
FF3A10	
FF3A11	
FF3A12	
FF3A13	



Aluminium Tool Box General Purpose Toolkit, 145pcs



4750ALC01FF1



160 x 320 x 450 mm

1 4750ALC01FF1

111M-14, 111M-15, 111M-16, 111M-17, 111M-18, 111M-19, 111M-8, 111M-9, 111M-10, 111M-11, 111M-12, 111M-13	
BE-9678	
8072 C IP	
224 D	
2171G-160	
2339-220IP	
2678 G-180	
2470 G-160	
SCB140	
B191.030.075, B191.040.125	
B190.055.125, B190.065.150	
B192.001.100, B192.002.125	
806-1-1	
482F-30	
MTB-5-25	
208	
KB18-01	
808050TS	
59S/0.6-4.5-3P, 59S/1.0-5.5-3P, 59S/1.2-6.5-3P	
59S/PH1-3P, 59S/PH2-3P, 59S/PH3-3P, 59S/PH0-3P	
59S/PH2G-3P	
59S/PZ2-3P, 59S/PZ3-3P, 59S/PZ0-3P, 59S/PZ1-3P	
66IM/T20C-2P, 66IM/T15C-2P, 66IM/T10C-2P, 66IM/T40C-2P, 66IM/T30C-2P, 66IM/T27C-2P, 66IM/T25C-2P	
59S/H1.5-3P, 59S/H3-3P, 59S/H2.5-3P, 59S/H4-3P, 59S/H5-3P, 59S/H2-3P, 59S/H6-3P, 59S/H8-3P	
KM6750-11, KM6750-6, KM6750-7, KM6750-8, KM6750-10, KM6750-13	
K6650-1/4-1P	
KM653-1P	
KSBG18-10DISPEN	
700-1.5-50, 700-1.2-50, 700-1-50, 700-1.8-50	
701-00-50, 701-0-50	

3906-250-24-5P, 3906-250-32-5P	
3735N-4-120	
3734N-2-150, 3734N-4-150, 3734N-6-150	
SBS60-9, SBS60-10, SBS60-11, SBS60-12, SBS60-13, SBS60-4, SBS60-4.5, SBS60-5, SBS60-5.5, SBS60-6, SBS60-7, SBS60-8	
SBS61	
SB6963	
SBS64	
8160-10, 8160-5	
8158-10	
7800SM-20, 7800SM-21, 7800SM-22, 7800SM-23, 7800SM-24, 7800SM-27, 7800SM-12, 7800SM-13, 7800SM-14, 7800SM-15, 7800SM-16, 7800SM-17, 7800SM-18, 7800SM-19, 7800SM-10, 7800SM-11, 7800SM-30, 7800SM-32	
SBS81	
8166	
7772H	

Leather Bag General Purpose Toolkit - 32 Pcs



982000320



280 x 200 x 435 mm

1 982000320

4750-FOLTC-1	
2101D-160IP	
224 D	
2630D-180	
2430 D-160 IP	
8071 C IP	
483-20	
6M/8C	
541D-180	
2951-180	
B191.030.075, B191.040.100	
B190.100.200, B190.065.150	
B192.001.100, B192.002.125	
SC127	
2820EF2	
BE-9777	
MTB-3-16	

Plastic Case General Purpose Toolkit - 32 Pcs



983000320



162 x 380 x 435 mm

1 983000320

4750RC01	
2101D-160IP	
224 D	
2630D-180	
2430 D-160 IP	
8071 C IP	
483-20	
541D-180	
2951-180	
6M/8C	
B191.030.075, B191.040.100	
B190.100.200, B190.065.125	
B192.001.100, B192.002.125	
SC127	
2820EF2	
BE-9777	
MTB-3-16	

Rigid Case General Purpose Toolkit - 32 Pcs



983100320



210 x 415 x 460 mm

1 983100320

4750RC02	
2101D-160IP	
224 D	
2430 D-160 IP	
8071 C IP	
483-20	
541D-180	
2951-180	
B191.030.075, B191.040.100	
B190.100.200, B190.065.150	
B192.001.100, B192.002.125	
SC127	
2820EF2	
BE-9777	
MTB-3-16	
2630DC-180IP	
6M/8C	

Leather Bag General Purpose Toolkit - 34 Pcs



982000350

280 x 200 x 440 mm 1 982000350

4750-FOLTC-1	
2101GC-160IP	
2630GC-180IP	
2900-180	
2800-180	
1998M/10T	
8072 C IP	
2951-250	
B190.100.200, B190.065.150, B190.040.100	
B192.001.100, B192.002.125	
SC127	
6M/8C	
479-16	
2430 GC-200 IP	
1-110-08-2-2	
6224	

Zipper Wallet General Purpose Toolkit - 7 Pcs



9848

50 x 275 x 330 mm 1 9848

8160		
7890		
8070		
BE-8020, BE-8040		
BE-8610		
TL AA-SA-SL		

Wheeled Rigid Case General Purpose Toolkit - 32 Pcs



984010320

255 x 390 x 465 mm 1 984010320

4750RCW01	
2101D-160IP	
224 D	
2630D-180	
2430 D-160 IP	
6M/8C	
8071 C IP	
483-20	
541D-180	
2951-180	
B191.030.075, B191.040.100	
B190.100.200, B190.065.150	
B192.001.100, B192.002.125	
SC127	
2820EF2	
BE-9777	
MTB-3-16	

Mini Folder Case General Purpose Toolkit - 36 Pcs



4750FB5ATS001

275 mm 170 mm 1 4750FB5ATS001

4750FB5A	
2058/S26	
808050	
8070	
2101G-160	
2628 G-180	

Fabric tool folder with foam, 51 pcs



4750FB5BFF1

62 x 275 x 330 mm 1 4750FB5BFF1

4750FB5B	
808050P	
MTB-5-25	
2101G-160	
2628 G-180	
BE-9578	
9070	
59/S31B	



Plastic Tool Box General Purpose Tool Kit - 37 pcs



4750PTB65TS5



285 x 300 x 650 mm

1 4750PTB65TS5

2430 D-140 IP	
2630D-160	
MT-TS-3	
9572	
BE-9884	
2446	
SL25	
427-16	

Cantilever Metallic Box with Foams General Purpose Tool Kit - 69 pcs



3149-ORFF1



220 x 220 x 560 mm

1 3149-ORFF1

111M-19, 111M-18, 111M-17, 111M-16, 111M-15, 111M-14, 111M-13, 111M-12, 111M-11, 111M-10, 111M-8, 111M-9	
2953-250	
224 D	
2171G-160	
2470 G-200	
BE-9770	
611-3.5-75, 611-5.5-125, 611-6.5-150	
613-3-100, 613-4-125	
615-2-25, 615-1-100, 615-2-125, 615-3-150	
KBSK-01	
MTG-5-19-E	
482-30	
3625W-28	
3745-150	

3740-150	
3734-3, 3734-5	
3735-5-120	
3149-OR	
2678 G-200	
8160-10, 8160-5	
8158-10	
SBS81	
8166	
7772H	
7800SM-15, 7800SM-16, 7800SM-13, 7800SM-14, 7800SM-19, 7800SM-20, 7800SM-17, 7800SM-18, 7800SM-23, 7800SM-24, 7800SM-21, 7800SM-22, 7800SM-27, 7800SM-32, 7800SM-30, 7800SM-11, 7800SM-12, 7800SM-10	

Cantilever Metallic Box General Purpose Tool Kit - 69 pcs



3149-ORTS1



220 x 220 x 560 mm

1 3149-ORTS1

111M-19, 111M-18, 111M-17, 111M-16, 111M-15, 111M-14, 111M-13, 111M-12, 111M-11, 111M-10, 111M-9, 111M-8	
S240	
2953-250	
224 D	
2171G-160	
2678 G-200	
2470 G-200	
BE-9770	
611-3.5-75, 611-5.5-125, 611-6.5-150	
613-3-100, 613-4-125	
615-2-25, 615-1-100, 615-2-125, 615-3-150	
KBSK-01	
MTG-5-19-E	
482-30	
3625W-28	
3745-150	
3740-150	
3734-3, 3734-5	
3735-5-120	
3149-OR	

General Purpose 11 Foam Tool Kit - 758 pcs



FF1BSET-MONSTER



40 x 445 x 880 mm

1 FF1BSET-MONSTER

FF1B01LM	
FF1B02LM	
FF1B03LM	
FF1B04LM	
FF1B05LM	
FF1B10LM	
FF1B11LM	
FF1B08LM	
FF1B09LM	
FF1B06LM	
FF1B07LM	

General Purpose 12 Foam Tool Kit - 560 pcs



FF1ASET-XLARGE



40 x 543 x 445 mm

1 FF1ASET-XLARGE

FF1A195LM	
FF1A196LM	
FF1A197LM	
FF1A198LM	
FF1A199LM	

FF1A200LM	
FF1A201LM	
FF1A202LM	
FF1A203LM	
FF1A204LM	
FF1A205LM	
FF1A206LM	

General Purpose 6 Foam Tool Kit - 346 pcs



FF1ASET-LARGE

40 x 543 x 445 mm	1 FF1ASET-LARGE

FF1A207LM	
FF1A208LM	
FF1A209LM	
FF1A210LM	
FF1A211LM	
FF1A212LM	

General Purpose 3 Foam Tool Kit - 158 pcs



FF1ASET-BASIC

40 x 543 x 445 mm	1 FF1ASET-BASIC

FF1A214LM	
FF1A215LM	
FF1A216LM	

Foam Inlay for 40" Trolley 1/4" Metric & Imperial Socket Sets - 141 pcs



FF1B01LM

35 x 445 x 880 mm	1 FF1B01LM

6700SM-10, 6700SM-11, 6700SM-12, 6700SM-13, 6700SM-14, 6700SM-4, 6700SM-4.5, 6700SM-5, 6700SM-5.5, 6700SM-6, 6700SM-7, 6700SM-8, 6700SM-9		
6700SZ-1/2, 6700SZ-1/8, 6700SZ-9/16, 6700SZ-1/4, 6700SZ-11/32, 6700SZ-3/16, 6700SZ-3/8, 6700SZ-5/16, 6700SZ-7/16, 6700SZ-7/32, 6700SZ-9/32, 6700SZ-5/32		
6700TORX-E4, 6700TORX-E5, 6700TORX-E6, 6700TORX-E7, 6700TORX-E8, 6700TORX-E10		

6950SL	
6962L, 6960, 6961	
6972H	

7400SM-10, 7400SM-11, 7400SM-12, 7400SM-13, 7400SM-14, 7400SM-15, 7400SM-16, 7400SM-17, 7400SM-18, 7400SM-19, 7400SM-20, 7400SM-21, 7400SM-22, 7400SM-6, 7400SM-7, 7400SM-8, 7400SM-9		
---	--	--

7400TORX-E10, 7400TORX-E11, 7400TORX-E12, 7400TORX-E14, 7400TORX-E16, 7400TORX-E18		
7406ZZ-16, 7406ZZ-21		

7409TORX-R-T27, 7409TORX-R-T30, 7409TORX-R-T40, 7409TORX-R-T45, 7409TORX-R-T50		
--	--	--

7409TORX-T25, 7409TORX-T27, 7409TORX-T30, 7409TORX-T40, 7409TORX-T45, 7409TORX-T50		
--	--	--

7750SL	
2058-BR	
8164-1/2	

A6800DM-10, A6800DM-12, A6800DM-13, A6800DM-4, A6800DM-5, A6800DM-5.5, A6800DM-6, A6800DM-7, A6800DM-8, A6800DM-9, A6800DM-11, A6800DM-14		
---	--	--

A6800DZ-9/16, A6800DZ-1/2, A6800DZ-1/4, A6800DZ-11/32, A6800DZ-3/16, A6800DZ-3/8, A6800DZ-5/16, A6800DZ-7/16, A6800DZ-7/32, A6800DZ-9/32		
--	--	--

A7400DZ-1/2, A7400DZ-11/16, A7400DZ-3/4, A7400DZ-3/8, A7400DZ-5/8, A7400DZ-7/16, A7400DZ-17/32, A7400DZ-9/16, A7400DZ-19/32, A7400DZ-13/16, A7400DZ-7/8, A7400DZ-1/4, A7400DZ-5/16		
--	--	--

K6650-1/4-1P, K6650-3/8-1P	
K6625-1/4-1P	

6954	
6956	

6963	
6966	
7760, 7761, 7762	
7764	
7765	
7766	
7409BH-4, 7409BH-5, 7409BH-6, 7409BH-8, 7409BH-10	
A7402DM-10, A7402DM-11, A7402DM-12, A7402DM-13, A7402DM-14, A7402DM-15, A7402DM-16, A7402DM-17, A7402DM-18, A7402DM-19, A7402DM-8, A7402DM-9	
7756	

Foam Inlay for 40" Trolley 1/2" Metric & Imperial Socket Sets - 76 pcs



FF1B02LM

40 x 445 x 880 mm	1 FF1B02LM

7800DM-10, 7800DM-11, 7800DM-12, 7800DM-13, 7800DM-14, 7800DM-15, 7800DM-16, 7800DM-17, 7800DM-18, 7800DM-19, 7800DM-20, 7800DM-21, 7800DM-22, 7800DM-24, 7800DM-27, 7800DM-30, 7800DM-32, 7800DM-34, 7800DM-36		
---	--	--

7800DZ-1, 7800DZ-1.1/16, 7800DZ-1.1/4, 7800DZ-1.1/8, 7800DZ-1.3/16, 7800DZ-1/2, 7800DZ-11/16, 7800DZ-13/16, 7800DZ-15/16, 7800DZ-25/32, 7800DZ-3/4, 7800DZ-3/8, 7800DZ-5/8, 7800DZ-7/16, 7800DZ-7/8, 7800DZ-9/16, 7800DZ-19/32		
--	--	--

7809M-10, 7809M-12, 7809M-14, 7809M-4, 7809M-5, 7809M-6, 7809M-7, 7809M-8		
---	--	--

8150SL	
SBS87	

K7801M-13, K7801M-15, K7801M-16, K7801M-17, K7801M-18, K7801M-19, K7801M-21, K7801M-22, K7801M-24		
---	--	--

K8160D-2		
K7806M-13, K7806M-14, K7806M-16, K7806M-17, K7806M-18, K7806M-19, K7806M-21, K7806M-22, K7806M-24		

7809M-5-100, 7809M-6-100, 7809M-7-100, 7809M-8-120, 7809M-10-140	
--	--

K6650-1/2-1P	
8160-3, 8160-5, 8160-10	

8171	
8166	



Foam Inlay for 40" Trolley Combination Spanner & Ratcheting Spanner Sets - 36 pcs



FF1B03LM



35 x 445 x 880 mm

1 FF1B03LM

111M-10, 111M-11, 111M-12, 111M-13, 111M-14, 111M-15, 111M-16, 111M-17, 111M-18, 111M-19, 111M-20, 111M-21, 111M-22, 111M-24, 111M-27, 111M-30, 111M-32, 111M-34, 111M-8, 111M-9



1RM-10, 1RM-11, 1RM-12, 1RM-13, 1RM-14, 1RM-15, 1RM-16, 1RM-17, 1RM-18, 1RM-19, 1RM-21, 1RM-22, 1RM-24, 1RM-27, 1RM-8, 1RM-9



Foam Inlay for 40" Trolley Combination Spanner, Flex-Head Spanners & Telescopic Mirror - 26 pcs



FF1B04LM



35 x 445 x 880 mm

1 FF1B04LM

1RM-30, 1RM-32



111Z-1, 111Z-1.1/16, 111Z-1.1/4, 111Z-1.1/8, 111Z-1/2, 111Z-11/16, 111Z-13/16, 111Z-15/16, 111Z-3/4, 111Z-3/8, 111Z-5/16, 111Z-5/8, 111Z-7/16, 111Z-7/8, 111Z-9/16



4040M-10-11, 4040M-12-13, 4040M-14-15, 4040M-16-17, 4040M-18-19, 4040M-8-9



5515T



BLTS7P



2535L



Foam Inlay for 40" Trolley Pliers, Compact Pliers, Spanners & Calipers - 32 pcs



FF1B05LM



35 x 445 x 880 mm

1 FF1B05LM

1150-1/2H/P



1520 G



1620



2101S-160



21HDG-160



2223 S-150



2430 G-160



2430 S-200



2628 G-180



2628 S-180



2744



426TOR9



KBGU-10P-DISPEN



KERU-01



MTC-5-16-C1



8224



9029, 9031



806-1-3



C3330R



C3530



C3230



C3640



Foam Inlay for 40" Trolley ERGO™ Insulated and Precision Screwdriver Sets - 88 pcs



700-2.5-50, 700-2-50, 700-3-50		
701-00-50, 701-0-50, 701-1-75		
703-10-50, 703-15-75, 703-6-50, 703-7-50, 703-8-50, 703-9-50		
808050L		
BE-8010S		
BE-8020, BE-8040		
BE-8040SL, BE-8050SL		
BE-8150, BE-8155, BE-8256		
BE-8355		
BE-8600, BE-8611, BE-8621, BE-8623		
BE-8600S		
BE-8602		
BE-8610SL, BE-8620SL		
BE-8702, BE-8725		
BE-8820SL		
BE-8870		
BE-8975B		
BE-9777B		
BE-9787		
BE-9770		
BE-9785		

Foam Inlay for 40" Trolley ERGO™ Screwdrivers & Bit Sets - 169 pcs



FF1B07LM



40 x 445 x 880 mm

1 FF1B07LM

BE-8256TB, BE-8258TB



BE-8620TB, BE-8623TB



59/S100BC



7455-200



BE-8907, BE-8908, BE-8909, BE-8910, BE-8915, BE-8920, BE-8925, BE-8927, BE-8930, BE-8940



BE-8811, BE-8821



BE-8830



BE-8802



BE5049T



BE-7607



FF1B06LM



40 x 445 x 880 mm

1 FF1B06LM



Foam Inlay for 40" Trolley Striking, Filing & Extracting Sets - 45 pcs



FF1B08LM



40 x 445 x 880 mm

1 FF1B08LM

1-100-08-2-2	
1-170-08-2-2	
1-210-08-2-2	
1-230-08-2-2	
1435/5	
2484-30, 2484-45, 2484-60	
3734-2, 3734-3, 3734-4, 3734-5, 3734-6, 3734-8	
3735-4-120, 3735-5-120	
3740-150, 3740-250	
4543-3	
4611-3	
481-400	
7865	
3625N-32	
1418-4, 1418-5, 1418-6, 1418-7.5	

Foam Inlay for 40" Trolley Hexagonal T-Handle, Multi-Position Pry Bars & Feeler Gauges Sets - 21 pcs



FF1B09LM



35 x 445 x 880 mm

1 FF1B09LM

900T-025-100, 900T-030-100, 900T-040-150, 900T-050-150, 900T-060-200, 900T-080-200		
901T-010-100, 901T-015-150, 901T-020-150, 901T-025-150, 901T-027-150, 901T-030-200, 901T-040-200		
BE256-155, BE256-178, BE256-250		
BE66152		
BT10P325, BT10P330, BT10P338		
1544		

Foam Inlay for 40" Trolley Hand Hacksaw, Circlip Pliers & Grips - 20 pcs



FF1B10LM



45 x 445 x 880 mm

1 FF1B10LM

2633/S4	
2800-140, 2800-180	
2890-125, 2890-180	
2900-140, 2900-180	
2951-180	
2952-165	
2963-280	
2965-200	
2990-125, 2990-180	
BE-8986	
325	
2681	
CR B 02	

Foam Inlay for 40" Trolley Metal Clips for 1/4", 3/8", 1/2" Sockets & 3/4" Sockets Set - 104 pcs



FF1B11LM



50 x 445 x 880 mm

1 FF1B11LM

RAIL-264	
CLIPS-1/4	
CLIPS-3/8	
CLIPS-1/2	
SLX 17	

Foam Inlay Imperial Toolset for our metallic cases 1483K & 1483KHD Series - 79 Pcs



FF3A01



64 x 245 x 505 mm

1 FF3A01

A6700DZ-1/2, A6700DZ-1/4, A6700DZ-11/32, A6700DZ-3/8, A6700DZ-5/16, A6700DZ-7/16, A6700DZ-7/32, A6700DZ-9/32		
A6710DZ-3/8, A6710DZ-5/16, A6710DZ-7/16		
A6800DZ-1/4, A6800DZ-5/16, A6800DZ-7/32, A6800DZ-9/32		
A7400DM-10, A7400DM-13		
A7400DZ-1/2, A7400DZ-11/16, A7400DZ-3/4, A7400DZ-5/8, A7400DZ-9/16		
A7402DZ-1/2, A7402DZ-3/8, A7402DZ-7/16, A7402DZ-9/16		
1320RZ-1/4-5/16, 1320RZ-3/8-7/16		
59/S28-4		
6Z-1.1/16-1.1/4, 6Z-1.1-1/8, 6Z-7/8-15/16		
6950SL		
6956		
6958		
6960, 6961		
6966		
6972H		
7407H		
7750SL		
7752		
7760, 7761		
7764		
7765		
7766		
7800DZ-1, 7800DZ-13/16, 7800DZ-7/8		
8164-1/2		
8171		



Foam Inlay Imperial Toolset for our metallic cases 1483K & 1483KHD Series - 13 Pcs



FF3A02



39 x 210 x 445 mm

1 FF3A02

BE-3529		
BE-8020L		
BE-8155		
BE-8260		
BE-8601		
BE-8611, BE-8621		
1150-1/2H/P		
1177-SCRIBE		
2047-1.2-8		
2047PR-1-2		
5515T-52		
9715-14-250		

Foam Inlay Imperial Toolset for our metallic cases 1483K & 1483KHD Series - 12 Pcs



FF3A03



48 x 210 x 450 mm

1 FF3A03

MTB-3-16-M-E		
2101GC-160IP		
2421GC-180IP		
2855 D		
3658A-2, 3658A-3, 3658A-5		
8224CIP		
0454800500		

Foam Inlay Imperial Toolset for our metallic cases 1483K & 1483KHD Series - 20 Pcs



FF3A04



45 x 210 x 445 mm

1 FF3A04

1300Z-1/2-9/16, 1300Z-1/4-5/16, 1300Z-3/8-7/16, 1300Z-5/8-3/4, 1300Z-7/8-15/16, 1300Z-25/32-13/16, 1300Z-19/32-11/16		
6Z-19/32-11/16, 6Z-25/32-13/16, 6Z-3/8-7/16, 6Z-5/8-3/4, 6Z-1/4-5/16, 6Z-1/2-9/16		
9070C		
1931Z-7/32, 1931Z-1/4		
8157-15		

Foam Inlay Imperial Toolset for our metallic cases 1483K & 1483KHD Series - 98 Pcs



FF3A05



60 x 245 x 510 mm

1 FF3A05

A6700DZ-1/2, A6700DZ-1/4, A6700DZ-11/32, A6700DZ-3/16, A6700DZ-3/8, A6700DZ-5/16, A6700DZ-7/16, A6700DZ-7/32, A6700DZ-9/16, A6700DZ-9/32		
A6710DZ-1/4, A6710DZ-11/32, A6710DZ-3/8, A6710DZ-5/16, A6710DZ-7/16		
A6800DM-4		
A6800DZ-1/2, A6800DZ-1/4, A6800DZ-11/32, A6800DZ-3/8, A6800DZ-5/16, A6800DZ-7/16, A6800DZ-3/16, A6800DZ-7/32, A6800DZ-9/16, A6800DZ-9/32		

A7400DZ-1/2, A7400DZ-11/16, A7400DZ-13/16, A7400DZ-17/32, A7400DZ-19/32, A7400DZ-3/4, A7400DZ-5/8, A7400DZ-9/16

59/S28-4		
BE-9780		
KE18-01		
1544		
2058-BR		
59S/TS-1/4		
6950SL		
6956		
6960, 6962		
6966		
6972H		
7407H		
7752		
7750SL		
7760, 7761		
7764		
7765		
7766		
808050		
9071C		
8164-1/2		

Foam Inlay Imperial Toolset for our metallic cases 1483K & 1483KHD Series - 16 Pcs



FF3A06



40 x 205 x 450 mm

1 FF3A06

BE-8030		
BE-8150, BE-8155		
BE-8260		
BE-8350		
BE-8602		
BE-8610, BE-8620		
1177-SCRIBE		
2047-1-5.5		
2047PR-1-2		
5515T-52		
704Z-3/32		
1150-1/2H/P		

Foam Inlay Imperial Toolset for our metallic cases 1483K & 1483KHD Series - 11 Pcs



FF3A07

39 x 202 x 450 mm 1 FF3A07

MTB-3-16-E	
2101GC-160IP	
2427 GC-200IP	
2628 GC-160IP	
2632	
2650	
2855	
3734-3, 3734-5, 3734-8	
8224CIP	

Foam Inlay Imperial Toolset for our metallic cases 1483K & 1483KHD Series - 23 Pcs



FF3A08

43 x 205 x 450 mm 1 FF3A08

1320RZ-1/2-9/16, 1320RZ-5/16-11/32, 1320RZ-1/4-5/16, 1320RZ-3/8-7/16	
1952Z-1/2, 1952Z-1/4, 1952Z-11/16, 1952Z-11/32, 1952Z-13/16, 1952Z-3/4, 1952Z-3/8, 1952Z-5/16, 1952Z-5/8, 1952Z-7/16, 1952Z-7/8, 1952Z-9/16	
6Z-19/32-11/16, 6Z-1/2-9/16, 6Z-1/4-5/16, 6Z-13/16-7/8, 6Z-3/8-7/16, 6Z-5/16-11/32, 6Z-5/8-3/4	

Foam Inlay Metric Toolset for our metallic cases 1483K & 1483KHD Series - 95 Pcs



FF3A09

65 x 250 x 515 mm 1 FF3A09

A6800DM-7, A6800DM-6, A6800DM-5.5, A6800DM-11, A6800DM-10, A6800DM-9, A6800DM-8, A6800DM-13, A6800DM-12	
A7402DM-19, A7402DM-18, A7402DM-17, A7402DM-12, A7402DM-11, A7402DM-10, A7402DM-16, A7402DM-15, A7402DM-14, A7402DM-13	
1544	
2058-BR	
6700SM-8, 6700SM-7, 6700SM-6, 6700SM-5.5, 6700SM-12, 6700SM-11, 6700SM-10, 6700SM-9, 6700SM-13	
6709M-8, 6709M-6, 6709M-5, 6709M-4, 6709M-3	
6709PH-2, 6709PH-1, 6709PH-3	
6709TORX-T25, 6709TORX-T20, 6709TORX-T15, 6709TORX-T10, 6709TORX-T40, 6709TORX-T30, 6709TORX-T27, 6709TORX-T9, 6709TORX-T8	
6950SL	
6954	
6956	
6958	
6960, 6961, 6962, 6962L	
6966	
6972H	
7400SM-8, 7400SM-7, 7400SM-6, 7400SM-19, 7400SM-18, 7400SM-17, 7400SM-22, 7400SM-12, 7400SM-11, 7400SM-10, 7400SM-9, 7400SM-16, 7400SM-15, 7400SM-14, 7400SM-13	
7407H	
7409M-10, 7409M-8, 7409M-7, 7409M-6, 7409M-5, 7409M-4, 7409M-3	
7409TORX-T27, 7409TORX-T25, 7409TORX-T50, 7409TORX-T45, 7409TORX-T40, 7409TORX-T30	
7750SL	
7754	
7758	
7760, 7761	
7764	
7765	
7766	
8164-1/2	

Foam Inlay Metric Toolset for our metallic cases 1483K & 1483KHD Series - 53 Pcs



FF3A10

39 x 205 x 445 mm 1 FF3A10

BE-8020L, BE-8030	
BE-8155	
BE-8260	
BE-8350	
BE-8601, BE-8602	
BE-8610, BE-8620	
BE-9770	
2047-0.8-4	
2047PR-1-2	
808050P	
808050S	
59S/31-1	

Foam Inlay Metric Toolset for our metallic cases 1483K & 1483KHD Series - 12 Pcs



FF3A11

39 x 205 x 445 mm 1 FF3A11

1150-1/2H/P	
MTB-3-16	
1177-SCRIBE	
2101GC-160IP	
2427 GC-200IP	
2430 GC-200 IP	
2628 GC-160IP	
3734-3, 3734-5, 3734-8	
3735-4-120	
8224CIP	



Foam Inlay Metric Toolset for our metallic cases 1483K & 1483KHD Series - 28 Pcs



FF3A12

45 x 205 x 450 mm 1 FF3A12

- 111M-6, 111M-21, 111M-19, 111M-18, 111M-22, 111M-13, 111M-12, 111M-11, 111M-10, 111M-17, 111M-16, 111M-15, 111M-14, 111M-9, 111M-8, 111M-7
- 2820EF2
- 5515T-52
- 6M-10-11, 6M-6-7, 6M-12-13, 6M-8-9, 6M-14-15, 6M-16-17, 6M-18-19, 6M-20-22
- 9070C

Foam Inlay Metric Toolset for our metallic cases 1483K & 1483KHD Series - 49 Pcs



FF3A13

68 x 245 x 525 mm 1 FF3A13

- 111M-27, 111M-32, 111M-24, 111M-30
- 6M-24-27, 6M-30-32
- 7800SM-19, 7800SM-18, 7800SM-17, 7800SM-16, 7800SM-22, 7800SM-21, 7800SM-11, 7800SM-10, 7800SM-15, 7800SM-14, 7800SM-13, 7800SM-12, 7800SM-27, 7800SM-32, 7800SM-30, 7800SM-24
- 7807H
- 7809M-10, 7809M-12, 7809M-14, 7809M-19, 7809M-17, 7809M-5, 7809M-8, 7809M-6, 7809M-7
- 7809TORX-T50, 7809TORX-T45, 7809TORX-T60, 7809TORX-T55, 7809TORX-T25, 7809TORX-T20, 7809TORX-T40, 7809TORX-T30, 7809TORX-T27

- 8150SL
- 8164-1/2
- 8154-11
- 8160-5, 8160-10
- 8171
- 8166
- 8172

Foam Inlay Imperial Toolset for our metallic cases 1483K & 1483KHD Series - 77 Pcs



FF3A14

65 x 247 x 510 mm 1 FF3A14

- A6700DZ-1/2, A6700DZ-1/4, A6700DZ-3/8, A6700DZ-5/16, A6700DZ-7/16, A6700DZ-7/32, A6700DZ-9/16, A6700DZ-9/32, A6700DZ-11/32
- A6800DZ-1/4, A6800DZ-5/16, A6800DZ-7/32, A6800DZ-9/32
- A7400DM-10, A7400DM-13
- A7400DZ-1/2, A7400DZ-11/16, A7400DZ-13/16, A7400DZ-3/4, A7400DZ-5/8, A7400DZ-7/8, A7400DZ-9/16
- A7402DZ-1/2, A7402DZ-3/8, A7402DZ-7/16, A7402DZ-9/16
- 111Z-1, 111Z-1.1/8
- 59/S28-4
- 6Z-1.1/16-1.1/4, 6Z-1-1.1/8
- 6Z/8C
- 6950SL
- 6958
- 6960, 6961
- 6966
- 6972H
- 7407H, 7408H
- 7750SL
- 7752
- 7760, 7761
- 7764
- 7765
- 7766
- 7800DZ-1, 7800DZ-15/16
- 8164-1/2
- 1952Z-15/16
- 8171

Foam Inlay Imperial Toolset for our metallic cases 1483K & 1483KHD Series - 14 Pcs



FF3A15

40 x 210 x 445 mm 1 FF3A15

- BE-3529
- BE-8020L
- BE-8155
- BE-8260
- BE-8601, BE-8602
- BE-8611, BE-8621
- 1177-SCRIBE
- 2047-1.2-8
- 2047PR-1-2
- 5515T-52
- 9715-14-250

Foam Inlay Imperial Toolset for our metallic cases 1483K & 1483KHD Series - 12 Pcs



FF3A16

42 x 210 x 445 mm 1 FF3A16

- MTB-3-16-E
- 2101GC-160IP
- 2421GC-180IP
- 3658A-3, 3658A-5, 3658A-8
- 3735-5-120
- 3740-150
- 8224CIP
- 2855 D
- 0454800500

Foam Inlay Imperial Toolset for our metallic cases 1483K & 1483KHD Series - 30 Pcs



FF3A17

48 x 205 x 450 mm	1 FF3A17

BE-9780	
KE18-01	
1300Z-1/4-5/16, 1300Z-3/8-7/16	
1320RZ-1/4-5/16, 1320RZ-3/8-7/16	
1931Z-1/4, 1931Z-7/32	
1952Z-1/2, 1952Z-11/16, 1952Z-11/32, 1952Z-13/16, 1952Z-3/4, 1952Z-5/8, 1952Z-7/8, 1952Z-9/16	
2628 GC-180IP	
7758	

General Purpose Tool Kit - 109 pcs



981001100

109	27 kg
1	981001100

1546	
2521GC-160	
2630GC-180IP, 2630GC-200IP	
6M-12-13, 6M-14-15, 6M-10-11, 6M-6-7, 6M-8-9, 6M-20-22, 6M-21-23, 6M-24-27, 6M-25-28	
8150RN-1/2	
8154-1/2, 2421GC-160, 8160-1/2, 8162-1/2, 8166-1/2	
9048-400	
9-469-00-0-0	
1998M/10T	
3733-4	

3734-4	
814-100	
815-2-25, 815-1-100, 815-2-125	
9710-8-150, 9710-6.5-125	
2800-180	
SC127	
1-100-08-2-2, 1-100-10-2-2	
1150-1/2H/P	
2101D-140IP	
2535F1	
3906-300-24-2P	
2951-250	
2M-6-7, 2M-8-9, 2M-10-11, 2M-12-13, 2M-14-15, 2M-16-17, 2M-18-19, 2M-20-22, 2M-21-23, 2M-24-27	
3645-150-C	
4544-10	
813-3-75, 813-4-100, 813-5.5-125	
1-230-08-1-2	
2430 GC-160 IP	
3735-4-120	
2900-180	
3625W-35	
479-16	
869102500	
1-170-08-2-2	
1-210-08-2-2	
8072 C, 8071 C	
225-PLUS	
2427 GC-200IP	
3640-150-C	
7800DM-18, 7800DM-17, 7800DM-16, 7800DM-11, 7800DM-10, 7800DM-15, 7800DM-14, 7800DM-13, 7800DM-12, 7800DM-19, 7800DM-23, 7800DM-22, 7800DM-21, 7800DM-20, 7800DM-24, 7800DM-26, 7800DM-28, 7800DM-30, 7800DM-32, 7800DM-27	
813VDE-3-100	
6224	

Tool Trolley Auto Repair Tool Kit - 357 pcs



AUTO

976 x 510 x 820 mm	1 AUTO

FF1ASET-AUTO

Tool Panel Auto Repair Tool Kit - 62 pcs



1495TP-AUTO-M1

900 x 25 x 500 mm	1 1495TP-AUTO-M1

1495TP09	
BP910	
BP909TH	
BE-9678	
BE-9675	
29M-30	
2997-250	
1995LM-9, 1995LM-8, 1995LM-6	
3750	
1177-SCRIBE	
K7801M-9, K7801M-10, K7801M-11, K7801M-12, K7801M-13, K7801M-14, K7801M-15, K7801M-16, K7801M-17, K7801M-18, K7801M-19, K7801M-21, K7801M-22, K7801M-23, K7801M-24, K7801M-30, K7801M-32	
K7806M-15, K7806M-21, K7806M-24, K7806M-27	
K8901M-32, K8901M-34, K8901M-36	
K8964D	
K8167S	
K8160D-3	
2800-150	
2900-150	
3734S/6	
BE-8258TB	
1495TP-ACHL40x 9, 1495TP-ACHL65x 9, 1495TP-ACHL20x 33	



Tool Panel Auto Repair Tool Kit - 53 pcs



1495TP-AUTO-M2



900 x 25 x 500 mm

1 1495TP-AUTO-M2

1495TP09	
BE301	
K7801TORX-E10, K7801TORX-E12, K7801TORX-E14, K7801TORX-E16, K7801TORX-E18, K7801TORX-E20	
K8160D-2	
BE301CM	
BWHEPSSH8	
BE51038, BE510310, BE510312	
BP822	
BP825	
1495TP-ACHL40x 25, 1495TP-ACHL65x 4, 1495TP-ACHL20x 29	
1495TP-AC4	

1495TP09	
BE1GP5-T	
6968	
BE1SP1F	
BE6OF108	
BE6307414F	
BE6OFW	
BE1FFWF	
BE63064514F1	
BE6810Z, BE6810	
BE6FCP	
52	
1546	
2421GC-160	
8166-1/2	
5515M	
BE1P	
7455-60	
BE1FLD2, BE1FLD1, BE1FLD3	
BE65F65120	
7764	
8164-1/2	
BE6302712F	
6962-W	
6954	
BE6701VAG	
BE62110	
BE1310P427	
7406ZZ-21, 7406ZZ-16	
BE1SP14L	
BE1GP5	
1495TP-AC3	
1495TP-ACHL20x 38, 1495TP-ACHL40, 1495TP-ACHL65	

1495TP09	
BS618	
4545-N1, 4545-N11	
4545-1, 4545-2	
MTB-3-16	
361-14	
8900SM-41	
BS52	
8169-1/2, 8165-1/2	
747-22, 747-21, 747-19, 747-17, 747-15, 747-14, 747-13, 747-12	
BS40VAG	
BS56	
BS100PSA1	
BS45BMW	
1495TP-ACHL40x 10, 1495TP-ACHL65x 5, 1495TP-ACHL20x 20	

Tool Panel Auto Repair Tool Kit - 32 pcs



1495TP-AUTO-M5



900 x 25 x 500 mm

1 1495TP-AUTO-M5

1495TP09	
319	
484-1000	
SB3654BM-20	
3625S-44	
B192.004.200	
BE-8258TB	
2484/S4	
B194.030.150, B194.025.125, B194.020.100, B194.010.075	
600.005.012	
BBS165	
K7801TORX-E10, K7801TORX-E12, K7801TORX-E14, K7801TORX-E16, K7801TORX-E18, K7801TORX-E20, K7801TORX-E24	

Tool Panel Auto Repair Tool Kit - 34 pcs



1495TP-AUTO-M3



900 x 25 x 500 mm

1 1495TP-AUTO-M3

Tool Panel Auto Repair Tool Kit - 23 pcs



1495TP-AUTO-M4



900 x 25 x 500 mm

1 1495TP-AUTO-M4

BBR203P920, BBR203P925, BBR203P930, BBR203P940, BBR203P945, BBR203P950, BBR203P955, BBR203P960	
1495TP-ACHL40x 13, 1495TP-ACHL20x 38	
8226	

Tool Panel Auto Repair Tool Kit - 42 pcs

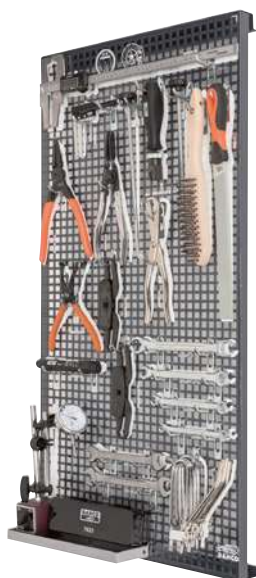

1495TP-AUTO-M6

900 x 25 x 500 mm	1	1495TP-AUTO-M6

1495TP09	
FM10	
782-U	
BBR405	
BBR400	
BBR210P3	
BBR6131	
BBR204	
BBR150I	
BBR501011, BBR50121314	
2900-215	
7823	
BBR100	
1154	
6M-16-17, 6M-14-15	
1949M-17-19, 1949M-12-13, 1949M-10-11, 1949M-8-9	
1495TP-ACHL40x 2, 1495TP-ACHL20x 29	
1495TP-AC3	

Auto Repair 2 Foam Tool Kit - 62 pcs



FF1ASET-AUTO-M1

50 x 543 x 445 mm	1	FF1ASET-AUTO-M1

BP910	
BP909TH	
BE-9678	
BE-9675	
29M-30	
2997-250	
1995LM-9, 1995LM-8, 1995LM-6	
3750	
1177-SCRIBE	
K7801M-9, K7801M-10, K7801M-11, K7801M-12, K7801M-13, K7801M-14, K7801M-15, K7801M-16, K7801M-17, K7801M-18, K7801M-19, K7801M-21, K7801M-22, K7801M-23, K7801M-24, K7801M-30, K7801M-32	
K7806M-15, K7806M-21, K7806M-24, K7806M-27	
K8901M-32, K8901M-34, K8901M-36	
K8964D	
K8167S	
K8160D-3	
2800-150	
2900-150	
3734S/6	
BE-8258TB	

Auto Repair 2 Foam & SAC Alignment Tool Kit - 54 pcs



FF1ASET-AUTO-M2

60 x 543 x 445 mm	1	FF1ASET-AUTO-M2

BE301	
K7801TORX-E10, K7801TORX-E12, K7801TORX-E14, K7801TORX-E16, K7801TORX-E18, K7801TORX-E20	
K8160D-2	
BE301CM	
BWHEPSSH8	
BE51038, BE510310, BE510312	
BP822	
BP825	

Auto Repair 2 Foam Tool Kit - 34 pcs



FF1ASET-AUTO-M3

40 x 543 x 445 mm	1	FF1ASET-AUTO-M3

BE1GP5-T	
6968	
BE1SP1F	
BE6OF108	
BE6307414F	
BE6OFW	
BE1FFWF	
BE63064514F1	
BE6810Z, BE6810	
BE6FCP	
52	
1546	
5515M	
BE1P	
7455-60	
BE1FLD2, BE1FLD1, BE1FLD3	
BE65F65120	
7764	
8164-1/2	
BE6302712F	
6962-W	
6954	
BE6701VAG	
BE62110	
BE1310P427	
7406ZZ-21, 7406ZZ-16	
BE1SP14L	
BE1GP5	
2421GC-160IP	
8166	



Auto Repair 2 Foam Tool Kit - 23 pcs



FF1ASET-AUTO-M4

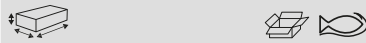

60 x 543 x 445 mm 1 FF1ASET-AUTO-M4

BS618	
4545-N1, 4545-N11	
4545-1, 4545-2	
MTB-3-16	
361-14	
8900SM-41	
BS52	
747-22, 747-21, 747-19, 747-17, 747-15, 747-14, 747-13, 747-12	
BS40VAG	
BS56	
BS100PSA1	
BS45BMW	
8157-24	
8171	

3625S-44	
B192.004.200	
BE-8258TB	
2484/S4	
6225D	
B194.030.150, B194.025.125, B194.020.100, B194.010.075	
600.005.012	
BBS165	
K7801TORX-E10, K7801TORX-E12, K7801TORX-E14, K7801TORX-E16, K7801TORX-E18, K7801TORX-E20, K7801TORX-E24	
BBR203P920, BBR203P925, BBR203P930, BBR203P940, BBR203P945, BBR203P950, BBR203P955, BBR203P960	

Auto Repair 2 Foam Tool Kit - 42 pcs



FF1ASET-AUTO-M6



40 x 543 x 445 mm 1 FF1ASET-AUTO-M6

FM10	
782-U	
BBR405	
BBR400	
BBR210P3	
BBR6131	
BBR204	
BBR150I	
BBR501011, BBR50121314	
2900-215	
7823	
BBR100	
1154	
6M-16-17, 6M-14-15	
1949M-17-19, 1949M-12-13, 1949M-10-11, 1949M-8-9	

Auto Repair 2 Foam Tool Kit - 32 pcs



FF1ASET-AUTO-M5



45 x 543 x 445 mm 1 FF1ASET-AUTO-M5

319	
484-1000	
SB3654BM-20	

Auto Repair 5 Foam Toolkit - 196 Pcs



FF1ASET-AUTO1



50 x 543 x 445 mm 1 FF1ASET-AUTO1

FF1A19	
FF1A20	
FF1A21	
FF1A22	
FF1A23	

Auto Repair 4 Foam Toolkit - 168 Pcs



FF1ASET-AUTO2

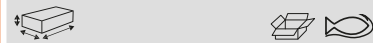

50 x 543 x 445 mm 1 FF1ASET-AUTO2

FF1A19	
FF1A24	
FF1A21	
FF1A25	

Auto Repair 8 Foam Tool Kit - 357 pcs



FF1ASET-AUTO



40 x 543 x 445 mm

1 FF1ASET-AUTO

FF1A218LM	
FF1A219LM	
FF1A220LM	
FF1A221LM	
FF1A222LM	
FF1A223LM	
FF1A224LM	
FF1A225LM	

Auto Repair 3 Foam Toolkit - 140 Pcs



FF1ASET-AUTO3



50 x 543 x 445 mm

1 FF1ASET-AUTO3

FF1A28	
FF1A26	
FF1A27	

Auto Repair 4 Foam Toolkit - 177 Pcs



FF1ASET-AUTO6



50 x 543 x 445 mm

1 FF1ASET-AUTO6

FF1A19	
FF1A72	
FF1A70	
FF1A71	

Blow Mould Case with Adjustable Torque Wrench and Impact Socketry Toolkit - 11 pcs



4750BMC10FF1



84 x 341 x 447 mm

1 4750BMC10FF1

4750BMC10	
BWSHK21	
BWSMB15	
BWSMB17	
BWSS12P5	
BWTVCTT355	
74W9-200	
9R-1/2	

Heavy Duty Rigid Case Aviation Toolkit - 240 Pcs



4750RCHDW01FF1



250 x 345 x 545 mm

1 4750RCHDW01FF1

4750RCHDW01	
FF2B01	
FF2B02	
FF2B03	
FF2B04	
FF2B05	
FF2B06	

Heavy Duty Rigid Case Aviation Toolkit - 159 Pcs



4750RCHDW01FF2



250 x 345 x 545 mm

1 4750RCHDW01FF2

4750RCHDW01	
FF2B07	
FF2B08	
FF2B09	
FF2B10	
FF2B11	



Aviation Toolkit - 159 Pcs/Rigid Case



4750RCHD01FF1



215 x 410 x 475 mm

1 4750RCHD01FF1

4750RCHD01



FF2A07



FF2A08



FF2A10



FF2A09



Metallic Tool Box Aviation Toolkit - 129 Pcs



1483KHD3RB-FF1



335 x 260 x 565 mm

1 1483KHD3RB-FF1

1483KHD3RB



FF3A01



FF3A02



FF3A03



FF3A04



Metallic Tool Box Aviation Toolkit - 152 Pcs



1483KHD3RB-FF2



335 x 260 x 565 mm

1 1483KHD3RB-FF2

1483KHD3RB

FF3A05



FF3A06



FF3A07



FF3A08



2509



2535F2



3625N-32



481-400



7762



Metallic Tool Box Aviation Toolkit - 137 Pcs



1483KHD3RB-FF5



335 x 260 x 565 mm

1 1483KHD3RB-FF5

1483KHD3RB

FF3A14



FF3A15



FF3A16



FF3A17



Metallic Tool Box Aviation Tool Kit - 124 pcs



1483KHD3RB-FF7



335 x 260 x 565 mm

1 1483KHD3RB-FF7

1483KHD3RB

481-400



2535F1



7762



6950SL



6960, 6962



6956



7752



6966



6972H



A6700DZ-3/16, A6700DZ-7/32, A6700DZ-1/4, A6700DZ-9/32, A6700DZ-5/16, A6700DZ-11/32, A6700DZ-3/8, A6700DZ-7/16, A6700DZ-1/2, A6700DZ-9/16



A6710DZ-1/4, A6710DZ-5/16, A6710DZ-11/32, A6710DZ-3/8, A6710DZ-7/16



A6800DZ-3/16, A6800DZ-7/32, A6800DZ-1/4, A6800DZ-9/32, A6800DZ-5/16, A6800DZ-11/32, A6800DZ-3/8, A6800DZ-7/16, A6800DZ-1/2, A6800DZ-9/16



A6800DM-4



BE-9780



59/S28-4



59S/TS-1/4



9070 P



808050



2058-BR



KE18-01



1150-1/2H/P



2047-1-5.5



2047PR-1-2



BE-8030



BE-8150



BE-8260



BE-8350



BE-8602		
BE-8610, BE-8620		
5515T-52		
1177-SCRIBE		
SR300-E		
704Z-3/32		
MTB-3-16-M-E		
2101GC-160IP		
2427 GC-200IP		
2855		
8224CIP		
2628 GC-160IP		
2632		
3734-3, 3734-5, 3734-8		
1300Z-1/4-5/16		
1320RZ-1/4-5/16, 1320RZ-3/8-7/16		
1952Z-15/16, 1952Z-1, 1952Z-1/4, 1952Z-5/16, 1952Z-11/32, 1952Z-3/8, 1952Z-7/16, 1952Z-1/2, 1952Z-9/16, 1952Z-5/8, 1952Z-11/16, 1952Z-3/4, 1952Z-13/16, 1952Z-7/8		
6Z-19/32-11/16		
3625N-32		

Heavy Duty Rigid Case Offshore Oil and Gas Crane Maintenance Application Toolkit - 29 Pcs

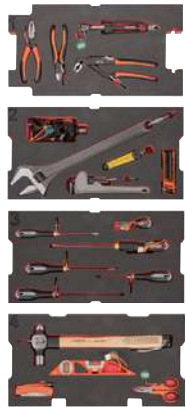

4750RCHDW01FF4



250 x 345 x 545 mm

1 4750RCHDW01FF4

TAH8075		
TAH479-32		
TAHBE-9777B		
TAHBE-9787		
TAH2820EF2		
TAHBFRL11		
TAH466-250		
TAHPINREASER		
TAH380-10		
TAH2101G-160		
TAH2628G-180		
TAH2855		

TAH8224		
TAHSCB140G		
TAHBE-8258		
TAHBE-8241, TAHBE-8252		
TAHBE-8620L, TAHBE-8620		
4750RCHDW01		
4750-HDLB-TAH		
3875-LY9		
3875-LY5		
3875-RL2		
3875-MHP4		
3875-MHP6		
3875-HB60		
3875-LY60		
3875-LY70		

Heavy Duty Rigid Case Offshore Oil and Gas Training Application Toolkit - 41 Pcs



4750RCHDW01FF9



250 x 345 x 545 mm

1 4750RCHDW01FF9

TAH8073		
TAH84-PODGER		
TAH3640-250-C		
TAH1-143-12-1-2		
TAH479-32		
TAH325		
TAHBE-9777B		
TAH2820EF2		
TAHBFRL11		
TAHPINREASER		
TAH380-14		
TAH2101G-140		
TAH2628G-180		
TAH2855		
TAH2958-250		
TAH2484-30		
TAH3734BM-8		

TAHSCB140G		
TAHBE-8257		
TAHBE-8602		
TAH16B-19		
TAH16B-11/16		
TAH16-H8		
TAH8150-1/2		
TAH8158B-1		
TAH7455-300-1		
TAH1949M-14-17		
4750RCHDW01		
4750-HDLB-TAH		
3875-LY9		
3875-LY5		
3875-RL2		
3875-MHP4		
3875-MHP6		
MTS-5-25		
4750-MTHO-TAH		
3875-HB60		
TAH2487		
TAH466-250		
3875-LY60		
3875-LY70		

Heavy Duty Rigid Case MRO Toolkit - 195 Pcs



4750RCHDW02FF1



275 x 460 x 600 mm

1 4750RCHDW02FF1

4750RCHDW02		
6700SM-12, 6700SM-13, 6700SM-10, 6700SM-11, 6700SM-8, 6700SM-9, 6700SM-6, 6700SM-7, 6700SM-5.5		
A6800DM-13, A6800DM-11, A6800DM-12, A6800DM-9, A6800DM-10, A6800DM-7, A6800DM-8, A6800DM-5.5, A6800DM-6		
6709M-3, 6709M-4, 6709M-8, 6709M-5, 6709M-6		
6709PH-1, 6709PH-2, 6709PH-3		



6709TORX-T8, 6709TORX-T30, 6709TORX-T40, 6709TORX-T25, 6709TORX-T27, 6709TORX-T15, 6709TORX-T20, 6709TORX-T9, 6709TORX-T10		
6950SL		
6954		
6956		
6958		
6960, 6962, 6962L		
6966		
6972H		
7764		
7800SM-13, 7800SM-14, 7800SM-11, 7800SM-12, 7800SM-9, 7800SM-10, 7800SM-8, 7800SM-32, 7800SM-30, 7800SM-27, 7800SM-28, 7800SM-25, 7800SM-26, 7800SM-23, 7800SM-24, 7800SM-21, 7800SM-22, 7800SM-19, 7800SM-17, 7800SM-18, 7800SM-15, 7800SM-16		
7805SM-22, 7805SM-23, 7805SM-21, 7805SM-18, 7805SM-19, 7805SM-16, 7805SM-17, 7805SM-14, 7805SM-15, 7805SM-12, 7805SM-13, 7805SM-10, 7805SM-32, 7805SM-30, 7805SM-24, 7805SM-27, 7805SM-24, 7805SM-29, 7805SM-28, 7805SM-25, 7805SM-20		
7809TORX-T30, 7809TORX-T40, 7809TORX-T25, 7809TORX-T27, 7809TORX-T50, 7809TORX-T45		
8150RN-1/2		
111M-23, 111M-24, 111M-21, 111M-22, 111M-19, 111M-17, 111M-18, 111M-15, 111M-16, 111M-13, 111M-14, 111M-11, 111M-12, 111M-9, 111M-10, 111M-7, 111M-8, 111M-6, 111M-32, 111M-29, 111M-30, 111M-27, 111M-28, 111M-26, 111M-25		
1RM-18, 1RM-19, 1RM-16, 1RM-17, 1RM-14, 1RM-15, 1RM-12, 1RM-13, 1RM-10, 1RM-11, 1RM-8, 1RM-9, 1RM-6, 1RM-7		
9070C		
BE-9770		
BE-8571		
2058-BR		
2509		
1544		
2101G-160IP		
2427 G-200 IP		
2430 G-200 IP		
2628 G-160IP		
8224 IP		
1150-1/2H/P		
5515T-52		
2820EF2		
481-300		
3625W-35		
3734-3, 3734-5, 3734-8		
3735-4-120		
1177-SCRIBE		
2535F1		
MTB-3-16		
8160-3, 8160-5, 8160-10		
8166		
8154-11		
8157-15		

Closed Top Bag MRO Toolkit - 61 Pcs



4750FB2-19TS001

	500 mm		250 mm		1	4750FB2-19TS001
--	--------	--	--------	--	---	-----------------

4750FB2-19A		
BE-8010S, BE-8040S, BE-8050S, BE-8220S		
BE-8610S, BE-8620S, BE-8630S		
BE-8800S, BE-8820S, BE-8830S		
706-4		
PC-12-VEN		
1-210-08-2-2		
2101G-180		
2233 D-200		
2628 G-180		
268		
3830-20-VIP, 3830-25-VIP		
3834-ARBR-730		
4130		
424P-16, 424P-20, 424P-25		
428-16		
484-1250		
806-1-1		
8231		
9031		
SL25		

Wheeled Textile Bag MRO Toolkit - 72 Pcs



4750FB2W-TS001

	390 x 400 x 685 mm		1	4750FB2W-TS001
--	--------------------	--	---	----------------

4750FB2W-24A		
SL25		
BE-8030, BE-8242		
S240		
BE-8155		
BE-8600, BE-8610, BE-8620		
BE-8800, BE-8810, BE-8820		
BE-8040S		
2628 G-180		
2101G-180		
7224		
1520 G		
MTB-5-25		
MA421		
268		
325		
479-16		
KERU-01		
5515T		
9071		

MRO 7 Foam Toolkit - 256 Pcs



FF1ASET-MRO2

	530 x 600 x 800 mm		1	FF1ASET-MRO2
--	--------------------	--	---	--------------

FF1A130		
FF1A131		
FF1A132		
FF1A133		
FF1A134		
FF1A135		
FF1A136		

MRO 5 Foam Toolkit - 188 Pcs



FF1ASET-MRO3

530 x 600 x 800 mm 1 FF1ASET-MRO3

FF1A138		
FF1A137		
FF1A134		
FF1A139		
FF1A141		

MRO 4 Foam Toolkit - 147 Pcs



FF1ASET-MRO4

530 x 600 x 800 mm 1 FF1ASET-MRO4

FF1A143		
FF1A142		
FF1A145		
FF1A134		

MRO 3 Foam Toolkit - 84 Pcs



FF1ASET-MRO5

530 x 600 x 800 mm 1 FF1ASET-MRO5

FF1A147		
FF1A146		
FF1A134		

Heavy Duty Rigid Case Windmills Standard Application Toolkit - 114 Pcs



4750RCHDW02FF4

480 x 290 x 630 mm 1 4750RCHDW02FF4

TAH9070, TAH9072		
TAH3625W-35		
TAH481-300		

TAHBE-9777B		
TAH2820EF2		
TAH1150-1/2H/P		
TAH1177-SCRIBE		
TAH1544		
TAH2509		
TAH2535F2		
MTS-5-25		
TAHPINRELEASER		
TAH2427G-200		
TAH2430G-200		
TAH2628G-160		
TAH8224		
TAH2484-30		
TAH3734BM-3, TAH3734BM-8, TAH3734BM-5		
TAH3755BM-4		
TAHSCB140G		
TAHBE-8030, TAHBE-8020L		
TAHBE-8040S, TAHBE-8050S, TAHBE-8220S		
TAHBE-8155		
TAHBE-8260		
TAHBE-8620S, TAHBE-8610S		
TAHBE-8620, TAHBE-8610		
TAHBE-8630		
TAHBE-8810, TAHBE-8820		
TAHBE-8830		
TAH08-5.5, TAH08-9, TAH08-7, TAH08-8, TAH08-13, TAH08-6, TAH08-11, TAH08-10, TAH08-12		
TAH6961, TAH6962, TAH6960, TAH6962L		
TAH6956-1		
TAH6950		
TAH6966		
TAH6958B-1		
TAH16B-27, TAH16B-30, TAH16B-24, TAH16B-22, TAH16B-32, TAH16B-19, TAH16B-21, TAH16B-17, TAH16B-18, TAH16B-11, TAH16B-15, TAH16B-16, TAH16B-13, TAH16B-10, TAH16B-14, TAH16B-12		
TAH16-H8, TAH16-H6, TAH16-H7, TAH16-H5, TAH16-H17, TAH16-H19, TAH16-H12, TAH16-H14, TAH16-H10		
TAH16-T40, TAH16-T45, TAH16-T50, TAH16-T55, TAH16-T60		
TAH8166		
TAH8150-1/2		
TAH8160, TAH8162		
TAH8158B-1		
TAH111M-32, TAH111M-27, TAH111M-24, TAH111M-21, TAH111M-22, TAH111M-19, TAH111M-9, TAH111M-7, TAH111M-8, TAH111M-18, TAH111M-6, TAH111M-16, TAH111M-17, TAH111M-14, TAH111M-15, TAH111M-12, TAH111M-13, TAH111M-10, TAH111M-11, TAH111M-30		
TAH2101G-160		
TAH2047PR-1-2		
TAH2047-0.8-4		
4750RCHDW02		



Heavy Duty Rigid Case Windmills Heavy Duty Application Toolkit - 36 Pcs



4750RCHDW02FF15

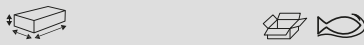

480 x 290 x 630 mm 1 4750RCHDW02FF15

TAH1-100-06-2-4		
TAH1-210-06-2-2		
TAH1-230-06-2-2		
TAH3625PU-50		
TAH489-1100		
TAHBE64520		
TAHPINRELEASER		
TAHSCB140G		
TAH24B-50, TAH24B-46, TAH24B-41, TAH24B-38, TAH24B-36, TAH24B-32, TAH24B-30, TAH24B-27		
TAH8950N/A		
TAH8961		
TAH8953		
TAH7452-2		
TAH7455-300-1		
TAH7435-100		
TAH111M-50, TAH111M-46, TAH111M-41, TAH111M-36, TAH111M-34		
TAH7444SG-M-46, TAH7444SG-M-41, TAH7444SG-M-36, TAH7444SG-M-55, TAH7444SG-M-50		
4750RCHDW02		

Zipper Wallet Electrician Toolkit - 17 Pcs



9852

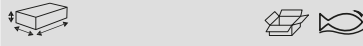

360 x 40 x 240 mm 1 9852

TM3m

7890		
8160		
8070		
TL AA-SA-SL		
2421 G-160		
2101G-160		
2628 G-180		
BE-8210, BE-8040		
BE-8150, BE-8155		
BE-8600, BE-8610, BE-8620		
8045LVDE		
K-AP-1		

Zipper Wallet Electrician Toolkit - 7 Pcs



9841

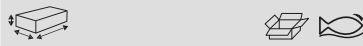

275 x 48 x 330 mm 1 9841

7190		
7890		
TL AA-SA-SL		
BE-8020, BE-8040		
BE-8610		
8070		

Heavy Duty Rigid Case Windpower Toolkit - 167 Pcs



4750RCHDW02FF2



480 x 290 x 630 mm 1 4750RCHDW02FF2

4750RCHDW02		
6700SM-12, 6700SM-13, 6700SM-10, 6700SM-11, 6700SM-8, 6700SM-9, 6700SM-6, 6700SM-7, 6700SM-5.5		
6954		
6956		
6958		
6960, 6961, 6962, 6962L		
6966		
6972H		
6950SL		
7800SM-13, 7800SM-14, 7800SM-11, 7800SM-12, 7800SM-10, 7800SM-32, 7800SM-30, 7800SM-27, 7800SM-24, 7800SM-21, 7800SM-19, 7800SM-17, 7800SM-18, 7800SM-15, 7800SM-16, 7800SM-22		
7809M-7, 7809M-6, 7809M-17, 7809M-19, 7809M-5, 7809M-14, 7809M-12, 7809M-10, 7809M-8		
7809TORX-T60, 7809TORX-T40, 7809TORX-T55, 7809TORX-T50, 7809TORX-T45		
59S/31-1		
8150SL		
111M-24, 111M-21, 111M-19, 111M-17, 111M-18, 111M-15, 111M-16, 111M-13, 111M-14, 111M-11, 111M-12, 111M-9, 111M-10, 111M-7, 111M-8, 111M-6, 111M-32, 111M-29, 111M-30, 111M-27		
BE-9770		
1177-SCRIBE		
6M-6-7, 6M-8-9, 6M-10-11, 6M-12-13, 6M-14-15, 6M-16-17, 6M-18-19, 6M-20-22, 6M-24-27, 6M-30-32		
MTB-3-16-E		
9070, 9072		
2535L		
BE-8020L, BE-8030		
BE-8155		
BE-8260		
BE-8610, BE-8620		
BE-8630		
BE-8810, BE-8820		

BE-8830		
1544		
2047-0.8-4		
TAH2047PR-1-2		
2058-BR		
2509		
808050P		
808050S		
BE-8220S, BE-8040S, BE-8050S		
BE-8610S, BE-8620S		
2535F2		
1150-1/2H/P		
2101G-160IP		
2427 G-200 IP		
2430 G-200 IP		
2628 G-160IP		
2820EF2		
5515T-52		
8224 IP		
3625W-35		
3734-3, 3734-5, 3734-8		
3735-4-120		
481-300		
3680		
3875-RL1		
3875-WL1		
4750-3PB-2		
3750		
8157-15		
8154-11		
8160-5, 8160-10		
8171		
8166		

RIGID CASES

31 L Wheeled Heavy Duty Rigid Cases



240 x 350 x 545 mm	1	4750RCHDW01
240 x 350 x 545 mm	1	4750RCHDW01RED

60x20 wheels on ball bearing for easy transport even when very loaded

53 L Wheeled Heavy Duty Rigid Cases



290 x 480 x 630 mm	1	4750RCHDW02
290 x 480 x 630 mm	1	4750RCHDW02RED

60x37mm wheels on ball bearings

29 L Heavy Duty Rigid Cases



215 x 415 x 465 mm	1	4750RCHD01

Indestructible tool case with injected copolymer polypropylene structural resin

29 L Heavy Duty Rigid Cases with Tool Pallets



215 x 415 x 465 mm	1	4750RCHD011

18.5 L Heavy Duty Rigid Cases



205 x 345 x 400 mm	1	4750RCHD00

153.9 L Wheeled Heavy Duty Rigid Cases



460 x 560 x 860 mm	1	4750RCHDW10

150 L Wheeled Rigid Tool Cases with Telescopic Handle and 4 Drawers



453 x 340 x 575 mm	1	4750RCWD4
453 x 340 x 575 mm	1	4750RCWD4-OR



42 L Wheeled Rigid Tool Cases with Telescopic Handle



4750RCW01



257 x 406 x 485 mm
257 x 406 x 485 mm

1 4750RCW01
1 4750RCW011

4750RCW01 with transparent pouches. 4750RCW011 with rubber strips on lid and bottom tool pallets

35 L Rigid Tool Cases



4750RC02



221 x 406 x 485 mm
221 x 406 x 485 mm

1 4750RC02
1 4750RC021

4750RC02: with transparent pouches on one side 4750RC021: With rubber strips on one side

23-35 L Rigid Tool Cases



4750RC01



165 x 399 x 450 mm

1 4750RC01

Swivelling Wheel Kit - 4 Pcs



4750RCWD-AC1



100 x 50 x 200 mm

1 4750RCWD-AC1

Pivoting Under Lid Tool Pallets with Pouch System



4750RCWD-AC2



30 x 277 x 507 mm

1 4750RCWD-AC2

Pivoting Under Lid Tool Pallets with Fixed Elastics



4750RCWD-AC3



5 x 277 x 507 mm

1 4750RCWD-AC3

Fixed Under Lid Tool Pallets with Adjustable Elastics



4750RCWD-AC4



4 x 286 x 490 mm

1 4750RCWD-AC4

Removable Padded Lid Panels for 4750RCHD01



4750RCHD01AC1



35 x 305 x 425 mm

1 4750RCHD01AC1

Removable Padded Bags for 4750RCHD01 Heavy Duty Rigid Case



4750RCHD01AC2



135 x 360 x 450 mm

1 4750RCHD01AC2

Removable Lid Panels for 4750RCHDW01 Heavy Duty Case



4750RCHDW01AC1



50 x 204 x 500 mm

1 4750RCHDW01AC1

Internal Bags for 4750RCHDW01 Heavy Duty Rigid Case



4750RCHDW01AC2



120 x 280 x 525 mm

1 4750RCHDW01AC2

TSA Locks for 4750RCHD Cases



4750RCHD-AC1



20 x 40 x 70 mm

1 4750RCHD-AC1

Foam Inlay Socket Set for 4750RCHD01 Heavy Duty Rigid Case - 64 Pcs



FF2A07



45 x 330 x 430 mm

1 FF2A07

A6700DZ-1/2, A6700DZ-1/4, A6700DZ-11/32, A6700DZ-3/16, A6700DZ-3/8, A6700DZ-5/16, A6700DZ-7/16, A6700DZ-7/32, A6700DZ-9/16, A6700DZ-9/32

A6710DZ-3/8, A6710DZ-5/16, A6710DZ-7/16, A6710DZ-1/4

A6800DZ-1/2, A6800DZ-1/4, A6800DZ-11/32, A6800DZ-3/16, A6800DZ-3/8, A6800DZ-5/16, A6800DZ-7/16, A6800DZ-7/32, A6800DZ-9/16, A6800DZ-9/32

A7400DZ-1/2, A7400DZ-11/16, A7400DZ-13/16, A7400DZ-19/32, A7400DZ-3/4, A7400DZ-3/8, A7400DZ-5/8, A7400DZ-7/16, A7400DZ-7/8, A7400DZ-9/16

A7402DZ-1/2, A7402DZ-11/16, A7402DZ-13/16, A7402DZ-19/32, A7402DZ-3/4, A7402DZ-3/8, A7402DZ-5/8, A7402DZ-7/16, A7402DZ-7/8, A7402DZ-9/16

2058-BR

6950SL

6954

6956

6960, 6962, 6962L

6966

6972H

7407H, 7408H

7750SL

7752

7760, 7761, 7762

7764

7765

7766

8164-1/2

Foam Inlay Wrench and File Set for 4750RCHD01 Heavy Duty Rigid Case - 24 Pcs



FF2A08



45 x 335 x 435 mm

1 FF2A08

1-100-04-2-2



1-230-04-2-2



111Z-1, 111Z-1/2, 111Z-1/4, 111Z-11/16, 111Z-3/4, 111Z-3/8, 111Z-5/16, 111Z-5/8, 111Z-7/16, 111Z-9/16, 111Z-7/8

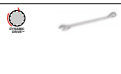

1177-SCRIBE



1320RZ-1/2-9/16, 1320RZ-1/4-5/16, 1320RZ-3/8-7/16, 1320RZ-5/16-11/32



1931Z-1/4, 1931Z-3/16, 1931Z-7/32



1950MZ-3/8



208



9031 C



Foam Inlay Screwdriver and Wrench Set for 4750RCHD01 Heavy Duty Rigid Case - 56 Pcs



FF2A09



45 x 335 x 440 mm

1 FF2A09

BE-8040, BE-8210



BE-8260



BE-8600, BE-8610, BE-8620



BE-9780



MTB-3-16-E



2047-1-5.5

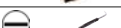

2047PR-1-2

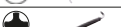

59/S28-4

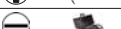

2509



2535F2



5515T-52



808050

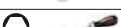

BE-8150



Foam Inlay Socket Set for 4750RCHDW01 Heavy Duty Rigid Case - 61 Pcs



FF2B01



40 x 270 x 505 mm

1 FF2B01

A6700DZ-1/2, A6700DZ-1/4, A6700DZ-11/32, A6700DZ-3/16, A6700DZ-3/8, A6700DZ-5/16, A6700DZ-7/16, A6700DZ-7/32, A6700DZ-9/16, A6700DZ-9/32



A6800DZ-1/2, A6800DZ-1/4, A6800DZ-11/32, A6800DZ-3/16, A6800DZ-3/8, A6800DZ-5/16, A6800DZ-7/16, A6800DZ-7/32, A6800DZ-9/16, A6800DZ-9/32



A7400DZ-1/2, A7400DZ-1/4, A7400DZ-11/16, A7400DZ-17/32, A7400DZ-19/32, A7400DZ-3/4, A7400DZ-3/8, A7400DZ-5/16, A7400DZ-5/8, A7400DZ-7/16, A7400DZ-9/16



A7402DZ-1/2, A7402DZ-1/4, A7402DZ-11/16, A7402DZ-19/32, A7402DZ-3/4, A7402DZ-3/8, A7402DZ-5/16, A7402DZ-5/8, A7402DZ-7/16, A7402DZ-9/16



- 6950SL
- 6954
- 6956
- 6958
- 6960, 6961, 6962L
- 6966
- 6972H
- 7407H
- 7750SL
- 7752
- 7760, 7761, 7762
- 7764
- 7765
- 7766
- 8164-1/2

Foam Inlay Wrench and Socket Set for 4750RCHDW01 Heavy Duty Rigid Case - 69 Pcs



FF2B02



39 x 270 x 505 mm

1 FF2B02

A6700DM-5.5, A6700DM-6, A6700DM-11, A6700DM-12, A6700DM-13, A6700DM-14, A6700DM-7, A6700DM-8, A6700DM-9, A6700DM-10



A6800DM-6, A6800DM-7, A6800DM-8, A6800DM-9, A6800DM-4, A6800DM-5, A6800DM-5.5, A6800DM-14, A6800DM-10, A6800DM-11, A6800DM-12, A6800DM-13



A7400DM-10, A7400DM-14, A7400DM-15, A7400DM-16, A7400DM-11, A7400DM-12, A7400DM-17, A7400DM-18, A7400DM-19, A7400DM-13



A7402DM-19, A7402DM-15, A7402DM-16, A7402DM-17, A7402DM-18, A7402DM-11, A7402DM-12, A7402DM-13, A7402DM-14, A7402DM-10



BE-9770



111M-24, 111M-6, 111M-7, 111M-12, 111M-13, 111M-14, 111M-15, 111M-8, 111M-9, 111M-10, 111M-11, 111M-22, 111M-16, 111M-17, 111M-18, 111M-19



4020L-M-5, 4020L-M-5.5



Foam Inlay Wrench and Socket Set for 4750RCHDW01 Heavy Duty Rigid Case - 44 Pcs



FF2B03



35 x 270 x 505 mm

1 FF2B03

A6710DM-7



A6710DZ-1/2, A6710DZ-1/4, A6710DZ-11/32, A6710DZ-3/16, A6710DZ-3/8, A6710DZ-5/16, A6710DZ-7/16, A6710DZ-7/32, A6710DZ-9/16, A6710DZ-9/32



BE-9780



111Z-1, 111Z-1/2, 111Z-1/4, 111Z-11/16, 111Z-3/4, 111Z-3/8, 111Z-5/16, 111Z-5/8, 111Z-7/16, 111Z-7/8, 111Z-9/16, 111Z-13/16



1320RZ-1/2-9/16, 1320RZ-1/4-5/16, 1320RZ-3/8-7/16, 1320RZ-5/16-11/32



1931Z-1/4, 1931Z-3/16, 1931Z-7/32



1950MZ-3/8



2058-BR



Foam Inlay Socket Set for 4750RCHDW01 Heavy Duty Rigid Case - 45 Pcs



FF2B04



42 x 270 x 505 mm

1 FF2B04

BE-8020L, BE-8040



BE-8080-10



BE-8150, BE-8255



BE-8610, BE-8620



1544



2509



59/S28-4



2535F2



5516



700-1.5-50, 700-1-50



701-0-50, 701-00-50



808050

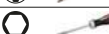

9070C



Foam Inlay Pliers Set for 4750RCHDW01 Heavy Duty Rigid Case - 15 Pcs



FF2B05



35 x 270 x 510 mm

1 FF2B05

1150-1/2H/P	
MTB-3-16-M-E	
2101GC-125IP, 2101GC-160IP	
2427 GC-200IP	
2628 GC-160IP	
2650	
2820EF2	
2855	
4130	
4830	
5515T-52	
8224CIP	

Foam Inlay Hammer and Punch Set for 4750RCHDW01 Heavy Duty Rigid Case - 6 Pcs



FF2B06



35 x 122 x 355 mm

1 FF2B06

3625N-32	
3734-5, 3734-8, 3734-3	
3735-5-120	
481-300	

Foam Inlay Wrench and Socket Set for 4750RCHDW01 Heavy Duty Rigid Case - 62 Pcs



FF2B07



35 x 270 x 505 mm

1 FF2B07

A6700DZ-1/2, A6700DZ-1/4, A6700DZ-11/32, A6700DZ-3/16, A6700DZ-3/8, A6700DZ-5/16, A6700DZ-7/16, A6700DZ-7/32, A6700DZ-9/16, A6700DZ-9/32	
A6710DZ-3/8, A6710DZ-5/16, A6710DZ-7/16	
A6800DZ-1/2, A6800DZ-1/4, A6800DZ-11/32, A6800DZ-3/16, A6800DZ-3/8, A6800DZ-5/16, A6800DZ-7/16, A6800DZ-7/32, A6800DZ-9/16, A6800DZ-9/32	
A7400DZ-1/2, A7400DZ-11/16, A7400DZ-13/16, A7400DZ-19/32, A7400DZ-3/4, A7400DZ-3/8, A7400DZ-5/8, A7400DZ-7/16, A7400DZ-7/8, A7400DZ-9/16	
A7402DZ-1/2, A7402DZ-11/16, A7402DZ-13/16, A7402DZ-19/32, A7402DZ-3/4, A7402DZ-3/8, A7402DZ-5/8, A7402DZ-7/16, A7402DZ-7/8, A7402DZ-9/16	
6950SL	
6954	
6956	
6960, 6962, 6962L	
6966	
6972H	
7407H, 7408H	
7750SL	
7752	
7760, 7761, 7762	
7764	
7765	
7766	
8164-1/2	

Foam Inlay Wrench Set for 4750RCHDW01 Heavy Duty Rigid Case - 25 Pcs



FF2B08



44 x 270 x 505 mm

1 FF2B08

1-100-04-2-2	
1-230-04-2-2	
111Z-1, 111Z-1/2, 111Z-1/4, 111Z-11/16, 111Z-3/4, 111Z-3/8, 111Z-5/16, 111Z-5/8, 111Z-7/16, 111Z-7/8, 111Z-9/16	
1177-SCRIBE	
1320RZ-1/2-9/16, 1320RZ-1/4-5/16, 1320RZ-3/8-7/16, 1320RZ-5/16-11/32	
1931Z-1/4, 1931Z-3/16, 1931Z-7/32	
1950MZ-3/8	
2058-BR	
208	
9031 C	

Foam Inlay Screwdriver Set for 4750RCHDW01 Heavy Duty Rigid Case - 56 Pcs



FF2B09



47 x 270 x 505 mm

1 FF2B09

BE-8040, BE-8210	
BE-8150	
BE-8260	
BE-8600, BE-8610, BE-8620	
BE-9780	
MTB-3-16-E	
2047-1-5.5	
2047PR-1-2	
2509	
2535F2	
5515T-52	
59/S28-4	
808050	



Foam Inlay Aviation Pliers Set for 4750RCHDW01 Heavy Duty Rigid Case - 9 Pcs



FF2B10



37 x 270 x 505 mm

1 FF2B10

2101GC-160IP	
2427 GC-200IP	
2430 GC-200 IP	
2628 GC-160IP	
2650	
2744	
2855	
2979 D-180	
8224CIP	

Foam Inlay Striking Toolset for 4750RCHDW01 Heavy Duty Rigid Case - 7 Pcs



FF2B11



39 x 122 x 355 mm

1 FF2B11

2632	
3625N-32	
3734-2, 3734-3, 3734-4, 3734-5	
481-300	

Foam Inlay Socket Set for 4750RCHDW01 Heavy Duty Rigid Case - 92 Pcs



FF2B12



44 x 270 x 505 mm

1 FF2B12

A6800DM-6, A6800DM-7, A6800DM-8, A6800DM-9, A6800DM-5.5, A6800DM-10, A6800DM-11, A6800DM-12, A6800DM-13	
A7402DM-19, A7402DM-15, A7402DM-16, A7402DM-17, A7402DM-18, A7402DM-11, A7402DM-12, A7402DM-13, A7402DM-14, A7402DM-10	
6700SM-5.5, 6700SM-6, 6700SM-11, 6700SM-12, 6700SM-13, 6700SM-7, 6700SM-8, 6700SM-9, 6700SM-10	
6709M-3, 6709M-4, 6709M-5, 6709M-6, 6709M-8	
6709PH-1, 6709PH-2, 6709PH-3	
6709TORX-T20, 6709TORX-T25, 6709TORX-T27, 6709TORX-T30, 6709TORX-T8, 6709TORX-T9, 6709TORX-T10, 6709TORX-T15, 6709TORX-T40	
6954	
6956	
6958	
6960, 6961, 6962, 6962L	
6966	
6972H	
7400SM-6, 7400SM-11, 7400SM-12, 7400SM-13, 7400SM-14, 7400SM-7, 7400SM-8, 7400SM-9, 7400SM-10, 7400SM-19, 7400SM-22, 7400SM-15, 7400SM-16, 7400SM-17, 7400SM-18	
7407H	
7409M-8, 7409M-10, 7409M-4, 7409M-5, 7409M-6, 7409M-7, 7409M-3	
7409TORX-T25, 7409TORX-T27, 7409TORX-T30, 7409TORX-T40, 7409TORX-T45, 7409TORX-T50	
7750SL	
7761, 7762, 7760	
7764	
7765	
7766	
8164-1/2	
6950SL	

Foam Inlay Wrench Set for 4750RCHDW01 Heavy Duty Rigid Case - 39 Pcs



FF2B13



50 x 270 x 505 mm

1 FF2B13

BE-9770	
111M-12, 111M-13, 111M-14, 111M-15, 111M-8, 111M-9, 111M-10, 111M-11, 111M-6, 111M-7, 111M-21, 111M-22, 111M-16, 111M-17, 111M-18, 111M-19	
6M-6-7, 6M-8-9, 6M-10-11, 6M-12-13, 6M-14-15, 6M-16-17, 6M-18-19, 6M-20-22	
9070C	
1177-SCRIBE	
2535F2	
7758	
7754	

Foam Inlay Screwdriver Set for 4750RCHDW01 Heavy Duty Rigid Case - 48 Pcs



FF2B14



35 x 270 x 505 mm

1 FF2B14

BE-8020L, BE-8030	
BE-8155	
BE-8260	
BE-8350	
BE-8601, BE-8602	
BE-8610, BE-8620	
BE-8630	
1544	
2047-0-8-4	
2047PR-1-2	
2058-BR	
2509	
808050P	
808050S	
59S/31-1	

Foam Inlay General Purpose Pliers Set for 4750RCHDW01 Heavy Duty Rigid Case - 9 Pcs



FF2B15



35 x 270 x 505 mm



1 FF2B15

1150-1/2H/P	
2101GC-160IP	
2427 GC-200IP	
2430 GC-200 IP	
2628 GC-160IP	
2820EF2	
5515T-52	
8224CIP	
MTB-3-16-M-E	

Foam Inlay Striking Set for 4750RCHDW01 Heavy Duty Rigid Case - 6 Pcs



FF2B16



34 x 122 x 355 mm



1 FF2B16

3625W-35	
3734-3, 3734-5, 3734-8	
3735-4-120	
481-300	

Foam Inlay 1/4" & 1/2" Socket Set & Multimeter for 4750RCHDW01 Heavy Duty Rigid Case - 51 pcs



FF2C01



45 x 390 x 530 mm



1 FF2C01

SBS81	
SL25	
BMMTRMS1	
S240	

Foam Inlay Toolset for Heavy Duty Rigid Cases - 15 Pcs



FF2A10



49 x 330 x 435 mm



1 FF2A10

2101GC-160IP	
2427 GC-200IP	
2628 GC-160IP	
2632	
2650	
2855	
2979 D-180	
3625N-32	
3734-2, 3734-3, 3734-4, 3734-5	
3735-4-120	
481-300	
8224CIP	

WORKBENCHES

Heavy Duty Steel Top Workbenches with Side Drawer Tower and 2-Leg 1500 mm x 750 mm x 1030 mm



1495KCWB15TS



1030 x 750 x 1500 mm	1	1495K6CWB15TS
1030 x 750 x 1500 mm	1	1495K7CWB15TS
1030 x 750 x 1500 mm	1	1495K8CWB15TS
1030 x 750 x 1500 mm	1	1495K6CBKWB15TS
1030 x 750 x 1500 mm	1	1495K7CBKWB15TS
1030 x 750 x 1500 mm	1	1495K8CBKWB15TS
1030 x 750 x 1500 mm	1	1495K6CBLWB15TS
1030 x 750 x 1500 mm	1	1495K7CBLWB15TS
1030 x 750 x 1500 mm	1	1495K8CBLWB15TS
1030 x 750 x 1500 mm	1	1495K6CRDWB15TS
1030 x 750 x 1500 mm	1	1495K7CRDWB15TS
1030 x 750 x 1500 mm	1	1495K8CRDWB15TS



Heavy Duty Steel Top Workbenches with Side Drawer Tower and 2-Leg 1800 mm x 750 mm x 1030 mm



1495KCWB18TS



1030 x 750 x 1800 mm	1	1495K6CWB18TS
1030 x 750 x 1800 mm	1	1495K7CWB18TS
1030 x 750 x 1800 mm	1	1495K8CWB18TS
1030 x 750 x 1800 mm	1	1495K6CBKWB18TS
1030 x 750 x 1800 mm	1	1495K7CBKWB18TS
1030 x 750 x 1800 mm	1	1495K8CBKWB18TS
1030 x 750 x 1800 mm	1	1495K6CBLWB18TS
1030 x 750 x 1800 mm	1	1495K7CBLWB18TS
1030 x 750 x 1800 mm	1	1495K8CBLWB18TS
1030 x 750 x 1800 mm	1	1495K6CRDWB18TS
1030 x 750 x 1800 mm	1	1495K7CRDWB18TS
1030 x 750 x 1800 mm	1	1495K8CRDWB18TS



Heavy Duty Wooden Top Workbenches with Side Drawer Tower and 2-Leg 1500 mm x 750 mm x 1030 mm



1495KCWB15TW

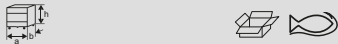

1030 x 750 x 1500 mm	1	1495K6CWB15TW
1030 x 750 x 1500 mm	1	1495K7CWB15TW
1030 x 750 x 1500 mm	1	1495K8CWB15TW
1030 x 750 x 1500 mm	1	1495K6CBKWB15TW
1030 x 750 x 1500 mm	1	1495K7CBKWB15TW
1030 x 750 x 1500 mm	1	1495K8CBKWB15TW
1030 x 750 x 1500 mm	1	1495K6CBLWB15TW
1030 x 750 x 1500 mm	1	1495K7CBLWB15TW
1030 x 750 x 1500 mm	1	1495K8CBLWB15TW
1030 x 750 x 1500 mm	1	1495K6CRDWB15TW
1030 x 750 x 1500 mm	1	1495K7CRDWB15TW
1030 x 750 x 1500 mm	1	1495K8CRDWB15TW

Heavy Duty MDF Workbenches with Side Drawer Tower and 2-Leg 1500 mm x 750 mm x 1030 mm



1495KCWB15TD

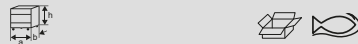

1030 x 750 x 1500 mm	1	1495K6CWB15TD
1030 x 750 x 1500 mm	1	1495K7CWB15TD
1030 x 750 x 1500 mm	1	1495K8CWB15TD
1030 x 750 x 1500 mm	1	1495K6CBKWB15TD
1030 x 750 x 1500 mm	1	1495K7CBKWB15TD
1030 x 750 x 1500 mm	1	1495K8CBKWB15TD
1030 x 750 x 1500 mm	1	1495K6CBLWB15TD
1030 x 750 x 1500 mm	1	1495K7CBLWB15TD
1030 x 750 x 1500 mm	1	1495K8CBLWB15TD
1030 x 750 x 1500 mm	1	1495K6CRDWB15TD
1030 x 750 x 1500 mm	1	1495K7CRDWB15TD
1030 x 750 x 1500 mm	1	1495K8CRDWB15TD

Heavy Duty Low Height Steel Top Workbenches with 6 Drawers Side Tower and 2-Leg



1495KH6WBTS

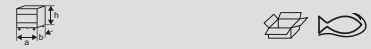

880 x 750 x 1500 mm	1	1495KH6WB15TS
880 x 750 x 1800 mm	1	1495KH6WB18TS
880 x 750 x 1500 mm	1	1495KH6BKWB15TS
880 x 750 x 1800 mm	1	1495KH6BKWB18TS
880 x 750 x 1500 mm	1	1495KH6BLWB15TS
880 x 750 x 1800 mm	1	1495KH6BLWB18TS
880 x 750 x 1500 mm	1	1495KH6RDWB15TS
880 x 750 x 1800 mm	1	1495KH6RDWB18TS

Heavy Duty Wooden Top Workbenches with Side Drawer Tower and 2-Leg 1800 mm x 750 mm x 1030 mm



1495KCWB18TW

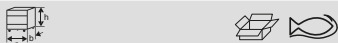

1030 x 750 x 1800 mm	1	1495K6CWB18TW
1030 x 750 x 1800 mm	1	1495K7CWB18TW
1030 x 750 x 1800 mm	1	1495K8CWB18TW
1030 x 750 x 1800 mm	1	1495K6CBKWB18TW
1030 x 750 x 1800 mm	1	1495K7CBKWB18TW
1030 x 750 x 1800 mm	1	1495K8CBKWB18TW
1030 x 750 x 1800 mm	1	1495K6CBLWB18TW
1030 x 750 x 1800 mm	1	1495K7CBLWB18TW
1030 x 750 x 1800 mm	1	1495K8CBLWB18TW
1030 x 750 x 1800 mm	1	1495K6CRDWB18TW
1030 x 750 x 1800 mm	1	1495K7CRDWB18TW
1030 x 750 x 1800 mm	1	1495K8CRDWB18TW

Heavy Duty MDF Top Workbenches with Side Drawer Tower and 2-Leg 1800 mm x 750 mm x 1030 mm



1495KCWB18TD

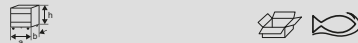

1030 x 750 x 1800 mm	1	1495K6CWB18TD
1030 x 750 x 1800 mm	1	1495K7CWB18TD
1030 x 750 x 1800 mm	1	1495K8CWB18TD
1030 x 750 x 1800 mm	1	1495K6CBKWB18TD
1030 x 750 x 1800 mm	1	1495K7CBKWB18TD
1030 x 750 x 1800 mm	1	1495K8CBKWB18TD
1030 x 750 x 1800 mm	1	1495K6CBLWB18TD
1030 x 750 x 1800 mm	1	1495K7CBLWB18TD
1030 x 750 x 1800 mm	1	1495K8CBLWB18TD
1030 x 750 x 1800 mm	1	1495K6CRDWB18TD
1030 x 750 x 1800 mm	1	1495K7CRDWB18TD
1030 x 750 x 1800 mm	1	1495K8CRDWB18TD

Heavy Duty Low Height Steel Top Workbenches with 7 Drawers Side Tower and 2-Leg



1495KH7WBTS

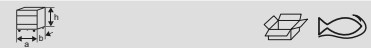

880 x 750 x 1500 mm	1	1495KH7WB15TS
880 x 750 x 1800 mm	1	1495KH7WB18TS
880 x 750 x 1500 mm	1	1495KH7BKWB15TS
880 x 750 x 1800 mm	1	1495KH7BKWB18TS
880 x 750 x 1500 mm	1	1495KH7BLWB15TS
880 x 750 x 1800 mm	1	1495KH7BLWB18TS
880 x 750 x 1500 mm	1	1495KH7RDWB15TS
880 x 750 x 1800 mm	1	1495KH7RDWB18TS

Heavy Duty Low Height Steel Top Workbenches with 8 Drawers Side Tower and 2-Leg



1495KH8WBTS



880 x 750 x 1500 mm	1	1495KH8WB15TS
880 x 750 x 1800 mm	1	1495KH8WB18TS

880 x 750 x 1500 mm	1	1495KH8BKWB15TS
880 x 750 x 1800 mm	1	1495KH8BKWB18TS
880 x 750 x 1500 mm	1	1495KH8BLWB15TS
880 x 750 x 1800 mm	1	1495KH8BLWB18TS
880 x 750 x 1500 mm	1	1495KH8RDWB15TS
880 x 750 x 1800 mm	1	1495KH8RDWB18TS

Heavy Duty Low Height Wooden top Workbenches with 8 Drawers Side Tower and 2-Leg



1495KH8WB15TW

880 x 750 x 1500 mm	1	1495KH8WB15TW
880 x 750 x 1800 mm	1	1495KH8WB18TW
880 x 750 x 1500 mm	1	1495KH8BKWB15TW
880 x 750 x 1800 mm	1	1495KH8BKWB18TW
880 x 750 x 1500 mm	1	1495KH8BLWB15TW
880 x 750 x 1800 mm	1	1495KH8BLWB18TW
880 x 750 x 1500 mm	1	1495KH8RDWB15TW
880 x 750 x 1800 mm	1	1495KH8RDWB18TW

880 x 750 x 1500 mm	1	1495KH7BKWB15TD
880 x 750 x 1800 mm	1	1495KH7BKWB18TD
880 x 750 x 1500 mm	1	1495KH7BLWB15TD
880 x 750 x 1800 mm	1	1495KH7BLWB18TD
880 x 750 x 1500 mm	1	1495KH7RDWB15TD
880 x 750 x 1800 mm	1	1495KH7RDWB18TD

Heavy Duty Low Height MDF Top Workbenches with 8 Drawers Side Tower and 2-Leg



Heavy Duty Low Height Wooden top Workbenches with 6 Drawers Side Tower and 2-Leg



1495KH6WB15TW

880 x 750 x 1500 mm	1	1495KH6WB15TW
880 x 750 x 1800 mm	1	1495KH6WB18TW
880 x 750 x 1500 mm	1	1495KH6BKWB15TW
880 x 750 x 1800 mm	1	1495KH6BKWB18TW
880 x 750 x 1500 mm	1	1495KH6BLWB15TW
880 x 750 x 1800 mm	1	1495KH6BLWB18TW
880 x 750 x 1500 mm	1	1495KH6RDWB15TW
880 x 750 x 1800 mm	1	1495KH6RDWB18TW

Heavy Duty Low Height MDF Top Workbenches with 6 Drawers Side Tower and 2-Leg



1495KH6WB15TD

880 x 750 x 1500 mm	1	1495KH6WB15TD
880 x 750 x 1800 mm	1	1495KH6WB18TD
880 x 750 x 1500 mm	1	1495KH6BKWB15TD
880 x 750 x 1800 mm	1	1495KH6BKWB18TD
880 x 750 x 1500 mm	1	1495KH6BLWB15TD
880 x 750 x 1800 mm	1	1495KH6BLWB18TD
880 x 750 x 1500 mm	1	1495KH6RDWB15TD
880 x 750 x 1800 mm	1	1495KH6RDWB18TD

1495KH8WB15TD

880 x 750 x 1500 mm	1	1495KH8WB15TD
880 x 750 x 1800 mm	1	1495KH8WB18TD
880 x 750 x 1500 mm	1	1495KH8BKWB15TD
880 x 750 x 1800 mm	1	1495KH8BKWB18TD
880 x 750 x 1500 mm	1	1495KH8BLWB15TD
880 x 750 x 1800 mm	1	1495KH8BLWB18TD
880 x 750 x 1500 mm	1	1495KH8RDWB15TD
880 x 750 x 1800 mm	1	1495KH8RDWB18TD

Heavy Duty Low Height Wooden Top Workbenches with 7 Drawers Side Tower and 2-Leg



1495KH7WB15TW

880 x 750 x 1500 mm	1	1495KH7WB15TW
880 x 750 x 1800 mm	1	1495KH7WB18TW
880 x 750 x 1500 mm	1	1495KH7BKWB15TW
880 x 750 x 1800 mm	1	1495KH7BKWB18TW
880 x 750 x 1500 mm	1	1495KH7BLWB15TW
880 x 750 x 1800 mm	1	1495KH7BLWB18TW
880 x 750 x 1500 mm	1	1495KH7RDWB15TW
880 x 750 x 1800 mm	1	1495KH7RDWB18TW

Heavy Duty Low Height MDF top Workbenches with 7 Drawers Side Tower and 2-Leg



1495KH7WB15TD

880 x 750 x 1500 mm	1	1495KH7WB15TD
880 x 750 x 1800 mm	1	1495KH7WB18TD

Steel Top Kit for Convert 1475K Tool Trolley to Workbench



1495KW-TS

1030 x 750 x 1500 mm	1	1495KW15TS
1030 x 750 x 1800 mm	1	1495KW18TS



Heavy Duty Wooden Countertop Kit for Convert 1475k Series Trolley to Workbench



1495KWB-TW



1030 x 750 x 1500 mm	1	1495KWB15TW
1030 x 750 x 1800 mm	1	1495KWB18TW

Heavy Duty Chestnut Top Workbenches with 4-Leg



1495WB-TW



1030 x 750 x 1500 mm	1	1495WB15TW
1030 x 750 x 1800 mm	1	1495WB18TW
1030 x 750 x 1500 mm	1	1495WB15TWGR
1030 x 750 x 1800 mm	1	1495WB18TWGR

Heavy Duty Steel Top Workbenches & Bottom Tray with 4 Legs - 1800 mm



1495WB18TSBT



1030 x 750 x 1800 mm	1	1495WB18TSBT
1030 x 750 x 1800 mm	1	1495WB18TSBLBT

Heavy Duty MDF Countertop Kit for Convert 1475k Series Trolley to Workbench



1495KWB-TD



1030 x 750 x 1500 mm	1	1495KWB15TD
1030 x 750 x 1800 mm	1	1495KWB18TD

Heavy Duty MDF Top Workbenches with 4-Leg



1495WB-TD



1030 x 750 x 1500 mm	1	1495WB15TD
1030 x 750 x 1800 mm	1	1495WB18TD
1030 x 750 x 1500 mm	1	1495WB15TDGR
1030 x 750 x 1800 mm	1	1495WB18TDGR

Heavy Duty Steel Top Workbenches with Adjustable Height 4-Leg



1495WBAH-TS



850 x 750 x 1500 mm	1	1495WBAH15TS
850 x 750 x 1500 mm	1	1495WBAH15TSBL
850 x 750 x 1800 mm	1	1495WBAH18TS
850 x 750 x 1800 mm	1	1495WBAH18TSBK
850 x 750 x 1800 mm	1	1495WBAH18TSBL
850 x 750 x 1800 mm	1	1495WBAH18TSRED

Heavy Duty Steel Top Workbenches with 4-Leg



1495WB-TS



1030 x 750 x 1500 mm	1	1495WB15TS
1030 x 750 x 1800 mm	1	1495WB18TS
1030 x 750 x 1500 mm	1	1495WB15TSBK
1030 x 750 x 1800 mm	1	1495WB18TSBK
1030 x 750 x 1500 mm	1	1495WB15TSBL
1030 x 750 x 1800 mm	1	1495WB18TSBL
1030 x 750 x 1500 mm	1	1495WB15TSRED
1030 x 750 x 1800 mm	1	1495WB18TSRED

Heavy Duty Steel Top Workbenches & Bottom Tray with 4 Legs - 1500 mm



1495WB15TSBT



1030 x 750 x 1500 mm	1	1495WB15TSBT
----------------------	---	--------------

Heavy Duty Chestnut Top Workbenches with Adjustable Height 4-Leg



1495WBAH-TW



850 x 750 x 1500 mm	1	1495WBAH15TW
850 x 750 x 1800 mm	1	1495WBAH18TW
850 x 750 x 1800 mm	1	1495WBAH18TWGR

Heavy Duty MDF Top Workbenches with Adjustable Height 4-Leg



1495WBAH-TD



850 x 750 x 1500 mm	1	1495WBAH15TD
850 x 750 x 1800 mm	1	1495WBAH18TD

MDF and Galvanized Top Portable Workbenches



1495FWBTD



840 x 510 x 970 mm	1	1495FWB097TD
840 x 510 x 1200 mm	1	1495FWB120TD

Galvanized Top Foldable Workbenches



1495FWBTS



840 x 510 x 970 mm	1	1495FWB097TS
840 x 510 x 1200 mm	1	1495FWB120TS

Steel Bottom Trays for 1495WB Workbenches



1495WB1-AC



30 x 504 x 1500 mm	1	1495WB15-AC1
30 x 504 x 1800 mm	1	1495WB18-AC1
30 x 500 x 1500 mm	1	1495WB15-AC1GR
30 x 504 x 1800 mm	1	1495WB18-AC1GR

Drawers with Trays or Dividers for 1495WB Workbenches



1495WB-AC



105 x 500 x 500 mm	1	1495WB-AC1
160 x 528 x 570 mm	1	1495WB-AC2

CABINETS & PANELS

Wall or Bench Mount Cabinet with Shutter



1495CS1



900 x 170 x 1500 mm	1	1495CS15
900 x 170 x 1800 mm	1	1495CS18
900 x 170 x 1500 mm	1	1495CS15BK
900 x 170 x 1800 mm	1	1495CS18BK
900 x 170 x 1500 mm	1	1495CS15BL
900 x 170 x 1800 mm	1	1495CS18BL
900 x 170 x 1500 mm	1	1495CS15RED
900 x 170 x 1800 mm	1	1495CS18RED

Wall or Bench Mount Cabinet with Shutter and Hooks



1495CS18HK



900 x 170 x 1800 mm	1	1495CS18HK
900 x 170 x 1800 mm	1	1495CS18BLHK

Heavy Duty Tool Panels with Reinforced Frame

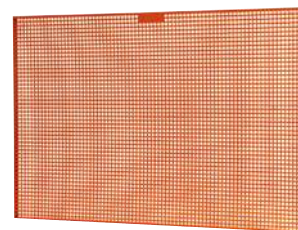

1495TP



500 x 23 x 600 mm	1	1495TP06
800 x 25 x 1200 mm	1	1495TP12
800 x 23 x 1500 mm	1	1495TP15
800 x 23 x 1800 mm	1	1495TP18
500 x 25 x 600 mm	1	1495TP06GR
800 x 25 x 1200 mm	1	1495TP12GR
800 x 25 x 1495 mm	1	1495TP15GR
800 x 25 x 1800 mm	1	1495TP18GR

Heavy Duty Tool Hanger Panels with Reinforced Frame



1495TP09



900 x 25 x 500 mm	1	1495TP09
-------------------	---	----------



Wheeled Heavy Duty Pyramid Shape Tool Panels



1495TP10W



1500 x 450 x 1000 mm

1 1495TP10W

2-Door Wall Mount Tool Cabinets



1495CD60



900 x 250 x 602 mm
900 x 250 x 602 mm
900 x 250 x 602 mm
900 x 250 x 602 mm

1 1495CD60
1 1495CD60BK
1 1495CD60BL
1 1495CD60RED

2-Door Wheeled Tool Cabinets



1495CD60W



1605 x 450 x 625 mm
1605 x 450 x 625 mm
1605 x 450 x 625 mm
1605 x 450 x 625 mm

1 1495CD60W
1 1495CD60WBK
1 1495CD60WBL
1 1495CD60WRED

Hook Kit for 1495 Cabinet and Panel - 24 Pcs

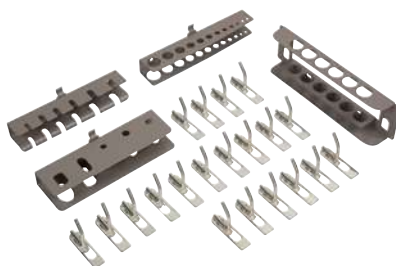

1495CD-AC1



1.22 kg



1 1495CD-AC1

Hook Kit for 1495 Cabinet and Panel - 35 Pcs

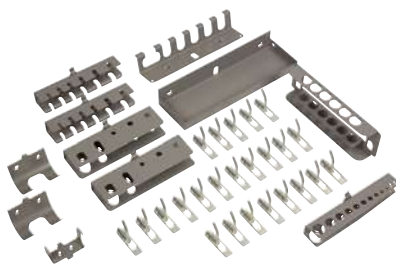

1495CS-AC1



2.11 kg



1 1495CS-AC1

Tool Panel Adaptors for Wooden and MDF Workbench Tops



1495TP-AC1



9.5 kg



1 1495TP-AC1

Combination Wrenches 12-Slot Holders for Tool Panels



1495TP-AC10



0.43 kg



1 1495TP-AC10

Pin Punch 6-Slot Holders for Tool Panels

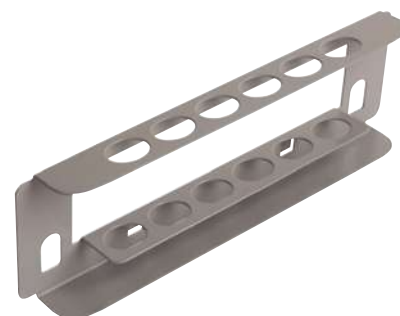

1495TP-AC11



0.16 kg



1 1495TP-AC11

Hammer 1-Slot Holders for Tool Panels



1495TP-AC12



0.07 kg



1 1495TP-AC12

T-Handle 1-Slot Holders for Tool Panels



1495TP-AC13

0.04 kg	1	1495TP-AC13

Plastic Trays for Tool Panels



1495TP-AC4

0.125 kg	1	1495TP-AC4

Grip 1-Slot Hooks for Tool Panels



1495TP-AC7

0.79 kg	1	1495TP-AC7

Trays for Tool Panels



1495TP-AC2

0.44 kg	1	1495TP-AC2

Screwdriver 6-Slot Hooks for Tool Panels

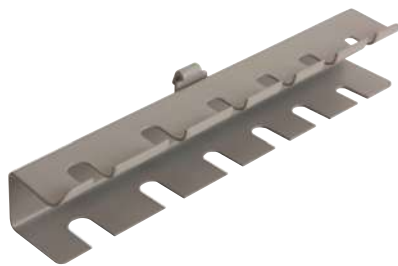

1495TP-AC5

0.14 kg	1	1495TP-AC5

Hexagon 12-Slot L-Key Hooks for Tool Panels

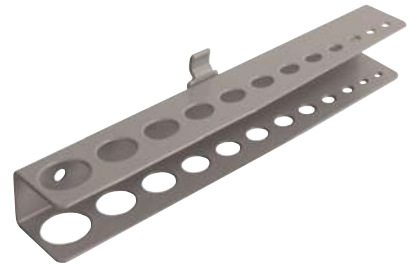

1495TP-AC8

0.12 kg	1	1495TP-AC8

Socket Hook and Tray Kit for Tool Panels



1495TP-AC3

0.45 kg	1	1495TP-AC3

Pliers 5-Slot Hooks for Tool Panels



1495TP-AC6

0.17 kg	1	1495TP-AC6

Double Socket Wrench 12-Slot Hooks for Tool Panel



1495TP-AC9

0.43 kg	1	1495TP-AC9



L/U Shaped Hooks Set for Tool Panels - 5 Pcs



1495TP-ACH

kg	
0.116 kg	1 1495TP-ACHL20
0.125 kg	1 1495TP-ACHL40
0.144 kg	1 1495TP-ACHL65
0.17 kg	1 1495TP-ACHL90
0.102 kg	1 1495TP-ACHU20
0.125 kg	1 1495TP-ACHU40
0.146 kg	1 1495TP-ACHU65
0.162 kg	1 1495TP-ACHU90

Hanging Rail for 1495TP09 Panels



1495TP09-RAIL

40 x 57 x 440 mm	1 1495TP09-RAIL

METALLIC TOOL BOXES

Heavy Duty Metallic Tool Boxes with 3 Drawers



1483KHD3RB

	g	
305 x 233 x 523 mm	13050 g	1 1483KHD3RB

Heavy Duty Metallic Tool Boxes with 4 Drawers



1483KHD4RB

	g	
390 x 260 x 593 mm	15200 g	1 1483KHD4RB

Heavy Duty Metallic Tool Boxes with 3 Drawers



1484THD3RB

	kg	
300 x 220 x 520 mm	12.40 kg	1 1484THD3RB

Metallic Tool Boxes with 2 Drawers



1483K2RB

	g	
277 x 257 x 525 mm	8200 g	1 1483K2RB

Metallic Tool Boxes with 3 Drawers



1483K3RB

	g	
334 x 260 x 523 mm	10200 g	1 1483K3RB

Carts for 1483K Metallic Boxes



1483CART

	kg	
200 x 270 x 655 mm	6.02 kg	1 1483CART

Mason Tool Chests 530 mm x 290 mm x 290 mm



1496MB2

	kg	
290 x 290 x 530 mm	40 kg	1 1496MB2

Mason Tool Chests 690 mm x 360 mm x 310 mm



1496MB3

310 x 360 x 690 mm	60 kg	1	1496MB3

Mason's Tool Chests 100 mm x 170 mm x 573 mm



1497MB08

100 x 170 x 573 mm	30 kg	1	1497MB08

Metallic Tool Boxes with 5 Compartments and Locking Capability



3149-OR

200 x 220 x 530 mm	4370 g	1	3149-OR

Mason Tool Chests 830 mm x 440 mm x 340 mm



1496MB4

340 x 440 x 830 mm	80 kg	1	1496MB4

Mason's Tool Chests 100 mm x 230 mm x 605 mm



1497MB13

100 x 230 x 605 mm		1	1497MB13

Metallic Tool Boxes with 3/5 Compartments and Locking Capability



9601

190 x 210 x 300 mm	2450 g	1	960100010
190 x 210 x 400 mm	3400 g	1	960100020
190 x 210 x 500 mm	3670 g	1	960100030
245 x 210 x 400 mm	4400 g	1	960100050
245 x 210 x 500 mm	4840 g	1	960100060

Mason Tool Chests 910 mm x 530 mm x 530 mm



1496MB5

530 x 530 x 910 mm	150 kg	1	1496MB5

Mason's Tool Chests 122 mm x 270 mm x 640 mm



1497MB18

122 x 270 x 640 mm	30 kg	1	1497MB18

Cantilever Style Tool Boxes with 3 Compartments



1497MBF350

160 x 200 x 530 mm	10 kg	1	1497MBF350



Cantilever Style Tool Boxes with 5 Compartments



1497MBF550

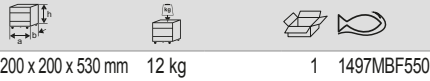

200 x 200 x 530 mm 12 kg 1 1497MBF550

24 L Open Top Fabric Tool Bags with Rigid Base



3100TB

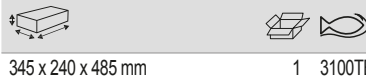

345 x 240 x 485 mm 1 3100TB

32 L Closed Top Fabric Tool Bags with Rigid Base



4750FB2-19A



370 x 230 x 470 mm 4 4750FB2-19A

Cantilever Style Tool Boxes with 7 Compartments



1497MBF750



250 x 200 x 530 mm 15 kg 1 1497MBF750

32 L Open Top Fabric Tool Bags with Rigid Base



4750FB1-19A



355 x 230 x 470 mm 1 4750FB1-19A

48 L Closed Top Fabric Tool Bags with Rigid Base



4750FB2-24A



380 x 260 x 600 mm 2 4750FB2-24A

TEXTILE & LEATHER EQUIPMENT

Backpack with Anti-Slip Plastic Hard Bottom



4750FB8



560 x 190 x 335 mm 4 4750FB8

32 L Open Top Deluxe Fabric Tool Bags with Rigid Base



4750FB1-19B



365 x 225 x 480 mm 4 4750FB1-19B

73 L Wheeled Fabric Tool Bags with Telescopic Handle



4750FB2W-24A



385 x 325 x 665 mm 1 4750FB2W-24A

12 L Electrician Fabric Tool Bags



4750FB3-12



285 x 190 x 285 mm



1 4750FB3-12

36 L Closed Top Fabric Tool Bags



4750FB6-19



290 x 265 x 480 mm



1 4750FB6-19

2.38 L Fabric Tool Folders with Handle



4750-SF-1



0,96 kg



55 x 220 x 485 mm



1 4750-SF-1

17 L Laptop and Tool Bags



4750FB4-18



350 x 150 x 430 mm



4 4750FB4-18

Fabric Tool Bags for 416-SET-1



4750-LV-1



85 x 43 x 1800 mm

51 x 43 x 1800 mm



1 4750-LV-1

1 4750-LV-2

2.9 L Fabric Tool Folders with Handle



4750-SF-2



60 x 265 x 485 mm



1 4750-SF-2

21 L Closed Top Fabric Tool Bags



4750FB6-13



275 x 250 x 310 mm



1 4750FB6-13

24 L Open Top Fabric Tool Bags with Rigid Base - 9 pc Display



3100TB-DISP



300 x 555 x 715 mm



1 3100TB-DISP

2.4 L Mini Fabric Tool Folders



4750FB5A



50 x 168 x 273 mm



1 4750FB5A



6 L Medium Fabric Tool Folders with Rubberized Handle



4750FB5B



62 x 275 x 330 mm

1 4750FB5B

11 L Fabric Tool Folder with Rubberised Handle for 2x 1/3 Fit&Go Foams



4750FB5-FG2



90 x 210 x 470 mm

1 4750FB5-FG2

Electrician Leather Tool Cases



4750-VDEC



290 x 190 x 445 mm

1 4750-VDEC

12 L Max Fabric Tool Folders with Rubberized Handle



4750FB5C



80 x 305 x 403 mm

8 4750FB5C

Folding Front Leather Tool Cases



4750-FOLT-1



290 x 195 x 440 mm

1 4750-FOLT-1

Zip Bags 3 Units Set - 90 mm



4750FB7-01



135 x 10 x 215 mm

60 4750FB7-01

8 L Fabric Tool Folder with Rubberised Handle for 1x 1/3 Fit&Go Foam



4750FB5-FG1



65 x 210 x 470 mm

1 4750FB5-FG1

Tube Style Leather Tool Cases



4750-TOCST-1



220 x 170 x 495 mm

1 4750-TOCST-1

Zip Bags 3 Units Set - 145 mm



4750FB7-02



205 x 10 x 310 mm

60 4750FB7-02

BAHCO

Orange Zip Bag - 90 mm



4750FB7ORLT



135 x 10 x 215 mm



120 4750FB7ORLT

Heavy Duty Belts with Cushion and Stainless Steel Twin-Pin Buckle



4750-HDB-2



190 x 50 x 900 mm



1 4750-HDB-2

Junior Three Pouch Belt Set



4750-JU3PB



125 x 55 x 395 mm



1 4750-JU3PB-1

Orange Zip Bag - 145 mm



4750FB7ORBG



205 x 10 x 310 mm



120 4750FB7ORBG

Heavy Duty Belt Set



4750-HDBS-2



330 x 170 x 900 mm



1 4750-HDBS-2

Heavy Duty Leather Belts



4750-HDLB



47 x 4 x 1380 mm



1 4750-HDLB-1

Three-Pouch Belt Set for Waist up to 48"



4750-3PB



234 x 105 x 570 mm



1 4750-3PB-1

Quick Release Fabric Adjustable Belts



4750-QRFB-1



50 x 4 x 1180 mm



1 4750-QRFB-1

Two Pocket Fixings Pouches



4750-2PP



285 x 130 x 265 mm



1 4750-2PP-1



Universal Pouches



4750-UP



302 x 140 x 250 mm



1 4750-UP-1

Multipurpose Holders



4750-MPH-1



240 x 50 x 155 mm



1 4750-MPH-1

Vertical Mobile Phone Holders



4750-VMPH-1



170 x 35 x 100 mm



1 4750-VMPH-1

Right and Left Handed Drill Holders



4750-DHO-3



320 x 73 x 175 mm



1 4750-DHO-3

Squeeze Knife Holders



4750-KNHO-1



205 x 35 x 105 mm



1 4750-KNHO-1

Roll Covers for Tools



4750-ROCO-1



320 x 5 x 370 mm



1 4750-ROCO-1

Electrician's Pouches



4750-EP



345 x 120 x 260 mm



1 4750-EP-1

Knife Holders for ERGO™ Series Knives



4750-KNHO-0



200 x 10 x 85 mm



1 4750-KNHO-0

Flooring and Roofing Knee Pads



4750-KP



210 x 50 x 175 mm



1 4750-KP-1

Black Leather Secateur Holster



PROF-TL



30 x 90 x 245 mm



4 PROF-TL

Braces with Clips



4750-BWC-1



750 x 20 x 105 mm



1 4750-BWC-1

PLASTIC BOXES & CASES

500 mm Heavy Duty Plastic Tool Boxes



4750PTB50



27 l



20 kg



3 4750PTB50

600 mm Heavy Duty Plastic Tool Boxes



4750PTB60



37 l



20 kg



3 4750PTB60

470 mm Heavy Duty Plastic Tool Boxes



4750PTBW47



60 l



30 kg



1 4750PTBW47

650 mm Heavy Duty Plastic Tool Boxes



4750PTB65



285 x 300 x 650 mm



2 4750PTB65

670 mm Heavy Duty Plastic Tool Boxes



4750PTBW67



420 x 472 x 675 mm



50 kg



1 4750PTBW67

Double Wall Shock Absorbing Case



4750BMC



51 x 117 x 260 mm



1 4750BMC3

67 x 214 x 230 mm

1 4750BMC4

70 x 230 x 280 mm

1 4750BMC5

90 x 230 x 320 mm

1 4750BMC5.5

93 x 257 x 357 mm

1 4750BMC6

76 x 256 x 355 mm

1 4750BMC7

80 x 287 x 380 mm

1 4750BMC9

105 x 297 x 393 mm

1 4750BMC9.5

84 x 341 x 450 mm

1 4750BMC10



TOOLSETS

Rigid Case General Purpose Toolkit - 109 Pcs



2010



109 480 x 180 x 330 mm 1 2010

1952M-6, 1952M-7, 1952M-8, 1952M-9, 1952M-10, 1952M-11, 1952M-12, 1952M-13, 1952M-14	
4020L-M-3, 4020L-M-3.2, 4020L-M-3.5, 4020L-M-4, 4020L-M-4.5, 4020L-M-5.5	
BE-8340, BE-8350, BE-8355	
700-1.5-50, 700-1.2-50, 700-1-50, 700-1.8-50	
3659/8T	
5550-3.2, 5550-4.5	
BE-8220S, BE-8050S, BE-8255S	
5516 I	
5577-145	
5418	
2535L	
3524	
2648	
1150-1/2H/P	
1952Z-1/4, 1952Z-3/8, 1952Z-1/2	
BE-8620S	
BE-7845, BE-7806	
701-0-50, 701-00-50	
8045LVDE	
5574-145	
2-470-16-1-0x 6	
5515GV	
5423	
326000300	
328000000	
2656 R	
BE-3529	
BE-6400M-4, BE-6400M-5, BE-6400M-5.5, BE-6400M-7	
BE-8160	
BE-8600, BE-8610	
1995LM-1.5, 1995LM-2, 1995LM-2.5, 1995LM-3, 1995LM-4	
1997M/10T	
2047-0.8-4, 2047-1-5.5	
2421 D-140IP	

2430 GC-200 IP	
2530-40	
2744	
4750RC021	
7372I-2.5-75	
8070 C	
2223 S-150	

Leather Bag Electrician Toolkit - 28 Pcs



3049-2



180 x 435 x 270 mm 1 3049-2

268	
5470-140	
111M-7, 111M-8, 111M-10, 111M-13	
2744	
2427 S-200	
8045LVDE	
BE-9765	
2705R	
481-300	
9072 P	
2628 S-180	
2101S-160	
BE-8820S	
BE-8220S, BE-8040S, BE-8050S, BE-8255S	
BE-8610S, BE-8620S	
B146.006.100	
4750-FOLTC-1	

Leather Bag Electrician Toolkit - 16 Pcs



982000170



290 x 195 x 440 mm 1 982000170

4750-FOLTC-1	
2101GC-160IP	
2800 N	
2630GC-160IP	
2421GC-160	
2521GC-160	
8071 C IP	
B196.065.150, B196.055.125, B196.030.100, B196.040.100	
B197.002.100, B197.001.080	
SC127	
2820EF2	
MTB-3-16	
6224	

Fabric Tool Bag Service Engineer's Toolkit - 51 Pcs



4750FB4-18TS001



450 mm 190 mm 1 4750FB4-18TS001

4750FB4-18	
2101G-160	
2628 G-180	
2430 G-160	
1RM/SH8	
7223	
2233 D-200	
SL25	
9070	
9031	
483-20	
BE-8020, BE-8040	
BE-8150, BE-8155	
BE-8610, BE-8620	
SC127	
SQZ150003	
BE-9777	
MTB-5-25	

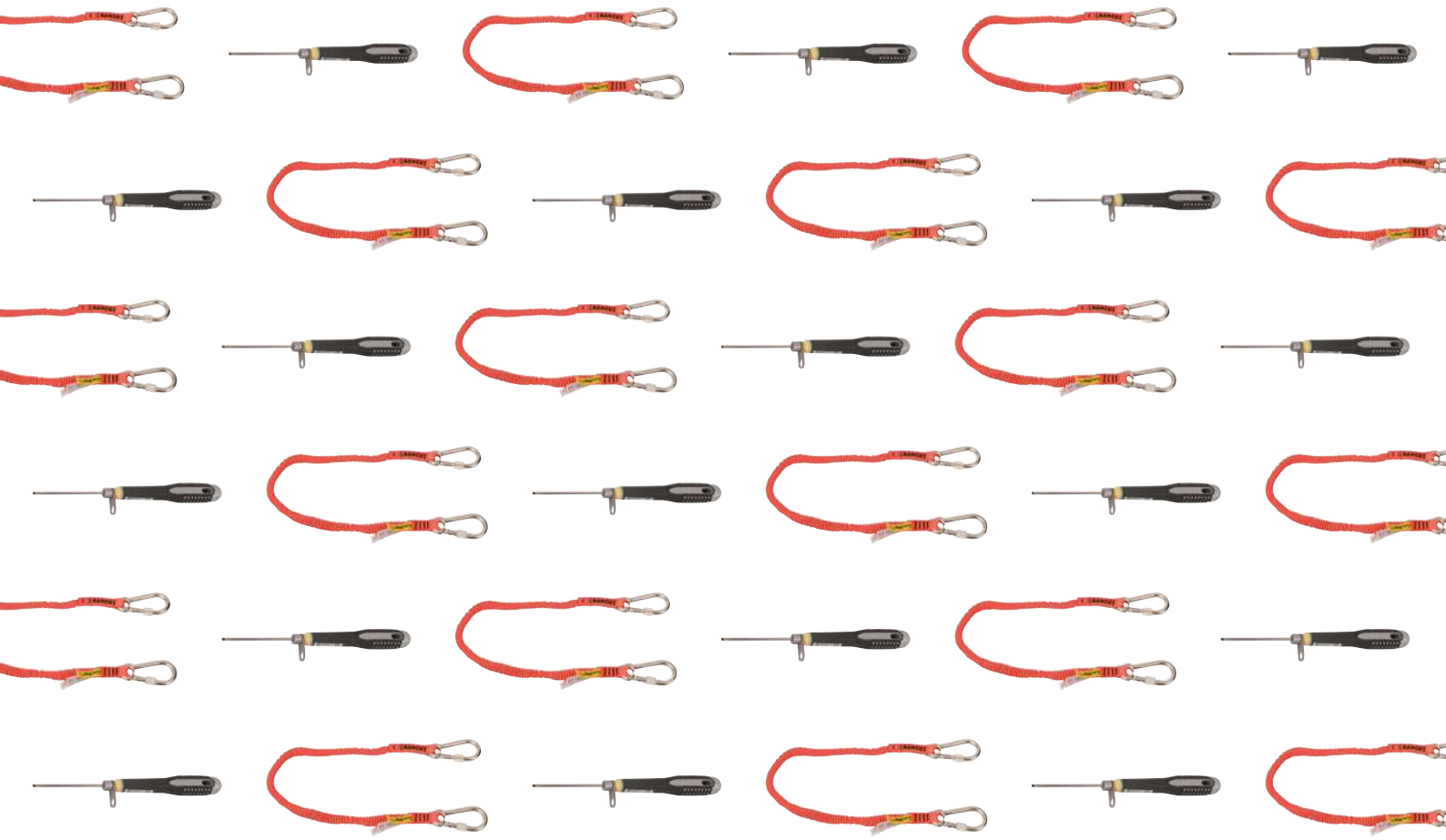

Tools @ Height



TOOL STORAGE & LANYARDS

High Visibility Orange Strap Lanyards with Swivel Carabiner 1 kg



3875-LY60



g



135 g

1 3875-LY60

Strap Lanyards with Fixed Carabiner and Interchangeable Loop 1 kg



3875-LY3

g



125 g

8 3875-LY3

Wrist Lanyards with Exchangeable Loop and Barrel Lock 1 kg



3875-WL1

g



40 g

8 3875-WL1

Connecting Loops for Lanyard



3875-QL1

g



40 g

8 3875-QL1

Retractable Lanyards with Fixed Carabiner 0.9 kg



3875-RL1

g



200 g

1 3875-RL1

Connecting Loops for Retractable Lanyard



3875-QRL1

g



40 g

1 3875-QRL1

Retractable Lanyards with Fixed Carabiner 1 kg



3875-RL2

g



212 g

1 3875-RL2

High Visibility Orange Strap Lanyards with Fixed Carabiner 3 kg



3875-LY70

g



172 g

1 3875-LY70

Strap Lanyards with Fixed Carabiner and Locking Device 3 kg



3875-LY4

g



180 g

8 3875-LY4

Strap Lanyards with Fixed Carabiner 3 kg



3875-LY1

g



170 g

8 3875-LY1

Strap Lanyards with Fixed Carabiner and Fixed Loop 3 kg



3875-LY2

g



120 g

8 3875-LY2

High Visibility Orange Strap Lanyards with Fixed Carabiner 6 kg



3875-LY8



330 g



1 3875-LY8

Coiled Lanyards with 1.5 mm Wire Loop String



439000001



130 g



1 439000001

Coiled Lanyards with Swivel Carabiner 3 kg



439000003



160 g



1 439000003

High Visibility Orange Strap Lanyards with Fixed Carabiner 12 kg



3875-LY10



270 g



1 3875-LY10

Steel String Lanyards



3875-SL1



10 g



1 3875-SL1

High Visibility Orange Strap Lanyards with Plastic Clip



439000004



13 g



1 439000004

Coiled Lanyards with 1 mm Wire Loop String



439000000



100 g



1 439000000

Coiled Lanyards with Swivel Carabiner 2 kg



439000002



130 g



1 439000002

Bags for Working at Height



3875-HB10



260 x 130 x 130 mm



1 3875-HB10



Lifting Bags with Single Reinforced Lifting Straps



3875-HB30/3875-HB60

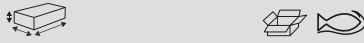

270 x 270 x 350 mm
350 x 350 x 640 mm

1 3875-HB30
8 3875-HB60

Backpacks with Durable Polyester Small Size



3875-BP1

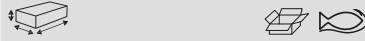

100 x 300 x 400 mm

8 3875-BP1

Pouches with 2 Large Pockets and 6 Safety Rings for Lanyard Attachment



3875-MHP6

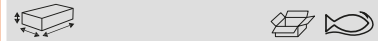

10 x 200 x 380 mm

1 3875-MHP6

Lifting Bags with Double Reinforced Lifting Straps



3875-HB100

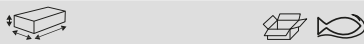

400 x 400 x 900 mm

1 3875-HB100

Backpacks with Durable Polyester Large Size



3875-BP2

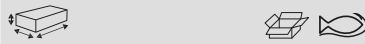

210 x 330 x 450 mm

8 3875-BP2

Three Pouch Set Belts with 4 Safety Rings for Lanyard Attachment



3PB-2

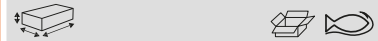

100 x 380 x 630 mm

1 4750-3PB-2

Rigid Case Lifting Bags with Double Reinforced Lifting Straps



3875-SB70

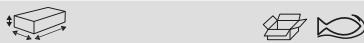

730 x 300 x 500 mm

1 3875-SB70

Pouches with 2 Large Pockets and 4 Safety Rings for Lanyard Attachment



3875-MHP4

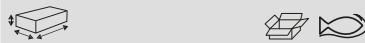

70 x 200 x 400 mm

1 3875-MHP4

Drill Holster Belt Pouches with 1 Safety Ring for Lanyard Attachment



4750-DHO-4

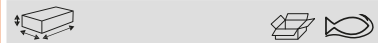

300 x 150 x 270 mm

1 4750-DHO-4

5 m and 8 m Measuring Tape Pouches with 1 Safety Ring for Lanyard Attachment



4750-MTHO-TAH

70 x 105 x 230 mm	1 4750-MTHO-TAH

Heavy Duty Belts with 6 Safety Ring for Lanyard Attachment



4750-HDLB-TAH

50 x 120 x 460 mm	1 4750-HDLB-TAH

Podger Wrenches with Safety D-Shackle



TAH84

405mm/16"	41 mm	1 TAH84-PODGER

Universal Pouches with 2 Large Pockets and 4 Safety Rings for Lanyard Attachment



4750-UP-2

300 x 150 x 300 mm	1 4750-UP-2

WRENCHES

ERGO™ 90 Series Adjustable Wrenches with Quick Link



TAH90

158mm/6"	20 mm	1 TAH9070
250mm/10"	31 mm	1 TAH9072

Metric Combination Wrenches with Safety Spring



TAH111M

6 mm	112 mm	1 TAH111M-6
7 mm	120 mm	1 TAH111M-7
8 mm	130 mm	1 TAH111M-8
9 mm	136 mm	1 TAH111M-9
10 mm	144 mm	1 TAH111M-10
11 mm	153 mm	1 TAH111M-11
12 mm	160 mm	1 TAH111M-12
13 mm	165 mm	1 TAH111M-13
14 mm	177 mm	1 TAH111M-14
15 mm	185 mm	1 TAH111M-15
16 mm	195 mm	1 TAH111M-16
17 mm	200 mm	1 TAH111M-17
18 mm	208 mm	1 TAH111M-18
19 mm	215 mm	1 TAH111M-19
20 mm	240 mm	1 TAH111M-20
21 mm	250 mm	1 TAH111M-21
22 mm	250 mm	1 TAH111M-22
23 mm	270 mm	1 TAH111M-23
24 mm	270 mm	1 TAH111M-24
25 mm	290 mm	1 TAH111M-25
27 mm	310 mm	1 TAH111M-27
30 mm	330 mm	1 TAH111M-30
32 mm	345 mm	1 TAH111M-32
34 mm	347 mm	1 TAH111M-34
36 mm	400 mm	1 TAH111M-36
41 mm	438 mm	1 TAH111M-41
46 mm	500 mm	1 TAH111M-46
50 mm	540 mm	1 TAH111M-50
55 mm	560 mm	1 TAH111M-55
85 mm	780 mm	1 TAH111M-85

Hammer Holster Belt Pouches with 1 Safety Ring for Lanyard Attachment



4750-HHO-2

120 x 70 x 180 mm	1 4750-HHO-2

80 Series Adjustable Wrenches with Quick Link



TAH80

110mm/4"	13 mm	1 TAH8069
155mm/6"	20 mm	1 TAH8070
205mm/8"	27 mm	1 TAH8071
255mm/10"	31 mm	1 TAH8072
305mm/12"	34 mm	1 TAH8073
380mm/15"	44 mm	1 TAH8074
460mm/18"	53 mm	1 TAH8075
110mm/4"	13 mm	1 TAH8069C
155mm/6"	20 mm	1 TAH8070C
205mm/8"	27 mm	1 TAH8071C
255mm/10"	31 mm	1 TAH8072C
305mm/12"	34 mm	1 TAH8073C
380mm/15"	44 mm	1 TAH8074C
460mm/18"	53 mm	1 TAH8075C



Imperial Combination Wrenches with Safety Spring



TAH111Z

Size	Length (mm)	Quantity	Part Number
1/4 in	112 mm	1	TAH111Z-1/4
5/16 in	130 mm	1	TAH111Z-5/16
3/8 in	140 mm	1	TAH111Z-3/8
7/16 in	153 mm	1	TAH111Z-7/16
1/2 in	169 mm	1	TAH111Z-1/2
9/16 in	177 mm	1	TAH111Z-9/16
5/8 in	195 mm	1	TAH111Z-5/8
11/16 in	200 mm	1	TAH111Z-11/16
3/4 in	218 mm	1	TAH111Z-3/4
13/16 in	250 mm	1	TAH111Z-13/16
7/8 in	250 mm	1	TAH111Z-7/8
15/16 in	270 mm	1	TAH111Z-15/16
1 in	290 mm	1	TAH111Z-1
1-1/16 in	310 mm	1	TAH111Z-1.1/16
1-1/8 in	310 mm	1	TAH111Z-1.1/8
1-1/4 in	350 mm	1	TAH111Z-1.1/4
1-5/16 in	350 mm	1	TAH111Z-1.5/16
1 3/8 in	410 mm	1	TAH111Z-1.3/8
1 7/16 in	410 mm	1	TAH111Z-1.7/16
1 1/2 in	410 mm	1	TAH111Z-1.1/2
1 5/8 in	460 mm	1	TAH111Z-1.5/8
1 11/16 in	460 mm	1	TAH111Z-1.11/16
1 3/4 in	500 mm	1	TAH111Z-1.3/4
1 13/16 in	500 mm	1	TAH111Z-1.13/16
1 7/8 in	540 mm	1	TAH111Z-1.7/8
2 in	540 mm	1	TAH111Z-2
2 1/8 in	560 mm	1	TAH111Z-2.1/8
2 1/4 in	600 mm	1	TAH111Z-2.1/4
2 3/8 in	600 mm	1	TAH111Z-2.3/8
2 1/2 in	680 mm	1	TAH111Z-2.1/2
2 5/8 in	680 mm	1	TAH111Z-2.5/8
2 3/4 in	680 mm	1	TAH111Z-2.3/4
2 7/8 in	730 mm	1	TAH111Z-2.7/8
3 in	730 mm	1	TAH111Z-3

Ratcheting Combination Wrenches with Safety Spring



TAH1RM

Size	Length (mm)	Quantity	Part Number
6 mm	128 mm	1	TAH1RM-6
7 mm	140 mm	1	TAH1RM-7
8 mm	140 mm	1	TAH1RM-8
9 mm	150 mm	1	TAH1RM-9

Size	Length (mm)	Quantity	Part Number
10 mm	159 mm	1	TAH1RM-10
11 mm	165 mm	1	TAH1RM-11
12 mm	172 mm	1	TAH1RM-12
13 in	178 mm	1	TAH1RM-13
14 in	191 mm	1	TAH1RM-14
15 in	200 mm	1	TAH1RM-15
16 in	208 mm	1	TAH1RM-16
17 mm	226 mm	1	TAH1RM-17
18 in	237 mm	1	TAH1RM-18
19 mm	248 mm	1	TAH1RM-19
21 in	290 mm	1	TAH1RM-21
22 in	361 mm	1	TAH1RM-22
24 mm	323 mm	1	TAH1RM-24
27 in	359 mm	1	TAH1RM-27
30 mm	400 mm	1	TAH1RM-30
32 in	425 mm	1	TAH1RM-32

Metric Deep Offset Double Ring End Spanners with Chrome Finish with Stainless Steel Sliding Spring



TAH2M

Size	Length (mm)	Quantity	Part Number
6x7 mm	165 mm	1	TAH2M-6-7
8x9 mm	180 mm	1	TAH2M-8-9
10x11 mm	190 mm	1	TAH2M-10-11
12x13 mm	210 mm	1	TAH2M-12-13
14x15 mm	226 mm	1	TAH2M-14-15
16x17 mm	246 mm	1	TAH2M-16-17
18x19 mm	266 mm	1	TAH2M-18-19

Metric Double Open End Wrenches with Safety Spring



TAH6M

Size	Length (mm)	Quantity	Part Number
6x7 mm	122 mm	1	TAH6M-6-7
8x9 mm	135 mm	1	TAH6M-8-9
10x11 mm	153 mm	1	TAH6M-10-11
12x13 mm	164 mm	1	TAH6M-12-13

Size	Length (mm)	Quantity	Part Number
14x15 mm	183 mm	1	TAH6M-14-15
16x17 mm	201 mm	1	TAH6M-16-17
17x19 mm	222 mm	1	TAH6M-17-19
18x19 mm	222 mm	1	TAH6M-18-19
20x22 mm	225 mm	1	TAH6M-20-22
24x27 mm	260 mm	1	TAH6M-24-27
30x32 mm	300 mm	1	TAH6M-30-32

Flare Nut Wrenches with Safety Spring



TAH1949M

Size	Length (mm)	Quantity	Part Number
8x9 mm	140 mm	1	TAH1949M-8-9
10x11 mm	150 mm	1	TAH1949M-10-11
12x14 mm	170 mm	1	TAH1949M-12-14
14x17 mm	200 mm	1	TAH1949M-14-17
19x22 mm	220 mm	1	TAH1949M-19-22
24x27 mm	255 mm	1	TAH1949M-24-27

Ring End Slogging Wrenches with D-Shackle



TAH7444SG

Size	Length (mm)	Quantity	Part Number
36 mm	205 mm	1	TAH7444SG-M-36
41 mm	230 mm	1	TAH7444SG-M-41
46 mm	240 mm	1	TAH7444SG-M-46
50 mm	255 mm	1	TAH7444SG-M-50
55 mm	270 mm	1	TAH7444SG-M-55

Metric Double Head Offset Socket Spanners with 6 x 6-Point Dynamic Drive™ with Stainless Steel Ring



TAH29



Size	Quantity	Part Number
12 mm	1	TAH29M-12
6 mm	1	TAH29M-6
7 mm	1	TAH29M-7
8 mm	1	TAH29M-8
10 mm	1	TAH29M-10
9 mm	1	TAH29M-9
11 mm	1	TAH29M-11
13 mm	1	TAH29M-13
14 mm	1	TAH29M-14
15 mm	1	TAH29M-15
16 mm	1	TAH29M-16
17 mm	1	TAH29M-17
18 mm	1	TAH29M-18
19 mm	1	TAH29M-19
20 mm	1	TAH29M-20
21 mm	1	TAH29M-21
22 mm	1	TAH29M-22
23 mm	1	TAH29M-23
24 mm	1	TAH29M-24
25 mm	1	TAH29M-25
26 mm	1	TAH29M-26
27 mm	1	TAH29M-27
28 mm	1	TAH29M-28
29 mm	1	TAH29M-29
30 mm	1	TAH29M-30
32 mm	1	TAH29M-32

Ratchet Wrenches with Safety Ring and Dee Shackle



TAHSC2RM



Size	Length	Quantity	Part Number
13-17 mm	280 mm	1	TAHSC2RM-13-17
15-17 mm	280 mm	1	TAHSC2RM-15-17
19-22 mm	310 mm	1	TAHSC2RM-19-22
27-30 mm	450 mm	1	TAHSC2RM-27-30

Aluminium Pipe Wrenches with Quick Link



TAH380

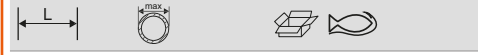

Size	Length	Quantity	Part Number
253 mm	1.1/2 in	1	TAH380-10
354 mm	2 in	1	TAH380-14
455 mm	2.1/2 in	1	TAH380-18
607 mm	3 in	1	TAH380-24

SOCKETS & RATCHETS

1/4" Square Drive Sockets with Metric Hex Profile and 4 point solution



TAH08

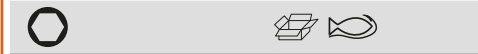

Size	Quantity	Part Number
5.5 mm	1	TAH08-5.5
6 mm	1	TAH08-6
7 mm	1	TAH08-7
8 mm	1	TAH08-8
9 mm	1	TAH08-9
10 mm	1	TAH08-10
11 mm	1	TAH08-11
12 mm	1	TAH08-12
13 mm	1	TAH08-13

Switch Cabinet Wrenches with Dyneema Ready to Work at Height



TAHMK5

Size	Quantity	Part Number
97x25 mm	1	TAHMK5

Swedish Model 90° Pipe Wrenches with Bow Shackle



TAH14



Size	Length	Quantity	Part Number
210 mm	3/4 in	1	TAH140
320 mm	1 in	1	TAH141
426 mm	1 1/2 in	1	TAH142
557 mm	2-1/2 in	1	TAH143

1/4" Square Drive Breaker Bars with Safety Spring



TAH6958B-1

Size	Quantity	Part Number
150 mm	1	TAH6958B-1



1/4" Square Drive Extension Bars with 4 Holes



TAH6960-TAH6962L

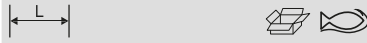

50 mm	1	TAH6960
101 mm	1	TAH6961
152 mm	1	TAH6962
355 mm	1	TAH6962L

1/4" Square Drive Universal Joints with 4 Holes



TAH6966

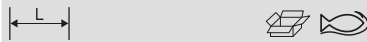

36 mm	1	TAH6966
-------	---	---------

1/4" Square Drive Socket Drivers for Metric Hex Head Screws with 4 Points Solution



TAH08-H



3 mm	1	TAH08-H3
4 mm	1	TAH08-H4
5 mm	1	TAH08-H5
6 mm	1	TAH08-H6
8 mm	1	TAH08-H8

1/4" Square Drive Socket Drivers for Phillips Head Screws with 4 Points Solution



TAH08-PH

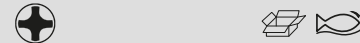

1	1	TAH08-PH1
2	1	TAH08-PH2
3	1	TAH08-PH3

1/4" Square Drive Socket Drivers for TORX® Head Screws with 4 Points Solution



TAH08TTAH

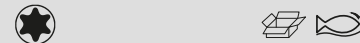

T-8	1	TAH08-T8
T-9	1	TAH08-T9
T-10	1	TAH08-T10
T-15	1	TAH08-T15
T-20	1	TAH08-T20
T-25	1	TAH08-T25
T-27	1	TAH08-T27
T-30	1	TAH08-T30
T-40	1	TAH08-T40

1/4" Square Drive Reversible Ratchets with Sealed Dyneema String



TAH6950



120 mm	1	TAH6950
--------	---	---------

1/4" Square Drive Spinner Handles with Safety Chuck



TAH6956-1

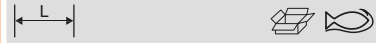

150 mm	1	TAH6956-1
--------	---	-----------

1/2" Square Drive Sockets with Metric Bi-Hex Profile and 4 Point Solution



TAH16B

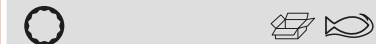

8 mm	1	TAH16B-8
10 mm	1	TAH16B-10
11 mm	1	TAH16B-11
12 mm	1	TAH16B-12
13 mm	1	TAH16B-13
14 mm	1	TAH16B-14
15 mm	1	TAH16B-15
16 mm	1	TAH16B-16
17 mm	1	TAH16B-17
18 mm	1	TAH16B-18
19 mm	1	TAH16B-19
21 mm	1	TAH16B-21
22 mm	1	TAH16B-22
24 mm	1	TAH16B-24
25 mm	1	TAH16B-25
27 mm	1	TAH16B-27
30 mm	1	TAH16B-30
32 mm	1	TAH16B-32

1/2" Square Drive Sockets with Imperial Bi-Hex Profile and 4 Point Solution



TAH16B"

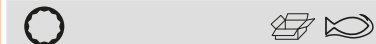

1/2 in	1	TAH16B-1/2
9/16 in	1	TAH16B-9/16



5/8 in	1	TAH16B-5/8
11/16 in	1	TAH16B-11/16
3/4 in	1	TAH16B-3/4
13/16 in	1	TAH16B-13/16
7/8 in	1	TAH16B-7/8
15/16 in	1	TAH16B-15/16
1 in	1	TAH16B-1
1 1/16 in	1	TAH16B-1.1/16
1 1/8 in	1	TAH16B-1.1/8
1 1/4 in	1	TAH16B-1.1/4

1/2" Universal Joints with 4 Point Solution



TAH8166



67 mm



1 TAH8166

1/2" Breaker Bars with Safety Spring



TAH8158B-1



256 mm



1 TAH8158B-1

1/2" Extension Bars with 4 Holes



TAH8160-8162



125 mm
250 mm



1 TAH8160
1 TAH8162

1/2" Square Drive Socket Drivers for Metric Hex Head Screws with 4 point solution



TAH16H



4 mm
5 mm
6 mm
7 mm
8 mm
10 mm
12 mm
14 mm
17 mm
19 mm



1 TAH16-H4
1 TAH16-H5
1 TAH16-H6
1 TAH16-H7
1 TAH16-H8
1 TAH16-H10
1 TAH16-H12
1 TAH16-H14
1 TAH16-H17
1 TAH16-H19

1/2" Square Drive Socket Drivers for Imperial Hex Head Screws with 4 point solution



TAH16H"



1/4 in
5/16 in
3/8 in



1 TAH16H-1/4
1 TAH16H-5/16
1 TAH16H-3/8



7/16 in	1	TAH16H-7/16
1/2 in	1	TAH16H-1/2
9/16 in	1	TAH16H-9/16
5/8 in	1	TAH16H-5/8

1/2" Square Drive Socket Drivers for TORX® Head Screws with 4 Points Solution



TAH16-T



T30	1	TAH16-T30
T40	1	TAH16-T40
T45	1	TAH16-T45
T50	1	TAH16-T50
T55	1	TAH16-T55
T60	1	TAH16-T60

1/2" Reversible Ratchets with Sealed Dyneema String



TAH8150-1/2



270 mm



1 TAH8150-1/2



1/2" Square Drive Socket Set with Metric Hex Profile and Pear Head Ratchet - 22 pcs for Working at Height



TAH16BM/22



85 x 350 x 445 mm

1 TAH16BM/22

1/2" Square Drive Socket Set with Imperial Hex Profile and Pear Head Ratchet - 17 pcs for Working at Height



TAH16BZ/17



80 x 300 x 380 mm

1 TAH16BZ/17

3/4" Square Drive Sockets with Metric Hex Profile and 4 point solution



TAH24B



- | | |
|-------|-------------|
| 27 mm | 1 TAH24B-27 |
| 30 mm | 1 TAH24B-30 |
| 32 mm | 1 TAH24B-32 |
| 36 mm | 1 TAH24B-36 |
| 38 mm | 1 TAH24B-38 |
| 41 mm | 1 TAH24B-41 |
| 46 mm | 1 TAH24B-46 |
| 50 mm | 1 TAH24B-50 |

3/4" Square Drive Extension Bars with 4 Point Solution



TAH8961



200 mm

1 TAH8961

3/4" Square Drive Universal Handles with Loop Wire



TAH8953



500 mm

1 TAH8953

3/4" Square Drive Reversible Ratchet Heads with Loop Wire



TAH8950N/A



170 mm

1 TAH8950N/A

Stubby Pin Releasers for TAH Sockets



TAHPINRELEASER



4 mm

45 mm

1 TAHPINRELEASER

SCREWDRIVERS

ERGO™ Slotted Screwdrivers with Safety Chuck



TAHBE8020L-TAHBE8252



- | | | |
|--------|--------|---------------|
| 3.2 mm | 75 mm | 1 TAHBE-8020L |
| 3.5 mm | 75 mm | 1 TAHBE-8030 |
| 4 mm | 100 mm | 1 TAHBE-8040 |
| 5.5 mm | 150 mm | 1 TAHBE-8241 |
| 6.5 mm | 150 mm | 1 TAHBE-8252 |

ERGO™ Slotted Screwdrivers with Dyneema String



TAHBE8155



- | | | |
|------|--------|--------------|
| 6 mm | 125 mm | 1 TAHBE-8155 |
| 8 mm | 175 mm | 1 TAHBE-8257 |
| 8 mm | 210 mm | 1 TAHBE-8258 |

ERGO™ Bolster Screwdrivers for Slotted Head Screws with Dyneema String



TAHBE-8260



9 mm	175 mm	1	TAHBE-8260
12 mm	200 mm	1	TAHBE-8880

ERGO™ Bolster Screwdrivers for Phillips Head Screws with Dyneema String



TAHBE-8630



PH 3	155 mm	1	TAHBE-8630

ERGO™ Bolster Screwdrivers for Pozidriv Head Screws with Dyneema String



TAHBE-8830



PZ 3	150 mm	1	TAHBE-8830

ERGO™ Stubby Screwdrivers for Slotted Head Screws with Safety Chuck



TAHBE-8350



5.5 mm	28 mm	1	TAHBE-8350

ERGO™ Stubby Screwdrivers for Phillips Head Screws with Safety Chuck



TAHBE-8602



PH2	30 mm	1	TAHBE-8602

ERGO™ Screwdrivers for TORX® Head Screws with Safety Chuck



TAHBE8910-TAHBE8930



T10	2.72 mm	1	TAHBE-8910
T15	3.26 mm	1	TAHBE-8915
T20	3.84 mm	1	TAHBE-8920
T25	4 mm	1	TAHBE-8925
T30	6 mm	1	TAHBE-8930

ERGO™ Screwdrivers for Phillips Head Screws with Safety Chuck



TAHBE8610-TAHBE8624



PH 1	75 mm	1	TAHBE-8611
PH 1	75 mm	1	TAHBE-8610
PH 2	100 mm	1	TAHBE-8620
PH 2	200 mm	1	TAHBE-8620L
PH 3	150 mm	1	TAHBE-8623
PH 4	190 mm	1	TAHBE-8624

ERGO™ Screwdrivers for Pozidriv Head Screws with Safety Chuck



TAHBE8810-TAHBE8820



PZ 1	73 mm	1	TAHBE-8810
PZ 2	100 mm	1	TAHBE-8820

ERGO™ Insulated Slotted Screwdrivers with Kevlar String



TAHBE8040S-TAHBE8050S



3.0 mm	100 mm	1	TAHBE-8220S
4.0 mm	100 mm	1	TAHBE-8040S
5.5 mm	125 mm	1	TAHBE-8050S
6.5 mm	155 mm	1	TAHBE-8255S



ERGO™ Insulated Phillips Screwdrivers with Kevlar String



TAHBE8610S-TAHBE8620S

Bit Type	Length	Quantity	Part Number
PH1	80 mm	1	TAHBE-8610S
PH2	100 mm	1	TAHBE-8620S
PH3	150 mm	1	TAHBE-8630S
PH4	190 mm	1	TAHBE-8640S

Slotted Screwdrivers with Precision Grip 0.18–0.8 mm with Stainless Steel Ring



TAH700

Bit Size	Length	Quantity	Part Number
1.5 mm	137 mm	1	TAH700-1.5-50
1.8 mm	137 mm	1	TAH700-1.8-50
2.5 mm	137 mm	1	TAH700-2.5-50
3 mm	187 mm	1	TAH700-3-100

Metric Hex L-Keys with Phosphate Finish with Stainless Steel Ring



TAH1995M

Size	Quantity	Part Number
8 mm	1	TAH1995M-8
10 mm	1	TAH1995M-10
12 mm	1	TAH1995M-12

ERGO™ Insulated TORX® Head Screwdrivers with Kevlar String



TAHBE8910S-TAHBE8930S

Bit Type	Length	Quantity	Part Number
T10	2.5 mm	1	TAHBE-8910S
T15	3.26 mm	1	TAHBE-8915S
T20	3.84 mm	1	TAHBE-8920S
T25	4.4 mm	1	TAHBE-8925S
T30	5.49 mm	1	TAHBE-8930S

Phillips Screwdrivers with Precision Grip PH00-PH1 with Stainless Steel Ring



TAH701

Bit Type	Length	Quantity	Part Number
PH00	137 mm	1	TAH701-00-50
PH 0	137 mm	1	TAH701-0-50

Imperial Hex L-Keys with Phosphate Finish with Stainless Steel Ring



TAH1995Z

Size	Quantity	Part Number
1/2 in	1	TAH1995Z-1/2

ERGO™ Slim VDE Insulated Pozidriv Screwdrivers with 3-Component Handle with Kevlar Cord



TAHBE-8820SL

Bit Type	Quantity	Part Number
PZ 2	1	TAHBE-8820SL

Torx® Screwdrivers with Precision Grip T4-T20 with Stainless Steel Ring



TAH703

Bit Size	Length	Quantity	Part Number
T 6	137 mm	1	TAH703-6-50
T 7	137 mm	1	TAH703-7-50
T 8	137 mm	1	TAH703-8-50
T 9	137 mm	1	TAH703-9-50
T 10	137 mm	1	TAH703-10-50
T 15	162 mm	1	TAH703-15-75

Metric Hex Folding L-Key Set with Phosphate Finish 1.5–6 mm - 7 pcs with Kevlar Textile Wire Loop



TAHBE-9776

Size	Quantity	Part Number
1.5, 2, 2.5, 3, 4, 5, 6 mm	1	TAHBE-9776

1.5, 2, 2.5, 3, 4, 5, 6 mm

Metric Offset Screwdriver Hex Key Folders with Kevlar String - 7 Pcs



TAHE-9777B



2.5,3,4,5,6,8,10 mm

1 TAHE-9777B

Imperial Offset Screwdriver Hex Key Folders with Insert Plate - 7 Pcs



TAHE-9787



3/32, 1/8, 5/32, 3/16, 1/4, 5/16, 3/8 in

1 TAHE-9787

Double Offset Keys for Slotted Screws with Steel Wire



TAH2047



4.0 mm

1 TAH2047-0.8-4

Double Offset Keys for Phillips Screws with Steel Wire



TAH2047PR



PH 1 & 2

1 TAH2047PR-1-2

PLIERS

ERGO™ Side Cutting Pliers with Safety Ring



ergo



TAH2101G



130 mm	1 TAH2101G-125
145 mm	1 TAH2101G-140
165 mm	1 TAH2101G-160
185 mm	1 TAH2101G-180
125 mm	1 TAH2101G-125C
145 mm	1 TAH2101G-140C
165 mm	1 TAH2101G-160C
180 mm	1 TAH2101G-180C

ERGO™ Combination Pliers with Safety Ring



ergo



TAH2628G



170 mm	1 TAH2628G-160
190 mm	1 TAH2628G-180
200 mm	1 TAH2628G-200

2 Position Combination Pliers with Safety Ring



TAH2970G



200 mm	1 TAH2970G-200
--------	----------------

Double Offset Keys for Slotted Screws with Steel Wire



TAH21HDG



4.0 mm

1 TAH21HDG-0.8-4

ERGO™ Heavy Duty Side Cutting Pliers with Safety Ring



ergo



TAH21HDG



210 mm	1 TAH21HDG-200
200 mm	1 TAH21HDG-200C

ERGO™ Snipe Nose Pliers with Safety Ring



ergo



TAH2430G



160 mm	1 TAH2430G-160
200 mm	1 TAH2430G-200



ERGO™ Snipe Nose Pliers with 45° Bent Tips and Safety Ring



ergo



TAH2427G



200 mm



1 TAH2427G-200

Internal Circlip Pliers with Straight Jaws and Phosphate Finish with Stainless Steel Ring



TAH2800



150 mm
180 mm



1 TAH2800-150
1 TAH2800-180

Self Grip Locking Pliers with Curved Jaws with Fixed Metallic Plate



TAH2953



140 mm
300 mm



1 TAH2953-140
1 TAH2953-300

ERGO™ Wire Stripping Pliers with Safety Ring



ergo



TAH2223G-150



167 mm



1 TAH2223G-150

External Circlip Pliers with Straight Jaws and Phosphate Finish with Stainless Steel Ring



TAH2900



180 mm



1 TAH2900-180

Grips with Straight Jaws and Insert Plate



TAH2958



200 mm
245 mm



1 TAH2958-200
1 TAH2958-250

Ratcheting Crimping Pliers for Insulated Connectors with Fixed Metallic Wire Loop



TAHCRW01



225 mm



0.5-6.0 mm²



1 TAHCRW01

TAH Universal grip with curved jaws. 0



TAH2951



235 mm



1 TAH2951-250

ERGO™ Water Pump Pliers with Safety Ring



ergo



TAH8224



250 mm



1 TAH8224

Wire Twisting Pliers with Safety Ring



TAH2855



232 mm



1 TAH2855

Traditional Hand Hacksaw Frames with Loop Wire



TAH320



500 mm



1 TAH320

ERGO™ Flat Files with Safety Ring



ergo®



TAH1-100



265 mm

2

1 TAH1-100-06-2-4

CUTTING TOOLS

Folding Pruning Saws with Dual-Component Handle with Sealed Dyneema Cord



TAH396



190 mm

7 1/2 in



1 TAH396-JT

Hacksaw Frames with Loop Wire for All Round Use



TAH317



432 mm

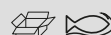

1 TAH317

ERGO™ Engineering Tapered Edge Flat Files Bastard/Second/Smooth Cut with Permanent Stainless Steel Ring



ergo®



TAH1-110



200 mm

1

1 TAH1-110-08-1-2

ERGO™ Professional Hand Hacksaw Frames with Loop Wire



ergo®



TAH325



300 mm



1 TAH325

Aluminium Hand Hacksaw Frames with Loop Wire



TAH225



310 mm



1 TAH225-PLUS

ERGO™ Mill Files with 2 Flat Edges and Safety Ring



ergo®



TAH1-143



415 mm

1

1 TAH1-143-12-1-2



ERGO™ Engineering Square Files
Bastard/Second/Smooth Cut with
Permanent Stainless Steel Ring



ergo®



TAH1-160



200 mm	1	1	TAH1-160-08-1-2

ERGO™ Round Files with Safety Chuck



ergo®



TAH1-230



260 mm	2	1	TAH1-230-06-2-2
310 mm	1	1	TAH1-230-08-1-2

Retractable Utility Knives with Dyneema
Textile Wire Loop



TAH8687



172 mm	1 TAH868700000

ERGO™ Engineering 3 Square Files
Bastard/Second/Smooth Cut with
Permanent Stainless Steel Ring



ergo®



TAH1-170



200 mm	1	1	TAH1-170-08-1-2

Heavy Duty Electrician Scissors with Wire
Loop



TAHSCB140G



145 mm	43 mm	1	TAHSCB140G

Utility Wire Brushes With Wooden Handle



TAH52-TAH782-U



150 mm		1	TAH52
290 mm		1	TAH782-U

ERGO™ Half-Round Files with Safety
Ring



ergo®



TAH1-210



270 mm	2	1	TAH1-210-06-2-2
325 mm	1	1	TAH1-210-08-1-2

Electrician Knives with Dyneema String



TAH2820EF



195 mm	85 mm	1	TAH2820EF2

HAMMERS, PRY BARS & CHISELS

Dead Blow Sledge Hammers with Wire
Loop and Anti-Sliding Handle



TAH3625PU



620 g	340 mm	1	TAH3625PU-50

Nylon Tip Mallets with Wire Loop



TAH3625PW



300 mm		1	TAH3625W-35

Club Hammers with Wire Loop and Hickory Handle



TAH484



1000 g	260 mm	1	TAH484-1000
1500 g	280 mm	1	TAH484-1500
2000 g	305 mm	1	TAH484-2000

Spanish Type Bricklayer Hammers with Wire Loop



TAH486F



700 g	330 mm	1	TAH486F-700

Ball Pein Hammers with Wire Loop and Hickory Handle



TAH479



480 g	350 mm	1	TAH479-16
900 g	400 mm	1	TAH479-32

Safety Sledge Hammers with Wire Loop



TAH489



1100 g	294 mm	1	TAH489-1100
1800 g	300 mm	1	TAH489-1800
2700 g	770 mm	1	TAH489-2700
3600 g	770 mm	1	TAH489-3600
4500 g	797 mm	1	TAH489-4500
5400 g	795 mm	1	TAH489-5400
6300 g	780 mm	1	TAH489-6300

Carpenter's Hammer Spike Claw with Tubular Steel Shaft with Wire Loop



TAH485



600 g		1	TAH485

German DIN Hammers with Wire Loop



TAH481



300 g	300 mm	1	TAH481-300

Ball Pein Hammers with Unbreakable Handle and Fixed Metallic Wire Loop



TAH490



700 g	340 mm	1	TAH490-700
900 g	340 mm	1	TAH490-900
1100 g	340 mm	1	TAH490-1100

Non-Sparking and Anti-Magnetic Hammers with Aluminium Bronze Shackle



TAH487



4500 g	895 mm	1	TAH487-5200



TAH Special steel hexagonal bar



TAHWBB



595 mm	1	TAHWBB600
680 mm	1	TAHWBB700

Bi-Material Parallel Punches with Safety Chuck



TAH3734BM



155 mm	2 mm	1	TAH3734BM-2
155 mm	3 mm	1	TAH3734BM-3
165 mm	4 mm	1	TAH3734BM-4
165 mm	5 mm	1	TAH3734BM-5
185 mm	6 mm	1	TAH3734BM-6
185 mm	8 mm	1	TAH3734BM-8
185 mm	10 mm	1	TAH3734BM-10

Bi-Material Centre Punches with Safety Chuck



TAH3755BM



165 mm	4 mm	1	TAH3755BM-4

Cold Chisels with Safety Ring



TAH3640



250 mm	1	TAH3640-250-C

Pointed Chisels with Octagonal Shank and Lacquered Copper Finish with Fixed Metallic Wire Loop



TAH3739



300 mm	1	TAH3739-300

Pry Bars with PVC Handle and Safety Ring



TAH2484



305 mm	1	TAH2484-30

Cam Pry Bars with Bow Shackle



TAH3683



400 mm	1	TAH3683

Rolling Head Pry Bars with Phosphated Body with Fixed Metallic Wire Loop



TAH3681



304 mm	1	TAH3681-11
406 mm	1	TAH3681-16
503 mm	1	TAH3681-20

MEASURING & LAYOUT

Long Measuring Tapes with Nylon Coated Blade and Open Case with Dyneema Textile Wire Loop



TAHLTS

30 m	13 mm	1	TAHLTS-30

Metric Stainless Steel Rulers with Dyneema Textile Wire Loop



TAHSR300

300 mm	1	TAHSR300-MM

Scaffold Levels with Dyneema String



TAH466

250 mm	1	TAH466-250

Combination Squares with Dyneema String



TAHCS300

300 mm	125 mm	1 TAHCS300

Carpenter Squares with Dyneema String



TAH9048-250

250 mm	165 mm	1 TAH9048-250

Squares with Dyneema String



TAH9045-B-250

250 mm	170 mm	1 TAH9045-B-250

Callipers with Safety Ring



TAH1150

7 x 75 x 235 mm	1	TAH1150-1/2H/P

Offset Scribes with Wire Loop



TAH1177

30 g	1	TAH1177-SCRIBE

Professional Feeler Gauges with Safety Ring



TAH1544

105 mm	1	TAH1544

TORQUE TOOLS

Mechanical Adjustable Torque Click Wrench with Marked Scale and Fixed Ratchet Head with Metallic Plate



TAH73R

1/2"	20-100 Nm	1	TAH73R-100
1/2"	40-200 Nm	1	TAH73R-200
1/2"	60-300 Nm	1	TAH73R-300

Torque Wrenches with Fixed Ratchet Head and Wire Loop



TAH7445

20-100 Nm	1/2 in	1 TAH7445-100A-1



Mechanical Torque Wrenches with Wire Loop



TAH7455

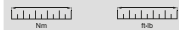

60-300 Nm 44.3-221.3 lb-ft



1 TAH7455-300-1

Reversible Ratchet Insert Tools with Safety Pin Locking Mechanism



TAH7852-1

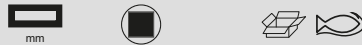

14X18 mm 1/2" 1 TAH7852-1

Miniature Awls/Hooks/Picks Tool Set with Kevlar Textile Wire Loop



TAH2633

146 g

1 TAH2633/S4

Torque Wrenches with Interchangeable Head and Wire Loop



TAH74W9

20-100 N·m 9x12 mm

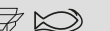

1 TAH74W9-100

F-Clamps with Safety Bow Shackle



TAH420SH-80-160

160 mm 80 mm 1 TAH420SH-80-160

Flexible Pick-up Tools with Wire Loop



TAH2509

560 mm

1 TAH2509

Reversible Ratchet Head Inserts with Locking Device



TAH7452-2

9x12 mm 1/2"

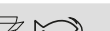

1 TAH7452-2

OTHER TOOLS

Carbon Scrapers with Safety Spring



TAH2487

205 mm 1 TAH2487

ERGO™ Magnetic Pick-ups with Dyneema String



TAH2535F2

13 mm 405 mm 1 TAH2535F2

Chain Oil Filter Wrenches with D-shackle



TAHBE64520



520 mm	60-160 mm	1	TAHBE64520

GLOVES

General Purpose Gloves with Absorption Pad



GL008

8 10	5 5	GL008-8 GL008-10

Head Torches with Dyneema String



TAHBFRL11



90 x 95 x 115 mm	1	TAHBFRL11

General Purpose Synthetic Leather Gloves



3875-GLOVE

9	67 g	5	3875-GLOVE

Grease Pumps with Quick Link



TAHBOD54

120 x 385 x 57 mm 135 x 400 x 61 mm	1 1	TAHBOD5400 TAHBOD5450

Power Tool Gloves with Absorption Pad and Anti-Vibration Pad



GL010

8 10	5 5	GL010-8 GL010-10



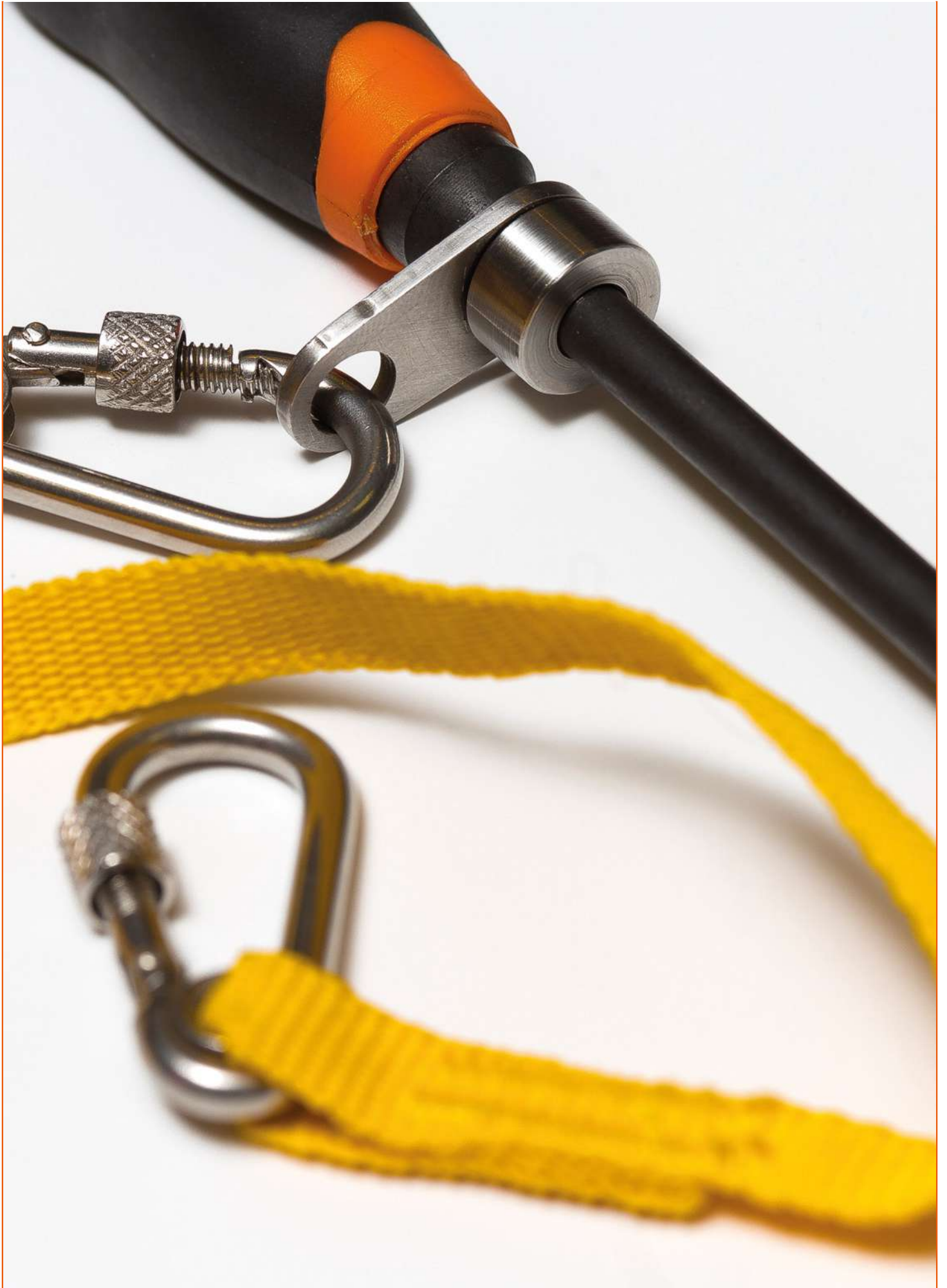

BAHCO



Insulated Tools



SCREWDRIVERS

ERGO™ VDE Insulated Slotted Screwdrivers with 3-Component Handle 2.5 mm-12 mm



ergo



BE-8010S - BE-8065S

Tip Size	Length	Quantity	Model
2.5 mm	75 mm	5	BE-8010S
3.0 mm	100 mm	5	BE-8220S
3.5 mm	100 mm	5	BE-8230S
4.0 mm	100 mm	5	BE-8040S
5.5 mm	125 mm	5	BE-8050S
6.5 mm	150 mm	5	BE-8255S
8.0 mm	175 mm	5	BE-8065S
10 mm	200 mm	5	BE-8258S
12 mm	200 mm	5	BE-8259S

ERGO™ VDE Insulated Phillips Screwdrivers with 3-Component Handle PH0-PH4



ergo



BE-8600S - BE-8640S

Tip Size	Length	Quantity	Model
PH 0	75 mm	5	BE-8600S
PH 1	80 mm	5	BE-8610S
PH1	80 mm	5	BE-8611S
PH 1	150 mm	5	BE-8612S
PH 2	100 mm	5	BE-8620S
PH 2	100 mm	5	BE-8621S
PH 2	175 mm	5	BE-8622S
PH 3	150 mm	5	BE-8630S
PH 4	200 mm	5	BE-8640S

ERGO™ VDE Insulated Pozidriv Screwdrivers with 3-Component Handle PZ0-PZ4



ergo



BE-8800S - BE-8840S

Tip Size	Length	Quantity	Model
PZ 0	75 mm	5	BE-8800S
PZ 1	80 mm	5	BE-8810S
PZ1	80 mm	5	BE-8811S
PZ 1	150 mm	5	BE-8812S
PZ 2	100 mm	5	BE-8820S
PZ 2	100 mm	5	BE-8821S
PZ 2	175 mm	5	BE-8822S
PZ 3	150 mm	5	BE-8830S
PZ 4	200 mm	5	BE-8840S

ERGO™ VDE Insulated TORX® Head Screwdrivers with 3-Component Handle T5-T30



ergo



BE-8910S - BE-8930S

Tip Size	Length	Quantity	Model
T 5	75 mm	5	BE-8905S
T 6	75 mm	5	BE-8906S
T 7	75 mm	5	BE-8907S
T 8	75 mm	5	BE-8908S
T 9	75 mm	5	BE-8909S
T 10	100 mm	5	BE-8910S
T 15	125 mm	5	BE-8915S
T 20	125 mm	5	BE-8920S
T 25	150 mm	5	BE-8925S
T 30	175 mm	5	BE-8930S

ERGO™ VDE Insulated Hex Socket-Head Screwdrivers with 3-Component Handle 2.5 mm-8 mm



ergo



BE-8725S - BE-8708S

Tip Size	Length	Quantity	Model
2.5 mm	100 mm	5	BE-8725S
3 mm	125 mm	5	BE-8703S
4 mm	150 mm	5	BE-8704S
5 mm	175 mm	5	BE-8705S
6 mm	150 mm	5	BE-8706S
8 mm	200 mm	5	BE-8708S

ERGO™ VDE Insulated Plus-Minus/Phillips-Tip Screwdrivers with 3-Component Handle 5.0/PH1-6.0/PH2



ergo



BE-8510S - BE-8520S

Tip Size	Length	Quantity	Model
5.0/PH1	80 mm	5	BE-8510S
6.0/PH2	100 mm	5	BE-8520S

ERGO™ VDE Insulated Plus-Minus/Pozidriv-Tip Screwdrivers with 3-Component Handle 5.0/PZ1-6.0/PZ2



ergo



BE-8710S - BE-8720S

Tip Size	Length	Quantity	Model
5.0/PZ1	80 mm	5	BE-8710S
6.0/PZ2	100 mm	5	BE-8720S

ERGO™ VDE Insulated Nut Drivers with 3-Component Handle 5.5 mm-10 mm



ergo



BE-7855S - BE-7810S

Tip Size	Length	Quantity	Model
5.5 mm	125 mm	5	BE-7855S
6 mm	125 mm	5	BE-7806S
7 mm	125 mm	5	BE-7807S
8 mm	125 mm	5	BE-7808S
9 mm	125 mm	5	BE-7809S
10 mm	125 mm	5	BE-7810S

ERGO™ VDE Insulated Plus-Minus/
Pozidriv-Tip Screwdriver Set with
3-Component Handle - 2 Pcs



ergo®



BE-9890S

X	g		
2	175 g	1	BE-9890S

BE-8710S, BE-8720S



ERGO™ VDE Insulated Slotted and
Phillips Screwdriver Set with 3-Component
Handle - 5 Pcs



ergo®



BE-9881S

X			
5		1	BE-9881S

BE-8220S, BE-8040S, BE-8050S



BE-8611S, BE-8621S



ERGO™ VDE Insulated Slotted
and Pozidriv Screwdriver Set with
3-Component Handle - 5 Pcs



ergo®



BE-9882S

X			
5		1	BE-9882S

BE-8220S, BE-8050S, BE-8040S



BE-8811S, BE-8821S



ERGO™ VDE Insulated Plus-Minus/
Phillips, Plus-Minus/Pozidriv-Tip
Screwdriver Set with 3-Component Handle
and 150 V-250 V voltage tester - 5 Pcs



ergo®



BE-9885S

X			
5		1	BE-9885S

806-1-1



BE-8520S, BE-8510S



BE-8710S, BE-8720S



ERGO™ VDE Insulated Slotted, Pozidriv
and Plus-Minus/Pozidriv-Tip Screwdriver
Set with 3-Component Handle - 6 Pcs



ergo®



BE-9884S

X			
6		1	BE-9884S

BE-8220S, BE-8040S



BE-8710S, BE-8720S



BE-8810S, BE-8820S



ERGO™ VDE Insulated Slotted
and Pozidriv Screwdriver Set with
3-Component Handle - 7 Pcs



ergo®



BE-9888S

X			
7		1	BE-9888S

BE-8040S, BE-8050S, BE-8010S,
BE-8220S



BE-8800S, BE-8821S, BE-8830S



ERGO™ VDE Insulated Slotted and
Phillips Screwdriver Set with 3-Component
Handle - 7 Pcs



ergo®



BE-9887S

X			
7		1	BE-9887S

806-1-1



BE-8010S, BE-8050S, BE-8230S,
BE-8040S

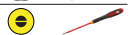

BE-8611S, BE-8621S



ERGO™ VDE Insulated Slotted
and Pozidriv Screwdriver Set with
3-Component Handle - 7 Pcs



ergo®

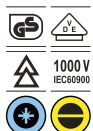

BE-9889S

X			
7		1	BE-9889S

BE-8010S, BE-8040S, BE-8050S,
BE-8230S



BE-8821S, BE-8811S



806-1-1



ERGO™ Slotted, Phillips, Pozidriv, TORX® and Plus-Minus/Pozidriv Screwdriver Set with Rubber Grip - 14 Pcs



ergo



BE-9876S

		14	1	BE-9876S
--	--	----	---	----------

BE-8010S, BE-8220S, BE-8230S, BE-8040S, BE-8050S		
BE-8611S, BE-8621S		
BE-8811S, BE-8821S		
BE-8910S, BE-8915S, BE-8920S		
BE-8710S, BE-8720S		

ERGO™ Slim VDE Insulated Slotted Screwdrivers with 3-Component Handle 3.0 mm-6.5 mm



ergo



BE-8220SL - BE-8255SL

3.0 mm	100 mm	10	BE-8220SL	
3.5 mm	100 mm	10	BE-8230SL	
4.0 mm	100 mm	10	BE-8040SL	
5.5 mm	125 mm	10	BE-8050SL	
6.5 mm	150 mm	10	BE-8255SL	

ERGO™ Slim VDE Insulated Phillips Screwdrivers with 3-Component Handle PH1-PH2



ergo



BE-8610SL - BE-8620SL

PH 1	80 mm	10	BE-8610SL
PH 2	100 mm	10	BE-8620SL

ERGO™ Slim VDE Insulated Pozidriv Screwdrivers with 3-Component Handle PZ1-PZ2



ergo



BE-8810SL - BE-8820SL

PZ 1	80 mm	10	BE-8810SL
PZ 2	100 mm	10	BE-8820SL

ERGO™ Slim VDE Insulated TORX® Screwdrivers with 3-Component Handle T10-T30



ergo



BE-8910SL - BE-8930SL

T 10	100 mm	5	BE-8910SL
T 15	100 mm	5	BE-8915SL
T 20	100 mm	5	BE-8920SL
T 25	125 mm	5	BE-8925SL
T 30	150 mm	5	BE-8930SL

ERGO™ Slim VDE Insulated Plus-Minus/Phillips-Tip Screwdrivers with 3-Component Handle for 5.0/PH1 - 6.0/PH2



ergo



BE-8510SL - BE-8520SL

5.0/PH1	80 mm	10	BE-8510SL
6.0/PH2	100 mm	10	BE-8520SL

ERGO™ Slim VDE Insulated Plus-Minus/Pozidriv-Tip Screwdrivers with 3-Component Handle 5.0/PZ1 - 6.0/PZ2



ergo



BE-8710SL - BE-8720SL

5.0/PZ1	80 mm	10	BE-8710SL
6.0/PZ2	100 mm	10	BE-8720SL

ERGO™ Slim VDE Insulated Plus-Minus/Pozidriv Screwdriver Set with 3-Component Handle - 2 Pcs



ergo



BE-9890SL

		2	175 g	1	BE-9890SL
--	--	---	-------	---	-----------

BE-8710SL, BE-8720SL

ERGO™ Slim VDE Insulated Phillips Screwdriver Set with 3-Component Handle - 2 Pcs



ergo



BE-9891SL

		2	132 g	1	BE-9891SL
--	--	---	-------	---	-----------

BE-8610SL, BE-8620SL

ERGO™ Slim VDE Insulated Pozidriv Screwdriver Set with 3-Component Handle - 2 Pcs



ergo

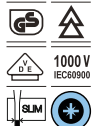

BE-9894SL

X	g		
2	132 g	1	BE-9894SL

BE-8810SL, BE-8820SL

ERGO™ Slim VDE Insulated TORX® Screwdriver Set with 3-Component Handle - 4 Pcs



ergo



BE-9880SL

X			
4		1	BE-9880SL

BE-8910SL, BE-8915SL, BE-8920SL, BE-8925SL

ERGO™ Slim VDE Insulated Slotted and Phillips Screwdriver Set with 3-Component Handle - 5 Pcs



ergo



BE-9881SL

X			
5		1	BE-9881SL

BE-8220SL, BE-8040SL, BE-8050SL
BE-8610SL, BE-8620SL

ERGO™ Slim VDE Insulated Slotted and Pozidriv Screwdriver Set with 3-Component Handle - 5 Pcs



ergo



BE-9882SL

X			
5		1	BE-9882SL

BE-8220SL, BE-8040SL, BE-8050SL
BE-8810SL, BE-8820SL

ERGO™ Slim VDE Insulated Slotted, Phillips and Torx® Screwdriver Set with 3-Component Handle - 5 pcs



ergo



BE-9871SL

X			
5		1	BE-9871SL

BE-8220SL, BE-8040SL
BE-8910SL
BE-8610SL, BE-8620SL

ERGO™ Slim VDE Insulated Slotted, Pozidriv and Torx® Screwdriver Set with 3-Component Handle - 5 pcs



ergo



BE-9872SL

X			
5		1	BE-9872SL

BE-8220SL, BE-8040SL
BE-8910SL
BE-8810SL, BE-8820SL

ERGO™ Slim VDE Insulated Slotted, Phillips, Pozidriv, Torx and Plus-Minus/ Phillips Screwdriver Set with 3-Component Handle - 12 Pcs



ergo



BE-9878SL

X			
12		1	BE-9878SL

BE-8010S
BE-8220SL, BE-8230SL, BE-8040SL, BE-8050SL
BE-8610SL, BE-8620SL
BE-8810SL, BE-8820SL
BE-8510SL, BE-8520SL
BE-8910SL

BahcoFit VDE Insulated Slotted Screwdrivers with Multi-Component Handle 2.5 mm-12 mm



B196

2.5 mm	75 mm	10	B196.025.075
3 mm	100 mm	10	B196.030.100
3.5 mm	100 mm	10	B196.035.100
4 mm	100 mm	10	B196.040.100
5.5 mm	125 mm	10	B196.055.125
6.5 mm	150 mm	10	B196.065.150
8 mm	175 mm	10	B196.080.175
10 mm	200 mm	10	B196.100.200
12 mm	200 mm	10	B196.120.200
2.5 mm	75 mm	1	SB196.025.075
3 mm	100 mm	1	SB196.030.100
3.5 mm	100 mm	1	SB196.035.100
4 mm	100 mm	1	SB196.040.100
5.5 mm	125 mm	1	SB196.055.125
6.5 mm	150 mm	1	SB196.065.150
8 mm	175 mm	1	SB196.080.175
10 mm	200 mm	1	SB196.100.200
12 mm	200 mm	1	SB196.120.200



BahcoFit VDE Insulated Phillips Screwdrivers with Multi-Component Handle PH0-PH4



B197PH

Tip	Length	Qty	Part No.
PH0	75 mm	10	B197.000.075
PH1	80 mm	10	B197.001.080
PH1	150 mm	10	B197.001.150
PH2	100 mm	10	B197.002.100
PH2	175 mm	10	B197.002.175
PH3	150 mm	10	B197.003.150
PH4	200 mm	10	B197.004.200
PH0	75 mm	1	SB197.000.075
PH1	80 mm	1	SB197.001.080
PH2	100 mm	1	SB197.002.100
PH3	150 mm	1	SB197.003.150
PH4	200 mm	1	SB197.004.200

BahcoFit VDE Insulated Pozidriv Screwdrivers with Multi-Component Handle PZ0-PZ3

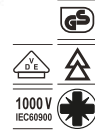

B142PZ

Tip	Length	Qty	Part No.
PZ0	75 mm	10	B142.000.075
PZ1	80 mm	10	B142.001.080
PZ1	150 mm	10	B142.001.150
PZ2	100 mm	10	B142.002.100
PZ2	175 mm	10	B142.002.175
PZ3	150 mm	10	B142.003.150
PZ0	75 mm	1	SB142.000.075
PZ1	80 mm	1	SB142.001.080
PZ2	100 mm	1	SB142.002.100
PZ3	150 mm	1	SB142.003.150

BahcoFit VDE Insulated TORX® Screwdrivers with Multi-Component Handle T10-T25



B150TORX

Tip	Length	Qty	Part No.
T10	100 mm	10	B150.010.100
T15	125 mm	10	B150.015.125

Tip	Length	Qty	Part No.
T20	125 mm	10	B150.020.125
T25	150 mm	10	B150.025.150
T10	100 mm	1	SB150.010.100
T15	125 mm	1	SB150.015.125
T20	125 mm	1	SB150.020.125
T25	150 mm	1	SB150.025.150

BahcoFit VDE Insulated Plus-Minus/Phillips-Tip Screwdrivers with Multi-Component Handle 5.0/PH1 - 6.0/PH2



B148

Tip	Length	Qty	Part No.
5.0mm/PH1	80 mm	10	B148.001.080
6.0mm/PH2	100 mm	10	B148.002.100
5.0mm/PH1	80 mm	1	SB148.001.080
6.0mm/PH2	100 mm	1	SB148.002.100

BahcoFit VDE Insulated Nut Drivers with Multi-Component Handle 5.5 mm-13 mm



B199

Tip	Length	Qty	Part No.
5,5 mm	125 mm	5	B199.055.125
6 mm	125 mm	5	B199.060.125
7 mm	125 mm	5	B199.070.125
8 mm	125 mm	5	B199.080.125
9 mm	125 mm	5	B199.090.125
10 mm	125 mm	5	B199.100.125
11 mm	125 mm	5	B199.110.125
12 mm	125 mm	5	B199.120.125
13 mm	125 mm	5	B199.130.125
5,5 mm	125 mm	1	SB199.055.125
6 mm	125 mm	1	SB199.060.125
7 mm	125 mm	1	SB199.070.125
8 mm	125 mm	1	SB199.080.125
9 mm	125 mm	1	SB199.090.125
10 mm	125 mm	1	SB199.100.125
11 mm	125 mm	1	SB199.110.125
12 mm	125 mm	1	SB199.120.125
13 mm	125 mm	1	SB199.130.125

BahcoFit VDE Insulated Plus-Minus/Pozidriv-Tip Screwdrivers with Multi-Component Handle 5.0/PZ1-6.0/PZ2



B149

Tip	Length	Qty	Part No.
5.0mm/PZ1	80 mm	10	B149.001.080
6.0mm/PZ2	100 mm	10	B149.002.100
5.0mm/PZ1	80 mm	1	SB149.001.080
6.0mm/PZ2	100 mm	1	SB149.002.100

BahcoFit VDE Insulated Slotted and Phillips Screwdriver Set with Multi-Component Handle - 2 Pcs



B220.002

Tip	Length	Qty	Part No.
X	g	1	B220.002

B196.030.100

B197.001.080

BahcoFit VDE Insulated Plus-Minus/Pozidriv-Tip Screwdriver Set with Multi-Component Handle - 2 Pcs



B220.012

Tip	Length	Qty	Part No.
X	g	1	B220.012

B149.001.080, B149.002.100

BahcoFit VDE Insulated Slotted and Phillips Screwdriver Set with Multi-Component Handle - 5 Pcs



B220.005



5 1 B220.005

B196.030.100, B196.040.100,
B196.055.125



B197.001.080, B197.002.100



BahcoFit VDE Insulated Slotted and Pozidriv Screwdriver Set with Multi-Component Handle - 5 Pcs



B220.015



5 1 B220.015

B196.035.100, B196.040.100,
B196.065.150



B142.001.080, B142.002.100



BahcoFit VDE Insulated Slotted and Phillips Screwdriver Set with Multi-Component Handle - 7 Pcs

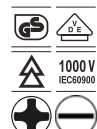

B220.007



7 1 B220.007

B196.030.100, B196.040.100,
B196.055.125, B196.065.150



B197.000.075, B197.001.080,
B197.002.100



BahcoFit VDE Insulated Slotted and Pozidriv Screwdriver Set with Multi-Component Handle - 7 Pcs



B220.017



7 1 B220.017

B196.025.075, B196.040.100,
B196.055.125, B196.065.150



B142.000.075, B142.001.080,
B142.002.100



BahcoFit VDE Insulated Slotted and Phillips Screwdriver Set with Multi-Component Handle and 150 V-250 V Voltage Tester - 7 Pcs



B220.027



7 1 B220.027

B196.030.100, B196.040.100,
B196.055.125



B197.000.075, B197.001.080,
B197.002.100



806-1-1



VDE Insulated Slotted Screwdrivers with Multi-Component Handle 3.0 mm-6.5 mm



623

3.0 mm	100 mm	10	623-3-100
3.5 mm	100 mm	10	623-3.5-100
4.0 mm	100 mm	10	623-4-100
5.5 mm	125 mm	10	623-5.5-125
6.5 mm	150 mm	10	623-6.5-150

VDE Insulated Phillips Screwdrivers with Multi-Component Handle PH0-PH2



625PH

PH 0	100 mm	10	625-0-100
PH 1	150 mm	10	625-1-150
PH 2	175 mm	10	625-2-175

VDE Insulated Slotted and Phillips Screwdriver Set with Multi-Component Handle - 6 Pcs



620-6

6	1	620-6
<p>623-4-100, 623-3-100, 623-5.5-125, 623-6.5-150</p>		
<p>625-1-150, 625-2-175</p>		



Insulated Ratcheting Screwdriver with Slotted and Phillips Interchangeable Blades Set - 6 Pcs

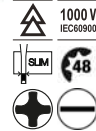

808061

7	85 x 85 x 218 mm	5	808061

Pouch contains 6 individual blades

808060		
8610SL-2P, 8620SL-2P		
8010SL-2P, 8050SL-2P, 8220SL-2P, 8040SL-2P		

Insulated Ratcheting Screwdriver with Slotted and Pozidriv Interchangeable Blades Set - 6 Pcs

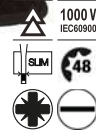

808062

7	85 x 85 x 215 mm	5	808062

Pouch contains 6 individual blades

808060		
8820SL-2P, 8810SL-2P		
8010SL-2P, 8050SL-2P, 8220SL-2P, 8040SL-2P		

Insulated Ratcheting Screwdriver with Dual-Component Handle



808060

36 mm	122 mm	1	808060

Insulated Slotted Interchangeable Blades with Reduced Diameter



8010SL-2P - 8050SL-2P

0.4 mm	2.5 mm	1	8010SL-2P
0.5 mm	3.0 mm	1	8220SL-2P
0.8 mm	4.0 mm	1	8040SL-2P
1.0 mm	5.5 mm	1	8050SL-2P

Insulated Phillips and Pozidriv Interchangeable Blades with Reduced Diameter PH1, PZ1



8610SL-2P - 8620SL-2P

1		1	8610SL-2P
2		1	8620SL-2P

Insulated Phillips and Pozidriv Interchangeable Blades with Reduced Diameter PH2, PZ2



8810SL-2P - 8820SL-2P

1		1	8810SL-2P
2		1	8820SL-2P

Insulated Plus-Minus/Phillips-Tip Interchangeable Blades with Reduced Diameter



8510SL-2P - 8520SL-2P

5.0/PH1		1	8510SL-2P
6.0/PH2		1	8520SL-2P

Insulated Combi-Tip Slotted and Pozidriv Interchangeable Blades with Reduced Diameter



8710SL-2P - 8720SL-2P

5.0/PZ1		1	8710SL-2P
6.0/PZ2		1	8720SL-2P

Insulated TORX® Interchangeable Blades with Reduced Diameter



8910SL-2P - 8930SL-2P

10		1	8910SL-2P
15		1	8915SL-2P
20		1	8920SL-2P
25		1	8925SL-2P
30		1	8930SL-2P

PLIERS

ERGO™ Side Cutting Pliers with Insulated Handles and Phosphate Finish



ergo®



2101S



Cu	Fe+		
3.7 mm	2.0 mm	3	2101S-140
3.8 mm	2.5 mm	3	2101S-160
4.0 mm	2.7 mm	3	2101S-180

ERGO™ Side Cutting Pliers with Insulated Handles and Phosphate Finish 200 mm



2101S-200



Cu	Fe+		
4.5 mm	3.0 mm	3	2101S-200

Insulated Cable Cutters for 30 mm Copper/Aluminium



2520S



L			
552 mm		1	2520 S

VDE Insulated Side Cutting Pliers



2171V



Cu	L		
2.7 mm	160 mm	2	2171V-160
2.8 mm	180 mm	2	2171V-180
4.0 mm	200 mm	2	2171V-200

VDE Insulated End Cutting Pliers



527V



Cu	L		
2 mm	160 mm	2	527V-160
2.5 mm	200 mm	2	527V-200

VDE Insulated Cable Cutters



2250V



L			
170 mm	0-10 mm	2	2250V-170
230 mm	0-15 mm	2	2250V-230

Insulated Bolt Cutters



2820VBC



L			
630 mm		1	2820VBC

Side Cutting Pliers with Insulated Cellulose Acetate Handles and Nickel-Chrome Finish



2674 NVDE



Cu	Fe+		
3.7 mm	2.0 mm	1	2674 NVDE

ERGO™ Combination Pliers with Insulated Dual-Component Handles and Phosphate Finish



ergo®



2628S



Fe+	Plano		
2.0 mm	1.8 mm	3	2628 S-160
2.5 mm	2.0 mm	3	2628 S-180
3.0 mm	2.5 mm	3	2628 S-200



Reinforced Combination Pliers with Insulated Dual-Component Handles and Chrome Finish



ergo®



2630SC



180 mm	3 2630SC-180	

ERGO™ 45° Bent Tip Snipe Nose Pliers with Insulated Dual-Component Handles and Phosphate Finish



ergo®



2427S



3.0 mm 3.0 mm	1.8 mm 1.8 mm	3 3	2427S-160 2427 S-200

VDE Insulated Snipe Nose Pliers



2430V



3.0 mm 3.0 mm	160 mm 200 mm	2 2	2430V-160 2430V-200

VDE Insulated Combination Pliers



2678V



2.7 mm 3.0 mm 4.0 mm	160 mm 180 mm 200 mm	2 2 2	2678V-160 2678V-180 2678V-200

ERGO™ Long Flat Nose Pliers with Insulated Dual-Component Handles and Phosphate Finish



ergo®



2421S



140 mm 160 mm 180 mm	3 3 3	2421S-140 2421S-160 2421S-180

VDE Insulated 45° Tip Angled Snipe Nose Pliers



2427V



3.0 mm	200 mm	2	2427V-200

ERGO™ Snipe Nose Pliers with Insulated Dual-Component Handles and Phosphate Finish



ergo®



2430S



2.5 mm 3.0 mm 3.0 mm	1.8 mm 1.8 mm 1.8 mm	3 3 3	2430S-140 2430 S-160 2430 S-200

ERGO™ Round Nose Pliers with Insulated Dual-Component Handles and Phosphate Finish



ergo®



2521S



140 mm 160 mm	3 3	2521S-140 2521S-160

VDE Insulated Long Flat Nose Pliers



2421V



160 mm	2	2421V-160

VDE Insulated Round Nose Pliers



2521V

160 mm	2	2521V-160



Insulated Quick-Adjust Water Pump Pliers with Dual-Component Handle



7224S

16 250 mm	4	7224S



ISO 8976, IEC 60900

Side Screw Insulated Adjustable Wrenches



8071VLT - 8073VLT

205mm/8"	1	8071VLT
255mm/10"	1	8072VLT
305mm/12"	1	8073VLT



ERGO™ Wire Stripping Pliers with Insulated Dual-Component Handles and Phosphate Finish



2223S

165 mm	3	2223 S-150



Insulated Thumb Screw Adjustable Wrenches



8070V - 8074V

165mm/6"	2	8070V
205mm/8"	2	8071V
260mm/10"	2	8072V
310mm/12"	2	8073V
390mm/15"	2	8074V



Insulated Open End Wrenches



6MV

6 mm	5	6MV-6
7 mm	5	6MV-7
8 mm	5	6MV-8
9 mm	5	6MV-9
10 mm	5	6MV-10
11 mm	5	6MV-11
12 mm	5	6MV-12
13 mm	5	6MV-13
14 mm	5	6MV-14
15 mm	5	6MV-15
16 mm	5	6MV-16
17 mm	3	6MV-17
18 mm	3	6MV-18
19 mm	3	6MV-19
20 mm	3	6MV-20
21 mm	3	6MV-21
22 mm	3	6MV-22
23 mm	3	6MV-23
24 mm	3	6MV-24
27 mm	2	6MV-27
30 mm	2	6MV-30
32 mm	2	6MV-32



VDE Insulated Wire Stripping Pliers



2223V

160 mm	0.5-5 mm	2	2223V-160



Insulated Side Screw Adjustable Wrenches



8070VL-8073VL

160mm/6"	1	8070VL
210mm/8"	1	8071VL
260mm/10"	1	8072VL
310mm/12"	1	8073VL



Insulated Offset Ring Spanners



2MV

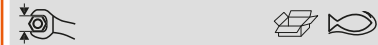

6.0 mm	5	2MV-6
7.0 mm	5	2MV-7
8.0 mm	5	2MV-8
9.0 mm	5	2MV-9
10.0 mm	5	2MV-10
11.0 mm	5	2MV-11
12.0 mm	5	2MV-12
13.0 mm	5	2MV-13
14.0 mm	5	2MV-14
15.0 mm	5	2MV-15
16.0 mm	5	2MV-16
17.0 mm	3	2MV-17
18.0 mm	3	2MV-18
19.0 mm	3	2MV-19
21.0 mm	3	2MV-21
22.0 mm	3	2MV-22
23.0 mm	3	2MV-23
24.0 mm	3	2MV-24



Insulated Cross Rim Wrenches



2820V

7x9x11x13 mm	1	2820V13
--------------	---	---------



12 mm	10	7800DMV-12
13 mm	10	7800DMV-13
14 mm	10	7800DMV-14
15 mm	10	7800DMV-15
16 mm	10	7800DMV-16
17 mm	10	7800DMV-17
18 mm	10	7800DMV-18
19 mm	10	7800DMV-19
20 mm	10	7800DMV-20
21 mm	10	7800DMV-21
22 mm	10	7800DMV-22
24 mm	5	7800DMV-24
27 mm	5	7800DMV-27
30 mm	5	7800DMV-30
32 mm	5	7800DMV-32

Insulated Hexagon L-Keys



1999MV

3 mm	5	1999MV-3
4 mm	5	1999MV-4
5 mm	5	1999MV-5
6 mm	5	1999MV-6
7 mm	5	1999MV-7
8 mm	5	1999MV-8
9 mm	5	1999MV-9
10 mm	3	1999MV-10
12 mm	3	1999MV-12



Insulated T-Handle Socket Wrenches



28MV

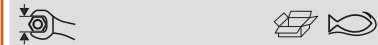

8.0 mm	2	28MV-8
9.0 mm	2	28MV-9
10.0 mm	2	28MV-10
11.0 mm	2	28MV-11
12.0 mm	2	28MV-12
13.0 mm	2	28MV-13
14.0 mm	2	28MV-14
15.0 mm	2	28MV-15
16.0 mm	2	28MV-16
17.0 mm	2	28MV-17
18.0 mm	2	28MV-18
19.0 mm	2	28MV-19
20.0 mm	2	28MV-20
21.0 mm	2	28MV-21
22.0 mm	2	28MV-22



INSULATED SOCKETS & RATCHETS

1/2" VDE Insulated Sockets 8 mm-32 mm



7800DMV

8 mm	10	7800DMV-8
10 mm	10	7800DMV-10
11 mm	10	7800DMV-11



1/2" VDE Insulated Ratchets 270 mm



8150-1/2V

270 mm	1	8150-1/2V
--------	---	-----------



1/2" VDE Insulated T-Handles 200 mm



8154-1/2V

200 mm	190 mm	1	8154-1/2V
--------	--------	---	-----------



1/2" VDE Insulated Extensions 125 mm-250 mm



8160-1/2V - 8162-1/2V



125 mm	1	8160-1/2V
250 mm	1	8162-1/2V

Insulated Straight Knives



2820VP



50 mm	180 mm	2
		2820VP

Insulated Cable Knives with Plastic Protective Cap



2820VDE



55.5 mm	180 mm	10
		2820VDE

SCISSORS & KNIVES

Insulated Electrician Scissors with Finger Guard



SC127V



50 mm	130 mm	5
		SC127V

VDE Insulated Bent Knives



2820VPC



50 mm	180 mm	2
		2820VPC

TWEEZERS

General Purpose Insulated Tweezers 150 mm



2820VTEE



145 mm	1	2820VTEE

Insulated Electrician Scissors



SC150NGV



38 mm	150 mm	5
		SC150NGV

Insulated Bent Knives with Guide



2820VHELP



38 mm	180 mm	1
		2820VHELP

PROTECTIVE EQUIPMENT

Insulated Fuse Pullers for NH 00-3



2820VFP



458 g	1	2820VFP



Insulating Mats for 1000VAC



2820VM

1000 mm	1000 mm	1	2820VM



Insulating Gloves 550 VAC-1000 VAC



2820VG

500 V	1000 V	1	2820VG05
		1	2820VG10



Cotton Gloves to Wear Under Insulated Gloves



2820VGCOT

50 g		1	2820VGCOT

THIS ITEM IS NOT INSULATED AND HAS TO BE USED WITH INSULATED GLOVES

TOOLSETS

ERGO™ All-Round Pliers Tool Set Insulated - 3 pcs



9897S/3

3	50 x 180 x 400 mm	1	9897S/3

2628 S-180		1000 V IEC60900
2101S-160		1000 V IEC60900
2430 S-200		1000 V IEC60900

Insulated Open End Wrench Set - 8 Pcs



6MV/

8 mm		1	6MV/8T



6MV-10, 6MV-11, 6MV-12, 6MV-13, 6MV-14, 6MV-17, 6MV-18, 6MV-19		1000 V IEC60900
--	--	-----------------

Insulated Open End Wrench Set - 10 Pcs



6MV/10T_1

10 mm		1	6MV/10T



6MV-10, 6MV-11, 6MV-12, 6MV-13, 6MV-14, 6MV-16, 6MV-17, 6MV-18, 6MV-19, 6MV-22		1000 V IEC60900
--	--	-----------------

1/2" VDE Insulated Socket Set - 11 Pcs



7811DMV

11	270 x 79 x 350 mm	1	7811DMV



7800DMV-13, 7800DMV-10, 7800DMV-11, 7800DMV-22, 7800DMV-17, 7800DMV-19, 7800DMV-20		1000 V IEC60900
--	--	-----------------

8150-1/2V		1000 V IEC60900
-----------	--	-----------------

8154-1/2V		1000 V IEC60900
-----------	--	-----------------

8160-1/2V		1000 V IEC60900
-----------	--	-----------------

BE-8050S		
----------	--	--

Foldable Case Insulated Electrician's Toolset - 10 Pcs



3045/1VDE

10	225 x 70 x 300 mm	1	3045/1VDE

BE-8010S, BE-8040S, BE-8050S, BE-8220S, BE-8230S, BE-8255S		
BE-8620S		
2171V-160		
2430V-160		
2678V-180		

Leather Briefcase Insulated Electrician's Toolset - 10 Pcs



3045V-1

10	60 x 240 x 330 mm	1	3045V-1

2171V-160		
2678V-180		
2223V-160		
BE-8220S, BE-8040S, BE-8050S		
BE-8610S, BE-8620S		
2820VP		
SC127V		

Insulated Toolset within Leather Bag - 19 Pcs



3045V-2

19	200 x 285 x 445 mm	1	3045V-2

2171V-160		
2678V-180		
2430V-160		
2223V-160		
BE-8220S, BE-8040S, BE-8050S, BE-8255S		
BE-8610S, BE-8620S		
6MV-10, 6MV-11, 6MV-13, 6MV-12, 6MV-14, 6MV-17, 6MV-19		
2820VP		
SC150NGV		





BAHCO



Non Sparking Tools



WRENCHES

Non-Sparking Central Nut Adjustable Wrenches Aluminium Bronze



NS001

Size	Length	Quantity	Part No.
18 mm	150mm/6"	5	NS001-150
24 mm	200mm/8"	5	NS001-200
30 mm	250mm/10"	5	NS001-250
36 mm	300mm/12"	5	NS001-300
46 mm	375mm/15"	5	NS001-375
55 mm	450mm/18"	3	NS001-450
65 mm	600mm/24"	1	NS001-600
75 mm	900mm/36"	1	NS001-900

Non-Sparking Central Nut Adjustable Wrenches Copper Beryllium



NSB001

Size	Length	Quantity	Part No.
18 mm	150mm/6"	5	NSB001-150
24 mm	200mm/8"	5	NSB001-200
30 mm	250mm/10"	5	NSB001-250
36 mm	300mm/12"	5	NSB001-300
48 mm	375mm/15"	5	NSB001-375
55 mm	450mm/18"	3	NSB001-450
65 mm	600mm/24"	3	NSB001-600
75 mm	900mm/36"	1	NSB001-900

BAM/ZBF/003/21

Non-Sparking Metric Combination Wrenches Aluminium Bronze



NS002

Size	Quantity	Part No.
6 mm	5	NS002-6
7 mm	5	NS002-7
8 mm	5	NS002-8
9 mm	5	NS002-9

Size	Quantity	Part No.
10 mm	10	NS002-10
11 mm	5	NS002-11
12 mm	5	NS002-12
13 mm	10	NS002-13
14 mm	5	NS002-14
15 mm	5	NS002-15
16 mm	5	NS002-16
17 mm	10	NS002-17
18 mm	5	NS002-18
19 mm	10	NS002-19
20 mm	5	NS002-20
21 mm	5	NS002-21
22 mm	10	NS002-22
23 mm	5	NS002-23
24 mm	10	NS002-24
25 mm	5	NS002-25
26 mm	5	NS002-26
27 mm	5	NS002-27
28 mm	5	NS002-28
29 mm	10	NS002-29
30 mm	10	NS002-30
31 mm	5	NS002-31
32 mm	5	NS002-32
33 mm	5	NS002-33
34 mm	5	NS002-34
35 mm	5	NS002-35
36 mm	5	NS002-36
38 mm	5	NS002-38
40 mm	5	NS002-40
41 mm	5	NS002-41
42 mm	5	NS002-42
46 mm	5	NS002-46
50 mm	5	NS002-50
52 mm	5	NS002-52
55 mm	5	NS002-55
60 mm	1	NS002-60
65 mm	1	NS002-65
70 mm	1	NS002-70
75 mm	1	NS002-75
80 mm	1	NS002-80

BAM/ZBF/002/21

Non-Sparking Metric Combination Wrenches Copper Beryllium



NSB002

Size	Quantity	Part No.
6 mm	5	NSB002-6
7 mm	5	NSB002-7
8 mm	5	NSB002-8
9 mm	5	NSB002-9
10 mm	5	NSB002-10
11 mm	5	NSB002-11
12 mm	5	NSB002-12
13 mm	5	NSB002-13
17 mm	5	NSB002-17
14 mm	5	NSB002-14
15 mm	5	NSB002-15
16 mm	5	NSB002-16
18 mm	5	NSB002-18
19 mm	5	NSB002-19
20 mm	5	NSB002-20
21 mm	5	NSB002-21
22 mm	5	NSB002-22
25 mm	5	NSB002-25
23 mm	5	NSB002-23
26 mm	5	NSB002-26

Size	Quantity	Part No.
24 mm	5	NSB002-24
27 mm	5	NSB002-27
28 mm	5	NSB002-28
29 mm	5	NSB002-29
30 mm	5	NSB002-30
31 mm	1	NSB002-31
32 mm	10	NSB002-32
33 mm	1	NSB002-33
34 mm	1	NSB002-34
35 mm	1	NSB002-35
36 mm	5	NSB002-36
38 mm	1	NSB002-38
40 mm	1	NSB002-40
41 mm	5	NSB002-41
42 mm	1	NSB002-42
46 mm	1	NSB002-46
50 mm	1	NSB002-50
52 mm	1	NSB002-52
55 mm	1	NSB002-55
60 mm	1	NSB002-60
65 mm	1	NSB002-65
70 mm	1	NSB002-70
75 mm	1	NSB002-75
80 mm	1	NSB002-80

BAM/ZBF/003/21

Non-Sparking Imperial Combination Wrenches Aluminium Bronze



NS003



Size	Quantity	Part No.
1/4 in	1	NS003-8
11/32 in	1	NS003-11
3/8 in	1	NS003-12
7/16 in	1	NS003-14
1/2 in	1	NS003-16
9/16 in	1	NS003-18
5/8 in	1	NS003-20
3/4 in	1	NS003-24
7/8 in	1	NS003-28
15/16 in	1	NS003-30

Non-Sparking Imperial Combination Wrenches Copper Beryllium



NSB003

Size	Quantity	Part No.
1/4 in	1	NSB003-8
5/16 in	1	NSB003-10
11/32 in	1	NSB003-11
3/8 in	5	NSB003-12



		
13/32 in	1	NSB003-13
7/16 in	1	NSB003-14
1/2 in	5	NSB003-16
9/16 in	1	NSB003-18
19/32 in	1	NSB003-19
5/8 in	1	NSB003-20
11/16 in	5	NSB003-22
3/4 in	5	NSB003-24
25/32 in	1	NSB003-25
13/16 in	1	NSB003-26
7/8 in	5	NSB003-28
15/16 in	1	NSB003-30
31/32 in	1	NSB003-31
1 in	1	NSB003-32
1.1/16 in	1	NSB003-34
1.1/8 in	1	NSB003-36
1.3/16 in	1	NSB003-38
1.1/4 in	1	NSB003-40
1.5/16 in	1	NSB003-42
1.3/8 in	5	NSB003-44
1.7/16 in	1	NSB003-46
1.1/2 in	1	NSB003-48
1.9/16 in	1	NSB003-50
1.5/8 in	1	NSB003-52
1.11/16 in	1	NSB003-54
1.3/4 in	1	NSB003-56
1.13/16 in	1	NSB003-58
1.7/8 in	1	NSB003-60
1.15/16 in	1	NSB003-62
2 in	5	NSB003-64
2.1/8 in	1	NSB003-68
2.1/4 in	1	NSB003-72
2.1/2 in	1	NSB003-80
2.5/8 in	1	NSB003-84
2.3/4 in	1	NSB003-88



BAM/ZBF/003/21

Non-Sparking Metric Double Open Ended Wrenches Aluminium Bronze



NS006

		
6x7 mm	1	NS006-0607
6x8 mm	1	NS006-0608
7x8 mm	1	NS006-0708
7x9 mm	1	NS006-0709
8x9 mm	1	NS006-0809
8x10 mm	1	NS006-0810
9x10 mm	1	NS006-0910
9x11 mm	1	NS006-0911
10x11 mm	1	NS006-1011
10x12 mm	1	NS006-1012
10x13 mm	1	NS006-1013
10x14 mm	1	NS006-1014
11x13 mm	1	NS006-1113
11x14 mm	1	NS006-1114
12x13 mm	1	NS006-1213
12x14 mm	1	NS006-1214
13x15 mm	1	NS006-1315
14x15 mm	1	NS006-1415
14x16 mm	1	NS006-1416



		
14x17 mm	1	NS006-1417
16x17 mm	1	NS006-1617
16x18 mm	1	NS006-1618
17x19 mm	1	NS006-1719
17x22 mm	1	NS006-1722
18x19 mm	1	NS006-1819
18x20 mm	1	NS006-1820
19x20 mm	1	NS006-1920
19x22 mm	1	NS006-1922
19x24 mm	1	NS006-1924
20x22 mm	1	NS006-2022
21x22 mm	1	NS006-2122
21x23 mm	1	NS006-2123
22x23 mm	1	NS006-2223
22x24 mm	1	NS006-2224
22x27 mm	1	NS006-2227
23x26 mm	1	NS006-2326
24x25 mm	1	NS006-2425
24x26 mm	1	NS006-2426
24x27 mm	1	NS006-2427
24x30 mm	1	NS006-2430
25x28 mm	1	NS006-2528
26x29 mm	1	NS006-2629
27x29 mm	1	NS006-2729
27x30 mm	1	NS006-2730
27x32 mm	1	NS006-2732
28x30 mm	1	NS006-2830
30x31 mm	1	NS006-3031
30x32 mm	1	NS006-3032
30x34 mm	1	NS006-3034
30x36 mm	1	NS006-3036
32x34 mm	1	NS006-3234
32x35 mm	1	NS006-3235
32x36 mm	1	NS006-3236
33x35 mm	1	NS006-3335
34x36 mm	1	NS006-3436
35x36 mm	1	NS006-3536
36x38 mm	1	NS006-3638
36x41 mm	1	NS006-3641
38x42 mm	1	NS006-3642
41x46 mm	1	NS006-4146
46x50 mm	1	NS006-4650
50x52 mm	1	NS006-5052
50x55 mm	1	NS006-5055
50x60 mm	1	NS006-5060
50x62 mm	1	NS006-5062
55x60 mm	1	NS006-5560
60x65 mm	1	NS006-6065
65x70 mm	1	NS006-6570



BAM/ZBF/002/21

Non-Sparking Metric Double Open Ended Wrenches Copper Beryllium



NSB006

		
6X7 mm	1	NSB006-0607
6X8 mm	1	NSB006-0608
7X8 mm	1	NSB006-0708
7X9 mm	1	NSB006-0709

		
8X9 mm	1	NSB006-0809
8X10 mm	1	NSB006-0810
9X10 mm	1	NSB006-0910
9X11 mm	1	NSB006-0911
10X11 mm	1	NSB006-1011
10X12 mm	1	NSB006-1012
10X13 mm	1	NSB006-1013
10X14 mm	1	NSB006-1014
11X13 mm	1	NSB006-1113
11X14 mm	1	NSB006-1114
12X13 mm	1	NSB006-1213
12X14 mm	1	NSB006-1214
13X15 mm	1	NSB006-1315
14X15 mm	1	NSB006-1415
14X16 mm	1	NSB006-1416
14X17 mm	1	NSB006-1417
16X17 mm	1	NSB006-1617
16X18 mm	1	NSB006-1618
17X19 mm	1	NSB006-1719
17X22 mm	1	NSB006-1722
18X19 mm	1	NSB006-1819
18X20 mm	1	NSB006-1820
19X20 mm	1	NSB006-1920
19X22 mm	1	NSB006-1922
19X24 mm	1	NSB006-1924
20X22 mm	1	NSB006-2022
21X22 mm	1	NSB006-2122
21X23 mm	1	NSB006-2123
22X23 mm	1	NSB006-2223
22X24 mm	1	NSB006-2224
22X27 mm	1	NSB006-2227
23X26 mm	1	NSB006-2326
24X25 mm	1	NSB006-2425
24X26 mm	1	NSB006-2426
24X27 mm	1	NSB006-2427
24X30 mm	1	NSB006-2430
25x28 mm	1	NSB006-2528
26x29 mm	1	NSB006-2629
27-29 mm	1	NSB006-2729
27x30 mm	1	NSB006-2730
27x32 mm	1	NSB006-2732
28x30 mm	1	NSB006-2830
30x31 mm	1	NSB006-3031
30x32 mm	1	NSB006-3032
30x34 mm	1	NSB006-3034
30x36 mm	1	NSB006-3036
32x34 mm	1	NSB006-3234
32x35 mm	1	NSB006-3235
32x36 mm	1	NSB006-3236
33x35 mm	1	NSB006-3335
34x36 mm	1	NSB006-3436
35x36 mm	1	NSB006-3536
36x38 mm	1	NSB006-3638
36x41 mm	1	NSB006-3641
38x42 mm	1	NSB006-3642
41x46 mm	1	NSB006-4146
46x50 mm	1	NSB006-4650
50x52 mm	1	NSB006-5052
50x55 mm	1	NSB006-5055
50x60 mm	1	NSB006-5060
50x62 mm	1	NSB006-5062
55X60 mm	1	NSB006-5560
60X65 mm	1	NSB006-6065
65X70 mm	1	NSB006-6570

BAM/ZBF/003/21



Non-Sparking Metric Double Ended Flat Ring Wrenches Aluminium Bronze



NS10

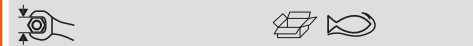

6x7 mm	1	NS010-0607
7x9 mm	1	NS010-0709
8x9 mm	1	NS010-0809
9x11 mm	1	NS010-0911
10x11 mm	1	NS010-1011
10x12 mm	1	NS010-1012
12x14 mm	1	NS010-1214
13x15 mm	1	NS010-1315
14x17 mm	1	NS010-1417
16x18 mm	1	NS010-1618
17x19 mm	1	NS010-1719
17x22 mm	1	NS010-1722
18x19 mm	1	NS010-1819
19x21 mm	1	NS010-1921
19x22 mm	1	NS010-1922
20x22 mm	1	NS010-2022
21x23 mm	1	NS010-2123
22x24 mm	1	NS010-2224
24x27 mm	1	NS010-2427
25x28 mm	1	NS010-2528
26x28 mm	1	NS010-2628
27x30 mm	1	NS010-2730
27x32 mm	1	NS010-2732
30x32 mm	1	NS010-3032
30x36 mm	1	NS010-3036
32x36 mm	1	NS010-3236
36x41 mm	1	NS010-3641
41x46 mm	1	NS010-4146
46x50 mm	1	NS010-4650

BAM/ZBF/002/21

Non-Sparking Metric Double Ended Flat Ring Wrenches Copper Beryllium



NSB010

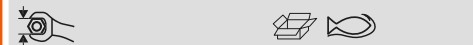

6X7 mm	1	NSB010-0607
7X9 mm	1	NSB010-0709
8X9 mm	1	NSB010-0809
9X11 mm	1	NSB010-0911

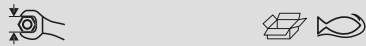

10X11 mm	1	NSB010-1011
10X12 mm	1	NSB010-1012
12X14 mm	1	NSB010-1214
13X15 mm	1	NSB010-1315
14X17 mm	1	NSB010-1417
16X18 mm	1	NSB010-1618
17X19 mm	1	NSB010-1719
17X22 mm	1	NSB010-1722
18X19 mm	1	NSB010-1819
19X21 mm	1	NSB010-1921
19X22 mm	1	NSB010-1922
20X22 mm	1	NSB010-2022
21X23 mm	1	NSB010-2123
22X24 mm	1	NSB010-2224
24X27 mm	1	NSB010-2427
25X28 mm	1	NSB010-2528
26X28 mm	1	NSB010-2628
27X30 mm	1	NSB010-2730
27X32 mm	1	NSB010-2732
30X32 mm	1	NSB010-3032
30X36 mm	1	NSB010-3036
32X36 mm	1	NSB010-3236
36X41 mm	1	NSB010-3641
41X46 mm	1	NSB010-4146
46X50 mm	1	NSB010-4650

BAM/ZBF/003/21

Non-Sparking Metric Double Ended Offset Ring Wrenches Aluminium Bronze



NS011



6x7 mm	1	NS011-0607
8x9 mm	1	NS011-0809
10x11 mm	1	NS011-1011
12x13 mm	1	NS011-1213
14x15 mm	1	NS011-1415
16x17 mm	1	NS011-1617
18x19 mm	1	NS011-1819
20x22 mm	1	NS011-2022
21x23 mm	1	NS011-2123
24x26 mm	1	NS011-2426
25x28 mm	1	NS011-2528
27x29 mm	1	NS011-2729
30x32 mm	1	NS011-3032

BAM/ZBF/002/21

Non-Sparking Metric Double Ended Offset Ring Wrenches Copper Beryllium



NSB011



6x7 mm	1	NSB011-0607
8x9 mm	1	NSB011-0809
10x11 mm	1	NSB011-1011
12x13 mm	1	NSB011-1213
14x15 mm	1	NSB011-1415
16x17 mm	1	NSB011-1617
18x19 mm	1	NSB011-1819
20x22 mm	1	NSB011-2022
21x23 mm	1	NSB011-2123
24x26 mm	1	NSB011-2426
25x28 mm	1	NSB011-2528
27x29 mm	1	NSB011-2729
30x32 mm	1	NSB011-3032

BAM/ZBF/003/21



Non-Sparking Metric Slogging Open Wrenches Aluminium Bronze



NS100



17 mm	1	NS100-17
19 mm	1	NS100-19
22 mm	1	NS100-22
24 mm	1	NS100-24
25 mm	1	NS100-25
27 mm	1	NS100-27
28 mm	1	NS100-28
29 mm	1	NS100-29
30 mm	1	NS100-30
32 mm	1	NS100-32
33 mm	1	NS100-33
34 mm	1	NS100-34
35 mm	1	NS100-35
36 mm	1	NS100-36
37 mm	1	NS100-37
38 mm	1	NS100-38
41 mm	1	NS100-41
42 mm	1	NS100-42
45 mm	1	NS100-45



		
46 mm	1	NS100-46
47 mm	1	NS100-47
50 mm	1	NS100-50
52 mm	1	NS100-52
54 mm	1	NS100-54
55 mm	1	NS100-55
56 mm	1	NS100-56
58 mm	1	NS100-58
60 mm	1	NS100-60
63 mm	1	NS100-63
65 mm	1	NS100-65
67 mm	1	NS100-67
70 mm	1	NS100-70
71 mm	1	NS100-71
75 mm	1	NS100-75
77 mm	1	NS100-77
80 mm	1	NS100-80
82 mm	1	NS100-82
85 mm	1	NS100-85
88 mm	1	NS100-88
90 mm	1	NS100-90
94 mm	1	NS100-94
95 mm	1	NS100-95
100 mm	1	NS100-100
105 mm	1	NS100-105
110 mm	1	NS100-110
115 mm	1	NS100-115
120 mm	1	NS100-120



BAM/ZBF/002/21

Non-Sparking Metric Slogging Open Wrenches Copper Beryllium



NSB100

		
17 mm	1	NSB100-17
19 mm	1	NSB100-19
22 mm	1	NSB100-22
24 mm	1	NSB100-24
25 mm	1	NSB100-25
27 mm	1	NSB100-27
28 mm	1	NSB100-28
29 mm	1	NSB100-29
30 mm	1	NSB100-30
32 mm	1	NSB100-32
33 mm	1	NSB100-33
34 mm	1	NSB100-34
35 mm	1	NSB100-35
36 mm	1	NSB100-36
37 mm	1	NSB100-37
38 mm	1	NSB100-38
41 mm	1	NSB100-41



		
42 mm	1	NSB100-42
45 mm	1	NSB100-45
46 mm	1	NSB100-46
47 mm	1	NSB100-47
50 mm	1	NSB100-50
52 mm	1	NSB100-52
54 mm	1	NSB100-54
55 mm	1	NSB100-55
56 mm	1	NSB100-56
58 mm	1	NSB100-58
60 mm	1	NSB100-60
63 mm	1	NSB100-63
65 mm	1	NSB100-65
67 mm	1	NSB100-67
70 mm	1	NSB100-70
71 mm	1	NSB100-71
75 mm	1	NSB100-75
77 mm	1	NSB100-77
80 mm	1	NSB100-80
82 mm	1	NSB100-82
85 mm	1	NSB100-85
88 mm	1	NSB100-88
90 mm	1	NSB100-90
94 mm	1	NSB100-94
95 mm	1	NSB100-95
100 mm	1	NSB100-100
105 mm	1	NSB100-105
110 mm	1	NSB100-110
115 mm	1	NSB100-115
120 mm	1	NSB100-120



BAM/ZBF/003/21

Non-Sparking Metric Slogging Ring Wrenches Aluminium Bronze



NS104

		
17 mm	1	NS104-17
19 mm	1	NS104-19
20 mm	1	NS104-20
22 mm	1	NS104-22
24 mm	1	NS104-24
25 mm	1	NS104-25
26 mm	1	NS104-26
27 mm	1	NS104-27
28 mm	1	NS104-28
29 mm	1	NS104-29
30 mm	1	NS104-30

		
31 mm	1	NS104-31
32 mm	1	NS104-32
33 mm	1	NS104-33
34 mm	1	NS104-34
35 mm	1	NS104-35
36 mm	1	NS104-36
37 mm	1	NS104-37
38 mm	1	NS104-38
39 mm	1	NS104-39
40 mm	1	NS104-40
41 mm	1	NS104-41
42 mm	1	NS104-42
43 mm	1	NS104-43
44 mm	1	NS104-44
45 mm	1	NS104-45
46 mm	1	NS104-46
47 mm	1	NS104-47
48 mm	1	NS104-48
49 mm	1	NS104-49
50 mm	1	NS104-50
51 mm	1	NS104-51
52 mm	1	NS104-52
53 mm	1	NS104-53
54 mm	1	NS104-54
55 mm	1	NS104-55
56 mm	1	NS104-56
57 mm	1	NS104-57
58 mm	1	NS104-58
59 mm	1	NS104-59
60 mm	1	NS104-60
61 mm	1	NS104-61
62 mm	1	NS104-62
63 mm	1	NS104-63
64 mm	1	NS104-64
65 mm	1	NS104-65
66 mm	1	NS104-66
67 mm	1	NS104-67
68 mm	1	NS104-68
69 mm	1	NS104-69
70 mm	1	NS104-70
71 mm	1	NS104-71
72 mm	1	NS104-72
73 mm	1	NS104-73
74 mm	1	NS104-74
75 mm	1	NS104-75
76 mm	1	NS104-76
77 mm	1	NS104-77
78 mm	1	NS104-78
79 mm	1	NS104-79
80 mm	1	NS104-80
81 mm	1	NS104-81
82 mm	1	NS104-82
83 mm	1	NS104-83
84 mm	1	NS104-84
85 mm	1	NS104-85
86 mm	1	NS104-86
87 mm	1	NS104-87
88 mm	1	NS104-88
89 mm	1	NS104-89
90 mm	1	NS104-90
92 mm	1	NS104-92
94 mm	1	NS104-94
95 mm	1	NS104-95
98 mm	1	NS104-98
100 mm	1	NS104-100
105 mm	1	NS104-105
110 mm	1	NS104-110
115 mm	1	NS104-115
120 mm	1	NS104-120

BAM/ZBF/002/21



Non-Sparking Metric Slogging Ring
Wrenches Copper Beryllium



NSB104



17 mm	1	NSB104-17
19 mm	1	NSB104-19
20 mm	1	NSB104-20
22 mm	1	NSB104-22
24 mm	1	NSB104-24
25 mm	1	NSB104-25
26 mm	1	NSB104-26
27 mm	1	NSB104-27
28 mm	1	NSB104-28
29 mm	1	NSB104-29
30 mm	1	NSB104-30
31 mm	1	NSB104-31
32 mm	1	NSB104-32
33 mm	1	NSB104-33
34 mm	1	NSB104-34
35 mm	1	NSB104-35
36 mm	1	NSB104-36
37 mm	1	NSB104-37
38 mm	1	NSB104-38
39 mm	1	NSB104-39
40 mm	1	NSB104-40
41 mm	1	NSB104-41
42 mm	1	NSB104-42
43 mm	1	NSB104-43
44 mm	1	NSB104-44
45 mm	1	NSB104-45
46 mm	1	NSB104-46
47 mm	1	NSB104-47
48 mm	1	NSB104-48
49 mm	1	NSB104-49
50 mm	1	NSB104-50
51 mm	1	NSB104-51
52 mm	1	NSB104-52
53 mm	1	NSB104-53
54 mm	1	NSB104-54
55 mm	1	NSB104-55
56 mm	1	NSB104-56
57 mm	1	NSB104-57
58 mm	1	NSB104-58
59 mm	1	NSB104-59
60 mm	1	NSB104-60
61 mm	1	NSB104-61
62 mm	1	NSB104-62
63 mm	1	NSB104-63
64 mm	1	NSB104-64
65 mm	1	NSB104-65
66 mm	1	NSB104-66
67 mm	1	NSB104-67
68 mm	1	NSB104-68
69 mm	1	NSB104-69
70 mm	1	NSB104-70
71 mm	1	NSB104-71
72 mm	1	NSB104-72
73 mm	1	NSB104-73
74 mm	1	NSB104-74
75 mm	1	NSB104-75
76 mm	1	NSB104-76
77 mm	1	NSB104-77

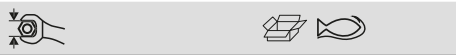

78 mm	1	NSB104-78
79 mm	1	NSB104-79
80 mm	1	NSB104-80
81 mm	1	NSB104-81
82 mm	1	NSB104-82
83 mm	1	NSB104-83
84 mm	1	NSB104-84
85 mm	1	NSB104-85
86 mm	1	NSB104-86
87 mm	1	NSB104-87
88 mm	1	NSB104-88
89 mm	1	NSB104-89
90 mm	1	NSB104-90
92 mm	1	NSB104-92
94 mm	1	NSB104-94
95 mm	1	NSB104-95
98 mm	1	NSB104-98
100 mm	1	NSB104-100
105 mm	1	NSB104-105
110 mm	1	NSB104-110
115 mm	1	NSB104-115
120 mm	1	NSB104-120

BAM/ZBF/003/21

Non-Sparking Imperial Slogging Ring
Wrenches Aluminium Bronze



NS106

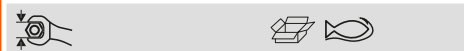

5/8 in	1	NS106-20
11/16 in	1	NS106-22
3/4 in	1	NS106-24
25/32 in	1	NS106-25
13/16 in	1	NS106-26
7/8 in	1	NS106-28
15/16 in	1	NS106-30
1 in	1	NS106-32
1 1/16 in	1	NS106-34
1 1/8 in	1	NS106-36
1 3/16 in	1	NS106-38
1 1/4 in	1	NS106-40
1 5/16 in	1	NS106-42
1 3/8 in	1	NS106-44
1 13/32 in	1	NS106-45
1 7/16 in	1	NS106-46
1 1/2 in	1	NS106-48
1 9/16 in	1	NS106-50
1 5/8 in	1	NS106-52
1 11/16 in	1	NS106-54
1 3/4 in	1	NS106-56
1 13/16 in	1	NS106-58
1 7/8 in	1	NS106-60
1 15/16 in	1	NS106-62
2 in	1	NS106-64
2 1/16 in	1	NS106-66
2 1/8 in	1	NS106-68
2 3/16 in	1	NS106-70
2 13/64 in	1	NS106-71
2 1/4 in	1	NS106-72
2 5/16 in	1	NS106-74

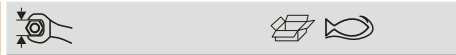

2 3/8 in	1	NS106-76
2 7/16 in	1	NS106-78
2 1/2 in	1	NS106-80
2 9/16 in	1	NS106-82
2 5/8 in	1	NS106-84
2 3/4 in	1	NS106-88
2 13/16 in	1	NS106-90
2 7/8 in	1	NS106-92
2 15/16 in	1	NS106-94
3 in	1	NS106-96
3 1/16 in	1	NS106-98
3 1/8 in	1	NS106-100
3 1/4 in	1	NS106-104
3 3/8 in	1	NS106-108
3 1/2 in	1	NS106-112
3 9/16 in	1	NS106-114
3 5/8 in	1	NS106-116
3 3/4 in	1	NS106-120
3 7/8 in	1	NS106-124
3 15/16 in	1	NS106-126
4 in	1	NS106-128
4 1/8 in	1	NS106-132
4 1/4 in	1	NS106-136
4 5/16 in	1	NS106-138
4 1/2 in	1	NS106-144
4 9/16 in	1	NS106-146
4 11/16 in	1	NS106-150
4 7/8 in	1	NS106-156
4 15/16 in	1	NS106-158

BAM/ZBF/002/21

Non-Sparking Imperial Slogging Ring
Wrenches Copper Beryllium



NSB106



5/8 in	1	NSB106-20
11/16 in	1	NSB106-22
3/4 in	1	NSB106-24
25/32 in	1	NSB106-25
13/16 in	1	NSB106-26
7/8 in	1	NSB106-28
15/16 in	1	NSB106-30
1 in	1	NSB106-32
1.1/16 in	1	NSB106-34
1.1/8 in	1	NSB106-36
1.3/16 in	1	NSB106-38
1.1/4 in	1	NSB106-40
1.5/16 in	1	NSB106-42
1.3/8 in	1	NSB106-44
1.13/32 in	1	NSB106-45
1.7/16 in	1	NSB106-46
1.1/2 in	1	NSB106-48
1.9/16 in	1	NSB106-50
1.5/8 in	1	NSB106-52
1.11/16 in	1	NSB106-54
1.3/4 in	1	NSB106-56
1.13/16 in	1	NSB106-58
1.7/8 in	1	NSB106-60
1.15/16 in	1	NSB106-62

2 in	1	NSB106-64
2.1/16 in	1	NSB106-66
2.1/8 in	1	NSB106-68
2.3/16 in	1	NSB106-70
2.13/64 in	1	NSB106-71
2.1/4 in	1	NSB106-72
2.5/16 in	1	NSB106-74
2.3/8 in	1	NSB106-76
2.7/16 in	1	NSB106-78
2.1/2 in	1	NSB106-80
2.9/16 in	1	NSB106-82
2.5/8 in	1	NSB106-84
2.3/4 in	1	NSB106-88
2.13/16 in	1	NSB106-90
2.7/8 in	1	NSB106-92
2.15/16 in	1	NSB106-94
3 in	1	NSB106-96
3.1/16 in	1	NSB106-98
3.1/8 in	1	NSB106-100
3.1/4 in	1	NSB106-104
3.3/8 in	1	NSB106-108
3.1/2 in	1	NSB106-112
3.9/16 in	1	NSB106-114
3.5/8 in	1	NSB106-116
3.3/4 in	1	NSB106-120
3.7/8 in	1	NSB106-124
3.15/16 in	1	NSB106-126
4 in	1	NSB106-128
4.1/8 in	1	NSB106-132
4.1/4 in	1	NSB106-136
4.5/16 in	1	NSB106-138
4.1/2 in	1	NSB106-144
4.9/16 in	1	NSB106-146
4.11/16 in	1	NSB106-150
4.7/8 in	1	NSB106-156
4.15/16 in	1	NSB106-158

BAM/ZBF/003/21

PIPE WRENCHES & VALVE TOOLS

Non-Sparking Heavy Duty Pipe Wrenches Aluminium Bronze



25 mm	200 mm	1 NS200-200
30 mm	250 mm	1 NS200-250
40 mm	300 mm	1 NS200-300
50 mm	350 mm	1 NS200-350
60 mm	450 mm	1 NS200-450
75 mm	600 mm	1 NS200-600
85 mm	900 mm	1 NS200-900
110 mm	1200 mm	1 NS200-1200

BAM/ZBF/002/21

Non-Sparking Heavy Duty Pipe Wrenches Copper Beryllium



25 mm	200 mm	1 NSB200-200
30 mm	250 mm	1 NSB200-250
40 mm	300 mm	1 NSB200-300
50 mm	350 mm	1 NSB200-350
60 mm	450 mm	1 NSB200-450
75 mm	600 mm	1 NSB200-600
85 mm	900 mm	1 NSB200-900
110 mm	1200 mm	1 NSB200-1200

BAM/ZBF/003/21

Non-Sparking Long Valve Wrenches Aluminium Bronze



370 mm		1 NS202-350

BAM/ZBF/002/21

Non-Sparking Long Valve Wrenches Copper Beryllium



375 mm		1 NSB202-350

BAM/ZBF/003/21

Non-Sparking Valve Wrenches Aluminium Bronze



215 mm	24 mm	1 NS203-200
215 mm	32 mm	1 NS203-215

290 mm	36 mm	1 NS203-290
400 mm	48 mm	1 NS203-400
490 mm	60 mm	1 NS203-490
800 mm	60 mm	1 NS203-800

BAM/ZBF/002/21

Non-Sparking Valve Wrenches Copper Beryllium



215 mm	24 mm	1 NSB203-200
215 mm	32 mm	1 NSB203-215
290 mm	36 mm	1 NSB203-290
400 mm	48 mm	1 NSB203-400
490 mm	60 mm	1 NSB203-490
800 mm	60 mm	1 NSB203-800

BAM/ZBF/003/21

Non-Sparking Valve Hooks Aluminium Bronze



200 mm		1 NS204-30
300 mm		1 NS204-32
250 mm		1 NS204-35
300 mm		1 NS204-40
350 mm		1 NS204-45
375 mm		1 NS204-48
400 mm		1 NS204-50
450 mm		1 NS204-55
500 mm		1 NS204-60
550 mm		1 NS204-65
600 mm		1 NS204-70
650 mm		1 NS204-75
700 mm		1 NS204-80
750 mm		1 NS204-85
800 mm		1 NS204-90

BAM/ZBF/002/21



Non-Sparking Valve Hooks Copper Beryllium



NSB204

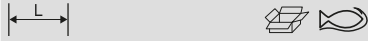

200 mm	1	NSB204-30
300 mm	1	NSB204-32
250 mm	1	NSB204-35
300 mm	1	NSB204-40
350 mm	1	NSB204-45
375 mm	1	NSB204-48
400 mm	1	NSB204-50
450 mm	1	NSB204-55
500 mm	1	NSB204-60
550 mm	1	NSB204-65
600 mm	1	NSB204-70
650 mm	1	NSB204-75
700 mm	1	NSB204-80
750 mm	1	NSB204-85
800 mm	1	NSB204-90

BAM/ZBF/003/21

SOCKETS & RATCHETS

Non-Sparking 1/2" Sockets with Metric Hex Profile Aluminium Bronze



NSB220

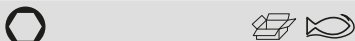

6 mm	1	NSB220-06
7 mm	1	NSB220-07
8 mm	1	NSB220-08
9 mm	1	NSB220-09
10 mm	1	NSB220-10
11 mm	1	NSB220-11
12 mm	1	NSB220-12
13 mm	1	NSB220-13
14 mm	1	NSB220-14
15 mm	1	NSB220-15
16 mm	1	NSB220-16
17 mm	1	NSB220-17

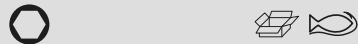

18 mm	1	NS220-18
19 mm	1	NS220-19
20 mm	1	NS220-20
21 mm	1	NS220-21
22 mm	1	NS220-22
23 mm	1	NS220-23
24 mm	1	NS220-24
25 mm	1	NS220-25
26 mm	1	NS220-26
27 mm	1	NS220-27
28 mm	1	NS220-28
29 mm	1	NS220-29
30 mm	1	NS220-30
32 mm	1	NS220-32
34 mm	1	NS220-34
36 mm	1	NS220-36
41 mm	1	NS220-41

BAM/ZBF/002/21

Non-Sparking 1/2" Sockets with Metric Hex Profile Copper Beryllium



NSB220

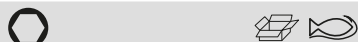

6 mm	1	NSB220-06
7 mm	1	NSB220-07
8 mm	1	NSB220-08
9 mm	1	NSB220-09
10 mm	1	NSB220-10
11 mm	1	NSB220-11
12 mm	1	NSB220-12
13 mm	1	NSB220-13
14 mm	1	NSB220-14
15 mm	1	NSB220-15
16 mm	1	NSB220-16
17 mm	1	NSB220-17
18 mm	1	NSB220-18
19 mm	1	NSB220-19
20 mm	1	NSB220-20
21 mm	1	NSB220-21
22 mm	1	NSB220-22
23 mm	1	NSB220-23
24 mm	1	NSB220-24
25 mm	1	NSB220-25
26 mm	1	NSB220-26
27 mm	1	NSB220-27
28 mm	1	NSB220-28
29 mm	1	NSB220-29
30 mm	1	NSB220-30
32 mm	1	NSB220-32

BAM/ZBF/003/21

Non-Sparking 3/4" Sockets with Metric Hex Profile Aluminium Bronze



NS224

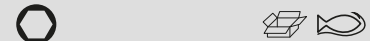

17 mm	1	NS224-17
18 mm	1	NS224-18
19 mm	1	NS224-19
21 mm	1	NS224-21
22 mm	1	NS224-22
23 mm	1	NS224-23
24 mm	1	NS224-24
26 mm	1	NS224-26
27 mm	1	NS224-27
28 mm	1	NS224-28
29 mm	1	NS224-29
30 mm	1	NS224-30
32 mm	1	NS224-32
34 mm	1	NS224-34
36 mm	1	NS224-36
38 mm	1	NS224-38
41 mm	1	NS224-41
46 mm	1	NS224-46
50 mm	1	NS224-50

BAM/ZBF/002/21

Non-Sparking 3/4" Sockets with Metric Hex Profile Copper Beryllium



NSB224



17 mm	1	NSB224-17
18 mm	1	NSB224-18
19 mm	1	NSB224-19
21 mm	1	NSB224-21
22 mm	1	NSB224-22
23 mm	1	NSB224-23
24 mm	1	NSB224-24
26 mm	1	NSB224-26
27 mm	1	NSB224-27
28 mm	1	NSB224-28
29 mm	1	NSB224-29
30 mm	1	NSB224-30
32 mm	1	NSB224-32
34 mm	1	NSB224-34

Ø			
36 mm	1	NSB224-36	
38 mm	1	NSB224-38	
41 mm	1	NSB224-41	
46 mm	1	NSB224-46	
50 mm	1	NSB224-50	

BAM/ZBF/003/21

Non-Sparking 1" Sockets with Metric Hex Profile Aluminium Bronze



NS228

Ø	L		
22 mm	55 mm	1	NS228-22
24 mm	55 mm	1	NS228-24
26 mm	55 mm	1	NS228-26
27 mm	55 mm	1	NS228-27
28 mm	55 mm	1	NS228-28
29 mm	55 mm	1	NS228-29
30 mm	60 mm	1	NS228-30
31 mm	60 mm	1	NS228-31
32 mm	60 mm	1	NS228-32
34 mm	60 mm	1	NS228-34
36 mm	65 mm	1	NS228-36
38 mm	65 mm	1	NS228-38
41 mm	70 mm	1	NS228-41
46 mm	75 mm	1	NS228-46
50 mm	75 mm	1	NS228-50
55 mm	80 mm	1	NS228-55
60 mm	85 mm	1	NS228-60
65 mm	90 mm	1	NS228-65
70 mm	90 mm	1	NS228-70
75 mm	95 mm	1	NS228-75
80 mm		1	NS228-80

BAM/ZBF/002/21

Non-Sparking 1" Sockets with Metric Hex Profile Copper Beryllium



NSB228

Ø	g		
22 mm	370 g	1	NSB228-22
24 mm	430 g	1	NSB228-24
26 mm	396 g	1	NSB228-26
27 mm	440 g	1	NSB228-27

Ø	g		
28 mm	411 g	1	NSB228-28
29 mm	460 g	1	NSB228-29
30 mm	462 g	1	NSB228-30
31 mm	520 g	1	NSB228-31
32 mm	497 g	1	NSB228-32
34 mm	506 g	1	NSB228-34
36 mm	610 g	1	NSB228-36
38 mm	600 g	1	NSB228-38
41 mm	740 g	1	NSB228-41
46 mm	832 g	1	NSB228-46
50 mm	960 g	1	NSB228-50
55 mm	1130 g	1	NSB228-55
60 mm	1570 g	1	NSB228-60
65 mm	1698 g	1	NSB228-65
70 mm	2350 g	1	NSB228-70
75 mm	3010 g	1	NSB228-75
80 mm	2818 g	1	NSB228-80

BAM/ZBF/003/21

Non-Sparking Adapters Aluminium Bronze



NS232

Ø	Ø		
1/2"	3/4"	1	NS232-16-24
3/4"	1/2"	1	NS232-24-16
3/4"	1"	1	NS232-24-32
1"	3/4"	1	NS232-32-24

BAM/ZBF/002/21

Non-Sparking Adapters Copper Beryllium



NSB232

Ø	Ø		
1/2"	3/4"	1	NSB232-16-24
3/4"	1/2"	1	NSB232-24-16
3/4"	1"	1	NSB232-24-32
1"	3/4"	1	NSB232-32-24

BAM/ZBF/003/21

Non-Sparking Extensions Aluminium Bronze



NS234

Ø	Ø		
1/2"	1/2"	1	NS234-16-100
1/2"	1/2"	1	NS234-16-200
1/2"	1/2"	1	NS234-16-250
3/4"	3/4"	1	NS234-24-200
1"	1"	1	NS234-32-250

BAM/ZBF/002/21

Non-Sparking Extensions Copper Beryllium



NSB234

L	Ø		
100 mm	16,4 mm	1	NSB234-16-100
200 mm	16,4 mm	1	NSB234-16-200
250 mm	16,4 mm	1	NSB234-16-250
200 mm	25 mm	1	NSB234-24-200
250 mm	34 mm	1	NSB234-32-250

BAM/ZBF/003/21

Non-Sparking Universal Joints Aluminium Bronze



NS236

Ø	Ø		
1/2"	1/2"	1	NS236-16
3/4"	3/4"	1	NS236-24
1"	1"	1	NS236-32

BAM/ZBF/002/21



Non-Sparking Universal Joints Copper Beryllium



NSB236

□	■	⊞	⊞
1/2"	1/2"	1	NSB236-16
3/4"	3/4"	1	NSB236-24
1"	1"	1	NSB236-32

BAM/ZBF/003/21

Non-Sparking Offset L-handles Aluminium Bronze



NS240

■	L	⊞	⊞
1/2"	230 mm	1	NS240-16-230

BAM/ZBF/002/21

Non-Sparking Reversible Ratchets Copper Beryllium



NSB242

L	g	⊞	⊞
245 mm	710 g	1	NSB242-16
320 mm	1660 g	1	NSB242-24
550 mm	3680 g	1	NSB242-32

BAM/ZBF/003/21

Non-Sparking Sliding T-handles Aluminium Bronze



NS238

■	L	⊞	⊞
1/2"	250 mm	1	NS238-16-250
3/4"	260 mm	1	NS238-24-250
1"	300 mm	1	NS238-32-300

BAM/ZBF/002/21

Non-Sparking Offset L-handles Copper Beryllium



NSB240

■	g	⊞	⊞
1/2"	370 g	1	NSB240-16-230

BAM/ZBF/003/21

Non-Sparking Speed Handles Aluminium Bronze



NS243

■	L	⊞	⊞
1/2"	390 mm	1	NS243-16-400

BAM/ZBF/002/21

Non-Sparking Sliding T-handles Copper Beryllium



NSB238

■	L	⊞	⊞
1/2"	250 mm	1	NSB238-16-250
3/4"	250 mm	1	NSB238-24-250
1"	300 mm	1	NSB238-32-300

BAM/ZBF/003/21

Non-Sparking Reversible Ratchets Aluminium Bronze



NS242

L	g	⊞	⊞
245 mm	630 g	1	NS242-16
320 mm	1460 g	1	NS242-24
550 mm	3190 g	1	NS242-32

BAM/ZBF/002/21

Non-Sparking Speed Handles Copper Beryllium



NSB243

■	L	⊞	⊞
1/2"	395 mm	1	NSB243-16-400

BAM/ZBF/003/21

Non-Sparking Spark Plug Sockets with Hex Profile Aluminium Bronze



NS247



1/2" 13 mm 1 NS247-26

BAM/ZBF/002/21

Non-Sparking Spark Plug Sockets with Hex Profile Copper Beryllium



NSB247



1/2" 13 mm 1 NSB247-26

BAM/ZBF/003/21

Non-Sparking Screwdriver Sockets Aluminium Bronze



NS248



13 mm 1 NS248-16-52

BAM/ZBF/002/21

Non-Sparking Screwdriver Sockets Copper Beryllium



NSB248

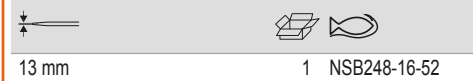

13 mm 1 NSB248-16-52

BAM/ZBF/003/21

SCREWDRIVERS

ERGO™ Non-Sparking Slotted Screwdrivers Aluminium Bronze



NS300

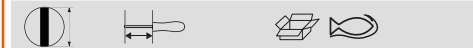

3 mm	50 mm	1	NS300-3-50
3 mm	75 mm	1	NS300-3-75
4 mm	75 mm	1	NS300-4-75
4.5 mm	50 mm	1	NS300-4.5-50
4.5 mm	100 mm	1	NS300-4.5-100
5 mm	75 mm	1	NS300-5-75
5 mm	100 mm	1	NS300-5-100
6 mm	100 mm	1	NS300-6-100
6 mm	125 mm	1	NS300-6-125
6 mm	150 mm	1	NS300-6-150
7 mm	150 mm	1	NS300-7-150
8 mm	150 mm	1	NS300-8-150
8 mm	200 mm	1	NS300-8-200
9 mm	250 mm	1	NS300-9-250
10 mm	200 mm	1	NS300-10-200
10 mm	300 mm	1	NS300-10-300
11 mm	250 mm	1	NS300-11-250
11 mm	300 mm	1	NS300-11-300
11 mm	350 mm	1	NS300-11-350
12 mm	400 mm	1	NS300-12-400
13 mm	450 mm	1	NS300-13-450

BAM/ZBF/002/21

ERGO™ Non-Sparking Slotted Screwdrivers Copper Beryllium



NSB300

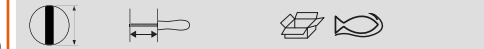

3 mm	50 mm	1	NSB300-3-50
3 mm	75 mm	1	NSB300-3-75
4 mm	75 mm	1	NSB300-4-75
4.5 mm	60 mm	1	NSB300-4.5-50
4.5 mm	95 mm	1	NSB300-4.5-100
5 mm	75 mm	1	NSB300-5-75
5 mm	100 mm	1	NSB300-5-100
6 mm	105 mm	1	NSB300-6-100
6 mm	125 mm	1	NSB300-6-125
6 mm	160 mm	1	NSB300-6-150
7 mm	150 mm	1	NSB300-7-150
8 mm	150 mm	1	NSB300-8-150
8 mm	200 mm	1	NSB300-8-200
9 mm	250 mm	1	NSB300-9-250
9 mm	200 mm	1	NSB300-10-200
10 mm	318 mm	1	NSB300-10-300
11 mm	250 mm	1	NSB300-11-250
11 mm	300 mm	1	NSB300-11-300
11 mm	350 mm	1	NSB300-11-350
12 mm	400 mm	1	NSB300-12-400
13 mm	450 mm	1	NSB300-13-450

BAM/ZBF/003/21

ERGO™ Non-Sparking Electrician Flat Tipped Screwdrivers Aluminium Bronze



NS301



3 mm	50 mm	1	NS301-3-50
4 mm	100 mm	1	NS301-4-100
4 mm	150 mm	1	NS301-4-150
5 mm	100 mm	1	NS301-5-100
5 mm	200 mm	1	NS301-5-200
6 mm	100 mm	1	NS301-6-100
8 mm	150 mm	1	NS301-8-150
10 mm	200 mm	1	NS301-10-200
10 mm	300 mm	1	NS301-10-300

BAM/ZBF/002/21



ERGO™ Non-Sparking Electrician Flat Tipped Screwdrivers Copper Beryllium



NSB301

Tip Size	Length	Part No.
3 mm	50 mm	1 NSB301-3-50
4 mm	100 mm	1 NSB301-4-100
4 mm	150 mm	1 NSB301-4-150
5 mm	100 mm	1 NSB301-5-100
5 mm	210 mm	1 NSB301-5-200
6 mm	100 mm	1 NSB301-6-100
8 mm	155 mm	1 NSB301-8-150
10 mm	200 mm	1 NSB301-10-200
10 mm	300 mm	1 NSB301-10-300

BAM/ZBF/003/21

ERGO™ Non-Sparking Pozidriv Screwdrivers Aluminium Bronze



NS304

Tip Size	Length	Part No.
PZ0	50 mm	1 NS304-0-50
PZ1	100 mm	1 NS304-1-100
PZ2	125 mm	1 NS304-2-125
PZ3	150 mm	1 NS304-3-150
PZ4	300 mm	1 NS304-4-300

BAM/ZBF/002/21

ERGO™ Non-Sparking Pozidriv Screwdrivers Copper Beryllium



NSB304

Tip Size	Length	Part No.
PZ0	50 mm	1 NSB304-0-50
PZ1	100 mm	1 NSB304-1-100
PZ2	125 mm	1 NSB304-2-125
PZ3	150 mm	1 NSB304-3-150
PZ4	300 mm	1 NSB304-4-300

BAM/ZBF/003/21

ERGO™ Non-Sparking Phillips Screwdrivers Aluminium Bronze



NS302

Tip Size	Length	Part No.
PH0	50 mm	1 NS302-0-50
PH1	100 mm	1 NS302-1-100
PH2	125 mm	1 NS302-2-125
PH3	150 mm	1 NS302-3-150
PH4	300 mm	1 NS302-4-300

BAM/ZBF/002/21

ERGO™ Non-Sparking Phillips Screwdrivers Copper Beryllium



NSB302

Tip Size	Length	Part No.
PH0	65 mm	1 NSB302-0-50
PH1	120 mm	1 NSB302-1-100
PH2	125 mm	1 NSB302-2-125
PH3	150 mm	1 NSB302-3-150
PH4	300 mm	1 NSB302-4-300

BAM/ZBF/003/21

Non-Sparking Offset Keys Aluminium Bronze



NS320

Tip Size	Part No.
2 mm	1 NS320-2
3 mm	1 NS320-3
4 mm	1 NS320-4
5 mm	1 NS320-5
6 mm	1 NS320-6
7 mm	1 NS320-7
8 mm	1 NS320-8
9 mm	1 NS320-9
10 mm	1 NS320-10

BAM/ZBF/002/21

Non-Sparking Offset Keys Copper Beryllium



NSB320

Tip Size	Part No.
2 mm	1 NSB320-2
3 mm	1 NSB320-3
4 mm	1 NSB320-4
5 mm	1 NSB320-5
6 mm	1 NSB320-6
7 mm	1 NSB320-7
8 mm	1 NSB320-8
9 mm	1 NSB320-9
10 mm	1 NSB320-10

BAM/ZBF/003/21

PLIERS

Non-Sparking Combination Pliers Aluminium Bronze



NS400

Length	Part No.
155 mm	1 NS400-160
175 mm	1 NS400-180
200 mm	1 NS400-200

BAM/ZBF/002/21

Non-Sparking Combination Pliers Copper Beryllium



NSB400

Length	Part No.
157 mm	1 NSB400-160
175 mm	1 NSB400-180
200 mm	1 NSB400-200

BAM/ZBF/003/21

Non-Sparking Diagonal Cutting Pliers Aluminium Bronze



NS402

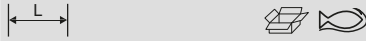

150 mm	1 NS402-160
200 mm	1 NS402-200

BAM/ZBF/002/21

Non-Sparking Diagonal Cutting Pliers Copper Beryllium



NSB402

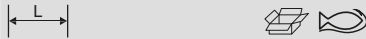

155 mm	1 NSB402-160
200 mm	1 NSB402-200

BAM/ZBF/003/21

Non-Sparking Heavy Duty Diagonal Cutting Pliers Aluminium Bronze



NS403

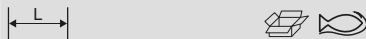

150 mm	1 NS403-160
180 mm	1 NS403-180

BAM/ZBF/002/21

Non-Sparking Heavy Duty Diagonal Cutting Pliers Copper Beryllium



NSB403

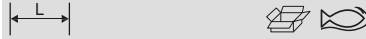

155 mm	1 NSB403-160
180 mm	1 NSB403-180

BAM/ZBF/003/21

Non-Sparking Long Flat Nose Pliers Aluminium Bronze



NS404

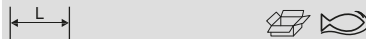

150 mm	1 NS404-160
--------	-------------

BAM/ZBF/002/21

Non-Sparking Long Flat Nose Pliers Copper Beryllium



NSB404

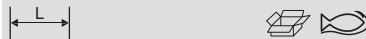

155 mm	1 NSB404-160
--------	--------------

BAM/ZBF/003/21

Non-Sparking Round Nose Pliers Aluminium Bronze



NS405

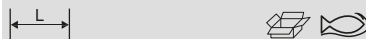

160 mm	1 NS405-160
--------	-------------

BAM/ZBF/002/21

Non-Sparking Round Nose Pliers Copper Beryllium



NSB405

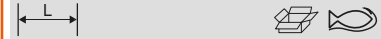

155 mm	1 NSB405-160
--------	--------------

BAM/ZBF/003/21

Non-Sparking Long Nose Pliers Aluminium Bronze



NS406



160 mm	1 NS406-160
180 mm	1 NS406-180
200 mm	1 NS406-200

BAM/ZBF/002/21

Non-Sparking Long Nose Pliers Copper Beryllium



NSB406

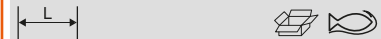

155 mm	1 NSB406-160
180 mm	1 NSB406-180
200 mm	1 NSB406-200

BAM/ZBF/003/21

Non-Sparking Wire Strippers Aluminium Bronze



NS407



170 mm	1 NS407-160
--------	-------------

BAM/ZBF/002/21



Non-Sparking Wire Strippers Copper Beryllium



NSB407



170 mm



1 NSB407-160

BAM/ZBF/003/21

Non-Sparking Groove Joint Pliers Aluminium Bronze



NS408



260 mm
300 mm



1 NS408-250
1 NS408-300

BAM/ZBF/002/21

Non-Sparking Groove Joint Pliers Copper Beryllium



NSB408



255 mm
300 mm



1 NSB408-250
1 NSB408-300

BAM/ZBF/003/21

Non-Sparking Slip Joint Pliers Aluminium Bronze



NS412



200 mm



1 NS412-200

BAM/ZBF/002/21

Non-Sparking Slip Joint Pliers Copper Beryllium



NSB412



200 mm



1 NSB412-200

BAM/ZBF/003/21

Non-Sparking Gas Pliers Aluminium Bronze



NS411



200 mm



1 NS411-200

BAM/ZBF/002/21

Non-Sparking Gas Pliers Copper Beryllium



NSB411



205 mm



1 NSB411-200

BAM/ZBF/003/21

Non-Sparking Carpenter's Pincers Aluminium Bronze



NS413



180 mm
195 mm



1 NS413-180
1 NS413-200

BAM/ZBF/002/21

Non-Sparking Carpenter's Pincers Copper Beryllium



NSB413



185 mm
195 mm



1 NSB413-180
1 NSB413-200

BAM/ZBF/003/21

HAMMERS, PRY BARS & CHISELS

Non-Sparking Stoning Hammers with Aluminium Bronze Head and Wooden Handle



NS500



2000 g
2500 g
3000 g
4000 g



1 NS500-2000
1 NS500-2500
1 NS500-3000
1 NS500-4000

BAM/ZBF/002/21

Non-Sparking Stoning Hammers with Copper Beryllium Head and Wooden Handle



NSB500



2000 g
2500 g
3000 g
4000 g



1 NSB500-2000
1 NSB500-2500
1 NSB500-3000
1 NSB500-4000

BAM/ZBF/003/21

Non-Sparking Stoning Hammers with Aluminium Bronze Head and Fibreglass Handle



NS500-FB

Weight (g)	Quantity	Model
1000	1	NS500-1000-FB
1500	1	NS500-1500-FB
2000	1	NS500-2000-FB
2500	1	NS500-2500-FB
3000	1	NS500-3000-FB
3500	1	NS500-3500-FB

BAM/ZBF/002/21

Weight (g)	Quantity	Model
6800	1	NS502-6800-FB
8000	1	NS502-8000-FB
10000	1	NS502-10000-FB
12000	1	NS502-12000-FB

BAM/ZBF/002/21

Non-Sparking Sledge Hammers with Copper Beryllium Head and Fibreglass Handle



NSB502-FB

Weight (g)	Quantity	Model
450	1	NSB502-450-FB
1000	1	NSB502-1000-FB
1500	1	NSB502-1500-FB
2000	1	NSB502-2000-FB
2500	1	NSB502-2500-FB
3000	1	NSB502-3000-FB
4500	1	NSB502-4500-FB
5000	1	NSB502-5000-FB
6800	1	NSB502-6800-FB
8000	1	NSB502-8000-FB
10000	1	NSB502-10000-FB
12000	1	NSB502-12000-FB

BAM/ZBF/003/21

Non-Sparking Stoning Hammers with Copper Beryllium Head and Fibreglass Handle



NSB500-FB

Weight (g)	Quantity	Model
1000	1	NSB500-1000-FB
1500	1	NSB500-1500-FB
2000	1	NSB500-2000-FB
2500	1	NSB500-2500-FB
3000	1	NSB500-3000-FB
3500	1	NSB500-3500-FB

BAM/ZBF/003/21

Non-Sparking Sledge Hammers with Aluminium Bronze Head and Fibreglass Handle



NS502-FB

Weight (g)	Quantity	Model
450	1	NS502-450-FB
1000	1	NS502-1000-FB
1500	1	NS502-1500-FB
2000	1	NS502-2000-FB
2500	1	NS502-2500-FB
3000	1	NS502-3000-FB
4500	1	NS502-4500-FB
5000	1	NS502-5000-FB

BAM/ZBF/002/21

Non-Sparking Machinist's Hammers with Copper Beryllium Head and Fibreglass Handle



NSB504-FB

Weight (g)	Quantity	Model
100	1	NSB504-100-FB
200	1	NSB504-200-FB
300	1	NSB504-300-FB
500	1	NSB504-500-FB
800	1	NSB504-800-FB
1000	1	NSB504-1000-FB
1500	1	NSB504-1500-FB
2000	1	NSB504-2000-FB

BAM/ZBF/003/21

Non-Sparking Ball Pein Hammers with Aluminium Bronze Head and Wooden Handle



NS506

Weight (g)	Quantity	Model
340	1	NS506-300
450	1	NS506-450
670	1	NS506-700
910	1	NS506-900

BAM/ZBF/002/21

Non-Sparking Ball Pein Hammers with Copper Beryllium Head and Wooden Handle



NSB506

Weight (g)	Quantity	Model
300	1	NSB506-300
450	1	NSB506-450
680	1	NSB506-700
910	1	NSB506-900

BAM/ZBF/003/21



Non-Sparking Ball Pein Hammers with Aluminium Bronze Head and Fibreglass Handle



NS506-FB

Weight	Product Code
310 g	1 NS506-300-FB
470 g	1 NS506-450-FB
700 g	1 NS506-700-FB
910 g	1 NS506-900-FB

BAM/ZBF/002/21

Non-Sparking Ball Pein Hammers with Copper Beryllium Head and Fibreglass Handle



NSB506-FB

Weight	Product Code
300 g	1 NSB506-300-FB
450 g	1 NSB506-450-FB
680 g	1 NSB506-700-FB
900 g	1 NSB506-900-FB

BAM/ZBF/003/21

Non-Sparking Claw Hammers with Aluminium Bronze Head and Fibreglass Handle



NS508-FB

Weight	Product Code
500 g	1 NS508-500-FB
700 g	1 NS508-700-FB

BAM/ZBF/002/21

Non-Sparking Claw Hammers with Copper Beryllium Head and Fibreglass Handle



NSB508-FB

Weight	Product Code
500 g	1 NSB508-500-FB
700 g	1 NSB508-700-FB

BAM/ZBF/003/21

Non-Sparking Chipping Hammers with Aluminium Bronze Head and Fibreglass Handle



NS512-FB

Weight	Product Code
230 g	1 NS512-200-FB
400 g	1 NS512-400-FB
640 g	1 NS512-600-FB
970 g	1 NS512-900-FB

BAM/ZBF/002/21

Non-Sparking Chipping Hammers with Copper Beryllium Head and Fibreglass Handle



NSB512-FB

Weight	Product Code
200 g	1 NSB512-200-FB
400 g	1 NSB512-400-FB
600 g	1 NSB512-600-FB
900 g	1 NSB512-900-FB

BAM/ZBF/003/21

Non-Sparking Wedges Aluminium Bronze



NS600

Length	Product Code
80 mm	1 NS600-80-13
100 mm	1 NS600-100-50
135 mm	1 NS600-135-50
150 mm	1 NS600-150-25
150 mm	1 NS600-150-30
150 mm	1 NS600-150-40
150 mm	1 NS600-150-50
180 mm	1 NS600-180-13
180 mm	1 NS600-180-32
180 mm	1 NS600-180-50
200 mm	1 NS600-200-20
200 mm	1 NS600-200-30
200 mm	1 NS600-200-40
200 mm	1 NS600-200-50
230 mm	1 NS600-230-40
250 mm	1 NS600-250-40
300 mm	1 NS600-300-50

BAM/ZBF/002/21

Non-Sparking Wedges Copper Beryllium



NSB600

Length	Product Code
80 mm	1 NSB600-80-13
100 mm	1 NSB600-100-50
135 mm	1 NSB600-135-50
150 mm	1 NSB600-150-25
150 mm	1 NSB600-150-30
150 mm	1 NSB600-150-40
150 mm	1 NSB600-150-50
180 mm	1 NSB600-180-13
180 mm	1 NSB600-180-32
180 mm	1 NSB600-180-50
200 mm	1 NSB600-200-20
200 mm	1 NSB600-200-30
200 mm	1 NSB600-200-40
200 mm	1 NSB600-200-50
230 mm	1 NSB600-230-40
250 mm	1 NSB600-250-40
300 mm	1 NSB600-300-50

BAM/ZBF/003/21

Non-Sparking Wrecking Bars Aluminium
Bronze



NS602

Ø	L	1	NS602-460
16 mm	460 mm	1	NS602-460
20 mm	600 mm	1	NS602-600
22 mm	760 mm	1	NS602-760
22 mm	935 mm	1	NS602-900

BAM/ZBF/002/21

Non-Sparking Wrecking Bars Copper
Beryllium



NSB6028

Ø	L	1	NSB602-460
16 mm	460 mm	1	NSB602-460
20 mm	600 mm	1	NSB602-600
22 mm	760 mm	1	NSB602-760
22 mm	920 mm	1	NSB602-900

BAM/ZBF/003/21

Non-Sparking Cross Cutting Chisels
Aluminium Bronze



NS604

L	1	NS604-150
140 mm	1	NS604-150
200 mm	1	NS604-200
300 mm	1	NS604-300

BAM/ZBF/002/21

Non-Sparking Cross Cutting Chisels
Copper Beryllium



NSB604

L	1	NSB604-150
140 mm	1	NSB604-150
200 mm	1	NSB604-200
300 mm	1	NSB604-300

BAM/ZBF/003/21

Non-Sparking Flat Chisels Aluminium
Bronze



NS606

L	1	NS606-150
150 mm	1	NS606-150
200 mm	1	NS606-200
250 mm	1	NS606-250
300 mm	1	NS606-300
400 mm	1	NS606-400

BAM/ZBF/002/21

Non-Sparking Flat Chisels Copper
Beryllium



NSB606

L	1	NSB606-150
150 mm	1	NSB606-150
200 mm	1	NSB606-200
250 mm	1	NSB606-250
300 mm	1	NSB606-300
400 mm	1	NSB606-400

BAM/ZBF/003/21

Non-Sparking Centre Punches Aluminium
Bronze



NS608

L	1	NS608-100
100 mm	1	NS608-100

BAM/ZBF/002/21

Non-Sparking Centre Punches Copper
Beryllium



NSB608

L	1	NSB608-100
100 mm	1	NSB608-100

BAM/ZBF/003/21

SCRAPERS

Non-Sparking Angled Scrapers Aluminium
Bronze



NS700

L	1	NS700-300
45 mm	1	NS700-300

BAM/ZBF/002/21



Non-Sparking Angled Scrapers Copper Beryllium



NSB700

45 mm	310 mm	1	NSB700-300

BAM/ZBF/003/21

Non-Sparking Long Blade Scrapers Aluminium Bronze



NS704

100 mm	720 mm	1	NS704-225

BAM/ZBF/002/21

Non-Sparking Flexible Scrapers Copper Beryllium



NSB706

50 mm	200 mm	1	NSB706-50
80 mm	200 mm	1	NSB706-80

BAM/ZBF/003/21

Non-Sparking Flat Scrapers Aluminium Bronze



NS702

30 mm	325 mm	1	NS702-200

BAM/ZBF/002/21

Non-Sparking Long Blade Scrapers Copper Beryllium



NSB704

100 mm	720 mm	1	NSB704-225

BAM/ZBF/003/21

Non-Sparking Three-Square Scrapers Aluminium Bronze



NS708

440 mm		1	NS708-360

BAM/ZBF/002/21

Non-Sparking Flat Scrapers Copper Beryllium



NSB702

30 mm	325 mm	1	NSB702-200

BAM/ZBF/003/21

Non-Sparking Flexible Scrapers Aluminium Bronze



NS706

50 mm	200 mm	1	NS706-50
80 mm	200 mm	1	NS706-80

BAM/ZBF/002/21

Non-Sparking Three-Square Scrapers Copper Beryllium



NSB708

450 mm		1	NSB708-360

BAM/ZBF/003/21

Non-Sparking Triangular Ship Scrapers
Aluminium Bronze



NS710

470 mm	1	NS710-450

BAM/ZBF/002/21

Non-Sparking Triangular Ship Scrapers
Copper Beryllium



NSB710

470 mm	1	NSB710-450

BAM/ZBF/003/21

DIGGING TOOLS

Non-Sparking Pickaxes Aluminium Bronze



NS800

910 mm	1	NS800-1100
910 mm	1	NS800-1700
965 mm	1	NS800-2000

BAM/ZBF/002/21

Non-Sparking Pickaxes Copper Beryllium



NSB800

910 mm	2000 g	1	NSB800-1100
910 mm	2800 g	1	NSB800-1700
910 mm	3200 g	1	NSB800-2000

BAM/ZBF/003/21

Non-Sparking Round Shovels Aluminium
Bronze



NS802

1370 mm	1	NS802-290

BAM/ZBF/002/21

Non-Sparking Round Shovels Copper
Beryllium



NSB802

1450 mm	1	NSB802-290

BAM/ZBF/003/21

Non-Sparking Hand Brushes Brass



NS804

290 mm	1	NS804-290

BAM/ZBF/002/21

EXTRACTORS & PULLERS

Non-Sparking 3-Jaws Reversible Pullers
Aluminium Bronze



NS810

50-100 mm	105 mm	1	NS810-100
60-150 mm	175 mm	1	NS810-150
70-200 mm	250 mm	1	NS810-200
80-350 mm	320 mm	1	NS810-350

BAM/ZBF/002/21

Non-Sparking 3-Jaws Reversible Pullers
Copper Beryllium



NSB810

50-100 mm	105 mm	1	NSB810-100
60-150 mm	175 mm	1	NSB810-150
70-200 mm	250 mm	1	NSB810-200
80-350 mm	320 mm	1	NSB810-350

BAM/ZBF/003/21



TORQUE TOOLS

Non-Sparking Mechanical Adjustable Torque Click Wrenches with Window Scale and Fixed Ratchet Head in Aluminium Bronze



NS041

Size	Range (Nm)	Quantity	Part Number
1/4"	5-25 Nm	1	NS041-8-25
3/8"	10-50 Nm	1	NS041-12-50
1/2"	20-100 Nm	1	NS041-16-100
1/2"	40-200 Nm	1	NS041-16-200
1/2"	60-260 Nm	1	NS041-16-260
3/4"	150-670 Nm	1	NS041-24-670
1"	200-900 Nm	1	NS041-32-900

BAM/ZBF/002/21

Non-Sparking Mechanical Adjustable Torque Click Wrenches with Window Scale and Fixed Ratchet Head in Copper Beryllium



NSB041

Size	Range (Nm)	Quantity	Part Number
1/4"	5-25 Nm	1	NSB041-8-25
3/8"	10-50 Nm	1	NSB041-12-50
1/2"	20-100 Nm	1	NSB041-16-100
1/2"	40-200 Nm	1	NSB041-16-200
1/2"	60-260 Nm	1	NSB041-16-260
3/4"	150-670 Nm	1	NSB041-24-670
1"	200-900 Nm	1	NSB041-32-900

BAM/ZBF/003/21



Stainless Steel Tools



TROLLEYS

26" 7 Drawers Stainless Steel Tool Trolley



1470K7SS



956 x 500 x 762 mm

1 1470K7SS

40" 7 Drawers Stainless Steel Tool Trolley



1475KXL7SS



986 x 501 x 1100 mm

1 1475KXL7SS

WRENCHES

Stainless Steel Central Nut Adjustable Wrenches



SS001



100mm/4"	13 mm	1	SS001-100
150mm/6"	18 mm	1	SS001-150
200mm/8"	24 mm	1	SS001-200
250mm/10"	30 mm	1	SS001-250
300mm/12"	36 mm	1	SS001-300
375mm/15"	46 mm	1	SS001-375
450mm/18"	55 mm	1	SS001-450
600mm/24"	60 mm	1	SS001-600

Stainless Steel Metric Offset Combination Wrenches



SS002



6 mm	1	SS002-6
8 mm	1	SS002-8
10 mm	1	SS002-10
11 mm	1	SS002-11
12 mm	1	SS002-12
13 mm	1	SS002-13
14 mm	1	SS002-14
15 mm	1	SS002-15
16 mm	1	SS002-16
17 mm	1	SS002-17
19 mm	1	SS002-19
21 mm	1	SS002-21
22 mm	1	SS002-22
24 mm	1	SS002-24
27 mm	1	SS002-27
32 mm	1	SS002-32

Stainless Steel Metric Combination Wrench Set - 6 Pcs



SS002-6-2



6	710 g	1	SS002-6-2
---	-------	---	-----------

SS002-8, SS002-10, SS002-12, SS002-14, SS002-17, SS002-19

Stainless Steel Metric Combination Wrench Set - 9 Pcs



SS002-9-2



9	924 g	1	SS002-9-2
---	-------	---	-----------

SS002-8, SS002-10, SS002-11, SS002-12, SS002-13, SS002-14, SS002-15, SS002-17, SS002-19

Stainless Steel Imperial Combination Wrenches



SS003



1/4 in	105 mm	1	SS003-8
5/16 in	120 mm	1	SS003-10
11/32 in	135 mm	1	SS003-11
3/8 in	135 mm	1	SS003-12
7/16 in	150 mm	1	SS003-14
1/2 in	175 mm	1	SS003-16
9/16 in	175 mm	1	SS003-18
5/8 in	195 mm	1	SS003-20
11/16 in	195 mm	1	SS003-22
3/4 in	215 mm	1	SS003-24
25/32 in	215 mm	1	SS003-25
13/16 in	245 mm	1	SS003-26
7/8 in	245 mm	1	SS003-28
15/16 in	265 mm	1	SS003-30

Stainless Steel Metric Double Ring End Offset Wrenches



SS011



5.5*7 mm	180 mm	1	SS011-0507
6*7 mm	180 mm	1	SS011-0607
8*9 mm	190 mm	1	SS011-0809
8*10 mm	190 mm	1	SS011-0810
9*11 mm	215 mm	1	SS011-0911
10*12 mm	215 mm	1	SS011-1012
12*14 mm	225 mm	1	SS011-1214
14*17 mm	255 mm	1	SS011-1417
16*18 mm	280 mm	1	SS011-1618
17*19 mm	280 mm	1	SS011-1719
17*22 mm	300 mm	1	SS011-1722
22*24 mm	330 mm	1	SS011-2224
24*27 mm	340 mm	1	SS011-2427
24*30 mm	350 mm	1	SS011-2430
30*32 mm	370 mm	1	SS011-3032

Stainless steel double ring end offset wrenches sets, mm. 9 pieces



SS011-9-3

9	2470 g	1	SS011-9-3

SS011-0810, SS011-1012, SS011-1214, SS011-1417, SS011-1719, SS011-1722, SS011-2224, SS011-2427, SS011-3032

Stainless steel double ring end offset wrenches sets, mm. 11 pieces



SS011-11-3

11	3100 g	1	SS011-11-3

SS011-0810, SS011-0911, SS011-1012, SS011-1214, SS011-1417, SS011-1719, SS011-1722, SS011-2224, SS011-2427, SS011-2430, SS011-3032

SOCKETS & RATCHETS

1/4" Square Drive Stainless Steel Sockets with Metric Hex Profile



SS210

4 mm	25 mm	1	SS210-4
4.5 mm	25 mm	1	SS210-4.5

5 mm	25 mm	1	SS210-5
5.5 mm	25 mm	1	SS210-5.5
6 mm	25 mm	1	SS210-6
7 mm	25 mm	1	SS210-7
8 mm	25 mm	1	SS210-8
9 mm	25 mm	1	SS210-9
10 mm	25 mm	1	SS210-10
11 mm	25 mm	1	SS210-11
12 mm	26 mm	1	SS210-12
13 mm	26 mm	1	SS210-13
14 mm	26 mm	1	SS210-14

1/2" Square Drive Stainless Steel Sockets with Metric Hex Profile



SS220

8 mm	40 mm	1	SS220-8
9 mm	40 mm	1	SS220-9
10 mm	40 mm	1	SS220-10
11 mm	40 mm	1	SS220-11
12 mm	40 mm	1	SS220-12
13 mm	40 mm	1	SS220-13
14 mm	40 mm	1	SS220-14
15 mm	40 mm	1	SS220-15
16 mm	40 mm	1	SS220-16
17 mm	40 mm	1	SS220-17
18 mm	42 mm	1	SS220-18
19 mm	42 mm	1	SS220-19
20 mm	42 mm	1	SS220-20
21 mm	43 mm	1	SS220-21
22 mm	43 mm	1	SS220-22
23 mm	43 mm	1	SS220-23
24 mm	43 mm	1	SS220-24
25 mm	43 mm	1	SS220-25
26 mm	43 mm	1	SS220-26
27 mm	46 mm	1	SS220-27
28 mm	46 mm	1	SS220-28
29 mm	46 mm	1	SS220-29
30 mm	46 mm	1	SS220-30
31 mm	46 mm	1	SS220-31
32 mm	46 mm	1	SS220-32

3/4" Square Drive Stainless Steel Sockets with Metric Hex Profile



SS224

17 mm	50 mm	1	SS224-17
19 mm	50 mm	1	SS224-19
22 mm	55 mm	1	SS224-22
24 mm	55 mm	1	SS224-24
27 mm	55 mm	1	SS224-27
30 mm	60 mm	1	SS224-30
32 mm	60 mm	1	SS224-32
34 mm	60 mm	1	SS224-34
36 mm	60 mm	1	SS224-36
41 mm	65 mm	1	SS224-41
46 mm	65 mm	1	SS224-46
50 mm	70 mm	1	SS224-50
55 mm	75 mm	1	SS224-55
60 mm	75 mm	1	SS224-60
65 mm	80 mm	1	SS224-65

Stainless Steel Extensions



SS234

100 mm	1	SS234-16-100
200 mm	1	SS234-16-200
250 mm	1	SS234-16-250
100 mm	1	SS234-24-100
200 mm	1	SS234-24-200
250 mm	1	SS234-24-250

Stainless Steel Universal Joints



SS236

56 mm	1	SS236-08-80
80 mm	1	SS236-16-80
110 mm	1	SS236-24-110



Stainless Steel Sliding T-Handles



SS238

250 mm	1	SS238-08-250
250 mm	1	SS238-16-250
350 mm	1	SS238-24-350

Stainless Steel Rotary Speed Handles



SS243

300 mm	1	SS243-08
390 mm	1	SS243-16
450 mm	1	SS243-24

Stainless Steel Reversible Ratchets



SS242

200 mm	1	SS242-08-200
245 mm	1	SS242-16-245
320 mm	1	SS242-24-320

SCREWDRIVERS

ERGO™ Stainless Steel Straight Tipped Slotted Screwdrivers with 3-Component Handle 0.5 mm-1.2 mm



BE-8020i - BE-8252i

3.0 mm	60 mm	5	BE-8020i
3.5 mm	75 mm	5	BE-8030i

4.0 mm	100 mm	5	BE-8040i
5.5 mm	125 mm	5	BE-8241i
6.5 mm	150 mm	5	BE-8252i

ERGO™ Stainless Steel Phillips Screwdrivers with 3-Component Handle PH0-PH4



BE-8600i - BE-8623i

PH 0	60 mm	5	BE-8600i
PH 1	75 mm	5	BE-8610i
PH 2	100 mm	5	BE-8620i
PH 3	150 mm	5	BE-8623i

ERGO™ Stainless Steel Pozidriv Screwdrivers with 3-Component Handle PZ0-PZ4



BE-8800i - BE-8823i

PZ 0	60 mm	5	BE-8800i
PZ 1	75 mm	5	BE-8810i
PZ 2	100 mm	5	BE-8820i
PZ 3	150 mm	5	BE-8823i

ERGO™ Stainless Steel TORX® Screwdrivers with 3-Component Handle T10-T25



BE-8910i - BE-8925i

T 10	75 mm	5	BE-8910i
T 15	100 mm	5	BE-8915i
T 20	100 mm	5	BE-8920i
T 25	125 mm	5	BE-8925i

ERGO™ Stainless Steel Slotted/Phillips Screwdriver Set - 6 Pcs



BE-9881i

6	1	BE-9881i	

BE-8020i, BE-8040i, BE-8241i, BE-8252i

BE-8610i, BE-8620i

ERGO™ Stainless Steel Slotted/Pozidriv Screwdriver Set - 6 Pcs



BE-9882i

6	1	BE-9882i	

BE-8020i, BE-8040i, BE-8241i, BE-8252i

BE-8810i, BE-8820i

L-KEYS

Imperial Stainless Steel Long L-Key Set for Hex Screws - 13 Pcs



BE-9785i

13	1	BE-9785i

0.05; 1/16; 5/64; 3/32;
7/64; 1/8; 9/64; 5/32; 3/16;
7/32; 1/4; 5/16; 3/8; in

Metric Stainless Steel L-Keys with Long Ball End for Hex Screws



SS324

1,5 mm	2	SS324-1.5
2 mm	2	SS324-2
2,5 mm	2	SS324-2.5
3 mm	1	SS324-3
4 mm	1	SS324-4
5 mm	1	SS324-5
6 mm	1	SS324-6
8 mm	1	SS324-8
10 mm	1	SS324-10

Metric Stainless Steel L-Key Set with Long Ball End for Hex Screws - 9 Pcs



BE-9770i

9	1.5; 2; 2.5; 3; 4; 5; 6; 8; 10 mm	20	BE-9770i
---	-----------------------------------	----	----------

SS324-1.5, SS324-2, SS324-2.5, SS324-3, SS324-4, SS324-5, SS324-6, SS324-8, SS324-10

Imperial Stainless Steel L-Keys with Long Ball End for Hex Screws



SS325

5/64" in	2	SS325-2.5
7/64" in	2	SS325-3.5
1/8" in	1	SS325-4
9/64" in	1	SS325-4.5
5/32" in	1	SS325-5
3/16" in	1	SS325-6
7/32" in	1	SS325-7
1/4" in	1	SS325-8
5/16" in	1	SS325-10
3/8" in	1	SS325-12
3/32" in	2	SS325-3

Imperial Stainless Steel L-Key Set with Long Ball End for Hex Screws - 13 Pcs



BE-9786i

13	0.05; 1/16; 5/64; 3/32; 7/64; 1/8; 9/64; 5/32; 3/16; 7/32; 1/4; 5/16; 3/8; in	1	BE-9786i
----	---	---	----------

SS325-2.5, SS325-3, SS325-3.5, SS325-4, SS325-4.5, SS325-5, SS325-6, SS325-7, SS325-8, SS325-10, SS325-12

SCREWDRIVER BITS

1/4" Stainless Steel Torsion Screwdriver Bits for Phillips Head Screws 25 mm



65I/PH

10	1	1	65I/PH1
10	2	1	65I/PH2
10	3	1	65I/PH3

1/4" Stainless Steel Torsion Screwdriver Bits for Pozidriv Head Screws 25 mm



65I/PZ

10	1	1	65I/PZ1
10	2	1	65I/PZ2
10	3	1	65I/PZ3

1/4" Stainless Steel Torsion Screwdriver Bits for TORX® Head Screws 25 mm



65I/T

5	T15	1	65I/T15
5	T40	1	65I/T40

1/4" Hex Universal Bit Holders with Retaining Ring 75 mm



KSR753

1	1/4 in	1	KSR753-1P
5	1/4 in	1	KSR753

1/4" Stainless Steel Bit Set for Phillips/Pozidriv/TORX® Screws - 7 Pcs



65I/7

22 x 65 x 75 mm	1	65I/7-1
-----------------	---	---------

+ 1 bitholder

65I/PH2	
65I/PZ2	
65I/T15, 65I/T20, 65I/T25, 65I/T30	



PLIERS

Stainless Steel Combination Pliers with PVC Coated Handles



SS400



155 mm	1	SS400-160
175 mm	1	SS400-180
200 mm	1	SS400-200

Stainless Steel Diagonal Cutting Pliers with PVC Coated Handles



SS402



150 mm	1	SS402-160
195 mm	1	SS402-200

Stainless Steel Slip Joint Pliers with 2-Position and PVC Coated Handles



SS412



200 mm	1	SS412-200
--------	---	-----------

Stainless Steel Snipe Nose Pliers with PVC Coated Handles



SS406



150 mm	1	SS406-160
175 mm	1	SS406-200

Stainless Steel Box Joint Pliers with PVC Coated Handles



SS410



250 mm	1	SS410-250
300 mm	1	SS410-300

Stainless Steel Locking Pliers



SS415



255 mm	1	SS415-225
--------	---	-----------

HAMMERS

Stainless Steel Ball Pein Hammers with Fibreglass Handle



SS506



200 g	1	SS506-200-FB
300 g	1	SS506-300-FB



450 g	1	SS506-500-FB
680 g	1	SS506-700-FB
900 g	1	SS506-900-FB
1100 g	1	SS506-1100-FB

Stainless Steel Sledge Hammers with Fibreglass Handle



SS502



1000 g	1	SS502-1000-FB
1500 g	1	SS502-1500-FB
2000 g	1	SS502-2000-FB
2500 g	1	SS502-2500-FB
3000 g	1	SS502-3000-FB
3600 g	1	SS502-3600-FB

PUNCHES & COLD CHISELS

Stainless Steel Tapered Pry Bars



SS603



500 mm	1	SS603-15-500
500 mm	1	SS603-19-500
500 mm	1	SS603-20-500
500 mm	1	SS603-23-500
800 mm	1	SS603-23-800
600 mm	1	SS603-25-600
1000 mm	1	SS603-30-1000

Stainless Steel 55° Flat Chisel with Oval Form



SS610



160 mm	1	SS610-16-160
200 mm	1	SS610-18-200
300 mm	1	SS610-24-300
400 mm	1	SS610-25-400
500 mm	1	SS610-30-500

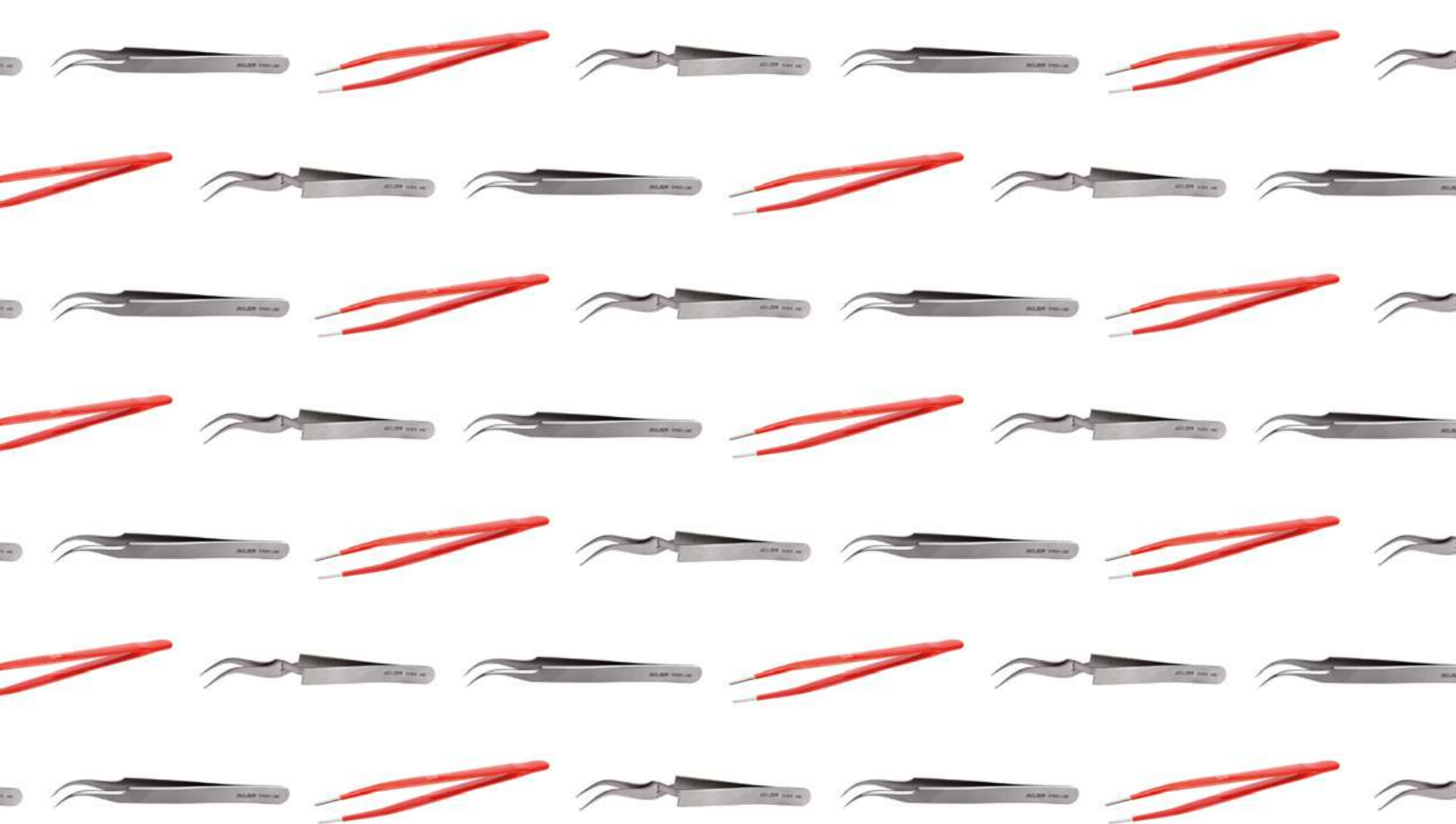

Tweezers & Electronics Specialty Tools



TWEEZERS

General Purpose Tweezers with Serrated Tips



5468



112 mm



5 5468-112

General Purpose Tweezers with Polished/PVC Coated Finish 127 mm



5469



127 mm

127 mm

127 mm



5 5469-127

5 5469 R

5 5469 I

General Purpose Tweezers with Polished/PVC Coated Finish 120 mm



5469B



120 mm

120 mm



5 5469 B

5 5469 BI

General Pointed Tweezers with Polished and Nickel Plated Finish



5479



130 mm



5 5479-130

General Purpose Tweezers with Polished and Nickel Plated/Polished/PVC Coated Finish



5471F



120 mm

145 mm

200 mm

250 mm

300 mm

120 mm

200 mm

120 mm

145 mm



5 5471 F-120

5 5471 F-145

5 5471 F-200

5 5471 F-250

5 5471 F-300

5 5471 FI-120

5 5471 FI-200

5 5471 FR-120

5 5471 FR-145

General Purpose Tweezers with Polished and Nickel Plated/Polished Finish



5475R/5475K



150 mm

100 mm



5 5475 R

5 5475 K

General Purpose Tweezers with Polished and Nickel Plated/PVC Coated Finish



5516



150 mm

150 mm



5 5516

5 5516 I

Non-Magnetic Titanium General Tweezers for Fine and Ultra-Fine Assembly Work 110 mm



5465AMT



110 mm



5 5465 AMT

Non-Magnetic Stainless steel General Tweezers for Fine and Ultra-Fine Assembly Work 130 mm



5469AMI



130 mm



1 5469 AMI

General Pointed Tweezers with Polished and Nickel Plated/PVC Coated Finish



5517



155 mm

155 mm



5 5517

5 5517 I

General Reverse Action Tweezers with Polished and Nickel Plated Finish



5518



155 mm



5 5518

SMD Tweezers for Handling and Positioning SOT Packages



5540AM



120 mm



5 5540 AM

SMD Tweezers for Positioning and Soldering 1 mm Components



5546AM



120 mm



5 5546 AM

Electronics Tweezers for Picking Up Flat Lying Components



5489AM



115 mm



5 5489 AM

SMD Tweezers for Positioning All SOT Packages Vertically



5541AM



120 mm



5 5541 AM

SMD Tweezers for Positioning and Soldering 1 mm Components at 45° Angle



5547AM



120 mm



5 5547 AM

Electronics Tweezers for Easy Manipulation of Components in Confined Areas



5490AM



115 mm



5 5490 AM

SMD Tweezers for Handling and Positioning 2/3 Lead SOT Packages at 45° Angle



5544AM



115 mm



5 5544 AM

SMD Tweezers for Positioning 5 mm Monolithic Chip Capacitors



5549AM



120 mm



5 5549 AM

Assembly Tweezers for Diagonal Inserting and Desoldering Circuit Board Levels with 6 mm Jaw



5573



145 mm



5 5573-145

SMD Tweezers for Positioning Flat Devices at 60° Angle



5545AM



120 mm



5 5545 AM

Electronics Tweezers for Holding Smallest Components



5488AM



115 mm



5 5488 AM

Assembly Tweezers for Inserting and Desoldering Horizontal Components with 4 mm Jaw



5578



122 mm



5 5578-115



Assembly Tweezers for Inserting and Desoldering Horizontal Components



5579



115 mm



5 5579-115

SMD Tweezers for Positioning 5 mm Monolithic Chip at 60° Angle



5588AM



120 mm



5 5588 AM

SMD Tweezers with Grooved Tips and 30° Bent Angle



5589AM



120 mm



5 5589 AM

SMD Tweezers for Vertical Positioning of Cylindrical Devices Ø1 mm or More



5590AM



120 mm



5 5590 AM

Stainless Steel SMD Tweezers Set - 5 Pcs



5568/5



100 g



1 5568/5

5489 AM

5583 AM

5589 AM

5584 AM

5546 AM

Watchmaker's Straight Tweezers with Polished Finish 120 mm



5463



120 mm

120 mm



5 5463-120

5 5463 R

Jeweller's Tweezers with Polished and Nickel Plated/PVC Coated Finish



5470



120 mm

160 mm



5 5470-120

5 5470 I-160

Heat Absorbing Tweezers for Soldering on Semiconductors



5577



145 mm



5 5577-145

Watchmaker's Straight Tweezers with Polished Finish 110 mm



5464



110 mm



5 5464-105

Watchmaker's Straight Tweezers with Polished Finish 105 mm



5465



105 mm



5 5465 R

Cutting Tweezers for Copper Wires



5493



115 mm



5 5493-115

Soldering Tweezers with Vulcanised Fibre Hand Protection



5476H

160 mm	5	5476 H

Heavy-Duty Soldering Irons with Euro Plug and Soldering Stand 30 W/40 W/80 W



322500

30 W	370 °C	1	322500300
40 W	375 °C	1	322500500
80 W	380 °C	1	322500800

Heavy-Duty Soldering Irons with Euro Plug and Soldering Stand 50 W/80 W



329600

50 W	400 °C	1	329600500
80 W	410 °C	1	329600800

Desoldering Tweezers for Removing Firmly Seated Round/Cubic Components



5574

145 mm	5	5574-145

Electronic Soldering Irons with Euro Plug and Earth Connection 18 W/25 W



32600

18 W	390 °C	1	326000200
25 W	420 °C	1	326000300

Spare Tips for Heavy-Duty Soldering Iron with Straight and Angled Version



3225

1.5 x 2.5 mm	1	322510300
1.5 x 2.5 mm	1	322510400
2 x 3 mm	1	322510500
2 x 3 mm	1	322510600
2.5 x 5 mm	1	322510700
2.5 x 5 mm	1	322510800

SOLDERING TOOLS

Instant Heat Double Insulated Soldering Guns



3250

100 W	400 °C	1	325001000
		1	3250010SH

3250010SH: Spare tip

Temperature Controlled Soldering Irons with Euro Plug and Soldering Stand



3270

50 W	200-500 °C	1	327020500

Electronic Soldering Irons with Euro Plug and Earth Connection 30 W/40 W



329500

30 W	380 °C	1	329500300
40 W	420 °C	1	329500400

Spare Tips for Electronic Soldering Guns



326010

5 g	1	326010200
5 g	1	326020200
5 g	1	326030200



Spare Tips for 3270 Temperature Controlled Soldering Irons



327020500-SH

Tip Size	Quantity	Part Number
0,5mm	1	327020500-SH1
2mm	1	327020500-SH2
3mm	1	327020500-SH3
4mm	1	327020500-SH4

Lead-Free Solders 0.8 mm



3290

Length	Quantity	Part Number
2000 mm	1	329000330
4000 mm	1	329000500

Hook Set 105 mm - 6 Pcs



5419/6T

Dimensions	Quantity	Part Number
5 x 78 x 110 mm	1	5419/6T

Spare Tips for Electronic Soldering Irons with Chisel and Pencil shaped Versions



3295

Weight	Quantity	Part Number
5 g	1	329500350
5 g	1	329500450

Miniature Awls/Hooks/Picks Tool Set 150 mm-250 mm



2633/

Dimensions	Quantity	Part Number
17 x 80 x 150 mm	12	2633/S4
12 x 12 x 275 mm	12	2633L/S4

ERGO™ O-Ring Levers for Desoldering



BE-3529

Length	Quantity	Part Number
197 mm	5	BE-3529

Spare Tips for Heavy-Duty Soldering Irons



3296

Weight	Quantity	Part Number
10 g	1	329600100
10 g	1	329600200

Double End Wires and Spring Hooks with Knurled Hexagon Handle



5418

Length	Quantity	Part Number
145 mm	1	5418

Adjusting Screwdrivers with Guide Sleeve and Plastic Handle



5550

Length	Quantity	Part Number
140 mm	10	5550-3.2
140 mm	10	5550-4.5

Tuning and Trimming Tools



5551-5554

L		
220 mm	1	5551
205 mm	1	5552
195 mm	1	5553
180 mm	1	5554

Tuning and Trimming Tools Set



5600/4

g		
75 g	1	5600/4

5551, 5552, 5553, 5554

Lacquer Stripping Tweezers with Plastic Grips



2530-32/2530-40

L		
130 mm	5	2530-40

Carbon Scrapers with Plastic Handle



2487

L		
210 mm	12	2487

3-Square Scrapers with Nickel Plated Handle



3524

g		
24 g	1	3524
5 g	1	3524L-K

3-Square Machinist's Scrapers with Plastic Handle



3525HB

L		
168 mm	5	3525HB

Optical Magnifiers 90 mm x 30 mm



3046-OP

L		
105 mm	12	3046-OP





BAHCO



Measuring & Layout



MEASURING TAPES

Double-Sided Measuring Tapes with Rubber Grip



MTS

L	W	Q	Model
5 m	25 mm	6	MTS-5-25
5 m	25 mm	6	MTS-5-25-E
8 m	25 mm	6	MTS-8-25
8 m	25 mm	6	MTS-8-25-E

Short Measuring Tapes with Rubber Grip



MTB

L	W	Q	Model
3 m	16 mm	6	MTB-3-16
3 m	16 mm	6	MTB-3-16-M
3 m	16 mm	6	MTB-3-16-M-E
5 m	25 mm	6	MTB-5-25
5 m	25 mm	6	MTB-5-25-M
5 m	25 mm	6	MTB-5-25-M-E
8 m	25 mm	6	MTB-8-25
8 m	25 mm	6	MTB-8-25-M
8 m	25 mm	6	MTB-8-25-M-E

Short Measuring Tapes with Rubber Grip Class-I



MTB_C1

L	W	Q	Model
5 m	25 mm	6	MTB-5-25-C1

Short Measuring Tapes with Positive Locking Button



MTG

L	W	Q	Model
3 m	16 mm	12	MTG-3-16
3 m	16 mm	12	MTG-3-16-E
5 m	19 mm	12	MTG-5-19
5 m	19 mm	12	MTG-5-19-E
8 m	25 mm	4	MTG-8-25
8 m	25 mm	4	MTG-8-25-E

Short Measuring Tapes with ABS Grip Compact Class-I



MTC_C1

L	W	Q	Model
3 m	13 mm	6	MTC-3-13-C1
5 m	16 mm	6	MTC-5-16-C1

Short Measuring Tapes with ABS Grip Compact Class-II



MTC_C2

L	W	Q	Model
3 m	13 mm	6	MTC-3-13
5 m	16 mm	6	MTC-5-16

COMPACT 3 M x 13 mm METRIC MEASURING TAPE



MT-TS-3

L	W	Q	Model
3 m	13 mm	12	MT-TS-3

Short Measuring Tapes with Steel Blade



1162N

L	W	Q	Model
3 m	13 mm	1	1162N-1/2

Adhesive Steel Bench Measuring Tapes



BT

L	W	Q	Model
3 m	13 mm	12	BTR-3-13
6 m	13 mm	12	BTR-6-13
3 m	13 mm	12	BTL-3-13
6 m	13 mm	12	BTL-6-13

Long Measuring Tapes with Steel Blade



LTG

L	Blade Width	Quantity	Model
10 m	10 mm	6	LTG-10
20 m	10 mm	6	LTG-20
30 m	10 mm	6	LTG-30

Long Measuring Tapes with Nylon Coated Blade and Open Case



LTS

L	Blade Width	Quantity	Model
30 m	13 mm	5	LTS-30
30 m	13 mm	5	LTS-30-E
50 m	13 mm	5	LTS-50
50 m	13 mm	5	LTS-50-E
100 m	13 mm	5	LTS-100
100 m	13 mm	5	LTS-100-E

Long Measuring Tapes with Nylon Coated Blade



LTB

L	Blade Width	Quantity	Model
10 m	13 mm	6	LTB-10
20 m	13 mm	6	LTB-20
30 m	13 mm	6	LTB-30

Long Measuring Tapes with Steel Blade and Open Case



LT-STEEL

L	Blade Width	Quantity	Model
30 m	13 mm	5	LT-STEEL-30
50 m	13 mm	5	LT-STEEL-50

MEASURING WHEELS

Metric Rubber Coated Measuring Wheels 150 mm



MW-150

L	Quantity	Model
150 mm	2	MW-150

Metric Rubber Coated Measuring Wheels 250 mm



MW-250

L	Quantity	Model
940 mm	2	MW-250

SPIRIT LEVELS

Thick Shaped Aluminium Profile Spirit Levels



466

L	Quantity	Model
400 mm	4	466-400
400 mm	4	466-400-M
600 mm	4	466-600
600 mm	4	466-600-M
800 mm	4	466-800
800 mm	4	466-800-M
1000 mm	4	466-1000
1000 mm	4	466-1000-M
1200 mm	4	466-1200
1200 mm	4	466-1200-M
1800 mm	4	466-1800
2000 mm	4	466-2000

Rectangular Aluminium Profile Spirit Levels



426

L	Blade Width	Quantity	Model
400 mm	49x22 mm	1	426-400
600 mm	49x22 mm	1	426-600
800 mm	49x22 mm	1	426-800
1000 mm	49x22 mm	1	426-1000
1200 mm	49x22 mm	1	426-1200

400 mm and 600 mm with 2 vials. 600 mm to 1200 mm with 3 vials 400 mm and 600 mm with 2 vials. 600 mm to 1200 mm with 3 vials



Light Aluminium Spirit Levels



416

Length (mm)	Quantity	Product Code
400 mm	10	416-400
600 mm	10	416-600
800 mm	10	416-800
1000 mm	10	416-1000
1200 mm	10	416-1200
1500 mm	10	416-1500
1800 mm	10	416-1800
2000 mm	10	416-2000

Lightweight Level made from solid injected aluminium



405L_

Length (mm)	Quantity	Product Code
400 mm	10	405L-400
600 mm	10	405L-600

Solid Injected Aluminium Magnetic Spirit Levels



406_M

Length (mm)	Quantity	Product Code
300 mm	1	5 406-300-M
400 mm	1	5 406-400-M
500 mm	1	5 406-500-M
600 mm	1	5 406-600-M

Level made from solid injected aluminium



405_

Length (mm)	Quantity	Product Code
400 mm	5	405-400
600 mm	5	405-600
800 mm	10	405-800
1000 mm	5	405-1000

Lightweight Magnetic Level made from solid injected aluminium



405L_M

Length (mm)	Quantity	Product Code
400 mm	5	405L-400-M
600 mm	5	405L-600-M

Polystyrene Spirit Levels



406P

Length (mm)	Quantity	Product Code
400 mm	10	406P-400
600 mm	10	406P-600

Magnetic Level, Solid Injected Aluminium



405_M

Length (mm)	Quantity	Product Code
400 mm	5	405-400-M
600 mm	5	405-600-M
800 mm	5	405-800-M
1000 mm	5	405-1000-M

Solid Injected Aluminium Spirit Levels



406

Length (mm)	Quantity	Product Code
300 mm	1	406-300
400 mm	5	406-400
500 mm	5	406-500
600 mm	5	406-600
800 mm	5	406-800

Spirit Level Set 600/1200/1800 mm - 3 Pcs/Carry Bag



416-SET+BAG

Quantity	Product Code
3	1 416-SET+BAG

416-SET-1

4750-LV-1

Spirit Level Set 600/1200/1800 mm - 3 Pcs



416-SET-1



3

5 416-SET-1

416-600, 416-1200, 416-1800



Spirit Level Set 600/1200/2000 mm - 3 Pcs



416-SET-2



3

5 416-SET-2

416-600, 416-1200, 416-2000



Magnetic Plastic Spirit Torpedo Levels



406T-225



228 mm

10 406T-225

DISP is a counter display with 12 units

Aluminium Spirit Torpedo Levels



426TOR9



230 mm

10 426TOR9

Aluminium Spirit Scaffold Levels



466-250



250 mm

10 466-250

Aluminium Spirit Line Levels 75 mm



466-LINE



75 mm

12 466-LINE

Flat Surface 2-Way Spirit Levels



466-BE1



20 g

12 466-BE1

Magnetic Spirit Levels for Fence Post



466-POST



120 x 75 x 80 mm

6 466-POST

Aluminium Straight Edge Spirit Levels



486



1800 mm

5 486-1800

2000 mm

5 486-2000

2400 mm

5 486-2400

Aluminium Straight Edge Spirit Levels Unhandled



486-xxxWH



1800 mm

5 486-1800WH

2000 mm

5 486-2000WH

2400 mm

5 486-2400WH

Double T-Profile Spirit Precision Levels



496



1500 mm

5 496-1500

1800 mm

5 496-1800



Spare Vial for 496 Levels



496-SPARE

496-1500, 496-1800	1	496-SPARE

MARKING

Chalk Lines 5x Rewind



CL-1441

185 mm	36	CL-1441

Chalk Lines 1x Rewind



CL-1331

185 mm	48	CL-1331

Chalk Lines 3x Rewind



CL-1221

130 mm	6	CL-1221

Marking Chalk 227 g/Pour Bottle



CHALK

227 g	6	CHALK-BLUE
227 g	6	CHALK-WHITE
227 g	6	CHALK-RED
227 g	6	CHALK-YELLOW

Chalk Line Set 3x Rewind - 3 Pcs



CL-1221-SET

180 g	4	CL-1221-SET

CHALK-BLUE

466-LINE

CL-1221

Plumb Bobs with 5 m Cord



PBS

5 m	6	PBS-700

Plumb Bobs with Hardened Steel Tip



PBB

185 mm	227 g	8	PBB-8

HB Grade Pencils - 25 Pcs/Box



P-HB

175 mm	25	25	P-HB

FSC Certificate Code: QMI-COC-001417 File No.: 1627439

HB Grade Pencils - 200 Pcs/Display



PENCIL-200

180 mm	200	1	PENCIL-200-DISP

HB Grade Pencils



P-MEC

150 mm	1	24	P-MEC
100 mm	5	12	P-MEC-LEAD

Scribers with Interchangeable Carbide Point



1179-SCRIBE

150 mm	5	1179-SCRIBE	
	1	1179-TIPS	

Tungsten Carbide Scribers



1178-SCRIBE

150 mm	5	1178-SCRIBE	

High Performance Alloy Steel Offset Scribers



1177-SCRIBE

230 mm	5	1177-SCRIBE	

RULES

5-Section Wooden Folding Rules 1 m



WR1

1 m	17 mm	50	WR1
1 m	17 mm	50	WR1-MM

10-Section Wooden Folding Rules 2 m



WR2

2 m	17 mm	25	WR2
2 m	17 mm	25	WR2-MM

Wooden Folding Rules with 12 Section 2 m



WR2-12

2 m	17 mm	25	WR2-12

Metric and Imperial Flexible Stainless Steel Rulers



1179-FLX

160 mm	12 mm	25	1179-FLX

Metric Stainless Steel Rulers



SR MM

150 mm	19 mm	12	SR150-MM
200 mm	19 mm	12	SR200-MM
300 mm	25 mm	12	SR300-MM
600 mm	30 mm	20	SR600-MM
1000 mm	35 mm	20	SR1000-MM



Imperial Stainless Steel Rulers



SR IN

Length	Width	Quantity	Model
6 in	6 in	12	SR150-E
8 in	8 in	12	SR200-E
12 in	12 in	12	SR300-E
24 in	24 in	20	SR600-E
39 in	40 in	20	SR1000-E

SQUARES

Carpenter Squares with Steel Blade



9045-B

Length	Width	Quantity	Model
220 mm	170 mm	6	9045-B-200
250 mm	170 mm	6	9045-B-250
300 mm	170 mm	6	9045-B-300
400 mm	170 mm	1	9045-B-400

Carpenter Squares with Stainless Steel Blade and Sliding Marker



9048

Length	Width	Quantity	Model
200 mm	165 mm	10	9048-200
250 mm	165 mm	10	9048-250
300 mm	180 mm	10	9048-300
350 mm	180 mm	10	9048-350
400 mm	180 mm	10	9048-400

Construction Squares for Layout and Setting Up



3085

Length	Width	Quantity	Model
400 mm	200 mm	1	308504000
500 mm	250 mm	1	308505000
600 mm	300 mm	1	308506000
800 mm	400 mm	1	308508000
1000 mm	500 mm	1	308510000

Sliding Combination Squares with Metal Scriber



CS

Length	Width	Quantity	Model
152 mm	90 mm	12	CS150
305 mm	125 mm	12	CS300
407 mm	125 mm	12	CS400

Spare parts, 4 pcs set.

Spare parts Kit for CS Model Sliding Squares - 4 Pcs



CS-SPARE

Quantity	Model
1	CS-SPARE

Sliding Bevel Squares with Cold-Rolled Steel Blade



9572

Length	Width	Quantity	Model
235 mm	115 mm	20	9572-200
250 mm	150 mm	20	9572-250

Bevel Squares with Steel Blade



9574

Length	Width	Quantity	Model
215 mm	165 mm	10	9574-200
285 mm	170 mm	10	9574-250
300 mm	170 mm	10	9574-300

Fixed Bevel Squares with Stainless Steel Blade



9575

Length	Width	Quantity	Model
250 mm	110 mm	6	9575-250

Flat Carpenter Squares with Steel Blade



FCS-600/FCS-1000

600 mm	300 mm	6	FCS-600
800 mm	300 mm	6	FCS-800
1000 mm	360 mm	6	FCS-1000

Mechanical Callipers



1150

150 mm	9 x 75 x 235 mm	1	1150-1/2H/P

Professional Feeler Gauges with 20 Blades



1547

20	100 mm	20	1547

0,05 mm steps Carbon steel

Adjustable Precision Squares



AS-1200

1265 mm	560 mm	3	AS-1200

Professional Feeler Gauges with 26 Blades

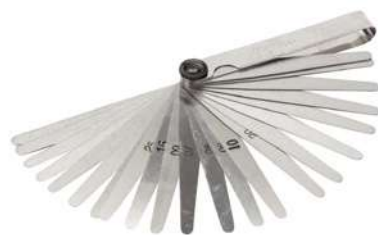

1544

26	100 mm	1	1544

0,03 mm to 0,1 mm in 0,01 mm increments / 0,10 mm to 1,0 mm in 0,05 mm increments Carbon steel

Screw Pitch Gauges with Metric 60°



1535

24	67 mm	1	1535

Stainless steel

PRECISION MEASURING

Precision Measuring Digital Callipers with LCD Screen



1150D

150 mm	25 x 90 x 245 mm	1	1150D

Professional Feeler Gauges with 13 Blades



1546

100 mm	1	1546

(0,05-0,30) x 0,05mm (0,30-1,00) x 0,10 mm Carbon steel

Screw Pitch Gauges with Metric 60° and Whitworth 55°



1537

0.25-6.0 / 4-62	70 mm	1	1537

0,25-6,00 mm, 4 to 62 TPI Stainless steel





BAHCO



Wall Tools



SCRAPERS

ERGO™ Precision Paint Scrapers with Dual-Component Handle



ergo



625



25 mm



5 625

ERGO™ Universal Paint Scrapers with Dual-Component Handle



ergo



650



50 mm



5 650

ERGO™ Heavy Duty Paint Scrapers with Dual-Component Handle



ergo



665



65 mm



5 665

Replacement Blades for 625 ERGO™ Scrapers



449



25 mm



10 449

Replacement Blades for 625 ERGO™ Scrapers



625-



3 g

3 g

3 g



10 625-DROP

10 625-PEAR

10 625-ROUND

Replacement Blades for 650 ERGO™ Scrapers



442



50 mm

50 mm



10 442-3P

10 442

442-3P: set of 3 blades of 442

Replacement Blades for 650 and 665 ERGO™ Scrapers



850 / 865



50 mm

65 mm



10 850-1

10 865-1

ERGO™ Paint Scrapers Set with Dual-Component Handle



ergo



SCRAPER-SET2



50 x 145 x 265 mm



1 SCRAPER-SET2

625

625-DROP, 625-PEAR, 625-ROUND

650



BAHCO

Cabinet Scrapers with Plastic Edge Protector



474

L		Icons	
130 mm	10	474-125-0.60	
130 mm	10	474-125-0.80	
150 mm	10	474-150-0.60	
150 mm	10	474-150-0.80	

Paint Scrapers with Carbon Steel Blade and Wooden Handle



2155

Blade Width	Length	Quantity	Product Code
30 mm	195 mm	12	215500300
40 mm	195 mm	12	215500400
50 mm	195 mm	12	215500500
60 mm	215 mm	12	215500600
70 mm	220 mm	12	215500700
80 mm	225 mm	12	215500800
90 mm	230 mm	12	215500900
100 mm	234 mm	12	215501000

Paint Scrapers with Carbon Steel Blade and Plastic Handle



216

Blade Width	Length	Quantity	Product Code
30 mm	215 mm	12	216000300
40 mm	215 mm	12	216000400
50 mm	215 mm	12	216000500
60 mm	215 mm	12	216000600
70 mm	215 mm	12	216000700
80 mm	215 mm	12	216000800
90 mm	215 mm	12	216000900
100 mm	215 mm	12	216001000
120 mm	215 mm	12	216001200

Paint Scrapers with Carbon Steel Blade and Dual-Component Handle



2150

Blade Width	Length	Quantity	Product Code
30 mm	225 mm	12	215000030
40 mm	225 mm	12	215000040
50 mm	225 mm	12	215000050
60 mm	225 mm	12	215000060
70 mm	225 mm	12	215000070
80 mm	225 mm	12	215000080
90 mm	220 mm	12	215000090
100 mm	220 mm	12	215000100
120 mm	220 mm	12	215000120

Paint Scrapers with Stainless Steel Blade and Dual-Component Handle



2161

Blade Width	Length	Quantity	Product Code
40 mm	215 mm	12	216100040
60 mm	215 mm	12	216100060
80 mm	215 mm	12	216100080
100 mm	215 mm	12	216100100
120 mm	215 mm	12	216100120

Paint Scrapers with Rigid Blade and Plastic Handle



2165

Blade Width	Length	Quantity	Product Code
30 mm	180 mm	12	216500300
50 mm	180 mm	12	216500500
75 mm	200 mm	12	216500750
100 mm	200 mm	12	216501000

Filling Scrapers with Carbon Steel Blade and Wooden Handle



2190

Blade Width	Length	Quantity	Product Code
100 mm	235 mm	5	219001000
120 mm	230 mm	5	219001200
140 mm	245 mm	5	219001400
160 mm	235 mm	5	219001600
200 mm	245 mm	5	219002000

Filling Scrapers with Stainless Steel Blade and Wooden Handle



2192

Blade Width	Length	Quantity	Product Code
100 mm	235 mm	5	219201000
120 mm	230 mm	5	219201200
140 mm	235 mm	5	219201400
160 mm	245 mm	5	219201600
200 mm	235 mm	5	219202000

Filling Scrapers with Reinforced Stainless Steel Blade and Wooden Handle



2193

Blade Width	Quantity	Product Code
250 mm	10	219302500
300 mm	10	219303000
350 mm	10	219303500



Glue Comb Scrapers with Triangular Teeth



2212

Width	Length (L)	Quantity	Product Code
130 mm	120 mm	5	221201200
130 mm	200 mm	5	221202000
130 mm	300 mm	5	221203000

Putty Knives with Stainless Steel Blade and Dual-Component Handle



2489

Quantity	Product Code
12	2489

Sevilla Model Masonry Trowels with Wooden Handle



2304

Width	Length	Quantity	Product Code
115 mm	200 mm	6	2304C0000

Glue Comb Scrapers with Square Teeth



2213

Width	Length (L)	Quantity	Product Code
130 mm	120 mm	5	221301200
130 mm	200 mm	5	221302000
130 mm	300 mm	5	221303000

Catalan Model Masonry Trowels with Wooden Handle



2301

Width	Length	Quantity	Product Code
175 mm	125 mm	6	2301C0000

Masonry Trowels with Sharp Tipped Blade and Wooden Handle



2308

Width	Length	Quantity	Product Code
120 mm	70 mm	6	2308A0000
150 mm	100 mm	6	2308B0000

Hook Knives with Stainless Steel Blade and Dual-Component Handle



2488

Quantity	Product Code
12	2488

Madrid Model Masonry Trowels with Wooden Handle



2303

Width	Length	Quantity	Product Code
70 mm	110 mm	6	2303B0000
80 mm	135 mm	6	2303D0000

Plastering Trowels with Carbon Steel Blade and Wooden Handle



204

Width	Length	Quantity	Product Code
300 mm	150 mm	12	204030150
300 mm	160 mm	12	204030160
300 mm	180 mm	12	204030180
500 mm	130 mm	6	204050130

Plastering Trowels with Triangle Serrated Teeth Carbon Steel Blade and Wooden Handle



209



270 mm 115 mm 12 209027040

Plastering Trowels with Stainless Steel Blade and Light Poplar Wooden Handle



2045A



140 mm 300 mm 12 2045A3000

Notched Base Plastering Trowels with Polystyrene Handle



213



265 mm 140 mm 5 213026140

Plastering Trowels with Square Serrated Teeth Carbon Steel Blade and Wooden Handle



2092



275 mm 115 mm 12 209227060
280 mm 130 mm 12 209228100
500 mm 130 mm 6 209250100

Plastering Trowels with Plastic Blade and Polystyrene Handle



211



350 mm 180 mm 5 211035180
420 mm 210 mm 5 211042210

Aluminium Plastering Scribes with Long Handle



2127



90 mm 435 mm 6 212704350

Plastering Trowels with Stainless Steel Blade and Long Poplar Wooden Handle



2045



300 mm 140 mm 12 204530140
500 mm 130 mm 6 204550130

Plastering Trowels with Notched Base and Polystyrene Handle



2120



270 mm 180 mm 5 212027180
330 mm 220 mm 8 212033220

Flat and Serrated Plasterer's Rails with Wooden Handle



2145xxxD



45 x 20 x 275 mm 1 2145020D0
45 x 25 x 275 mm 1 2145025D0
45 x 30 x 275 mm 1 2145030D0
45 x 35 x 275 mm 1 2145035D0



Flat Plasterer's Rails with Wooden Handle



2145xxxL

45 x 20 x 275 mm	1	2145020L0
45 x 25 x 275 mm	1	2145025L0
45 x 30 x 275 mm	1	2145030L0
45 x 35 x 275 mm	1	2145035L0

Curved Plasterer's Rails with Wooden Handle



2145xxxC

45 x 25 x 225 mm	1	2145025C0
45 x 35 x 210 mm	1	2145039C0

Joints Plastering Trowels with Anti-Shock Polystyrene Handle



2122

250 mm	100 mm	10 212202500

Sponge Base Plastering Trowels with Anti-Shock Polystyrene Handle and Hanging Clip



2123

140 mm	280 mm	10 212302900

Hard Rubber Grout Float Plastering Trowels with Anti-Shock Polystyrene Handle



2125

220 mm	135 mm	10 212502150

Soft Rubber Grout Float Plastering Trowels with Anti-Shock Polystyrene Handle



2126

140 mm	220 mm	10 212602150
140 mm	280 mm	1 212602800

DRYWALL TOOLS

Plaster Board Lifters



2504

300 x 750 x 1400 mm	1 250400000

Lift Spare Set with 2 Springs and Brakes



250400010

80 g	1 250400010

Board Filter Cable



250400020

180 g	1 250400020

Board Filter Parts Set



250400030



80 g



1 250400030

Setting Tools for Metal Anchors



250501800



185 mm



50 250501800

Setting Tools for Metal Anchors with Sprung Handle



250502450



245 mm



1 250502450

Trim Cutters with Variable Angle



8640



230 mm



50 864002450

Spare Blades for 8640 Trim Cutter



864000010



20 g



1 864000010

Spare Mitres for 864 Trim Cutter



864000020



20 g



1 864000020

Adjustable Trim Cutters



8641



245 mm



1 864102400

Spare Blades for 8641 Trim Cutter



864100010



5 g



1 864100010

Punching Tools for Dry Lining Walls



671002600



260 mm



50 671002600

Punching Tools with Articulated Head for Dry Lining Walls



671002850



295 mm



1 671002850





BAHCO



Hand Hacksaws



HAND HACKSAW FRAMES

ERGO™ Professional Hand Hacksaw Frames 300 mm



ergo



325

300 mm	5	325

Professional Hand Hacksaw Frames with Aluminium Handle 300 mm



225-PLUS

300 mm	5	225-PLUS

Professional Hand Hacksaw Frames with Soft Grip Handle 300 mm



319

300 mm	5	319

Hand Hacksaw Frames 432 mm



317

432 mm	10	317

Compact Hand Hacksaw Frames 470 mm



306

440 mm	10	306

Traditional Hand Hacksaw Frames 504 mm



320

504 mm	10	320

Traditional Hand Hacksaw Frames 517 mm



304

517 mm	10	304

Mini Hacksaws with Sandflex® Bi-Metal Blade



208

330 mm	5	208

Compass Saws 8 Blade Positions



321

330 g	5	321

Compass Saws 4 Blade Positions



210

360 g	10	210

Junior Hacksaws with Steel Frame and Fibreglass Handle 150 mm



268

150 mm	5	268

Junior Hacksaws with Steel Wire Frame and Handle 290 mm



239

260 mm	150	239

Junior High-Arch Hacksaws with Steel Profile Frame and Wooden Handle 150 mm



238

150 mm	60	238

Junior Hacksaws with Steel Profile Frame and Wooden Handle 150 mm



228

150 mm	80	228
150 mm	5	228-BULK

Junior Hacksaws with Steel Wire Frame and Wooden Handle 291 mm



219

291 mm	120	219

Junior Hacksaws with Steel Wire Frame and Handle 235 mm



218

235 mm	10	218
235 mm	150	218-BULK

HAND HACKSAW BLADES

Sandflex® Bi-Metal Spiro Hand Hacksaw Blades



3806-SPIRO

600 mm	32	10 3806-600-32

Sandflex® Bi-Metal Hand Hacksaw Blades



3906

250 mm	18	100 3906-250-18-100
250 mm	24	100 3906-250-24-100
250 mm	32	100 3906-250-32-100
300 mm	14	100 3906-300-14-100
300 mm	18	100 3906-300-18-100
300 mm	24	100 3906-300-24-100
300 mm	32	100 3906-300-32-100
300 mm	18-28	100 3818-300-PROG-100
300 mm	14	10 3906-300-14-10P
300 mm	18	10 3906-300-18-10P
300 mm	24	10 3906-300-24-10P
300 mm	32	10 3906-300-32-10P
250 mm	18	10 3906-250-18-5P
250 mm	24	10 3906-250-24-5P
250 mm	32	10 3906-250-32-5P
300 mm	14	10 3906-300-14-5P
300 mm	18	10 3906-300-18-5P
300 mm	24	10 3906-300-24-5P
300 mm	32	10 3906-300-32-5P
300 mm	18-28	10 3818-300-PROG-5P
300 mm	18/24/32	10 3906-300-3P
300 mm	18	10 3906-300-18-2P
300 mm	24	10 3906-300-24-2P
300 mm	32	10 3906-300-32-2P



Sandcut® High Speed Steel Hand Hacksaw Blades



3905

L	Teeth	Quantity	Part Number
250 mm	24	100	3905-250-24-100
300 mm	14	100	3905-300-14-100
300 mm	18	100	3905-300-18-100
300 mm	24	100	3905-300-24-100
300 mm	32	100	3905-300-32-100
300 mm	24	10	3905-300-24-2P

Junior Hacksaw Spare Blades



228-P

L	Teeth	Quantity	Part Number
150 mm	15	10	228-15-5P
150 mm	32	10	228-32-5P
150 mm	32	10	228-32-10P
150 mm	32	1	228-32-100P

Tungsten Carbide Grit Hand Hacksaw Blade



3816

L	Teeth	Quantity	Part Number
300 mm	12	50	3816-300

Junior Hacksaw Rod Blades 150-300 mm



216-R

L	Teeth	Quantity	Part Number
150 mm	20	1	216-150-R
300 mm	20	1	216-300-R

Junior Hacksaw Rod Blades 150 mm



215

L	Teeth	Quantity	Part Number
150 mm	110	1	215-150

Sandflex® Interchangeable Compass Hand Hacksaw Blades



321-SB

L	Teeth	Quantity	Part Number
310 mm	7	10	321-7-SB
310 mm	18	10	321-18-SB
310 mm	24	10	321-24-SB



Handsaws



HANDSAWS FOR CONSTRUCTION MATERIAL

ProfCut™ Toolbox General Purpose Handsaws



PC-GNP

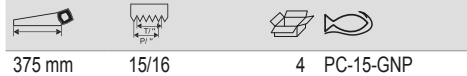

375 mm 15/16 4 PC-15-GNP



PrizeCut™ Compass Saws for Wood/Plastic



NP-COM

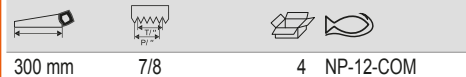

300 mm 7/8 4 NP-12-COM



ProfCut™ Handsaws for Plaster/Boards of Wood Based Materials



PC-PLS



600 mm 7/8 4 PC-24-PLS



Superior™ General Purpose Sawblades, Used with ERGO™ EX Handles



EX-16-GNP-C

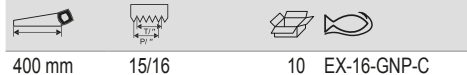

400 mm 15/16 10 EX-16-GNP-C



ProfCut™ Compass Saws for Wood/Plastic



PC-COM



300 mm 9/10 4 PC-12-COM



Superior™ Sawblades for Plaster and Boards, Used with ERGO™ EX Handles



EX-22-PLS-C



550 mm 7/8 10 EX-22-PLS-C



Superior™ Compass Saws for Wood/Plastic



3150

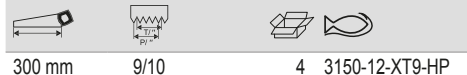

300 mm 9/10 4 3150-12-XT9-HP



Compass Saws for Plaster/Drywall/Boards of Wood Based Materials



PC-6-DRY



160 mm 8 6 PC-6-DRY



ProfCut™ Handsaws for Hard Plastic Tubes/Profiles



PC-22-PLC



550 mm 11/12 4 PC-22-PLC



ProfCut™ Handsaws for Polystyrene/
Stucco Profiles/Foams



PC-DECO

400 mm	18/19	4	PC-16-DECO



ProfCut™ Handsaws for Lightweight
Concrete/Leca®/Bricks



256

650 mm	2	4	256-26



General Purpose Handsaws for Plastics/
Laminates/Wood/Soft Metals



300

350 mm	15/16	4	300-14-F15/16-HP



ProfCut™ Handsaws for Lightweight
Concrete/Leca®/Bricks 1.3 TPI



255-34

620 mm	1,3	2	255-34



Insulation Saws for Mineral Wool/Stone
Wool/Eco Wool/Styrex®



PC-22-INS

550 mm	WT	4	PC-22-INS



General Purpose Spare Sawblades



369

360 mm	13/14	20	369-BLADE



ProfCut™ Handsaws for Lightweight
Concrete/Leca®/Bricks 0.6 TPI



255-17/34

620 mm	0.6	2	255-17/34



Folding Saw Specifically for Cutting
Insulation Wool Material



396-INS

190 mm	WT	10	396-INS



PrizeCut™ Universal Handsaws for
Plastics/Laminates/Wood/Soft Metals



NP

400 mm	7/8	4	NP-16-U7/8-HP
475 mm	7/8	10	NP-19-U7/8-HP
550 mm	7/8	10	NP-22-U7/8-HP



HANDSAWS FOR WOOD



PrizeCut™ Sawblades for Fine to Medium Thick Materials, Used with ERGO™ EX Handles



EX-NPP-22



550 mm	7/8	10	EX-NPP-22

PrizeCut™ Sawblades for All Types of Wood, Used with ERGO™ EX Handles



EX-22-U7



550 mm	7/8	10	EX-22-U7

ERGO™ Superior™ Toolbox Saws for Plaster/Boards of Wood Based Materials



2600-16



400 mm	11/12	4	2600-16-XT11-HP

Superior™ Sawblades for Medium to Thick Material, Used with ERGO™ EX Handles



EX-XT9



475 mm	9/10	10	EX-19-XT9-C
550 mm	9/10	10	EX-22-XT9-C

ProfCut™ Hardpoint Handsaws for Plaster/Boards of Wood Based Materials



PC-GT7



475 mm	7/8	4	PC-19-GT7
550 mm	7/8	4	PC-22-GT7

ERGO™ Superior Tenon Saws for Plastics/Laminates/Wood/Soft Metals



3180



350 mm	11/12	4	3180-14-XT11-HP

PrizeCut™ Crosscut Handsaws for Coarse/Medium Thick Wood Materials



NP-FLEEM



550 mm	7	10	NP-22-F7/8-HP

Fileable Universal Handsaws for Plastics/Laminates/Wood/Soft Metals



PC-FILE



400 mm	7/8	4	PC-16-FILE-U7
475 mm	7/8	4	PC-19-FILE-U7
550 mm	7/8	4	PC-22-FILE-U7
600 mm	7/8	4	PC-24-FILE-U7

ERGO™ Superior™ Veneer Handsaws for Plywood and Plastic



3240



350 mm	11/12	4	3240-14-XT11-HP

ERGO™ Superior™ Saws for Plaster/
Boards of Wood Based Materials



2600

475 mm	9/10	4	2600-19-XT-HP
550 mm	9/10	4	2600-22-XT-HP

Superior™ Sawblades for Laminates and
Wooden Floors, Used with ERGO™ EX
Handles



EX-20-LAM-C

500 mm	11/12	10	EX-20-LAM-C

Superior™ Sawblades for Fine to Medium
Thick Materials, Used with ERGO™ EX
Handles



EX-20-XT11-C

500 mm	11/12	10	EX-20-XT11-C

ERGO™ Superior™ Saws for Plastics/
Laminates/Wood/Soft Metals



3090

500 mm	11/12	4	3090-20-XT11-HP

ProfCut™ Laminator Saws for Laminate/
Wooden Floors



PC-LAM

500 mm	11/12	4	PC-20-LAM

Superior™ Tenon Sawblades for Plastics,
Laminates, Wood and Soft Metals, Used
with ERGO™ EX Handles



EX-14-TEN-C

350 mm	11/12	10	EX-14-TEN-C

Handsaws for Plastics/Laminates/Wood/
Soft Metals



244

500 mm	7/8	10	244-20-U7/8-HP
550 mm	7/8	10	244-22-U7/8-HP

ERGO™ Superior™ Laminator Saws for
Laminate/Wooden Floors



SUP-LAM

500 mm	11/12	4	SUP-20-LAM

Superior™ Veneer Sawblades for
Plywood/Plastic, Used with ERGO™ EX
Handles



EX-14-VEN-C

350 mm	11/12	10	EX-14-VEN-C



ProfCut™ Hardpoint Handsaws for Hard Wood/Plywood/Thin Profile



PC-GT9

475 mm	9/10	4	PC-19-GT9
550 mm	9/10	4	PC-22-GT9

PrizeCut™ Hardpoint Sawblades for Fine/Medium Thick Material



PC-VEN

300 mm	11/12	4	PC-12-VEN

PrizeCut™ Veneer Saws for Fine/Medium Thick Material



NP-VEN

300 mm	13/14	10	NP-12-VEN

ProfCut™ Toolbox Handsaws for Fine to Medium Thick Materials



PC-TBX

375 mm	11/12	4	PC-15-TBX

ProfCut™ Sawblades for Fine/Medium Thick Material



PC-PRC

500 mm	9/10	4	PC-20-PRC

Superior™ Sawblades for Coarse/Thick Material, Used with ERGO™ EX Handles



EX-XT7

550 mm	7/8	10	EX-22-XT7-C
600 mm	7/8	10	EX-24-XT7-C

ProfCut™ Tenon Handsaws for Medium Thick Materials



PC-TEN

300 mm	11/12	4	PC-12-TEN

PrizeCut™ Tenon Saws for Fine/Medium Thick Material



NP-TEN

300 mm	13/14	10	NP-12-TEN

Barracuda Sawblades for Medium to Thick Materials, Used with ERGO™ EX Handles



EX-244P-22

550 mm	7/8	10	EX-244P-22

Handsaws with Dual-Component for Medium to Thick Wood



244P

500 mm	7/8	4	244P-20-U7-HP
550 mm	7/8	10	244P-22-U7-HP



Wooden Mitre Boxes with Optional Side Wall



233

65 x 135 x 300 mm	5 233-300
75 x 135 x 300 mm	5 233-300-A
65 x 135 x 400 mm	5 233-400



PRECISION HANDSAWS

ProfCut™ General Carpentry Pull-Saws for Wood and Plastic



PC-12-PS

305 mm	13.5	4	PC-12-14-PS
305 mm	13.5	10	PC-12-14-PS-B



ERGO™ Superior Handsaws for Timber/Wet/Tanalised Wood



2700

550 mm	7/8	4	2700-22-XT7-HP
600 mm	7/8	4	2700-24-XT7-HP



Laminated Wood Mitre Boxes



234-W

53 x 77 x 245 mm	10 234-W1
63 x 95 x 300 mm	10 234-W2
80 x 100 x 300 mm	10 234-W3



ProfCut™ Tenon Pull-Saws for Wood and Plastic



PC-11-PS

270 mm	18.5	4	PC-11-19-PS
270 mm	18.5	10	PC-11-19-PS-B



ProfCut™ Timber Saws for Timber/Wet/Tanalised Wood



PC-TIM

600 mm	3.5/4.5	4	PC-24-TIM



Aluminium Mitre Boxes



234-A

55 x 65 x 245 mm	1 234-A1
40 x 106 x 245 mm	1 234-A2



ProfCut™ Double Edge Pull-Saws for Wood and Plastic



PC-9-PS

240 mm	6-8.5 / 17	4	PC-9-9/17-PS
240 mm	6-8.5 / 17	10	PC-9-9/17-PS-B



ProfCut™ Dovetail Saws with Angled Swinging Wooden Handle



PC-DTF

250 mm	15/16	10	PC-10-DTF



ProfCut™ Dovetail Saws with Straight Wooden Handle



PC-DTR

250 mm	15/16	10	PC-10-DTR



ProfCut™ Dovetail Saws with Angled Wooden Handle



PC-DTL

250 mm	15/16	10	PC-10-DTL



HANDLES & SHARPENERS

ERGO™ BHS Handle for EX Sawblade Large



EX-

120 x 330 x 60 mm	4	EX-LL	
120 x 330 x 60 mm	4	EX-RM	
120 x 330 x 60 mm	4	EX-RL	



Fret Saws with Frame and Wooden Handle



502

130 mm	25	502



Fret Saw Sets, 2 pieces



502-SET2

2	130 g	35	502-SET2



Professional High Speed Steel Sharpeners



SHARP-INS

206 mm	100	SHARP-INS



FRET SAWS & SAWBLADES

Fret Saws with Wooden Handle



302

130 mm	30	302



Fret Saw Sets, 6 pieces



502-SET6

6	500 g	10	502-SET6

Assortment of Spare Blades for 302 and 502 Fret Saws



302-6X4P



130 mm



1 302-6X4P

Fret Saw Spare Blades for Wood and Plastic



302W



1	130 mm	1	302-51W-12P
3	130 mm	1	302-53W-12P
5	130 mm	1	302-55W-12P
7	130 mm	1	302-57W-12P
9	130 mm	1	302-59W-12P
11	130 mm	1	302-511W-12P

MUSICAL SAW

Musical Handsaws with Wooden Handle



296



750 mm



1 296

Fret Saw Spare Blades for Metal



302M



1	130 mm	1	302-71M-12P
3	130 mm	1	302-73M-12P
5	130 mm	1	302-75M-12P
7	130 mm	1	302-77M-12P

COPING SAWS & SAWBLADES

Coping Saws with Wooden Handle



301



165 mm



50 301

Fret Saw Spiral Spare Blades for Wood and Plastic



302S



1	130 mm	1	302-81S-12P
3	130 mm	1	302-83S-12P
5	130 mm	1	302-85S-12P

Coping Sawblades for 301 Saw

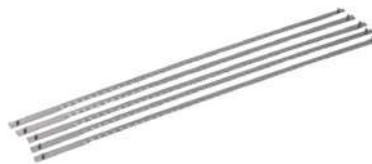

303



165 mm



10 303-5P





BAHCO



Wood Chisels



WOODWORKING CHISELS

ERGO™ Splitproof Woodworking Chisels



ergo



434

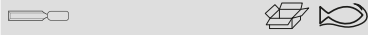

6 mm	4	434-6
8 mm	4	434-8
10 mm	4	434-10
12 mm	4	434-12
14 mm	4	434-14
15 mm	4	434-15
16 mm	4	434-16
18 mm	4	434-18
20 mm	4	434-20
22 mm	4	434-22
25 mm	4	434-25
28 mm	4	434-28
30 mm	4	434-30
32 mm	4	434-32
35 mm	4	434-35
38 mm	4	434-38
50 mm	4	434-50

Suitable for an intensive use with a metallic hammer

ERGO™ Splitproof Chisel Set - 3 Pcs/
Cardboard Box



ergo



434-S3-EUR

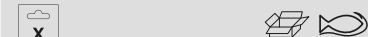

3 1 434-S3-EUR

Suitable for an intensive use with a metallic hammer

434-12, 434-18, 434-25

6 pcs ERGO™ Splitproof chisel set in
leather roll pouch.



ergo



434-S6-LR

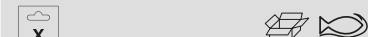

6 1 434-S6-LR

Suitable for an intensive use with a metallic hammer

434-6, 434-10, 434-12, 434-18, 434-25, 434-32

ERGO™ Splitproof Chisel Set - 6 Pcs/
Wooden Box



ergo



434-S6-EUR

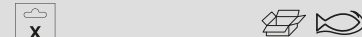

6 1 434-S6-EUR

Suitable for an intensive use with a metallic hammer

434-6, 434-10, 434-12, 434-18, 434-25, 434-32

ERGO™ Splitproof Chisel Set - 8 Pcs/
Wooden Box



ergo



434-S8-EUR



8 1 434-S8-EUR

Suitable for an intensive use with a metallic hammer

434-6, 434-10, 434-12, 434-16, 434-18, 434-25,
434-32, 434-38

ERGO™ Splitproof Chisel Set - 6 Pcs/
Polyester Pouch



ergo



434-S6-PP

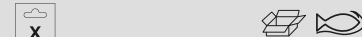

6 1 434-S6-PP

Suitable for an intensive use with a metallic hammer

434-6, 434-10, 434-12, 434-18, 434-25, 434-32

Woodworking Chisels with Rubberised
Handle



424P

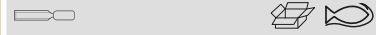

4 mm	4	424P-4
6 mm	4	424P-6
8 mm	4	424P-8
10 mm	4	424P-10
12 mm	4	424P-12
14 mm	4	424P-14
15 mm	4	424P-15
16 mm	4	424P-16
18 mm	4	424P-18
20 mm	4	424P-20
22 mm	4	424P-22
24 mm	4	424P-24
25 mm	4	424P-25
26 mm	4	424P-26
28 mm	4	424P-28
30 mm	4	424P-30
32 mm	4	424P-32
35 mm	4	424P-35
38 mm	4	424P-38
40 mm	4	424P-40

Chisel Set with Rubberised Handle - 3
Pcs/Cardboard Box



424P-S3-EUR



3 1 424P-S3-EUR

424P-12, 424P-18, 424P-25

Chisel Set with Rubberised Handle 6-32
mm - 6 Pcs/Leather Roll Pouch



424P-S6-LR

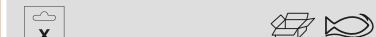

6 1 424P-S6-LR

424P-6, 424P-10, 424P-12, 424P-18, 424P-25, 424P-32

Chisel Set with Rubberised Handle - 6 Pcs/Wooden Box



424P-S6-EUR



6 1 424P-S6-EUR

424P-6, 424P-10, 424P-12, 424P-18, 424P-25, 424P-32



Chisel Set with Rubberised Handle - 6 Pcs/Wooden Box



424P-S6-GER



6 1 424P-S6-GER

424P-6, 424P-10, 424P-12, 424P-16, 424P-20, 424P-26



Chisel Set with Rubberised Handle - 8 Pcs/Wooden Box



424P-S8-EUR



8 1 424P-S8-EUR

424P-6, 424P-10, 424P-12, 424P-16, 424P-18, 424P-25, 424P-32, 424P-38



Chisel Set with Rubberised Handle - 6 Pcs/Polyester Pouch



424P-S6-PP



6 1 424P-S6-PP

424P-6, 424P-10, 424P-12, 424P-18, 424P-25, 424P-32



Woodworking Chisels with Orange Polypropylene Handle



414



6 mm	4	414-6
8 mm	4	414-8
10 mm	4	414-10
12 mm	4	414-12
14 mm	4	414-14
15 mm	4	414-15
16 mm	4	414-16
18 mm	4	414-18
20 mm	4	414-20
22 mm	4	414-22
25 mm	4	414-25
28 mm	4	414-28
30 mm	4	414-30
32 mm	4	414-32
35 mm	4	414-35
38 mm	4	414-38

10 mm	5 1031-10
12 mm	5 1031-12
14 mm	5 1031-14
16 mm	5 1031-16
18 mm	5 1031-18
20 mm	5 1031-20
22 mm	5 1031-22
25 mm	5 1031-25
28 mm	5 1031-28
30 mm	5 1031-30
32 mm	5 1031-32
40 mm	5 1031-40

Chisel Set with Polypropylene Handle - 3 Pcs/Cardboard Box



414-S3-EUR



3 1 414-S3-EUR

414-12, 414-18, 414-25



Chisel Set with Polypropylene Handle - 5 Pcs/Blister



9883



5 1 9883

1031-6, 1031-12, 1031-16, 1031-20, 1031-25



Woodworking Chisels with Wooden Handle



425

Width	Quantity	Part Number
4 mm	4	425-4
6 mm	4	425-6
8 mm	4	425-8
10 mm	4	425-10
12 mm	4	425-12
14 mm	4	425-14
15 mm	4	425-15
16 mm	4	425-16
18 mm	4	425-18
20 mm	4	425-20
22 mm	4	425-22
24 mm	4	425-24
25 mm	4	425-25
26 mm	4	425-26
28 mm	4	425-28
30 mm	4	425-30
32 mm	4	425-32
35 mm	4	425-35
38 mm	4	425-38
40 mm	4	425-40

Chisel Set with Wooden Handle - 5 Pcs/
Cardboard Box



425-082

Quantity	Part Number
5	425-082

425-6, 425-10, 425-12, 425-18, 425-25

Chisel Set with Wooden Handle - 6 Pcs/
Wooden Box



425-083

Quantity	Part Number
6	425-083

425-6, 425-10, 425-12, 425-18, 425-25, 425-32

3 pcs wooden-handle chisel set in
cardboard box



425-081

Quantity	Part Number
3	425-081

425-12, 425-18, 425-25

GOUGE CHISELS

Gouge Chisels with Rubberised Handle



422P

Width	Quantity	Part Number
6 mm	4	422P-6
10 mm	4	422P-10
12 mm	4	422P-12
16 mm	4	422P-16
20 mm	4	422P-20
25 mm	4	422P-25

DEMOLITION CHISELS

Heavy Duty Wrecking Knives with
Rubberised Handle



2448

Width	Length	Quantity	Part Number
25 mm	231 mm	12	2448
25 mm	240 mm	12	SB-2448

Spare Handles for 1031 Chisels



956

Length	Weight	Quantity	Part Number
108 mm	50 g	1	956

Heavy Duty Wrecking Knives with Curved
Blade and Rubberised Handle



2449

Width	Length	Quantity	Part Number
25 mm	240 mm	12	2449
25 mm	231 mm	10	SB-2449

WOOD CHISEL ACCESSORIES

Natural Grinding Stones



528-700



150 mm



1 528-700

Grinding Stones with Two Grains



528-COM



150 mm



1 528-COM

Grinding Plain



BP-40



160 mm



1 BP-40

Sharpening block



SBC110



30 x 65 x 110 mm



67 g



1 SBC110-65

Block Plane Spare Blade



BP-40-95



112 mm



55 g



12 BP-40-95

Protective Plastic Holsters



WC-HOL



292 mm



1 WC-HOL





BAHCO



Scissors & Knives



METAL SHEARS

Straight Cut Aviation Shears with Increased Power by Lever Action and Yellow Colour Coded Handle up to 1.5 mm



MA421



250 mm



10 MA421

Multipurpose Long Straight Cut Aviation/Compound Shears with Orange Handle



MA431



290 mm



1 MA431

8698M0250: Spare parts set

Right Cut Aviation Shears with Increased Power by Lever Action and Green Colour Coded Handle up to 1.5 mm



MA411



250 mm



10 MA411

8698M0250: Spare parts set

Right Cut Aviation Shears with Increased Power by Lever Action and Green Colour Coded Handle up to 1.8 mm



MA321



260 mm



10 MA321

8697M0260: Spare parts set

Left Cut Aviation Shears with Increased Power by Lever Action and Red Colour Coded Handle up to 1.5 mm



MA401



250 mm



10 MA401

8698M0250: Spare parts set

Left Cut Aviation Shears with Increased Power by Lever Action and Red Colour Coded Handle up to 1.8 mm



MA311



260 mm



1 MA311

8697M0260: Spare parts set

Straight Cut Aviation Shears with Increased Power by Lever Action



MA225



250 mm



4 MA225

Right Cut Aviation Shears with Increased Power by Lever Action



MA225R



250 mm



4 MA225R

Left Cut Aviation Shears with Increased Power by Lever Action



MA225L



250 mm



4 MA225L

Right Cut Pass-Through Shears with Increased Power by Lever Action and Green Colour Coded Handle



MA361



260 mm 10 MA361

8697M0260: Spare parts set

Long Straight Cut Pass-Through Metal Shears



MR340



340 mm 2 MR340

Right and Straight Cut Offset Pass-Through Metal Shears for Soft/Medium Materials



585D



280 mm 4 585D

Left Cut Pass-Through Shears with Increased Power by Lever Action and Red Colour Coded Handle



MA351



250 mm 10 MA351

8697M0260: Spare parts set

Right and Straight Cut Offset Pass-Through Metal Shears for Medium/Hard Materials



583D



280 mm 4 583D

Left and Straight Cut Offset Pass-Through Metal Shears for Soft/Medium Materials



586D



280 mm 4 586D

Straight Cut Pass-Through Metal Shears with Increased Power by Lever Action



MA325



250 mm 4 MA325

Left and Straight Cut Offset Pass-Through Metal Shears for Medium/Hard Materials



584D



280 mm 4 584D

Left and Straight Cut Traditional/Industrial Metal Shears with Two Thin Blades



M227L



270 mm 4 M227L



Right and Straight Cut Traditional/Industrial Metal Shears with Two Thin Blades



M227R



270 mm



4 M227R

Right Cut Madrid Traditional/Industrial Metal Shears



8691



255 mm
300 mm



6 869102500
6 869103000

Right and Straight Cut Traditional/Industrial Metal Shears with Two Thin Blades and Return Spring



MR227R



270 mm



4 MR227R

Long Straight Cut Pass-Through Traditional/Industrial Shears



M330



11 3/4 mm



4 M330

Catalonian Traditional/Industrial Metal Shears



8692



300 mm



6 869203000

Straight Cut Pass-Through Two Hand Compound Shears



M6376



760 mm



1 M6376
1 M6376-SH

Straight Cut Traditional/Industrial Metal Shears with Two Thick Blades



M526



260 mm



4 M526

Left and Straight Cut Traditional/Industrial Metal Shears with Two Thin Blades and Return Spring



MR227L



270 mm



4 MR227L

Straight Cut Two Hand Compound Shears



M676



760 mm



1 M676
1 M676-SH

Metal Shears Nibblers with Eye Protecting Screen



M926

250 mm	1 M926	1 M926-SH

Heavy Duty Electrician Scissors with Groove



SCB140G

43 mm	140 mm	10 SCB140G

Electrician Scissors with Longer Handle



SC150NG

38 mm	155 mm	10 SC150NG

Multipurpose Heavy Duty Universal Snips



2744

190 mm	6 2744	

Electrician Scissors with Optional Serrated Blade



SC127/SC127S

45 mm	130 mm	10 SC127
45 mm	127 mm	10 SC127S

Special Tin Snips with Curved Cutting Jaws



2704

110 mm	1 2704A	

SCISSORS

Heavy Duty Electrician Scissors



SCB140

90 mm	140 mm	10 SCB140

Electrician Scissors with Optional Curved Blade



SC140/SC140C

50 mm	145 mm	10 SC140
50 mm	145 mm	10 SC140C

Special Tin Forceps with Finely Serrated Jaws



2705R

160 mm	1 2705R	



KNIVES

ERGO™ Retractable Utility Knives



ergo



KERU-01



ERGO™ Fixed Utility Knives



ergo



KEFU-01

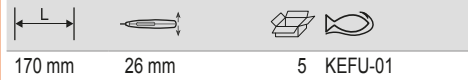

ERGO™ Snap Off Utility Knives with 18 mm Blades



ergo



KE18-01



Retractable Utility Knives with TPR Grip



KBRU-01

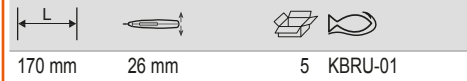

Retractable Utility Knives



KGRU-01

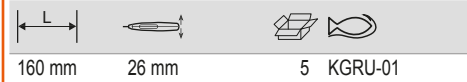

Retractable Twist Utility Knives



KGRU-02

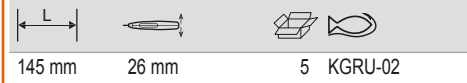

Mini Retractable Utility Knives



KMU-01



Squeeze Retractable Utility Knives with Rubber Grip



SQZ150003

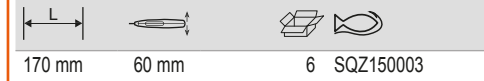

Fixed Utility Knives with TPR grip



KBFU-01



Fixed Utility Knives



KGFU-01



Trapezoidal Blades for Utility Knives - 100 Pcs



KBGU



0,635 x 19 x 60 mm



1 KBGU-100P

Hook Trapezoidal Blades for Utility Knives - 5 Pcs/Dispenser



KBGH-5P-DISPEN



0,635 x 19 x 51 mm



20 KBGH-5P-DISPEN

Trapezoidal Hook Blades for SQZ150003 Utility Knives



SQZ150003-HSBL



51 mm



6 SQZ150003-HSBL

Trapezoidal Blades for Utility Knives - 5 Pcs/Dispenser



KBGU-5P-DISPEN



0,635 x 19 x 60 mm



20 KBGU-5P-DISPEN

Safety Trapezoidal Blades for Utility Knives - 5 Pcs/Dispenser



KBGR-5P-DISPEN



0,635 x 19 x 55 mm



20 KBGR-5P-DISPEN

Snap Off Utility Knives with TPR Grip and 9 mm Blades



KB09-01



140 mm



5 KB09-01

Trapezoidal Blades for Utility Knives - 10 Pcs/Dispenser



KBGU-10P-DISPEN



0,635 x 19 x 60 mm



20 KBGU-10P-DISPEN

Trapezoidal Safety Blades for SQZ150003 Utility Knives



SQZ150003-SBL



60 mm



1 SQZ150003-SBL

Snap Off Utility Knives with TPR Grip and 18 mm Blades



KB18-01



160 mm



5 KB18-01



Snap Off Utility Knives with 9 mm Blades



KG09-01



140 mm
140 mm



5 KG09-01
10 KG09-01-3P

Blades for Utility Knives - 5 Pcs/Retail Pack



KUBG



0.7 x 85 x 9 mm
1 x 110 x 18 mm



20 KUBG09-5P
20 KUBG18-5P

Auto Retractable Safety Utility Knives



KGAU-01



160 mm



5 KGAU-01

Snap Off Utility Knives with 18 mm Blades



KG18-01



160 mm



5 KG18-01

Blades for Utility Knives 18 mm - 5 Pcs/Dispenser



KUBG18-5DISPEN



15 x 30 x 130 mm



20 KUBG18-5DISPEN

Holsters for Fixed Utility Knives



KHU-01



90 g



4 KHU-01

Snap Off Blades for Utility Knives 9 mm - 10 Pcs/Dispenser



KSBG09-10DISPEN



1 x 9 x 85 mm



20 KSBG09-10DISPEN

Snap Off Blades for Utility Knives 18 mm - 10 Pcs/Dispenser



KSBG18-10DISPEN



15 x 30 x 130 mm



20 KSBG18-10DISPEN

Mini Squeeze Retractable Utility Knives with Rubber Grip



SQZ-MINI



160 mm



24 SQZ-MINI

Trapezoidal Mini Squeeze Blades for SQZ-MINI Utility Knife



SQZ-MINI-BLADE



28 mm



1 SQZ-MINI-BLADE

Sports Foldable Utility Knives with Aluminium Handle



KBSU-01



5 KBSU-01

Tradesman Laplander Knives with Dual-Component Green Handle



2446-LAP



218 mm



102 mm



15 2446-LAP

Sports Foldable Utility Knives with Aluminium Handle and Twin Blades



KBTU-01



5 KBTU-01

Sports Foldable Utility Knives with Polyamide Handle



KGSU-01



5 KGSU-01

Multipurpose Tradesman Robust Knife Retail Pack



SB-2444



220 mm



100 mm



1 SB-2444

Sports Foldable Knives for Rope Cutting



KBSK-01



5 KBSK-01

Multipurpose Tradesman Knives with Dual-Component Handle - 15 Pcs/Counter Display



2444



15 2444

Multipurpose Tradesman Knives with Dual-Component Handle and Double Button Holster



2446



225 mm



100 mm



15 2446



Multipurpose Tradesman Stainless-Steel Knives with Dual-Component Handle -15 Pcs/Counter Display



2446-BL



218 mm 102 mm 15 2446-BL

Electrician Stripping Knives for Both Hands Use



2446-EL

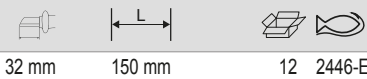

32 mm 150 mm 12 2446-EL

Tradesman Electrician's Stripping Knives for Right Hand Use



2446-ELR

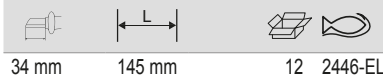

34 mm 145 mm 12 2446-ELR

Multipurpose Tradesman Knives with Dual-Component Handle and Safety Blunt Tip



2446-SAFE



215 mm 95 mm 15 2446-SAFE

Electrician Stripping Knives for Both Hands Use Retail Pack



SB2446-EL

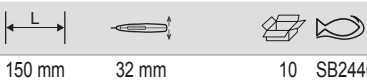

150 mm 32 mm 10 SB2446-EL

Multipurpose Tradesman Knives with Dual-Component Handle and Special Holster



2446-OV



220 mm 100 mm 15 2446-OV

Tradesman Knives for Lino Carpets - 12 Pcs/Counter Display



2446-LINO



180 mm 55 mm 12 2446-LINO

Tradesman Electrician's Stripping Knives for Left Hand Use



2446-ELL

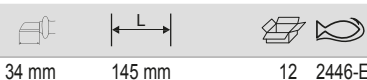

34 mm 145 mm 12 2446-ELL

Tradesman Electrician's Knives with Guide



2446-EL-HELP



43 mm 12 2446-EL-HELP

Multipurpose Tradesman Knives with 1-Component Handle - 15 Pcs/Counter Display



1446



220 mm 100 mm 15 1446

Bucket for 1446 Knives



BUCKET 1446

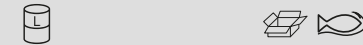

30 l 75 BUCKET 1446

Electricians Knives with 70 mm Serrated Blades



2820EK

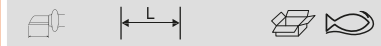

95 mm 205 mm 6 2820EK

Multipurpose Tradesman Carbon Steel Knives with Dual Component Handle - 15 Pcs/Counter Display



1446-CS

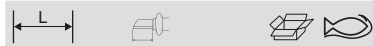

218 mm 102 mm 15 1446-CS

Multipurpose Tradesman Knives with 1-Component Handle and Special Holster



1446-OV



225 mm 100 mm 15 1446-OV

Electricians Folding Knives with 60 mm Blades



2820EF1



90 mm 200 mm 12 2820EF1

Rescue floating knife with fluorescent handle



1446-FLOAT



226 mm 102 mm 15 1446-FLOAT

Electricians Pinch Knives with Wooden Handle



2820EK-01

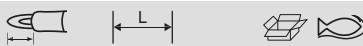

25 mm 130 mm 12 2820EK-01

Electricians Folding Knives with 65 mm Blades



2820EF2



85 mm 195 mm 8 2820EF2



Electricians Folding Knives with 70 mm Blades



2820EF3

80 mm	170 mm	1	2820EF3

18-in-1 Aluminium Mini Foldable Multitools



MTT121

110 mm	8	MTT121

Windows Scrapers with Dual-Component Plastic Body



KBWS-01

70 g	10	KBWS-01

Electricians Folding Knives with 70/85 mm Double Blades



2820EF4

75-85 mm	170 mm	1	2820EF4

12-in-1 Aluminium Foldable Multitools



MTT051

165 mm	6	MTT051

18-in-1 Aluminium Foldable Multitools



MTT151

150 mm	6	MTT151

Windows Scraper with Interchangeable Blade



KRSS-01

80 g	10	KRSS-01



Clamps & Vices



CLAMPS

Quick Clamps with 200 kg Force



QCB

L	QCB
456 mm	6 QCB-150
606 mm	6 QCB-300
756 mm	6 QCB-450
906 mm	4 QCB-600
1206 mm	4 QCB-900
1556 mm	8 QCB-1250

Quick Clamps with 125 kg Force



QCG

L	QCG
380 mm	6 QCG-150
530 mm	6 QCG-300

High Resistance Quick Clamps with 70 kg Maximum Force



QC

X	L	QC
1	230 mm	12 QC-115A
2	230 mm	6 QC-115A-2P
1	305 mm	6 QC-150A
2	305 mm	6 QC-150A-2P
1	475 mm	6 QC-300A
2	475 mm	4 QC-300A-2P

-2P: Twin Pack

F-Clamps with Steel T-Handle 90 mm



3066

L	T-Handle	3066
250 mm	90 mm	5 306601500
300 mm	90 mm	5 306602000
400 mm	90 mm	5 306603000
510 mm	90 mm	5 306604000

F-Clamps with Steel T-Handle 120 mm



3067

L	T-Handle	3067
415 mm	125 mm	5 306703000
510 mm	125 mm	5 306704000
610 mm	125 mm	5 306705000
710 mm	125 mm	5 306706000
910 mm	125 mm	5 306708000
1115 mm	125 mm	5 306710000
1310 mm	125 mm	2 306712000
1610 mm	125 mm	2 306715000

F-Clamps with Steel T-Handle 150 mm



3068

L	T-Handle	3068
430 mm	155 mm	5 306803000
535 mm	155 mm	5 306804000
640 mm	155 mm	2 306805000
730 mm	155 mm	2 306806000
820 mm	155 mm	2 306808000
1135 mm	155 mm	2 306810000
1335 mm	155 mm	2 306812000
1630 mm	155 mm	1 306815000
2130 mm	155 mm	1 306820000

F-Clamps with Steel T-Handle 220 mm



3069

L	T-Handle	3069
430 mm	225 mm	2 306903000
540 mm	225 mm	2 306904000
638 mm	225 mm	2 306905000
730 mm	225 mm	2 306906000
932 mm	225 mm	2 306908000
1130 mm	225 mm	2 306910000

F-Clamps with Rubberised Handle



420SH

L	T-Handle	420SH
100 mm	50 mm	10 420SH-50-100
200 mm	50 mm	10 420SH-50-200
120 mm	60 mm	12 420SH-60-120
300 mm	60 mm	12 420SH-60-300
160 mm	80 mm	12 420SH-80-160
200 mm	100 mm	10 420SH-100-200
250 mm	120 mm	8 420SH-120-250
300 mm	120 mm	8 420SH-120-300
400 mm	120 mm	6 420SH-120-400
500 mm	120 mm	6 420SH-120-500
600 mm	120 mm	6 420SH-120-600
800 mm	120 mm	6 420SH-120-800
1000 mm	120 mm	6 420SH-120-1000
1250 mm	120 mm	6 420SH-120-1250
1500 mm	120 mm	6 420SH-120-1500
400 mm	140 mm	6 420SH-140-400
400 mm	175 mm	6 420SH-175-400

Handy Spring Clamps with Movable Gripping Surface



420SC

Icon	g	Icon	Icon
	60 g		
25 mm	60 g	10	420SC-25
50 mm	120 g	5	420SC-50

Heavy Duty Round Guide Bench Vices with Interchangeable Jaws, Suitable for Swivel Base



6010

Icon	Icon	Icon	Icon
80 mm	1	601000800	
100 mm	1	601001000	
125 mm	1	601001250	
150 mm	1	601001500	

Pair of Spare Pipe Jaw Set for 834V-4, 834V-7 & 6072 Bench Vices



833P

Icon	Icon	Icon	Icon
100 mm	1	833PJ-4	
125 mm	1	833PJ-5	
150 / 175 mm	1	833PJ-67	

BENCH VICES

Heavy Duty Square Guide Bench Vices with Interchangeable Jaws



834V

Icon	Icon	Icon	Icon
100 mm	1	834V-4	
125 mm	1	834V-5	
150 mm	1	834V-6	
175 mm	1	834V-7	

Slide adjustment screw to regulate the looseness with pipe holding jaws

Round Guide Portable Bench Vices with Interchangeable Jaws



834V-2

Icon	Icon	Icon	Icon
63 mm	1	834V-2	

Spare Spindles and Nuts for 6072 and 834V Bench Vices



6070H

Icon	Icon	Icon	Icon
100 mm	1	6070H1000	
125 mm	1	6070H1250	
150 mm	1	6070H1500	
175 mm	1	6070H1750	

Heavy Duty Square Guide Bench Vices with Interchangeable Jaws, Suitable for Swivel Base



6072

Icon	Icon	Icon	Icon
100 mm	1	607201000	
125 mm	1	607201250	
150 mm	1	607201500	
175 mm	1	607201750	

Pair of Spare Jaws and Screws for 6072 and 834V Bench Vices



6072M

Icon	Icon	Icon	Icon
100 mm	834V-4, 607201000	1	6072M1000
150 mm	834V-6, 607201500	1	6072M1500
175 mm	834V-7, 607201750	1	6072M1750

125 mm size jaw common for round & square models

Pair of Spare Jaws and Screws for 6010 Bench Vice



6010M

Icon	Icon	Icon	Icon
80 mm	601000800	1	6010M0800
100 mm	601001000	1	6010M1000
125 mm	834V-5, 607201250, 601001250	1	6010M1250
150 mm	601001500	1	6010M1500

125 mm size jaw common for round & square models



Spare Spindles and Bolts for 6010 Bench Vice



6010H

↓ ↔	↕ ↔	↕ ↔
80 mm	1	6010H0800
100 mm	1	6010H1000
125 mm	1	6010H1250
150 mm	1	6010H1500

Pair of Spare Aluminium Jaws with magnetic strip



833AJ

↓ ↔	↕ ↔	↕ ↔
100 mm	1	833AJ-4
125 mm	1	833AJ-5
150 mm	1	833AJ-6

Pair of Spare Jaws for 834V-2 Table Vice



6040M/H

↓ ↔	↕ ↔	↕ ↔
63 mm	1	6040M0630

Pair of Spare Polyurethane Jaws with magnetic strip

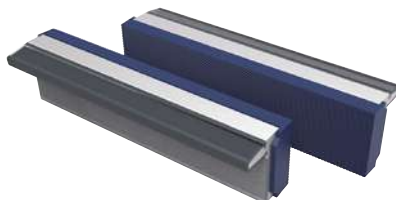

833FJ

↓ ↔	↕ ↔	↕ ↔
100 mm	1	833FJ-4
125 mm	1	833FJ-5
150 mm	1	833FJ-6

BENCH VICE ACCESSORIES

Swivel Bases for 6010/6072 and 834V Bench Vices



833SB

↓ ↔	↓ ↔	↕ ↔
80 mm	100 mm	1 833SB-4
100 mm	125 mm	1 833SB-5
125 mm	150 mm	1 833SB-6
150 mm	175 mm	1 833SB-7





Hammers



CLAW HAMMERS



ERGO™ Claw Hammers with Rubber Grip 



529		
450 g	4	529-16-L
450 g	4	529-16-XL
570 g	4	529-20-L
570 g	4	529-20-XL



ERGO™ Straight Claw Hammers with Bi-Material Rubber Grip 



529S		
450 g	4	529S-16-XL
570 g	4	529S-20-XL

Claw Hammers with Rubber Grip Steel Tube Handle 



429		
230 g	4	429-8
370 g	4	429-13
450 g	4	429-16
570 g	4	429-20



Claw Hammers with Rubber Grip Fibreglass Handle 



428		
450 g	4	428-16



Claw Hammer rubber grip with curved nails 



428F		
230 g	4	428F-8
370 g	4	428F-13
454 g	4	428F-16
567 g	4	428F-20
680 g	4	428F-24



Claw Hammer rubber grip with RIP nails 



428S		
454 g	4	428S-16
567 g	4	428S-20



Claw Hammers with Anti-Slip Surface Wooden Handle 



427		
370 g	4	427-13
680 g	4	427-24
230 g	4	427-8
450 g	4	427-16
570 g	4	427-20

Claw Hammer with RIP nails and polish head 



427S		
454 g	4	427S-16
567 g	4	427S-20

Spanish Style Claw Hammers with Dotted Grip Hickory Handle 



427		
700 g	6	427-700

Spanish Style Claw Hammers with Rubber Grip Tri-Material Handle



428

700 g	6	428-700

NAIL PULLERS

Compact Nail Pullers with Thermoplastic Handle



36

220 mm	5	36

ENGINEERING HAMMERS

Ball Pein Hammers with Hickory Handle



479

230 g	6	479-08
340 g	6	479-12
450 g	6	479-16
570 g	6	479-20
800 g	6	479-24
900 g	6	479-32

Ball Pein hammer with fiberglass Handle



479F

230 g	6	479F-08
340 g	6	479F-12
450 g	6	479F-16
570 g	6	479F-20
680 g	6	479F-24
900 g	6	479F-32

German DIN Locksmith's Hammers



481

100 g	6	481-100
200 g	6	481-200
300 g	6	481-300
400 g	6	481-400
500 g	6	481-500
800 g	6	481-800
1000 g	6	481-1000
1500 g	6	481-1500
2000 g	6	481-2000

German DIN Hammer Fiberglass Handle



481F

100 g	6	481F-100
200 g	4	481F-200

300 g	6	481F-300
400 g	6	481F-400
500 g	6	481F-500
800 g	6	481F-800
1000 g	6	481F-1000
1500 g	4	481F-1500
2000 g	4	481F-2000

Rivoir Hammers French Pattern with Anti-Sliding Handle



482

300 g	6	482-25
400 g	6	482-28
500 g	6	482-30
800 g	6	482-35
1000 g	6	482-40
1500 g	6	482-45

Rivoir Hammer Fiberglass Handle



482F

300 g	4	482F-25
400 g	4	482F-28
470 g	6	482F-30
800 g	4	482F-35
1000 g	2	482F-40
1500 g	4	482F-45



Warrington Hammers English Joiner's with Cross Pein



480

Weight	Quantity	Model
230 g	4	480-08
280 g	6	480-10
340 g	6	480-12
400 g	4	480-14
570 g	4	480-20

Carpenter Hammers Spike Claw with Forged Head



485W

Weight	Quantity	Model
650 g	6	485W-650
750 g	6	485W-750
	1	SH-485W
	1	SH-485W-PLATES

Cross Pein Pin Hammers with Hickory Handle



490

Weight	Quantity	Model
100 g	4	490-3.5

Pattern Makers Hammers with Ball Pein and Hickory Handle



492

Weight	Quantity	Model
100 g	4	492-3.5

Joiner's Hammers French Pattern



483

Weight	Quantity	Model
100 g	6	483-16
160 g	6	483-20
200 g	6	483-22
300 g	6	483-25
400 g	6	483-28
500 g	6	483-30

Club Hammers with Hickory Handle



484

Weight	Quantity	Model
1000 g	6	484-1000
1250 g	6	484-1250
1500 g	6	484-1500
2000 g	4	484-2000

CONSTRUCTION HAMMERS

Carpenter Hammers Spike Claw with Tubular Steel Shaft



485

Weight	Quantity	Model
600 g	6	485

Joiner Hammer Fiberglass Handle



483F

Weight	Quantity	Model
100 g	6	483F-16
160 g	6	483F-20
200 g	6	483F-22
300 g	6	483F-25
400 g	6	483F-28
500 g	4	483F-30

Club Hammer Fiberglass Handle



484F

Weight	Quantity	Model
1000 g	6	484F-1000
1250 g	6	484F-1250
1500 g	6	484F-1500
2000 g	4	484F-2000

Club Hammers Spanish Type with Oval Eye



407

Weight	Quantity	Model
700 g	5	407-700
1000 g	6	407-1000
1400 g	6	407-1400

Club Hammers with Fibreglass Handle



407F

Weight	Quantity	Model
700 g	6	407F-700
1000 g	6	407F-1000
1400 g	6	407F-1400

Square Head Sledge Hammers with Hickory Handle



488

Weight	Quantity	Model
2000 g	2	488-2000
3000 g	2	488-3000
4000 g	2	488-4000
5000 g	2	488-5000
6000 g	1	488-6000

Square Head Sledge Hammers with Tri-Material Handle



488F

Weight	Quantity	Model
2000 g	2	488F-2000
3000 g	2	488F-3000
4000 g	2	488F-4000
5000 g	4	488F-5000
6000 g	2	488F-6000

Bricklayer's Hammers with Hickory Handle



486W

Weight	Quantity	Model
500 g	4	486W-500
600 g	4	486W-600
	1	SH-486W

Spanish Type Bricklayer's Hammers with Hickory Handle



486-700

Weight	Quantity	Model
700 g	6	486-700

Spanish Type Bricklayer's Hammers with Fibreglass Handle



486F

Weight	Quantity	Model
700 g	6	486F-700

Bricklayer's Hammers with Rubber Grip



486

Weight	Quantity	Model
600 g	4	486

Mason's Pin with Pointed Tip



4401

Length	Quantity	Model
255 mm	10	440102500
300 mm	10	440103000



Spare Wooden Handles for Hammers



WSH

Icon	Icon	Icon
407	1	SH-407
491-3000 & 491-4000	12	SH-491-34
491-5000 & 491-6000	12	SH-491-56
488-2000	10	SH-488-2000
488-3000, 488-4000	10	SH-488-34
488-5000, 488-6000	10	SH-488-56
427-700	10	SH-427-700
486-700, 495-500, 495-600, 493-500, 493-600	10	SH-486-493-495

Spanish Type Shovel-Hatchets with Fibreglass Handle



493F

Icon	Icon	Icon
500 g	6	493F-500
600 g	1	493F-600

Plasterer's Hatchets with Tubular Steel Shaft



494

Icon	Icon	Icon
600 g	4	494-600

Fibreglass Spare Handles



FSH

Icon	Icon	Icon
488f-2000	10	SH-488F-2000
488F-3000 & 488F-4000	1	SH-488F-34
488F-5000 & 488F-6000	1	SH-488F-56
428-700	10	SH-428-700
486F-700, 495F-500, 495F-600, 493F-500, 493F-600	10	SH-486F493F495F

Spanish Type Shovel-Picks with Hickory Handle



495

Icon	Icon	Icon
500 g	6	495-500
600 g	6	495-600

SLEDGE HAMMERS

Anti Rebound Hammers with Wooden Handle



3625AR

g	Icon	Icon
550 g	34	3625AR-35
1430 g	18	3625AR-50
1550 g	12	3625AR-60

SPECIALTY HAMMERS

Spanish Type Shovel-Hatchets with Wooden Handle



493

Icon	Icon	Icon
500 g	6	493-500
600 g	6	493-600

Spanish Type Shovel-Picks with Fibreglass Handle



495F

Icon	Icon	Icon
500 g	6	495F-500
600 g	1	495F-600

Spare Tips for 3625AR Hammers



3625ARL

Icon	Icon	Icon	Icon
35 mm	3625AR-35	6	3625ARL-35
50 mm	3625AR-50	6	3625ARL-50
60 mm	3625AR-60	6	3625ARL-60

Spare Handle for 3625AR Hammers



3625ARLH

3625AR-35	290 mm	80	60	3625ARLH-35
3625AR-60	300 mm	50	60	3625ARLH-50
3625AR-60	390 mm	16	60	3625ARLH-60

Pein Sledge Hammers with Hickory Handle



491

3000 g	4	4	491-3000
4000 g	4	4	491-4000
5000 g	4	4	491-5000
6000 g	4	4	491-6000

SOFT FACE HAMMERS & MALLETS

Polyplex Plastic Hammers with Wooden Handle



3625Y

120 g	6	3625Y-22
225 g	6	3625Y-32
372 g	6	3625Y-40
484 g	6	3625Y-50

Dead Blow Sledge Hammers with Anti-Sliding Handle



3625PU

300 g	12	3625PU-30
790 g	6	3625PU-50
1080 g	6	3625PU-60

99/105 mm Safety Sledge Hammers with Rubber Handle



489-1100/489-1800

1100 g	8	489-1100
1800 g	8	489-1800

Pairs of Poll for 3625Y Polyflex Plastic Hammers



3625YL

3625Y-22	22 mm	20	3625YL-22
3625Y-32	32 mm	20	3625YL-32
3625Y-40	40 mm	20	3625YL-40
3625Y-50	50 mm	20	3625YL-50

Dead Blow Sledge Hammers with Anti-Sliding Handle 105 mm



3625PU-105

5000 g	5600 g	4	3625PU-105

150/190 mm Safety Sledge Hammers with Rubber Handle



489-2700/489-5400

2700 g	4	489-2700
3600 g	4	489-3600
4500 g	4	489-4500
5400 g	4	489-5400

Superflex Plastic Hammers with Wooden Handle



3625N





120 g	6	3625N-22
225 g	6	3625N-32
372 g	6	3625N-40
484 g	6	3625N-50



Pairs of Poll for 3625N Superflex Plastic Hammers





3625NL

   		
3625N-22	22 mm	20 3625NL-22
3625N-32	32 mm	20 3625NL-32
3625N-40	40 mm	20 3625NL-40
3625N-50	50 mm	20 3625NL-50

Spare Handle for 3625W Hammers





3625WLH

  	
3625W-22	50 3625WLH-22
3625W-28	50 3625WLH-28
3625W-35	80 3625WLH-35
3625W-44	50 3625WLH-44
3625W-55	16 3625WLH-55

Rubber Mallets with Wooden Handle





3625RM

g	 
290 g	50 3625RM-55
460 g	40 3625RM-65
660 g	30 3625RM-75
850 g	20 3625RM-90

Nylon Tip Mallets with Wooden Handle





3625W

g	 
150 g	120 3625W-22
250 g	72 3625W-28
490 g	40 3625W-35
1050 g	1 3625W-44
1470 g	12 3625W-55

Nylon Tip Mallets with Rubber Grip





3625S

g	 
350 g	50 3625S-28
610 g	30 3625S-35
1100 g	18 3625S-44

Copper Sledge Hammers with Soft Face







4130

g	 
500 g	12 413005000
1000 g	12 413010000
1500 g	12 413015000
2000 g	6 413020000
3000 g	1 413030000
4000 g	1 413040000

Pairs of Poll for 3625W and 3625S Nylon Tipped Mallets



3625WL

   		
3625W-22	22 mm	10 3625WL-22
3625W-28, 3625S-28	28 mm	10 3625WL-28
3625W-35, 3625S-35	35 mm	10 3625WL-35
3625W-44, 3625S-44	44 mm	10 3625WL-44
3625W-55	55 mm	6 3625WL-55



Tree Felling & Forestry Tools



AXES, HATCHETS & MAULS

Camping Axes with Curved Ash Wood Handle and Yankee Pattern 380 mm-500 mm



HUS

Length	Weight (g)	Quantity	Model
380 mm	830 g	4	HUS-0.6-380
500 mm	1030 g	4	HUS-0.8-500

Camping Axes with Curved Ash Wood Handle



HGPS

Length	Weight (g)	Quantity	Model
380 mm	944 g	4	HGPS-0.8-380-WB
400 mm	1130 g	4	HGPS-1.0-400-WB
360 mm	810 g	10	HGPS-0.6-360
380 mm	930 g	4	HGPS-0.8-380
400 mm	1180 g	4	HGPS-1.0-400

Camping Axes with Composite Handle



CUC

Length	Weight (g)	Quantity	Model
360 mm	640 g	4	CUC-0.4-360

Camping Axes with Curved Ash Wood Handle and Yankee Pattern 650 mm



HUS-1.0-650

Length	Weight (g)	Quantity	Model
650 mm	1610 g	4	HUS-1.0-650

60 cm Chopping Fibreglass Handle Axes



CUC-0.8-600

Length	Weight (g)	Quantity	Model
600 mm	1220 g	4	CUC-0.8-600

Camping Axes with Fibreglass Handle and French Pattern Blade



HFGPS

Length	Weight (g)	Quantity	Model
380 mm	1010 g	4	HFGPS-0,7-400FG

Felling Axes with Curved Ash Wood Handle 800 mm



FGS-810

Length	Weight (g)	Quantity	Model
800 mm	2230 g	4	FGS-1.6-810
800 mm	2480 g	4	FGS-1.8-810

Felling Axes with Hickory Wood Handle and Canadian Style



FCP

Length	Weight (g)	Quantity	Model
800 mm	2540 g	4	FCP-1.8-810
850 mm	3000 g	2	FCP-2.3-860

Felling Axes with Curved Ash Wood Handle 600 mm-700 mm



FGS

Length	Weight (g)	Quantity	Model
700 mm	1730 g	4	FGS-1.25-700-WB
810 mm	2210 g	4	FGS-1.6-810-WB
600 mm	1330 g	4	FGS-1.0-600
700 mm	1850 g	4	FGS-1.25-700

Felling Axes with Fibreglass Handle and French Style



FFSS

Length	Weight (g)	Quantity	Model
900 mm	2400 g	4	FFSS-1.5-900FG

Splitting Axes with Curved Ash Wood Handle



SUS

Length	Weight (g)	Quantity	Model
800 mm	2660 g	4	SUS-2.0-800

Splitting Axes with Hickory Wood Handle



MCP

Length	Weight (g)	Quantity	Model
800 mm	3300 g	2	MCP-2.5-810

Splitting Axes with Composite Handle



SUC

Length	Weight (g)	Quantity	Model
450 mm	980 g	4	SUC-0.7-450
600 mm	1310 g	4	SUC-0.9-600
710 mm	1550 g	4	SUC-1.0-710
780 mm	2300 g	4	SUC-1.7-800

Mauls/Sledges with Ash Wood/3-Component Handle and Two Flat Face



LS-MASSE

Length	Weight (g)	Quantity	Model
900 mm	4800 g	2	LS-MASSE-4FG
900 mm	4450 g	2	LS-MASSE-4

Mauls/Sledges with 3-Component Handle and One Flat Face



LS-MASSE-TR

Length	Weight (g)	Quantity	Model
900 mm	4840 g	2	LS-MASSE-TR-4FG

Spare Ash Wood Handles for Pick Axes



SH

Length	Quantity	Model
800 mm	1	SH-FCS-810
900 mm	1	SH-FCS-860
600 mm	1	SH-FGS-600
700 mm	12	SH-FGS-700
800 mm	1	SH-FGS-800
900 mm	1	SH-FGS-1.8-810
375 mm	1	SH-HGFS-400FG
400 mm	1	SH-HGFS-400
900 mm	12	SH-MES-F-900
360 mm	12	SH-HGFS-360
380 mm	1	SH-HGFS-380
380 mm	1	SH-HUS-380
500 mm	1	SH-HUS-500
650 mm	1	SH-HUS-650
900 mm	12	SH-MES-900
915 mm	12	SH-MES-900FG
800 mm	12	SH-SUS-800
800 mm	1	SH-MCS-800
905 mm	1	SH-FCP-860

Splitting Axes with Ash Wood/3-Component Handle and One Flat Face



LS/MES

Length	Weight (g)	Quantity	Model
900 mm	3270 g	2	LS-MERLIN-2.5
900 mm	3330 g	2	LS-MERLIN-2.5FG
900 mm	3620 g	2	MES-3.0-900

Splitting Axes with Ash Wood/3-Component Handle



MES

Length	Weight (g)	Quantity	Model
900 mm	3880 g	2	MES-3.5-900
900 mm	4310 g	2	MES-3.5-900FG

Pick Axes with Fibreglass Handle for Construction Work



PAGS-2.0-900FG

Length	Weight (g)	Quantity	Model
900 mm	3000 g	1	PAGS-2.0-900FG

Pick Axes Heads with Round Eye for Construction Work



PAGS

Length	Weight (g)	Quantity	Model
450 mm	2000 g	1	PAGS-2.0

Ash Wood/Fibreglass Spare Handles for Pick Axes with Round Eye



SH-PAGS

Length	Weight (g)	Quantity	Model
900 mm	690 g	1	SH-PAGS-900
920 mm	1030 g	1	SH-PAGS-900FG



WEDGES

Synthetic Felling Wedges



LS-COIN

Length (mm)	Weight (g)	Quantity	Model
260 mm	295 g	2	LS-COIN 26 CM
190 mm	170 g	4	LS-COIN 19 CM

Twisted Steel Splitting Wedges



WT

Length (mm)	Weight (g)	Quantity	Model
220 mm	2000 g	4	W-T-2.0

Traditional Steel Splitting Wedges



WS

Length (mm)	Weight (g)	Quantity	Model
220 mm	1500 g	4	W-S-1.5
250 mm	2000 g	4	W-S-2.0
260 mm	2500 g	4	W-S-2.5



Cold Chisels & Punches



COLD CHISELS

Flat Cold Chisels with Octagonal Shank, Plastic Covered



3656

L	W	Q	Part No.
129 mm	12 mm	50	3656-125
155 mm	16 mm	50	3656-150
178 mm	19,5 mm	1	3656-175

Cold Chisels with Flat Oval Shank and Phosphate Finish



3640

L	W	Q	Part No.
150 mm	18 mm	25	3640-150-C
175 mm	21 mm	6	3640-175-C
200 mm	22 mm	25	3640-200-C
250 mm	28 mm	20	3640-250-C
300 mm	26 mm	25	3640-300-C

Cold Cape Chisels with Flat Oval Shank and Lacquered Copper Finish



3745

L	W	Q	Part No.
150 mm	6 mm	50	3745-150
175 mm	7 mm	25	3745-175
200 mm	8 mm	20	3745-200
250 mm	9 mm	10	3745-250

Cold Chisels with Flat Oval Shank and Lacquered Copper Finish



3740

L	Q	Part No.
100 mm	50	3740-100
125 mm	50	3740-125
150 mm	50	3740-150
175 mm	25	3740-175
200 mm	25	3740-200
250 mm	10	3740-250
300 mm	10	3740-300

Flat Cold Chisels with Octagonal Shank and Lacquered Copper Finish



3756

L	W	Q	Part No.
125 mm	10 mm	50	3756-125
150 mm	12 mm	50	3756-150

Cold Cape Chisel with Octagonal Shank and Lacquered Copper Finish



3749

L	W	Q	Part No.
125 mm	10 mm	50	3749-125

Cold Chisels with Flat Oval Shank and Lacquered Copper Finish Retail Pack



SB-3740

L	Q	Part No.
125 mm	87	SB-3740-125
150 mm	25	SB-3740-150
175 mm	25	SB-3740-175
200 mm	25	SB-3740-200
250 mm	25	SB-3740-250
300 mm	25	SB-3740-300

Cold Cape Chisels with Flat Octagonal Shank, Plastic Covered



3649

L	W	Q	Part No.
128 mm	12 mm	50	3649-125

Slitting Chisels with Flat Oval Shank and Lacquered Copper Finish



3750

L	W	Q	Part No.
240 mm	26 mm	25	3750

Mason's Chisels with Octagonal Shank and Lacquered Copper Finish



3736M

L			
200 mm	30	3736M-200	
250 mm	25	3736M-250	
300 mm	10	3736M-300	
400 mm	10	3736M-400	

Pointed Chisels with Octagonal Shank and Lacquered Copper Finish



3739-250 / -400

L		∅		
250 mm	16 mm	25	3739-250	
300 mm	18 mm	10	3739-300	
400 mm	18 mm	10	3739-400	

Pointed Chisels with Octagonal Shank and Guard



3739H

L		∅		
250 mm	16 mm	15	3739H-250	
300 mm	18 mm	10	3739H-300	
400 mm	18 mm	10	3739H-400	

Mason's Chisels with Long Flat Shank



8740

L			
200 mm	5	874002000	
250 mm	5	874002500	
300 mm	5	874003000	
350 mm	5	874003500	
400 mm	5	874004000	
500 mm	5	874005000	

COLD CHISELS WITH GUARD

Slitting Chisels with Flat Oval Shank and Guard



3750H

L			
240 mm	25	3750H	

COLD CHISELS, REGRINDABLE

Regrindable Cold Chisels with Flat Shank and Guard



8741

L			
200 mm	6	874102000	
250 mm	5	874102500	
300 mm	5	874103000	
350 mm	4	874103500	
400 mm	5	874104000	

Mixed Chisel Set with Lacquered Copper Finish - 6 Pcs/Box



3736S/6

g		
840 g	5	3736S/6

3735-4-120, 3735-5-150

3733-3

3749-125

3756-125, 3756-150

Mason's Chisels with Octagonal Shank and Guard



3736MH

L			
250 mm	10	3736MH-250	
300 mm	10	3736MH-300	
400 mm	5	3736MH-400	

Regrindable Pointed Chisels with Octagonal Shank



8746

L		∅		
200 mm	14 mm	5	874602000	
250 mm	14 mm	5	874602500	
300 mm	16 mm	5	874603000	
350 mm	16 mm	5	874603500	
400 mm	18 mm	5	874604000	



Electrician Regrindable Chisels with Octagonal Shank



8760

Length (mm)	Quantity	Part Number
200 mm	10	876002000
250 mm	5	876002500

Regrindable Cold Chisels with Extra Flat Shank



8770

Length (mm)	Quantity	Part Number
240 mm	25	877002400

COLD CHISELS ACCESSORIES

Handles for Cold Chisels



8749

Length (mm)	Quantity	Part Number
160 mm	1	874916X16
180 mm	1	874918X18
230 mm	1	874923X13
260 mm	1	874926X7

PUNCHES

Centre Punches with Octagonal Shank and Hand Protection



3643

Shank Diameter (mm)	Length (mm)	Quantity	Part Number
3 mm	100 mm	50	3643-100
4 mm	120 mm	50	3643-120
5 mm	120 mm	50	3643-150

Centre Punches with Octagonal Shank and Lacquered Copper Finish



3735

Shank Diameter (mm)	Length (mm)	Quantity	Part Number
4 mm	120 mm	50	3735-4-120
5 mm	120 mm	50	3735-5-120
5 mm	150 mm	50	3735-5-150

Centre Punches with Hexagonal Shank and Chrome Finish



3735N

Shank Diameter (mm)	Length (mm)	Quantity	Part Number
2 mm	100 mm	10	3735N-2-100
4 mm	120 mm	10	3735N-4-120
5 mm	120 mm	10	3735N-5-120
6 mm	150 mm	10	3735N-6-150
8 mm	150 mm	10	3735N-8-150
2 mm	100 mm	1	SB-3735N-2-100
4 mm	120 mm	60	SB-3735N-4-120
5 mm	120 mm	1	SB-3735N-5-120
6 mm	150 mm	1	SB-3735N-6-150
8 mm	150 mm	1	SB-3735N-8-150

SB: With hanging clip

Centre Punch Set with Chrome Finish - 4 Pcs/Wallet



3735NS/4

Weight (g)	Quantity	Part Number
340 g	25	3735NS/4

3735N-6-150, 3735N-8-150, 3735N-2-100, 3735N-4-120

Automatic Centre Punches with Hardened Steel Point



1157

Shank Diameter (mm)	Length (mm)	Quantity	Part Number
2 mm	130 mm	60	1157

Drift Punches with Octagonal Shank and Hand Protection



3644

Shank Diameter (mm)	Length (mm)	Quantity	Part Number
2 mm	120 mm	50	3644-120
3 mm	125 mm	50	3644-125
4 mm	130 mm	50	3644-130
4 mm	150 mm	50	3644-150
5 mm	165 mm	50	3644-165
6 mm	180 mm	50	3644-180
8 mm	200 mm	50	3644-200

Cylindrical Drift Punches with Knurled Guide Sleeve



3659

Ø	L	Icons	Part No.
0.9 mm	70 mm	5	3659-0.9
1.4 mm	81 mm	5	3659-1.4
1.8 mm	84 mm	5	3659-1.8
2.4 mm	92 mm	5	3659-2.4
2.8 mm	95 mm	5	3659-2.8
3.4 mm	97 mm	5	3659-3.4
3.9 mm	100 mm	5	3659-3.9
5.9 mm	100 mm	5	3659-6.0

Cylindrical Drift Punches with Octagonal Shank and Hand Protection



3658A

Ø	L	Icons	Part No.
2 mm	150 mm	125	3658A-2
2 mm	150 mm	125	3658A-3
4 mm	150 mm	125	3658A-4
4 mm	150 mm	125	3658A-5
6 mm	150 mm	125	3658A-6
7 mm	150 mm	50	3658A-8

Ø	L	Icons	Part No.
8 mm	150 mm	10	3734N-8-150
9 mm	150 mm	10	3734N-9-150
10 mm	150 mm	10	3734N-10-150
2 mm	150 mm	1	SB-3734N-2-150
3 mm	150 mm	1	SB-3734N-3-150
4 mm	150 mm	60	SB-3734N-4-150
5 mm	150 mm	1	SB-3734N-5-150
6 mm	150 mm	60	SB-3734N-6-150
7 mm	150 mm	1	SB-3734N-7-150
8 mm	150 mm	1	SB-3734N-8-150
10 mm	150 mm	1	SB-3734N-10-150

Conical Drift Punches with Octagonal Shank and Lacquered Copper Finish



3733

Ø	L	Icons	Part No.
2 mm	120 mm	50	3733-2
3 mm	120 mm	50	3733-3
4 mm	120 mm	50	3733-4
5 mm	120 mm	50	3733-5
6 mm	120 mm	50	3733-6

Cylindrical Drift Punches with Octagonal Shank and Lacquered Copper Finish



3734

Ø	L	Icons	Part No.
2 mm	150 mm	50	3734-2
3 mm	150 mm	50	3734-3
4 mm	150 mm	50	3734-4
5 mm	150 mm	50	3734-5
6 mm	150 mm	50	3734-6
8 mm	150 mm	50	3734-8

Fine Grounded Pin Drift Punch Set with Hand Protection - 6 Pcs/Wooden Stand



3646/6

g	Icons	Part No.
730 g	25	3646/6

3646-115, 3646-125, 3646-150, 3646-165, 3646-180, 3646-200

Fine Grounded Pin Cylindrical Drift Punches with Octagonal Shank and Hand Protection



3646

Ø	L	Icons	Part No.
2 mm	115 mm	250	3646-115
3 mm	125 mm	250	3646-125
4 mm	150 mm	125	3646-150
5 mm	165 mm	125	3646-165
6 mm	180 mm	50	3646-180
8 mm	200 mm	50	3646-200

Cylindrical Drift Punches with Hexagonal Shank



3734N

Ø	L	Icons	Part No.
2 mm	150 mm	10	3734N-2-150
3 mm	150 mm	10	3734N-3-150
4 mm	150 mm	10	3734N-4-150
5 mm	150 mm	10	3734N-5-150
6 mm	150 mm	10	3734N-6-150
7 mm	150 mm	10	3734N-7-150

Chisel and Drift Punch Set - 6 Pcs/Plastic Wallet



3654R

g	Icons	Part No.
870 g	1	3654R

2 x 3656, 1 x 3649, 2 x 3644, 1 x 3643



Drift Punch Set with Knurled Guide Sleeve - 8 Pcs/Plastic Stand



3659/8

270 g	1	3659/8

3659-0.9, 3659-1.4, 3659-1.8, 3659-2.4, 3659-2.8, 3659-3.4, 3659-3.9, 3659-6.0

Cylindrical Drift Punch Set with Hand Protection - 6 Pcs/Wooden Stand



3658A/6

560 g	30	3658A/6

3658A-2, 3658A-3, 3658A-4, 3658A-5, 3658A-6, 3658A-8

Cylindrical Drift Punch Set with Hexagonal Shank - 9 Pcs/Wallet



3734NS/9

750 g	10	3734NS/9

3734N-10-150, 3734N-9-150, 3734N-8-150, 3734N-7-150, 3734N-6-150, 3734N-5-150, 3734N-4-150, 3734N-3-150, 3734N-2-150

Cylindrical Drift Punch Set with Octagonal Shank - 6 Pcs/Box



3734S/6

720 g	5	3734S/6

3734-2, 3734-3, 3734-4, 3734-5, 3734-6, 3734-8

Drift Punch Set with Knurled Guide Sleeve - 8 Pcs/Plastic Wallet



3659/8T

170 g	1	3659/8T

3659-0.9, 3659-2.8, 3659-2.4, 3659-1.8, 3659-6.0, 3659-3.9, 3659-3.4, 3659-1.4

Nail Drift Punches with Plastic Handle Retail Pack



3732

2 mm	125 mm	60	SB-3732-2-125
2,5 mm	125 mm	60	SB-3732-2.5-125
3,2 mm	125 mm	60	SB-3732-3.2-125
4 mm	125 mm	1	SB-3732-4-125

Chisel and Drift Punch Set - 10 Pcs/Plastic Wallet



3656/10

1260 g	1	3656/10

3 x 3656, 1 x 3644, 1 x 3649, 1 x 3643 en 3 x 3646

Conical Drift Punch Set with Octagonal Shank - 5 Pcs/Wallet



3733S/5

410 g	25	3733S/5

3733-4, 3733-2, 3733-6
3733-8, 3733-10

Wad Punch Noses



B400

2 mm	1	B400.002
3 mm	1	B400.003
4 mm	1	B400.004
5 mm	1	B400.005
6 mm	1	B400.006
7 mm	1	B400.007



8 mm	1	B400.008
9 mm	1	B400.009
10 mm	1	B400.010
11 mm	1	B400.011
12 mm	1	B400.012
13 mm	1	B400.013
14 mm	1	B400.014
15 mm	1	B400.015
16 mm	1	B400.016
17 mm	1	B400.017
18 mm	1	B400.018
19 mm	1	B400.019
20 mm	1	B400.020
21 mm	1	B400.021
22 mm	1	B400.022
23 mm	1	B400.023
24 mm	1	B400.024
25 mm	1	B400.025
26 mm	1	B400.026
27 mm	1	B400.027
28 mm	1	B400.028
29 mm	1	B400.029
30 mm	1	B400.030
31 mm	1	B400.031
32 mm	1	B400.032
33 mm	1	B400.033
34 mm	1	B400.034
35 mm	1	B400.035
36 mm	1	B400.036
37 mm	1	B400.037
38 mm	1	B400.038
39 mm	1	B400.039
40 mm	1	B400.040
41 mm	1	B400.041
42 mm	1	B400.042
43 mm	1	B400.043
44 mm	1	B400.044
45 mm	1	B400.045
46 mm	1	B400.046
47 mm	1	B400.047
48 mm	1	B400.048
49 mm	1	B400.049
50 mm	1	B400.050

Handles for 2 mm-30 mm Wad Punches



WPH3-30

160 mm	530 g	1 WPH 3-30

Interchangeable Wad Punch Set - 16 Pcs/
Plastic Case



400.003.030

3-30 mm	1 400.003.030

Handles for 2 mm-50 mm Wad Punches



WPH2-50

170 mm	780 g	1 WPH 2-50

Interchangeable Wad Punch Set - 32 Pcs/
Plastic Case



400.002.050

2-50 mm	1 400.002.050

Handles for 2 mm-20 mm Wad Punches



WPH3-20

95 mm	320 g	1 WPH 3-20

Interchangeable Wad Punch Set - 11 Pcs/
Plastic Case



400.003.020

3-20 mm	1 400.003.020

Revolving Wad Punches with Plastic
Handle for 2 mm-4.5 mm



2635

245 mm	1 2635



Revolving Wad Punches for 2 mm-4.5 mm



4630



220 mm



1 4630

Knockout Screw Hole Punches



6900



16 mm	1	690000160
20 mm	1	690000200
22 mm	1	690000220
25 mm	1	690000250
30 mm	1	690000300
32 mm	1	690000320
35 mm	1	690000350
40 mm	1	690000400
50 mm	1	690000500
63 mm	1	690000630

Screw Punch Set - 7 Pcs/Plastic Box



6907



4080 g



1 69079019P

690000160, 690000250, 690000200, 690000320,
690000500, 690000400, 690000630



690900120, 690900080, 690900100, 690900200,
690900140



Spare Screws for 6900 Series Screw Punchers



6909



16 mm	4	690900080
20-25 mm	4	690900100
30-35 mm	2	690900120
40-50 mm	2	690900140
63 mm	1	690900200

PUNCHES WITH 2-COMPONENT HANDLE

Centre Punch with 2-Component Handle and Guard



SB3755BM



4 mm	165 mm	1	SB3755BM-4
6 mm	185 mm	5	SB3755BM-6

SB: Retail pack

Cylindrical Parallel Pin Punch with 2-Component Handle



SB3734BM



10 mm	180 mm	5	SB3734BM-10
3 mm	155 mm	5	SB3734BM-3
4 mm	165 mm	5	SB3734BM-4
5 mm	165 mm	5	SB3734BM-5
6 mm	185 mm	5	SB3734BM-6
8 mm	185 mm	5	SB3734BM-8

SB: Retail pack

Cylindrical Pin Punch Set with Dual-Component Handle - 7 Pcs/Plastic Tray



3734BMS/7



900 g



1 3734BMS/7

3734BM-2, 3734BM-3, 3734BM-4, 3734BM-5, 3734BM-6, 3734BM-8, 3734BM-10

COLD CHISELS WITH 2-COMPONENT HANDLE

Mason's Chisels with 2-component handle



SB3654BM



155 mm
185 mm



5 SB3654BM-15
5 SB3654BM-20

SB: Retail pack

Mixed Mason's Chisel Set with Dual-Component Handle - 7 Pcs/Plastic Tray



3654BMS/7



920 g



1 3654BMS/7

3734BM-2, 3734BM-4, 3734BM-5, 3734BM-6, 3654BM-15, 3654BM-20, 3755BM-6



Pry Bars



WRECKING BARS

Adjustable Pry Bars with V-Claw 260 mm



APB260

260 mm	410 g	10	APB260

Adjustable Pry Bars with V-Claw 360 mm



APB360

360 mm	543 g	10	APB360

Pry Bar Crowfoots with Precise End



CFP250

250 mm	6	CFP250

Pry Bar Crowfoot with Precise End 330 mm - 12 Pcs/Display Pack



CFP250-DISP

12	50 x 280 x 330 mm	12 CFP250-DISP

12x CFP250

CFP250x 12

Pry Bar Crowfoots with Wide End



CFW250

250 mm	6	CFW250

Pry Bar Crowfoot with Wide End 330 mm - 12 Pcs/Display Pack



CFW250-DISP

12	50 x 280 x 330 mm	12 CFW250-DISP

CFW250x 12

Premium Wrecking Bars with Bent and Flat End



WBP

14 mm	346 mm	20	WBP300
16 mm	487 mm	12	WBP500
17 mm	625 mm	12	WBP625
17 mm	704 mm	10	WBP710
20 mm	890 mm	6	WBP900

Wrecking Bars with Bent and Flat End



WBB

391 mm	14 mm	10	WBB400
500 mm	16 mm	10	WBB500
595 mm	18 mm	10	WBB600
680 mm	18 mm	6	WBB700
810 mm	18 mm	6	WBB800
1000 mm	20 mm	4	WBB1000
1200 mm	20 mm	4	WBB1200
1500 mm	22 mm	1	WBB1500

Flat Wrecking Bars with Bent and Flat End



WBF380

374 mm	35 mm	12	WBF380

Mini Flat Wrecking Bars with Bent and Flat End



WBMF190

18 mm	188 mm	24	WBMF190

Wrecking Bar Set - Flat , Mini & Premium with End 346 mm



WBP-3P-3FMF

1600 g	1	WBP-3P-3FMF

Mini Flat Wrecking Bars with Bent and Flat End - 15 Pcs/Display



WBMF190IP

39 g	15	WBMF190IP

WBMF190x 15

WBP300	
WBF380	
WBMF190	

Premium Wrecking Bar Set



WBP-3P-963

4740 g	1	WBP-3P-963

WBP900, WBP625, WBP300





BAHCO



Planting & Cultivating Tools



SHOVELS

Snow Shovels with Dual-Component Handle - Small Size



LST-72324



780 mm

5 LST-72324

Shifting Shovels with Large Square Mouth and Dual-Component Handle



LST-70120



1295 mm

5 LST-70120

SPADES

Lawn Edge Knives with T-Handle



LST-63102



1045 mm

5 LST-63102

FORKS

Digging Forks with Dual-Component D-Handle - Medium Size



LST-51121



1030 mm

5 LST-51121

Digging Forks with Dual-Component D-Handle - Large Size



LST-52121



1200 mm

5 LST-52121

Garden Claws with Large T-Handle and Soft Grips



LST-99102



1030 mm

4 LST-99102

RAKES

Small Garden Rakes with 12 Tines



LST-30111



1470 mm

5 LST-30111

SMALL GARDEN TOOLS

Hoes with Dual-Component Handle



P262



315 mm

10 P262

Border Hoes with Dual-Component Handle



P272



450 mm

5 P272

One Point Hoes with Dual-Component Handle



P268



320 mm



10 P268

Two Point Hoes with Dual-Component Handle and Long Metal Rod



P277



455 mm



5 P277

Border Cultivators with Dual-Component Handle



P274



470 mm



5 P274

One Point Hoes with Dual-Component Handle and Long Metal Rod



P278



455 mm



5 P278

Trowels with Dual-Component Handle



P263



370 mm



10 P263

Border Rakes with Dual-Component Handle



P276



450 mm



5 P276

Two Point Hoes with Dual-Component Handle



P267



320 mm



10 P267

Cultivators with Dual-Component Handle



P264



315 mm



10 P264

Rakes with Dual-Component Handle



P266



335 mm



10 P266



Daisy Grubbers with Dual-Component Handle



P269



315 mm



10 P269

Weeding Forks with Dual-Component Handle



P270



305 mm



10 P270

Bulb Planters with Solid Wooden Handle



P241



340 g



5 P241





Pruning Tools



SECATEURS

ERGO™ Bypass Secateurs with Elastomer Coated Fixed Handle



ergo



PX



15 mm	2	PX-S1
20 mm	2	PX-S2
15 mm	2	PX-M1
20 mm	2	PX-M2
20 mm	2	PX-M2-L
30 mm	2	PX-M3
20 mm	2	PX-L2
30 mm	2	PX-L3

ERGO™ Bypass Secateurs with Elastomer Coated Rotating Handle



ergo



PXR



20 mm	2	PXR-S2-L
15 mm	2	PXR-S1
20 mm	2	PXR-S2
15 mm	2	PXR-M1
20 mm	2	PXR-M2
20 mm	2	PXR-M2-L
30 mm	2	PXR-M3
20 mm	2	PXR-L2

Spare Pre-assembled Cutting Heads for PX and PXR ERGO™ Bypass Secateurs



R801P-R804P



1	1	R801P
2	1	R802P
3	1	R803P
2	1	R804P

Spare Cutting Blades for ERGO™ Bypass Secateurs



R211P/R300P/R500P/R600P

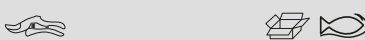

Px/PxR N° 2, P1-20, P2-20	1	R211P
Px/PxR N° 2, P1-20, P2-20	80	R211P-BULK80
Px/PxR N° 1	1	R300P
Px/PxR N° 3	40	R500P
Px-M2-L & PxR-M2-L	1	R600P

Spare Counter Blades for PX and PXR ERGO™ Bypass Secateurs



R303P-R603P

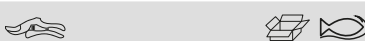

Px-S1, Px-M1, Px-L1, PxR-M1, PxR-L1	1	R303P
Px-S2, Px-M2, Px-L2, PxR-M2, PxR-L2	1	R403P
Px-S3, Px-M3, Px-L3, PxR-M3, PxR-L3	1	R503P
Px-M2-L, PxR-M2-L	1	R603P

Spare Pair of Handles for PX and PXR ERGO™ Bypass Secateurs



ergo



R811P-RT825P



Px-S	1	R811P
Px-M	1	R812P
Px-L	1	R813P
Px-M2-L	1	R815P
PxR-S	1	RT821P
PxR-M	1	RT822P
PxR-L	6	RT823P
PxR-M2-L	1	RT824P
PxR-S2-L	6	RT825P

Spare Centre Bolts for ERGO™ Bypass Secateurs



R900P



PX & PXR	20 g	1	R900P
----------	------	---	-------

Spare Centre Bolt Locking Systems for ERGO™ Bypass Secateurs



R901P



PX & PXR	10 g	30	R901P
----------	------	----	-------

Spare Four Handle Screws with Inserts for PX and PXR ERGO™ Bypass Secateurs



R902P

Icon	g	Icon	Icon
	20 g		
PX & PXR	20 g	24	R902P

Spare Springs for P64 and ERGO™ Bypass Secateurs



R905P-R907P

Icon	g	Icon	Icon
PX & PXR, P64	10 g	1	R905P
PX & PXR, P64	164 g	50	R905P-BULK50
PX & PXR	10 g	1	R906P
PX & PXR	220 g	50	R906P-BULK50
PX & PXR	10 g	1	R907P

Bypass Secateurs with Composite Handle and Angled Head



P1

Icon	L	Icon	Icon
20 mm	200 mm	5	P1-20
30 mm	230 mm	5	P1-23

Spare Two Buffers for PX/PXR, P1/P2, P64 ERGO™ Bypass Secateurs



R903P/R1269P

Icon	g	Icon	Icon
PX & PXR, P1 & P2, P64	10 g	1	R903P
PX & PXR, P1 & P2, P64	486 g	50	R1269P-BULK50

Bypass Secateurs with Forged Steel Handle and Large Cutting Head



P3

Icon	Icon	Icon
20 mm	2	P3-20-F
25 mm	2	P3-23-F

Bypass Secateurs with Soft Grip Composite Handle and Narrow Cutting Head



P108

Icon	L	Icon	Icon
20 mm	200 mm	2	P108-20-F
25 mm	230 mm	2	P108-23-F

Spare Locking Devices for PX and PXR ERGO™ Bypass Secateurs



R904P

Icon	g	Icon	Icon
Px & Pxr	10 g	1	R904P

Bypass Secateurs with Stamped/Pressed Steel Handle and Narrow Cutting Head



P110

Icon	Icon	Icon
20 mm	2	P110-20-F
25 mm	2	P110-23-F

Bypass Secateurs with Forged Steel Handle and Narrow Cutting Head



P5

Icon	L	Icon	Icon
25 mm	230 mm	2	P5-23-F



Anvil Secateurs with Stamped/Pressed Steel Handle



P138

20 mm	220 mm	6	P138-22-F

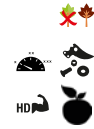

Bypass Secateurs with Stamped/Pressed Steel Handle and Angled Cutting Head



P121

15 mm	180 mm	6	P121-18-F
20 mm	200 mm	6	P121-20-F
25 mm	230 mm	6	P121-23-F



Spare Anvils and Rivets



R221P/R222P

P138-22	1	R221P
P138-22	50	R221P-BULK50

Cut and Hold Secateurs with Composite Handle



P64

12 mm	210 mm	6	P64-20
12 mm	210 mm	12	P64-20-BULK12



Bypass Secateurs with Stamped/Pressed Steel Handle and Straight Cutting Head



P126

15 mm	190 mm	6	P126-19-F
20 mm	220 mm	6	P126-22-F



Spare Cutting Blades for P1-22, P2-22, P6 Bypass Pruners/P7 Left-Handed Pruners



R201P/R171P

P1-22, P2-22	1	R201P
P1-22, P2-22	80	R201P-BULK80

Left and Right Handed Bypass Secateurs with Fibreglass Handle



PG-01-F/PG-03-L

12-20 mm	6	PG-01-F
12-20 mm	2	PG-03-L



Left and Right Handed Bypass Secateurs with Composite Handle



PG-12-F

20 mm	210 mm	10	PG-12-F
20 mm	210 mm	15	PG-12-BULK15



Spare Blade for P4 Bypass Secateurs



R301P

P4-20, P4R-20	41 g	30	R301P

Spare Cutting Blades for Hand and Top-Pruners



R112PG-R124PG/R224P

Icon	Icon	Icon
P3-20, P5-20	1	R112PG
P108-20, P110-20	1	R114PG
P3-23, P5-23	30	R122PG
P108-23, P110-23, P34-27A	30	R124PG
P138-22	1	R223P
P138-22	80	R223P-BULK80

Spare Centre Bolts for P4 Bypass Secateurs



R900P-Z

Icon	g	Icon	Icon
P4-20, P4-23, P4R-20, P4R-23	21 g	24	R900P-Z

Spare Counter Blades and Pins for Hand-Pruners



R113PG/R123PG

Icon	Icon	Icon
P108-20, P110-20	30	R113PG
P108-23, P110-23	30	R123PG

Spare Counter Blades for P1-22, P2-22 Bypass Pruners/P6 and P7 Left-Handed Pruners



R202P/R271P

Icon	Icon	Icon
P1-22, P2-22	1	R202P

Spare Spring for P4 Bypass Secateurs

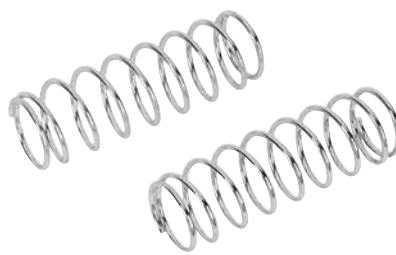

R906P-Z

Icon	g	Icon	Icon
P4-20, P4-23, P4R-20, P4R-23	8 g	12	R906P-Z

Spare Closing Springs



R341P/R474P

Icon	Icon	Icon
P3-20, P3-23	12	R341P
P5-20, P5-23, P108-20, P108-23, P110-20, P110-23	1	R474P

Spare Counter Blade for P4 Bypass Secateurs



R304P

Icon	g	Icon	Icon
P4-20, P4R-20	45 g	1	R304P

Spare Centre Bolt/Nut/Washer Set for Pruners



R239P/R141P/R142P/R157H

Icon	Icon	Icon
P34-27A, P3-20, P3-23, P5-20, P5-23, P108-20, P108-23, P110-20, P110-23	24	R142P
P1-20, P1-22, P2-20, P2-22, P6-20, P7-20	1	R239P

Spare Springs for One-Hand Pruners

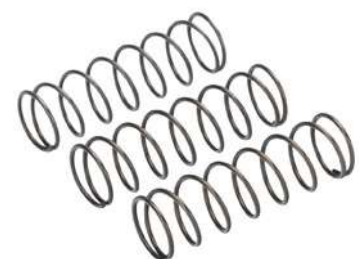

R438P/R463P

Icon	Icon	Icon
P121-23	1	R463P
P138-22	1	R438P
P138-22	50	R438P-BULK50



Spare Spring and Buffer Set for One-Hand Pruners



R1069P



P1-20, P2-20, P6-20, P7-20

12 R1069P

Spare Springs, Buffers and Buffer Cup Set for One-Hand Pruners



R1068



P3-20, P3-23, P5-20, P5-23, P108-20, P108-23, P110-20, P110-23

1 R1068

Spare Part Kit for P5-20 and P5-23 Re-Designed Secateurs



R1080P



P5-20, P5-23

1 R1080P

Spare Handle Screws/Nuts/Closing Button Set with Flat Spring for Pruners



R1601



P1-20, P1-22, P2-20, P6-20, P7-20

1 R1601

Spare Locking Device with Screws and Nuts for P108 and P5 Bypass Secateurs



R478P/R480P



P108
P5

1 R478P
1 R480P

FRUIT PICKING TOOLS

Bypass Snips with Fibreglass Handle



P123



10 mm

30 P123-19-BULK30

Straight Long Snips with Fibreglass Handle



P127



6 mm

30 P127-19-BULK30



Straight Short Snips with Fibreglass Handle



P128



6 mm

6 P128-19
30 P128-19-BULK30



11° Angled Snips with Fibreglass Handle



P129



6 mm

30 P129-19-BULK30



Spare Springs with Buffers for Snips



R1071/R1075

Icon	g	Icon	Icon
P123, P127, P128, P129	20 g	14	R1071
P123, P127, P128, P129	130 g	50	R1075-BULK50

30 mm Professional Bypass Loppers with Wooden Handle and Forged Counter Blade



P16-40W

Icon	L	Icon	Icon
30 mm	400 mm	2	P16-40W

50 mm Professional Bypass Loppers with Aluminium Handle



P19

Icon	L	Icon	Icon
50 mm	800 mm	1	P19-80-F

LOPPERS

30 mm Professional Lightweight Bypass Loppers with Aluminium Handle



P114-SL

Icon	L	Icon	Icon
30 mm	400 mm	2	P114-SL-40
30 mm	500 mm	2	P114-SL-50
30 mm	600 mm	2	P114-SL-60

35 mm Professional Lightweight Bypass Loppers with Aluminium Handle



P116-SL

Icon	L	Icon	Icon
35 mm	400 mm	2	P116-SL-40
35 mm	500 mm	2	P116-SL-50
35 mm	600 mm	2	P116-SL-60
35 mm	700 mm	2	P116-SL-70

55 mm Professional Lightweight Long Bypass Loppers with Aluminium Handle



P280-SL

Icon	L	Icon	Icon
55 mm	600 mm	2	P280-SL-60
55 mm	800 mm	2	P280-SL-80

30 mm Professional Bypass Loppers with Steel Handle and Forged Counter Blade



P16

Icon	L	Icon	Icon
30 mm	400 mm	2	P16-40
30 mm	500 mm	2	P16-50-F
30 mm	600 mm	2	P16-60-F

45 mm Professional Lightweight Long Bypass Loppers with Aluminium Handle and Forged Counter Blade



P160-SL

Icon	L	Icon	Icon
45 mm	600 mm	2	P160-SL-60
45 mm	750 mm	1	P160-SL-75
45 mm	900 mm	1	P160-SL-90

Professional Anvil Loppers with Lever Action and Aluminium Handle



P173-SL

Icon	L	Icon	Icon
45 mm	850 mm	1	P173-SL-85



35 mm Bypass Loppers with Steel Handle



P130-P140

Blade Width	Length	Quantity	Part Number
40 mm	450 mm	6	P130-F
40 mm	660 mm	6	P140-F

40 mm Expert Bypass Loppers with Dual-Component Handle



PG-18

Blade Width	Length	Quantity	Part Number
40 mm	450 mm	2	PG-18-45-F
40 mm	610 mm	2	PG-18-60-F

40 mm Expert Bypass Telescopic Loppers with Dual-Component Handle



PG-19

Blade Width	Length	Quantity	Part Number
40 mm	700 - 900 mm	2	PG-19-F

Spare Cutting Blades for Loppers



R114V/R373A

Blade Width	Length	Quantity	Part Number
P160-SL		28	R160A-BULK28
P280-SL-80		25	R185V
P14		25	R114V
P14		28	R114V-BULK28
P280		1	R181P
P-SL2, P116-SL		1	R16V
P-SL2, P116-SL		14	R16V-BULK14
P-SL, P114-SL		8	R115V
P-SL, P114-SL		14	R115V-BULK14
P172-85, P172-65		1	R172A
P16-40W		25	R116VP
P16		1	R116V
P16		36	R116V-BULK36
P19-80		1	R119V
P160		1	R160A
P173-SL-85		25	R373A

Spare Counter Blades for Loppers



R214V/R26V/R260A...

Blade Width	Length	Quantity	Part Number
P14		1	R214V
P14		28	R214V-BULK28
P116-SL		8	R216SL
P-SL-40/45/60		1	R215V
P114-SL		1	R214SL
P160		16	R260A
P16*		40	R716VCB
P180-70		1	R680V
P19-80		1	R619V

Spare Buffers for Loppers and Hedge Shears



R430V-R516V

Blade Width	Length	Quantity	Part Number
P-SL, P-SL2, P114, P116, P52-SL, P54-SL		22	R440V

Spare Anvils with Screws for Loppers



R372H

Blade Width	Length	Quantity	Part Number
P172-65 /-85, P172-SL		1	R372H

Spare Central Bolt and Nut Set for Loppers



R312V-R318V/R143PV/R144PV/R146

Blade Width	Length	Quantity	Part Number
P280-SL		12	R335V
P16		1	R143PV
P16*		1	R143PVCB
P160		24	R144PV
P14, P174, P176-75		24	R146VS
P14, P174, P176-75		50	R146VS-BULK50
P114-SL, P116-SL		22	R166V
P172-65 /-85		1	R312V
P-SL-40 /-45 /-60		1	R315V
P280-(SL)		22	R328V
P180-70, P19-80, P172		1	R318V

Spare Handle Bolt and Nut Set for Loppers



R415V-R775V

Icon	Icon	Icon
P280-SL	1	R775V
P173-SL-85	1	R776V
P-SL, P-SL2, P114, P116	1	R415V
P19-80	1	R519V
P14, P16	1	R615V
P160	24	R660V
P172-SL	14	R772V
P280-SL-80	1	R773V

Hexagonal Screws for Adjusting Blade to Anvil



R272H

Icon	Icon	Icon
P173-SL-85	30	R472H
P172-65/-85, P172-SL-85	1	R272H

POLE SAWS & TOP PRUNERS

Telescopic aluminium poles



ATP-200

Icon	Icon	Icon
2000-3520 mm	1	ATP-200-350
2070-5040 mm	1	ATP-200-500

Aluminium or Fibreglass Telescopic Poles



AP-/FP-

Icon	Icon	Icon
2000 - 5000 mm	1	AP-5M
2000 - 3500 mm	1	AP-3M
1800 - 3200 mm	1	FP-3M

Aluminium Compact Telescopic Poles



ATP-110-210

Icon	Icon	Icon
1100 - 2100 mm	1	ATP-110-210

Aluminium Base Section Poles



ASP-1850G

Icon	Icon	Icon
1870 mm	1	ASP-1850G

Aluminium Extension Poles



ASP-1850

Icon	Icon	Icon
1870 mm	1	ASP-1850

Adaptors for Pole Saws



ASP-AS

Icon	Icon	Icon
135 mm	6	ASP-AS

Adaptors for P34-37/P134/P34-27A-F Top Pruner



ASP-ATP

Icon	Icon	Icon
160 mm	100 g	6 ASP-ATP

Adaptor for section and telescopic poles



RAUNI

Icon	Icon	Icon
ATP-110-210	82 g	6 RAUNI



Pole Hooks with Adaptor for ASP and ATP Poles



ASP-AS-HOOK

325 g	4 ASP-AS-HOOK



Top Pruners on Telescopic Pole



ATP-230-410

32 mm	2370 - 4110 mm	2 ATP-230-410



Spare cutting blades for top-pruners P34-37



R137E

P34-37	30 R137E

Top Pruners with Triple Pulley Action



P34-37

40 mm	2 P34-37



Top Pruners with Pull Cord



AP-234

30 mm	2200 mm	2 AP-234-F



Spare Blade Kit for ATP-230-410 Telescopic Top Pruner



R230P

ATP-230-410	62 g	10 R230P

Top Pruners with Single Pulley Action



P34-27A

30 mm	2 P34-27A-F



Top Pruner Set



ASP3740-P

40 mm	1 ASP3740-P3437



Spare Spring for ATP-230-410 Telescopic Top Pruner



R4230

ATP-230-410	7 g	10 R4230

ASP-1850G	
ASP-1850	
P34-37	
ASP-ATP	
4750-PSTB-1	

Spare Rubber Bumper for Short Telescopic Pole



RBCP

ATP-110-210	30 g	10	RBCP

Spare Rope for Cutting Head



RD1M

ATP-230-410	5 g	15	RD1M

Spare Counter Blades for Top-Pruners



R133PG

P34-27A	1	R133PG

Spare Rubber Bumper & Inner Handle for Telescopic Top Pruner



RBCP230

ATP-230-410	66 g	12	RBCP230

Spare Centre Bolt and Nut Set for P34-37 Top Pruners



R142P/R337E

P34-37	1	R337E

Spare Lever for Cutting Head for ATP-230-410 Telescopic Top Pruner



RPL230G

ATP-230-410	72 g	8	RPL230G

Spare Cam for ATP Telescopic Poles



RCAM

ATP-200-350 ; ATP-200-500 ; ATP-110-210	29 g	20	RCAM30
ATP-200-500 ; ATP-110-210	37 g	20	RCAM36

Spare Rope for Cutting Head for ATP-230-410 Telescopic Top Pruner



RD7M

ATP-230-410	19 g	20	RD7M

Spare Springs for P34-27A Top Pruner



R427AE/R427E/R437E

P134, P34-27A P34-37	18 18	R427AE R437E



Fine Cut Pole Pruning Saws



ASP-AS-C F

330 mm	7	5	ASP-AS-C33-JT-F

Medium Cut Pole Pruning Saws



ASP-AS-C M

360 mm	6.2	5	ASP-AS-C36-JT-M

Coarse Cut Pole Pruning Saws



ASP-AS-C C

390 mm	5.4	5	ASP-AS-C39-JT-C
450 mm	5.4	2	ASP-AS-C45-JT-C

Hardpoint and Fileable Teeth Pole Pruning Saws with Plastic Handle



339-/340-

360 mm	6	4	339-6T
360 mm	6	4	340-6T

Hardpoint and Fileable Teeth Pole Pruning Saws with Steel Tube Handle



383-/384-

360 mm	6	4	383-6T
360 mm	6	4	384-6T
360 mm	5	4	384-5T

Hardpoint and Fileable Teeth Pole Pruning Saws with Steel Tube Handle and Extended Hook Tip



385-/386-

360 mm	6	4	385-6T
360 mm	6	4	386-6T

Pole Saws Set with 360 mm Medium Cut Blade



ASP3740-C36JTM

1950 mm	2819 g	1	ASP3740-C36JTM

ASP-1850G

ASP-1850

ASP-AS-C36-JT-M

4750-PSTB-1

Pole Saws Set with 390 mm Coarse Cut Blade



ASP3740-C39JTC

1950 mm	2838 g	1	ASP3740-C39JTC

ASP-1850G

ASP-1850

ASP-AS-C39-JT-C

4750-PSTB-1

Pole Saws Set with 450 mm Coarse Cut Blade



ASP3740-C45JTC

1950 mm	2863 g	1	ASP3740-C45JTC

ASP-1850G

ASP-1850

ASP-AS-C45-JT-C

4750-PSTB-1

HEDGE SHEARS

Heavy Duty Lightweight Hedge Shears with Steel Handle



P51

570 mm	25 cm	2	P51-F

Heavy Duty Lightweight Hedge Shears with Aluminium Handle



P51-SL

570 mm	25 cm	2	P51-SL

Lightweight Precision Hedge Shears with Aluminium Handle



P54-SL

500 mm	18 cm	2	P54-SL-20
550 mm	22,5 cm	2	P54-SL-25

Precision Hedge Shears with Aluminium Handle



PG-56

540 mm	23 cm	2	PG-56-F

Heavy Duty Extra Long Lightweight Hedge Shears with Aluminium Handle



P51H-SL

730 mm	25 cm	2	P51H-SL

Long Lightweight Precision Hedge Shears with Aluminium Handle



P54H-SL

600 mm	18 cm	2	P54H-SL-20
650 mm	22,5 cm	2	P54H-SL-25

Expert Telescopic Hedge Shears with Aluminium Handle



PG-57-F

800-1050 mm	20 cm	2	PG-57-F

Heavy Duty Hedge Shears with Wooden Handle



P57-25

540 mm	23 cm	4	P57-25-F
540 mm	23 cm	4	P57-25-W-F

Lightweight Extra Precision Hedge Shears with Aluminium Handle



P52-SL-20

590 mm	18 cm	2	P52-SL-20

Universal Hedge Shears with Steel Handle



P59

580 mm	21 cm	6	P59-25-F



Spare Buffers for Hedge Shears



R440V-R516V

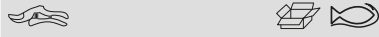

P14, P16, P180-70, P19-80, P160-60, P51	22	R515VS
P160, P160-SL, P280-SL	22	R516V
P53-SL, P54H-SL, P52-SL-20	22	R444V

Centre Bolt/Nut/Locking Ring Set for Hedge Shears



R146VC/R147V

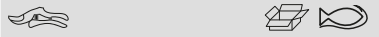

P51, P51H, P52, P53, P54, P52-SL-20	22	R146VC
P55, P57	24	R147V

GRASS SHEARS

3-Positions Grass Shears with Plastic Sleeve Handle



GS-76

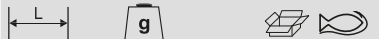

355 mm	435 g	8	GS-76
--------	-------	---	-------

Multi-Angle Grass Shear



GS-180



375 mm	317 g	6	GS-180-F
--------	-------	---	----------

Duck's Foot Grass Shears with Plastic Sleeve Handle 1100 mm



P74

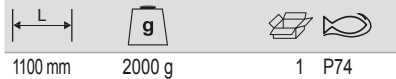

1100 mm	2000 g	1	P74
---------	--------	---	-----

Grass Shears with Plastic Sleeve Handle 1000 mm



P75



1000 mm	1900 g	1	P75
---------	--------	---	-----

PRUNING KNIVES

Foldable Grafting Knives with Plastic Handle



P11

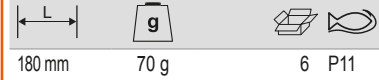

180 mm	70 g	6	P11
--------	------	---	-----

Foldable Pruning Knives with Plastic Handle



P20

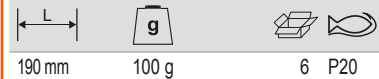

190 mm	100 g	6	P20
--------	-------	---	-----

Bow-Shaped Foldable Pruning Knives with Stainless Steel Handle



K-AP-1



90 g	10	K-AP-1
------	----	--------

Hook-Shaped Foldable Pruning Knives with Stainless Steel Handle



K-GP-1

90 g	10	K-GP-1

SCISSORS

Floral Scissor with Soft Touch Finger Loop - Small



FS-5

10	FS-5

Floral Scissor with Soft Touch Finger Loop - Medium



FS-8

10	FS-8

Floral Scissor with Soft Touch Finger Loop - Large



FS-7.5

10	FS-7.5

BOW SAWS

ERGO™ Heavy Duty Professional Bow Saws 21"-30"



10

530 mm	21 in	5	10-21-51
607 mm	24 in	5	10-24-23
607 mm	24 in	5	10-24-51
759 mm	30 in	5	10-30-23
759 mm	30 in	5	10-30-51

ERGO™ Pointed Heavy Duty Professional Bow Saws 21"



332

530 mm	21 in	5	332-21-51

General Purpose Bow Saws 21" to 36"



SE-15-16

530 mm	21 in	5	SE-16-21
530 mm	21 in	5	SE-16-21-23
607 mm	24 in	5	SE-15-24
759 mm	30 in	5	SE-15-30
759 mm	30 in	5	SE-15-30-23
810 mm	32 in	5	SE-15-32
912 mm	36 in	5	SE-15-36
912 mm	36 in	5	SE-15-36-23

Pointed Bow Saws for Dry Wood 21"



331-21

530 mm	21 in	5	331-21-51-KP

Pointed Bow Saws for Green Wood 15"



331-15

378 mm	15 in	5	331-15-23



General Purpose Bow Saws with Reversible Blade 24"



3-24-51

607 mm	24 in	5	3-24-51

Bow Saws for Ventilation Tubes 24"



14-24

607 mm	24 in	5	14-24-3810

Green Wood Spare Blades for Bow Saw 15"-36"



23

378 mm	13.33 in	10	23-15
530 mm	20.75 in	10	23-21
607 mm	24 in	10	23-24
759 mm	30 in	10	23-30
810 mm	28.57 in	10	23-32
912 mm	36 in	10	23-36

General Purpose Bow Saws with Reversible Blade 21"



2-21-51

530 mm	21 in	5	2-21-51

Toolbox-Sized Mini Bow Saw 12"



9-12

320 mm	12 in	5	9-12-51/3806-KP

Fine Peg Toothed Spare Blades for Bow Saw 14"



333-5

350 mm	13-3/4 in	10	333-5

General Purpose Bow Saws with Reversible Blade 14"



333

350 mm	14 in	5	333

Dry Wood Spare Blades for Bow Saw 12"-36"



51

320 mm	12-1/2 in	10	51-12
530 mm	20.75 in	10	51-21
607 mm	24 in	10	51-24
759 mm	30 in	10	51-30
810 mm	28.57 in	10	51-32
912 mm	36 in	10	51-36

PRUNING SAWS

Toothed Handheld Pruning Saws with Low Friction Blade



349

300 mm	7	4	349

Foldable Pruning Saws with Low Friction Blade



PG-72

190 mm	7	4	PG-72

Foldable Pruning Saws with Dual-Component Handle for Winter Pruning



396-JT

190 mm	7	4	396-JT

Handheld Pruning Saws with Dual-Component Handle and Holster for Green Branches Cutting



51-JS

240 mm	5	4	5124-JS-H
280 mm	5	4	5128-JS-H

Foldable Pruning Saws with Dual-Component Handle for Dry Wood/Plastic/Bone Cutting



396-LAP

190 mm	200 g	10	396-LAP
190 mm	44 g	100	396-BLADE
190 mm	44 g	1	396-BLADE-1P

Foldable Pruning Saws with Dual-Component Handle for Hard/Dry Wood Cutting



396-HP

190 mm	7	4	396-HP

Pruning Saws with Dual-Component Handle and Holster for Winter Pruning



41-JT

240 mm	7	4	4124-JT-H
280 mm	7	4	4128-JT-H

Foldable Pruning Saws with Dual-Component Handle for Green Branches Cutting



396-JS

190 mm	5	4	396-JS

4211 Hardpoint and 4212 Fileable Toothed Pruning Saws with Wooden Handle



4211-4212-

280 mm	6	4	4211-11-6T
360 mm	6	4	4211-14-6T
280 mm	6	4	4212-11-6T
360 mm	6	4	4212-14-6T

Foldable Saw and Knife Laplander Set with Dual-Component Handle



LAP-KNIFE

329 g	10	LAP-KNIFE

396-LAP
2444-LAP



Spare Blades for 51-JS Pruning Saws



5724-JS/5728-JS

240 mm	5	1	5724-JS
280 mm	5	1	5728-JS

Spare Blades for 41-JT Pruning Saws



4724-JT/4728-JT

240 mm	7	1	4724-JT
280 mm	7	1	4728-JT

Spare Blades for 396-JS Pruning Saws



396-JS-BLADE

190 mm	5	300	396-JS-BLADE

Spare Blades for 396-JT Pruning Saws



396-JT-BLADE

190 mm	7	300	396-JT-BLADE

Spare Blades for 396-HP Pruning Saws



396-HP-BLADE

190 mm	7	300	396-HP-BLADE

Spare Blades for 4211/4212/339/340 Pruning Saws



4400-/4420-

280 mm	6	10	4400-11
360 mm	6	10	4400-14
280 mm	6	10	4420-11
360 mm	6	10	4420-14
280 mm	6	10	4400-11-BULK
360 mm	6	10	4400-14-BULK
280 mm	6	10	4420-11-BULK
360 mm	6	10	4420-14-BULK

SPARE PARTS & ACCESSORIES

Spare Fine Cut Curved Blades for Pole Saws



AS-F-BLADE

330 mm	7	15	AS-C33-JT-F

Spare Medium Cut Curved Blades for Pole Saws



AS-M-BLADE

360 mm	6.2	15	AS-C36-JT-M

Spare Coarse Cut Curved Blades for Pole Saws



AS-C-C-BLADE

390 mm	5.4	15	AS-C39-JT-C
450 mm	5.4	15	AS-C45-JT-C

Transport Bags for Pole Sections



4750-PSTB-1

1910 mm	1040 g	1	4750-PSTB-1

ACCESSORIES & MAINTENANCE

Synthetic Grinding Stones 180/400 Grain



LS-COMBINESS



100 mm



1 LS-COMBINESS

Synthetic Grinding Stones 320 Grain



LS-CORINDON



100 mm



1 LS-PIERRE CORINDON

Grinding Stones and Carbide Sharpener with Dual-Component Handle



SHARP-X



100 mm

100 mm



10 SHARP-X
1 SHARP-X-DISP

Synthetic Grinding Stones 180 Grain



LS-PIERRE-FAUX



230 mm



1 LS-PIERRE-FAUX

Carbor Type Synthetic Grinding Stones 220 Grain



LS-6160-23



230 mm



1 LS-6160-23

Lubricants 50 ml Spray Bottle



LUB-2015



60 g



6 LUB-2015

Leather Secateurs Holsters



PROF-H



86 g



2 PROF-H

Nylon Lopper Holsters



PROF-LOPP



390 g



1 PROF-LOPP

Nylon Secateurs Holsters



PROF-SEC



150 g



1 PROF-SEC



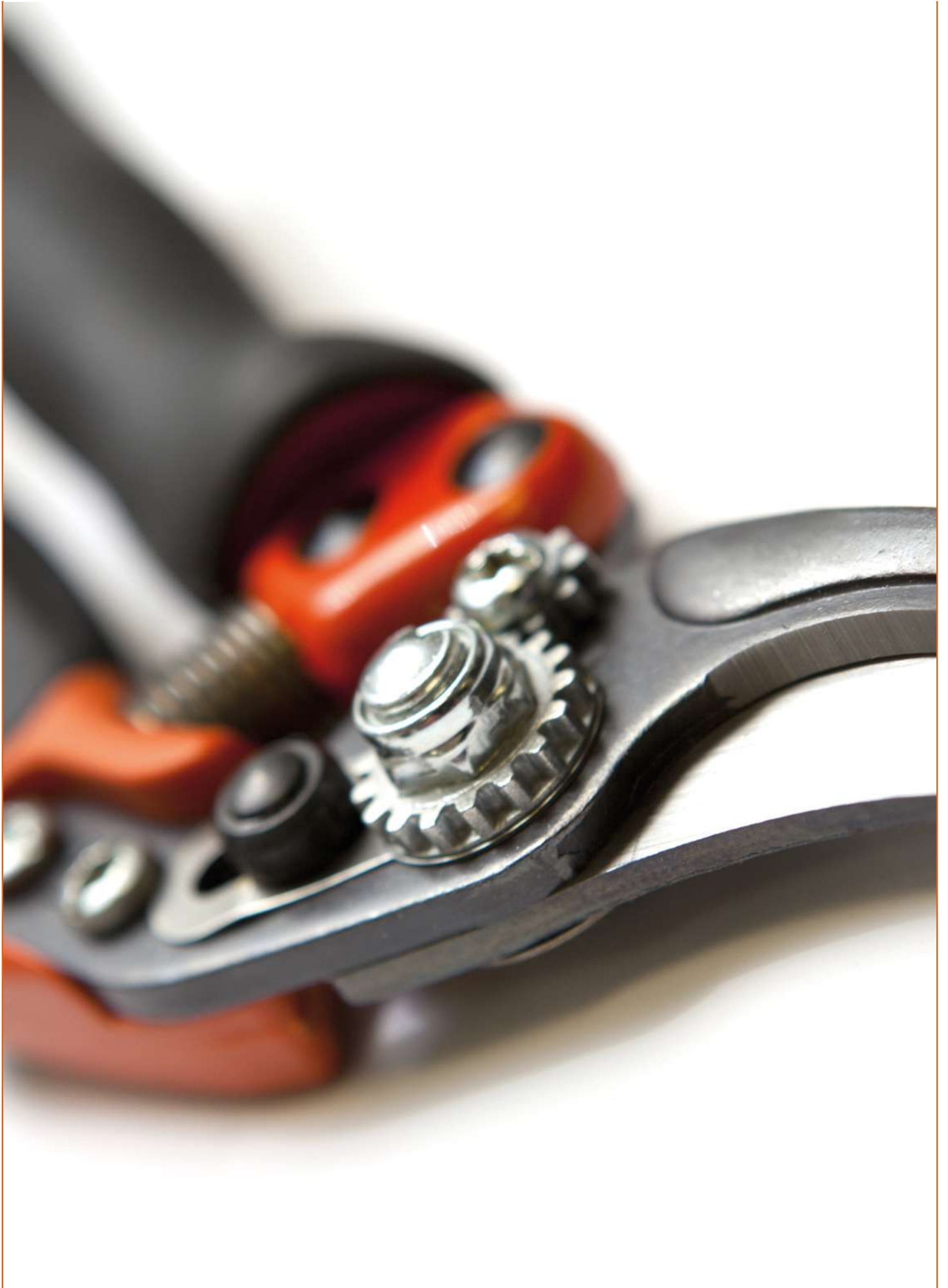

BAHCO



Air Tools Outdoor



SECATEURS

Professional Air Secateurs with Single Cutting Blade



9210



30 mm



1 9210

Pack of Assorted O-Rings for 9210 Air Secateurs



9210-20



28 g



1 9210-20

Piston Discs for 9210 Air Secateurs



9210-1690148



22 g



1 9210-1690148

Cutting Blades and Rivets for 9210 Air Secateurs



9210-1



9210



82 g



1 9210-1

Brass Sleeves for 9210 Air Secateurs - 10 Pcs



9210-1720100



55.3 g



1 9210-1720100

Shock Absorbers for 9210 Air Secateurs



9210-1730107



176 g



10 9210-1730107

Complete Pre-Assembled Cutting Heads for 9210 Air Secateurs



9210-10



9210



212 g



1 9210-10

Piston Seals for 9210 Air Secateurs



9210-1230235



6.7 g



1 9210-1230235

Return Springs for 9210 Air Secateurs



9210-1640142



26.6 g



1 9210-1640142

Connecting Rods for 9210 Air Secateurs



9210-1700118

9210	41 g	1	9210-1700118

TSP 2.2 mm x 6.5 mm Self Tapping Screws for 9210 Air Secateurs



9210-1060238

9210	10 g	20	9210-1060238

TCCE M6 x 20 mm Screws for 9210 Air Secateurs



9210-1060177

9210	7 g	1	9210-1060177

Special Rivets for 9210 Air Secateurs



9210-1770106

9210	1000 g	10	9210-1770106

Front Covers for 9210 Air Secateurs



9210-1830137

9210	9.5 g	1	9210-1830137

Hand Guards for 9210 Air Secateurs



9210-1320281

9210	35 g	10	9210-1320281

Dust Protection Seals for 9210 Air Secateurs



9210-1230219

9210	8.6 g	20	9210-1230219

Secateurs Body with Brass Cylinder for 9210 Air Secateurs



9210-1710266

9210	193 g	1	9210-1710266





BAHCO



1-100-04-1-0	7311518019006	10	22
1-100-04-1-2	7311518244125	5	22
1-100-04-2-0	7311518019013	10	22
1-100-04-2-2	7311518244132	5	22
1-100-04-3-0	7311518019020	10	22
1-100-06-1-0	7311518019037	10	22
1-100-06-1-2	7311518000233	5	22
1-100-06-2-0	7311518019044	10	22
1-100-06-2-2	7311518003593	5	22
1-100-06-3-0	7311518019051	10	22
1-100-06-3-2	7311518293581	5	22
1-100-08-1-0	7311518019068	10	22
1-100-08-1-2	7311518000264	5	22
1-100-08-2-0	7311518019075	10	22
1-100-08-2-2	7311518003609	5	22
1-100-08-3-0	7311518019082	10	22
1-100-08-3-2	7311518295585	5	22
1-100-10-1-0	7311518019099	10	22
1-100-10-1-2	7311518000295	5	22
1-100-10-2-0	7311518019105	10	22
1-100-10-2-2	7311518003616	5	22
1-100-10-3-0	7311518019112	10	22
1-100-10-3-2	7311518295592	5	22
1-100-12-1-0	7311518019129	5	22
1-100-12-1-2	7311518028053	5	22
1-100-12-2-0	7311518019136	5	22
1-100-12-2-2	7311518244118	5	22
1-100-12-3-0	7311518019143	5	22
1-100-12-3-2	7311518295608	5	22
1-100-14-1-0	7311518019150	5	22
1-100-14-2-0	7311518019167	5	22
1-102-06-2-0	7311518019198	10	22
1-102-06-3-0	7311518019204	10	22
1-102-08-1-0	7311518019211	10	22
1-102-08-2-0	7311518019228	10	22
1-102-08-3-0	7311518019235	10	22
1-104-10-2-0	7311518019242	10	22
1-104-10-3-0	7311518019259	10	22
1-104-12-2-0	7311518019266	5	22
1-104-12-3-0	7311518019273	5	22
1-104-14-3-0	7311518019297	5	22
1-106-08-1-0	7311518019303	10	22
1-106-08-1-2	7311518000301	5	22
1-106-10-1-0	7311518019310	10	22
1-106-10-1-2	7311518000325	5	22
1-106-12-1-0	7311518019327	5	22
1-106-12-1-2	7311518295615	5	22
1-110-04-1-0	7311518019334	10	22
1-110-04-2-0	7311518019341	10	22
1-110-04-3-0	7311518044046	10	22
1-110-06-1-0	7311518019358	10	22
1-110-06-1-2	7311518295622	5	23
1-110-06-2-0	7311518019365	10	22
1-110-06-2-2	7311518003623	5	23
1-110-06-3-0	7311518019372	10	22
1-110-06-3-2	7311518295639	5	23
1-110-08-1-0	7311518019389	10	22
1-110-08-1-2	7311518000332	5	23
1-110-08-2-0	7311518019396	10	22
1-110-08-2-2	7311518003630	5	23
1-110-08-3-0	7311518019402	10	22
1-110-08-3-2	7311518295646	5	23
1-110-10-1-0	7311518019419	10	22
1-110-10-1-2	7311518000349	5	23
1-110-10-2-0	7311518019426	10	22
1-110-10-2-2	7311518003647	5	23
1-110-10-3-0	7311518019433	10	22
1-110-10-3-2	7311518295653	5	23
1-110-12-1-0	7311518019440	5	22
1-110-12-1-2	7311518295660	5	23
1-110-12-2-0	7311518019457	5	22
1-110-12-2-2	7311518295677	5	23
1-110-12-3-0	7311518019464	5	22
1-110-12-3-2	7311518295684	5	23
1-110-14-1-0	7311518019488	5	22
1-111-04-1-0	7311518044053	10	23
1-111-04-2-0	7311518019518	10	23
1-111-04-3-0	7311518019525	10	23
1-111-06-1-0	7311518019549	10	23
1-111-06-2-0	7311518019556	10	23
1-111-06-2-2	7311518000363	5	23
1-111-06-3-0	7311518019563	10	23
1-111-08-1-0	7311518019570	10	23
1-111-08-2-0	7311518019587	10	23
1-115-11-3-1	7311518003791	10	23
1-143-04-1-0	7311518105983	10	23
1-143-06-1-0	7311518019631	10	23
1-143-06-1-2	7311518022341	5	23
1-143-08-1-0	7311518019662	10	23
1-143-08-1-2	7311518028077	5	23
1-143-10-1-0	7311518019693	10	23
1-143-10-1-2	7311518022358	5	23
1-143-12-1-0	7311518019723	5	23
1-143-12-1-2	7311518295691	5	23
1-160-04-1-0	7311518019785	10	25
1-160-04-1-2	7311518244057	5	25



1-160-04-2-0	7311518019792	10	25
1-160-04-2-2	7311518244095	5	25
1-160-04-3-0	7311518019808	10	25
1-160-06-1-0	7311518019815	10	25
1-160-06-1-2	7311518000370	5	25
1-160-06-2-0	7311518019822	10	25
1-160-06-2-2	7311518003685	5	25
1-160-06-3-0	7311518019839	10	25
1-160-06-3-2	7311518295707	5	25
1-160-08-1-0	7311518019846	10	25
1-160-08-1-2	7311518000394	5	25
1-160-08-2-0	7311518019853	10	25
1-160-08-2-2	7311518003692	5	25
1-160-08-3-0	7311518019860	10	25
1-160-08-3-2	7311518295714	5	25
1-160-10-1-0	7311518019877	10	25
1-160-10-1-2	7311518000400	5	25
1-160-10-2-0	7311518019884	10	25
1-160-10-2-2	7311518295721	5	25
1-160-10-3-0	7311518019891	10	25
1-160-10-3-2	7311518295738	5	25
1-160-12-1-0	7311518019907	5	25
1-160-12-1-2	7311518295745	5	25
1-160-12-2-0	7311518019914	5	25
1-160-12-2-2	7311518295752	5	25
1-160-12-3-0	7314150292059	5	25
1-160-12-3-2	7311518298005	5	25
1-170-04-1-0	7311518044060	10	24
1-170-04-2-0	7311518019945	10	24
1-170-04-2-2	7311518244088	5	24
1-170-04-3-0	7311518019952	10	24
1-170-06-1-0	7311518019969	10	24
1-170-06-1-2	7311518244071	5	24
1-170-06-2-0	7311518019976	10	24
1-170-06-2-2	7311518003715	5	24
1-170-06-3-0	7311518019983	10	24
1-170-06-3-2	7311518295769	5	24
1-170-08-1-0	7311518019990	10	24
1-170-08-1-2	7311518000417	5	24
1-170-08-2-0	7311518020002	10	24
1-170-08-2-2	7311518003722	5	24
1-170-08-3-0	7311518020019	10	24
1-170-08-3-2	7311518295783	5	24
1-170-10-1-0	7311518020026	10	24
1-170-10-1-2	7311518028107	5	24
1-170-10-2-0	7311518020033	10	24
1-170-10-2-2	7311518244064	5	24
1-170-10-3-0	7311518020040	10	24
1-170-10-3-2	7311518295806	5	24
1-170-12-1-0	7311518020057	5	24
1-170-12-2-0	7311518020064	5	24
1-210-04-1-0	7311518020071	10	24
1-210-04-1-2	7311518243944	5	24
1-210-04-2-0	7311518020088	10	24
1-210-04-2-2	7311518244040	5	24
1-210-04-3-0	7311518020095	10	24
1-210-06-1-0	7311518020101	10	24
1-210-06-1-2	7311518000424	5	24
1-210-06-2-0	7311518020118	10	24
1-210-06-2-2	7311518003654	5	24
1-210-06-3-0	7311518020125	10	24
1-210-06-3-2	7311518293574	5	24
1-210-08-1-0	7311518020132	10	24
1-210-08-1-2	7311518000455	5	24
1-210-08-2-0	7311518020149	10	24
1-210-08-2-2	7311518000479	5	24
1-210-08-3-0	7311518020156	10	24
1-210-08-3-2	7311518295837	5	24
1-210-10-1-0	7311518020163	10	24
1-210-10-1-2	7311518000493	5	24
1-210-10-2-0	7311518020170	10	24
1-210-10-2-2	7311518003661	5	24
1-210-10-3-0	7311518020187	10	24
1-210-10-3-2	7311518295844	5	24
1-210-12-1-0	7311518020194	5	24
1-210-12-1-2	7311518028121	5	24
1-210-12-2-0	7311518020200	5	24
1-210-12-2-2	7311518244149	5	24
1-210-12-3-0	7311518020217	5	24
1-210-12-3-2	7311518295851	5	24
1-210-14-1-0	7311518020224	5	24
1-230-04-1-0	7311518020248	10	24
1-230-04-1-2	7311518244163	5	24
1-230-04-2-0	7311518020255	10	24
1-230-04-2-2	7311518244156	5	24
1-230-04-3-0	7311518020262	10	24
1-230-06-1-0	7311518020279	10	24
1-230-06-1-2	7311518000509	5	24
1-230-06-2-0	7311518020286	10	24
1-230-06-2-2	7311518000523	5	24
1-230-06-3-0	7311518020293	10	24
1-230-06-3-2	7311518293567	5	24
1-230-08-1-0	7311518020309	10	24
1-230-08-1-2	7311518000547	5	24
1-230-08-2-0	7311518020316	10	24
1-230-08-2-2	7311518000554	5	24





1-230-08-3-0	7311518020323	10	24
1-230-08-3-2	7311518295882	5	24
1-230-10-1-0	7311518020330	10	24
1-230-10-1-2	7311518000578	5	24
1-230-10-2-0	7311518020347	10	24
1-230-10-2-2	7311518003678	5	24
1-230-10-3-0	7311518020354	10	24
1-230-10-3-2	7311518295899	5	24
1-230-12-1-0	7311518020361	5	24
1-230-12-1-2	7311518295912	5	24
1-230-12-2-0	7311518020378	5	24
1-230-12-2-2	7311518295929	5	24
1-230-12-3-0	7311518020385	5	24
1-230-12-3-2	7311518295905	5	24
1-320-08-2-0	7311518191276	10	23
1-320-08-2-2	7311518270865	5	23
1-320-10-2-0	7311518020477	10	23
1-320-10-2-2	7311518270872	5	23
1-320-12-2-0	7311518020484	5	23
1-320-12-2-2	7311518270889	5	23
1-473-06-2-2	7311518201098	5	25
1-473-08-2-2	7311518201104	5	25
1-473-10-2-2	7311518201111	5	25
1-476-04-3-2	7311518010928	1	25
1-477-08-2-2	7311518037994	5	25
1-477-10-2-2	7311518201074	5	26
1-478-08-1-2	7311518141127	5	26
1-478-10-1-2	7311518241995	5	26
1-479-08-1-2	7311518176747	5	26
1-479-08-2-2	7311518180607	5	26
10-21-51	7311518229344	5	647
10-24-23	7311518229368	5	647
10-24-51	7311518229351	5	647
10-30-23	7311518229382	5	647
10-30-51	7311518229375	5	647
1016	7314150218189	10	217
1019	8412814010199	10	217
1031-10	7314150025442	5	585
1031-12	7314150025459	5	585
1031-14	7314150025466	5	585
1031-16	7314150025473	5	585
1031-18	7314150025480	5	585
1031-20	7314150025497	5	585
1031-22	7314150025503	5	585
1031-25	7314150025510	5	585
1031-28	7314150025527	5	585
1031-30	7314150025534	5	585
1031-32	7314150025541	5	585
1031-4	7314150025411	5	585
1031-40	7314150025558	5	585
1031-6	7314150025428	5	585
1031-8	7314150025435	5	585
1067	8412814010670	10	217
1084	7311518277291	5	270
1084-KIT	7314150336944	1	271
10RM-10	7314153014351	1	45
10RM-13	7314153014368	1	45
10RM-14	7314150221677	1	45
10RM-17	7314153014375	1	45
10RM-19	7314153014382	1	45
10RM-8	7314153014344	1	45
10RM/SH6	7314150222971	1	46
10RZ-1/2	7314150358786	1	45
10RZ-11/16	7314150358816	1	45
10RZ-3/4	7314150358823	1	45
10RZ-3/8	7314150358762	1	45
10RZ-5/16	7314150358748	1	45
10RZ-5/8	7314150358809	1	45
10RZ-7/16	7314150358779	1	45
10RZ-9/16	7314150358793	1	45
111M-10	7314151828653	10	40
111M-100	7314150401499	1	40
111M-11	7314151828660	10	40
111M-12	7314151828677	10	40
111M-13	7314151828684	10	40
111M-14	7314151828691	10	40
111M-15	7314151828707	10	40
111M-16	7314151828714	10	40
111M-17	7314151828721	10	40
111M-18	7314151828738	10	40
111M-19	7314151828745	10	40
111M-20	7314151828752	10	40
111M-21	7314151828769	10	40
111M-22	7314151828776	5	40
111M-23	7314151828783	5	40
111M-24	7314151828790	5	40
111M-25	7314151828806	5	40
111M-26	7314151828813	5	40
111M-27	7314151828820	5	40
111M-28	7314151828837	5	40
111M-29	7314151828844	5	40
111M-30	7314151828851	5	40
111M-32	7314151828868	5	40
111M-33	7314150222223	5	40
111M-34	7314151828875	5	40
111M-36	7314150135516	1	40



111M-38	7314150222230	1	40
111M-41	7314150135523	1	40
111M-46	7314150135530	1	40
111M-5.5	7314151828608	10	40
111M-50	7314150135547	1	40
111M-55	7314150135554	1	40
111M-6	7314151828615	10	40
111M-60	7314150135561	1	40
111M-65	7314150135578	1	40
111M-7	7314151828622	10	40
111M-70	7314150135585	1	40
111M-75	7314150135592	1	40
111M-8	7314151828639	10	40
111M-80	7314150135608	1	40
111M-85	7314150352999	1	40
111M-9	7314151828646	10	40
111M-90	7314150401475	1	40
111M-95	7314150401482	1	40
111M/11T	7314151828899	1	42
111M/14T	7314151828905	1	42
111M/17T	7314151828912	1	42
111M/17TL	7314150197859	1	42
111M/24T	7314150197866	1	42
111M/26T	7314151828929	1	42
111M/S10	7314150212965	1	42
111M/SH12	7314153013347	1	41
111M/SH5	7314150325252	1	41
111M/SH8	7314150197873	1	41
111Z-1	7314151829063	3	41
111Z-1.11/16	7314151829070	5	41
111Z-1.1/2	7314150135752	1	41
111Z-1.1/4	7314151829094	5	41
111Z-1.1/8	7314151829087	5	41
111Z-1.11/16	7314150135615	1	41
111Z-1.13/16	7314150135639	1	41
111Z-1.3/4	7314150135622	1	41
111Z-1.3/8	7314150135738	1	41
111Z-1.5/16	7314151829100	5	41
111Z-1.5/8	7314150135769	1	41
111Z-1.7/16	7314150135745	1	41
111Z-1.7/8	7314150135646	1	41
111Z-1/2	7314151828981	5	41
111Z-1/4	7314151828943	5	41
111Z-11/16	7314151829018	5	41
111Z-13/16	7314151829032	5	41
111Z-15/16	7314151829056	3	41
111Z-2	7314150135653	1	41
111Z-2.1/2	7314150135721	1	41
111Z-2.1/4	7314150135691	1	41
111Z-2.1/8	7314150135677	1	41
111Z-2.3/4	7314150135783	1	41
111Z-2.3/8	7314150135707	1	41
111Z-2.5/8	7314150135776	1	41
111Z-2.7/8	7314150135790	1	41
111Z-3	7314150135806	1	41
111Z-3/4	7314151829025	5	41
111Z-3/8	7314151828967	5	41
111Z-5/16	7314151828950	5	41
111Z-5/8	7314151829001	5	41
111Z-7/16	7314151828974	5	41
111Z-7/8	7314151829049	5	41
111Z-9/16	7314151828998	5	41
111Z/11T	7314151829124	1	43
111Z/8T	7314151829117	1	42
1150-1/2H/P	7314150129263	1	559
1150D	7311518276614	1	559
1154	7314150249831	1	326
1154-DG	7314150249800	1	326
1154-MB	7314150249817	1	326
1157	7311518277031	60	620
1162N-1/2	7314151847241	1	552
1177-SCRIBE	7314150120550	5	557
1178-SCRIBE	7314150120567	5	557
1179-FLX	7311518276997	25	557
1179-SCRIBE	7314150120574	5	557
1179-TIPS	7314150120581	1	557
11M-10	7314151829155	5	43
11M-11	7314151829162	5	43
11M-12	7314151829179	5	43
11M-13	7314151829186	5	43
11M-14	7314151829193	5	43
11M-15	7314151829209	5	43
11M-16	7314151829216	5	43
11M-17	7314151829223	5	43
11M-18	7314151829230	5	43
11M-19	7314151829247	5	43
11M-21	7314151829254	5	43
11M-22	7314151829261	5	43
11M-24	7314151829278	5	43
11M-27	7314151829285	1	43
11M-30	7314151829292	1	43
11M-32	7314151829308	1	43
11M-36	7314151829315	1	43
11M-38	7314151829322	1	43
11M-8	7314151829131	5	43
11M-9	7314151829148	5	43

Part Number	Quantity	Part Number	Quantity
11Z-1	5	7314150355303	43
11Z-1/2	5	7314150355235	43
11Z-11/16	5	7314150355266	43
11Z-13/16	5	7314150355280	43
11Z-3/4	5	7314150355273	43
11Z-3/8	5	7314150355211	43
11Z-5/8	5	7314150355259	43
11Z-7/16	5	7314150355228	43
11Z-9/16	5	7314150355242	43
1300Z-1-1.1/8	1	7314153000989	52
1300Z-1/4-5/16	1	7314153000965	52
1300Z-15/16-1	1	7314153005656	52
1300Z-19/32-11/16	1	7314151040000	52
1300Z-25/32-13/16	1	7314153000972	52
1300Z-3/8-7/16	1	7314151039981	52
1300Z-5/8-3/4	1	7314151040017	52
1300Z-7/8-15/16	1	7314153005649	52
1320RM-10-11	1	7314153014511	47
1320RM-12-13	1	7314153014528	47
1320RM-14-15	1	7314153014535	47
1320RM-16-17	1	7314153014542	47
1320RM-17-19	1	7314150359196	47
1320RM-18-19	1	7314153014559	47
1320RM-22-24	1	7314150221646	47
1320RM-6-7	1	7314153014498	47
1320RM-8-9	1	7314153014504	47
1320RM/SH8	1	7314150222988	47
1320RZ-1/2-9/16	1	7314153014580	47
1320RZ-1/4-5/16	1	7314153014566	47
1320RZ-3/4-13/16	1	7314150359264	47
1320RZ-3/4-7/8	1	7314150359271	47
1320RZ-3/8-7/16	1	7314153014573	47
1320RZ-5/16-11/32	60	7314153015235	47
1320RZ-5/8-11/16	1	7314150359257	47
1320RZ-7/8-15/16	1	7314150359288	47
1320SRM-14-19	1	7314150190355	47
1320SRM/S29	1	7314150188673	47
1321RZ-1/2-9/16	1	7314150359349	47
1321RZ-3/4-7/8	1	7314150359363	47
1321RZ-3/8-7/16	1	7314150359332	47
1321RZ-5/8-11/16	1	7314150359356	47
133SGM-100	1	7314151828523	55
133SGM-105	1	7314151828530	55
133SGM-110	1	7314151828547	55
133SGM-115	1	7314151828554	55
133SGM-120	1	7314151828561	55
133SGM-27	1	7314151828363	55
133SGM-30	1	7314151828370	55
133SGM-32	1	7314151828387	55
133SGM-36	1	7314151828394	55
133SGM-41	1	7314151828400	55
133SGM-46	1	7314151828417	55
133SGM-50	1	7314151828424	55
133SGM-55	1	7314151828431	55
133SGM-60	1	7314151828448	55
133SGM-65	1	7314151828455	55
133SGM-70	1	7314151828462	55
133SGM-75	1	7314151828479	55
133SGM-80	1	7314151828486	55
133SGM-85	1	7314151828493	55
133SGM-90	1	7314151828509	55
133SGM-95	1	7314151828516	55
14-24-3810	5	7311518002879	648
140	1	7314150008797	266
141	1	7314150008827	266
1410	1	7314150106332	266
1410D	1	7314150452842	266
1418-4	1	7314150510863	372
1418-5	1	7314150510870	372
1418-6	1	7314150510887	372
1418-7.5	1	7314150510894	372
1418-8.5	1	7314150510900	372
1418S	1	7314151040604	372
1419-M12	1	7314150257423	371
1419-M16	1	7314150358045	371
1419-M5	1	7314150257409	371
1419-M8	1	7314150257416	371
1419-MD	1	7311518277352	343
1419/4	1	7314150125036	371
142	1	7314150008841	266
1420	1	7314150103744	266
1420-1.4	1	7314151696337	371
1420D	1	7314150452859	266
1421-2.1	1	7314151696412	371
1422-3.1	1	7314151696689	371
1423-4.8	1	7314151696764	371
1424-6.2	1	7314151696849	371
143	1	7314150008872	266
1430FT120	1	7314150342006	384
1435/5	1	7314151040734	371
1435/8	1	7314151040741	371
144	1	7314150008902	266
1446	15	7314150128631	599
1446-CS	15	7314150508266	599
1446-FLOAT	15	7314150438464	599
1446-OV	15	7314150313679	599

Part Number	Quantity	Part Number	Quantity
1450D-ISO	1	7314151040970	374
1450D-VVV	1	7314151040987	374
1450D/2	1	7314151040963	374
1460M/1	1	7314151041090	373
1460M/2	1	7314151041106	374
1460Z/2	1	7314151041120	374
1467-250	1	7314150124268	263
1467-320-850	1	7314150178636	263
1467-520	1	7314150124275	263
1467-B14	1	7314150301645	263
1467-L3.2	1	7314150209071	263
1467-L4	1	7314150209057	263
1467-L5	1	7314150209040	263
1467-L6	1	7314150209064	263
1467-L6.4	1	7314150209088	263
1467-LJ	1	7314150209033	263
1467-S2.4	1	7314150209026	263
1467-S3.2	1	7314150209019	263
1467-S4	1	7314150209002	263
1467-S5	1	7314150208999	263
1467-SJ	1	7314150208982	263
1468-10-1	1	7314150342471	350
1468-10M10	1	7314150243457	349
1468-10M4	1	7314150243419	349
1468-10M5	1	7314150243426	349
1468-10M6	1	7314150243433	349
1468-10M8	1	7314150243440	349
1468-6M3	1	7314150243372	349
1468-6M4	1	7314150243389	349
1468-6M5	1	7314150243396	349
1468-6M6	1	7314150243402	349
1468-M10	1	7314150243228	349
1468-M6	1	7314150243211	349
147	1	7314150008933	266
147-1	1	7314150367047	119
147-1.1/4	1	7314150367061	119
147-1.1/8	1	7314150367054	119
147-1/2	1	7314150366965	119
147-11/16	1	7314150366996	119
147-13	1	7314150366644	118
147-13/16	1	7314150367016	118
147-14	1	7314150366651	118
147-15	1	7314150366668	118
147-15/16	1	7314150367030	119
147-16	1	7314150366675	118
147-17	1	7314150366682	118
147-18	1	7314150366699	118
147-19	1	7314150366705	118
147-21	1	7314150366712	118
147-22	1	7314150366729	118
147-24	1	7314150366736	118
147-25	1	7314150366743	118
147-27	1	7314150366750	118
147-3/4	1	7314150367009	119
147-30	1	7314150366767	118
147-32	1	7314150366774	118
147-33	1	7314150366781	118
147-34	1	7314150366798	118
147-35	1	7314150366804	118
147-36	1	7314150366811	118
147-37	1	7314150366828	118
147-38	1	7314150366835	118
147-39	1	7314150366842	118
147-41	1	7314150366859	118
147-45	1	7314150366866	118
147-46	1	7314150366873	119
147-5/8	1	7314150366989	119
147-50	1	7314150366880	119
147-55	1	7314150366897	119
147-60	1	7314150366903	119
147-68	1	7314150366910	119
147-7/16	1	7314150366958	119
147-7/8	1	7314150367023	119
147-70	1	7314150366927	119
147-75	1	7314150366934	119
147-9/16	1	7314150366972	119
147-90	1	7314150366941	119
1470K-AC1	1	7314150226498	382
1470K-AC2	1	7314150226504	382
1470K-AC3	1	7314150226511	382
1470K-AC4	1	7314150226528	382
1470K-AC7	1	7314150271320	382
1470K-AC8	1	7314150328581	383
1470K-AC8GR	1	7314150328598	383
1470K-ACSIDE	1	7314150226535	382
1470K-ACTD	1	7314150297269	383
1470K-ACTSS	1	7314150297283	383
1470K-ACTW	1	7314150297276	383
1470K7LH	1	7314150360444	380
1470K7LHBLUE	1	7314150407491	380
1470K7LHGREY	1	7314150407767	380
1470K7LHRED	1	7314150407507	380
1470K7SS	1	7314150343287	538
1470KAC01	1	7314150165124	383
1470KC2	1	7314150226696	384
1470KC3A	1	7314150506354	384



1470KC5



1470KC5	7314150226665	1	384
1470KC5PC	7314150226672	1	384
1470KCTRAY	7314150226702	1	384
1470KXL-ACTD	7314150297290	1	383
1470KXL-ACTSS	7314150297313	1	383
1470KXL-ACTW	7314150297306	1	383
1470KXLC-TRAY	7314150285549	1	383
1471KXXL12BKTSS	7314150365432	1	381
1472K-ACTD	7314150399345	1	380
1472K-ACTSS	7314150399338	1	380
1472K-ACTW	73141503993152	1	380
1472K5	7314150349463	1	376
1472K5BLACK	7314150349500	1	376
1472K5BLUE	7314150349616	1	376
1472K5GREY	7314150403813	1	376
1472K5RED	7314150349562	1	376
1472K5WHITE	7314150403707	1	376
1472K6	7314150349470	1	376
1472K6BLACK	7314150349531	1	376
1472K6BLUE	7314150349623	1	376
1472K6GREY	7314150403820	1	376
1472K6RED	7314150349579	1	376
1472K6WHITE	7314150399888	1	376
1472K7	7314150349487	1	376
1472K7BLACK	7314150349548	1	376
1472K7BLUE	7314150349630	1	376
1472K7GREY	7314150403837	1	376
1472K7RED	7314150349586	1	376
1472K7WHITE	7314150403714	1	376
1472K8	7314150349494	1	376
1472K8BLACK	7314150349555	1	376
1472K8BLUE	7314150349647	1	377
1472K8GREY	7314150404018	1	377
1472K8RED	7314150349593	1	377
1472K8WHITE	7314150403721	1	377
1475K-ACSIDE	7314150419968	1	383
1475K6	7314150349654	1	380
1475K6BLACK	7314150349685	1	380
1475K6BLUE	7314150349760	1	380
1475K6RED	7314150349715	1	380
1475K7	7314150349661	1	381
1475K7BLACK	7314150349692	1	381
1475K7BLUE	7314150349814	1	381
1475K7RED	7314150349746	1	381
1475K8	7314150349678	1	381
1475K8BLACK	7314150349708	1	381
1475K8BLUE	7314150349821	1	381
1475K8RED	7314150349753	1	381
1475KXL-AC20BK	7314150353903	1	383
1475KXL12	7314150350223	1	381
1475KXL12BLACK	7314150350230	1	381
1475KXL12RED	7314150402731	1	381
1475KXL6	7314150349968	1	381
1475KXL6BLACK	7314150349999	1	381
1475KXL6BLUE	7314150350162	1	381
1475KXL6C	7314150350193	1	381
1475KXL6CBK-FF5	7314150437467	1	435
1475KXL6CBK-FF6	7314150437474	1	435
1475KXL6CBLACK	7314150350209	1	381
1475KXL6RED	7314150350124	1	381
1475KXL7	7314150349975	1	381
1475KXL7BLACK	7314150350070	1	381
1475KXL7BLUE	7314150350179	1	381
1475KXL7RED	7314150350148	1	381
1475KXL7SS	7314150349517	1	538
1475KXL8	7314150349982	1	381
1475KXL8BLACK	7314150350094	1	381
1475KXL8BLUE	7314150350186	1	381
1475KXL8RED	7314150350155	1	381
1475KXXL-ACTSS	7314150459896	1	383
1475KXXL-ACTW	7314150465330	1	383
1475KXXL8CWTSS	7314150400157	1	381
1476KXXL7BK	7314150439935	1	382
1477K-AC10	7314150353163	1	379
1477K-AC11	7314150369874	1	378
1477K-AC12	7314150369195	1	377
1477K-AC13	7314150369218	1	377
1477K-AC14	7314150369225	1	377
1477K-AC15	7314150369249	1	378
1477K-AC16	7314150369256	1	378
1477K-AC17	7314150369270	1	378
1477K-AC18	7314150369287	1	378
1477K-AC19	7314150369676	1	378
1477K-AC20	7314150369683	1	378
1477K-AC21	7314150370412	1	379
1477K-AC22	7314150369706	1	379
1477K-AC23	7314150369867	1	380
1477K-AC24	7314150370429	1	379
1477K-AC25	7314150370436	1	379
1477K-AC26	7314150414864	1	379
1477K-AC28	7314150370481	1	378
1477K-AC29	7314150370498	1	378
1477K-AC30	7314150469949	1	379
1477K-ACTD	7314150370474	1	380
1477K-ACTP	7314150383764	1	380
1477K-ACTSS	7314150370450	1	379



1477K-ACTW	7314150370467	1	379
1477K6	7314150350391	1	376
1477K6BLACK	7314150351091	1	376
1477K6GREY	7314150351138	1	376
1477K6RED	7314150403653	1	376
1477K6WHITE	7314150358137	1	376
1477K7	7314150350407	1	376
1477K7BLACK	7314150351107	1	376
1477K7GREY	7314150351145	1	376
1477K7RED	7314150403660	1	376
1477K7WHITE	7314150358144	1	376
1477K8	7314150350414	1	376
1477K8BLACK	7314150351114	1	376
1477K8GREY	7314150351183	1	376
1477K8RED	7314150403677	1	376
1477K8WHITE	7314150358151	1	376
1477K9	7314150350940	1	376
1477K9BLACK	7314150351121	1	376
1477K9GREY	7314150351190	1	376
1477K9RED	7314150403684	1	376
1477K9WHITE	7314150403691	1	376
148-1	7314150367801	1	120
148-1/2	7314150367726	1	120
148-11/16	7314150367757	1	120
148-13	7314150367559	1	119
148-13/16	7314150367771	1	120
148-14	7314150367566	1	119
148-15	7314150367573	1	119
148-15/16	7314150367795	1	120
148-16	7314150367580	1	119
148-17	7314150367597	1	119
148-18	7314150367603	1	119
148-19	7314150367610	1	119
148-21	7314150367627	1	119
148-22	7314150367634	1	119
148-24	7314150367641	1	119
148-27	7314150367658	1	119
148-28	7314150367665	1	119
148-3/4	7314150367764	1	120
148-30	7314150367672	1	119
148-32	7314150367689	1	119
148-34	7314150367696	1	119
148-36	7314150367702	1	119
148-41	7314150367719	1	119
148-5/8	7314150367740	1	120
148-7/8	7314150367788	1	120
148-9/16	7314150367733	1	120
1482K4	7314150415779	1	377
1482K4BKW	7314150426126	1	377
1482K4BLACK	7314150415786	1	377
1482K4BLUE	7314150415793	1	377
1482K4GREY	7314150415809	1	377
1482K4RED	7314150415816	1	377
1482K4W	7314150425174	1	377
1482K4WHITE	7314150415823	1	377
1482K5W	7314150431274	1	377
1483CART	7314150273256	1	470
1483K2RB	7314150230013	1	470
1483K3RB	7314150230037	1	470
1483KHD3RB	7314150230099	1	470
1483KHD3RB-FF1	7314150233564	1	452
1483KHD3RB-FF2	7314150233571	1	452
1483KHD3RB-FF3	7314150233588	1	437
1483KHD3RB-FF4	7314150233595	1	437
1483KHD3RB-FF5	7314150233601	1	452
1483KHD3RB-FF7	7314150336050	1	452
1483KHD4RB	7314150230105	1	470
1484THD3RB	7314150265435	1	470
1485K4	7314150349838	1	382
1485K4BLACK	7314150349920	1	382
1485K4BLUE	7314150349944	1	382
1485K4RED	7314150349937	1	382
1485KXL4	7314150350247	1	382
1485KXL4BLACK	7314150350346	1	382
1485KXL4BLUE	7314150350360	1	382
1485KXL4RED	7314150350353	1	382
1487K4	7314150351206	1	377
1487K4BKW	7314150426133	1	377
1487K4BLACK	7314150351213	1	377
1487K4GREY	7314150351237	1	377
1487K4W	7314150425181	1	377
1495CD-AC1	7314150296965	1	468
1495CD60	7314150296927	1	468
1495CD60BK	7314150326952	1	468
1495CD60BL	7314150326969	1	468
1495CD60RED	7314150326976	1	468
1495CD60TS1	7314150325627	1	436
1495CD60W	7314150303656	1	468
1495CD60WBK	7314150327713	1	468
1495CD60WBL	7314150327720	1	468
1495CD60WRED	7314150327744	1	468
1495CS-AC1	7314150296910	1	468
1495CS15	7314150296934	1	467
1495CS15BK	7314150326853	1	467
1495CS15BL	7314150326860	1	467
1495CS15RED	7314150326877	1	467



1495CS15TS1	7314150325610	1	436
1495CS18	7314150296941	1	467
1495CS18BK	7314150326884	1	467
1495CS18BL	7314150326891	1	467
1495CS18BLHK	7314150407620	1	467
1495CS18HK	7314150407613	1	467
1495CS18RED	7314150326907	1	467
1495CS18TS1	7314150325603	1	436
1495FWB097TD	7314150296675	1	467
1495FWB097TS	7314150296651	1	467
1495FWB120TD	7314150296682	1	467
1495FWB120TS	7314150296668	1	467
1495K6CBKWB15TD	7314150369072	1	464
1495K6CBKWB15TS	7314150368990	1	463
1495K6CBKWB15TW	7314150369034	1	464
1495K6CBKWB18TD	7314150369690	1	464
1495K6CBKWB18TS	7314150369591	1	463
1495K6CBKWB18TW	7314150369638	1	464
1495K6CBLWB15TD	7314150369317	1	464
1495K6CBLWB15TS	7314150369119	1	463
1495K6CBLWB15TW	7314150369232	1	464
1495K6CBLWB18TD	7314150369829	1	464
1495K6CBLWB18TS	7314150369744	1	463
1495K6CBLWB18TW	7314150369782	1	464
1495K6CRDWB15TD	7314150368969	1	464
1495K6CRDWB15TS	7314150368600	1	463
1495K6CRDWB15TW	7314150368655	1	464
1495K6CRDWB18TD	7314150369553	1	464
1495K6CRDWB18TS	7314150369478	1	463
1495K6CRDWB18TW	7314150369515	1	464
1495K6CWB15TD	7314150368563	1	464
1495K6CWB15TS	7314150368440	1	463
1495K6CWB15TW	7314150368501	1	464
1495K6CWB18TD	7314150369430	1	464
1495K6CWB18TS	7314150369355	1	463
1495K6CWB18TW	7314150369393	1	464
1495K7CBKWB15TD	7314150369089	1	464
1495K7CBKWB15TS	7314150369003	1	463
1495K7CBKWB15TW	7314150369041	1	464
1495K7CBKWB18TD	7314150369713	1	464
1495K7CBKWB18TS	7314150369607	1	463
1495K7CBKWB18TW	7314150369645	1	464
1495K7CBLWB15TD	7314150369324	1	464
1495K7CBLWB15TS	7314150369164	1	463
1495K7CBLWB15TW	7314150369263	1	464
1495K7CBLWB18TD	7314150369836	1	464
1495K7CBLWB18TS	7314150369751	1	463
1495K7CBLWB18TW	7314150369799	1	464
1495K7CRDWB15TD	7314150368976	1	464
1495K7CRDWB15TS	7314150368624	1	463
1495K7CRDWB15TW	7314150368662	1	464
1495K7CRDWB18TD	7314150369560	1	464
1495K7CRDWB18TS	7314150369485	1	463
1495K7CRDWB18TW	7314150369522	1	464
1495K7CWB15TD	7314150368570	1	464
1495K7CWB15TS	7314150368464	1	463
1495K7CWB15TW	7314150368518	1	464
1495K7CWB18TD	7314150369447	1	464
1495K7CWB18TS	7314150369362	1	463
1495K7CWB18TW	7314150369409	1	464
1495K8CBKWB15TD	7314150369096	1	464
1495K8CBKWB15TS	7314150369010	1	463
1495K8CBKWB15TW	7314150369058	1	464
1495K8CBKWB18TD	7314150369720	1	464
1495K8CBKWB18TS	7314150369614	1	463
1495K8CBKWB18TW	7314150369652	1	464
1495K8CBLWB15TD	7314150369331	1	464
1495K8CBLWB15TS	7314150369188	1	463
1495K8CBLWB15TW	7314150369294	1	464
1495K8CBLWB18TD	7314150369843	1	464
1495K8CBLWB18TS	7314150369768	1	463
1495K8CBLWB18TW	7314150369805	1	464
1495K8CRDWB15TD	7314150368945	1	464
1495K8CRDWB15TS	7314150368631	1	463
1495K8CRDWB15TW	7314150368693	1	464
1495K8CRDWB18TD	7314150369577	1	464
1495K8CRDWB18TS	7314150369492	1	463
1495K8CRDWB18TW	7314150369539	1	464
1495K8CWB15TD	7314150368587	1	464
1495K8CWB15TS	7314150368471	1	463
1495K8CWB15TW	7314150368525	1	464
1495K8CWB18TD	7314150369454	1	464
1495K8CWB18TS	7314150370061	1	463
1495K8CWB18TW	7314150369416	1	464
1495KH6BKWB15TD	7314150418954	1	465
1495KH6BKWB15TS	7314150420063	1	464
1495KH6BKWB15TW	7314150417704	1	465
1495KH6BKWB18TD	7314150420575	1	465
1495KH6BKWB18TS	7314150420728	1	464
1495KH6BKWB18TW	7314150420452	1	465
1495KH6BLWB15TD	7314150418961	1	465
1495KH6BLWB15TS	7314150420216	1	464
1495KH6BLWB15TW	7314150417803	1	465
1495KH6BLWB18TD	7314150420629	1	465
1495KH6BLWB18TS	7314150420759	1	464
1495KH6BLWB18TW	7314150420483	1	465



1495KH6RDWB15TD	7314150418947	1	465
1495KH6RDWB15TS	7314150420032	1	464
1495KH6RDWB15TW	7314150417575	1	465
1495KH6RDWB18TD	7314150420544	1	465
1495KH6RDWB18TS	7314150420698	1	464
1495KH6RDWB18TW	7314150420421	1	465
1495KH6WB15TD	7314150418923	1	465
1495KH6WB15TS	7314150420001	1	464
1495KH6WB15TW	7314150417407	1	465
1495KH6WB18TD	7314150420513	1	465
1495KH6WB18TS	7314150420650	1	464
1495KH6WB18TW	7314150420377	1	465
1495KH7BKWB15TD	7314150419951	1	465
1495KH7BKWB15TS	7314150420193	1	464
1495KH7BKWB15TW	7314150418282	1	465
1495KH7BKWB18TD	7314150420605	1	465
1495KH7BKWB18TS	7314150420735	1	464
1495KH7BKWB18TW	7314150420469	1	465
1495KH7BLWB15TD	7314150419982	1	465
1495KH7BLWB15TS	7314150420223	1	464
1495KH7BLWB15TW	7314150418299	1	465
1495KH7BLWB18TD	7314150420636	1	465
1495KH7BLWB18TS	7314150420766	1	464
1495KH7BLWB18TW	7314150420490	1	465
1495KH7RDWB15TD	7314150419937	1	465
1495KH7RDWB15TS	7314150420049	1	464
1495KH7RDWB15TW	7314150418275	1	465
1495KH7RDWB18TD	7314150420551	1	465
1495KH7RDWB18TS	7314150420704	1	464
1495KH7RDWB18TW	7314150420438	1	465
1495KH7WB15TD	7314150418978	1	465
1495KH7WB15TS	7314150420018	1	464
1495KH7WB15TW	7314150417926	1	465
1495KH7WB18TD	7314150420520	1	465
1495KH7WB18TS	7314150420667	1	464
1495KH7WB18TW	7314150420407	1	465
1495KH8BKWB15TD	7314150419975	1	465
1495KH8BKWB15TS	7314150420209	1	465
1495KH8BKWB15TW	7314150418329	1	465
1495KH8BKWB18TD	7314150420612	1	465
1495KH8BKWB18TS	7314150420742	1	465
1495KH8BKWB18TW	7314150420476	1	465
1495KH8BLWB15TD	7314150419999	1	465
1495KH8BLWB15TS	7314150420360	1	465
1495KH8BLWB15TW	7314150418336	1	465
1495KH8BLWB18TD	7314150420643	1	465
1495KH8BLWB18TS	7314150420773	1	465
1495KH8BLWB18TW	7314150420506	1	465
1495KH8RDWB15TD	7314150419944	1	465
1495KH8RDWB15TS	7314150420056	1	465
1495KH8RDWB15TW	7314150418312	1	465
1495KH8RDWB18TD	7314150420568	1	465
1495KH8RDWB18TS	7314150420711	1	465
1495KH8RDWB18TW	7314150420445	1	465
1495KH8WB15TD	7314150418985	1	465
1495KH8WB15TS	7314150420025	1	464
1495KH8WB15TW	7314150418305	1	465
1495KH8WB18TD	7314150420537	1	465
1495KH8WB18TS	7314150420674	1	464
1495KH8WB18TW	7314150420414	1	465
1495KWB15TD	7314150296637	1	466
1495KWB15TS	7314150338115	1	465
1495KWB15TW	7314150296613	1	466
1495KWB18TD	7314150296644	1	466
1495KWB18TS	7314150338122	1	465
1495KWB18TW	7314150296620	1	466
1495TP-AC1	7314150297030	1	468
1495TP-AC10	7314150297207	1	468
1495TP-AC11	7314150297214	1	468
1495TP-AC12	7314150297221	1	468
1495TP-AC13	7314150297238	1	469
1495TP-AC2	7314150297122	1	469
1495TP-AC3	7314150297139	1	469
1495TP-AC4	7314150297146	1	469
1495TP-AC5	7314150297153	1	469
1495TP-AC6	7314150297160	1	469
1495TP-AC7	7314150297177	1	469
1495TP-AC8	7314150297184	1	469
1495TP-AC9	7314150297191	1	469
1495TP-ACHL20	7314150297047	1	470
1495TP-ACHL40	7314150297054	1	470
1495TP-ACHL65	7314150297061	1	470
1495TP-ACHL90	7314150297078	1	470
1495TP-ACHU20	7314150297085	1	470
1495TP-ACHU40	7314150297092	1	470
1495TP-ACHU65	7314150297108	1	470
1495TP-ACHU90	7314150297115	1	470
1495TP-AUTO-M1	7314150438266	1	447
1495TP-AUTO-M2	7314150438273	1	448
1495TP-AUTO-M3	7314150438280	1	448
1495TP-AUTO-M4	7314150438297	1	448
1495TP-AUTO-M5	7314150438303	1	448
1495TP-AUTO-M6	7314150438310	1	449
1495TP06	7314150296989	1	467
1495TP06GR	7314150326914	1	467
1495TP09	7314150438624	1	467



1495TP09-RAIL



1495TP09-RAIL	7314150465705	1	470
1495TP10W	7314150297023	1	468
1495TP12	7314150296996	1	467
1495TP12GR	7314150326921	1	467
1495TP15	7314150297009	1	467
1495TP15GR	7314150326938	1	467
1495TP18	7314150297016	1	467
1495TP18GR	7314150326945	1	467
1495WB-AC1	7314150296576	1	467
1495WB-AC2	7314150296583	1	467
1495WB15-AC1	7314150296590	1	467
1495WB15-AC1GR	7314150327218	1	467
1495WB15TD	7314150296521	1	466
1495WB15TDGR	7314150327133	1	466
1495WB15TS	7314150296514	1	466
1495WB15TSBK	7314150326983	1	466
1495WB15SBL	7314150326990	1	466
1495WB15TSBT	7314150407651	1	466
1495WB15TSRED	7314150327003	1	466
1495WB15TW	7314150296538	1	466
1495WB15TWGR	7314150327140	1	466
1495WB18-AC1	7314150296606	1	467
1495WB18-AC1GR	7314150327225	1	467
1495WB18TD	7314150296552	1	466
1495WB18TDGR	7314150327157	1	466
1495WB18TS	7314150296545	1	466
1495WB18TSBK	7314150327010	1	466
1495WB18TSBL	7314150327027	1	466
1495WB18TSBLBT	7314150407644	1	466
1495WB18TSBT	7314150407637	1	466
1495WB18TSRED	7314150327034	1	466
1495WB18TW	7314150296569	1	466
1495WB18TWGR	7314150327164	1	466
1495WBAH15TD	7314150312993	1	467
1495WBAH15TS	7314150313006	1	466
1495WBAH15TSBL	7314150327058	1	466
1495WBAH15TW	7314150313013	1	466
1495WBAH18TD	7314150313037	1	467
1495WBAH18TS	7314150313044	1	466
1495WBAH18TSBK	7314150327089	1	466
1495WBAH18TSBL	7314150327119	1	466
1495WBAH18TSRED	7314150327126	1	466
1495WBAH18TW	7314150313051	1	466
1495WBAH18TWGR	7314150327201	1	466
1496MB2	7314150273478	1	470
1496MB3	7314150273485	1	471
1496MB4	7314150273492	1	471
1496MB5	7314150273508	1	471
1497MB08	7314150349869	1	471
1497MB13	7314150349876	1	471
1497MB18	7314150349913	1	471
1497MBF350	7314150321391	1	471
1497MBF550	7314150321407	1	472
1497MBF750	7314150321414	1	472
14A-32	7314150368228	1	120
14A-9	7314150368211	1	120
14F-1/2	7314150366200	1	118
14F-3/4	7314150366217	1	118
14P-1/2	7314150366064	1	118
14Q-1/2	7314150366026	1	118
14R-1/2	7314150365920	1	117
14R-3/4	7314150365937	1	117
14T-1/2	7314150366125	1	117
14T-3/4	7314150366132	1	117
14W	7314150357031	1	120
1519 D	7314150032747	3	237
1519-9	7314150026074	1	237
1520 D	7311518278922	5	233
1520 G	7311518266516	5	233
1520 G IP	7314150437740	5	233
1535	7314150214808	1	559
1537	7314150214822	1	559
1544	7311518276560	1	559
1546	7314150214792	1	559
1547	7311518276577	20	559
158-N	7311518277239	12	242
158-NB	7311518277246	12	244
1610	7314150404186	1	266
1610-NUT	7314150409594	1	266
1620	7314150404193	1	266
1620-NUT	7314150409754	1	266
166-6-16-2.5-12	7311518021979	12	26
166-6-16-2.5-2	7311518209698	5	26
167-1	7314150419067	1	121
167-1.1/16	7314150419074	1	121
167-1.1/4	7314150419104	1	121
167-1.1/8	7314150419081	1	121
167-1.3/16	7314150419098	1	121
167-1/2	7314150418930	1	121
167-10	7314150418657	1	121
167-11	7314150418664	1	121
167-11/16	7314150419364	1	121
167-12	7314150418671	1	121
167-13	7314150418688	1	121
167-13/16	7314150419036	1	121
167-14	7314150418695	1	121



167-15	7314150418701	1	121
167-15/16	7314150419050	1	121
167-16	7314150418718	1	121
167-17	7314150418725	1	121
167-18	7314150418732	1	121
167-19	7314150418749	1	121
167-20	7314150418763	1	121
167-21	7314150418770	1	121
167-22	7314150418787	1	121
167-23	7314150418794	1	121
167-24	7314150418800	1	121
167-25	7314150418817	1	121
167-26	7314150418824	1	121
167-27	7314150418831	1	121
167-28	7314150418848	1	121
167-3/4	7314150419029	1	121
167-3/8	7314150418909	1	121
167-30	7314150418855	1	121
167-32	7314150418862	1	121
167-36	7314150418886	1	121
167-5/16	7314150418893	1	121
167-5/8	7314150419012	1	121
167-7	7314150418619	1	121
167-7/16	7314150418916	1	121
167-7/8	7314150419043	1	121
167-8	7314150418626	1	121
167-8-21-3.2-12	7311518021986	12	26
167-9	7314150418640	1	121
167-9/16	7314150419005	1	121
168-1	7314150419562	1	122
168-1.1/16	7314150419579	1	122
168-1.3/16	7314150419586	1	122
168-1/2	7314150419487	1	122
168-10	7314150419272	1	122
168-11	7314150419289	1	122
168-11/16	7314150419517	1	122
168-12	7314150419296	1	122
168-13	7314150419302	1	122
168-13/16	7314150419531	1	122
168-14	7314150419319	1	122
168-15	7314150419326	1	122
168-15/16	7314150419555	1	122
168-16	7314150419333	1	122
168-17	7314150419340	1	122
168-18	7314150419357	1	122
168-19	7314150419371	1	122
168-20	7314150419388	1	122
168-21	7314150419395	1	122
168-22	7314150419401	1	122
168-23	7314150419418	1	122
168-24	7314150419425	1	122
168-26	7314150419432	1	122
168-27	7314150419449	1	122
168-3/4	7314150419524	1	122
168-3/8	7314150419463	1	122
168-5/16	7314150419456	1	122
168-5/8	7314150419500	1	122
168-6-3.2-1P	7311518152338	12	26
168-6-3.2-3P	7311518152413	12	27
168-6-3.5-1P	7311518152345	12	26
168-6-3.5-3P	7311518152420	12	27
168-7	7314150419241	1	122
168-7/16	7314150419470	1	122
168-7/8	7314150419548	1	122
168-8	7314150419258	1	122
168-8-4.0-1P	7311518152352	12	26
168-8-4.0-3P	7311518152437	12	27
168-8-4.0-6	7311518217419	6	27
168-8-4.5-1P	7311518152369	12	26
168-8-4.5-3P	7311518152444	12	27
168-8-4.5-6	7311518217426	6	27
168-8-4.8-1P	7311518152376	12	26
168-8-4.8-3P	7311518152451	12	27
168-8-4.8-6	7311518217433	6	27
168-8-5.2-1P	7311518152383	12	26
168-8-5.2-3P	7311518152468	12	27
168-8-5.2-6	7311518217440	6	27
168-8-5.5-1P	7311518152390	12	26
168-8-5.5-3P	7311518152475	12	27
168-8-5.5-6	7311518217457	6	27
168-8-6.3-1P	7311518152406	12	26
168-8-6.3-3P	7311518152482	12	27
168-9	7314150419265	1	122
168-9/16	7314150419494	1	122
168-COMBI-4.0	7311518209667	10	27
168-COMBI-4.0-6922	7311518209612	10	27
168-COMBI-4.5	7314150272860	10	27
168-COMBI-4.8	7311518209674	10	27
168-COMBI-4.8-6920	7311518209643	10	27
168-COMBI-5.5	7311518209681	10	27
168-COMBI-5.5-6924	7311518209650	10	27
169-10	7314150419630	1	122
169-11	7314150419647	1	122
169-12	7314150419654	1	122
169-13	7314150419661	1	122
169-14	7314150419678	1	122

Part Number	Quantity	Price
169-15	1	122
169-16	1	122
169-17	1	122
169-18	1	122
169-19	1	122
169-20	1	122
169-21	1	122
169-22	1	122
169-23	1	122
169-24	1	122
169-27	1	122
169-7	1	122
169-8	1	122
169-9	1	122
16F-1/2	1	121
16F-1/4	1	121
16F-3/8	1	121
16R-1/2	1	121
16R-1/4	1	121
16R-3/8	1	121
1931M-10	5	49
1931M-11	5	49
1931M-12	5	49
1931M-13	5	49
1931M-14	5	49
1931M-17	5	49
1931M-4	5	49
1931M-4.5	5	49
1931M-5	5	49
1931M-5.5	5	49
1931M-6	5	49
1931M-7	5	49
1931M-8	5	49
1931M-9	5	49
1931M/10T	1	50
1931Z-1/2	5	49
1931Z-1/4	5	49
1931Z-1/8	5	49
1931Z-11/32	5	49
1931Z-11/32-3/8	5	49
1931Z-13/64	5	49
1931Z-15/64-1/4	5	49
1931Z-3/16	5	49
1931Z-3/8	5	49
1931Z-5/16	5	49
1931Z-5/32	5	49
1931Z-5/8	5	49
1931Z-7/16	5	49
1931Z-7/32	5	49
1931Z-9/16	5	49
1931Z-9/32	5	49
1931Z-9/32-5/16	5	49
1931Z/12T	1	50
1933M/6T	1	50
1936M-10-11	25	57
1936M-10-13	25	57
1936M-12-13	25	57
1936M-13-17	20	57
1936M-14-15	20	57
1936M-14-17	15	57
1936M-16-17	15	57
1936M-17-19	10	57
1936M-18-19	10	57
1936M-19-22	8	57
1936M-20-22	8	57
1936M-21-23	8	57
1936M-22-24	5	57
1936M-24-26	5	57
1936M-24-27	5	57
1936M-25-28	5	57
1936M-30-32	1	57
1936M-30-34	4	57
1936M-36-41	4	57
1936M-46-50	2	57
1936M-6-7	50	57
1936M-8-10	30	57
1936M-8-9	5	57
1936M/12	1	58
1936M/7	1	58
1943M-11-13	1	53
1943M-13-15	1	53
1943M-13-17	1	53
1943M-14-16	1	53
1943M-14-17	1	53
1943M-15-17	1	53
1943M-19-22	1	53
1943Z-11/16-13/16	1	53
1943Z-5/16-3/8	1	53
1943Z-5/8-3/4	1	53
1943Z-7/16-1/2	1	53
1943Z-9/16-5/8	1	53
1945W12	6	316
1945W14	8	316
1945W38	6	316
1949M-10-11	1	54
1949M-10-12	1	54

Part Number	Quantity	Price
1949M-12-13	1	54
1949M-12-14	1	54
1949M-14-15	1	54
1949M-14-17	1	54
1949M-17-19	1	54
1949M-19-22	1	54
1949M-22-24	1	54
1949M-24-27	1	54
1949M-30-32	1	54
1949M-8-9	1	54
1949Z-1-1.1/8	1	54
1949Z-1/2-9/16	1	54
1949Z-3/4-7/8	1	54
1949Z-3/8-7/16	1	54
1949Z-5/8-3/4	1	54
1950MZ-3/8	1	55
1952M-10	10	43
1952M-11	10	43
1952M-12	10	43
1952M-13	10	43
1952M-14	10	43
1952M-15	10	43
1952M-16	10	43
1952M-17	10	43
1952M-18	10	43
1952M-19	10	43
1952M-20	10	43
1952M-21	10	43
1952M-22	5	43
1952M-23	5	43
1952M-24	5	43
1952M-25	5	43
1952M-26	5	43
1952M-27	5	43
1952M-28	1	43
1952M-29	1	43
1952M-30	1	43
1952M-32	1	43
1952M-34	1	43
1952M-36	1	43
1952M-41	1	43
1952M-46	1	43
1952M-50	1	43
1952M-55	1	43
1952M-6	10	43
1952M-60	1	43
1952M-65	1	43
1952M-7	10	43
1952M-70	1	43
1952M-75	1	43
1952M-8	10	43
1952M-80	1	43
1952M-9	10	43
1952M/10	1	44
1952M/14T	1	44
1952M/17T	1	44
1952M/26T	1	44
1952M/7T	1	44
1952M/SH12	1	44
1952M/SH6	1	44
1952Z-1	1	43
1952Z-1.1/16	1	43
1952Z-1.1/2	1	43
1952Z-1.1/4	1	43
1952Z-1.1/8	1	43
1952Z-1.3/8	1	43
1952Z-1.5/16	1	43
1952Z-1.5/8	1	43
1952Z-1.7/16	1	43
1952Z-1/2	5	43
1952Z-1/4	5	43
1952Z-11/16	5	43
1952Z-13/16	5	43
1952Z-15/16	5	43
1952Z-3/4	5	43
1952Z-3/8	5	43
1952Z-5/16	5	43
1952Z-5/8	5	43
1952Z-7/16	5	43
1952Z-7/8	5	43
1952Z-9/16	5	43
1952Z/11T	1	45
1976TORX-T10	5	228
1976TORX-T15	5	228
1976TORX-T20	5	228
1976TORX-T25	5	228
1976TORX-T27	5	228
1976TORX-T30	5	228
1976TORX-T40	5	228
1976TORX-T6	5	228
1976TORX-T7	5	228
1976TORX-T8	5	228
1976TORX-T9	5	228
1976TORX/5T	1	228
1986TORX-T10	5	228



1986TORX-T15



1986TORX-T15	7314150123544	5	228
1986TORX-T20	7314150123551	5	228
1986TORX-T25	7314150123568	5	228
1986TORX-T27	7314150123575	5	228
1986TORX-T30	7314150123582	5	228
1986TORX-T40	7314150123599	5	228
1986TORX-T9	7314150122233	5	228
1986TORX/7T	7314150123735	1	228
1995LM-1.5	7314150122172	10	224
1995LM-10	7314150123254	10	224
1995LM-12	7314150123261	10	224
1995LM-14	7314150123278	10	224
1995LM-2	7314150122189	10	224
1995LM-2.5	7314150123162	10	224
1995LM-3	7314150123179	10	224
1995LM-4	7314150123186	10	224
1995LM-5	7314150123209	10	224
1995LM-6	7314150123216	10	224
1995LM-7	7314150123223	10	224
1995LM-8	7314150123230	10	224
1995LM-9	7314150123247	10	224
1995M-0.9	7314150216291	10	223
1995M-1.5	7314150122158	10	223
1995M-10	7314150122912	10	223
1995M-12	7314150122943	10	223
1995M-14	7314150122967	10	223
1995M-17	7314150122974	10	223
1995M-19	7314150122981	10	223
1995M-2	7314150122745	10	223
1995M-2.5	7314150122752	10	223
1995M-22	7314150122998	10	223
1995M-3	7314150122769	10	223
1995M-4	7314150122776	10	223
1995M-5	7314150122790	10	223
1995M-6	7314150122813	10	223
1995M-7	7314150122837	10	223
1995M-8	7314150122851	10	223
1995M-9	7314150122875	10	223
1995M/10T	7314150123643	1	223
1995M/11T	7314150123650	1	223
1995M/15T	7314150123667	1	223
1995M/6T	7314150123629	1	223
1995M/8T	7314150123636	1	223
1995TORX-T10	7314150123308	5	226
1995TORX-T15	7314150123322	5	226
1995TORX-T20	7314150123339	5	226
1995TORX-T25	7314150123346	5	226
1995TORX-T27	7314150123353	5	226
1995TORX-T30	7314150123360	5	226
1995TORX-T40	7314150123377	5	226
1995TORX-T45	7314150123407	5	226
1995TORX-T50	7314150123421	5	226
1995TORX-T55	7314150216963	5	226
1995TORX-T6	7314150122196	5	226
1995TORX-T60	7314150216970	5	226
1995TORX-T7	7314150123285	5	226
1995TORX-T8	7314150123292	5	226
1995TORX-T9	7314150122219	5	226
1995TORX/11T	7314150123742	1	226
1995TORX/13T	7314150123759	1	227
1995TORX/4T	7314150123674	1	226
1995TORX/7T	7314150123711	1	226
1995Z-1/16	7314150122165	10	223
1995Z-1/2	7314150123117	10	223
1995Z-1/4	7314150123070	10	223
1995Z-1/8	7314150123025	10	223
1995Z-3/16	7314150123056	10	223
1995Z-3/32	7314150123018	10	223
1995Z-3/4	7314150123155	10	223
1995Z-3/8	7314150123094	10	223
1995Z-5/16	7314150123087	10	223
1995Z-5/32	7314150123049	10	223
1995Z-5/64	7314150123001	10	223
1995Z-5/8	7314150123131	10	223
1995Z-7/16	7314150123100	10	223
1995Z-7/32	7314150123063	10	223
1995Z/10T	7314150215980	1	224
1995Z/12T	7314150215997	1	224
1996M-1.5	7314150122202	10	225
1996M-10	7314150122721	10	225
1996M-12	7314150122738	10	225
1996M-2	7314150122653	10	225
1996M-2.5	7314150122660	10	225
1996M-3	7314150122677	10	225
1996M-4	7314150122684	10	225
1996M-5	7314150122691	10	225
1996M-6	7314150122707	10	225
1996M-8	7314150122714	10	225
1996TORX-T10	7314150122783	5	227
1996TORX-T15	7314150122806	5	227
1996TORX-T20	7314150122820	5	227
1996TORX-T25	7314150122844	5	227
1996TORX-T27	7314150122868	5	227
1996TORX-T30	7314150122882	5	227
1996TORX-T40	7314150122899	5	227
1996TORX-T45	7314150122905	5	227



1996TORX-T50	7314150122929	5	227
1996TORX-T9	7314150122226	5	227
1996TORX/5T	7314150123698	1	227
1998M-1.5	7314150185719	10	222
1998M-10	7314150185801	10	222
1998M-12	7314150185818	5	222
1998M-14	7314150185825	1	222
1998M-17	7314150185832	1	222
1998M-19	7314150185849	1	222
1998M-2	7314150185726	10	222
1998M-2.5	7314150185733	10	222
1998M-22	7314150185856	1	222
1998M-3	7314150185740	10	222
1998M-4	7314150185757	10	222
1998M-5	7314150185764	10	222
1998M-6	7314150185863	10	222
1998M-7	7314150185771	10	222
1998M-8	7314150185788	10	222
1998M-9	7314150185795	5	222
1998M/10T	7314150186228	1	222
1998M/11T	7314150186235	1	222
1998M/15T	7314150186242	1	222
1998M/6T	7314150186204	1	222
1998M/8R	7314150186266	1	222
1998M/8T	7314150186211	1	222
1999M/7H	7314151801076	1	222
1999MV-10	7314150121496	3	512
1999MV-12	7314150121502	3	512
1999MV-3	7314150121427	5	512
1999MV-4	7314150121434	5	512
1999MV-5	7314150121441	5	512
1999MV-6	7314150121458	5	512
1999MV-7	7314150121465	5	512
1999MV-8	7314150121472	5	512
1999MV-9	7314150121489	5	512
1RM-10	7314153000576	1	45
1RM-11	7314153000583	1	45
1RM-12	7314153000590	1	45
1RM-13	7314153000606	1	45
1RM-14	7314153000613	1	45
1RM-15	7314153000620	1	45
1RM-16	7314153000637	1	45
1RM-17	7314153000644	1	45
1RM-18	7314153000651	1	45
1RM-19	7314153000668	1	45
1RM-21	7314150214495	1	45
1RM-22	73141530005915	1	45
1RM-24	73141530005922	1	45
1RM-27	7314153014177	1	45
1RM-30	7314153014184	1	45
1RM-32	7314153014191	1	45
1RM-6	7314153014146	1	45
1RM-7	7314153014153	1	45
1RM-8	7314153000552	1	45
1RM-9	7314153000569	1	45
1RM/S5	7314150225514	10	46
1RM/SH12	7314150219780	10	46
1RM/SH6	7314150219773	1	46
1RM/SH8	7314150223015	1	46
1RMA-10-1/4-BIT	7314153014634	1	48
1RMA-10-1/4-SQ	7314153014603	1	48
1RMA-13-10-BIT	7314150223008	1	48
1RMA-13-3/8-SQ	7314153014610	1	48
1RMA-13-5/16-BIT	7314153014641	1	48
1RMA-19-1/2-SQ	7314153014627	1	48
1RMA-19-1/4-SQ	7314150190638	1	48
1RMA/S4	7314153014658	1	48
1RMA/S8	7314153014665	1	48
1RZ-1/2	7314153014245	1	45
1RZ-1/4	7314150153725	1	45
1RZ-11/16	7314153014269	1	45
1RZ-11/32	7314150358915	1	45
1RZ-15/16	7314150358939	1	45
1RZ-3/4	7314153014276	1	45
1RZ-3/8	7314153014214	1	45
1RZ-5/16	7314153014207	1	45
1RZ-5/8	7314153014252	1	45
1RZ-7/16	7314153014221	1	45
1RZ-7/8	7314150358922	1	45
1RZ-9/16	7314153014238	1	45
1RZ/SH8	7314150223022	1	46
1Z-1	7314150375189	10	41
1Z-1/2	7314150375103	10	41
1Z-11/16	7314150375134	10	41
1Z-11/32	7314150375073	10	41
1Z-13/16	7314150375158	10	41
1Z-15/16	7314150375172	5	41
1Z-3/16	7314150375028	20	41
1Z-3/4	7314150375141	10	41
1Z-3/8	7314150375080	10	41
1Z-5/16	7314150375066	10	41
1Z-5/8	7314150375127	10	41
1Z-7/16	7314150375097	10	41
1Z-7/32	7314150375035	20	41
1Z-7/8	7314150375165	10	41
1Z-9/16	7314150375110	10	41

1Z-9/32	7314150375059	20	41
2-21-51	7315962500011	5	648
2-300-14-0-0	7311518044138	10	31
2-300-14-2-0	7311518044145	10	31
2-300-14-4-0	7311518108786	10	31
2-300-14-D-1P	7311518189105	10	34
2-300-16-0-0	7311518020491	10	31
2-300-16-1-0	7311518020507	10	31
2-300-16-2-0	7311518020514	10	31
2-300-16-4-0	7311518020521	10	31
2-300-16-D-1P	7311518189129	10	34
2-300-18-0-0	7311518190545	10	31
2-300-18-2-0	7311518190552	10	31
2-301-14-0-0	7311518190569	10	31
2-301-14-2-0	7311518108748	10	31
2-301-14-D-1P	7311518189136	1	34
2-301-16-0-0	7311518108755	10	31
2-301-16-1-0	7311518020538	10	31
2-301-16-2-0	7311518020545	10	31
2-302-14-0-0	7311518044152	10	32
2-302-14-2-0	7311518044169	10	32
2-302-14-4-0	7311518108793	10	32
2-302-14-D-1P	7311518189150	10	34
2-302-16-0-0	7311518108762	10	32
2-302-16-1-0	7311518020552	10	32
2-302-16-2-0	7311518020569	10	32
2-302-16-4-0	7311518108809	10	32
2-302-16-D-1P	7311518189167	10	34
2-302-18-0-0	7311518190613	10	32
2-302-18-2-0	7311518190620	10	32
2-303-14-2-0	7311518044176	10	32
2-303-14-D-1P	7311518189174	10	34
2-303-16-0-0	7311518108779	10	32
2-303-16-1-0	7311518020576	10	32
2-303-16-2-0	7311518020583	10	32
2-303-16-4-0	7311518108830	10	32
2-303-16-D-1P	7311518189198	1	34
2-303-18-0-0	7311518190644	10	32
2-303-18-2-0	7311518190668	10	32
2-304-14-0-0	7311518044183	10	32
2-304-14-2-0	7311518044190	10	32
2-304-14-4-0	7311518108878	10	32
2-304-14-D-1P	7311518189204	10	34
2-304-16-0-0	7311518020590	10	32
2-304-16-1-0	7311518020606	10	32
2-304-16-2-0	7311518020613	10	32
2-304-16-4-0	7311518020620	10	32
2-304-16-D-1P	7311518189211	10	34
2-304-18-0-0	7311518190712	10	32
2-304-18-2-0	7311518190736	10	32
2-305-16-1-0	7311518020637	10	32
2-305-16-2-0	7311518108908	10	32
2-306-14-D-1P	7311518189228	1	35
2-306-16-1-0	7311518020644	10	32
2-306-16-2-0	7311518108854	10	32
2-307-14-0-0	7311518044206	10	32
2-307-14-2-0	7311518044213	10	32
2-307-14-4-0	7311518108885	10	32
2-307-14-D-1P	7311518189235	10	35
2-307-16-0-0	7311518020651	10	32
2-307-16-1-0	7311518020668	10	32
2-307-16-2-0	7311518020675	10	32
2-307-16-4-0	7311518020682	10	32
2-307-16-D-1P	7311518189242	10	35
2-307-18-0-0	7311518190965	10	32
2-307-18-2-0	7311518190972	10	32
2-308-14-2-0	7311518044220	10	32
2-308-14-D-1P	7311518189259	1	35
2-308-16-0-0	7311518108861	10	32
2-308-16-1-0	7311518020699	10	32
2-308-16-2-0	7311518020705	10	32
2-309-16-2-0	7311518108946	10	32
2-309-16-4-0	7311518191054	10	32
2-313-16-0-0	7311518191177	10	32
2-470-14-0-0	7311518191191	10	33
2-470-14-2-0	7311518109080	10	33
2-470-14-4-0	7311518191207	10	33
2-470-16-1-0	7311518010942	10	33
2-470-16-2-0	7311518109097	10	33
2-471-16-1-0	7311518010959	5	33
2-472-14-0-0	7311518191214	5	34
2-472-14-2-0	7311518109103	5	34
2-472-16-0-0	7311518191238	5	34
2-472-16-1-0	7311518010966	5	34
2-472-16-2-0	7311518108922	5	34
2010	7314151584610	1	478
204030150	8413345400855	12	564
204030160	8413345400862	12	564
204030180	8413345400879	12	564
204050130	8413345097970	6	564
204530140	8413345097918	12	565
204550130	8413345097956	6	565
2045A3000	8413345097932	12	565
2047-0.8-4	7314151060459	5	229
2047-1-5.5	7314151060473	5	229
2047-1.2-8	7314151060480	5	229

2047-1.6-10	7314151060497	1	229
2047-2-12	7314151060503	1	229
2047PR-1-2	7314151060558	5	229
2047PR-3-4	7314151060565	5	229
2047PZ-1-2	7314150216390	5	229
2058-BR	7314151849290	1	86
2058/S26	7314151849276	30	168
2058/S26-2	7314151849283	1	168
208	7311518017545	5	570
209027040	8413345400947	12	565
209227060	8413345400961	12	565
209228100	8413345099233	12	565
209250100	8413345099585	6	565
210	7315965100379	10	570
2100PD-150	7314150205691	5	234
2101D-125	7314150106387	5	232
2101D-125IP	7314150106431	5	232
2101D-140	7314150106394	5	232
2101D-140IP	7314150106325	5	232
2101D-160	7314150106400	5	232
2101D-160IP	7314150106318	5	232
2101D-180	7314150106417	5	232
2101D-180IP	7314150106448	5	232
2101G-125	7314150106462	5	232
2101G-125IP	7314150106516	5	232
2101G-125IPD	7314150335039	5	232
2101G-140	7314150106479	5	232
2101G-140IP	7314150106288	5	232
2101G-140IPD	7314150335053	5	232
2101G-160	7314150106486	5	232
2101G-160IP	7314150106295	5	232
2101G-160IPD	7314150335060	5	232
2101G-180	7314150106493	5	232
2101G-180IP	7314150106523	5	232
2101G-180IPD	7314150335077	5	232
2101GC-125IP	7314150106547	5	232
2101GC-140IP	7314150106554	5	232
2101GC-160IP	7314150106561	5	232
2101GC-180IP	7314150106578	5	232
2101PG-160	7314150113972	5	232
2101S-140	7314150106592	3	509
2101S-160	7314150106608	3	509
2101S-180	7314150106615	3	509
2101S-200	7314150106622	3	509
211035180	8413345000147	5	565
211042210	8413345000154	5	565
212027180	8413345000178	5	565
212033220	8413345129435	8	565
212202500	8413345110266	10	566
212302900	8413345110280	10	566
212502150	8413345110303	10	566
212602150	8413345110327	10	566
212602800	8413345129404	1	566
212704350	8413345122184	6	565
213026140	8413345000185	5	565
2145020D0	8413345097994	1	565
2145020L0	8413345098045	1	566
2145025C0	8413345098083	1	566
2145025D0	8413345098007	1	565
2145025L0	8413345098052	1	566
2145030D0	8413345098014	1	565
2145030L0	8413345098069	1	566
2145035D0	8413345098021	1	565
2145035L0	8413345098076	1	566
2145039C0	8413345098090	1	566
2145PD-150	7314150114009	5	236
215-150	7311518017576	1	572
215000030	8413345131971	12	563
215000040	8413345131988	12	563
215000050	8413345131995	12	563
215000060	8412243557944	12	563
215000070	8413345132008	12	563
215000080	8413345132015	12	563
215000090	8413345132022	12	563
215000100	8413345132039	12	563
215000120	8413345132046	12	563
215500300	7314150220120	12	563
215500400	8413345122627	12	563
215500500	8413345122641	12	563
215500600	8413345122665	12	563
215500700	8413345122689	12	563
215500800	8413345122702	12	563
215500900	8413345137478	12	563
215501000	8413345122726	12	563
216-150-R	7311518017583	1	572
216-300-R	7311518017798	1	572
216000300	8413345403658	12	563
216000400	8413345403665	12	563
216000500	8413345403672	12	563
216000600	8413345403689	12	563
216000700	8413345403696	12	563
216000800	8413345403702	12	563
216000900	8413345403719	12	563
216001000	8413345403726	12	563
216001200	8413345403740	12	563
216100040	8413345132053	12	563





216100060	8413345132091	12	563
216100080	8413345132060	12	563
216100100	8413345132077	12	563
216100120	8413345132084	12	563
216500300	8413345407274	12	563
216500500	8413345407281	12	563
216500750	8413345407298	12	563
216501000	8413345407304	12	563
2171G-140	7314150116232	5	234
2171G-160	7314150116133	5	234
2171G-180	7314150116140	5	234
2171V-160	7314150126798	2	509
2171V-180	7314150126804	2	509
2171V-200	7314150466009	2	509
218	7311518017521	10	571
218-BULK	7311518140946	150	571
219	7311518140953	120	571
219001000	8413345029865	5	563
219001200	8413345029872	5	563
219001400	8413345029889	5	563
219001600	8413345029896	5	563
219002000	8413345029902	5	563
2190PD-150	7314150114016	5	237
219201000	8413345029667	5	563
219201200	8413345029674	5	563
219201400	8413345029681	5	563
219201600	8413345029698	5	563
219202000	8413345029704	5	563
219302500	8413345129466	10	563
219303000	8413345129473	10	563
219303500	8413345129480	10	563
21HDD-140	7314150231256	5	233
21HDD-140IP	7314150231263	5	233
21HDD-160	7314150231270	5	233
21HDD-160IP	7314150231287	5	233
21HDD-180	7314150231294	5	233
21HDD-180IP	7314150231300	5	233
21HDD-200	7314150231317	5	233
21HDD-200IP	7314150231324	5	233
21HDG-140	7314150231331	5	232
21HDG-140A	7314150237654	5	233
21HDG-140IP	7314150231348	5	232
21HDG-160	7314150231355	5	232
21HDG-160A	7314150237661	5	233
21HDG-160IP	7314150231362	5	232
21HDG-180	7314150231379	5	232
21HDG-180A	7314150237678	5	233
21HDG-180IP	7314150231386	5	232
21HDG-200	7314150231409	5	232
21HDG-200A	7314150238439	5	233
21HDG-200IP	7314150231416	5	232
21HDGC-140IP	7314150231423	5	233
21HDGC-160IP	7314150231430	5	233
21HDGC-180IP	7314150231447	5	233
21HDGC-200IP	7314150231454	5	233
221 D	7314150037070	5	248
221201200	8413345029711	5	564
221202000	8413345029728	5	564
221203000	8413345029735	5	564
221301200	8413345029742	5	564
221302000	8413345029759	5	564
221303000	8413345029766	5	564
222 D	7314150037087	5	248
22209004B	8413345401333	1	349
2223 D-150	7314150033591	5	251
2223 G-150	7314150113651	5	251
2223 S-150	7314150032983	3	511
2223V-160	7314150134113	2	511
223 D	7314150037094	5	248
2233 D-160	7314150114023	5	238
2233 D-200	7314150114030	5	238
2233 D-240	7314150114047	5	238
2233D-160IP	7314150114054	5	238
2233D-200IP	7314150114061	5	238
2233D-240IP	7314150114078	5	238
2235-160	7314150179695	1	238
224 D	7314150037100	5	248
225 D	7314150037117	5	248
225-PLUS	7311518029708	5	570
2250V-170	7314150128730	2	509
2250V-230	7314150128747	2	509
227-22	7314150419845	1	121
227-24	7314150419852	1	121
227-27	7314150419869	1	121
227-30	7314150419876	1	121
227-32	7314150419883	1	121
227-34	7314150419890	1	121
227-36	7314150419906	1	121
227-41	7314150419913	1	121
227-46	7314150419920	1	121
228	7311518014995	80	571
228-15-5P	7311518031442	10	572
228-22	7314150420070	1	122
228-24	7314150420087	1	122
228-27	7314150420094	1	122
228-30	7314150420100	1	122



228-32	7314150420117	1	122
228-32-100P	7311518150990	1	572
228-32-10P	7311518010867	10	572
228-32-5P	7311518031459	10	572
228-34	7314150420124	1	122
228-36	7314150420131	1	122
228-41	7314150420148	1	122
228-46	7314150420155	1	122
228-BULK	7311518009069	5	571
228-SD	7311518277048	24	153
228-SET-SD	7314150217946	1	154
229-SD	7311518277055	24	154
22F-3/4	7314150419821	1	121
22R-3/4	7314150419838	1	121
23-15	7311518274665	10	648
23-21	7311518012274	10	648
23-24	7311518003852	10	648
23-30	7311518003869	10	648
23-32	7311518003876	10	648
23-36	7311518003883	10	648
230-SD	7311518280956	25	154
2301C0000	8413345091329	6	564
2303B0000	8413345091404	6	564
2303D0000	8413345091428	6	564
2304C0000	8413345091565	6	564
2308A0000	8413345091602	6	564
2308B0000	8413345091626	6	564
232-SD	7314150214839	1	154
233-300	7311518044015	5	579
233-300-A	7311518044039	5	579
233-400	7311518044022	5	579
2339 D	7314150032792	3	236
2339 DIP	7314150103508	5	236
2339-220	7314150442461	5	237
2339-220IP	7314150101061	5	237
2339-250IP	7314150101078	5	237
2339-280IP	7314150101948	5	237
2339-300IP	7314150123865	6	237
2339D-300	7314150411245	5	236
2339D-300IP	7314150411238	6	236
234-A1	7311518013653	1	579
234-A2	7311518013660	1	579
234-SD	7314150214846	25	154
234-W1	7311518013608	10	579
234-W2	7311518013615	10	579
234-W3	7311518013622	10	579
238	7311518011314	60	571
239	7311518010874	150	571
2420 G-125	7314150102525	5	244
2420G-125IP	7314150447091	5	244
2421 D-140IP	7314150101979	5	245
2421 D-160IP	7314150101986	5	245
2421 D-180IP	7314150101993	5	245
2421 G-140	7314150102532	5	244
2421 G-140IP	7314150102006	5	244
2421 G-160	7314150102549	5	244
2421 G-160 IP	7314150100576	5	244
2421 G-180	7314150102556	5	244
2421 G-180 IP	7314150100583	5	244
2421GC-140IP	7314150447107	5	244
2421GC-160IP	7314150447114	5	244
2421GC-180IP	7314150233229	5	244
2421S-140	7314150447121	3	510
2421S-160	7314150447138	3	510
2421S-180	7314150447145	3	510
2421V-160	7314150126774	2	510
2427 D-160	7314150032846	5	243
2427 D-200	7314150169030	5	243
2427 G-160	7314150100408	5	243
2427 G-160 IP	7314150100743	5	243
2427 G-200	7314150100415	5	243
2427 G-200 IP	7314150100750	5	243
2427 GC-160IP	7314150102051	5	243
2427 GC-200IP	7314150102075	5	243
2427 S-200	7314150033027	3	510
2427S-160	7314150447008	3	510
2427V-200	7314150126903	2	510
2430 D-140	7314150032853	5	241
2430 D-140 IP	7314150100774	5	241
2430 D-160	7314150032860	5	241
2430 D-160 IP	7314150100781	5	241
2430 D-200	7314150032884	5	241
2430 D-200 IP	7314150100804	5	241
2430 G-140	7314150102563	5	241
2430 G-140 IP	7314150102143	5	241
2430 G-160	7314150024070	5	241
2430 G-160 IP	7314150100811	5	241
2430 G-200	7314150100422	5	241
2430 G-200 IP	7314150100835	5	241
2430 GC-140 IP	7314150102150	5	241
2430 GC-160 IP	7314150102167	5	241
2430 GC-200 IP	7314150102174	5	241
2430 S-160	7314150206742	3	510
2430 S-200	7314150033010	3	510
2430S-140	7314150446995	3	510
2430V-160	7314150126880	2	510

2430V-200	7314150126897	2	510
2431G-125	7314150447015	5	241
2431G-125IP	7314150447053	5	241
2431G-140	7314150447022	5	241
2431G-140IP	7314150447060	5	241
2431G-160	7314150447039	5	241
2431G-160IP	7314150447077	5	241
2431G-180	7314150447046	5	241
2431G-180IP	7314150447084	5	241
244-20-U7/8-HP	7311518012519	10	577
244-22-U7/8-HP	7311518012526	10	577
2444	7311518286750	15	597
2446	7314150128648	15	597
2446-BL	7314150508242	15	598
2446-EL	7314150270736	12	598
2446-EL-HELP	7314150394500	12	598
2446-ELL	7314150370153	12	598
2446-ELR	7314150370146	12	598
2446-LAP	7314150508228	15	597
2446-LINO	7314150270750	12	598
2446-OV	7314150313662	15	598
2446-SAFE	7314150453078	15	598
2448	7314150136049	12	586
2449	7314150194056	12	586
244P-20-U7-HP	7311518235499	4	579
244P-22-U7-HP	7311518235482	10	579
2460	7314151063467	1	250
2461 C19	7314151063498	1	249
2461 C40	7314151063504	1	249
2461 C8	7314151063481	1	249
2463 D19	7314151063511	1	249
2463 D40	7314151063528	1	249
2463 D8	7314151588878	1	249
2464 A10	7314151063535	1	250
2464 A19	7314151063542	1	250
2464 A3	7314151406516	1	250
2464 A40	7314151063559	1	250
2465D-200	7314150120826	1	250
2466 B10	7314151063573	1	250
2466 B19	7314151063580	1	250
2466 B3	7314151406868	1	250
2466 B40	7314151063597	1	250
247-24	7314150367078	1	119
247-27	7314150367085	1	119
247-30	7314150367092	1	119
247-32	7314150367108	1	119
247-34	7314150367115	1	119
247-36	7314150367122	1	119
247-41	7314150367139	1	119
247-46	7314150367146	1	119
247-50	7314150367153	1	119
247-55	7314150367160	1	119
247-60	7314150367177	1	119
2470 G-160	7314150116188	5	242
2470 G-200	7314150116195	5	242
2471 G-160	7314150116225	5	245
2477 G-200	7314150116201	5	244
248-24	7314150367818	1	119
248-27	7314150367825	1	119
248-30	7314150367832	1	119
248-32	7314150367849	1	119
248-34	7314150367856	1	119
248-36	7314150367863	1	119
248-41	7314150367870	1	119
248-46	7314150367887	1	119
248-50	7314150367894	1	119
248-55	7314150367900	1	119
248-60	7314150367917	1	119
2484-20	7314150233250	1	372
2484-30	7314150233267	1	372
2484-45	7314150233274	1	372
2484-60	7314150233281	1	372
2484/S4	7311518276553	10	372
2484T-20	7314150455102	1	372
2484T-30	7314150455119	1	372
2484T-45	7314150455126	1	372
2484T-60	7314150455133	1	372
2484T/S4	7314150455096	1	372
2485	7314150242382	1	348
2487	7311518276058	12	549
2488	7311518276072	12	564
2489	7311518276065	12	564
24A-14	7314150368235	1	120
24A-27	7314150368242	1	120
24F-1	7314150366231	1	118
24F-3/4	7314150366224	1	118
24R-1	7314150365951	1	117
24R-3/4	7314150365944	1	117
24T-1	7314150366156	1	117
24T-3/4	7314150366149	1	117
24W	7314150368266	1	120
250400000	8413345129374	1	566
250400010	7314150314430	1	566
250400020	7314150393008	1	566
250400030	7314150393015	1	567
250501800	8413345128964	50	567

250502450	8413345128957	1	567
2509	7314151064280	50	373
2520	7314150023752	1	238
2520 S	7314150033041	1	509
2520-SH	7311518197506	1	238
2521 G-140	7314150100293	5	246
2521 G-160 IP	7314150100620	5	246
2521D-140IP	7314150447176	5	246
2521D-160IP	7314150447183	5	246
2521G-140IP	7314150447169	5	246
2521G-160	7314150447152	5	246
2521S-140	7314150447190	3	510
2521S-160	7314150447206	3	510
2521V-160	7314150126781	2	511
2530	7314150326761	1	373
2530-40	7314151317294	5	549
2535F0	7314150402236	1	373
2535F1	7314151064495	1	373
2535F2	7314150233854	1	373
2535F3	7314150180233	1	373
2535L	7314150125357	12	373
255-17/34	7314150272372	2	575
255-34	7314150272365	2	575
2555	7311518276041	1	309
256-26	7311518000080	4	575
2600-16-XT11-HP	7311518239527	4	576
2600-19-XT-HP	7311518160760	4	577
2600-22-XT-HP	7311518160777	4	577
2620-80	7311518200947	1	238
2628 D-160	7314150123193	5	240
2628 D-180	7314150042661	5	240
2628 D-200	7314150123315	5	240
2628 G-160	7314150042999	5	239
2628 G-160IP	7314150055357	5	239
2628 G-180	7314150042678	5	239
2628 G-180IP	7314150044030	5	239
2628 G-200	7314150103539	5	239
2628 GC-160IP	7314150101863	5	239
2628 GC-180IP	7314150101870	5	239
2628 GC-200IP	7314150101887	5	239
2628 S-160	7314150206735	3	509
2628 S-180	7314150044054	3	509
2628 S-200	7314150043002	3	509
2628G-200IP	7314150101085	5	239
2629G-160	7314150446933	5	240
2629G-160IP	7314150446964	5	240
2629G-180	7314150446940	5	240
2629G-180IP	7314150446971	5	240
2629G-200	7314150446957	5	240
2629G-200IP	7314150446988	5	240
2630DC-160IP	7314150446896	5	240
2630DC-180IP	7314150446902	5	240
2630DC-200IP	7314150446919	5	240
2630GC-160IP	7314150180165	5	240
2630GC-180IP	7314150180172	5	240
2630GC-200IP	7314150180189	5	240
2630SC-180	7314150446926	3	510
2632	7314151065706	1	372
2633/S4	7311518276942	12	548
2633HD/S6	7314150205783	1	316
2633HD1	7314150230464	1	316
2633HD2	7314150230471	1	316
2633HD3	7314150230488	1	316
2633HD4	7314150230495	1	316
2633HD5	7314150230501	1	316
2633HD6	7314150230518	1	316
2633L/S4	7311518276959	12	548
2635	7311518276348	1	623
2640D-160	7314150123766	10	240
2640D-180	7314150123773	5	240
2640D-200	7314150123797	5	240
2646	7314151304638	1	235
2646 A	7314151304645	1	235
2646 AK	7314151396619	1	235
2646 K	7314151495862	1	235
2646 M	7314151487928	1	235
2646 MF	7314151573683	1	245
2646 MS	7314151573768	1	246
2646 R	7314151304706	1	235
2646 RA	7314151834838	1	235
2646 RK	7314151496678	1	235
2648	7314151304713	1	235
2648 A	7314151304720	1	235
2649	7314150058013	1	235
2650	7314151065829	1	248
2650 B	7314151065843	1	248
2656	7314151304737	1	237
2656 R	7314151473976	1	244
2656 S	7314150058044	1	242
2666	7314150058006	1	235
2666 FK	7314151066079	1	235
2674 NB	7314151066321	1	234
2674 NVDE	7314151498535	1	509
2676 B	7314151066390	1	235
2678 B	7314151066468	1	235
2678 G-160	7314150116157	5	241



2678 G-180



2678 G-180	7314150116164	5	241
2678 G-200	7314150116171	5	241
2678V-160	7314150126835	2	510
2678V-180	7314150126842	2	510
2678V-200	7314150126859	2	510
268	7311518017538	5	571
2681	7311518276706	12	262
2681-1	7314150116980	1	263
2688D-250	7314150123520	3	240
2690	7314150411108	10	263
26S-1216	7314151830236	8	59
26S-16	7314150345588	5	59
26S-610	7314151830229	10	59
2700-22-XT7-HP	7311518191672	4	579
2700-24-XT7-HP	7311518191665	4	579
2704A	7314151066963	1	593
2705R	7314151821470	1	593
2720	7314150179701	1	238
2720-SH	7314150179718	1	238
2744	7314151809096	6	593
277-30	7314150367184	1	119
277-32	7314150367191	1	119
277-34	7314150367207	1	119
277-36	7314150367214	1	119
277-41	7314150367221	1	119
277-46	7314150367238	1	119
277-50	7314150367245	1	119
277-55	7314150367252	1	119
277-60	7314150367269	1	119
278-30	7314150367924	1	119
278-32	7314150367931	1	119
278-34	7314150367948	1	119
278-36	7314150367955	1	119
278-41	7314150367962	1	119
278-46	7314150367979	1	119
278-50	7314150367986	1	119
278-55	7314150367993	1	119
278-60	7314150368006	1	119
2784-2.5	7314150215607	1	214
2784-3.5	7314150215614	1	214
2784-4.5	7314150215621	1	214
2787 F	7314151474270	1	236
2787 G	7314150058020	1	236
27A-24	7314150368259	1	120
27F-1	7314150366248	1	118
27M-10-11	7314150180523	10	58
27M-12-13	7314150180547	10	58
27M-13-17	7314150180790	10	58
27M-14-15	7314150180554	10	58
27M-16-17	7314150180561	10	58
27M-16-18	7314150180806	10	58
27M-18-19	7314150180578	10	58
27M-20-22	7314150180585	10	58
27M-21-23	7314150180592	5	58
27M-21-24	7314150180813	5	58
27M-24-26	7314150180608	5	58
27M-24-27	7314150180820	5	58
27M-25-28	7314150180622	5	58
27M-27-29	7314150180639	5	58
27M-30-32	7314150180646	5	58
27M-6-7	7314150180509	10	58
27M-8-9	7314150180516	10	58
27M/10	7314150180677	1	58
27M/12	7314150180684	1	59
27M/12T	7314150180783	1	58
27M/6	7314150180653	1	58
27M/8	7314150180660	1	58
27M/8T	7314150180776	1	58
27R-1	7314150365968	1	117
27T-1	7314150366163	1	117
28-29/S4	7314150179688	1	251
2800 N	7314151318338	1	239
2800-140	7314150121632	3	249
2800-150	7314150034567	3	249
2800-180	7314150034581	3	249
2800-225	7314150034604	3	249
2800-300	7314150122622	1	249
2801 N	7314151318352	1	239
2804	7314151692698	1	238
2805-280	7314151826123	1	238
2820EF1	7314150122042	12	599
2820EF2	7314150122059	8	599
2820EF3	7314150122066	1	600
2820EF4	7314150122073	1	600
2820EK	7314150122035	6	599
2820EK-01	7314150270743	12	599
2820V13	7314150121823	1	512
2820VBC	7314150121915	1	509
2820VDE	7314151605476	10	513
2820VFP	7314150121922	1	513
2820VG05	7314150121953	1	514
2820VG10	7314150121960	1	514
2820VGCOT	7314150121977	1	514
2820VHELP	7314150121908	1	513
2820VMM	7314150121946	1	514
2820VP	7314150121885	2	513



2820VPC	7314150121892	2	513
2820VTEE	7314150121939	1	513
2855	7314151825805	1	264
2855 D	7314151822569	1	264
2856-10	7314150437214	1	264
2856-8	7314150437207	1	264
2890-125	7314150122639	3	249
2890-140	7314150034550	3	249
2890-180	7314150034574	3	249
2890-210	7314150034598	3	249
2890-300	7314150122646	1	249
28M-10	7314151834678	5	56
28M-11	7314151834685	5	56
28M-12	7314151834692	5	56
28M-13	7314151834708	5	56
28M-14	7314151834715	5	56
28M-15	7314151834722	5	56
28M-16	7314151834739	5	56
28M-17	7314151834746	5	56
28M-18	7314151834753	3	56
28M-19	7314151834760	3	56
28M-20	7314150122561	3	56
28M-21	7314151834777	3	56
28M-22	7314151834784	3	56
28M-23	7314150122578	3	56
28M-24	7314151834791	3	56
28M-25	7314150122585	3	56
28M-26	7314150122592	3	56
28M-27	7314151834807	3	56
28M-28	7314150122608	1	56
28M-29	7314150122615	1	56
28M-30	7314151834814	1	56
28M-32	7314151834821	1	56
28M-6	7314151834630	5	56
28M-7	7314151834647	5	56
28M-8	7314151834654	5	56
28M-9	7314151834661	5	56
28M/11	7314151838126	1	57
28M/12	7314151838133	1	57
28M/15	7314151838140	1	57
28M/8	7314151838119	1	57
28MV-10	7314150121298	2	512
28MV-11	7314150121304	2	512
28MV-12	7314150121311	2	512
28MV-13	7314150121328	2	512
28MV-14	7314150121335	2	512
28MV-15	7314150121342	2	512
28MV-16	7314150121359	2	512
28MV-17	7314150121366	2	512
28MV-18	7314150121373	2	512
28MV-19	7314150121380	2	512
28MV-20	7314150121397	2	512
28MV-21	7314150121403	2	512
28MV-22	7314150121410	2	512
28MV-8	7314150121274	2	512
28MV-9	7314150121281	2	512
29-B	7311518277703	1	328
2900-140	7314150121045	3	249
2900-150	7314150034499	3	249
2900-180	7314150034512	3	249
2900-215	7314150034536	3	249
2900-300	7314150121076	1	249
2928-1	7314150056583	1	250
2928-160	7314150056514	1	250
2928-2	7314150056590	1	250
2928-200	7314150056521	1	250
2928-250	7314150056538	1	250
2928-3	7314150056606	1	250
2928-4	7314150056613	1	250
2949-190IP	7314150123926	1	262
2949-200IP	7314150123940	1	262
2949-240IP	7314150123957	1	262
2949-250IP	7314150123971	1	262
2949-L075	7314150440559	1	262
2949-L120	7314150440566	1	262
2949-L200	7314150440573	1	262
2950-250	7314150124039	1	261
2951-140	7314150124084	1	259
2951-180	7314150102204	1	259
2951-250	7314150102211	1	259
2951-300	7314150102228	1	259
2951-S05	7314150447299	1	262
2951-S07	7314150447305	1	262
2951-S10	7314150447312	1	262
2951-S12	7314150447329	1	262
2952-165	7314150103836	1	259
2952-235	7314150103843	1	259
2953-140	7314150124046	1	259
2953-200	7314150124053	1	259
2953-250	7314150124060	1	259
2953-300	7314150124077	1	259
2955-250	7314150102235	1	260
2956-290	7314150413690	1	261
2957-250	7314150102259	1	259
2958-140	7314150124104	1	259
2958-200	7314150124114	1	259



2958-250	7314150102242	1	259
296	7311518034146	1	581
2960-280	7314150412808	1	260
2962-8-150	7314150412815	1	261
2962-8-230	7314150413706	1	261
2962-8-300	7314150413713	1	261
2963-280	7314150102280	1	260
2963-450	7314150124138	1	260
2963-630	7314150124145	1	260
2964-160	7314150124183	1	261
2964-280	7314150102297	1	261
2964-450	7314150124190	1	261
2964-600	7314150124206	1	261
2965-200	7314150124152	1	261
2965-280	7314150102266	1	261
2966-280	7314150102273	1	261
2967-180	7314150102396	1	260
2968-190	7314150124091	1	259
2968-235	7314150103850	1	259
2970G-200	7314150134946	5	241
2971G-250	7314150117154	5	248
2979 D-180	7314150034246	5	246
2990-125	7314150121250	3	249
2990-140	7314150034482	3	249
2990-180	7314150034505	3	249
2990-200	7314150034529	3	249
2990-300	7314150121267	1	249
2997-250	7314150124237	1	262
2997-300	7314150124244	5	262
2998-250	7314150124213	1	260
2998-SHN	7314150447275	1	260
2999-250	7314150124169	1	260
2999-SHN	7314150447282	1	260
29M-10	7314150122318	5	56
29M-11	7314150122325	5	56
29M-12	7314150122332	5	56
29M-13	7314150122349	5	56
29M-14	7314150122356	5	56
29M-15	7314150122363	5	56
29M-16	7314150122370	5	56
29M-17	7314150122387	5	56
29M-18	7314150122394	3	56
29M-19	7314150122400	3	56
29M-20	7314150122417	3	56
29M-21	7314150122424	3	56
29M-22	7314150122431	3	56
29M-23	7314150122448	3	56
29M-24	7314150122455	3	56
29M-25	7314150122462	3	56
29M-26	7314150122479	3	56
29M-27	7314150122486	3	56
29M-28	7314150122493	1	56
29M-29	7314150122509	1	56
29M-30	7314150122516	1	56
29M-32	7314150122523	1	56
29M-6	7314150122271	5	56
29M-7	7314150122288	5	56
29M-8	7314150122295	5	56
29M-9	7314150122301	5	56
29M/10	7314150122547	1	57
29M/14	7314150122554	1	57
29M/8	7314150122530	1	57
2M-10-11	7314151001223	5	52
2M-10-13	7314151001513	5	52
2M-12-13	7314151001230	5	52
2M-13-17	7314151343972	5	52
2M-14-15	7314151001247	5	52
2M-16-17	7314151001254	5	52
2M-16-18	7314151001575	5	52
2M-17-19	7314151000844	5	52
2M-18-19	7314151001261	5	52
2M-19-22	7314151000868	5	52
2M-20-22	7314151001278	5	52
2M-21-23	7314151001285	5	52
2M-22-24	7314151001612	5	52
2M-24-26	7314151001292	5	52
2M-24-27	7314151000899	5	52
2M-25-28	7314151001308	5	52
2M-27-29	7314150205332	5	52
2M-27-30	7314151001636	5	52
2M-27-32	7314151001322	5	52
2M-30-32	7314151000929	5	52
2M-32-36	7314151001667	1	52
2M-36-41	7314151001681	1	52
2M-41-46	7314151001704	1	52
2M-46-50	7314151001711	1	52
2M-6-7	7314151001209	5	52
2M-8-10	7314151001506	5	52
2M-8-9	7314151001216	5	52
2M/10T	7314150212996	1	52
2M/12T	7314151001414	1	52
2M/8T	7314151001391	1	52
2M/S8	7314151827335	1	52
2MV-10	7314150121113	5	512
2MV-11	7314150121120	5	512
2MV-12	7314150121137	5	512



2MV-13	7314150121144	5	512
2MV-14	7314150121151	5	512
2MV-15	7314150121168	5	512
2MV-16	7314150121175	5	512
2MV-17	7314150121182	3	512
2MV-18	7314150121199	3	512
2MV-19	7314150121205	3	512
2MV-21	7314150121212	3	512
2MV-22	7314150121229	3	512
2MV-23	7314150121236	3	512
2MV-24	7314150121243	3	512
2MV-6	7314150121069	5	512
2MV-7	7314150121083	5	512
2MV-8	7314150121090	5	512
2MV-9	7314150121106	5	512
2Z-1-1.1/8	7314151001827	1	52
2Z-1.1/16-1.1/4	7314151001834	1	52
2Z-1/2-9/16	7314151001445	1	52
2Z-1/4-5/16	7314151001421	1	52
2Z-13/16-7/8	7314151001797	1	52
2Z-15/16-1	7314151001810	1	52
2Z-3/4-7/8	7314151001773	1	52
2Z-3/8-7/16	7314151001438	1	52
2Z-5/16-3/8	7314151001728	1	52
2Z-5/8-11/16	7314151001452	1	52
2Z-9/16-5/8	7314151001735	1	52
2Z/7T	7314150217373	1	53
3-24-51	7315962500028	5	648
3-330-12-1-0	7311518020712	5	31
3-330-12-2-0	7311518020729	5	31
3-330-14-1-0	7311518020736	5	31
3-330-14-2-0	7311518020743	5	31
3-331-14-1-0	7311518020750	5	31
300-14-F15/16-HP	7311518005955	4	575
301	7311518001384	50	581
301-16	7314150456048	12	269
301-22	7311518293673	12	269
302	7311518013349	30	580
302-15-95	7314150486632	100	269
302-35	7311518293680	6	269
302-511W-12P	7311518207786	1	581
302-51W-12P	7311518013356	1	581
302-53W-12P	7311518013363	1	581
302-55W-12P	7311518013370	1	581
302-57W-12P	7311518013387	1	581
302-59W-12P	7311518207779	1	581
302-6X4P	7311518017590	1	581
302-71M-12P	7311518013394	1	581
302-73M-12P	7311518013400	1	581
302-75M-12P	7311518013417	1	581
302-76-95	7314150188345	1	269
302-76N	7314150456307	6	269
302-77M-12P	7311518207793	1	581
302-81S-12P	7311518013677	1	581
302-83S-12P	7311518013684	1	581
302-85S-12P	7311518207809	1	581
302-95-SET	7314150456321	1	269
303-5P	7311518031435	10	581
304	7311518265533	10	570
304S/1VDE	7314151783815	1	515
304S-V1	7314150128785	1	515
304S-V2	7314150128792	1	515
3046-OP	7311518276980	12	549
3046-REF	7311518276966	1	309
3049-2	7314151848118	1	478
306	7311518265540	10	570
306-10	7314150120246	1	268
306-12	7314150120253	1	268
306-15	7311518297107	12	268
306-15-95	7311518297329	1	269
306-22	7311518297114	12	268
306601500	8413345098700	5	602
306602000	8413345098717	5	602
306603000	8413345217033	5	602
306604000	8413345217095	5	602
306703000	8413345217194	5	602
306704000	8413345098755	5	602
306705000	8413345098762	5	602
306706000	8413345098779	5	602
306708000	8413345098786	5	602
306710000	8413345098793	5	602
306712000	8413345123334	2	602
306715000	8413345123341	2	602
306803000	8413345098809	5	602
306804000	8413345098816	5	602
306805000	8413345098823	2	602
306806000	8413345098830	2	602
306808000	8413345098847	2	602
306810000	8413345098854	2	602
306812000	8413345098861	2	602
306815000	8413345098878	1	602
306820000	8413345098885	1	602
306903000	8413345123402	2	602
306904000	8413345123419	2	602
306905000	8413345123426	2	602
306906000	8413345123433	2	602





306908000	8413345123457	2	602
306910000	8413345123471	2	602
307401B	7314150254958	1	268
307411B	7314150254965	1	268
307421B	7314150254972	1	268
307431B	7314150254989	1	268
307441	7314150235933	1	268
307451	7314150235940	1	268
308504000	8413345035156	1	558
308505000	8413345035194	1	558
308506000	8413345035163	1	558
308508000	8413345035170	1	558
308510000	8413345035187	1	558
3090-20-XT11-HP	7311518181369	4	577
31	7314150004942	5	40
31 IP	7314150004959	50	40
31-T	7314150483709	5	40
31-T IP	7314150483723	50	40
3100TB	7314150125364	1	472
3100TB-DISP	7314150400300	1	473
310M-24	7314151829612	1	56
310M-27	7314151829629	1	56
310M-30	7314151829636	1	56
310M-32	7314151829643	1	56
310M-36	7314151829650	1	56
310M-38	7314151829667	1	56
310M-41	7314151829674	1	56
310M-46	7314151829681	1	56
310M-50	7314151829698	1	56
310M-55	7314151829704	1	56
310M-60	7314151829711	1	56
310M-65	7314151829728	1	56
310M-70	7314151829735	1	56
310M-75	7314151829742	1	56
310M-80	7314151829759	1	56
310M-85	7314151829766	1	56
310M-90	7314151829773	1	56
310M-95	7314151829780	1	56
311-32	7314150120215	6	270
311-42	7311518295523	6	270
3115	7314150055326	1	366
3149-OR	7311518292249	1	471
3149-ORFF1	7314150292479	1	440
3149-ORTS1	7314150292066	1	440
3150-12-XT9-HP	7311518181406	4	574
315M-27	7314150133291	1	55
315M-30	7314150133307	1	55
315M-32	7314150133314	1	55
315M-36	7314150133321	1	55
315M-41	7314150133345	1	55
315M-46	7314150133352	1	55
315M-50	7314150133369	1	55
315M-55	7314150133376	1	55
315M-60	7314150133383	1	55
315M-65	7314150133390	1	55
315M-70	7314150133406	1	55
315M-75	7314150133413	1	55
315M-80	7314150133420	1	55
315Z-1.1/16	7314150133437	1	56
315Z-1.1/2	7314150133505	1	56
315Z-1.1/4	7314150133468	1	56
315Z-1.1/8	7314150133444	1	56
315Z-1.11/16	7314150133529	1	56
315Z-1.13/16	7314150133543	1	56
315Z-1.15/16	7314150133567	1	56
315Z-1.3/16	7314150133451	1	56
315Z-1.3/4	7314150133536	1	56
315Z-1.3/8	7314150133482	1	56
315Z-1.5/16	7314150133475	1	56
315Z-1.5/8	7314150133512	1	56
315Z-1.7/16	7314150133499	1	56
315Z-1.7/8	7314150133550	1	56
315Z-2	7314150133574	1	56
315Z-2.1/16	7314150133581	1	56
315Z-2.1/2	7314150133642	1	56
315Z-2.1/4	7314150133611	1	56
315Z-2.1/8	7314150133598	1	56
315Z-2.15/16	7314150133697	1	56
315Z-2.3/16	7314150133604	1	56
315Z-2.3/4	7314150133673	1	56
315Z-2.3/8	7314150133635	1	56
315Z-2.5/16	7314150133628	1	56
315Z-2.5/8	7314150133666	1	56
315Z-2.7/8	7314150133680	1	56
315Z-2.9/16	7314150133659	1	56
315Z-3	7314150133703	1	56
315Z-3.1/8	7314150133840	1	56
316-1	7311518296216	12	271
316-2	7311518296223	12	271
316-2-95	7311518296278	1	271
317	7311518240936	10	570
317-40	7311518296230	12	271
318-38	7311518296247	1	271
318-54	7311518296254	1	271
3180-14-XT11-HP	7311518181390	4	576
319	7311518240943	5	570



320	7311518265557	10	570
321	7311518001841	5	570
321-18-SB	7311518129125	10	572
321-24-SB	7311518129132	10	572
321-7-SB	7311518129149	10	572
322500300	8413345012829	1	547
322500500	8413345012836	1	547
322500800	8413345012843	1	547
322510300	8413345015899	1	547
322510400	8413345137386	1	547
322510500	8413345015905	1	547
322510600	8413345137393	1	547
322510700	8413345137409	1	547
322510800	8413345015912	1	547
3240-14-XT11-HP	7311518243005	4	576
325	7311518214852	5	570
325001000	8413345000505	1	547
3250010SH	8413345137492	1	547
326000200	8413345000529	1	547
326000300	8413345012881	1	547
326010200	8413345016100	1	547
326020200	8413345016117	1	547
326030200	8413345016124	1	547
327020500	7314150330584	1	547
327020500-SH1	7314150361021	1	548
327020500-SH2	7314150361038	1	548
327020500-SH3	7314150361045	1	548
327020500-SH4	7314150361052	1	548
3280M	7314151071318	1	50
329000330	8413345000741	1	548
329000500	8413345000758	1	548
329500300	7314150181001	1	547
329500350	7314150181049	1	548
329500400	7314150181018	1	547
329500450	7314150181056	1	548
329600100	7314150181063	1	548
329600200	7314150181070	1	548
329600500	7314150181025	1	547
329600800	7314150181032	1	547
331-15-23	7311518274658	5	647
331-21-51-KP	7311518003814	5	647
332-21-51	7311518229337	5	647
333	7311518005832	5	648
333-5	7311518005849	10	648
339-6T	7311518128371	4	644
33H	7314150266791	5	40
340-6T	7311518002008	4	644
341	7314150113729	1	266
3416 A	7314150216260	1	252
3416 A SH	7314150410941	1	252
3416 B	7314150411160	10	251
3416 B SH	7314150411191	10	251
3417 A	7314150216277	12	253
3418 A	7314150216284	1	252
3419 B	7314151812416	1	254
3419 B SH	7314150504381	1	254
342	7314150113736	1	266
343	7314150113743	1	266
344	7314150113750	1	266
349	7311518018924	4	648
3517 A	7314150410910	1	253
3518 A	7314150216376	1	252
3518 A SH	7314150216383	1	252
3518 B	7314150410927	1	252
3520 A	7314150410934	1	252
3520 A SH	7314150410958	1	252
3520 B	7314150411177	10	252
3520 B SH	7314150411207	10	252
3524	7314151073336	1	549
3524L-K	7314151339807	1	549
3525HB	7314151073350	5	549
36	7314150223381	5	607
361-10	7311518295202	1	267
361-12	7311518295219	1	267
361-14	7311518295226	1	267
361-18	7311518295233	1	267
361-24	7311518295240	1	267
361-36	7311518295257	4	267
361-8	7311518295196	1	267
3619 A	7314150411184	10	253
3619 A SH	7314150411214	10	253
3625AR-35	7314150214723	34	610
3625AR-50	7314150214730	18	610
3625AR-60	7314150214747	12	610
3625ARL-35	7314150214754	6	610
3625ARL-50	7314150214761	6	610
3625ARL-60	7314150214778	6	610
3625ARLH-35	7314150218677	80	611
3625ARLH-50	7314150218684	50	611
3625ARLH-60	7314150218691	16	611
3625N-22	7314151073602	6	611
3625N-32	7314151073640	6	611
3625N-40	7314151073688	6	611
3625N-50	7314151073701	6	611
3625NL-22	7314151073831	20	612
3625NL-32	7314151073855	20	612



3625NL-40	7314151073879	20	612
3625NL-50	7314151073886	20	612
3625PU-105	7314150170098	4	611
3625PU-30	7311518276119	12	611
3625PU-50	7311518276126	6	611
3625PU-60	7311518276133	6	611
3625RM-55	7314150120758	50	612
3625RM-65	7314150120765	40	612
3625RM-75	7314153019820	30	612
3625RM-90	7314150120390	20	612
3625S-28	7314150183906	50	612
3625S-35	7314150183913	30	612
3625S-44	7314150183920	18	612
3625W-22	7314150120406	120	612
3625W-28	7314150120413	72	612
3625W-35	7314150120420	40	612
3625W-44	7314150120437	1	612
3625W-55	7314150120444	12	612
3625WL-22	7314150120451	10	612
3625WL-28	7314150120468	10	612
3625WL-35	7314150120475	10	612
3625WL-44	7314150120482	10	612
3625WL-55	7314150120499	6	612
3625WLH-22	7314150219025	50	612
3625WLH-28	7314150218981	50	612
3625WLH-35	7314150218998	80	612
3625WLH-44	7314150219001	50	612
3625WLH-55	7314150219018	16	612
3625Y-22	7314151074074	6	611
3625Y-32	7314151074098	6	611
3625Y-40	7314151074111	6	611
3625Y-50	7314151074128	6	611
3625YL-22	7314151074159	20	611
3625YL-32	7314151074173	20	611
3625YL-40	7314151074197	20	611
3625YL-50	7314151074203	20	611
363-32	7311518295578	1	268
3640-150-C	7314150180691	25	618
3640-175-C	7314150180707	6	618
3640-200-C	7314150180714	25	618
3640-250-C	7314150180721	20	618
3640-300-C	7314150180738	25	618
3643-100	7314151074654	50	620
3643-120	7314151074678	50	620
3643-150	7314151074685	50	620
3644-120	7314151074708	50	620
3644-125	7314151074722	50	620
3644-130	7314151074746	50	620
3644-150	7314151074760	50	620
3644-165	7314151074777	50	620
3644-180	7314151074791	50	620
3644-200	7314151074807	50	620
3646-115	7314151074937	250	621
3646-125	7314151074944	250	621
3646-150	7314151074951	125	621
3646-165	7314151074968	125	621
3646-180	7314151074975	50	621
3646-200	7314151074982	50	621
3646/6	7314151074999	25	621
3649-125	7314150472413	50	618
3654BMS/7	7314150220816	1	624
3654R	7314151075132	1	621
3656-125	7314150472352	50	618
3656-150	7314150472376	50	618
3656-175	7314150472390	1	618
3656/10	7314151075279	1	622
3658A-2	7314151075293	125	621
3658A-3	7314151075309	125	621
3658A-4	7314151075316	125	621
3658A-5	7314151075323	125	621
3658A-6	7314151075330	125	621
3658A-8	7314151075347	50	621
3658A/6	7314151075354	30	622
3659-0.9	7314151075507	5	621
3659-1.4	7314151075514	5	621
3659-1.8	7314151597351	5	621
3659-2.4	7314151075538	5	621
3659-2.8	7314151597436	5	621
3659-3.4	7314151075552	5	621
3659-3.9	7314151075569	5	621
3659-6.0	7314151075576	5	621
3659/8	7314151075583	1	622
3659/8T	7314151472573	1	622
3680	7314151075835	1	372
3681-11	7314150132980	1	373
3681-16	7314150132997	1	373
3681-20	7314150133000	1	373
3683	7314151075866	1	373
3684-16	7314150133017	1	372
3684-18	7314150133024	1	372
3684-24	7314150133031	1	372
3684-30	7314150133048	1	372
369-BLADE	7311518016531	20	575
370-4	7311518296193	1	268
3717 A	7314150489916	1	253
3718 A	7314150489930	12	253



3719 A	7314150489954	12	253
372-1.1/2	7314150133239	1	267
372-12	7314150133284	1	267
372-2.1/2	7314150133246	1	267
372-4	7314150133253	1	267
372-6	7314150133260	1	267
372-8	7314150133277	1	267
3733-2	7314151834371	50	621
3733-3	7314151834388	50	621
3733-4	7314151834395	50	621
3733-5	7314151834401	50	621
3733-6	7314151834418	50	621
3733S/5	7314150220809	25	622
3734-2	7314151834296	50	621
3734-3	7314151834319	50	621
3734-4	7314151834326	50	621
3734-5	7314151834333	50	621
3734-6	7314151834340	50	621
3734-8	7314151834357	50	621
3734BMS/7	7314150220755	1	624
3734N-10-150	7314150218110	10	621
3734N-2-150	7314150218042	10	621
3734N-3-150	7314150218059	10	621
3734N-4-150	7314150218066	10	621
3734N-5-150	7314150218073	10	621
3734N-6-150	7314150218080	10	621
3734N-7-150	7314150218097	10	621
3734N-8-150	7314150218103	10	621
3734N-9-150	7314150218127	10	621
3734NS/9	7314150218134	10	622
3734S/6	7314151834470	5	622
3735-4-120	7314151834265	50	620
3735-5-120	7314151834272	50	620
3735-5-150	7314151834289	50	620
3735N-2-100	7314150217953	10	620
3735N-4-120	7314150217960	10	620
3735N-5-120	7314150217977	10	620
3735N-6-150	7314150217984	10	620
3735N-8-150	7314150217991	10	620
3735NS/4	7314150218004	25	620
3736M-200	7314150220878	30	619
3736M-250	7314151834142	25	619
3736M-300	7314151834159	10	619
3736M-400	7314151834166	10	619
3736MH-250	7314151834173	10	619
3736MH-300	7314151834180	10	619
3736MH-400	7314151834197	5	619
3736S/6	7314151834463	5	619
3739-250	7314151834203	25	619
3739-300	7314151834210	10	619
3739-400	7314151834227	10	619
3739H-250	7314151834234	15	619
3739H-300	7314151834241	10	619
3739H-400	7314151834258	10	619
3740-100	7314151834005	50	618
3740-125	7314151834012	50	618
3740-150	7314151834029	50	618
3740-175	7314151834036	25	618
3740-200	7314151834043	25	618
3740-250	7314151834050	10	618
3740-300	7314151834067	10	618
3745-150	7314151834081	50	618
3745-175	7314151834098	25	618
3745-200	7314151834104	20	618
3745-250	7314151834111	10	618
3749-125	7314150457915	50	618
375-8	7311518296209	50	268
3750	7314151834128	25	618
3750H	7314151834135	25	619
3756-125	7314150457892	50	618
3756-150	7314150457908	50	618
38-12	7314151831264	5	331
38-16	7314151831271	5	331
38-20	7314151831288	2	331
38-24	7314151831295	1	331
38-8	7314151831257	5	331
380-10	7314150133178	1	267
380-14	7314150133185	1	267
380-18	7314150133192	1	267
380-24	7314150133208	1	267
380-36	7314150133215	1	267
380-48	7314150133222	1	267
3802-300-25-1.25-10	7311518111229	10	20
3802-300-25-1.25-14	7311518111236	10	20
3802-300-25-1.25-6	7311518143299	10	20
3802-300-32-1.60-10	7311518111274	10	20
3802-300-32-1.60-6	7311518111298	10	20
3802-350-25-1.25-10	7311518111335	10	20
3802-350-25-1.25-14	7311518111342	10	20
3802-350-25-1.25-6	7311518111359	10	20
3802-350-32-1.60-10	7311518111397	10	20
3802-350-32-1.60-14	7311518111403	10	20
3802-350-32-1.60-4	7311518111410	10	20
3802-350-32-1.60-6	7311518111427	10	20
3802-350-32-1.60-8	7311518140908	10	20
3802-400-25-1.25-10	7311518111496	10	20



3802-400-25-1.25-14



3802-400-25-1.25-14	7311518111502	10	20
3802-400-25-1.25-6	7311518111519	10	20
3802-400-32-1.60-10	7311518111557	10	20
3802-400-32-1.60-14	7311518111564	10	20
3802-400-32-1.60-4	7311518111571	10	20
3802-400-32-1.60-6	7311518111588	10	20
3802-400-32-1.60-8	7311518111595	10	20
3802-400-38-2.00-10	7311518111649	10	20
3802-400-38-2.00-4	7311518111656	10	20
3802-400-38-2.00-6	7311518111663	10	20
3802-425-32-1.60-10	7311518111694	10	20
3802-425-32-1.60-6	7311518111700	10	20
3802-450-32-1.60-10	7311518111731	10	20
3802-450-32-1.60-14	7311518111748	10	20
3802-450-32-1.60-4	7311518111755	10	20
3802-450-32-1.60-6	7311518111762	10	20
3802-450-38-2.00-10	7311518111816	10	20
3802-450-38-2.00-10-KA	7311518111823	10	20
3802-450-38-2.00-4	7311518111830	10	20
3802-450-38-2.00-4-KA	7311518111847	10	20
3802-450-38-2.00-6	7311518111854	10	20
3802-450-38-2.00-6-KA	7311518111861	10	20
3802-450-38-2.00-8	7311518111878	10	20
3802-450-38-2.00-8-KA	7311518111885	10	20
3802-475-38-2.00-8	7311518111317	10	20
3802-500-38-2.00-10	7311518111953	10	20
3802-500-38-2.00-4	7311518111960	10	20
3802-500-38-2.00-6	7311518111977	10	20
3802-500-38-2.00-8	73115181113070	10	20
3802-500-45-2.25-10	7311518111984	10	20
3802-500-50-2.50-4	7311518112028	10	20
3802-500-50-2.50-4-KA	7311518112035	10	20
3802-500-50-2.50-6	7311518112042	10	20
3802-500-50-2.50-6-KA	7311518112059	10	20
3802-525-38-2.00-10	7311518112073	10	20
3802-525-38-2.00-6	7311518112097	10	20
3802-525-38-2.00-8	7311518112103	10	20
3802-550-38-2.00-6	7311518112158	10	20
3802-550-50-2.50-10	7311518112196	10	20
3802-550-50-2.50-4	7311518112202	10	20
3802-550-50-2.50-4-KA	7311518112219	10	20
3802-550-50-2.50-6	7311518112226	10	20
3802-550-50-2.50-8	7311518112240	5	20
3802-550-50-2.50-8-KA	7311518113315	10	20
3802-575-50-2.50-3-KA	7311518112301	10	20
3802-575-50-2.50-4	7311518112318	10	20
3802-575-50-2.50-4-KA	7311518112325	10	20
3802-575-50-2.50-6	7311518112332	10	20
3802-575-50-2.50-6-KA	7311518112349	10	20
3802-600-50-2.50-4	7311518112417	10	20
3802-600-50-2.50-6	7311518112431	10	20
3802-600-50-2.50-8	7311518112455	10	20
3802-650-50-2.50-4	7311518112509	5	20
3802-650-50-2.50-4-KA	7311518112523	5	20
3802-650-50-2.50-6	7311518112530	5	20
3802-650-50-2.50-6-KA	7311518112554	5	20
3802-700-50-2.50-2-KA	7311518112578	5	20
3802-700-50-2.50-3	7311518112585	5	20
3802-700-50-2.50-4	7311518112608	5	20
3802-700-50-2.50-4-KA	7311518112615	5	20
3802-700-50-2.50-6	7311518112622	5	20
3802-700-50-2.50-6-KA	7311518112639	5	20
3802-750-50-2.50-4	7311518112660	5	20
3802-750-50-2.50-6	7311518112677	5	20
3806-600-32	7311518018092	10	57
3809-300-25-1.25-10	7311518113711	10	19
3809-300-25-1.25-14	7311518113728	10	19
3809-300-32-1.60-10	7311518113735	10	19
3809-300-32-1.60-6	7311518113742	10	19
3809-350-25-1.25-10	7311518113759	10	19
3809-350-25-1.25-14	7311518113766	10	19
3809-350-25-1.25-6	7311518113773	10	19
3809-350-32-1.60-10	7311518113780	10	19
3809-350-32-1.60-14	7311518113797	10	19
3809-350-32-1.60-4	7311518113803	10	19
3809-350-32-1.60-6	7311518113810	10	19
3809-350-32-1.60-8	7311518113827	10	19
3809-350-32-2.00-10	7311518113834	10	19
3809-350-32-2.00-4	7311518113841	10	19
3809-350-32-2.00-6	7311518113858	10	19
3809-350-38-2.00-10	7311518113865	10	19
3809-350-38-2.00-6	7311518113889	10	19
3809-400-25-1.25-10	7311518178666	10	19
3809-400-32-1.60-10	7311518113896	10	19
3809-400-32-1.60-14	7311518113902	10	19
3809-400-32-1.60-4	7311518113919	10	19
3809-400-32-1.60-6	7311518113933	10	19
3809-400-32-1.60-8	7311518113940	10	19
3809-400-32-2.00-10	7311518113957	10	19
3809-400-32-2.00-4	7311518113964	10	19
3809-400-32-2.00-6	7311518113971	10	19
3809-400-32-2.00-6-KA	7311518158248	10	20
3809-400-32-2.00-8	7311518114152	10	19
3809-400-38-2.00-10	7311518113988	10	19
3809-400-38-2.00-4	7311518113995	10	19
3809-400-38-2.00-6	7311518114008	10	19



3809-425-32-1.60-10	7311518114015	10	19
3809-425-32-1.60-6	7311518197759	10	19
3809-450-32-1.60-10	7311518114022	10	19
3809-450-32-1.60-14	7311518114039	10	19
3809-450-32-1.60-4	7311518114046	10	19
3809-450-32-1.60-6	7311518114053	10	19
3809-450-32-2.00-10	7311518114060	10	19
3809-450-32-2.00-4	7311518114077	10	19
3809-450-32-2.00-6	7311518114084	10	19
3809-450-38-2.00-10	7311518114091	10	19
3809-450-38-2.00-10-KA	7311518114107	10	20
3809-450-38-2.00-4	7311518114114	10	19
3809-450-38-2.00-4-KA	7311518114121	10	20
3809-450-38-2.00-6	7311518114138	10	19
3809-450-38-2.00-6-KA	7311518114145	10	20
3809-450-38-2.00-8	7311518114176	10	19
3809-450-45-2.25-4	7311518114206	10	19
3809-450-45-2.25-6	7311518114213	10	19
3809-475-45-2.25-6	7311518114237	10	19
3809-500-38-2.00-10	7311518114244	10	19
3809-500-38-2.00-4	7311518114251	10	19
3809-500-38-2.00-6	7311518114268	10	19
3809-500-45-2.25-4	7311518114275	10	19
3809-500-45-2.25-6	7311518114299	10	19
3809-500-45-2.25-6-KA	7311518114305	10	20
3809-500-50-2.50-4	7311518114312	10	19
3809-500-50-2.50-4-KA	7311518114329	10	20
3809-500-50-2.50-6	7311518114336	10	19
3809-500-50-2.50-6-KA	7311518114343	10	20
3809-500-50-2.50-8	7311518114350	10	19
3809-525-38-2.00-10	7311518114367	10	19
3809-525-38-2.00-6	7311518114374	10	19
3809-525-45-2.25-4	7311518114381	10	19
3809-525-45-2.25-6	7311518114398	10	19
3809-550-45-2.25-4	7311518114411	10	19
3809-550-45-2.25-6	7311518114428	10	19
3809-550-50-2.50-4	7311518114435	10	19
3809-550-50-2.50-4-KA	7311518114442	10	20
3809-550-50-2.50-6	7311518114459	10	19
3809-550-50-2.50-6-KA	7311518114466	10	20
3809-575-45-2.25-4	7311518114473	10	19
3809-575-50-2.50-10-KA	7311518114497	10	20
3809-575-50-2.50-3	7311518114602	10	19
3809-575-50-2.50-3-KA	7311518114503	10	19
3809-575-50-2.50-4	7311518114510	10	19
3809-575-50-2.50-4-KA	7311518114527	10	20
3809-575-50-2.50-6	7311518114534	10	19
3809-575-50-2.50-6-KA	7311518114541	10	20
3809-600-38-2.00-6	7311518227579	10	19
3809-600-45-2.25-4	7311518172275	10	19
3809-600-45-2.25-6	7311518114558	10	19
3809-600-50-2.50-3	7311518114565	10	19
3809-600-50-2.50-4	7311518114572	10	19
3809-600-50-2.50-4-KA	7311518114589	10	20
3809-600-50-2.50-6	7311518114596	10	19
3809-600-50-2.50-6-KA	7311518114626	10	20
3809-650-50-2.50-3-KA	7311518114640	5	20
3809-650-50-2.50-4	7311518114657	5	19
3809-650-50-2.50-4-KA	7311518114664	5	20
3809-650-50-2.50-6	7311518114671	5	19
3809-650-50-2.50-6-KA	7311518114688	5	20
3809-700-50-2.50-3-KA	7311518114695	5	20
3809-700-50-2.50-4	7311518114701	5	19
3809-700-50-2.50-4-KA	7311518114718	5	20
3809-700-50-2.50-6	7311518114725	5	19
3809-700-50-2.50-6-KA	7311518114732	5	20
3809-750-50-2.50-4	7311518114749	5	19
3809-750-50-2.50-6	7311518234009	5	19
3815-200-2.0-32-1-03BW	7311518160258	1	17
3815-200-2.0-32-1-04BW	7311518160241	1	17
3815-225-2.0-32-1-03BW	7311518160319	1	17
3815-225-2.0-32-1-04BW	7311518158347	1	17
3815-225-2.0-32-1-05BW	7311518160302	1	17
3815-225-2.0-32-1-06C	7311518160296	1	17
3815-250-2.0-32-1-03BW	7311518160586	1	17
3815-250-2.0-32-1-04BW	7311518160579	1	17
3815-250-2.0-32-1-05BW	7311518158354	1	17
3815-250-2.0-32-1-06C	7311518160562	1	17
3815-250-2.0-40-2-03BW	7311518160340	1	17
3815-250-2.0-40-2-04BW	7311518174446	1	17
3815-250-2.0-40-2-05BW	7311518160333	1	17
3815-275-2.5-32-1-04BW	7311518160593	1	17
3815-275-2.5-32-1-05BW	7311518158361	1	17
3815-275-2.5-32-1-06C	7311518174590	1	17
3815-275-2.5-32-1-08C	7311518174583	1	17
3815-275-2.5-40-2-03BW	7311518176433	1	17
3815-275-2.5-40-2-04BW	7311518160623	1	17
3815-275-2.5-40-2-05BW	7311518158378	1	17
3815-275-2.5-40-2-06C	7311518160616	1	17
3815-275-2.5-40-2-08C	7311518160609	1	17
3815-300-2.5-32-1-04BW	7311518160630	1	17
3815-300-2.5-32-1-05BW	7311518158385	1	17
3815-300-2.5-32-1-05C	7311518174699	1	17
3815-300-2.5-32-1-06C	7311518174705	1	17
3815-300-2.5-32-1-08C	7311518174712	1	17
3815-315-2.5-32-1-04BW	7311518160210	1	17

3815-315-2.5-32-1-05BW	7311518160203	1	17
3815-315-2.5-32-1-06C	7311518160197	1	17
3815-315-2.5-32-1-08C	7311518160401	1	17
3815-315-2.5-40-2-04BW	7311518160456	1	17
3815-315-2.5-40-2-05BW	7311518160449	1	17
3815-315-3.0-40-2-06C	7311518174842	1	17
3815-350-2.5-32-1-04BW	7311518197605	1	17
3815-350-2.5-32-1-06C	7311518197612	1	17
3815-370-3.0-50-4-08C	7311518174989	1	17
3815-370-3.0-50-4-10C	7311518174996	1	17
3815-400-3.5-50-4-10C	7311518160494	1	17
3816-300	7311518015749	50	572
3818-300-PROG-100	7311518288105	100	571
3818-300-PROG-5P	7314150265589	10	571
383-6T	7311518128876	4	644
3830-102-C	7311518225612	1	124
3830-102-VIP	7311518042035	4	124
3830-105-C	7311518225629	1	124
3830-105-VIP	7311518042042	4	124
3830-108-C	7311518228521	1	124
3830-108-VIP	7311518042059	4	124
3830-111-C	7311518228538	1	124
3830-111-VIP	7311518042066	4	124
3830-114-C	7311518225636	1	124
3830-114-VIP	7311518042073	4	124
3830-121-C	7311518225643	1	124
3830-121-VIP	7311518042080	1	124
3830-127-C	7311518225650	1	124
3830-127-VIP	7311518042097	1	124
3830-133-C	7311518228545	1	124
3830-133-VIP	7311518042103	1	124
3830-14-C	7311518228347	1	124
3830-14-VIP	7311518041618	6	124
3830-140-C	7311518228552	1	124
3830-140-VIP	7311518042110	1	124
3830-146-C	7311518228569	1	124
3830-146-VIP	7311518042127	1	124
3830-152-C	7311518225667	1	124
3830-152-VIP	7311518042134	1	124
3830-16-C	7311518225353	1	124
3830-16-VIP	7311518041625	6	124
3830-168	7311518040659	1	124
3830-17-C	7311518228354	1	124
3830-17-VIP	7311518041632	6	124
3830-177-HIGH	7311518101329	1	124
3830-19-4P	7314150428557	1	124
3830-19-C	7311518225360	1	124
3830-19-VIP	7311518041649	6	124
3830-20-4P	7314150428601	1	124
3830-20-C	7311518225377	1	124
3830-20-VIP	7311518041656	6	124
3830-21-C	7311518228361	1	124
3830-21-VIP	7311518041663	6	124
3830-210	7311518040666	1	124
3830-22-4P	7314150428649	1	124
3830-22-C	7311518225384	1	124
3830-22-VIP	7311518041670	6	124
3830-24-C	7311518228378	1	124
3830-24-VIP	7311518041687	6	124
3830-25-4P	7314150428663	1	124
3830-25-C	7311518225391	1	124
3830-25-VIP	7311518041694	6	124
3830-27-4P	7314150428670	1	124
3830-27-C	7311518225407	1	124
3830-27-VIP	7311518041700	6	124
3830-29-4P	7314150428922	1	124
3830-29-C	7311518225414	1	124
3830-29-VIP	7311518041717	6	124
3830-30-4P	7314150433483	1	124
3830-30-C	7311518225421	1	124
3830-30-VIP	7311518041724	6	124
3830-32-4P	7314150428687	1	124
3830-32-C	7311518225438	1	124
3830-32-VIP	7311518041731	6	124
3830-33-C	7311518228385	1	124
3830-33-VIP	7311518041748	6	124
3830-35-4P	7314150428700	1	124
3830-35-C	7311518225445	1	124
3830-35-VIP	7311518041755	6	124
3830-37-C	7311518228392	1	124
3830-37-VIP	7311518041762	6	124
3830-38-C	7311518225452	1	124
3830-38-VIP	7311518041779	6	124
3830-40-C	7311518228408	1	124
3830-40-VIP	7311518041786	6	124
3830-41-C	7311518225469	1	124
3830-41-VIP	7311518041793	6	124
3830-43-C	7311518228415	1	124
3830-43-VIP	7311518041809	6	124
3830-44-C	7311518225476	1	124
3830-44-VIP	7311518041816	6	124
3830-46-C	7311518228422	1	124
3830-46-VIP	7311518041823	6	124
3830-48-C	7311518225483	1	124
3830-48-VIP	7311518041830	6	124
3830-50-C	7311518260873	1	124

3830-50-VIP	7311518260866	6	124
3830-51-C	7311518225490	1	124
3830-51-VIP	7311518041847	6	124
3830-52-C	7311518228439	1	124
3830-52-VIP	7311518041854	4	124
3830-54-C	7311518225506	1	124
3830-54-VIP	7311518041861	4	124
3830-55-C	7311518270919	1	124
3830-55-VIP	7311518270902	4	124
3830-56-C	7311518228446	1	124
3830-56-VIP	7311518152703	4	124
3830-57-C	7311518225513	1	124
3830-57-VIP	7311518041878	4	124
3830-59-C	7311518228453	1	124
3830-59-VIP	7311518041885	4	124
3830-60-C	7311518225520	1	124
3830-60-VIP	7311518041892	4	124
3830-62-VIP	7311518234645	4	124
3830-64-C	7311518225537	1	124
3830-64-VIP	7311518041908	4	124
3830-65-C	7311518228460	1	124
3830-65-VIP	7311518041915	4	124
3830-67-C	7311518225544	1	124
3830-67-VIP	7311518041922	4	124
3830-68-C	7311518228477	1	124
3830-68-VIP	7311518196530	4	124
3830-70-C	7311518225551	1	124
3830-70-VIP	7311518041939	4	124
3830-73-C	7311518228484	1	124
3830-73-VIP	7311518041946	4	124
3830-76-C	7311518225568	1	124
3830-76-VIP	7311518041953	4	124
3830-79-C	7311518228491	1	124
3830-79-VIP	7311518041960	4	124
3830-83-C	7311518225575	1	124
3830-83-VIP	7311518041977	4	124
3830-86-C	7311518228507	1	124
3830-86-VIP	7311518041984	4	124
3830-89-C	7311518225582	1	124
3830-89-VIP	7311518041991	4	124
3830-92-C	7311518225599	1	124
3830-92-VIP	7311518042004	4	124
3830-95-C	7311518225605	1	124
3830-95-VIP	7311518042011	4	124
3830-98-C	7311518228514	1	124
3830-98-VIP	7311518042028	4	124
3832-102	7311518558567	4	131
3832-102-C	7314150474394	1	132
3832-105	7311518558581	4	131
3832-108	7311518558604	4	131
3832-111	7311518558611	4	131
3832-114	7311518558628	4	131
3832-114-C	7314150474424	1	132
3832-121	7311518558642	1	131
3832-127	7311518558666	1	131
3832-127-C	7314150474431	1	132
3832-133	7311518558673	1	131
3832-14	7311518557744	6	131
3832-140	7311518558680	1	131
3832-146	7311518558697	1	131
3832-152	7311518558703	1	131
3832-16	7311518557768	6	131
3832-16-C	7314150474448	1	132
3832-17	7311518557782	6	131
3832-19	7311518557805	6	131
3832-19-C	7314150474455	1	132
3832-20	7311518557812	6	131
3832-20-C	7314150474462	1	132
3832-21	7311518557829	6	131
3832-22	7311518557843	6	131
3832-22-C	7314150474479	1	132
3832-24	7311518557867	6	131
3832-24-C	7314150479054	1	132
3832-25	7311518557881	6	131
3832-25-C	7314150474486	1	132
3832-27	7311518557904	6	131
3832-29	7311518557928	6	131
3832-29-C	7314150474493	1	132
3832-30	7311518557942	6	131
3832-30-C	7314150479061	1	132
3832-32	7311518557966	6	131
3832-32-C	7314150474509	1	132
3832-33	7311518557980	6	131
3832-35	7311518558000	6	131
3832-35-C	7314150474516	1	132
3832-37	7311518558024	6	131
3832-38	7311518558048	6	131
3832-38-C	7314150474523	1	132
3832-40	7311518558062	6	131
3832-41	7311518558086	6	131
3832-41-C	7314150474530	1	132
3832-43	7311518558109	6	131
3832-44	7311518558123	6	131
3832-44-C	7314150474547	1	132
3832-46	7311518558147	6	131
3832-46-C	7314150479078	1	132





3832-48	7311518558161	6	131
3832-48-C	7314150474554	1	132
3832-51	7311518558185	6	131
3832-51-C	7314150474561	1	132
3832-52	7311518558208	4	131
3832-54	7311518558222	4	131
3832-54-C	7314150474578	1	132
3832-56	7311518558239	4	131
3832-57	7311518558246	4	131
3832-57-C	7314150474585	1	132
3832-59	7311518558260	4	131
3832-60	7311518558284	4	131
3832-60-C	7314150474615	1	132
3832-64	7311518558307	4	131
3832-64-C	7314150474622	1	132
3832-65	7311518558321	4	131
3832-67	7311518558345	4	131
3832-68	7311518558352	4	131
3832-70	7311518558369	4	131
3832-73	7311518558383	4	131
3832-73-C	7314150474639	1	132
3832-76	7311518558406	4	131
3832-76-C	7314150474646	1	132
3832-79	7311518558420	4	131
3832-83	7311518558444	4	131
3832-83-C	7314150474653	1	132
3832-86	7311518558468	4	131
3832-86-C	7314150474660	1	132
3832-89	7311518558482	4	131
3832-92	7311518558505	4	131
3832-92-C	7314150474677	1	132
3832-95	7311518558529	4	131
3832-98	7311518558543	4	131
3832-SET-164-ES	7314150487349	1	132
3832-SET-84-ES	7314150498932	1	132
3833-102-C	7314150263899	1	129
3833-105-C	7314150263905	1	129
3833-108-C	7314150263912	1	129
3833-109-C	7314150263929	1	129
3833-111-C	7314150263936	1	129
3833-114-C	7314150263943	1	129
3833-121-C	7314150263950	1	129
3833-127-C	7314150263967	1	129
3833-133-C	7314150401581	1	129
3833-140-C	7314150263974	1	129
3833-152-C	7314150263981	1	129
3833-159-C	7314150263998	1	129
3833-168	7314150413546	1	129
3833-177	7314150413539	1	129
3833-19-C	7314150263561	1	129
3833-20-C	7314150263578	1	129
3833-210	7314150413522	1	129
3833-22-C	7314150263585	1	129
3833-225	7314150413515	1	129
3833-25-C	7314150263592	1	129
3833-27-C	7314150263608	1	129
3833-29-C	7314150263615	1	129
3833-30-C	7314150263622	1	129
3833-32-C	7314150263639	1	129
3833-35-C	7314150263646	1	129
3833-38-C	7314150263653	1	129
3833-40-C	7314150263660	1	129
3833-41-C	7314150263677	1	129
3833-44-C	7314150263684	1	129
3833-48-C	7314150263691	1	129
3833-51-C	7314150263707	1	129
3833-54-C	7314150263714	1	129
3833-56-C	7314150314676	1	129
3833-57-C	7314150263721	1	129
3833-60-C	7314150263738	1	129
3833-62-C	7314150314683	1	129
3833-64-C	7314150263745	1	129
3833-65-C	7314150263752	1	129
3833-67-C	7314150263769	1	129
3833-68-C	7314150263776	1	129
3833-70-C	7314150263783	1	129
3833-71-C	7314150314690	1	129
3833-73-C	7314150263790	1	129
3833-74-C	7314150314706	1	129
3833-76-C	7314150263806	1	129
3833-77-C	7314150263813	1	129
3833-78-C	7314150314713	1	129
3833-79-C	7314150263820	1	129
3833-83-C	7314150263837	1	129
3833-86-C	7314150263844	1	129
3833-89-C	7314150263851	1	129
3833-92-C	7314150263868	1	129
3833-95-C	7314150263875	1	129
3833-98-C	7314150263882	1	129
3833-PROMO-42	7314150464951	1	129
3833-SET-101	7314150315383	1	129
3833-SET-201	7314150315406	1	129
3833-SET-202	7314150315420	1	129
3833-SET-203	7314150315444	1	130
3833-SET-204	7314150315468	1	130
3833-SET-205	7314150330874	1	130



3833-SET-207	7314150330898	1	130
3833-SET-208	7314150330904	1	130
3833-SET-301	7314150315376	1	130
3833-SET-302	7314150315390	1	131
3833-SET-303	7314150315413	1	131
3833-SET-304	7314150315437	1	131
3834-ADP	7311518454425	1	134
3834-ARBR-11152	7311518015596	1	133
3834-ARBR-11152-C	7311518225698	1	133
3834-ARBR-11152QC	7311518167967	1	133
3834-ARBR-11152QC-C	7311518225711	1	133
3834-ARBR-1130	7311518015572	4	133
3834-ARBR-1130-C	7311518228583	1	133
3834-ARBR-16152	7311518015602	1	133
3834-ARBR-16152QC	7311518453152	1	133
3834-ARBR-630	7311518015558	1	133
3834-ARBR-630-C	7311518228576	1	133
3834-ARBR-730	7311518167974	1	133
3834-ARBR-730-C	7311518225674	1	133
3834-ARBR-9100	7311518015589	1	133
3834-ARBR-9100-C	7311518228590	1	133
3834-ARBR-9100EL	7314150265077	1	132
3834-ARBR-9100ESM	7314150390458	1	132
3834-ARBR-9100QC	7311518249830	1	133
3834-ARBR-9100QC-C	7311518225704	1	133
3834-ARBR-930	7311518015565	1	133
3834-ARBR-930-C	7311518225681	1	133
3834-ARBR-930EL	7314150265053	1	132
3834-ARBR-930ESM	7314150390465	1	132
3834-ARBR-SD152QC	7311518203825	1	133
3834-ARBR-SD30	7311518203818	1	133
3834-CP-20/25	7314150312092	1	124
3834-DRL	7311518234638	1	133
3834-DRL-CT	7311518953201	1	133
3834-DRL-EL	7314150265114	1	132
3834-DRL-ES	7314150265091	1	133
3834-DRL-HSS-ES	7314150339396	1	133
3834-DRL-L	7314150265138	1	133
3834-ES	7311518454418	1	133
3834-EXT-1	7311518040673	1	133
3834-EXT-2	7311518168070	1	133
3834-M6X29-SET	7314150383450	1	134
3834-M8X10-SET	7314150383429	1	134
3834-M8X5-SET	7314150383443	1	134
3834-M8X6-SET	7314150383436	1	134
3834-PROMO-122	7314150432059	1	125
3834-PROMO-122-76	7314150459193	1	125
3834-PROMO-82	7314150432042	1	125
3834-SET-103	7314150134908	1	128
3834-SET-152	7314150255658	1	128
3834-SET-42	7311518241988	1	125
3834-SET-53	7314150127153	1	125
3834-SET-61	7311518266431	1	126
3834-SET-62	7311518228040	1	126
3834-SET-62-16/50	7311518258887	1	126
3834-SET-65-16/51	7311518159900	1	126
3834-SET-65-22/64	7311518159917	1	126
3834-SET-72	7311518044992	1	126
3834-SET-72-35/83	7314150444229	1	125
3834-SET-73	7311518254339	1	127
3834-SET-73-22/68	7314150134809	1	127
3834-SET-77	7314150235919	1	127
3834-SET-84-ES	7314150470587	1	127
3834-SET-86	7311518224295	1	127
3834-SET-87	7311518181772	1	127
3834-SET-92	7311518044985	1	128
3834-SET-93	7314150414741	1	128
3834-SET-94	7311518166458	1	128
3834-SET-95	7311518159894	1	128
3834-UPSIZE	7314150344567	1	133
3835-SET-64	7314150423309	1	132
3835-SET-711	7314150465835	1	132
384-5T	7311518159795	4	644
384-6T	7311518002039	4	644
3845-18-10P	7311518101602	1	135
3845-24-10P	7311518101619	1	135
3845-32-10P	7311518101626	1	135
385-6T	7311518002053	4	644
3851-10-0.6-10/14	7311518182717	1	12
3851-10-0.6-H-4	7311518282776	1	12
3851-10-0.6-H-6	7311518282806	1	12
3851-10-0.6-HA-4	7314150139309	1	12
3851-10-0.9-10/14	7311518182823	1	12
3851-10-0.9-H-4	7311518282851	1	12
3851-10-0.9-H-6	7311518282868	1	12
3851-10-0.9-R-14	7314150312399	1	12
3851-13-0.5-10/14	7311518282813	1	12
3851-13-0.5-14/18	7311518282790	1	12
3851-13-0.5-H-4	7311518292072	1	12
3851-13-0.5-R-10	7311518331306	1	12
3851-13-0.5-R-14	7311518331320	1	12
3851-13-0.5-R-18	7311518331344	1	12
3851-13-0.5-R-24	7311518282820	1	12
3851-13-0.6-10/14	7311518183271	1	12
3851-13-0.6-5/8	7311518183233	1	12
3851-13-0.6-6/10	7311518183240	1	12

3851-13-0.6-8/12	7311518185572	1	12
3851-13-0.6-H-3	7311518282769	1	12
3851-13-0.6-H-4	7311518282745	1	12
3851-13-0.6-H-6	7311518282738	1	12
3851-13-0.6-HA-4	7311518282752	1	12
3851-13-0.6-HA-6	7311518282561	1	12
3851-13-0.6-R-10	7311518183110	1	12
3851-13-0.6-R-14	7311518183158	1	12
3851-13-0.6-R-18	7311518183196	1	12
3851-13-0.9-10/14	7311518183868	1	12
3851-13-0.9-6/10	7311518183585	1	12
3851-13-0.9-H-3	7311518282936	1	12
3851-13-0.9-H-4	7311518282943	1	12
3851-13-0.9-H-6	7311518286125	1	12
3851-13-0.9-HA-4	7311518281052	1	12
3851-13-0.9-R-14	7311518182359	1	12
3851-13-0.9-R-6	7311518183301	1	12
3851-20-0.9-10/14	7311518282585	1	12
3851-20-0.9-4/6	7311518183905	1	12
3851-20-0.9-5/8	7311518183929	1	12
3851-20-0.9-6/10	7311518183936	1	12
3851-20-0.9-8/12	7311518282578	1	12
3851-20-0.9-H-3	7314150398515	1	12
3851-20-0.9-H-4	7314150398294	1	12
3851-20-0.9-HA-3	7311518282646	1	12
3851-20-0.9-HA-4	7311518282653	1	12
3851-20-0.9-R-18	7311518332587	1	12
3851-27-0.9-10/14	7311518165475	1	13
3851-27-0.9-2/3	7311518126377	1	13
3851-27-0.9-3/4	7311518126384	1	13
3851-27-0.9-4/6	7311518126391	1	13
3851-27-0.9-5/8	7311518126407	1	13
3851-27-0.9-6/10	7311518126414	1	13
3851-27-0.9-8/12	7311518160692	1	13
3851-27-0.9-HA-3	7311518282684	1	12
3851-27-0.9-HA-4	7314150398317	1	12
3851-27-0.9-P-3	7311518157135	1	12
3851-27-0.9-P-4	7311518157661	1	12
3851-27-0.9-R-6	7311518126353	1	12
3851-34-1.1-2/3	7311518126476	1	13
3851-34-1.1-3/4	7311518126483	1	13
3851-34-1.1-4/6	7311518126490	1	13
3851-34-1.1-5/8	7311518126506	1	13
3851-34-1.1-6/10	7311518165505	1	13
3851-34-1.1-P-2	7311518157715	1	12
3851-34-1.1-P-3	7311518157753	1	12
3851-41-1.3-1.4/2	7311518211837	1	13
3851-41-1.3-2/3	7311518126568	1	13
3851-41-1.3-3/4	7311518126575	1	13
3851-41-1.3-4/6	7311518126582	1	13
3851-41-1.3-5/8	7311518262488	1	13
3851-54-1.3-1.4/2	7314150459360	1	13
3851-54-1.3-2/3	7311518163716	1	13
3851-54-1.3-4/6	7311518168025	1	13
3851-54-1.6-1.4/2	7311518211431	1	13
3851-54-1.6-1/1.4	7311518188542	1	13
3851-54-1.6-2/3	7311518126636	1	13
3851-54-1.6-3/4	7311518126643	1	13
3851-54-1.6-4/6	7314150398539	1	13
3851-54-1.6-P-1.25	7311518158026	1	13
3851-6-0.6-10/14	7311518180652	1	12
3851-6-0.6-H-6	7311518282707	1	12
3851-6-0.9-10/14	7311518180768	1	12
3851-6-0.9-H-6	7311518282714	1	12
3851-67-1.6-7/1	7311518200909	1	13
3851-67-1.6-1.4/2	7314150273317	1	13
3851-67-1.6-1/1.4	7311518178840	1	13
3851-67-1.6-2/3	7311518335243	1	13
3851-67-1.6-3/4	7311518328597	1	13
3851-67-1.6-4/6	7311518194963	1	13
3851-80-1.6-7/1	7311518255367	1	13
3851-80-1.6-1.4/2	7311518255350	1	13
3851-80-1.6-1/1.4	7311518197377	1	13
3853-20-0.9-5/7-VS	7311518331689	1	14
3853-20-0.9-8/11-VS	7311518331702	1	14
3853-27-0.9-3/4	7311518285395	1	14
3853-27-0.9-4/6	7311518183998	1	14
3853-27-0.9-5/7-VS	7311518331115	1	14
3853-27-0.9-5/8	7311518202118	1	14
3853-27-0.9-8/11-VS	7311518331122	1	14
3853-34-1.1-2/3	7311518282875	1	14
3853-34-1.1-3/4	7311518184094	1	14
3853-34-1.1-4/6	7311518184087	1	14
3853-34-1.1-5/7-VS	7311518331726	1	14
3853-34-1.1-5/8	7311518202149	1	14
3853-34-1.1-8/11-VS	7311518331719	1	14
3853-41-1.3-2/3	7311518282882	1	14
3853-41-1.3-2/3-W	7314150370115	1	14
3853-41-1.3-2/3-WS	7314150415113	1	14
3853-41-1.3-3/4	7311518185770	1	14
3853-41-1.3-3/4-W	7311518338053	1	14
3853-41-1.3-3/4-WS	7314150415120	1	14
3853-41-1.3-4/6	7311518184100	1	14
3853-41-1.3-5/7-VS	7311518331733	1	14
3853-41-1.3-5/8	7311518202286	1	14
3853-54-1.3-3/4	7311518184124	1	14

3853-54-1.3-3/4-W	7314150352876	1	14
3853-54-1.3-5/8	7311518197568	1	14
3853-54-1.6-2/3	7311518282899	1	14
3853-54-1.6-2/3-W	7311518338077	1	14
3853-54-1.6-2/3-WS	7314150415151	1	14
3853-54-1.6-3/4	7311518216757	1	14
3853-54-1.6-3/4-W	7311518338091	1	14
3853-54-1.6-3/4-WS	7314150415168	1	14
3853-54-1.6-4/6	7311518222055	1	14
3853-67-1.6-2/3	7311518282905	1	14
3853-67-1.6-2/3-W	7311518338114	1	14
3853-67-1.6-2/3-WS	7314150415175	1	14
3853-67-1.6-3/4	7311518282912	1	14
3853-67-1.6-3/4-W	7311518338138	1	14
3853-67-1.6-3/4-WS	7314150415182	1	14
3853-67-1.6-5/8-W	7311518338152	1	14
3854-27-0.9-PHX-2/3	7314150440603	1	13
3854-27-0.9-PHX-3/4	7314150440610	1	13
3854-27-0.9-PHX-4/6	7314150440627	1	13
3854-27-0.9-PQ-3/4	7314150137480	1	13
3854-27-0.9-PQ-4/6	7314150197828	1	13
3854-34-1.1-PHX-1.4/2	7314150440634	1	13
3854-34-1.1-PHX-2/3	7314150440641	1	13
3854-34-1.1-PHX-3/4	7314150440658	1	13
3854-34-1.1-PHX-4/6	7314150440665	1	13
3854-34-1.1-PQ-2/3	7311518287276	1	13
3854-34-1.1-PQ-3/4	7314150135813	1	13
3854-34-1.1-PQ-4/6	7314150197835	1	13
3854-41-1.3-PHX-1.4/2	7314150440672	1	13
3854-41-1.3-PHX-2/3	7314150440689	1	13
3854-41-1.3-PHX-3/4	7314150440696	1	13
3854-41-1.3-PHX-4/6	7314150440702	1	13
3854-41-1.3-PQ-1.4/2	7314150129355	1	13
3854-41-1.3-PQ-2/3	7311518280604	1	13
3854-41-1.3-PQ-3/4	7311518282950	1	13
3854-41-1.3-PQ-4/6	7314150197842	1	13
3854-54-1.3-PHX-1.4/2	7314150440719	1	13
3854-54-1.3-PHX-2/3	7314150440733	1	13
3854-54-1.3-PHX-3/4	7314150440740	1	13
3854-54-1.6-PHX-7/1	7314150440757	1	13
3854-54-1.6-PHX-1.4/2	7314150440771	1	13
3854-54-1.6-PHX-1/1.4	7314150440764	1	13
3854-54-1.6-PHX-2/3	7314150440788	1	13
3854-54-1.6-PHX-3/4	7314150440795	1	13
3854-54-1.6-PQ-9/1.2	7314150133857	1	13
3854-54-1.6-PQ-1.4/2	7314150127092	1	13
3854-54-1.6-PQ-2/3	7311518265137	1	13
3854-54-1.6-PQ-3/4	7311518282929	1	13
3854-54-1.6-PQ-4/6	7311518330637	1	13
3854-67-1.6-PHX-7/1	7314150440801	1	13
3854-67-1.6-PHX-1.4/2	7314150440825	1	13
3854-67-1.6-PHX-1/1.4	7314150440818	1	13
3854-67-1.6-PHX-2/3	7314150440832	1	13
3854-67-1.6-PQ-9/1.2	7314150133888	1	13
3854-67-1.6-PQ-1.4/2	7314150133901	1	13
3854-67-1.6-PQ-2/3	7311518290160	1	13
3854-80-1.6-PHX-7/1	7314150440849	1	13
3854-80-1.6-PHX-1.4/2	7314150440863	1	13
3854-80-1.6-PHX-1/1.4	7314150440856	1	13
3854-80-1.6-PQ-9/1.2	7314150133959	1	13
3854-80-1.6-PQ-1.4/2	7314150215966	1	13
3857-13-0.6-EZ-L	7311518264789	1	12
3857-13-0.6-EZ-M	7311518264772	1	12
3857-13-0.6-EZ-S	7311518264765	1	12
3857-13-0.6-EZ-S-3P1140	7314150345731	1	143
3857-13-0.6-EZ-S-3P690	7314150345694	1	143
3857-13-0.6-EZ-S-3P730	7314150345700	1	143
3857-13-0.6-EZ-S-3P835	7314150345717	1	143
3857-13-0.6-EZ-S-3P900	7314150345724	1	143
3857-20-0.9-EZ-L	7311518264819	1	12
3857-20-0.9-EZ-M	7311518264802	1	12
3857-20-0.9-EZ-S	7311518264796	1	12
3857-27-0.9-EZ-L	7311518264840	1	12
3857-27-0.9-EZ-M	7311518264833	1	12
3857-27-0.9-EZ-S	7311518264826	1	12
3857-34-1.1-EZ-L	7311518264871	1	12
3857-34-1.1-EZ-M	7311518264864	1	12
3857-34-1.1-EZ-S	7311518264857	1	12
3858-34-1.1-PHX-1.4/2	7314150441198	1	14
3858-34-1.1-PHX-2/3	7314150441204	1	14
3858-34-1.1-PHX-3/4	7314150441211	1	14
3858-41-1.3-PHX-1.4/2	7314150441013	1	14
3858-41-1.3-PHX-2/3	7314150441020	1	14
3858-41-1.3-PHX-3/4	7314150441037	1	14
3858-41-1.3-PQ-1.4/2	7314150395583	1	14
3858-41-1.3-PQ-2/3	7314150395590	1	14
3858-41-1.3-PQ-3/4	7314150395606	1	14
3858-54-1.3-PHX-1.4/2	7314150441068	1	14
3858-54-1.3-PHX-2/3	7314150441044	1	14
3858-54-1.3-PHX-3/4	7314150441051	1	14
3858-54-1.6-PHX-7/1	7314150441075	1	14
3858-54-1.6-PHX-1.4/2	7314150441099	1	14
3858-54-1.6-PHX-1/1.4	7314150441082	1	14
3858-54-1.6-PHX-2/3	7314150441105	1	14
3858-54-1.6-PHX-3/4	7314150441112	1	14
3858-54-1.6-PQ-9/1.2	7314150395613	1	14





3858-54-1.6-PQ-1.4/2	7314150395620	1	14
3858-54-1.6-PQ-2/3	7314150395637	1	14
3858-67-1.6-PHX-7/1	7314150441129	1	14
3858-67-1.6-PHX-1.4/2	7314150441143	1	14
3858-67-1.6-PHX-1/1.4	7314150441136	1	14
3858-67-1.6-PHX-2/3	7314150441150	1	14
3858-67-1.6-PQ-9/1.2	7314150395644	1	14
3858-67-1.6-PQ-1.4/2	7314150395651	1	14
3858-80-1.6-PHX-7/1	7314150441167	1	14
3858-80-1.6-PHX-1.4/2	7314150441181	1	14
3858-80-1.6-PHX-1/1.4	7314150441174	1	14
3858-80-1.6-PQ-9/1.2	7314150395668	1	14
3859-27-0.9-EZX-3/4	7314150517558	1	15
3859-27-0.9-EZX-4/6	7314150517565	1	15
3859-34-1.1-EZX-2/3	7314150517572	1	15
3859-34-1.1-EZX-3/4	7314150517589	1	15
3859-34-1.1-EZX-4/6	7314150517596	1	15
3859-41-1.3-EZX-1.4/2	7314150517602	1	15
3859-41-1.3-EZX-2/3	7314150517619	1	15
3859-41-1.3-EZX-3/4	7314150517626	1	15
3859-41-1.3-EZX-4/6	7314150517633	1	15
3859-54-1.6-EZX-1.4/2	7314150517640	1	15
3859-54-1.6-EZX-1/1.25	7314150517657	1	15
3859-54-1.6-EZX-2/3	7314150517664	1	15
3859-54-1.6-EZX-3/4	7314150517671	1	15
3859-54-1.6-EZX-4/6	7314150517688	1	15
3859-67-1.6-EZX-7/1	7314150517695	1	15
3859-67-1.6-EZX-1.4/2	7314150517701	1	15
3859-67-1.6-EZX-1/1.25	7314150517718	1	15
3859-67-1.6-EZX-2/3	7314150517725	1	15
3859-80-1.6-EZX-7/1	7314150517732	1	15
3859-80-1.6-EZX-1.4/2	7314150517749	1	15
3859-80-1.6-EZX-1/1.25	7314150517756	1	15
386-6T	7311518152017	4	644
3860-100-1.1-TMC-1.4/2	7314150336968	1	16
3860-27-0.9-TC-3	7314150413010	1	16
3860-27-0.9-TC-3/4	7314150413027	1	16
3860-27-0.9-TC-3/4	7314150263493	1	16
3860-34-1.1-TC-2/3	7314150413034	1	16
3860-34-1.1-TC-3/4	7314150413041	1	16
3860-34-1.1-TC-3/4-W	7314150413058	1	16
3860-34-1.1-TC-2/3	7311518330880	1	16
3860-34-1.1-TC-3/4	7311518330897	1	16
3860-41-1.3-TC-1.4/2	7314150413065	1	16
3860-41-1.3-TC-1.9/2.1	7314150413072	1	16
3860-41-1.3-TC-2/3	7314150413089	1	16
3860-41-1.3-TC-3/4	7314150413096	1	16
3860-41-1.3-TC-2/3	7311518330903	1	16
3860-41-1.3-TC-3/4	7311518330910	1	16
3860-41-1.3-TMC-1.4/2	7314150129379	1	16
3860-41-1.3-TMC-2/3	7311518330224	1	16
3860-54-1.3-TMC-1.4/2	7314150288748	1	16
3860-54-1.3-TMC-2/3	7311518335267	1	16
3860-54-1.6-TC-1.4/2	7314150413119	1	16
3860-54-1.6-TC-1.9/2.1	7314150413133	1	16
3860-54-1.6-TC-2/3	7314150413140	1	16
3860-54-1.6-TC-3/4	7314150413157	1	16
3860-54-1.6-TMC-7/1	7314150263431	1	16
3860-54-1.6-TMC-1.4/2	7314150137978	1	16
3860-54-1.6-TMC-1.4/2S	7314150395316	1	17
3860-54-1.6-TMC-1/1.25	7314150154340	1	16
3860-54-1.6-TMC-1/1.25S	7314150395309	1	17
3860-54-1.6-TMC-2/3	7314150189366	1	16
3860-54-1.6-TMC-2/3S	7314150395323	1	17
3860-67-1.6-TC-1.4/2	7314150413164	1	16
3860-67-1.6-TC-1/1.25	7314150413171	1	16
3860-67-1.6-TMC-1.4/2	7314150137985	1	16
3860-67-1.6-TMC-1.4/2S	7314150395347	1	17
3860-67-1.6-TMC-1/1.25	7314150154364	1	16
3860-67-1.6-TMC-1/1.25S	7314150395330	1	17
3860-67-1.6-TMC-2/3	7314150189359	1	16
3860-80-1.1-TMC-1.4/2	7314150382767	1	16
3860-80-1.6-TC-5/0.8	7314150413188	1	16
3860-80-1.6-TMC-7/1	7314150154371	1	16
3860-80-1.6-TMC-1.4/2	7314150182992	1	16
3860-80-1.6-TMC-1/1.25	7314150182336	1	16
3860-80-1.6-TMC-2/3	7314150215959	1	16
3861-20-0.6-H-4	7311518331351	1	18
3861-27-0.9-H-1.33	7311518329716	1	18
3861-34-0.9-H-1.15	7311518258894	1	18
3861-34-1.1-H-1.15	7311518258900	1	18
3861-41-1.1-H-1.15	7314150129294	1	18
3861-54-1.1-H-1.15	7314150129270	1	18
3862-33-0.9-H-1.15	7314150320325	1	18
3862-33-1.1-H-1.15	7311518331269	1	18
3862-40-1.1-H-1.15	7311518331283	1	18
3868-27-0.9-TSS-3/4	7314150447633	1	15
3868-27-0.9-TSX-3/4	7311518329693	1	15
3868-34-1.1-TSS-2/3	7311518329266	1	15
3868-34-1.1-TSX-2	7311518203016	1	15
3868-34-1.1-TSX-2/3	7311518255343	1	15
3868-34-1.1-TSX-3/4	7311518232375	1	15
3868-41-1.3-TSS-1.4/2	7311518243142	1	15
3868-41-1.3-TSS-2/3	7311518270643	1	15
3868-41-1.3-TSX-1.4/2	7311518214210	1	15
3868-41-1.3-TSX-1.6	7311518203092	1	15



3868-41-1.3-TSX-2	7311518203085	1	15
3868-41-1.3-TSX-2/3	7311518232382	1	15
3868-41-1.3-TSX-3/4	7311518232399	1	15
3868-54-1.3-TSX-1.4/2	7311518214876	1	15
3868-54-1.3-TSX-2/3	7314150416394	1	15
3868-54-1.6-TSS-1.4/2	7311518243166	1	15
3868-54-1.6-TSS-1/1.25	7311518243173	1	15
3868-54-1.6-TSS-2/3	7311518280383	1	15
3868-54-1.6-TSX-1.4/2	7311518214869	1	15
3868-54-1.6-TSX-1.6	7311518203108	1	15
3868-54-1.6-TSX-1/1.25	7311518213114	1	15
3868-54-1.6-TSX-2/3	7311518232405	1	15
3868-54-1.6-TSX-3/4	7311518270360	1	15
3868-67-1.6-TSS-7/1	7311518274115	1	15
3868-67-1.6-TSS-1.4/2	7311518243197	1	15
3868-67-1.6-TSS-1/1.25	7311518243180	1	15
3868-67-1.6-TSS-2/3	7311518328825	1	15
3868-67-1.6-TSX-7/1	7311518212865	1	15
3868-67-1.6-TSX-1.4/2	7311518265496	1	15
3868-67-1.6-TSX-1/1.25	7311518213084	1	15
3868-67-1.6-TSX-2/3	7314150203536	1	15
3868-80-1.1-TSX-3/4	7311518330200	1	15
3868-80-1.6-TSS-7/1	7314150216253	1	15
3868-80-1.6-TSS-1.4/2	7314150203529	1	15
3868-80-1.6-TSS-2/3	7314150398553	1	15
3868-80-1.6-TSX-7/1	7311518212872	1	15
3868-80-1.6-TSX-1.4/2	7314150342167	1	15
3868-80-1.6-TSX-1/1.25	7314150277278	1	15
3868-80-1.6-TSX-2/3	7314150203543	1	15
3869-13-0.9-TS-3	7311518200589	1	15
3869-20-0.9-TS-3	7311518177300	1	15
3869-20-0.9-TS-4	7311518197742	1	15
3869-27-0.9-TS-3	7311518177348	1	15
3869-27-0.9-TS-4	7311518182595	1	15
3869-34-1.1-TS-2	7314150330508	1	15
3869-34-1.1-TS-3	7311518177355	1	15
3870-BRUSH-100-10	7311518269876	4	18
3870-BRUSH-100-10-HEX	7311518333935	4	18
3870-BRUSH-100-12	7311518269883	4	18
3870-BRUSH-100-13	7314150321131	1	18
3870-BRUSH-60-6	7311518279523	4	18
3870-BRUSH-80-10	7311518278311	4	18
3870-BRUSH-80-6	7311518269906	4	18
3870-BRUSH-80-8	7311518269890	4	18
3870-REFRACTOMETER	7311518192129	1	18
3870-TACHO METER	7311518145620	1	18
3870-TENSION METER	7311518145637	1	18
3870-WEDGE-3	7311518262747	1	19
3870-WHEEL	7314150398652	1	19
3875-BP1	7314150187737	8	482
3875-BP2	7314150187744	8	482
3875-GLOVE	7314150353330	5	499
3875-HB10	7314150349777	1	481
3875-HB100	7314150289783	1	482
3875-HB30	7314150187720	1	482
3875-HB60	7314150187713	8	482
3875-LY1	7314150191253	8	480
3875-LY10	7314150315062	1	481
3875-LY2	7314150191260	8	480
3875-LY3	7314150191284	8	480
3875-LY4	7314150262878	8	480
3875-LY60	7314150436521	1	480
3875-LY70	7314150442751	1	480
3875-LY8	7314150309689	1	481
3875-MHP4	7314150187805	1	482
3875-MHP6	7314150187812	1	482
3875-QL1	7314150191307	8	480
3875-QRL1	7314150194797	1	480
3875-RL1	7314150194780	1	480
3875-RL2	7314150312948	1	480
3875-SB70	7314150326839	1	482
3875-SL1	7314150220106	1	481
3875-WL1	7314150191291	8	480
3881-100-1.6-THS-7/1	7311518329617	1	16
3881-34-1.1-THQ-2/3	7311518265793	1	16
3881-41-1.3-THQ-1.4/2	7314150129447	1	16
3881-41-1.3-THQ-2/3	7314150129454	1	16
3881-41-1.3-THS-1.4/2	7311518273712	1	16
3881-54-1.6-THQ-1.4/2	7314150128860	1	16
3881-54-1.6-THQ-1/1.25	7314150342181	1	16
3881-54-1.6-THQ-2/3	7314150138739	1	16
3881-54-1.6-THS-1.4/2	7314150138784	1	16
3881-54-1.6-THS-1/1.25	7311518269050	1	16
3881-67-1.6-THQ-1.4/2	7314150120369	1	16
3881-67-1.6-THQ-1/1.25	7314150180097	1	16
3881-67-1.6-THQ-2/3	7311518328832	1	16
3881-67-1.6-THS-1.4/2	7314150138791	1	16
3881-67-1.6-THS-1/1.25	7311518269043	1	16
3881-67-1.6-THS-2/3	7311518328849	1	16
3881-80-1.6-THQ-7/1	7311518332938	1	16
3881-80-1.6-THQ-1.4/2	7311518328856	1	16
3881-80-1.6-THQ-1/1.25	7314150133918	1	16
3881-80-1.6-THQ-2/3	7311518328863	1	16
3881-80-1.6-THS-7/1	7311518279202	1	16
3881-80-1.6-THS-1.4/2	7314150195312	1	16
3881-80-1.6-THS-2/3	7314150215942	1	16



38A-08	7314150433469	25	331
38A-10	7314150431564	25	331
38A-12	7314150237944	1	331
38A-15	7314150237951	25	331
38A-21	7314150237968	1	331
38A-26	7314150237975	1	331
38C-26	7314150237982	1	331
39-24	7314151831301	1	331
3905-250-24-100	7311518299255	100	572
3905-300-14-100	7311518292201	100	572
3905-300-18-100	7311518292218	100	572
3905-300-24-100	7311518292225	100	572
3905-300-24-2P	7311518299248	10	572
3905-300-32-100	7311518292232	100	572
3906-250-18-100	7311518250997	100	571
3906-250-18-5P	7314150265534	10	571
3906-250-24-100	7311518251000	100	571
3906-250-24-5P	7314150265541	10	571
3906-250-32-100	7311518251017	100	571
3906-250-32-5P	7314150265558	10	571
3906-300-14-100	7311518233563	100	571
3906-300-14-10P	7311518233693	10	571
3906-300-14-5P	7314150265565	10	571
3906-300-18-100	7311518233570	100	571
3906-300-18-10P	7311518233723	10	571
3906-300-18-2P	7311518233617	10	571
3906-300-18-5P	7314150265572	10	571
3906-300-24-100	7311518233587	100	571
3906-300-24-10P	7311518233730	10	571
3906-300-24-2P	7311518233624	10	571
3906-300-24-5P	7311518237417	10	571
3906-300-32-100	7311518233594	100	571
3906-300-32-10P	7311518233747	10	571
3906-300-32-2P	7311518233631	10	571
3906-300-32-5P	7311518237424	10	571
3906-300-3P	7311518233754	10	571
3911-115-IM-10P	7314150485703	10	142
3911-115-T41-AL	7314150485642	25	142
3911-115-T41-I	7314150454570	25	142
3911-115-T41-IM	7314150454587	50	142
3911-115-T42-M	7314150454679	25	142
3911-115T41-IM	7314150460595	50	142
3911-125-IM-10P	7314150485680	10	142
3911-125-T41-AL	7314150485666	25	142
3911-125-T41-I	7314150454594	25	142
3911-125-T41-IM	7314150454600	50	142
3911-125-T42-M	7314150454686	25	142
3911-125T41-IM	7314150485444	25	142
3911-150-T41-I	7314150454624	50	142
3911-150-T42-M	7314150454709	25	142
3911-180-T41-I	7314150454631	50	142
3911-180-T41-IM	7314150454655	50	142
3911-180-T42-M	7314150454693	25	142
3911-180T41-IM	7314150485468	50	142
3911-230-T41-I	7314150454648	50	142
3911-230-T41-IM	7314150454662	50	142
3911-230-T42-M	7314150454716	50	142
3911-230T41-IM	7314150485482	50	142
3911-230T41-IM	7314150485628	50	142
3911-350-X2TM	7314150486366	35	142
3911-400-F2TM	7314150485963	15	142
3911-400-X2TM	7314150502967	15	142
3912-115-T41-IM	7314150454808	50	142
3912-115-T42-ST	7314150454723	25	142
3912-125-T41-IM	7314150454815	50	142
3912-125-T42-ST	7314150454730	25	142
3912-180-T42-ST	7314150454747	25	142
3912-230-T42-ST	7314150454754	50	142
3916-115-10P-CE	7314150455348	100	143
3916-115-10S-UE	7314150455270	100	143
3916-125-10P-CE	7314150455355	100	143
3916-125-10S-UE	7314150455287	100	143
3916-150-10S-UE	7314150455294	50	143
3916-180-10S-UE	7314150455300	50	143
3916-230-10L-RC	7314150455232	25	143
3916-230-10S-UE	7314150455317	25	143
3917-115-7S-C	7314150455324	100	143
3917-115-7S-U	7314150455249	100	143
3917-125-7S-C	7314150455331	100	143
3917-125-7S-U	7314150455256	100	143
3917-230-7S-U	7314150455263	25	143
3921-115-T27-IM	7314150454617	25	142
3921-125-T27-IM	7314150454761	25	142
3921-150-T27-IM	7314150454778	25	142
3921-180-T27-IM	7314150454785	25	142
3921-230-T27-IM	7314150454792	25	142
3926-115IM-C120	7314150454860	20	143
3926-115IM-C40	7314150454839	20	143
3926-115IM-C60	7314150454846	20	143
3926-115IM-C80	7314150454853	20	143
3926-125IM-C120	7314150454914	20	143
3926-125IM-C40	7314150454884	20	143
3926-125IM-C60	7314150454891	20	143
3926-125IM-C80	7314150454907	20	143
3927-115IM-P120	7314150454952	20	143
3927-115IM-P40	7314150454921	20	143



3927-115IM-P60	7314150454938	20	143
3927-115IM-P80	7314150454945	20	143
3927-125-120-3P	7314150499007	12	143
3927-125-40-3P	7314150498949	12	143
3927-125-60-3P	7314150498963	12	143
3927-125-80-3P	7314150498987	12	143
3927-125IM-P120	7314150455010	20	143
3927-125IM-P40	7314150454976	20	143
3927-125IM-P60	7314150454983	20	143
3927-125IM-P80	7314150455003	20	143
3940-100-14-SC-2P	7314150364466	10	134
3940-100-14-SC-5P	7314150364473	5	134
3940-100-14-ST-10P	7314150364336	1	134
3940-100-14-ST-2P	7314150364312	10	134
3940-100-14-ST-5P	7314150364329	5	134
3940-100-18-SC-2P	7314150364442	10	134
3940-100-18-SC-5P	7314150364459	5	134
3940-100-18-ST-10P	7314150364367	1	134
3940-100-18-ST-2P	7314150364343	10	134
3940-100-18-ST-5P	7314150364350	5	134
3940-100-24-SC-2P	7314150364558	10	134
3940-100-24-SC-5P	7314150364565	5	134
3940-100-24-ST-10P	7314150364435	1	134
3940-100-24-ST-2P	7314150364411	10	134
3940-100-24-ST-5P	7314150364428	5	134
3940-150-10-HST-10P	7314150364039	1	134
3940-150-10-HST-2P	7314150364015	10	134
3940-150-10-HST-5P	7314150364022	5	134
3940-150-10-ST-100P	7314150362196	1	134
3940-150-10-ST-10P	7314150362189	1	134
3940-150-10-ST-2P	7314150362165	10	134
3940-150-10-ST-5P	7314150362172	5	134
3940-150-14-HST-10P	7314150362370	1	134
3940-150-14-HST-2P	7314150362325	10	134
3940-150-14-HST-5P	7314150362363	5	134
3940-150-14-ST-100P	7314150364183	1	134
3940-150-14-ST-10P	7314150364176	1	134
3940-150-14-ST-2P	7314150364152	5	134
3940-150-14-ST-5P	7314150364169	5	134
3940-150-18-HST-10P	7314150364060	1	134
3940-150-18-HST-2P	7314150364046	10	134
3940-150-18-HST-5P	7314150364053	5	134
3940-150-18-ST-100P	7314150364107	1	134
3940-150-18-ST-10P	7314150364091	1	134
3940-150-18-ST-2P	7314150364077	10	134
3940-150-18-ST-5P	7314150364084	5	134
3940-150-24-ST-100P	7314150364404	1	134
3940-150-24-ST-10P	7314150364398	1	134
3940-150-24-ST-2P	7314150364374	5	134
3940-150-24-ST-5P	7314150364381	5	134
3940-150-4/6-SC-10P	7314150361847	1	135
3940-150-4/6-SC-2P	7314150361823	10	135
3940-150-4/6-SC-5P	7314150361830	5	135
3940-150-5/8-DSL-10P	7314150361991	1	135
3940-150-5/8-DSL-2P	7314150361977	10	135
3940-150-5/8-DSL-5P	7314150361984	5	135
3940-150-5/8-SL-100P	7314150361724	1	135
3940-150-5/8-SL-10P	7314150361717	1	135
3940-150-5/8-SL-2P	7314150361687	10	135
3940-150-5/8-SL-5P	7314150361700	5	135
3940-150-6-ST-10P	7314150361786	1	135
3940-150-6-ST-2P	7314150361762	10	135
3940-150-6-ST-5P	7314150361779	5	135
3940-150-8/12-ST-100P	7314150362158	1	134
3940-150-8/12-ST-10P	7314150362141	1	134
3940-150-8/12-ST-2P	7314150362127	10	134
3940-150-8/12-ST-5P	7314150362134	5	134
3940-228-10-DSL-100P	7314150362035	1	135
3940-228-10-DSL-10P	7314150362028	1	135
3940-228-10-DSL-2P	7314150362004	10	135
3940-228-10-DSL-5P	7314150362011	5	135
3940-228-10-HST-100P	7314150362417	1	134
3940-228-10-HST-10P	7314150362400	1	134
3940-228-10-HST-2P	7314150362387	10	134
3940-228-10-HST-5P	7314150362394	5	134
3940-228-10-PR09-100P	7314150361625	1	135
3940-228-10-ST-100P	7314150362110	1	134
3940-228-10-ST-10P	7314150362103	1	134
3940-228-10-ST-2P	7314150362080	10	134
3940-228-10-ST-5P	7314150362097	5	134
3940-228-10/14-PR09-100P	7314150361526	1	135
3940-228-10/14-PR09-10P	7314150361519	1	135
3940-228-10/14-PR13-100P	7314150361649	1	135
3940-228-10/14-PR13-10P	7314150451265	1	135
3940-228-14-HST-10P	7314150362226	1	134
3940-228-14-HST-2P	7314150362202	10	134
3940-228-14-HST-5P	7314150362219	5	134
3940-228-14-ST-100P	7314150364145	1	134
3940-228-14-ST-10P	7314150364138	1	134
3940-228-14-ST-2P	7314150364114	10	134
3940-228-14-ST-5P	7314150364121	5	134
3940-228-18-HST-10P	7314150362271	1	134
3940-228-18-HST-2P	7314150362233	10	134
3940-228-18-HST-5P	7314150362264	5	134
3940-228-18-ST-100P	7314150364220	1	134
3940-228-18-ST-10P	7314150364213	1	134



3940-228-18-ST-2P



3940-228-18-ST-2P	7314150364190	10	134
3940-228-18-ST-5P	7314150364206	5	134
3940-228-5/8-DSL-10P	7314150361939	1	135
3940-228-5/8-DSL-2P	7314150361915	10	135
3940-228-5/8-DSL-5P	7314150361922	5	135
3940-228-6-SL-10P	7314150361755	1	135
3940-228-6-SL-2P	7314150361731	10	135
3940-228-6-SL-5P	7314150361748	5	135
3940-228-8/12-PR13-100P	7314150361601	1	135
3940-228-8/12-ST-100P	7314150362073	1	134
3940-228-8/12-ST-10P	7314150362066	1	134
3940-228-8/12-ST-2P	7314150362042	10	134
3940-228-8/12-ST-5P	7314150362059	5	134
3940-300-10-HST-10P	7314150362448	1	134
3940-300-10-HST-2P	7314150362424	10	134
3940-300-10-HST-5P	7314150362431	5	134
3940-300-14-HST-10P	7314150362301	1	134
3940-300-14-HST-2P	7314150362288	10	134
3940-300-14-HST-5P	7314150362295	5	134
3940-300-14-ST-100P	7314150364268	1	134
3940-300-14-ST-10P	7314150364251	1	134
3940-300-14-ST-2P	7314150364237	5	134
3940-300-14-ST-5P	7314150364244	5	134
3940-300-18-HST-10P	7314150364008	1	134
3940-300-18-HST-2P	7314150363988	10	134
3940-300-18-HST-5P	7314150363995	5	134
3940-300-18-ST-100P	7314150364305	1	134
3940-300-18-ST-10P	7314150364299	1	134
3940-300-18-ST-2P	7314150364275	10	134
3940-300-18-ST-5P	7314150364282	5	134
3940-300-5/8-DSL-10P	7314150361960	1	135
3940-300-5/8-DSL-2P	7314150361946	10	135
3940-300-5/8-DSL-5P	7314150361953	5	135
3940-300-6-SL-10P	7314150361816	1	135
3940-300-6-SL-2P	7314150361793	10	135
3940-300-6-SL-5P	7314150361809	5	135
3940-300-8/12-SL-100P	7314150361908	1	135
3940-300-8/12-SL-10P	7314150361892	1	135
3940-300-8/12-SL-2P	7314150361878	5	135
3940-300-8/12-SL-5P	7314150361885	5	135
3940-HDD-SET-5P	7314150401703	5	137
3940-METAL-SET-12P	7314150511488	6	137
3940-METAL-SET-5P	7314150401673	5	137
3940-MIX-SET-10P	7314150401666	4	137
3940-MIX-SET-12P	7314150511501	6	137
3940-MIX-SET-5P	7314150401659	5	137
3942-150-7-SL-10P	7314150364534	1	136
3942-150-7-SL-2P	7314150364510	10	136
3942-150-7-SL-5P	7314150364527	5	136
3942-228-11-HSL-10P	7314150364831	1	136
3942-228-11-HSL-2P	7314150364817	10	136
3942-228-11-HSL-5P	7314150364824	5	136
3942-228-5-HSL-10P	7314150364657	1	136
3942-228-5-HSL-2P	7314150364633	10	136
3942-228-5-HSL-5P	7314150364640	5	136
3942-228-7-HSL-10P	7314150364749	1	136
3942-228-7-HSL-2P	7314150364725	10	136
3942-228-7-HSL-5P	7314150364732	5	136
3942-228-7-SL-10P	7314150364503	1	136
3942-228-7-SL-2P	7314150364480	10	136
3942-228-7-SL-5P	7314150364497	5	136
3942-300-5-HSL-10P	7314150364688	1	136
3942-300-5-HSL-2P	7314150364664	10	136
3942-300-5-HSL-5P	7314150364671	5	136
3942-300-7-HSL-10P	7314150364770	1	136
3942-300-7-HSL-2P	7314150364756	10	136
3942-300-7-HSL-5P	7314150364763	5	136
3942-300-7-SL-10P	7314150364619	1	136
3942-300-7-SL-2P	7314150364596	10	136
3942-300-7-SL-5P	7314150364602	5	136
3942-WOOD-SET-12P	7314150511525	6	137
3942-WOOD-SET-5P	7314150401680	5	137
3943-C30-JT-F	7314150422869	10	136
3943-C30-JT-M	7314150422876	10	136
3943-C35-JT-C	7314150422937	10	136
3943-C35-JT-M	7314150422883	10	136
3943-R28-UT-C-2P	7314150422951	10	137
3943-S20-JT-F	7314150422944	10	136
3944-300-3-MEAT-1P	7314150364862	10	138
3946-100-DG-ST-2P	7314150478644	10	135
3946-150-10-HST-1P	7314150478156	10	135
3946-150-6-DSL-1P	7314150478101	10	136
3946-150-6-SL-1P	7314150364916	5	138
3946-150-8-HST-1P	7314150478132	10	135
3946-150-DG-ST-2P	7314150478668	10	135
3946-228-10-HST-1P	7314150478255	10	135
3946-228-3-ST-1P	7314150364886	5	138
3946-228-6-DSL-1P	7314150478217	10	136
3946-228-8-HST-1P	7314150478231	10	135
3946-300-10-HST-1P	7314150478323	10	135
3946-300-2-CB-1P	7314150478354	10	138
3946-300-6-DSL-1P	7314150478286	10	136
3946-300-6-ST-1P	7314150364923	5	138
3946-300-8-HST-1P	7314150478309	10	135
3946-457-2-CB-1P	7314150478378	10	138
396-BLADE	7311518299057	100	649



396-BLADE-1P	7311518330613	1	649
396-HP	7311518152284	4	649
396-HP-BLADE	7311518156404	300	650
396-INS	7314150422708	10	575
396-JS	7311518223250	4	649
396-JS-BLADE	7311518223267	300	650
396-JT	7311518168056	4	649
396-JT-BLADE	7311518168063	300	650
396-LAP	7311518172367	10	649
4-138-06-1-0	7311518020927	10	27
4-138-06-1-2	7311518000592	5	27
4-138-08-1-0	7311518020934	10	27
4-138-08-1-2	7311518000615	5	27
4-138-10-1-0	7311518020958	10	27
4-138-10-1-2	7311518000646	5	27
4-138-12-1-0	7311518020965	5	27
4-138-12-1-2	7311518194734	5	27
4-140-06-1-0	7311518020989	10	27
4-140-08-1-0	7311518020996	10	27
4-140-08-1-2	7311518028169	5	27
4-140-10-1-0	7311518022488	10	27
4-140-10-1-2	7311518194741	5	27
4-142-06-1-0	7311518021016	10	27
4-142-08-1-0	7311518021023	10	27
4-142-10-1-0	7311518021030	10	27
4-144-08-2-0	7311518021054	10	28
4-144-08-2-2	7311518021319	5	28
4-152-08-2-2	7311518000691	5	28
4-153-08-1-2	7311518000707	5	28
4-154-08-2-2	7311518000714	10	28
4-155-08-2-0	7311518116194	10	28
4-155-10-2-0	7311518116200	5	28
4-183-04-2-0	7311518021108	10	28
4-183-04-2-2	7311518021401	5	28
4-183-05-2-0	7311518021122	10	28
4-183-05-2-2	7311518021418	5	28
4-183-06-2-0	7311518021139	10	28
4-183-06-2-2	7311518000769	5	28
4-183-07-2-0	7311518021146	10	28
4-183-07-2-2	7311518194710	5	28
4-183-08-2-0	7311518021153	10	28
4-183-08-2-2	7311518194727	5	28
4-183-10-2-0	7311518021160	10	28
4-183-45-2-0	7311518021115	10	28
4-186-04-2-0	7311518021191	10	28
4-186-04-2-2	7311518021425	5	29
4-186-05-2-0	7311518021214	10	28
4-186-05-2-2	7311518028213	5	29
4-186-06-2-0	7311518021221	10	28
4-186-06-2-2	7311518000837	5	29
4-186-07-2-0	7311518021238	10	28
4-186-08-2-0	7311518021245	10	28
4-186-45-2-0	7311518021207	10	28
4-187-04-2-0	7311518021269	10	29
4-187-05-2-0	7311518021283	10	29
4-187-05-2-2	7311518021449	5	29
4-187-06-2-0	7311518021290	10	29
4-187-06-2-2	7311518022464	5	29
4-187-07-2-0	7311518021306	10	29
4-187-45-2-0	7311518021276	10	29
4-188-05-2-0	7311518021337	10	29
4-188-05-2-2	7311518021456	5	29
4-188-06-2-0	7311518021344	10	29
4-190-06-2-2	7311518000899	5	29
4-190-07-2-0	7311518021375	10	29
4-190-07-2-2	7311518000905	5	29
4-190-08-2-0	7311518021382	10	29
4-190-08-2-2	7311518000912	5	29
4-192-06-2-0	7311518021412	10	29
4-192-06-2-2	7311518021463	5	29
4-192-07-2-0	7311518021429	10	29
4-192-08-2-0	7311518021436	10	29
4-192-08-2-2	7311518021487	5	29
4-202-85-2-0	7311518021474	10	30
4-204-85-2-0	7311518021498	10	30
4-272-05-3-2	7311518021500	5	30
4-272-06-3-0	7311518021597	10	30
4-272-06-3-2	7311518001025	5	30
400.002.050	7314150249848	1	623
400.003.020	8412814403205	1	623
400.003.030	8412814403304	1	623
401-16	7314150400270	12	268
401-28	7314150384082	12	268
402-15-95	7314150485604	1	269
402-35	7314150384099	6	268
402-76	7314150384105	6	268
402-95-SET	7314150400997	1	269
4020L-M-3	7314151077693	5	43
4020L-M-3.2	7314151405038	5	43
4020L-M-3.5	7314151077709	5	43
4020L-M-4	7314151077716	5	43
4020L-M-4.5	7314151077723	5	43
4020L-M-5	7314151077730	5	43
4020L-M-5.5	7314151077747	5	43
4040M-10-11	7314151078287	1	59
4040M-10-13	7314153000750	1	59



4040M-12-13	7314151078294	1	59
4040M-13-17	7314151804565	1	59
4040M-14-15	7314151078300	1	59
4040M-16-17	7314151078317	1	59
4040M-16-18	7314151839635	1	59
4040M-17-19	7314151804572	1	59
4040M-18-19	7314151078324	1	59
4040M-20-22	7314151078331	1	59
4040M-21-23	7314151078348	1	59
4040M-24-27	7314151831974	1	59
4040M-6-7	7314151831967	1	59
4040M-8-9	7314151078270	1	59
4040M/6T	7314150112197	1	59
4040M/S6	7314150112180	1	59
4040Z-1/2-9/16	7314151831998	1	59
4040Z-13/16-7/8	7314150355099	1	59
4040Z-3/8-7/16	7314151831981	1	59
4040Z-5/8-11/16	7314151832001	1	59
4040Z-5/8-3/4	73141503001023	1	59
405-1000	7314150399758	5	554
405-1000-M	7314150399765	5	554
405-400	7314150399673	5	554
405-400-M	7314150399680	5	554
405-600	7314150399697	5	554
405-600-M	7314150399703	5	554
405-800	7314150399710	10	554
405-800-M	7314150399741	5	554
405L-400	7314150400461	10	554
405L-400-M	7314150400492	5	554
405L-600	7314150400478	10	554
405L-600-M	7314150400485	5	554
406-300	7314150183678	1	554
406-300-M	7314150186358	5	554
406-400	7314150183685	5	554
406-400-M	7314150183838	5	554
406-500	7314150183692	5	554
406-500-M	7314150186365	5	554
406-600	7314150245819	5	554
406-600-M	7314150245840	5	554
406-800	7314150245826	5	554
406P-400	7314150302574	10	554
406P-600	7314150302581	10	554
406T-225	7314150315130	10	555
407-1000	7314150369928	6	609
407-1400	7314150373703	6	609
407-700	7314150369911	6	609
407F-1000	7314150383801	5	609
407F-1400	7314150383818	6	609
407F-700	7314150383795	6	609
40B-115-165	7314153011879	25	60
40B-115-165-SP	7314153024459	1	60
40B-150-230	7314153024534	8	60
40B-19-50	7314153011848	25	60
40B-19-50-SP	7314153024473	1	60
40B-32-75	7314153011855	25	60
40B-32-75-SP	7314153024497	1	60
40B-50-120	7314153011862	20	60
40B-50-120-SP	7314153024510	1	60
4106-115-165	7314153024572	25	60
4106-150-230	7314153024596	8	60
4106-19-50	7314153011886	25	60
4106-32-75	7314153011893	25	60
4106-50-120	7314153024558	20	60
411-26	7314150412068	4	270
411-26-95	7314150412259	50	270
411-35	7314150412082	4	270
411-35-95	7314150412266	50	270
411-42	7314150412112	6	270
411-42-95	7314150412273	50	270
411-63	7314150412136	5	270
411-63-95	7314150412280	30	270
412-26-MULTI	7314150412174	5	270
412-26-MULTI-95	7314150412303	150	270
412-28-PEX	7314150412150	5	270
412-28-PEX-95	7314150412297	30	270
4124-JT-H	7311518267803	4	649
4128-JT-H	7311518267810	4	649
4130	7314150100019	3	233
413005000	8413345011860	12	612
413010000	8413345011877	12	612
413015000	8413345011884	12	612
413020000	8413345011891	6	612
413030000	8413345119986	1	612
413040000	8413345119993	1	612
4131	7314150100026	3	233
414-10	7311518238148	4	585
414-12	7311518238155	4	585
414-14	7311518238162	4	585
414-15	7311518238179	4	585
414-16	7311518238186	4	585
414-18	7311518238193	4	585
414-20	7311518238209	4	585
414-22	7311518238216	4	585
414-25	7311518238223	4	585
414-28	7311518238230	4	585
414-30	7311518238247	4	585



414-32	7311518238254	4	585
414-35	7311518238261	4	585
414-38	7311518238278	4	585
414-6	7311518238117	4	585
414-8	7311518238131	4	585
414-S3-EUR	7311518249205	1	585
416-1000	7314150314027	10	554
416-1200	7314150308798	10	554
416-1500	7314150314034	10	554
416-1800	7314150308804	10	554
416-2000	7314150308811	10	554
416-400	7314150314003	10	554
416-600	7314150308781	10	554
416-800	7314150314010	10	554
416-SET-1	7314150308828	5	555
416-SET-2	7314150308835	5	555
416-SET+ BAG	7314150365470	1	554
41RM-10	7314153014429	1	45
41RM-11	7314153014436	1	45
41RM-12	7314153014443	1	45
41RM-13	7314153014450	1	45
41RM-14	7314153014467	1	45
41RM-17	7314153014474	1	45
41RM-19	7314153014481	1	45
41RM-21	7314150219742	1	45
41RM-8	7314153014412	1	45
41RM/SH8	7314150220656	10	46
41RZ-1/2	7314150359011	1	45
41RZ-11/16	7314150359042	1	45
41RZ-13/16	7314150359066	1	45
41RZ-3/4	7314150359059	1	45
41RZ-3/8	7314150358991	1	45
41RZ-5/16	7314150358984	1	45
41RZ-5/8	7314150359035	1	45
41RZ-7/16	7314150359004	1	45
41RZ-7/8	7314150359073	1	45
41RZ-9/16	7314150359028	1	45
420SC-25	7314150169825	10	603
420SC-50	7314150169832	5	603
420SH-100-200	7314150359691	10	602
420SH-120-1000	7314150359790	6	602
420SH-120-1250	7314150359806	6	602
420SH-120-1500	7314150359813	6	602
420SH-120-250	7314150359707	8	602
420SH-120-300	7314150359745	8	602
420SH-120-400	7314150359752	6	602
420SH-120-500	7314150359769	6	602
420SH-120-600	7314150359776	6	602
420SH-120-800	7314150359783	6	602
420SH-140-400	7314150359820	6	602
420SH-175-400	7314150359837	6	602
420SH-50-100	7314150359646	10	602
420SH-50-200	7314150359653	10	602
420SH-60-120	7314150359660	12	602
420SH-60-300	7314150359677	12	602
420SH-80-160	7314150359684	12	602
4211-11-6T	7311518152000	4	649
4211-14-6T	7311518128883	4	649
4212-11-6T	7311518002060	4	649
4212-14-6T	7311518002077	4	649
422P-10	7311518248369	4	586
422P-12	7311518248376	4	586
422P-16	7311518248383	4	586
422P-20	7311518248390	4	586
422P-25	7311518248406	4	586
422P-6	7311518248352	4	586
4231	7314150100033	3	235
4239	7314150100088	3	235
424P-10	7311518238315	4	584
424P-12	7311518238322	4	584
424P-14	7311518238339	4	584
424P-15	7311518238346	4	584
424P-16	7311518238353	4	584
424P-18	7311518238360	4	584
424P-20	7311518238377	4	584
424P-22	7311518238384	4	584
424P-24	7311518238391	4	584
424P-25	7311518238407	4	584
424P-26	7311518238414	4	584
424P-28	7311518238421	4	584
424P-30	7311518238438	4	584
424P-32	7311518238445	4	584
424P-35	7311518238452	4	584
424P-38	7311518238469	4	584
424P-4	7311518238285	4	584
424P-40	7311518238476	4	584
424P-6	7311518238292	4	584
424P-8	7311518238308	4	584
424P-S3-EUR	7311518249199	1	584
424P-S6-EUR	7311518269968	1	585
424P-S6-GER	7311518280086	1	585
424P-S6-LR	7314150423804	1	584
424P-S6-PP	7314150326662	1	585
424P-S8-EUR	7311518276393	1	585
425-081	7311518010669	1	586
425-082	7311518010676	1	586





425-083	7311518010683	1	586
425-10	7311518004613	4	586
425-12	7311518004620	4	586
425-14	7311518004637	4	586
425-15	7311518017767	4	586
425-16	7311518004644	4	586
425-18	7311518004651	4	586
425-20	7311518004668	4	586
425-22	7311518004675	4	586
425-24	7311518005993	4	586
425-25	7311518004682	4	586
425-26	7311518006006	4	586
425-28	7311518004699	4	586
425-30	7311518004705	4	586
425-32	7311518004712	4	586
425-35	7311518017774	4	586
425-38	7311518004729	4	586
425-4	7311518030810	4	586
425-40	7311518017781	4	586
425-6	7311518004590	4	586
425-8	7311518004606	4	586
426-1000	7311518004309	1	553
426-1200	7311518004316	1	553
426-400	7311518004255	1	553
426-600	7311518004279	1	553
426-800	7311518004293	1	553
426TOR9	7314150125319	10	555
427-13	7314150403578	4	606
427-16	7311518025410	4	606
427-20	7311518025427	4	606
427-24	7314150402878	4	606
427-700	7314150338092	6	606
427-8	7314150402854	4	606
427S-16	7314150404247	4	606
427S-20	7314150404261	4	606
428-16	7311518012380	4	606
428-700	7314150338108	6	607
428F-13	7314150436392	4	606
428F-16	7314150436408	4	606
428F-20	7314150436422	4	606
428F-24	7314150436439	4	606
428F-8	7314150436378	4	606
428S-16	7314150424030	4	606
428S-20	7314150424047	4	606
429-13	7311518012250	4	606
429-16	7311518012403	4	606
429-20	7311518012410	4	606
429-8	7311518040703	4	606
42RM/S12	7314150384785	1	46
4307	7314151079444	1	60
4310	7314151079451	1	60
434-10	7311518238506	4	584
434-12	7311518238513	4	584
434-14	7311518238520	4	584
434-15	7311518238537	4	584
434-16	7311518238544	4	584
434-18	7311518238551	4	584
434-20	7311518238568	4	584
434-22	7311518238575	4	584
434-25	7311518238582	4	584
434-28	7311518238599	4	584
434-30	7311518238605	4	584
434-32	7311518238612	4	584
434-35	7311518238629	4	584
434-38	7311518238636	4	584
434-50	7311518285388	4	584
434-6	7311518238483	4	584
434-8	7311518238490	4	584
434-S3-EUR	7311518249212	1	584
434-S6-EUR	7311518267544	1	584
434-S6-LR	7314150423811	1	584
434-S6-PP	7314150326655	1	584
434-S8-EUR	7311518295110	1	584
439000000	8413345129282	1	481
439000001	7314150268788	1	481
439000002	7314150309702	1	481
439000003	7314150309719	1	481
439000004	7314150427666	1	481
4400-11	7311518200596	10	650
4400-11-BULK	7311518200633	10	650
4400-14	7311518200602	10	650
4400-14-BULK	7311518200640	10	650
440102500	8413345098977	10	609
440103000	8413345098991	10	609
4411-1.00	7314150372744	1	151
4411-1.50	7314150372768	1	151
4411-10.00	7314150372973	1	151
4411-10.20	7314150372980	1	151
4411-10.50	7314150470488	1	151
4411-11.00	7314150372997	1	151
4411-11.50	7314150470495	1	151
4411-12.00	7314150373000	1	151
4411-12.50	7314150470501	1	151
4411-13.00	7314150373017	1	151
4411-2.00	7314150372775	1	151
4411-2.50	7314150372782	1	151



4411-3.00	7314150372799	1	151
4411-3.25	7314150372805	1	151
4411-3.30	7314150372812	1	151
4411-3.50	7314150372829	1	151
4411-4.00	7314150372836	1	151
4411-4.20	7314150372843	1	151
4411-4.25	7314150372850	1	151
4411-4.50	7314150372867	1	151
4411-5.00	7314150372874	1	151
4411-5.50	7314150372881	1	151
4411-6.00	7314150372898	1	151
4411-6.50	7314150372904	1	151
4411-6.80	7314150372911	1	151
4411-7.00	7314150372928	1	151
4411-7.50	7314150372935	1	151
4411-8.00	7314150372942	1	151
4411-8.50	7314150372959	1	151
4411-9.00	7314150372966	1	151
4411-9.50	7314150394463	1	151
4413-1.00	7314150371754	1	152
4413-1.50	7314150371761	1	152
4413-10.00	7314150372034	1	152
4413-10.20	7314150372041	1	152
4413-10.50	7314150470556	25	152
4413-11.00	7314150372058	1	152
4413-11.50	7314150470563	25	152
4413-12.00	7314150372065	1	152
4413-12.50	7314150470570	25	152
4413-13.00	7314150372072	1	152
4413-2.00	7314150371785	1	152
4413-2.50	7314150371792	1	152
4413-3.00	7314150371815	1	152
4413-3.25	7314150371822	1	152
4413-3.30	7314150371877	1	152
4413-3.50	7314150371884	1	152
4413-4.00	7314150371891	1	152
4413-4.20	7314150371907	1	152
4413-4.25	7314150371914	1	152
4413-4.50	7314150371921	1	152
4413-5.00	7314150371938	1	152
4413-5.50	7314150371945	1	152
4413-6.00	7314150371952	1	152
4413-6.50	7314150371969	1	152
4413-6.80	7314150371976	1	152
4413-7.00	7314150371983	1	152
4413-7.50	7314150371990	1	152
4413-8.00	7314150372003	1	152
4413-8.50	7314150372010	1	152
4413-9.00	7314150372027	1	152
4413-9.50	7314150394456	1	152
4415-1.00	7314150394210	1	153
4415-1.50	7314150394227	1	153
4415-10.00	7314150394401	1	153
4415-10.50	7314150470525	1	153
4415-11.00	7314150394418	1	153
4415-11.50	7314150470532	1	153
4415-12.00	7314150394425	1	153
4415-12.50	7314150470549	1	153
4415-13.00	7314150394432	1	153
4415-13.50	7314150441495	1	153
4415-14.00	7314150441501	1	153
4415-14.50	7314150441518	1	153
4415-15.00	7314150441525	1	153
4415-15.50	7314150441532	1	153
4415-16.00	7314150441549	1	153
4415-16.50	7314150441556	1	153
4415-17.00	7314150441563	1	153
4415-17.50	7314150441570	1	153
4415-18.00	7314150441587	1	153
4415-18.50	7314150441594	1	153
4415-19.00	7314150441600	1	153
4415-19.50	7314150441617	1	153
4415-2.00	7314150394234	1	153
4415-2.50	7314150394241	1	153
4415-20.00	7314150441624	1	153
4415-3.00	7314150394258	1	153
4415-3.25	7314150394265	1	153
4415-3.50	7314150394272	1	153
4415-4.00	7314150394289	1	153
4415-4.25	7314150394296	1	153
4415-4.50	7314150394302	1	153
4415-5.00	7314150394319	1	153
4415-5.50	7314150394326	1	153
4415-6.00	7314150394333	1	153
4415-6.50	7314150394340	1	153
4415-7.00	7314150394357	1	153
4415-7.50	7314150394364	1	153
4415-8.00	7314150394371	1	153
4415-8.50	7314150394388	1	153
4415-9.00	7314150394395	1	153
442	7311518002848	10	562
442 B	7314150008957	1	266
442-3P	7314150309610	10	562
4420-11	7311518200619	10	650
4420-11-BULK	7311518200657	10	650
4420-14	7311518200626	10	650



4420-14-BULK	7311518200664	10	650
443 B	7314150008971	1	266
4430	7314150100040	3	245
4435-12.4	7314150465163	1	154
444 B	7314150009008	1	266
4480/2-ZD	7311518276911	1	271
4480IM	7314150263165	1	271
4480MM	7314150263158	1	271
449	7311518005337	10	562
44Z-1/2-9/16	7314150375233	10	53
44Z-1/4-5/16	7314150375196	10	53
44Z-11/16-13/16	7314150375264	5	53
44Z-11/16-3/4	7314150375257	5	53
44Z-3/8-7/16	7314150375219	10	53
44Z-5/16-3/8	7314150375202	10	53
44Z-5/8-3/4	7314150375240	5	53
44Z-7/16-1/2	7314150375226	10	53
451	7311518014506	10	562
4511-0.50-10P	7314150373079	1	151
4511-0.75-10P	7314150373062	1	151
4511-1.00-10P	7314150373055	1	151
4511-1.50-10P	7314150373086	1	151
4511-1.75-10P	7314150373093	1	151
4511-10.00-5P	7314150373444	1	151
4511-10.20-5P	7314150373468	1	151
4511-10.30-5P	7314150373475	1	151
4511-10.50-5P	7314150373482	1	151
4511-10.80-5P	7314150373499	1	151
4511-11.00-5P	7314150373505	1	151
4511-11.50-5P	7314150373512	1	151
4511-12.00-5P	7314150373529	1	151
4511-12.50-5P	7314150373536	1	151
4511-12.80-5P	7314150373543	1	151
4511-13.00-5P	7314150373550	1	151
4511-13.50-1P	7314150373567	1	151
4511-14.00-1P	7314150373574	1	151
4511-14.50-1P	7314150373581	1	151
4511-15.00-1P	7314150373598	1	151
4511-15.50-1P	7314150373604	1	151
4511-16.00-1P	7314150373611	1	151
4511-16.50-1P	7314150373628	1	151
4511-17.00-1P	7314150373635	1	151
4511-17.50-1P	7314150373642	1	151
4511-18.00-1P	7314150373659	1	151
4511-18.50-1P	7314150373673	1	151
4511-19.00-1P	7314150373680	1	151
4511-19.50-1P	7314150373697	1	151
4511-2.00-10P	7314150373109	1	151
4511-2.50-10P	7314150373116	1	151
4511-2.70-10P	7314150373123	1	151
4511-2.90-10P	7314150373130	1	151
4511-20.00-1P	7314150373666	1	151
4511-3.00-10P	7314150373147	1	151
4511-3.10-10P	7314150373185	1	151
4511-3.25-10P	7314150373192	1	151
4511-3.30-10P	7314150373208	1	151
4511-3.50-10P	7314150373215	1	151
4511-3.80-10P	7314150373222	1	151
4511-4.00-10P	7314150373239	1	151
4511-4.20-10P	7314150373246	1	151
4511-4.50-10P	7314150373253	1	151
4511-4.80-10P	7314150373260	1	151
4511-5.00-10P	7314150373277	1	151
4511-5.20-10P	7314150373284	1	151
4511-5.50-10P	7314150373291	1	151
4511-6.00-10P	7314150373307	1	151
4511-6.20-10P	7314150373314	1	151
4511-6.50-10P	7314150373321	1	151
4511-6.80-10P	7314150373338	1	151
4511-7.00-10P	7314150373345	1	151
4511-7.20-10P	7314150373352	1	151
4511-7.50-10P	7314150373369	1	151
4511-7.80-10P	7314150373376	1	151
4511-8.00-10P	7314150373383	1	151
4511-8.50-10P	7314150373390	1	151
4511-8.60-10P	7314150373406	1	151
4511-8.80-10P	7314150373413	1	151
4511-9.00-10P	7314150373420	1	151
4511-9.20-10P	7314150373437	1	151
4511-9.50-10P	7311518339081	1	151
4511-9.60-10P	7314150373451	1	151
4511-SET-19	7314150373031	1	151
4511-SET-25	7314150373048	1	152
4511-SET-6	7314150373024	1	151
4513-1.00-10P	7314150372119	1	152
4513-1.50-10P	7314150372126	1	152
4513-1.75-10P	7314150372133	1	152
4513-10.00-5P	7314150391998	1	152
4513-10.20-5P	7314150392001	1	152
4513-10.30-5P	7314150392018	1	152
4513-10.50-5P	7314150392025	1	152
4513-10.80-5P	7314150392032	1	152
4513-11.00-5P	7314150392049	1	152
4513-11.50-5P	7314150392056	1	152
4513-12.00-5P	7314150392063	1	152
4513-12.50-5P	7314150392070	1	152



4513-12.80-5P	7314150392087	1	152
4513-13.00-5P	7314150392094	1	152
4513-13.50-1P	7314150392100	1	152
4513-14.00-1P	7314150392117	1	152
4513-14.50-1P	7314150392124	1	152
4513-15.00-1P	7314150392131	1	152
4513-15.50-1P	7314150392148	1	152
4513-16.00-1P	7314150392155	1	152
4513-16.50-1P	7314150392162	1	152
4513-17.00-1P	7314150392179	1	152
4513-17.50-1P	7314150392186	1	152
4513-18.00-1P	7314150392193	1	152
4513-18.50-1P	7314150392209	1	152
4513-19.00-1P	7314150392216	1	152
4513-19.50-1P	7314150392223	1	152
4513-2.00-10P	7314150372140	1	152
4513-2.50-10P	7314150372157	1	152
4513-2.70-10P	7314150372164	1	152
4513-2.90-10P	7314150372171	1	152
4513-20.00-1P	7314150392230	1	152
4513-3.00-10P	7314150372188	1	152
4513-3.10-10P	7314150372195	1	152
4513-3.25-10P	7314150372201	1	152
4513-3.30-10P	7314150372218	1	152
4513-3.50-10P	7314150372225	1	152
4513-3.80-10P	7314150372232	1	152
4513-4.00-10P	7314150372249	1	152
4513-4.20-10P	7314150372256	1	152
4513-4.50-10P	7314150372263	1	152
4513-4.80-10P	7314150372270	1	152
4513-5.00-10P	7314150372287	1	152
4513-5.20-10P	7314150372294	1	152
4513-5.50-10P	7314150372300	1	152
4513-6.00-10P	7314150372317	1	152
4513-6.20-10P	7314150372324	1	152
4513-6.50-10P	7314150372331	1	152
4513-6.80-10P	7314150372348	1	152
4513-7.00-10P	7314150372355	1	152
4513-7.20-10P	7314150372362	1	152
4513-7.50-10P	7314150372379	1	152
4513-7.80-10P	7314150372386	1	152
4513-8.00-10P	7314150372393	1	152
4513-8.50-10P	7314150372409	1	152
4513-8.60-10P	7314150372416	1	152
4513-8.80-10P	7314150372423	1	152
4513-9.00-10P	7314150372430	1	152
4513-9.20-10P	7314150372447	1	152
4513-9.50-10P	7314150372454	1	152
4513-9.60-10P	7314150372461	1	152
4513-SET-19	7314150372096	1	152
4513-SET-25	7314150372102	1	153
4513-SET-6	7314150372089	1	152
4515-1.00-10P	7314150441228	1	153
4515-1.50-10P	7314150441235	1	153
4515-10.00-10P	7314150441426	1	153
4515-10.50-5P	7314150441433	1	153
4515-11.00-5P	7314150441440	1	153
4515-11.50-5P	7314150441457	1	153
4515-12.00-5P	7314150441464	1	153
4515-12.50-5P	7314150441471	1	153
4515-13.00-5P	7314150441488	1	153
4515-2.00-10P	7314150441242	1	153
4515-2.50-10P	7314150441259	1	153
4515-3.00-10P	7314150441266	1	153
4515-3.25-10P	7314150441273	1	153
4515-3.50-10P	7314150441280	1	153
4515-4.00-10P	7314150441297	1	153
4515-4.25-10P	7314150441303	1	153
4515-4.50-10P	7314150441310	1	153
4515-5.00-10P	7314150441327	1	153
4515-5.50-10P	7314150441334	1	153
4515-6.00-10P	7314150441341	1	153
4515-6.50-10P	7314150441358	1	153
4515-7.00-10P	7314150441365	1	153
4515-7.50-10P	7314150441372	1	153
4515-8.00-10P	7314150441389	1	153
4515-8.50-10P	7314150441396	1	153
4515-9.00-10P	7314150441402	1	153
4515-9.50-10P	7314150441419	1	153
4515-SET-19	7314150394449	1	153
4515-SET-25	7314150441709	1	153
4518-3	7314151716547	1	369
4518-4	7314151716622	1	369
4518-5	7314151716899	1	369
4519-1	7314151716974	1	367
4519-1/B	7314150225149	1	367
4519-1/S	7314151843762	1	367
4519-2	7314151717193	1	367
4519-2/S	7314151843977	1	367
4519-23/B	7314150225156	1	367
4519-3	7314151717278	1	367
4519K1	7314150225163	1	367
4519K2	7314150225170	1	367
4519K3	7314150225187	1	367
4521N-0	7314151837723	1	369
4521N-00	7314151837716	1	369



4521N-A



4521N-A	7314151837730	1	369
4521N-B	7314151837747	1	369
4521N-C	7314151837754	1	369
4521N-D	7314151837761	1	369
4521N-E	7314151837778	1	369
4521N-F	7314151837785	1	369
4521N-G	7314151837792	1	369
4521N-H	7314151837808	1	369
4521N-I	7314151837815	1	369
4521N-K	7314151837822	1	369
4521N-L	7314151837839	1	369
4521N-M	7314151837846	1	369
4521N-S	7314151839789	1	369
4521N-T	7314151839796	1	369
4521N/7	7314151839802	1	369
4522-1	7314151081591	1	369
4522-1/B	7314150225033	1	369
4522-1/S	7314150225064	1	369
4522-2	7314151081614	1	369
4522-2/B	7314150225057	1	369
4522-2/S	7314150225071	1	369
4522K1	7314150225088	1	369
4522K2	7314150225095	1	369
4523G	7314151846695	1	369
4524G	7314151718596	1	369
4528-1	7314151718671	1	366
4528-1/B	7314150224692	1	366
4528K1	7314151837662	1	366
4528K2	7314151837679	1	366
4528K3	7314151837686	1	366
4528K4	7314151837693	1	366
4528K5	7314151837709	1	366
4528M1	7314151718916	1	367
4528M1/B	7314150224654	1	367
4528M1/P	7314150330959	1	367
4528M2	7314151719050	1	367
4528M2/B	7314150224661	1	367
4528M2/P	7314150330980	1	367
4528M3	7314151719135	1	367
4528M3/P	7314150330973	1	367
4528M345/B	7314150224678	1	367
4528M4	7314151719210	1	367
4528M5	7314151719487	1	367
4528MK5	7314150224685	1	367
4529-15	7314151719647	1	366
4529-8	7314151719562	1	366
4530	7314150100095	3	246
4532-0	7314151719722	1	366
4532-A	7314151082109	1	366
4532-AL	7314150221912	1	366
4532-B	7314151082116	1	366
4532-BL	7314150221929	1	366
4532-C	7314151082123	1	366
4532-CD/S	7314151818067	1	366
4532-CL	7314150221936	1	366
4532-D	7314151082130	1	366
4532-E	7314151082147	1	366
4532-EFG/S	7314151838386	1	366
4532-F	7314151082154	1	366
4532-G	7314151082161	1	366
4532-G-SO	7314151841003	1	366
4532-H	7314151719999	1	366
4532-H/S	7314151838393	1	366
4532-OAB/S	7314151818050	1	366
4532K1	7314151082185	1	366
4532K2	7314151082192	1	366
4532K3	7314151082208	1	366
4532K4	7314151720148	1	366
4532LK1	7314151082215	1	366
4532LK2	7314151082222	1	366
4532LK3	7314151082239	1	366
4532LK4	7314151082246	1	366
4532LK5	7314151720223	1	366
4532ST/5	7314151720490	1	366
4533HP	7314151793043	1	366
4533HP/S	7314150224487	1	366
4533HPK	7314150224500	1	366
4533M	7314151793050	1	366
4533M/S	7314150224494	1	366
4533MK	7314150224517	1	366
4537-1	7314151720650	1	367
4537-1/B	7314150224562	1	367
4537-2	7314151720735	1	367
4537-2/B	7314150224579	1	367
4537-3	7314151720810	1	367
4537-34/B	7314150224586	1	367
4537-4	7314151721039	1	367
4537K1	7314150224593	1	367
4537K2	7314150224609	1	367
4537K3	7314150224616	1	367
4537K4	7314150224623	1	367
4540-17	7314150125005	1	368
4540-17/S	7314150225248	1	368
4540-25	7314150125012	1	368
4540-25/S	7314150225286	1	368
4541-A	7314151082413	1	367



4541-A/B	7314150224524	1	367
4541-B	7314151082420	1	367
4541-B/B	7314150224531	1	367
4541KA	7314150224548	1	367
4541KB	7314150224555	1	367
4542-A	7314151082451	1	367
4542-A/B	7314150224630	1	367
4542-B	7314151082468	1	367
4542-B/B	7314150224647	1	367
4543-1	7314151082499	1	367
4543-1/S	7314151818623	1	367
4543-10	7314151721466	1	367
4543-1020/B	7314150224715	1	367
4543-12/B	7314150224708	1	367
4543-2	7314151082505	1	367
4543-2/S	7314151818661	1	367
4543-20	7314151721541	1	367
4543-3	7314151721381	1	367
4543-3/B	7314150224739	1	367
4543-3/S	7314151818708	1	367
4543-30	7314151721626	1	367
4543-30/B	7314150224722	1	367
4543K110	7314150224746	1	367
4543K220	7314150224753	1	367
4543K330	7314150224760	1	367
4544-1	7314151844004	1	366
4544-1/B	7314150224845	1	367
4544-10	7314151844042	1	367
4544-10/B	7314150224883	1	367
4544-110/S	7314150224777	1	367
4544-2	7314151844011	1	366
4544-2/B	7314150224852	1	367
4544-20	7314151844059	1	367
4544-20/B	7314150224890	1	367
4544-220/S	7314150224784	1	367
4544-3	7314151844028	1	367
4544-3/B	7314150224869	1	367
4544-30	7314151844066	1	367
4544-30/B	7314150224906	1	367
4544-4	7314151844035	1	367
4544-4/B	7314150224876	1	367
4544-440/S	7314150224791	1	367
4544K110	7314150224807	1	367
4544K220	7314150224814	1	367
4544K330	7314150224821	1	367
4544K440	7314150224838	1	367
4545-1	7314151082543	1	370
4545-2	7314151082550	1	370
4545-3	7314151082567	1	370
4545-4	7314151722272	1	370
4545-5	7314151722357	1	370
4545-N1	7314151722432	1	369
4545-N1/S	7314150224913	1	369
4545-N11	7314150249169	1	369
4545-N2	7314151804947	1	369
4545-N2/S	7314150224920	1	369
4545-N21	7314150249176	1	369
4551-A	7314151082628	1	368
4551-A/S	7314150224937	1	368
4551-B	7314151722784	1	368
4551-B/S	7314150224944	1	368
4551-C	7314151082642	1	368
4551-C/S	7314150224951	1	368
4551-D	7314151082659	1	368
4551-D/S	7314150224968	1	368
4552-1	7314151722944	1	368
4552-1/B	7314150224975	1	368
4552-2	7314151723088	1	368
4552-2/B	7314150224982	1	368
4552-3	7314151723163	1	368
4552-3/B	7314150224999	1	368
4552K1	7314150225002	1	368
4552K2	7314150225019	1	368
4552K3	7314150225026	1	368
4553	7314151830649	1	371
4559-12	7314150113132	1	239
4559-12A JC	7314150223909	1	239
4559-18	7314150024513	8	239
4559-18B JC	7314150113880	1	239
4559-24	7314150024520	6	239
4559-24B JC	7314150113897	1	239
4559-30	7314150024537	5	239
4559-30B JC	7314150113903	1	239
4559-36	7314150024544	3	239
4559-36B JC	7314150113910	1	239
4559-42	7314150024551	2	239
4559-42A JC	7314150208876	1	239
4560-210	7314150178995	1	239
4574	7314151799014	1	368
4577	7314151838348	1	370
4578	7314150222308	1	369
4579	7314150222018	1	370
4580N/7	7314151301361	1	368
4581N-1	7314151724139	1	368
4581NA	7314151301200	1	368
4581NB	7314151301217	1	368



4581NB2	7314151724726	1	368
4581NC	7314151301224	1	368
4582N-1	7314151724214	1	368
4582N-2	7314151724481	1	368
4582NA	7314151301248	1	368
4582NB	7314151301255	1	368
4583N-1	7314151724566	1	368
4583N-2	7314151724641	1	368
4583NA	7314151301279	1	368
4583NB	7314151301286	1	368
4590SHS5	7314150384822	4	370
4591	7314151804039	1	371
4592	7314151804046	1	371
4593	7314151804053	1	371
4594VWT4	7314150403639	5	335
45S/H1.5	7314150218530	1	165
45S/H1.5-2P	7314150261505	50	165
45S/H2	7314150218547	1	165
45S/H2-2P	7314150261512	50	165
45S/H2.5	7314150218554	1	165
45S/H2.5-2P	7314150261529	50	165
45S/H3	7314150218561	1	165
45S/H3-2P	7314150261536	50	165
45S/PH1	7314150218516	1	165
45S/PH1-2P	7314150261482	50	165
45S/PH2	7314150218523	1	165
45S/PH2-2P	7314150261499	50	165
4610-1	7314151724993	1	370
4611-2	7314151725372	1	370
4611-2/B	7314150237500	1	370
4611-2/S	7314150237494	1	370
4611-3	7314150125043	1	370
4611-3/B	7314150237524	1	370
4611-3/S	7314150237517	1	370
4614-1	7314151725457	1	368
4614-1/B	7314150225101	1	368
4614-2	7314151725532	1	368
4614-2/B	7314150225118	1	368
4614K1	7314150225125	1	368
4614K2	7314150225132	1	368
4626-10.0	7314150457670	1	156
4626-4.0	7314150457632	1	156
4626-5.0	7314150457649	1	156
4626-6.0	7314150457656	1	156
4626-8.0	7314150457663	1	156
4629-10.0	7314150465385	1	156
4629-4.0	7314150465347	1	156
4629-5.0	7314150465354	1	156
4629-6.0	7314150465361	1	156
4629-8.0	7314150465378	1	156
4629-SET-5	7314150467204	10	156
4630	73141502216154	1	624
4641-10-120	7314150383085	1	150
4641-10-200	7314150383115	1	150
4641-10-400	7314150383207	1	150
4641-10-600	7314150383221	1	150
4641-11-150	7314150383122	1	150
4641-12-150	7314150383139	1	150
4641-12-200	7314150383146	1	150
4641-12-400	7314150383238	1	150
4641-12-600	7314150383245	1	150
4641-13-150	7314150383153	1	150
4641-14-150	7314150383160	1	150
4641-14-400	7314150383252	1	150
4641-14-600	7314150383269	1	150
4641-16-150	7314150383177	1	150
4641-16-400	7314150383276	1	150
4641-16-600	7314150383283	1	150
4641-18-400	7314150383290	1	150
4641-18-600	7314150383306	1	150
4641-20-400	7314150383313	1	150
4641-20-600	7314150383320	1	150
4641-22-400	7314150383337	1	150
4641-24-400	7314150383344	1	150
4641-25-400	7314150383351	1	150
4641-3-60	7314150382859	1	150
4641-4-75	7314150382866	1	150
4641-5-150	7314150382880	1	150
4641-5-85	7314150382873	1	150
4641-5.5-85	7314150382897	1	150
4641-6-100	7314150383016	1	150
4641-6-150	7314150383023	1	150
4641-6-400	7314150383184	1	150
4641-6.5-100	7314150383030	1	150
4641-7-100	7314150383047	1	150
4641-8-120	7314150383054	1	150
4641-8-200	7314150383061	1	150
4641-8-400	7314150383191	1	150
4641-9-120	7314150383078	1	150
4641-PB	7314150383368	1	150
4643-PB	7314150441679	1	150
4651-10-1000	7314150386413	1	149
4651-10-110	7314150386345	1	149
4651-10-160	7314150386352	1	149
4651-10-160-10P	7314150475483	1	149
4651-10-210	7314150386369	1	149



4651-10-210-10P	7314150475513	1	149
4651-10-260	7314150386376	1	149
4651-10-310	7314150386383	1	149
4651-10-450	7314150386390	1	149
4651-10-600	7314150386406	1	149
4651-12-1000	7314150386581	1	149
4651-12-160	7314150386529	1	149
4651-12-160-10P	7314150475490	1	149
4651-12-210	7314150386536	1	149
4651-12-210-10P	7314150475520	1	149
4651-12-260	7314150386543	1	149
4651-12-310	7314150386550	1	149
4651-12-450	7314150386567	1	149
4651-12-600	7314150386574	1	149
4651-14-1000	7314150386659	1	149
4651-14-160	7314150386598	1	149
4651-14-210	7314150386604	1	149
4651-14-260	7314150386611	1	149
4651-14-310	7314150386628	1	149
4651-14-450	7314150386635	1	149
4651-14-600	7314150386642	1	149
4651-15-160	7314150386666	1	149
4651-15-260	7314150386673	1	149
4651-15-450	7314150386680	1	149
4651-16-1000	7314150386765	1	149
4651-16-160	7314150386697	1	149
4651-16-210	7314150386710	1	149
4651-16-260	7314150386727	1	149
4651-16-310	7314150386734	1	149
4651-16-450	7314150386741	1	149
4651-16-600	7314150386758	1	149
4651-18-250	7314150386789	1	149
4651-18-450	7314150386796	1	149
4651-20-250	7314150386802	1	149
4651-20-450	7314150386819	1	149
4651-22-250	7314150386826	1	149
4651-22-450	7314150386833	1	149
4651-24-250	7314150386840	1	149
4651-24-450	7314150386857	1	149
4651-25-250	7314150386864	1	149
4651-25-450	7314150386871	1	149
4651-28-250	7314150386888	1	149
4651-28-450	7314150386895	1	149
4651-30-250	7314150386901	1	149
4651-30-450	7314150386918	1	149
4651-32-450	7314150386925	1	149
4651-5-110	7314150385683	1	149
4651-5-110-10P	7314150475407	1	149
4651-5-160	7314150385690	1	149
4651-5-160-10P	7314150475438	1	149
4651-5-260	7314150385713	1	149
4651-5-5-110	7314150385720	1	149
4651-5-5-110-10P	7314150475414	10	149
4651-5-5-160	7314150385737	1	149
4651-5-5-160-10P	7314150475445	1	149
4651-6-110	7314150385744	1	149
4651-6-110-10P	7314150475421	1	149
4651-6-160	7314150385751	1	149
4651-6-160-10P	7314150475452	1	149
4651-6-210	7314150385768	1	149
4651-6-260	7314150385775	1	149
4651-6-310	7314150385782	1	149
4651-6-5-110	7314150475391	50	149
4651-6-5-160	7314150385799	1	149
4651-6-5-160-10P	7314150475469	1	149
4651-6-5-210	7314150385805	1	149
4651-6-5-260	7314150385812	1	149
4651-6-5-310	7314150385829	1	149
4651-7-110	7314150385836	1	149
4651-7-160	7314150386253	1	149
4651-8-110	7314150386277	1	149
4651-8-160	7314150386284	1	149
4651-8-160-10P	7314150475476	1	149
4651-8-210	7314150386291	1	149
4651-8-210-10P	7314150475506	1	149
4651-8-260	7314150386307	1	149
4651-8-310	7314150386314	1	149
4651-8-460	7314150386321	1	149
4651-SET-5	7314150475537	1	149
4651-SET-7	7314150475544	1	149
4652-10-110	7314150385119	1	149
4652-10-160	7314150385126	1	149
4652-10-160-10P	7314150475322	1	149
4652-10-210	7314150385133	1	149
4652-10-210-10P	7314150475353	1	149
4652-10-260	7314150385140	1	149
4652-10-310	7314150385164	1	149
4652-10-450	7314150385171	1	149
4652-10-600	7314150385188	1	149
4652-11-160	7314150385195	1	149
4652-11-260	7314150385218	1	149
4652-12-1000	7314150385287	1	149
4652-12-160	7314150385225	1	149
4652-12-160-10P	7314150475339	1	149
4652-12-210	7314150385232	1	149
4652-12-210-10P	7314150475360	1	149





4652-12-260	7314150385249	1	149
4652-12-310	7314150385256	1	149
4652-12-450	7314150385263	1	149
4652-12-600	7314150385270	1	149
4652-13-310	7314150385300	1	150
4652-14-1000	7314150385379	1	150
4652-14-160	7314150385317	1	150
4652-14-210	7314150385324	1	150
4652-14-260	7314150385331	1	150
4652-14-310	7314150385348	1	150
4652-14-450	7314150385355	1	150
4652-14-600	7314150385362	1	150
4652-15-260	7314150385393	1	150
4652-16-1000	7314150385478	1	150
4652-16-210	7314150385416	1	150
4652-16-260	7314150385423	1	150
4652-16-310	7314150385430	1	150
4652-16-450	7314150385447	1	150
4652-16-600	7314150385454	1	150
4652-18-1000	7314150385515	1	150
4652-18-200	7314150385485	1	150
4652-18-300	7314150385492	1	150
4652-18-450	7314150385508	1	150
4652-20-1000	7314150385560	1	150
4652-20-200	7314150385522	1	150
4652-20-300	7314150385539	1	150
4652-20-450	7314150385546	1	150
4652-20-600	7314150385553	1	150
4652-22-1000	7314150385607	1	150
4652-22-250	7314150385577	1	150
4652-22-450	7314150385584	1	150
4652-22-600	7314150385591	1	150
4652-24-250	7314150385614	1	150
4652-24-450	7314150385621	1	150
4652-25-1000	7314150385652	1	150
4652-25-250	7314150385638	1	150
4652-25-450	7314150385645	1	150
4652-26-250	7314150385669	1	150
4652-26-450	7314150385676	1	150
4652-3-110	7314150475216	50	149
4652-3.5-110	7314150475223	50	149
4652-4-110	7314150384365	1	149
4652-4-160	7314150384372	1	149
4652-5-110	7314150384815	1	149
4652-5-110-10P	7314150475247	1	149
4652-5-160	7314150384839	1	149
4652-5-160-10P	7314150475278	1	149
4652-5-210	7314150384846	1	149
4652-5.5-110	7314150384853	1	149
4652-5.5-110-10P	7314150475254	10	149
4652-5.5-160	7314150384860	1	149
4652-5.5-160-10P	7314150475285	1	149
4652-5.5-210	7314150475230	50	149
4652-6-110	7314150384877	1	149
4652-6-110-10P	7314150475261	1	149
4652-6-160	7314150384891	50	149
4652-6-160-10P	7314150475292	1	149
4652-6-210	7314150384907	1	149
4652-6-260	7314150384969	1	149
4652-6.5-110	7314150384976	1	149
4652-6.5-160	7314150384990	1	149
4652-6.5-160-10P	7314150475308	1	149
4652-7-110	7314150385003	1	149
4652-7-160	7314150391981	1	149
4652-8-110	7314150385034	1	149
4652-8-160	7314150385058	1	149
4652-8-160-10P	7314150475315	1	149
4652-8-210	7314150385065	1	149
4652-8-210-10P	7314150475346	1	149
4652-8-260	7314150385072	1	149
4652-8-460	7314150385089	1	149
4652-9-160	7314150385096	1	149
4652-9-210	7314150385102	1	149
4652-SET-5	7314150475377	1	150
4652-SET-7	7314150475384	1	150
4655-FLAT-250	7314150387823	1	151
4655-HOLLOW-240	7314150387847	1	151
4655-POINT-250	7314150387816	1	151
4655-SLOT-25032	7314150387885	1	151
4655-TILE-20040	7314150387861	1	151
4655-WIDE-20040	7314150387830	1	151
4655-WING-C-250	7314150387854	1	151
4656-12-340	7314150386932	1	148
4656-12-540	7314150387021	1	148
4656-14-340	7314150387069	1	148
4656-14-540	7314150387076	1	148
4656-15-340	7314150387083	1	148
4656-16-1320	7314150387137	1	148
4656-16-340	7314150387106	1	148
4656-16-540	7314150387113	1	148
4656-16-940	7314150387120	1	148
4656-18-1320	7314150387175	1	148
4656-18-340	7314150387144	1	148
4656-18-540	7314150387151	1	148
4656-18-940	7314150387168	1	148
4656-20-1320	7314150387212	1	148



4656-20-320	7314150387182	1	148
4656-20-520	7314150387199	1	148
4656-20-920	7314150387205	1	148
4656-22-1320	7314150387250	1	148
4656-22-320	7314150387229	1	148
4656-22-520	7314150387236	1	148
4656-22-920	7314150387243	1	148
4656-24-320	7314150387267	1	148
4656-24-520	7314150387274	1	148
4656-25-1320	7314150387311	1	148
4656-25-320	7314150387281	1	148
4656-25-520	7314150387298	1	148
4656-25-920	7314150387304	1	148
4656-26-520	7314150387328	1	148
4656-28-370	7314150387434	1	148
4656-28-570	7314150387458	1	148
4656-28-670	7314150387489	1	148
4656-28-920	7314150387526	1	148
4656-30-370	7314150387540	1	148
4656-30-570	7314150387571	1	148
4656-32-1320	7314150387649	1	148
4656-32-370	7314150387595	1	148
4656-32-570	7314150387618	1	148
4656-32-920	7314150387632	1	148
4656-35-370	7314150387656	1	148
4656-35-570	7314150387663	1	148
4656-35-670	7314150387670	1	148
4656-37-370	7314150387687	1	148
4656-37-570	7314150387694	1	148
4656-37-920	7314150387700	1	148
4656-38-370	7314150387717	1	148
4656-38-570	7314150387724	1	148
4656-40-1320	7314150387762	1	148
4656-40-370	7314150387731	1	148
4656-40-570	7314150387748	1	148
4656-40-920	7314150387755	1	148
4656-45-570	7314150387779	1	148
4656-45-920	7314150387786	1	148
4656-50-570	7314150387793	1	148
4656-52-570	7314150387809	1	148
4659-FLAT-28	7314150387922	1	151
4659-FLAT-40	7314150387939	1	151
4659-FLAT-60	7314150387946	1	151
4659-POINT-28	7314150387892	1	151
4659-POINT-40	7314150387908	1	151
4659-POINT-60	7314150387915	1	151
4659-TILE-30-5	7314150388042	1	151
4659-TILE-30-8	7314150388059	1	151
4659-WIDE-30-8	7314150387953	1	151
4659-WIDE-36-5	7314150387984	1	151
466-1000	7314150128327	4	553
466-1000-M	7314150186105	4	553
466-1200	7314150128334	4	553
466-1200-M	7314150186129	4	553
466-1800	7314150128341	4	553
466-2000	7314150129836	4	553
466-250	7314150128655	10	555
466-400	7314150128297	4	553
466-400-M	7314150128358	4	553
466-600	7314150128303	4	553
466-600-M	7314150128365	4	553
466-800	7314150128310	4	553
466-800-M	7314150186082	4	553
466-BE1	7314150215218	12	555
466-LINE	7314150215249	12	555
466-POST	7314150215232	6	555
4724-JT	7311518265847	1	650
4728-JT	7311518265854	1	650
474-125-0.60	7311518029050	10	563
474-125-0.80	7311518029869	10	563
474-150-0.60	7311518029876	10	563
474-150-0.80	7311518029883	10	563
4750-2PP-1	7314153014733	1	475
4750-3PB-1	7314153014719	1	475
4750-3PB-2	7314150187782	1	482
4750-BWC-1	7314153018809	1	477
4750-DHO-3	7314150289530	1	476
4750-DHO-4	7314150303908	1	482
4750-EP-1	7314153014726	1	476
4750-FOLTC-1	7314153019271	1	474
4750-HDB-2	7314150289486	1	475
4750-HDBS-2	7314150289479	1	475
4750-HDLB-1	7314153014757	1	475
4750-HDLB-TAH	7314150303892	1	483
4750-HHO-2	7314153014863	1	483
4750-JU3PB-1	7314153015747	1	475
4750-KNHO-0	7314150289462	1	476
4750-KNHO-1	7314153015839	1	476
4750-KP-1	7314153014771	1	476
4750-LV-1	7314150358052	1	473
4750-LV-2	7314150393800	1	473
4750-MPH-1	7314150291625	1	476
4750-MTHO-TAH	7314150319589	1	483
4750-PSTB-1	7314150340491	1	650
4750-QRFB-1	7314150289455	1	475
4750-ROCO-1	7314153015273	1	476



4750-SF-1	7314150326082	1	473
4750-SF-2	7314150326099	1	473
4750-TOCST-1	7314153018779	1	474
4750-UP-1	7314153014795	1	476
4750-UP-2	7314150187768	1	483
4750-VDEC	7314150222377	1	474
4750-VMPH-1	7314153014818	1	476
4750ALC01FF1	7314150508884	1	438
4750BMC10	7314150264032	1	477
4750BMC10FF1	7314150500673	1	451
4750BMC3	7314150359639	1	477
4750BMC4	7314150426256	1	477
4750BMC5	7314150264001	1	477
4750BMC5.5	7314150326167	1	477
4750BMC6	7314150264018	1	477
4750BMC7	7314150277605	1	477
4750BMC9	7314150264025	1	477
4750BMC9.5	7314150326174	1	477
4750FB1-19A	7314150277612	1	472
4750FB1-19B	7314150277629	4	472
4750FB2-19A	7314150277636	4	472
4750FB2-19TS001	7314150302772	1	454
4750FB2-24A	7314150277643	2	472
4750FB2W-24A	7314150277650	1	472
4750FB2W-TS001	7314150302765	1	454
4750FB3-12	7314150277667	1	473
4750FB4-18	7314150277674	4	473
4750FB4-18TS001	7314150302758	1	478
4750FB5-FG1	7314150401796	1	474
4750FB5-FG2	7314150401819	1	474
4750FB5A	7314150277704	1	473
4750FB5ATS001	7314150302727	1	439
4750FB5B	7314150277698	1	474
4750FB5BFF1	7314150302734	1	439
4750FB5C	7314150277681	8	474
4750FB6-13	7314150393091	1	473
4750FB6-19	7314150393114	1	473
4750FB7-01	7314150465668	60	474
4750FB7-02	7314150465675	60	474
4750FB7ORBG	7314150465682	120	475
4750FB7ORLT	7314150465699	120	475
4750FB8	7314150465651	4	472
4750PTB50	7314150275007	3	477
4750PTB60	7314150275014	3	477
4750PTB65	7314150345809	2	477
4750PTB65TS5	7314150456260	1	440
4750PTBW47	7314150275021	1	477
4750PTBW67	7314150289189	1	477
4750RC01	7314150220151	1	458
4750RC02	7314150220168	1	458
4750RC021	7314150226641	1	458
4750RCHD-AC1	7314150229857	1	459
4750RCHD00	7314150271603	1	457
4750RCHD01	7314150227426	1	457
4750RCHD011	7314150229802	1	457
4750RCHD01AC1	7314150229819	1	458
4750RCHD01AC2	7314150229826	1	458
4750RCHD01FF1	7314150247578	1	452
4750RCHDW01	7314150227433	1	457
4750RCHDW01AC1	7314150229833	1	459
4750RCHDW01AC2	7314150229840	1	459
4750RCHDW01FF1	7314150247561	1	451
4750RCHDW01FF2	7314150249183	1	451
4750RCHDW01FF3	7314150249190	1	437
4750RCHDW01FF4	7314150309580	1	453
4750RCHDW01FF9	7314150345533	1	453
4750RCHDW01RED	7314150407538	1	457
4750RCHDW02	7314150227440	1	457
4750RCHDW02FF1	7314150267422	1	453
4750RCHDW02FF15	7314150347698	1	456
4750RCHDW02FF2	7314150306787	1	456
4750RCHDW02FF4	7314150309559	1	455
4750RCHDW02RED	7314150407545	1	457
4750RCHDW02RF1V	7314150422081	1	437
4750RCHDW10	7314150425587	1	457
4750RCW01	7314150220182	1	458
4750RCW011	7314150226627	1	458
4750RCWD-AC1	7314150277179	1	458
4750RCWD-AC2	7314150277186	1	458
4750RCWD-AC3	7314150277193	1	458
4750RCWD-AC4	7314150277209	1	458
4750RCWD4	7314150277124	1	457
4750RCWD4-OR	7314150409501	1	457
4750RCWD4FF1	7314150302413	1	436
479-08	7311518025441	6	607
479-12	7311518025458	6	607
479-16	7311518025465	6	607
479-20	7314150319862	6	607
479-24	7311518025472	6	607
479-32	7311518025489	6	607
479F-08	7314150441952	6	607
479F-12	7314150441976	6	607
479F-16	7314150441983	6	607
479F-20	7314150441990	6	607
479F-24	7314150442003	6	607
479F-32	7314150442010	6	607



480-08	7311518025496	4	608
480-10	7311518025502	6	608
480-12	7311518025519	6	608
480-14	7311518025526	4	608
480-20	7314150319763	4	608
481-100	7311518005030	6	607
481-1000	7311518005092	6	607
481-1500	7311518025533	6	607
481-200	7311518005047	6	607
481-2000	7314150319855	6	607
481-300	7311518005054	6	607
481-400	7311518005061	6	607
481-500	7311518005078	6	607
481-800	7311518025540	6	607
481F-100	7314150442072	6	607
481F-1000	7314150442133	6	607
481F-1500	7314150442140	4	607
481F-200	7314150442089	4	607
481F-2000	7314150442157	4	607
481F-300	7314150442096	6	607
481F-400	7314150442102	6	607
481F-500	7314150442119	6	607
481F-800	7314150442126	6	607
482-25	7311518025557	6	607
482-28	7311518025564	6	607
482-30	7311518025571	6	607
482-35	7311518025595	6	607
482-40	7311518025601	6	607
482-45	7311518027551	6	607
482F-25	7314150442225	4	607
482F-28	7314150442232	4	607
482F-30	7314150442249	6	607
482F-35	7314150442256	4	607
482F-40	7314150442263	2	607
482F-45	7314150442270	4	607
483-16	7311518024314	6	608
483-20	7311518024321	6	608
483-22	7311518005108	6	608
483-25	7311518005115	6	608
483-28	7311518024284	6	608
483-30	7311518024291	6	608
4830	7314150100057	3	242
4831	7314150103393	3	242
4833	7314150100064	3	243
483F-16	7314150442164	6	608
483F-20	7314150442171	6	608
483F-22	7314150442188	6	608
483F-25	7314150442195	6	608
483F-28	7314150442201	6	608
483F-30	7314150442218	4	608
484-1000	7311518005122	6	608
484-1250	7311518005139	6	608
484-1500	7311518005146	6	608
484-2000	7311518024338	4	608
484F-1000	7314150442027	6	608
484F-1250	7314150442034	6	608
484F-1500	7314150442041	6	608
484F-2000	7314150442058	4	608
485	7311518005153	6	608
485W-650	7314150319770	6	608
485W-750	7314150319787	6	608
486	7311518005160	4	609
486-1800	7314150315307	5	555
486-1800WH	7314150315338	5	555
486-2000	7314150315314	5	555
486-2000WH	7314150315345	5	555
486-2400	7314150315321	5	555
486-2400WH	7314150315352	5	555
486-700	7314150338078	6	609
486F-700	7314150338085	6	609
486W-500	7314150319794	4	609
486W-600	7314150319800	4	609
488-2000	7314150337972	2	609
488-3000	7314150337989	2	609
488-4000	7314150337996	2	609
488-5000	7314150338009	2	609
488-6000	7314150338016	1	609
488F-2000	7314150338023	2	609
488F-3000	7314150338030	2	609
488F-4000	7314150338047	2	609
488F-5000	7314150338054	4	609
488F-6000	7314150338061	2	609
489-1100	7314150133055	8	611
489-1800	7314150133062	8	611
489-2700	7314150133079	4	611
489-3600	7314150133086	4	611
489-4500	7314150133093	4	611
489-5400	7314150133109	4	611
490-3.5	7311518025373	4	608
491-3000	7314150345199	4	611
491-4000	7314150345205	4	611
491-5000	7314150345212	4	611
491-6000	7314150345229	4	611
492-3.5	7311518025380	4	608
493-500	7314150338139	6	610
493-600	7314150338146	6	610



493F-500



493F-500	7314150338153	6	610
493F-600	7314150338160	1	610
494-600	7311518025397	4	610
495-500	7314150338191	6	610
495-600	7314150338207	6	610
495F-500	7314150338184	6	610
495F-600	7314150338177	1	610
496-1500	7314150315147	5	555
496-1800	7314150315154	5	555
496-SPARE	7314150329304	1	556
4M-10-11	7314151829438	10	53
4M-12-13	7314151829445	10	53
4M-14-15	7314151829476	10	53
4M-16-17	7314151829490	10	53
4M-17-19	7314151829506	10	53
4M-18-19	7314151829513	10	53
4M-20-22	7314151829520	10	53
4M-21-23	7314150205363	5	53
4M-24-26	7314150205370	1	53
4M-24-27	7314151829551	1	53
4M-25-28	7314150205387	1	53
4M-27-29	7314150205394	1	53
4M-30-32	7314151829575	1	53
4M-6-7	7314151829407	10	53
4M-8-9	7314151829414	10	53
4M/10C	7314150212972	1	53
4M/10T	7314151829605	1	53
4M/12C	7314150212989	1	53
4M/8	7314150180493	1	54
5-600-21-D-1P	7311518189341	10	35
5-610-21-D-1P	7311518189358	5	35
5-630-21-D-1P	7311518189365	1	35
5-670-21-D-1P	7311518189389	1	35
500-12	7314150390977	1	271
500-14	7314150414505	1	271
500-15	7314150390984	1	271
500-16	7314150414512	1	271
500-18	7314150414543	1	271
500-22	7314150414567	1	271
502	7311518130589	25	580
502-SET2	7311518130664	35	580
502-SET6	7311518130633	10	580
5050	7314151083359	1	362
51-12	7311518044565	10	648
51-21	7311518003906	10	648
51-24	7311518003913	10	648
51-30	7311518003920	10	648
51-32	7311518003937	10	648
51-36	7311518003944	10	648
510031	7314150216338	5	214
510033	7314150216345	5	214
510034	7314150216314	10	214
5124-JS-H	7311518219352	4	649
5128-JS-H	7311518219369	4	649
52	7311518276027	12	309
527 D-160	7314150032723	5	236
527 D-200	7314150032730	5	236
527 GC-160	7314150205653	3	236
527 GC-200	7314150205660	3	236
527V-160	7314150126811	2	509
527V-200	7314150126828	2	509
528-700	7311518188993	1	587
528-COM	7311518188986	1	587
529-16-L	7314150198139	4	606
529-16-XL	7314150198146	4	606
529-20-L	7314150198160	4	606
529-20-XL	7314150198153	4	606
529S-16-XL	7314150340330	4	606
529S-20-XL	7314150340347	4	606
541 D-150	7314150032754	5	237
541 D-200	7314150032761	5	237
541 D-250	7314150032778	5	237
5418	7314151084370	1	548
5419/6T	7314151821562	1	548
541D-180	7314150127160	5	237
541D-225	7314150127290	5	237
5463 R	7314151085063	5	546
5463-120	7314151085001	5	546
5464-105	7314151085087	5	546
54640	7314150215720	1	169
5465 AMT	7314151085148	5	544
5465 R	7314151085162	5	546
5468-112	7314151085247	5	544
5469 AMI	7314151337803	1	544
5469 B	7314151085322	5	544
5469 BI	7314151085346	5	544
5469 I	7314151085407	5	544
5469 R	7314151085421	5	544
5469-127	7314151085285	5	544
5470 I-160	7314151085520	5	546
5470-120	7314151085452	5	546
5471 F-120	7314151085681	5	544
5471 F-145	7314151085704	5	544
5471 F-200	7314151085728	5	544
5471 F-250	7314151085742	5	544
5471 F-300	7314151085766	5	544



5471 FI-120	7314151085780	5	544
5471 FI-200	7314151085827	5	544
5471 FR-120	7314151085889	5	544
5471 FR-145	7314151085902	5	544
5475 K	7314151086244	5	544
5475 R	7314151086268	5	544
5476 H	7314151086305	5	547
5479-130	7314151086398	5	544
5488 AM	7314151821166	5	545
5489 AM	7314151821173	5	545
5490 AM	7314151821180	5	545
5493-115	7314151821234	5	546
5515B	7314151086978	25	363
5515FL	7314150504077	10	362
5515GV	7314151481483	1	362
5515L	7314151481568	1	363
5515M	7314151086985	1	363
5515T	7314151589172	25	363
5515T-52	7314153021939	25	362
5516	7314151086992	5	544
5516 I	7314151087029	5	544
5517	7314151573843	5	544
5517 I	7314151573928	5	544
5518	7314151087043	5	544
5521	7314150215713	1	169
5540 AM	7314151821319	5	545
5541 AM	7314151821326	5	545
5544 AM	7314151821357	5	545
5545 AM	7314151821364	5	545
5546 AM	7314151821371	5	545
5547 AM	7314151821388	5	545
5549 AM	7314151821401	5	545
5550-3.2	7314151475673	10	548
5550-4.5	7314151475758	10	548
5551	7314151378479	1	549
5552	7314151378554	1	549
5553	7314151378639	1	549
5554	7314151378714	1	549
5568/5	7314151821210	1	546
5573-145	7314151473112	5	545
5574-145	7314151473389	5	547
5577-145	7314151574062	5	546
5578-115	7314151547769	5	545
5579-115	7314151547844	5	546
5588 AM	7314151821432	5	546
5589 AM	7314151821449	5	546
5590 AM	7314151821456	5	546
5600/4	7314151436773	1	549
5724-JS	7311518216085	1	650
5728-JS	7311518216092	1	650
5750	7311518280949	1	344
5770	7314150504466	12	344
583D	7314150023721	4	591
584D	7314150023745	4	591
585D	7314150104185	4	591
586D	7314150104208	4	591
59/S100BC	7314150337637	1	167
59/S100BC-IP	7314150337644	8	167
59/S10BC	7314150413003	1	165
59/S28-4	7314151847109	1	166
59/S31B	7314150325788	6	166
59/S31B-IP	7314150325795	12	166
59/S35BC	7314150412990	1	167
59/S36BCR	7314150413232	6	210
59/S54BC	7314150337613	10	167
59/S54BC-IP	7314150337620	8	167
59S/0.5-3.0	7314150199815	1	160
59S/0.5-3.0-3P	7314150259205	50	160
59S/0.5-4.0	7314150199822	1	160
59S/0.5-4.0-3P	7314150259212	1	160
59S/0.6-3.5	7314150199839	50	160
59S/0.6-3.5-3P	7314150259229	50	160
59S/0.6-4.5	7314150198801	1	160
59S/0.6-4.5-3P	7314150201600	1	160
59S/0.8-5.5	7314150198849	1	160
59S/0.8-5.5-3P	7314150201624	1	160
59S/1.0-5.5	7314150198863	1	160
59S/1.0-5.5-3P	7314150258963	50	160
59S/1.2-6.5	7314150198887	1	160
59S/1.2-6.5-3P	7314150258970	50	160
59S/1.2-8.0	7314150198900	1	160
59S/1.2-8.0-3P	7314150258987	1	160
59S/1.6-10	7314150199846	1	160
59S/1.6-10-3P	7314150259236	50	160
59S/1.6-9.0	7314150199853	1	160
59S/1.6-9.0-3P	7314150259243	50	160
59S/125PH1	7314150206834	1	164
59S/125PH1-2P	7314150260553	25	164
59S/125PH2	7314150204298	1	164
59S/125PH2-2P	7314150260560	25	164
59S/125PH2-IP	7314150342433	100	164
59S/125PH3	7314150204304	1	164
59S/125PH3-2P	7314150260577	25	164
59S/125PZ1	7314150200733	1	164
59S/125PZ1-2P	7314150260522	25	164
59S/125PZ2	7314150200740	1	164



59S/125PZ2-2P	7314150260539	25	164
59S/125PZ3	7314150200757	1	164
59S/125PZ3-2P	7314150260546	25	164
59S/150T15	7314150200764	1	164
59S/150T15-2P	7314150260584	1	164
59S/150T20	7314150200771	1	164
59S/150T20-2P	7314150260591	1	164
59S/150T25	7314150200788	1	164
59S/150T25-2P	7314150260607	1	164
59S/150T30	7314150200795	1	164
59S/150T30-2P	7314150260614	1	164
59S/17-1	7314150191499	1	165
59S/17-2	7314150191505	1	166
59S/17-3	7314150191512	1	166
59S/22-1	7314150204229	12	166
59S/22-2	7314150204236	12	166
59S/31-1	7314150191451	12	166
59S/31-2	7314150191468	1	167
59S/31-3	7314150191475	12	167
59S/50/0.6-3.5	7314150199976	1	162
59S/50/0.8-4.0	7314150200009	1	162
59S/50/0.8-5.5	7314150200023	1	162
59S/50/1.0-6.0	7314150200047	1	162
59S/50/1.2-6.5	7314150200061	1	162
59S/50/3.5-2P	7314150260027	50	162
59S/50/4.0-2P	7314150260041	50	162
59S/50/5.5-2P	7314150260065	50	162
59S/50/6.0-2P	7314150260089	1	162
59S/50/6.5-2P	7314150260102	50	162
59S/50H1/16	7314150248926	1	163
59S/50H1/4	7314150249015	1	163
59S/50H1/8	7314150248964	1	163
59S/50H2	7314150200160	1	163
59S/50H2-2P	7314150259298	50	163
59S/50H2.5	7314150200177	1	163
59S/50H2.5-2P	7314150259304	50	163
59S/50H3	7314150200184	1	163
59S/50H3-2P	7314150259335	50	163
59S/50H3/16	7314150248995	1	163
59S/50H3/32	7314150248940	1	163
59S/50H3/8	7314150249039	1	163
59S/50H4	7314150200191	1	163
59S/50H4-2P	7314150259359	50	163
59S/50H5	7314150200207	1	163
59S/50H5-2P	7314150259373	50	163
59S/50H5/16	7314150249022	1	163
59S/50H5/32	7314150248988	1	163
59S/50H5/64	7314150248933	1	163
59S/50H6	7314150200214	1	163
59S/50H6-2P	7314150259397	50	163
59S/50H7/32	7314150249008	1	163
59S/50H7/64	7314150248957	1	163
59S/50H8	7314150200221	1	163
59S/50H8-2P	7314150259410	50	163
59S/50H9/64	7314150248971	1	163
59S/50PH1	7314150199860	1	162
59S/50PH1-2P	7314150203642	1	162
59S/50PH2	7314150199877	1	162
59S/50PH2-2P	7314150203758	1	162
59S/50PH3	7314150199891	1	162
59S/50PH3-2P	7314150203802	1	162
59S/50PZ1	7314150199914	1	163
59S/50PZ1-2P	7314150204007	1	163
59S/50PZ2	7314150199938	1	163
59S/50PZ2-2P	7314150204014	1	163
59S/50PZ3	7314150199952	1	163
59S/50PZ3-2P	7314150204021	1	163
59S/50R1	7314150200238	1	163
59S/50R1-2P	7314150259441	50	163
59S/50R2	7314150200245	1	163
59S/50R2-2P	7314150259472	50	163
59S/50R3	7314150200252	1	163
59S/50R3-2P	7314150259502	50	163
59S/50T10	7314150200092	1	163
59S/50T10-2P	7314150201723	1	163
59S/50T15	7314150200108	1	163
59S/50T15-2P	7314150201730	1	163
59S/50T20	7314150200115	1	163
59S/50T20-2P	7314150201747	1	163
59S/50T25	7314150200122	1	163
59S/50T25-2P	7314150201754	1	163
59S/50T27	7314150200139	1	163
59S/50T30	7314150200146	1	163
59S/50T30-2P	7314150201761	1	163
59S/50T40	7314150200153	1	163
59S/50T40-2P	7314150259281	50	163
59S/50T8	7314150200085	1	163
59S/50T8-2P	7314150262809	50	163
59S/60PEN/DISP	7314150459032	1	168
59S/7-1	7314150191536	1	165
59S/7-2	7314150191543	1	165
59S/7-3	7314150191550	1	165
59S/7-4	7314150191567	1	165
59S/70PH1	7314150200269	1	163
59S/70PH1-2P	7314150259526	1	163
59S/70PH2	7314150200276	1	163



59S/70PH2-2P	7314150259557	25	163
59S/70PZ1	7314150200283	1	163
59S/70PZ1-2P	7314150259564	1	163
59S/70PZ2	7314150200290	1	163
59S/70PZ2-2P	7314150260331	1	163
59S/70PZ3	7314150200306	1	163
59S/70PZ3-2P	7314150260348	1	163
59S/70T10	7314150200313	1	163
59S/70T10-2P	7314150260355	1	163
59S/70T15	7314150200566	1	163
59S/70T15-2P	7314150260362	25	163
59S/70T20	7314150200573	1	163
59S/70T20-2P	7314150201839	1	163
59S/70T25	7314150200580	1	163
59S/70T25-2P	7314150260379	25	163
59S/70T27	7314150200597	1	163
59S/70T27-2P	7314150260386	1	163
59S/70T30	7314150200603	1	163
59S/70T30-2P	7314150260393	1	163
59S/70T40	7314150200610	1	163
59S/70T40-2P	7314150260409	1	163
59S/70TR15	7314150200627	1	164
59S/70TR15-2P	7314150260416	1	164
59S/70TR20	7314150200634	1	164
59S/70TR20-2P	7314150260423	25	164
59S/70TR25	7314150200641	1	164
59S/70TR25-2P	7314150260430	25	164
59S/70TR27	7314150200658	1	164
59S/70TR27-2P	7314150260447	25	164
59S/70TR30	7314150200665	1	164
59S/70TR30-2P	7314150260454	25	164
59S/70TR40	7314150200672	1	164
59S/70TR40-2P	7314150260461	25	164
59S/H1.5	7314150198924	1	161
59S/H1.5-3P	7314150258994	50	161
59S/H1/16	7314150204205	1	162
59S/H1/16-3P	7314150259021	50	162
59S/H1/4	7314150199266	1	162
59S/H1/4-3P	7314150259120	50	162
59S/H1/8	7314150199174	1	162
59S/H1/8-3P	7314150259069	50	162
59S/H10	7314150199075	1	161
59S/H10-3P	7311518333638	25	161
59S/H2	7314150198955	1	161
59S/H2-3P	7314150259007	50	161
59S/H2.5	7314150198962	1	161
59S/H2.5-3P	7314150259014	50	161
59S/H3	7314150198986	1	161
59S/H3-3P	7314150201662	1	161
59S/H3/16	7314150199228	1	162
59S/H3/16-3P	7314150259090	1	162
59S/H3/32	7314150199136	1	162
59S/H3/32-3P	7314150259045	50	162
59S/H3/8	7314150204212	1	162
59S/H3/8-3P	7314150259144	25	162
59S/H3BALL	7314150200689	1	164
59S/H3BALL-2P	7314150260478	1	161
59S/H4	7314150198993	1	161
59S/H4-3P	7314150201679	1	161
59S/H4-IPB	7314150225767	500	161
59S/H4BALL	7314150200696	1	164
59S/H4BALL-2P	7314150260485	1	164
59S/H5	7314150199013	1	161
59S/H5-3P	7314150201686	1	161
59S/H5/16	7314150199273	1	162
59S/H5/16-3P	7314150259137	50	162
59S/H5/32	7314150199204	1	162
59S/H5/32-3P	7314150259083	50	162
59S/H5/64	7314150199112	1	162
59S/H5/64-3P	7314150259038	50	162
59S/H5BALL	7314150200702	1	164
59S/H5BALL-2P	7314150260492	1	164
59S/H6	7314150199037	1	161
59S/H6-3P	7314150201693	1	161
59S/H6BALL	7314150200719	1	164
59S/H6BALL-2P	7314150260508	1	164
59S/H7/32	7314150199242	1	162
59S/H7/32-3P	7314150259113	50	162
59S/H7/64	7314150199150	1	162
59S/H7/64-3P	7314150259052	50	162
59S/H8	7314150199051	1	161
59S/H8-3P	7314150201709	1	161
59S/H8BALL	7314150200726	1	164
59S/H8BALL-2P	7314150260515	1	164
59S/H9/64	7314150199198	1	162
59S/H9/64-3P	7314150259076	1	162
59S/HBALL-3P	7314150201716	1	164
59S/M3	7314150199730	1	162
59S/M3-3P	7314150259151	50	162
59S/M4	7314150199754	1	162
59S/M4-3P	7314150259168	50	162
59S/M5	7314150199778	1	162
59S/M5-3P	7314150259175	50	162
59S/M6	7314150199792	1	162
59S/M6-3P	7314150259182	50	162
59S/M8	7314150199808	1	162



59S/M8-3P



59S/M8-3P	7314150259199	50	162
59S/PH0	7314150198177	1	160
59S/PH0-3P	7314150258819	50	160
59S/PH1	7314150198313	1	160
59S/PH1-30P	7314150200801	1	160
59S/PH1-3P	7314150201396	1	160
59S/PH1-IP	7314150206780	100	160
59S/PH1-IPB	7314150225743	500	160
59S/PH1COMBI-2P	7314150215669	1	164
59S/PH2	7314150198320	1	160
59S/PH2-30P	7314150200818	1	160
59S/PH2-3P	7314150201402	1	160
59S/PH2-IP	7314150206797	100	160
59S/PH2-IPB	7314150204038	500	160
59S/PH2COMBI-2P	7314150203604	1	164
59S/PH2G	7314150204182	1	160
59S/PH2G-30P	7314150200832	1	160
59S/PH2G-3P	7314150259250	50	160
59S/PH2PEN	7314150458950	10	168
59S/PH3	7314150198351	1	160
59S/PH3-30P	7314150200825	1	160
59S/PH3-3P	7314150201419	1	160
59S/PH3-IPB	7314150225750	500	160
59S/PH3COMBI-2P	7314150203611	1	164
59S/PH4	7314150198368	1	160
59S/PH4-3P	7314150258826	25	160
59S/PZ0	7314150198375	1	161
59S/PZ0-3P	7314150258833	50	161
59S/PZ1	7314150198382	1	161
59S/PZ1-30P	7314150200849	1	161
59S/PZ1-3P	7314150201426	1	161
59S/PZ1-IP	7314150206803	100	161
59S/PZ1-IPB	7314150204373	500	161
59S/PZ2	7314150198405	1	161
59S/PZ2-30P	7314150200856	1	161
59S/PZ2-3P	7314150201433	1	161
59S/PZ2-IP	7314150206810	100	161
59S/PZ2-IPB	7314150204380	500	161
59S/PZ2PEN	7314150458974	10	168
59S/PZ3	7314150198429	1	161
59S/PZ3-30P	7314150200863	1	161
59S/PZ3-3P	7314150201440	1	161
59S/PZ3-IPB	7314150225736	500	161
59S/PZ4	7314150198436	1	161
59S/R1	7314150199310	1	162
59S/R1-3P	7314150201631	1	162
59S/R2	7314150199341	1	162
59S/R2-3P	7314150201648	1	162
59S/R3	7314150199365	1	162
59S/R3-3P	7314150201655	1	162
59S/R4	7314150232109	1	162
59S/T10	7314150198528	1	161
59S/T10-30P	7314150200870	1	161
59S/T10-3P	7314150201457	1	161
59S/T10CS	7314150444014	20	161
59S/T15	7314150198535	1	161
59S/T15-30P	7314150200887	1	161
59S/T15-3P	7314150201464	1	161
59S/T15CS	7314150444021	20	161
59S/T15PEN	7314150458929	10	168
59S/T20	7314150198542	1	161
59S/T20-30P	7314150200894	1	161
59S/T20-3P	7314150201471	1	161
59S/T20CS	7314150444038	20	161
59S/T20PEN	7314150458936	10	168
59S/T25	7314150198566	1	161
59S/T25-30P	7314150200900	1	161
59S/T25-3P	7314150201488	1	161
59S/T25CS	7314150444045	20	161
59S/T25PEN	7314150458943	10	168
59S/T27	7314150198580	1	161
59S/T27-3P	7314150201495	1	161
59S/T27CS	7314150444052	20	161
59S/T3	7314150198443	1	161
59S/T3-3P	7314150258840	50	161
59S/T30	7314150198597	1	161
59S/T30-30P	7314150200924	1	161
59S/T30-3P	7314150201501	1	161
59S/T30CS	7314150444069	20	161
59S/T4	7314150198450	1	161
59S/T4-3P	7314150258857	50	161
59S/T40	7314150198610	1	161
59S/T40-30P	7314150200931	1	161
59S/T40-3P	7314150201518	1	161
59S/T40CS	7314150444076	20	161
59S/T45	7314150198641	1	161
59S/T45-3P	7314150258918	50	161
59S/T5	7314150198467	1	161
59S/T5-3P	7314150258864	50	161
59S/T50	7314150198658	1	161
59S/T50-3P	7314150258925	50	161
59S/T6	7314150198474	1	161
59S/T6-3P	7314150258871	50	161
59S/T7	7314150198498	1	161
59S/T7-3P	7314150258888	50	161
59S/T8	7314150198504	1	161



59S/T8-3P	7314150258895	50	161
59S/T9	7314150198511	1	161
59S/T9-3P	7314150258901	50	161
59S/TCS11-1	7314150444083	10	165
59S/TR10	7314150198702	1	161
59S/TR10-3P	7314150201525	1	161
59S/TR15	7314150198719	1	161
59S/TR15-3P	7314150201532	1	161
59S/TR20	7314150198726	1	161
59S/TR20-3P	7314150201549	1	161
59S/TR25	7314150198740	1	161
59S/TR25-3P	7314150201556	1	161
59S/TR27	7314150198757	1	161
59S/TR27-3P	7314150201570	1	161
59S/TR30	7314150198771	1	161
59S/TR30-3P	7314150201587	1	161
59S/TR40	7314150198795	1	161
59S/TR40-3P	7314150201594	1	161
59S/TR7	7314150198672	1	161
59S/TR7-3P	7314150258932	50	161
59S/TR8	7314150198689	1	161
59S/TR8-3P	7314150258949	50	161
59S/TR9	7314150198696	1	161
59S/TR9-3P	7314150258956	50	161
59S/TS-0	7314150199389	1	162
59S/TS-1	7314150199396	1	162
59S/TS-1/4	7314150199594	1	162
59S/TS-10	7314150199570	1	162
59S/TS-2	7314150199419	1	162
59S/TS-3	7314150199433	1	162
59S/TS-4	7314150199457	1	162
59S/TS-5	7314150199518	1	162
59S/TS-6	7314150199532	1	162
59S/TS-8	7314150199556	1	162
59S/TW0	7314150199617	1	162
59S/TW1	7314150199631	1	162
59S/TW2	7314150199655	1	162
59S/TW3	7314150199679	1	162
59S/TW4	7314150199693	1	162
59S/TW5	7314150199716	1	162
6	8412814220048	1	217
6-342-06-2-0	7311518021719	10	30
6-342-06-2-2	7311518244170	5	30
6-342-08-1-0	7311518021726	10	30
6-342-08-1-2	7311518028282	5	30
6-342-08-2-0	7311518021733	10	30
6-342-08-2-2	7311518005375	5	30
6-342-10-1-0	7311518021757	10	30
6-342-10-1-2	7311518005382	5	30
6-342-10-2-0	7311518021764	10	30
6-342-10-2-2	7311518005399	5	30
6-343-08-2-0	7311518021801	10	30
6-343-08-2-2	7311518001070	5	30
6-343-08-3-0	7311518021818	10	30
6-343-10-2-0	7311518021825	10	30
6-343-10-2-2	7311518001094	5	30
6-343-10-3-0	7311518021832	10	30
6-344-08-2-0	7311518021887	10	30
6-344-08-2-2	7311518005344	5	30
6-344-10-2-0	7311518021900	10	30
6-344-10-2-2	7311518005351	5	30
6-345-08-1-2	7311518028312	5	31
6-345-08-2-0	7311518021948	10	31
6-345-08-2-2	7311518005412	5	31
6-345-10-1-2	7311518005429	5	31
6-345-10-2-0	7311518021955	10	31
6-470-08-2-2	7311518242008	5	31
600-3	7314150124787	1	208
600.003.010	8412814600000	1	374
600.005.012	8412814600017	1	374
601000800	8413345202299	1	603
601001000	8413345202305	1	603
601001250	8413345202312	1	603
601001500	8413345202329	1	603
6010H0800	8413345015769	1	604
6010H1000	8413345015776	1	604
6010H1250	8413345015783	1	604
6010H1500	8413345015790	1	604
6010M0800	8413345015806	1	603
6010M1000	8413345116619	1	603
6010M1250	8413345015820	1	603
6010M1500	8413345015837	1	603
602-4-LA	7314150224357	1	208
604-5	7314150124800	1	208
6040M0630	8413345124126	1	604
605-10-PC-AU	7314150186334	1	210
605-6	7314150153770	1	209
606-6	7314150124824	1	209
6070H1000	8413345030656	1	603
6070H1250	8413345084833	1	603
6070H1500	8413345030663	1	603
6070H1750	8413345030670	1	603
607201000	8413345030533	1	603
607201250	8413345030540	1	603
607201500	8413345030557	1	603
607201750	8413345030564	1	603

Part Number	Part Number	Quantity	Part Number
6072M1000	8413345015813	1	603
6072M1500	8413345137454	1	603
6072M1750	8413345030687	1	603
60T/17-1	7314150191529	1	158
60T/31-1	7314150191482	12	158
60T/7-1	7314150191574	1	158
60T/PH1	7314150199488	1	158
60T/PH2	7314150199495	1	158
60T/PH3	7314150199501	1	158
60T/PZ1	7314150199525	1	158
60T/PZ2	7314150199549	1	158
60T/PZ3	7314150199563	1	158
60T/T15	7314150199662	1	158
60T/T20	7314150199686	1	158
60T/T25	7314150199709	1	158
60T/T27	7314150199723	1	158
60T/T40	7314150199761	1	158
60T/T7	7314150199587	1	158
60T/T9	7314150199624	1	158
610-6	7314150124848	1	209
611-10-200	7314150124428	10	207
611-3.5-100	7314150124336	10	207
611-3.5-75	7314150124329	10	207
611-4-100	7314150124350	10	207
611-4-75	7314150124343	10	207
611-5.5-100	7314150124367	10	207
611-5.5-125	7314150124381	10	207
611-6.5-125	7314150124374	10	207
611-6.5-150	7314150124398	10	207
611-6.5-25	7314150124602	10	207
611-8-150	7314150124404	10	207
611-8-175	7314150124411	10	207
612-5	7314150124817	1	209
613-3-100	7314150124442	10	207
613-3-75	7314150124435	10	207
613-3.5-100	7314150124459	10	207
613-4-100	7314150124466	10	207
613-4-125	7314150124473	10	207
613-5.5-150	7314150124497	10	207
613-6.5-150	7314150124503	10	207
615-0-75	7314150124558	10	208
615-1-100	7314150124565	10	208
615-2-125	7314150124572	10	208
615-2-25	7314150124596	10	208
615-3-150	7314150124589	10	208
616-0-75	7314150124510	10	208
616-1-100	7314150124527	10	208
616-2-125	7314150124534	10	208
616-3-150	7314150124541	10	208
618-10-75	7314150124619	10	208
618-15-100	7314150124626	10	208
618-20-100	7314150124633	10	208
618-25-125	7314150124640	10	208
618-27-125	7314150124657	10	208
618-30-150	7314150124664	10	208
618-40-150	7314150124671	10	208
61H/50PH1	7314150200382	1	159
61H/50PZ1	7314150200412	1	159
61H/50PZ2	7314150200429	1	159
61H/50PZ3	7314150200436	1	159
61H/50T10	7314150200443	1	159
61H/50T15	7314150200450	1	159
61H/50T25	7314150200474	1	159
61H/50T30	7314150200481	1	159
61H/PH1	7314150199006	1	158
61H/PH2	7314150199020	1	158
61H/PH3	7314150199044	1	158
61H/PZ3	7314150199105	1	159
61H/T10	7314150199129	1	159
61H/T20	7314150199167	1	159
61H/T25	7314150199181	1	159
61H/T40	7314150199235	1	159
620-6	7314150128594	1	507
622-3P	7314150427727	1	248
6221D	7314150421596	10	248
6221D IP	7314150440368	10	248
6222D	7314150421589	10	248
6222D IP	7314150437702	10	248
6223D	7314150421558	8	248
6223D IP	7314150421794	8	248
6224	7314150421619	4	247
6224D	7314150421565	5	248
6224D IP	7314150421800	5	248
6225D	7314150421572	10	248
6225D IP	7314150421817	5	248
623-3-100	7314150128518	10	507
623-3.5-100	7314150128525	10	507
623-4-100	7314150128532	10	507
623-5.5-125	7314150128549	10	507
623-6.5-150	7314150128556	10	507
625	7311518221614	5	562
625-0-100	7314150128563	10	507
625-1-150	7314150128570	10	507
625-2-175	7314150128587	10	507
625-DROP	7311518221638	10	562
625-PEAR	7311518221621	10	562

Part Number	Part Number	Quantity	Part Number
625-ROUND	7311518221645	10	562
62TIN/50PH1	7314150200504	1	157
62TIN/50PH3	7314150200528	1	157
62TIN/50PZ1	7314150200535	1	157
62TIN/50PZ2	7314150200542	1	157
62TIN/50PZ3	7314150200559	1	157
62TIN/7-1	7314150203505	1	157
62TIN/PH1	7314150199259	1	157
62TIN/PZ1	7314150199327	1	157
62TIN/PZ2	7314150199334	1	157
62TIN/PZ3	7314150199358	1	157
62TIN/T15	7314150199402	1	157
62TIN/T20	7314150199426	1	157
62TIN/T25	7314150199440	1	157
62TIN/T30	7314150199464	1	157
63D/50PZ1	7314150200320	1	157
63D/50PZ2	7314150200337	1	157
63D/50PZ3	7314150200344	1	157
63D/7-1	7314150191604	1	157
63D/PH2G	7314150198979	1	156
63D/PH3	7314150198948	1	156
63D/PZ2	7314150198870	1	156
63D/T10	7314150198665	1	156
63D/T15	7314150198733	1	156
63D/T40	7314150198832	1	156
64A/PH1	7314150198481	1	157
64A/PH3	7314150198573	1	157
64A/PZ1	7314150198603	1	158
64A/PZ3	7314150198634	1	158
650	7311518221591	5	562
65I/7-1	7314150204113	1	541
65I/PH1	7314150199785	1	541
65I/PH2	7314150199884	1	541
65I/PH3	7314150199907	1	541
65I/PZ1	7314150199921	1	541
65I/PZ2	7314150199945	1	541
65I/PZ3	7314150199969	1	541
65I/T15	7314150199990	1	541
65I/T40	7314150200078	1	541
665	7311518221607	5	562
66IM/10C-1	7314150450732	40	160
66IM/11C-1	7314150450718	40	160
66IM/50PH1-2P	7314150446056	1	159
66IM/50PH2-2P	7314150446063	1	159
66IM/50PH3-2P	7314150446087	1	159
66IM/50PZ1-2P	7314150446094	1	160
66IM/50PZ2-2P	7314150446108	1	160
66IM/50PZ3-2P	7314150446117	1	160
66IM/50T10C-2P	7314150446131	1	160
66IM/50T15C-2P	7314150446148	1	160
66IM/50T20C-2P	7314150446155	1	160
66IM/50T25C-2P	7314150446162	1	160
66IM/50T27C-2P	7314150446179	1	160
66IM/50T30C-2P	7314150446186	1	160
66IM/50T40C-2P	7314150446193	1	160
66IM/PH1-2P	7314150445929	1	159
66IM/PH2-2P	7314150445936	1	159
66IM/PH3-2P	7314150445943	1	159
66IM/PZ1-2P	7314150445950	1	159
66IM/PZ2-2P	7314150445967	1	159
66IM/PZ3-2P	7314150445974	1	159
66IM/T10C-2P	7314150445981	1	159
66IM/T15C-2P	7314150445998	1	159
66IM/T20C-2P	7314150446001	1	159
66IM/T25C-2P	7314150446018	1	159
66IM/T27C-2P	7314150446025	1	159
66IM/T30C-2P	7314150446032	1	159
66IM/T40C-2P	7314150446049	1	159
6700SM-10	7314151088026	5	79
6700SM-11	7314151088033	5	79
6700SM-12	7314151088040	5	79
6700SM-13	7314151088057	5	79
6700SM-14	7314151088064	5	79
6700SM-4	7314151087944	5	79
6700SM-4.5	7314151087951	5	79
6700SM-5	7314151087968	5	79
6700SM-5.5	7314151087975	5	79
6700SM-6	7314151087982	5	79
6700SM-7	7314151087999	5	79
6700SM-8	7314151088002	5	79
6700SM-9	7314151088019	5	79
6700SZ-1/2	7314151088194	5	80
6700SZ-1/4	7314151088132	5	80
6700SZ-1/8	7314150346349	5	80
6700SZ-11/32	7314151088163	5	80
6700SZ-3/16	7314151088118	5	80
6700SZ-3/8	7314151088170	5	80
6700SZ-5/16	7314151088156	5	80
6700SZ-5/32	7314151808556	5	80
6700SZ-7/16	7314151088187	5	80
6700SZ-7/32	7314151088125	5	80
6700SZ-9/16	7314151088200	5	80
6700SZ-9/32	7314151088149	5	80
6700TORX-E10	7314153011725	5	80
6700TORX-E4	7314153011671	5	80
6700TORX-E5	7314153011688	5	80



6700TORX-E6



6700TORX-E6	7314153011695	5	80
6700TORX-E7	7314153011701	5	80
6700TORX-E8	7314153011718	5	80
6706TE	7314150220199	1	69
6708DMB	7314150220205	1	68
6709-IP10	7314150354498	1	84
6709-IP15	7314150354504	1	84
6709-IP20	7314150354511	1	84
6709-IP25	7314150354528	1	84
6709-IP27	7314150354535	1	84
6709-IP30	7314150354542	1	84
6709-IP40	7314150354559	1	84
6709-IP45	7314150354566	1	84
6709-IP6	7314150460373	1	84
6709-IP7	7314150460366	1	84
6709-IP8	7314150460359	1	84
6709-IP9	7314150460342	1	84
6709F-4.5	7314151830762	5	84
6709F-5.5	7314151830779	5	84
6709F-6.5	7314150220397	5	84
6709F-8	7314151830786	5	84
6709HL	7314150128457	1	83
6709M-10	7314150430833	5	85
6709M-3	7314151830656	5	85
6709M-4	7314151830663	5	85
6709M-5	7314151830670	5	85
6709M-6	7314151830687	5	85
6709M-8	7314151830694	5	85
6709PH-1	7314151830700	5	84
6709PH-2	7314151830717	5	84
6709PH-3	7314151830724	5	84
6709PZ-1	7314151830731	5	84
6709PZ-2	7314151830748	5	84
6709PZ-3	7314151830755	5	84
6709TORX-R-T10	7314153002471	1	84
6709TORX-R-T15	7314153002488	1	84
6709TORX-R-T20	7314153002495	1	84
6709TORX-R-T25	7314153002501	1	84
6709TORX-R-T8	7314153002464	1	84
6709TORX-T10	7314151811679	5	84
6709TORX-T15	7314151811686	5	84
6709TORX-T20	7314151811693	5	84
6709TORX-T25	7314151811709	5	84
6709TORX-T27	7314151811716	5	84
6709TORX-T30	7314151811723	5	84
6709TORX-T40	7314153002457	5	84
6709TORX-T6	7314150460540	5	84
6709TORX-T7	7314150460557	5	84
6709TORX-T8	7314153002440	5	84
6709TORX-T9	7314151811662	5	84
671002600	8413345128971	50	567
671002850	8413345128988	1	567
6711MB	7314150220298	1	69
6712R	7314151838225	1	65
6712RN	7314151838232	1	65
6713MH	7314150220212	1	68
6715GE	7314151831370	1	67
6715GJ	7314151831363	1	67
6715MG	7314151831349	1	66
6715MGS	7314151831332	1	65
6715MZ	7314153003218	1	68
6715PZ	7314151837525	1	67
6717MBP	7314150218806	1	66
6719MHR	7314150218783	1	65
6719SM	7314151820817	1	66
6720NM	7314151088262	1	67
6721NM	7314151088309	1	66
6722M	7314151594411	1	67
6729MHP	7314150218752	1	66
6729MHR	7314150218769	1	65
6729SM	7314153003225	1	68
6729SZ	7314153003232	1	68
6730MBP	7314150218776	1	66
677-10	7314150362486	1	50
677-13	7314150362493	1	50
677-3/8	7314150362509	1	50
677-7	7314150362455	1	50
677-8	7314150362462	1	50
677-9	7314150362479	1	50
679-1/2	7314150363384	1	54
679-10	7314150357345	1	54
679-11	7314150357352	1	54
679-12	7314150357369	1	54
679-13	7314150357376	1	54
679-14	7314150357383	1	54
679-3/8	7314150363360	1	54
679-7	7314150357536	1	54
679-7/16	7314150363377	1	54
679-8	7314150357079	1	54
679-9	7314150357338	1	54
679-9/16	7314150363391	1	54
6821NZ	7314151089269	1	68
6852-5	7314150125463	1	113
6852-5/S17	7314150135875	1	113
6852P-5	7314150416585	1	114
6876N	7314151845575	1	114



6878N	7314151845582	1	114
6880N	7314151845599	1	114
690000160	8413345008068	1	624
690000200	8413345008082	1	624
690000220	8413345008099	1	624
690000250	8413345008105	1	624
690000300	8413345008129	1	624
690000320	8413345087476	1	624
690000350	8413345008136	1	624
690000400	8413345008143	1	624
690000500	8413345008167	1	624
690000630	8413345111065	1	624
69079019P	8413345111089	1	624
690900080	8413345016209	4	624
690900100	8413345016216	4	624
690900120	8413345016223	2	624
690900140	8413345016230	2	624
690900200	8413345016247	1	624
6950	7314151089641	1	85
6950-SPARE	7314150187867	1	86
6950RN	7314151831189	1	85
6950RN-SPARE	7314150209149	1	86
6950SL	7314150197668	1	85
6950SL-SPARE	7314150210251	1	86
6951	7314151089764	1	86
6954	7314151089795	1	82
6956	7314151089825	10	82
6958-6	7314150476329	1	82
6960	7314151089856	1	82
6960W-2	7314150470860	10	82
6960W-4	7314150470877	1	82
6960W-6	7314150470884	10	82
6961	7314151089870	1	82
6962	7314151089894	1	82
6962L	7314151089917	1	82
6963	7314151089931	1	82
6966	7314151089986	10	82
6968	7314150128426	1	83
6969	7314150489268	1	83
696EX-01	7314150386192	1	82
696EX-06	7314150386239	1	82
696EX-08	7314150386246	1	82
696EX-11	7314150386208	1	82
6972H	7314151215934	5	83
6973A	7314150339495	10	83
6973M	7314150339501	1	83
6973N	7314151845605	1	113
6976N	7314151845612	1	113
6978N	7314151845629	1	113
6M-10-11	7314151832094	10	48
6M-10-13	7314151832117	10	48
6M-12-13	7314151832131	10	48
6M-12-14	7314151832148	10	48
6M-13-14	7314151832155	10	48
6M-13-15	7314151832162	10	48
6M-13-16	7314151832179	10	48
6M-13-17	7314151832186	10	48
6M-14-15	7314151832193	10	48
6M-14-17	7314151832209	10	48
6M-16-17	7314151832216	10	48
6M-16-18	7314151832223	10	48
6M-17-19	7314151832230	10	48
6M-18-19	7314151832247	10	48
6M-19-22	7314151832261	10	48
6M-19-24	7314151832278	10	48
6M-20-22	7314151832285	10	48
6M-21-23	7314151832292	10	48
6M-21-24	7314151838072	10	48
6M-22-24	7314151832308	10	48
6M-24-26	7314151832315	10	48
6M-24-27	7314151832322	10	48
6M-24-30	7314151832339	5	48
6M-25-28	7314151832353	5	48
6M-27-29	7314150189861	5	48
6M-27-30	7314151832360	5	48
6M-27-32	7314151832377	5	48
6M-30-32	7314151832384	5	48
6M-30-36	7314151832407	5	48
6M-32-36	7314151832414	5	48
6M-34-36	7314151832421	1	48
6M-36-41	7314151832438	1	48
6M-38-42	7314151832445	1	48
6M-4-5	7314151832018	10	48
6M-4.5-5.5	7314151832025	10	48
6M-4-1-46	7314151832452	1	48
6M-46-50	7314151832469	1	48
6M-5-5.5	7314151832032	10	48
6M-5.5-7	7314151832049	10	48
6M-6-7	7314151832056	10	48
6M-7-8	7314151832063	10	48
6M-8-10	7314151832087	10	48
6M-8-9	7314151832070	10	48
6M/10C	7314150212934	1	50
6M/12C	7314150212941	1	50
6M/6C	7314150212910	1	50
6M/8C	7314150212927	1	50

6M/S8	7314151832483	1	49
6M/SH12	7314153013439	1	49
6M/SH8	7314150201365	1	49
6MV-10	7314150120871	5	511
6MV-11	7314150120888	5	511
6MV-12	7314150120895	5	511
6MV-13	7314150120901	5	511
6MV-14	7314150120918	5	511
6MV-15	7314150120925	5	511
6MV-16	7314150120932	5	511
6MV-17	7314150120949	3	511
6MV-18	7314150120956	3	511
6MV-19	7314150120963	3	511
6MV-20	7314150120970	3	511
6MV-21	7314150120987	3	511
6MV-22	7314150120994	3	511
6MV-23	7314150121007	3	511
6MV-24	7314150121014	3	511
6MV-27	7314150121021	2	511
6MV-30	7314150121038	2	511
6MV-32	7314150121052	2	511
6MV-6	7314150120833	5	511
6MV-7	7314150120840	5	511
6MV-8	7314150120857	5	511
6MV-9	7314150120864	5	511
6MV/10T	7314150213023	1	514
6MV/8T	7314150122141	1	514
6Z-1-1.1/8	7314151832674	1	48
6Z-1.1/16-1.1/4	7314151832681	1	48
6Z-1.1/4-1.3/8	7314151832698	1	48
6Z-1/2-9/16	7314151832568	5	48
6Z-1/4-5/16	7314151832520	5	48
6Z-11/16-3/4	7314151832612	5	48
6Z-13/16-7/8	7314151832643	5	48
6Z-15/16-1	7314151832667	5	48
6Z-19/32-11/16	7314151832582	5	48
6Z-25/32-13/16	7314151832636	5	48
6Z-3/4-7/8	7314151832629	5	48
6Z-3/8-7/16	7314151832544	5	48
6Z-5/16-11/32	7314151832537	5	48
6Z-5/8-3/4	7314151832605	5	48
6Z-7/16-1/2	7314151832551	5	48
6Z-7/8-15/16	7314151832650	5	48
6Z-9/16-5/8	7314151832575	5	48
6Z/8C	7314150212958	1	50
700-1-50	7314153017673	5	212
700-1.2-50	7314153017680	5	212
700-1.5-50	7314153017697	5	212
700-1.8-50	7314153017703	5	212
700-2-50	7314153017710	5	212
700-2.5-50	7314153017741	5	212
700-3-100	7314153017772	5	212
700-3-200	7314153017789	5	212
700-3-50	7314153017765	5	212
700-3.5-75	7314153017796	5	212
700-4-250	7314153017819	5	212
700-4-75	7314153017802	5	212
701-0-200	7314153017857	5	212
701-0-50	7314153017840	5	212
701-00-50	7314153017833	5	212
701-1-250	7314153017871	5	212
701-1-75	7314153017864	5	212
702-0-50	7314153017888	5	212
702-1-75	7314153017895	5	212
703-10-50	7314153017963	5	212
703-15-75	7314153017970	5	212
703-20-75	7314153017987	5	212
703-4-50	7314153017901	5	212
703-5-50	7314153017918	5	212
703-6-50	7314153017925	5	212
703-7-50	7314153017932	5	212
703-8-50	7314153017949	5	212
703-9-50	7314153017956	5	212
704-1.5-50	7314153017994	5	212
704-2-50	7314153018007	5	212
704-2.5-50	7314153018014	5	212
704-3-75	7314153018021	5	212
704Z-3/32	7314150137428	5	212
706-1	7314153018045	1	212
706-2	7314153018052	1	213
706-3	7314153018069	1	213
706-4	7314153018076	1	213
706-5	7314153018083	1	213
70S/1.2-8.0	7314150218387	1	168
70S/1.2-8.0-2P	7314150262823	25	168
70S/1.6-10.0	7314150218394	1	168
70S/1.6-10.0-2P	7314150261017	25	168
70S/1.6-9.0	7314150218400	1	168
70S/1.6-9.0-2P	7314150261024	25	168
70S/2.0-12.0	7314150218417	1	168
70S/2.0-12.0-2P	7314150261086	25	168
70S/2.5-14.0	7314150218424	1	168
70S/2.5-14.0-2P	7314150261147	25	168
70S/H10	7314150218486	1	169
70S/H10-2P	7314150261451	25	169
70S/H12	7314150218493	1	169

70S/H12-2P	7314150261468	25	169
70S/H14	7314150218509	1	169
70S/H14-2P	7314150261475	25	169
70S/H4	7314150218431	1	169
70S/H4-2P	7314150261352	25	169
70S/H5	7314150218448	1	169
70S/H5-2P	7314150261406	25	169
70S/H6	7314150218455	1	169
70S/H6-2P	7314150261437	25	169
70S/H7	7314150218462	1	169
70S/H7-2P	7314150261444	25	169
70S/H8	7314150218479	1	169
70S/H8-2P	7314150262847	25	169
70S/PH1	7314150217557	1	168
70S/PH1-2P	7314150260621	25	168
70S/PH2	7314150217564	1	168
70S/PH2-2P	7314150260638	25	168
70S/PH3	7314150217571	1	168
70S/PH3-2P	7314150260645	25	168
70S/PH4	7314150217588	1	168
70S/PH4-2P	7314150260652	25	168
70S/PZ1	7314150217595	1	169
70S/PZ1-2P	7314150260683	25	169
70S/PZ2	7314150217601	1	169
70S/PZ2-2P	7314150260706	25	169
70S/PZ3	7314150217724	1	169
70S/PZ3-2P	7314150260720	25	169
70S/PZ4	7314150217731	1	169
70S/PZ4-2P	7314150260737	25	169
70S/T20	7314150217748	1	169
70S/T20-2P	7314150260744	25	169
70S/T25	7314150217755	1	169
70S/T25-2P	7314150260812	25	169
70S/T27	7314150217762	1	169
70S/T27-2P	7314150260867	1	169
70S/T30	7314150217779	1	169
70S/T30-2P	7314150260881	25	169
70S/T40	7314150217786	1	169
70S/T40-2P	7314150260898	25	169
70S/T45	7314150217793	1	169
70S/T45-2P	7314150260904	25	169
70S/T50	7314150217809	1	169
70S/T50-2P	7314150260911	25	169
70S/T55	7314150217816	1	169
70S/T55-2P	7314150260928	25	169
70S/TS1/4	7314150218349	1	169
70S/TS1/4-2P	7314150260935	25	169
70S/TS10	7314150218356	1	169
70S/TS10-2P	7314150260942	25	169
70S/TS5/16	7314150218363	1	169
70S/TS5/16-2P	7314150260959	25	169
70S/TS8	7314150218370	1	169
70S/TS8-2P	7314150260966	25	169
7106J	7314150339518	1	89
7223	7314150237722	4	247
7223D	7314150421527	8	247
7223D IP	7314150440306	8	247
7223IP	7314150421855	8	247
7224	7311518274733	4	247
7224-622XD-3P	7314150426973	1	248
7224D	7314150421534	4	247
7224D IP	7314150440313	4	247
7224IP	7314150421831	4	247
7224S	7314150421657	4	511
7225	7314150237739	8	247
7225D	7314150421541	4	247
7225D IP	7314150440320	4	247
7225IP	7314150421848	4	247
7372I-2-63	7314151398668	10	218
7372I-2.5-75	7314151399047	10	218
7372I-3-80	7314151341602	10	218
7400SM-10	7314151092955	5	86
7400SM-11	7314151092962	5	86
7400SM-12	7314151092979	5	86
7400SM-13	7314151092986	5	86
7400SM-14	7314151092993	5	86
7400SM-15	7314151093006	5	86
7400SM-16	7314151831127	5	86
7400SM-17	7314151093020	5	86
7400SM-18	7314151831134	5	86
7400SM-19	7314151093044	5	86
7400SM-20	7314153002570	5	86
7400SM-21	7314153002587	5	86
7400SM-22	7314153002594	5	86
7400SM-6	7314151092917	5	86
7400SM-7	7314151092924	5	86
7400SM-8	7314151092931	5	86
7400SM-9	7314151092948	5	86
7400SR/S12	7314153003294	1	72
7400SZ-1/2	7314150385942	1	87
7400SZ-1/4	7314150385959	1	87
7400SZ-11/16	7314150385966	1	87
7400SZ-11/32	7314150385973	1	87
7400SZ-13/16	7314150385980	1	87
7400SZ-3/4	7314150385997	1	87
7400SZ-3/8	7314150386000	1	87



7400SZ-5/16



7400SZ-5/16	7314150386017	1	87
7400SZ-5/8	7314150386024	1	87
7400SZ-7/16	7314150386031	1	87
7400SZ-7/8	7314150386048	1	87
7400SZ-9/16	7314150386055	1	87
7400TORX-E10	7314153003058	5	88
7400TORX-E11	7314153003065	5	88
7400TORX-E12	7314153003072	5	88
7400TORX-E14	7314153003089	5	88
7400TORX-E16	7314153003096	5	88
7400TORX-E18	7314153003102	5	88
7400TORX-E8	7314150118243	5	88
7400TORX-ER/S7	7314153003300	1	72
7402GPR-16	7314150503087	120	308
7402GPR-18	7314150503094	120	308
7402GPR-21	7314150503100	100	308
7406ZZ-16	7314153011992	1	307
7406ZZ-21	7314153012005	1	307
7407H	7314151218249	1	174
7408H	7314151218300	1	174
7408MD	7314150220328	1	72
7409BH-10	7314153002112	5	91
7409BH-4	7314153002075	5	91
7409BH-5	7314153002082	1	91
7409BH-6	7314153002099	5	91
7409BH-8	7314153002105	5	91
7409F-10	7314153002143	5	90
7409F-6.5	7314153002129	5	90
7409F-8	7314153002136	5	90
7409H	7314151218355	1	174
7409M-10	7314153001962	5	91
7409M-3	7314153002235	5	91
7409M-4	7314153001900	5	91
7409M-5	7314153001917	5	91
7409M-6	7314153001924	5	91
7409M-7	7314153001931	5	91
7409M-8	7314153001948	5	91
7409MB	7314150220236	1	72
7409MR/S7	7314153003256	1	92
7409PH-1	7314153002150	5	91
7409PH-2	7314153002167	5	91
7409PH-3	7314153002174	5	91
7409TORX-R-T27	7314153001856	5	91
7409TORX-R-T30	7314153001863	5	91
7409TORX-R-T40	7314153001870	5	91
7409TORX-R-T45	7314153001887	5	91
7409TORX-R-T50	7314153001894	5	91
7409TORX-T20	7314150220403	5	91
7409TORX-T25	7314153001771	5	91
7409TORX-T25-L	7314153011237	5	91
7409TORX-T27	7314153001788	5	91
7409TORX-T30	7314153001795	5	91
7409TORX-T30-L	7314153011244	5	91
7409TORX-T40	7314153001801	5	91
7409TORX-T40-L	7314153011251	5	91
7409TORX-T45	7314153001818	5	91
7409TORX-T45-L	7314153011268	5	91
7409TORX-T50	7314153001825	5	91
7409TORX-T50-L	7314153011275	5	91
7409TORX-TRR/S5	7314153003263	1	91
7409Z-1/4	7314150386062	1	92
7409Z-1/8	7314150386079	1	92
7409Z-3/16	7314150386086	1	92
7409Z-3/8	7314150386093	1	92
7409Z-5/32	7314150386109	1	92
7409Z-7/32	7314150386116	1	92
7420RE	7314153014962	1	70
7422MBR	7314150218844	1	71
7422MHR	7314150218868	1	71
7429JDE	7314153003348	1	72
7430GE	7314153014979	1	70
7440ME	7314153014986	1	70
7444SG-M-100	7314151830014	1	55
7444SG-M-105	7314151830021	1	55
7444SG-M-110	7314151830038	1	55
7444SG-M-115	7314151830045	1	55
7444SG-M-120	7314151830052	1	55
7444SG-M-125	7314151830069	1	55
7444SG-M-130	7314151830076	1	55
7444SG-M-135	7314151830083	1	55
7444SG-M-140	7314151830090	1	55
7444SG-M-145	7314151830106	1	55
7444SG-M-150	7314151830113	1	55
7444SG-M-155	7314151830120	1	55
7444SG-M-160	7314150132508	1	55
7444SG-M-165	7314150132515	1	55
7444SG-M-170	7314150132522	1	55
7444SG-M-175	7314150132539	1	55
7444SG-M-24	7314150205400	1	55
7444SG-M-27	7314151829834	1	55
7444SG-M-30	7314151829841	1	55
7444SG-M-32	7314151829858	1	55
7444SG-M-34	7314151838560	1	55
7444SG-M-36	7314151829865	1	55
7444SG-M-38	7314150180936	1	55
7444SG-M-41	7314151829872	1	55



7444SG-M-42	7314151829889	1	55
7444SG-M-46	7314151829896	1	55
7444SG-M-50	7314151829919	1	55
7444SG-M-55	7314151829926	1	55
7444SG-M-60	7314151829933	1	55
7444SG-M-65	7314151829940	1	55
7444SG-M-70	7314151829957	1	55
7444SG-M-75	7314151829964	1	55
7444SG-M-80	7314151829971	1	55
7444SG-M-85	7314151829988	1	55
7444SG-M-90	7314151829995	1	55
7444SG-M-95	7314151830007	1	55
7444SG-Z-1.1/16	7314150132546	1	55
7444SG-Z-1.1/2	7314150132614	1	55
7444SG-Z-1.1/4	7314150132577	1	55
7444SG-Z-1.1/8	7314150132553	1	55
7444SG-Z-1.11/16	7314150132638	1	55
7444SG-Z-1.13/16	7314150132652	1	55
7444SG-Z-1.3/16	7314150132560	1	55
7444SG-Z-1.3/4	7314150132645	1	55
7444SG-Z-1.3/8	7314150132591	1	55
7444SG-Z-1.5/16	7314150132584	1	55
7444SG-Z-1.5/8	7314150132621	1	55
7444SG-Z-1.7/16	7314150132607	1	55
7444SG-Z-1.7/8	7314150132669	1	55
7444SG-Z-2	7314150132676	1	55
7444SG-Z-2.1/16	7314150132683	1	55
7444SG-Z-2.1/4	7314150132713	1	55
7444SG-Z-2.1/8	7314150132690	1	55
7444SG-Z-2.3/16	7314150132706	1	55
7444SG-Z-2.3/4	7314150132768	1	55
7444SG-Z-2.3/8	7314150132720	1	55
7444SG-Z-2.5/8	7314150132751	1	55
7444SG-Z-2.9/16	7314150132744	1	55
7444SG-Z-3	7314150132775	1	55
7444SG-Z-3.1/2	7314150132805	1	55
7444SG-Z-3.1/8	7314150132782	1	55
7444SG-Z-3.3/4	7314150132812	1	55
7444SG-Z-3.3/8	7314150132799	1	55
7444SG-Z-3.7/8	7314150132829	1	55
7444SG-Z-4	7314150132836	1	55
7444SG-Z-4.1/2	7314150132850	1	55
7444SG-Z-4.1/8	7314150132843	1	55
7454-1400	7314150119592	1	111
7454-1400E	7314150119615	1	111
7454-140A	7314150509515	1	110
7454-17	7314150509492	1	110
7454-230	7314150509522	1	110
7454-3.5	7314150509478	1	110
7454-32	7314150509508	1	110
7454-480	7314150119578	1	111
7454-480A	7314150509539	1	110
7454-70A	7314150509577	1	110
7454-8.4	7314150509485	1	110
7454-800	7314150119585	1	111
7454-800A	7314150509584	1	110
7454-800E	7314150119608	1	111
7455-100	7314150125111	1	108
7455-1000	7314150368303	1	108
7455-100A	7314150340156	1	108
7455-15	7314150119646	1	108
7455-1500	7314150125166	1	109
7455-20	7314150125074	1	108
7455-200	7314150125128	1	108
7455-25	7314150125081	1	108
7455-2500	7314150125173	1	109
7455-300	7314150125104	1	108
7455-340	7314150125135	1	108
7455-5	7314150119639	1	108
7455-500	7314150125142	1	108
7455-60	7314150125098	1	108
7455-800	7314150125159	1	108
7456-80LB	7314150119783	1	109
7465-100	7314150340200	1	109
7465-15	7314150340170	1	109
7465-1500	7314150340248	1	109
7465-200	7314150340217	1	109
7465-30	7314150340187	1	109
7465-340	7314150340224	1	109
7465-5	7314150340163	1	109
7465-60	7314150340194	1	109
7465-800	7314150340231	1	109
747-1	7314150362899	1	51
747-1.1/16	7314150362905	1	51
747-1.1/2	7314150362974	1	51
747-1.1/4	7314150362936	1	51
747-1.1/8	7314150362912	1	51
747-1.11/16	7314150363001	1	51
747-1.13/16	7314150363025	1	51
747-1.15/16	7314150363049	1	51
747-1.3/16	7314150362929	1	51
747-1.3/4	7314150363018	1	51
747-1.3/8	7314150362950	1	51
747-1.5/16	7314150362943	1	51
747-1.5/8	7314150362998	1	51
747-1.7/16	7314150362967	1	51

Part Number	Quantity	Part Number	Quantity
747-1.7/8	1	7314150363032	51
747-1.9/16	1	7314150362981	51
747-1/2	1	7314150362813	51
747-10	1	7314150362516	51
747-11	1	7314150362523	51
747-11/16	1	7314150362844	51
747-12	1	7314150362530	51
747-13	1	7314150362547	51
747-13/16	1	7314150362868	51
747-14	1	7314150362554	51
747-15	1	7314150362561	51
747-15/16	1	7314150362882	51
747-16	1	7314150362578	51
747-17	1	7314150362585	51
747-18	1	7314150362592	51
747-19	1	7314150362608	51
747-2	1	7314150363056	51
747-2.1/16	1	7314150363063	51
747-2.1/2	1	7314150363131	51
747-2.1/4	1	7314150363094	51
747-2.1/8	1	7314150363070	51
747-2.3/16	1	7314150364893	51
747-2.3/4	1	7314150363162	51
747-2.3/8	1	7314150363117	51
747-2.5/16	1	7314150363100	51
747-2.5/8	1	7314150363155	51
747-2.7/16	1	7314150363124	51
747-2.7/8	1	7314150363179	51
747-2.9/16	1	7314150363148	51
747-20	1	7314150362615	51
747-21	1	7314150362622	51
747-22	1	7314150362639	51
747-23	1	7314150362646	51
747-24	1	7314150362653	51
747-25	1	7314150362660	51
747-26	1	7314150362677	51
747-27	1	7314150362684	51
747-28	1	7314150362691	51
747-3/4	1	7314150362851	51
747-3/8	1	7314150362790	51
747-30	1	7314150362707	51
747-32	1	7314150362714	51
747-34	1	7314150362721	51
747-36	1	7314150362738	51
747-40	1	7314150362745	51
747-41	1	7314150362752	51
747-42	1	7314150362769	51
747-46	1	7314150362776	51
747-5/8	1	7314150362837	51
747-50	1	7314150362783	51
747-7/16	1	7314150362806	51
747-7/8	1	7314150362875	51
747-9/16	1	7314150362820	51
749-1	54	7314150363506	54
749-1.1/16	54	7314150363513	54
749-1.1/2	54	7314150363582	54
749-1.1/4	54	7314150363544	54
749-1.1/8	54	7314150363520	54
749-1.11/16	54	7314150363612	54
749-1.13/16	54	7314150363636	54
749-1.15/16	54	7314150363650	54
749-1.3/16	54	7314150363537	54
749-1.3/4	54	7314150363629	54
749-1.3/8	54	7314150363568	54
749-1.5/16	54	7314150363551	54
749-1.5/8	54	7314150363605	54
749-1.7/16	54	7314150363575	54
749-1.7/8	54	7314150363643	54
749-1.9/16	54	7314150363599	54
749-1/2	54	7314150363421	54
749-11/16	54	7314150363452	54
749-13/16	54	7314150363476	54
749-15	54	7314150357543	54
749-15/16	54	7314150363490	54
749-16	54	7314150357550	54
749-17	54	7314150357567	54
749-18	54	7314150357574	54
749-19	54	7314150357581	54
749-2	54	7314150363667	54
749-2.1/4	54	7314150363698	54
749-2.1/8	54	7314150363674	54
749-2.3/16	54	7314150363681	54
749-2.3/4	54	7314150363728	54
749-2.3/8	54	7314150363704	54
749-2.5/8	54	7314150363711	54
749-20	54	7314150357598	54
749-21	54	7314150357604	54
749-22	54	7314150357611	54
749-23	54	7314150357628	54
749-24	54	7314150357635	54
749-25	54	7314150357642	54
749-26	54	7314150357659	54
749-27	54	7314150357666	54
749-3.1/8	54	7314150363735	54
749-3/4	54	7314150363469	54
749-3/8	54	7314150363407	54

Part Number	Quantity	Part Number	Quantity
749-5/8	1	7314150363445	54
749-7/16	1	7314150363414	54
749-7/8	1	7314150363483	54
749-9/16	1	7314150363438	54
74P14-200	1	7314150416318	112
74P14-300	1	7314150416325	112
74P14-400	1	7314150416332	112
74P9-100	1	7314150416301	112
74P9-20	1	7314150416288	112
74P9-60	1	7314150416295	112
74PR-100	1	7314150416189	111
74PR-100A	1	7314150416196	111
74PR-20	1	7314150416158	111
74PR-200	1	7314150416202	111
74PR-300	1	7314150416219	111
74PR-400	1	7314150416226	111
74PR-60	1	7314150416165	111
74PR-60A	1	7314150416172	111
74PS-100	1	7314150416257	112
74PS-20	1	7314150416233	112
74PS-200	1	7314150416264	112
74PS-300	1	7314150416271	112
74PS-60	1	7314150416240	112
74S/H10	1	7314150218622	164
74S/H10-2P	25	7314150261635	164
74S/H12	1	7314150218639	164
74S/H12-2P	25	7314150261659	164
74S/H14	1	7314150218646	164
74S/H14-2P	1	7314150261666	164
74S/H17	1	7314150218653	164
74S/H17-2P	25	7314150261673	164
74S/H4	1	7314150218578	164
74S/H4-2P	25	7314150261543	164
74S/H5	1	7314150218585	164
74S/H5-2P	25	7314150261550	164
74S/H6	1	7314150218592	164
74S/H6-2P	25	7314150261567	164
74S/H7	1	7314150218608	164
74S/H7-2P	25	7314150261574	164
74S/H8	1	7314150218615	164
74S/H8-2P	25	7314150261611	164
74W14-200	1	7314150415700	108
74W14-300	1	7314150415717	108
74W14-400	1	7314150415724	108
74W9-100	1	7314150415687	108
74W9-15	1	7314150415656	108
74W9-200	1	7314150415694	108
74W9-25	1	7314150415663	108
74W9-50	1	7314150415670	108
74WR-100	1	7314150415540	108
74WR-100B	1	7314150469871	108
74WR-15	1	7314150415519	108
74WR-200	1	7314150415557	108
74WR-25	1	7314150415526	108
74WR-300	1	7314150415564	108
74WR-340	1	7314150415571	108
74WR-400	1	7314150415588	108
74WR-50	1	7314150415533	108
74WS-100	1	7314150415625	108
74WS-15	1	7314150415595	108
74WS-200	1	7314150415632	108
74WS-25	1	7314150415601	108
74WS-300	1	7314150415649	108
74WS-50	1	7314150415618	108
75EXT	113	7314150415311	113
75P1-1500	1	7314150415298	112
75P3-1000	1	7314150415281	112
75P3-650	1	7314150415267	112
75P3-800	1	7314150415274	112
75PS-650	1	7314150415328	112
75R1-1500	1	7314150415236	109
75R3-1000	1	7314150415229	109
75R3-650	1	7314150415205	109
75R3-800	1	7314150415212	109
75S-650	1	7314150415243	110
76R1-2000	1	7314150522378	110
76R3-1000	1	7314150422128	110
76R3-1500	1	7314150422135	110
76R3-600	1	7314150423118	110
76R3-800	1	7314150422111	110
76S-600	1	7314150423125	110
7710	1	7314151551445	90
7750	1	7314151096427	90
7750-SPARE	1	7314150187874	92
7750RN	1	7314151831240	90
7750RN-SPARE	1	7314150209361	92
7750SL	1	7314150197675	90
7750SL-SPARE	1	7314150210268	92
7751	10	7314150386949	92
7752	1	7314151096533	88
7754	1	7314151096557	88
7755-SO/1	1	7314153010728	91
7756	6	7314150489152	88
7759	1	7314151096601	89
7760	1	7314151096618	88
7760W-3	10	7314150470907	88





7760W-6	7314150470914	10	88
7761	7314151096632	1	88
7762	7314151096649	1	88
7764	7314151096670	1	89
7765	7314151096687	1	83
7766	7314151096694	1	89
7767	7314153003577	1	83
7768	7314150128433	1	89
776EX-01	7314150386130	1	89
776EX-03	7314150386154	1	89
776EX-04	7314150386161	1	89
776EX-06	7314150386178	1	89
776EX-08	7314150386185	1	89
776EX-11	7314150386147	1	89
7772H	7314150476336	10	95
7800DM-10	7314151096991	10	93
7800DM-11	7314151097011	10	93
7800DM-12	7314151097035	10	93
7800DM-13	7314151097059	10	93
7800DM-14	7314151097073	10	93
7800DM-15	7314151097097	10	93
7800DM-16	7314151097110	10	93
7800DM-17	7314151097134	10	93
7800DM-18	7314151097158	10	93
7800DM-19	7314151097172	10	93
7800DM-20	7314151097196	10	93
7800DM-21	7314151097219	10	93
7800DM-22	7314151097233	10	93
7800DM-23	7314151097257	10	93
7800DM-24	7314151097271	10	93
7800DM-25	7314151097295	10	93
7800DM-26	7314151097318	10	93
7800DM-27	7314151097332	10	93
7800DM-28	7314151097356	10	93
7800DM-29	7314151097363	10	93
7800DM-30	7314151097370	10	93
7800DM-31	7314150464548	10	93
7800DM-32	7314151097387	10	93
7800DM-33	7314150169351	10	93
7800DM-34	7314150169405	10	93
7800DM-36	7314151097400	10	93
7800DM-8	7314151830854	10	93
7800DM-9	7314151830861	10	93
7800DMV-10	7314150121656	10	512
7800DMV-11	7314150121663	10	512
7800DMV-12	7314150121670	10	512
7800DMV-13	7314150121687	10	512
7800DMV-14	7314150121694	10	512
7800DMV-15	7314150121700	10	512
7800DMV-16	7314150121717	10	512
7800DMV-17	7314150121724	10	512
7800DMV-18	7314150121731	10	512
7800DMV-19	7314150121748	10	512
7800DMV-20	7314150121755	10	512
7800DMV-21	7314150121762	10	512
7800DMV-22	7314150121779	10	512
7800DMV-24	7314150121786	5	512
7800DMV-27	7314150121793	5	512
7800DMV-30	7314150121809	5	512
7800DMV-32	7314150121816	5	512
7800DMV-8	7314150121649	10	512
7800DZ-1	7314151097561	10	94
7800DZ-1.1/16	7314151097578	10	94
7800DZ-1.1/2	7314150464562	10	94
7800DZ-1.1/4	7314151097608	10	94
7800DZ-1.1/8	7314151097585	10	94
7800DZ-1.3/16	7314151097592	10	94
7800DZ-1.3/8	7314150464586	10	94
7800DZ-1.5/16	7314150166077	10	94
7800DZ-1.7/16	7314150464609	1	94
7800DZ-1/2	7314151097455	10	94
7800DZ-11/16	7314151097493	10	94
7800DZ-11/32	7314150465712	10	94
7800DZ-13/16	7314151097523	10	94
7800DZ-13/32	7314150464623	10	94
7800DZ-15/16	7314151097554	10	94
7800DZ-19/32	7314151097479	10	94
7800DZ-25/32	7314151097516	10	94
7800DZ-3/4	7314151097509	10	94
7800DZ-3/8	7314151097431	10	94
7800DZ-5/16	7314150464647	10	94
7800DZ-5/8	7314151097486	10	94
7800DZ-7/16	7314151097448	10	94
7800DZ-7/8	7314151097530	10	94
7800DZ-9/16	7314151097462	10	94
7800SM-10	7314151097851	10	92
7800SM-11	7314151097868	10	92
7800SM-12	7314151097875	10	92
7800SM-13	7314151097882	10	92
7800SM-14	7314151097899	10	92
7800SM-15	7314151097905	10	93
7800SM-16	7314151097912	10	93
7800SM-17	7314151097929	10	93
7800SM-18	7314151097936	10	93
7800SM-19	7314151097943	10	93
7800SM-20	7314150166206	10	93



7800SM-21	7314151097967	10	93
7800SM-22	7314151097974	10	93
7800SM-23	7314151097981	10	93
7800SM-24	7314151097998	10	93
7800SM-25	7314151098001	10	93
7800SM-26	7314151830823	10	93
7800SM-27	7314151098025	10	93
7800SM-28	7314151830830	10	93
7800SM-29	7314150166213	10	93
7800SM-30	7314151098056	10	93
7800SM-32	7314151098063	10	93
7800SM-33	7314150167319	10	93
7800SM-34	7314153011305	10	93
7800SM-36	7314151098087	10	93
7800SM-8	7314151830793	10	92
7800SM-9	7314151830809	10	92
7800TORX-E10	7314150166084	1	94
7800TORX-E11	7314150220359	1	94
7800TORX-E12	7314153011800	1	94
7800TORX-E14	7314153011756	1	94
7800TORX-E16	7314153011763	1	94
7800TORX-E18	7314153011770	1	94
7800TORX-E20	7314153011787	1	94
7800TORX-E24	7314153011794	1	94
7800TORX-E8	7314150166091	1	94
7800TORX/9	7314150469741	1	97
7805DM-10	7314151822101	10	94
7805DM-12	7314151098452	10	94
7805DM-13	7314151098469	10	94
7805DM-14	7314151098476	10	94
7805DM-15	7314151098483	10	94
7805DM-16	7314151098490	10	94
7805DM-17	7314151098506	10	94
7805DM-18	7314151098513	10	94
7805DM-19	7314151098520	10	94
7805DM-21	7314151098544	10	94
7805DM-22	7314151098551	10	94
7805DM-23	7314150313532	10	94
7805DM-24	7314151098568	10	94
7805DM-26	7314151098582	10	94
7805DM-27	7314151098599	10	94
7805DM-30	7314151098605	10	94
7805DM-32	7314150220281	10	94
7805DM-34	7314150488537	10	94
7805DZ-1	7314150357758	10	94
7805DZ-1.1/16	7314150357765	10	94
7805DZ-1.1/2	7314150357833	10	94
7805DZ-1.1/4	7314150357796	10	94
7805DZ-1.1/8	7314150357772	10	94
7805DZ-1.3/16	7314150357789	10	94
7805DZ-1.3/8	7314150357819	10	94
7805DZ-1.5/16	7314150357802	10	94
7805DZ-1.7/16	7314150357826	10	94
7805DZ-11/16	7314150357703	10	94
7805DZ-13/16	7314150357727	10	94
7805DZ-15/16	7314150357741	10	94
7805DZ-3/4	7314150357710	10	94
7805DZ-5/8	7314150357697	10	94
7805DZ-7/8	7314150357734	10	94
7805GPR-16	7314150503117	120	307
7805GPR-21	7314150503124	100	307
7805SM-10	7314153011312	10	93
7805SM-11	7314150475926	10	93
7805SM-12	7314153011329	10	93
7805SM-13	7314153011336	10	93
7805SM-14	7314153011343	10	93
7805SM-15	7314153011350	10	93
7805SM-16	7314153011367	10	93
7805SM-17	7314153011374	10	93
7805SM-18	7314153011381	10	93
7805SM-19	7314153011398	10	93
7805SM-20	7314153011404	10	93
7805SM-21	7314153011411	10	93
7805SM-22	7314153011428	10	93
7805SM-23	7314153011435	10	93
7805SM-24	7314153011442	10	93
7805SM-25	7314153011459	10	93
7805SM-26	7314153011466	10	93
7805SM-27	7314153011473	10	93
7805SM-28	7314153011480	10	93
7805SM-29	7314153011497	10	93
7805SM-30	7314153011503	10	93
7805SM-32	7314153011527	10	93
7805SM-34	7314153024251	10	93
7805SZ-1.1/2	7314150357987	1	93
7805SZ-1.1/4	7314150357949	1	93
7805SZ-1.3/16	7314150357932	1	93
7805SZ-1.3/8	7314150357963	1	93
7805SZ-1.5/16	7314150357956	1	93
7805SZ-1.7/16	7314150357970	1	93
7806MD	7314150220335	1	77
7807	7314153012029	1	306
7807H	7314151232764	1	177
7807TE	7314150313792	1	78
7808H	7314151232771	1	177
7808HM	7314150220434	1	98



7809F-10	7314151830892	5	97
7809F-8	7314151830885	5	97
7809H	7314151232788	1	177
7809HL	7314150128464	1	96
7809M-10	7314151815608	1	97
7809M-10-140	7314151831011	1	98
7809M-12	7314151815615	1	97
7809M-14	7314151815622	1	97
7809M-17	7314151831028	1	97
7809M-19	7314151831035	1	97
7809M-4	7314150214600	10	97
7809M-5	7314151815561	1	97
7809M-5-100	7314150313761	1	98
7809M-5-180	7314151830922	1	98
7809M-6	7314151815578	1	97
7809M-6-100	7314150313778	1	98
7809M-6-140	7314151830946	1	98
7809M-7	7314151815585	1	97
7809M-7-100	7314151830960	1	98
7809M-8	7314151815592	1	97
7809M-8-120	7314151830984	1	98
7809M-9	7314151830991	1	97
7809M/10	7314151831448	1	73
7809PH-2	7314151830908	1	97
7809PH-3	7314151830915	1	97
7809PH-4	7314153003423	1	97
7809PZ-2	7314153003430	1	97
7809PZ-3	7314153003447	1	97
7809TO	7314150220465	1	97
7809TORX-T20	7314151811730	1	97
7809TORX-T25	7314151811747	1	97
7809TORX-T27	7314151811754	1	97
7809TORX-T30	7314151811761	1	97
7809TORX-T40	7314151811778	1	97
7809TORX-T40-120	7314150220564	5	97
7809TORX-T45	7314151811785	1	97
7809TORX-T45-120	7314150220557	1	97
7809TORX-T50	7314151811792	1	97
7809TORX-T50-100	7314150220540	1	97
7809TORX-T55	7314151811808	1	97
7809TORX-T55-140	7314150220533	5	97
7809TORX-T60	7314151811815	1	97
7809TORX-T70-140	7314150220526	5	97
7809TORX/10	7314151831455	1	74
7809XZN-10	7314151831080	1	98
7809XZN-10-100	7314151831097	1	98
7809XZN-12	7314151831103	1	98
7809XZN-12-100	7314151831110	1	98
7809XZN-14	7314153004574	1	98
7809XZN-14-100	7314153004567	1	98
7809XZN-16	7314150220458	1	98
7809XZN-18	7314150314058	1	98
7809XZN-6	7314150214617	1	98
7809XZN-8	7314151831066	1	98
7809XZN-8-100	7314151831073	1	98
7809Z-1/2	7314153003515	1	98
7809Z-1/4	7314153003478	1	98
7809Z-17/32	7314150313785	1	98
7809Z-19/32	7314153003546	1	98
7809Z-3/16	7314153003461	1	98
7809Z-3/8	7314153003492	1	98
7809Z-5/16	7314153003485	1	98
7809Z-5/8	7314153003553	1	98
7809Z-7/16	7314153003508	1	98
7809Z-9/16	7314153003539	1	98
7809Z/10	7314153003560	1	74
7810MB	7314150220380	1	77
7810MH	7314150220373	1	77
7811DMV	7314150122134	1	514
7812	7314150502028	100	319
7814DS	7314150318964	1	74
7814DST	7314150319022	1	76
7817DZS	7314150319008	1	76
7817DZS1	7314150389902	1	76
7818DS	7314150318971	1	74
7818DST	7314150319039	1	76
7818MHR	7314150218912	1	74
7818SST	7314150319046	1	76
7819DRN	7314151831547	1	75
7819SRE	7314151837921	1	74
782-J	7311518276447	1	309
7823	7314150218141	16	170
7823DET	7314150319084	1	77
7823DZS	7314150319015	1	76
7823SE	7314150318988	1	75
7825DST	7314150319060	1	77
7825MBP	7314150218929	1	75
7825MHP	7314150218943	1	74
7825SST	7314150319053	1	77
7827DST	7314150319077	1	77
783	7311518276034	1	327
7835 G-160	7314150050253	5	245
7847SS	7314150318995	1	75
7851-G	7314150124909	1	117
7851-M	7314150124893	1	117
7865	7311518276720	1	170



787-1.1/16	7314150363186	1	51
787-1.1/2	7314150363254	1	51
787-1.1/4	7314150363216	1	51
787-1.1/8	7314150363193	1	51
787-1.11/16	7314150363278	1	51
787-1.13/16	7314150363292	1	51
787-1.3/16	7314150363209	1	51
787-1.3/4	7314150363285	1	51
787-1.3/8	7314150363230	1	51
787-1.5/16	7314150363223	1	51
787-1.5/8	7314150363261	1	51
787-1.7/16	7314150363247	1	51
787-1.7/8	7314150363308	1	51
787-2	7314150363315	1	51
787-2.1/4	7314150363346	1	51
787-2.1/8	7314150363322	1	51
787-2.3/16	7314150363339	1	51
787-2.3/8	7314150363353	1	51
7888DM	7314151820923	1	75
789-1.1/2	7314150363896	1	54
789-1.1/4	7314150363858	1	54
789-1.1/8	7314150363841	1	54
789-1.13/16	7314150363933	1	54
789-1.3/4	7314150363926	1	54
789-1.3/8	7314150363872	1	54
789-1.5/16	7314150363865	1	54
789-1.5/8	7314150363919	1	54
789-1.7/16	7314150363889	1	54
789-1.9/16	7314150363902	1	54
789-2	7314150363940	1	54
789-2.1/4	7314150363957	1	54
789-2.3/8	7314150363971	1	54
789-2.5/16	7314150363964	1	54
789-28	7314150363742	1	54
789-30	7314150363759	1	54
789-32	7314150357673	1	54
789-34	7314150363766	1	54
789-36	7314150363773	1	54
789-38	7314150363780	1	54
789-40	7314150363797	1	54
789-41	7314150363803	1	54
789-42	7314150363810	1	54
789-46	7314150363827	1	54
789-50	7314150363834	1	54
790450A	7314150214716	1	264
790455A	7314150214709	1	264
7993M0170	8413345115353	1	182
7993M0190	8413345115377	1	182
7993M0220	8413345115391	1	182
7993M0270	8413345115414	1	182
7993S0050	8413345115070	1	177
7993S0060	8413345115094	1	177
7993S0080	8413345115117	1	177
7993S0100	8413345115131	1	177
7993S0120	8413345115155	1	177
7993S0140	8413345115179	1	177
7993S0170	8413345115193	1	177
7993S0180	7314150476855	1	177
7993S0190	8413345115216	1	177
7993T0120	8413345115230	1	180
7993T0140	8413345115254	1	180
7993T0170	8413345115278	1	180
7993T0190	8413345115292	1	180
7993T0220	8413345115315	1	180
7993T0240	8413345115339	1	180
7994S0200	7314150492954	1	177
7994S0250	7314150492947	1	177
7994S0270	7314150492930	1	177
7994S0300	8413345129305	1	177
7994S0400	8413345129312	1	177
7994S0450	8413345129329	1	177
7994S0500	8413345129336	1	177
7994S0550	8413345129343	1	177
7994S0600	8413345129350	1	177
8010SL-2P	7314150243853	1	508
8020-2P	7314150246601	1	195
8030-2P	7314150246618	1	195
8040-2P	7314150246625	1	195
8040L-2P	7314150246670	1	196
8040SL-2P	7314150243877	1	508
8045LVDE	7314151509163	10	218
8045VDE	7314151317256	10	218
8050SL-2P	7314150243884	1	508
8052	7314151318406	5	217
806-1-1	7311518003760	6	218
806-1-2	7314150183258	6	218
806-1-3	7314150183265	6	218
8060B0080	8413345018104	1	267
8060B0100	8413345018111	1	267
8060B0120	8413345018128	1	267
8060B0140	8413345018135	1	267
8060B0180	8413345018142	1	267
8060B0240	8413345018159	1	267
8060B0360	8413345018166	1	267
8060T0080	8413345018173	1	267
8060T0100	8413345018180	1	267



8060T0140



8060T0140	8413345018203	1	267
8060T0180	8413345018210	1	267
8060T0240	8413345018227	1	267
8060T0360	8413345018234	1	267
8069	7314150007028	5	39
8069 C	7314150007035	5	39
8069 C IP	7314150101634	5	39
8069 IP	7314150007042	50	39
8069-1	7314150239511	1	39
8069-2	7314150238590	1	39
8070	7314150007110	5	39
8070 C	7314150007127	5	39
8070 C IP	7314150101641	5	39
8070 IP	7314150007134	40	39
8070-1	7314150239528	1	39
8070-2	7314150238606	1	39
8070V	7314150121519	2	511
8070VL	7314150213511	1	511
8071	7314150007202	5	39
8071 C	7314150007219	5	39
8071 C IP	7314150101658	5	39
8071 IP	7314150007226	50	39
8071-1	7314150239535	1	39
8071-2	7314150238613	1	39
8071V	7314150121526	2	511
8071VL	7314150213535	1	511
8071VLT	7314150121564	1	511
8072	7314150007288	5	39
8072 C	7314150007295	5	39
8072 C IP	7314150101665	5	39
8072 IP	7314150007301	30	39
8072-1	7314150239542	1	39
8072-2	7314150238620	1	39
8072V	7314150121533	2	511
8072VL	7314150213542	1	511
8072VLT	7314150121571	1	511
8073	7314150007363	5	39
8073 C	7314150007370	5	39
8073 C IP	7314150101672	5	39
8073 IP	7314150007387	20	39
8073-1	7314150239559	1	39
8073-2	7314150238637	1	39
8073V	7314150121540	2	511
8073VL	7314150213559	1	511
8073VLT	7314150121588	1	511
8074	7314150007448	3	39
8074 C	7314150007455	3	39
8074 C IP	7314150101689	3	39
8074 IP	7314150007462	20	39
8074-1	7314150239566	1	39
8074-2	7314150238644	1	39
8074V	7314150121557	2	511
8075	7314150007523	3	39
8075 C	7314150007530	3	39
8075 C IP	7314150101696	3	39
8075 IP	7314150007547	10	39
8075-1	7314150239573	1	39
8075-2	7314150238651	1	39
808050	7314153017642	50	210
808050A	7314150127306	1	216
808050L	7314150128075	25	210
808050L-SP1	7314150129218	1	210
808050P	7314150128105	50	210
808050P-25	7314150165179	10	211
808050S	7314150128082	25	211
808050S-18	7314150128921	30	211
808050S-22	7314150128938	30	211
808050TORX	7314150127313	50	216
808050TS	7314150128099	1	211
808060	7314150243822	1	508
808061	7314150243839	5	508
808062	7314150243846	5	508
8100B0140	7314150263028	1	267
8100B0240	8413345018296	1	267
8100B0360	8413345099660	1	267
8100F0180	7314150263059	1	267
8100F0240	7314150263066	1	267
8100F0360	8413345135849	1	267
8100T0100	7314150263073	1	267
8100T0140	8413345018333	1	267
8100T0180	7314150263080	1	267
8100T0240	7314150263097	1	267
8100T0360	7314150263103	1	267
8110H-1/2	7314153015860	1	99
8120-1/2	7314150384884	12	99
8120-1/4	7314150384921	20	86
8120-3/8	7314150384914	10	90
8150-1/2	7314151105006	1	98
8150-1/2-SPARE	7314150187881	1	100
8150-1/2V	7314150121601	1	512
8150RN-1/2	7314151831202	1	98
8150RN-1/2-SPARE	7314150209378	1	100
8150SL	7314150197682	1	98
8150SL-SPARE	7314150210275	1	100
8151-1/2	7314151105112	1	99
8152-1/2	7314151105129	1	94



8154-1/2V	7314150121595	1	512
8154-11	7314150469161	10	95
8155-1/2	7314151827595	1	98
8155-SO/1	7314153000811	1	99
8156-1/2	7314150166053	1	94
8157-10	7314150467273	1	94
8157-15	7314150469222	1	94
8157-24	7314150469246	1	94
8157-36	7314150469260	1	94
8158-10	7314150471003	1	95
8158-15	7314150471010	1	95
8160-1/2V	7314150121618	1	513
8160-10	7314150469185	10	95
8160-3	7314150469208	10	95
8160-5	7314150469284	10	95
8160-B	7314150182565	1	95
8160W-10	7314150471027	10	95
8160W-3	7314150471041	10	95
8160W-5	7314150471065	10	95
8162-1/2V	7314150121625	1	513
8164-1/2	7314151105266	1	89
8166	7314150459377	10	95
8167	7314153003584	1	89
8167-1/2	7314150181094	1	95
8168	7314150128440	1	95
8171	7314150469307	10	96
8172	7314150469321	10	96
8174A	7314150476374	10	96
8194-1/2	7314151831226	1	99
8195-KEY	7314150389810	50	96
8195-R	7314150389780	1	99
8195-SET	7314150389797	5	99
8195-SQ	7314150389803	25	99
8220SL-2P	7314150243860	1	508
8223	7314150112685	4	247
8223 IP	7314150113149	4	247
8224	7314150000012	4	247
8224 IP	7314150101757	4	247
8224CIP	7314150103607	4	247
8225	7314150000029	4	247
8225 IP	7314150101764	4	247
8225CIP	7314150103614	4	247
8226	7314150115853	1	247
8231	7311518266509	4	247
8231 IP	7311518270285	4	247
8242-2P	7314150243686	1	195
8242L-2P	7314150246687	1	196
8252-2P	7314150243693	1	195
8252L-2P	7314150246694	1	196
8252XL-1P	7314150265985	1	197
833AJ-4	7311518286927	1	604
833AJ-5	7311518286934	1	604
833AJ-6	7311518286941	1	604
833FJ-4	7311518286965	1	604
833FJ-5	7311518286972	1	604
833FJ-6	7311518286989	1	604
833PJ-4	7311518286897	1	603
833PJ-5	7311518286903	1	603
833PJ-67	7311518286910	1	603
833SB-4	7311518286859	1	604
833SB-5	7311518286866	1	604
833SB-6	7311518286873	1	604
833SB-7	7311518286880	1	604
834V-2	7314150124992	1	603
834V-4	7311518286811	1	603
834V-5	7311518286828	1	603
834V-6	7311518286835	1	603
834V-7	7311518286842	1	603
84-PODGER	7314150307494	1	40
850-1	7311518292737	10	562
8501-10	7311518004828	1	141
8501-10F	7311518220945	1	141
8501-12	7311518004842	1	141
8501-12F	7311518220952	1	141
8501-13	7311518004859	1	141
8501-136-10-24C	7314150371471	1	141
8501-136-20-24C	7314150371488	1	141
8501-13F	7311518220969	1	141
8501-15	7311518004873	1	141
8501-150-10-24C	7314150403004	1	141
8501-15F	7311518220976	1	141
8501-16	7311518004880	1	141
8501-160-20-24C	7314150403011	1	141
8501-160-20-48XF	7314150402892	1	141
8501-165-20-24C	7314150403028	1	141
8501-165-20-48XF	7314150402908	1	141
8501-16F	7311518220983	1	141
8501-16SW	7314150258642	1	141
8501-17	7311518004897	1	141
8501-17F	7311518220990	1	141
8501-17S	7311518221027	1	142
8501-184-16-24	7314150402946	1	141
8501-184-16-40	7314150402953	1	141
8501-184-20-24C	7314150403042	1	141
8501-18S	7311518221034	1	142
8501-18SW	7311518221058	1	141



8501-190-30-24C	7314150403059	1	141
8501-190-30-60XF	7314150402960	1	141
8501-2	7311518004743	1	141
8501-210-30-48SW	7314150403066	1	141
8501-210-30-60XF	7314150402977	1	141
8501-216-60SW	7314150359448	1	141
8501-22	7311518178888	1	141
8501-22F	7311518221003	1	141
8501-23	7311518004958	1	141
8501-230-30-60XF	7314150402984	1	141
8501-235-30-60XF	7314150402991	1	141
8501-23F	7311518018887	1	141
8501-260-24SW	7314150359479	1	141
8501-260-30-80S	7314150403097	1	142
8501-260-40SW	7314150359462	1	141
8501-260-60SW	7314150359455	1	141
8501-28	7311518018894	1	141
8501-28F	7311518221010	1	141
8501-28S	7311518221041	1	142
8501-28SW	7311518221065	1	141
8501-28XF	7311518281946	1	141
8501-3	7311518004750	1	141
8501-30	7311518237479	1	141
8501-305-30-40SW	7314150403073	1	141
8501-305-30-60SW	7314150403080	1	141
8501-305-30-96S	7314150403103	1	142
8501-30F	7311518237462	1	141
8501-30S	7311518282240	1	142
8501-30SW	7311518282196	1	141
8501-30XF	7311518281984	1	141
8501-31	7311518237455	1	141
8501-31F	7311518237448	1	141
8501-4	7311518008079	1	141
8501-40	7311518282042	1	141
8501-4F	7311518220914	1	141
8501-4XF	7311518281786	1	141
8501-5	7311518004774	1	141
8501-5F	7311518220921	1	141
8501-7	7311518004798	1	141
8501-7F	7311518220938	1	141
8510SL-2P	7314150245758	1	508
8520SL-2P	7314150245765	1	508
86	7314150005376	1	39
86-1	7314150254996	1	39
86-2	7314150255009	1	39
8600-2P	7314150245654	1	195
8610-2P	7314150243648	1	195
8610L-2P	7314150246700	1	196
8610SL-2P	7314150243891	1	508
8620-2P	7314150243662	1	195
8620L-2P	7314150246717	1	196
8620SL-2P	7314150243907	1	508
8620XL-1P	7314150265947	1	197
8630-2P	7314150246571	1	195
8630XL-1P	7314150265961	1	197
864000010	8413345137638	1	567
864000020	7314150330171	1	567
864002450	8413345129022	50	567
864100010	8413345137621	1	567
864102400	8413345129015	1	567
865-1	7311518292744	10	562
869102500	8413345083669	6	592
869103000	8413345116640	6	592
869203000	8413345137508	6	592
87	7314150005406	3	39
87-1	7314150255016	1	39
87-2	7314150255023	1	39
8703-2P	7314150246632	1	196
8704-2P	7314150246649	1	196
8705-2P	7314150246656	1	196
8706-2P	7314150246663	1	196
8710SL-2P	7314150245772	1	508
8720SL-2P	7314150245789	1	508
874002000	8413345024938	5	619
874002500	8413345024945	5	619
874003000	8413345024952	5	619
874003500	8413345024969	5	619
874004000	8413345024976	5	619
874005000	8413345024983	5	619
874102000	8413345080989	6	619
874102500	8413345081009	5	619
874103000	8413345081023	5	619
874103500	8413345081047	4	619
874104000	8413345081061	5	619
874602000	8413345024990	5	619
874602500	8413345025003	5	619
874603000	8413345025065	5	619
874603500	8413345025072	5	619
874604000	8413345025089	5	619
874916X16	7314150489787	1	620
874918X18	7314150489800	1	620
874923X13	7314150489763	1	620
874926X7	7314150489749	1	620
876002000	8413345025119	10	620
876002500	8413345025126	5	620
877002400	8413345025140	25	620



8800-2P	7314150246588	1	195
8810-2P	7314150243655	1	195
8810L-2P	7314150246724	1	196
8810SL-2P	7314150243914	1	508
8820-2P	7314150243679	1	195
8820L-2P	7314150246731	1	196
8820SL-2P	7314150243921	1	508
8820XL-1P	7314150265954	1	197
8821MB	7314150220571	1	78
8830-2P	7314150246595	1	195
8830XL-1P	7314150265978	1	197
8840M	7314151105495	1	79
8845DM	7314151105525	1	78
8845NM	7314151810955	1	78
8900DM-19	7314151105730	1	100
8900DM-21	7314150166367	5	100
8900DM-22	7314151105754	1	100
8900DM-23	7314150166374	1	100
8900DM-24	7314151105778	1	100
8900DM-25	7314151105785	1	100
8900DM-26	7314150219797	1	100
8900DM-27	7314151105822	1	100
8900DM-28	7314151105846	1	100
8900DM-29	7314150219803	1	100
8900DM-30	7314151105884	5	100
8900DM-32	7314151105891	1	100
8900DM-33	7314150166398	1	100
8900DM-34	7314151838478	1	100
8900DM-35	7314150219810	1	100
8900DM-36	7314151105914	1	100
8900DM-37	7314150166404	1	100
8900DM-38	7314150219827	1	100
8900DM-40	7314150166411	1	100
8900DM-41	7314151105938	5	100
8900DM-42	7314150166428	1	100
8900DM-46	7314151105952	1	100
8900DM-47	7314150166435	1	100
8900DM-50	7314151105969	5	100
8900DM-52	7314150166442	1	100
8900DM-54	7314150166459	3	100
8900DM-55	7314151105983	1	100
8900DM-56	7314150166466	1	100
8900DM-60	7314151106003	5	100
8900DZ-1	7314151106058	1	100
8900DZ-1.1/16	7314151106065	1	100
8900DZ-1.1/2	7314151106133	1	101
8900DZ-1.1/4	7314151106096	1	101
8900DZ-1.1/8	7314151106072	1	100
8900DZ-1.11/16	7314150166282	1	101
8900DZ-1.13/16	7314151106188	1	101
8900DZ-1.3/16	7314151106089	1	100
8900DZ-1.3/4	7314151106171	1	101
8900DZ-1.3/8	7314151106119	1	101
8900DZ-1.5/16	7314151106102	5	101
8900DZ-1.5/8	7314151106157	1	101
8900DZ-1.7/16	7314151106126	1	101
8900DZ-1.7/8	7314151106195	1	101
8900DZ-1.9/16	7314150166299	1	101
8900DZ-13/16	7314150166305	1	100
8900DZ-15/16	7314151106034	1	100
8900DZ-2	7314151106201	1	101
8900DZ-2.1/16	7314150166312	1	101
8900DZ-2.1/4	7314150166329	1	100
8900DZ-2.1/8	7314150166336	1	101
8900DZ-2.3/16	7314150358670	1	101
8900DZ-2.3/8	7314150166350	5	101
8900DZ-3/4	7314150166381	1	100
8900DZ-31/32	7314150358663	1	100
8900DZ-7/8	7314150166473	1	100
8900SM-19	7314150166633	1	100
8900SM-22	7314151810795	1	100
8900SM-23	7314150219834	1	100
8900SM-24	7314151810801	5	100
8900SM-26	7314150219841	5	100
8900SM-27	7314151810818	5	100
8900SM-28	7314150166657	1	100
8900SM-29	7314150219858	1	100
8900SM-30	7314151810825	5	100
8900SM-32	7314151810832	5	100
8900SM-33	7314150166671	1	100
8900SM-34	7314151838461	1	100
8900SM-35	7314150166688	1	100
8900SM-36	7314151810849	5	100
8900SM-38	7314151810856	1	100
8900SM-41	7314151810863	5	100
8900SM-42	7314150219865	1	100
8900SM-46	7314151810870	1	100
8900SM-50	7314151810887	1	100
8900SM-55	7314151810894	1	100
8900SM-60	7314151810900	1	100
8900SZ-1	7314150166480	1	100
8900SZ-1.1/16	7314150166497	1	100
8900SZ-1.13/16	7314150166534	1	100
8900SZ-1.3/4	7314150166541	1	100
8900SZ-1.3/8	7314150166558	1	100
8900SZ-1.5/16	7314150166565	1	100



8900SZ-1.5/8



8900SZ-1.5/8	7314150166572	1	100
8900SZ-1.7/16	7314150166589	1	100
8900SZ-1.7/8	7314150166596	1	100
8900SZ-1.9/16	7314150166602	1	100
8900SZ-13/16	7314150166619	1	100
8900SZ-2	7314150166640	1	100
8900SZ-3/4	7314150166664	1	100
8900SZ-7/8	7314150166695	1	100
89049TM-1000	7314150415403	1	115
8905-TM	7314150125470	1	115
8910-2P	7314150243709	1	196
8910SL-2P	7314150243938	1	508
8915-2P	7314150243716	1	196
8915L-2P	7314150258765	1	196
8915SL-2P	7314150243945	1	508
8920-2P	7314150243723	1	196
8920L-2P	7314150258772	1	196
8920SL-2P	7314150243952	1	508
89222CCR-1000	7314150415441	1	116
8925-2P	7314150243730	1	196
8925L-2P	7314150258789	1	196
8925SL-2P	7314150243969	1	508
8927-2P	7314150243747	1	196
8927L-2P	7314150263516	1	196
8930-2P	7314150243754	1	196
8930L-2P	7314150258796	1	196
8930SL-2P	7314150243976	1	508
8940-2P	7314150243761	1	196
894M-10	7314151833039	10	51
894M-100	7314151833305	1	51
894M-105	7314151833312	1	51
894M-11	7314151833046	10	51
894M-110	7314151833329	1	51
894M-115	7314151833336	1	51
894M-12	7314151833053	10	51
894M-120	7314151833343	1	51
894M-125	7314150132478	1	51
894M-13	7314151833060	10	51
894M-130	7314150132485	1	51
894M-135	7314150132492	1	51
894M-14	7314151833077	10	51
894M-15	7314151833084	10	51
894M-16	7314150139569	10	51
894M-17	7314151833091	10	51
894M-19	7314151833107	10	51
894M-21	7314150223220	5	51
894M-22	7314151833114	5	51
894M-24	7314151833121	5	51
894M-27	7314151833138	5	51
894M-30	7314151833145	5	51
894M-32	7314151833152	5	51
894M-34	7314150139583	1	51
894M-36	7314151833169	5	51
894M-38	7314151833176	1	51
894M-41	7314151833183	1	51
894M-46	7314151833190	1	51
894M-50	7314151833206	1	51
894M-55	7314151833213	1	51
894M-60	7314151833220	1	51
894M-65	7314151833237	1	51
894M-7	7314151833008	10	51
894M-70	7314151833244	1	51
894M-75	7314151833251	1	51
894M-8	7314151833015	10	51
894M-80	7314151833268	1	51
894M-85	7314151833275	1	51
894M-9	7314151833022	10	51
894M-90	7314151833282	1	51
894M-95	7314151833299	1	51
8950N/A	7314151810948	1	102
8950NA-SO/2	7314151816605	1	102
8951	7314151106782	1	102
8951-M	7314150124916	1	117
8953	7314151106799	1	101
8954	7314151106805	1	101
8954A	7314151106812	1	101
8955N	7314150434114	1	102
8955N-SPARE	7314150434121	1	102
8955N/A	7314150434053	1	102
8955N/B	7314150434176	5	102
8958	7314151106829	1	101
8958A	7314151106836	1	101
895M-10-11	7314151832742	10	49
895M-10-13	7314151832759	10	49
895M-13-17	7314151832803	10	49
895M-17-19	7314151832827	10	49
895M-19-22	7314151832834	10	49
895M-19-24	7314151832841	5	49
895M-22-24	7314151832858	5	49
895M-24-27	7314151832865	5	49
895M-24-30	7314151832872	5	49
895M-27-32	7314151832889	5	49
895M-30-32	7314151832896	5	49
895M-30-36	7314151832902	1	49
895M-32-36	7314151832919	1	49
895M-36-41	7314151832926	1	49



895M-41-46	7314151832933	1	49
895M-46-50	7314151832940	1	49
895M-50-55	7314151832957	1	49
895M-55-60	7314151832964	1	49
895M-6-7	7314151832711	10	49
895M-65-70	7314151832971	1	49
895M-8-10	7314151832735	10	49
895M-8-9	7314151832728	10	49
8961	7314151106850	1	101
8962	7314151106867	1	101
8963	7314150181087	1	101
8965	7314151106881	1	101
8966	7314151106898	1	101
8967	7314153003591	1	96
8967/S3	7314153003607	1	83
9-12-51/3806-KP	7311518044558	5	648
9-462-14-0-0	7311518020873	5	35
9-463-14-0-0	7311518327750	1	35
9-467-00-0-0	7311518020897	1	35
9-469-00-0-0	7311518020903	1	35
9-484-3.2-10	7311518193348	10	35
9-484-3.2-1P	7311518193522	10	35
9-484-5.2-10	7311518193355	10	35
9-484-5.2-1P	7311518193331	10	35
9-485-04-10	7314150271672	10	36
9-485-04-1P	7314150271665	10	36
9-485-05-10	7314150271696	10	36
9-485-05-1P	7314150271689	10	36
9-485-06-10	7311518193508	10	36
9-485-06-1P	7311518193492	20	36
9-485-09-10	7311518193386	10	36
9-485-09-1P	7311518193362	20	36
9-485-13-10	7311518193393	10	36
9-485-13-1P	7311518193379	1	36
9-486-04-10	7311518193430	10	36
9-486-04-1P	7311518193409	20	36
9-486-05-10	7311518193461	10	36
9-486-05-1P	7311518193447	20	36
9-486-07-10	7311518249373	10	36
9-486-07-1P	7311518249359	20	36
9-486-08-10	7311518270933	10	36
9-486-C-10	7311518209599	10	36
9-486-C-1P	7311518209605	10	36
9-488-02-10	7311518194772	10	35
900T-020-100	7314153018106	5	214
900T-025-100	7314153018113	5	214
900T-030-100	7314153018120	5	214
900T-040-150	7314153018137	5	214
900T-050-150	7314153018144	5	215
900T-060-200	7314153018151	5	215
900T-080-200	7314153018168	5	215
900T-100-200	7314153018175	5	215
901T-006-100	7314153018182	5	215
901T-007-100	7314153018199	5	215
901T-008-100	7314153018205	5	215
901T-009-100	7314153018212	5	215
901T-010-100	7314153018229	5	215
901T-015-150	7314153018236	5	215
901T-020-150	7314153018243	5	215
901T-025-150	7314153018250	5	215
901T-027-150	7314153018267	5	215
901T-030-200	7314153018274	5	215
901T-040-200	7314153018281	5	215
901T-045-200	7314153018298	5	215
901T-050-200	7314153018304	5	215
9029	7314153010612	5	38
9029 C	7314153010629	5	38
9029-1	7314150239580	1	39
9029-2	7314150238668	1	39
9029-T	7314150189076	5	38
9029T-1	7314150312139	1	39
902T-050-150	7314153018311	5	215
902T-055-150	7314153018328	5	215
902T-060-150	7314153018335	5	215
902T-070-175	7314153018342	5	215
902T-080-175	7314153018359	5	215
902T-090-175	7314153018366	5	215
902T-100-175	7314153018373	5	215
902T-110-175	7314153018380	5	215
902T-120-175	7314153018397	5	215
902T-130-175	7314153018403	5	215
9031	7314150110988	5	38
9031 C	7314150113507	5	38
9031 P-1	7314150266302	1	39
9031-1	7314150239597	1	39
9031-8224	7314150321193	3	258
9031-T	7314150131648	5	38
9031P	7314150187539	5	38
9031T-1	7314150312146	1	39
9033	7314150181414	5	38
9033-1	7314150353804	1	39
9035	7314150181421	5	38
9035-1	7314150353811	1	39
903T-1	7314153018410	1	215
903T-2	7314153018427	1	215
903T-3	7314153018434	1	216



9045-B-200	7311518012175	6	558
9045-B-250	7311518012182	6	558
9045-B-300	7311518012199	6	558
9045-B-400	7311518178123	1	558
9048-200	7314150138159	10	558
9048-250	7314150138166	10	558
9048-300	7314150138173	10	558
9048-350	7314150180349	10	558
9048-400	7314150138180	10	558
904T-060-150	7314153019837	5	216
905T-060-100	7314153019844	5	215
9070	7314150100170	5	38
9070 P	7314150103416	5	38
9070 P-1	7314150239610	1	39
9070 PC	7314150103423	5	38
9070C	7314150100187	5	38
9071	7314150100194	5	38
9071 P	7314150103430	5	38
9071 P-1	7314150239627	1	39
9071 PC	7314150103447	5	38
9071C	7314150100200	5	38
9072	7314150055609	5	38
9072 C	7314150055616	5	38
9072 P	7314150056354	5	38
9072 P-1	7314150239634	1	39
9072 PC	7314150056361	5	38
9073	7314150101702	5	38
9073 C	7314150101719	3	38
9073 P	7314150101726	5	38
9073 P-1	7314150239641	1	39
9073 PC	7314150101733	3	38
91-023-5P	7311518032593	1	138
91-027-5P	7311518032616	1	138
91-143-100P	7311518224363	1	138
91-143-25P	7311518266578	1	138
91-143-5P	7311518032630	1	138
91-148-5P	7311518032654	1	138
91-223-5P	7311518032661	1	138
91-226-5P	7311518032685	1	138
91-233-5P	7311518260057	1	138
91-243-5P	7311518032692	1	138
91-2PW-5P	7311518260163	1	138
91-3PM-5P	7311518260156	1	138
91-412-5P	7311518260040	1	138
91-433-5P	7311518260101	1	138
91-434-5P	7311518260026	1	138
91-443-5P	7311518032722	1	138
91-444-5P	7311518260033	1	138
91-4PWM-5P	7311518260170	1	138
91-502-5P	7311518032746	1	138
91-512-25P	7311518266592	1	138
91-512-5P	7311518032753	1	138
91-517-5P	7311518032777	1	138
91-522-5P	7311518032784	1	138
91-611-5P	7311518260071	1	138
91-612-5P	7311518032814	1	138
91-622-5P	7311518260088	1	138
91-623-5P	7311518260064	1	138
91-7V1-5P	7311518260118	1	138
91-METAL-10P	7314150449477	1	138
91-MIXED-10P	7314150449491	1	138
91-WOOD-10P	7314150449446	1	138
91C	7314150182381	5	40
92-001-1P	7314150474998	90	140
92-106-1P	7314150474899	90	139
92-113-1P	7314150474912	90	140
92-118-1P	7314150474950	90	140
92-133-1P	7314150474134	70	139
92-133-25	7314150486687	25	139
92-133-3P	7314150474158	46	139
92-136-1P	7314150474783	20	141
92-136-G120-5P	7314150498079	10	141
92-136-G240-5P	7314150498116	10	141
92-136-G40-5P	7314150497997	10	141
92-136-G80-5P	7314150498031	10	141
92-137-1P	7314150475070	50	141
92-137-G120-5P	7314150498093	10	141
92-137-G240-5P	7314150498130	10	141
92-137-G40-5P	7314150498017	10	141
92-137-G80-5P	7314150498055	10	141
92-157-1P	7314150474820	70	139
92-157-25	7314150486816	25	139
92-160-1P	7314150474172	70	139
92-160-25	7314150486700	25	139
92-160-3P	7314150474196	46	139
92-165-1P	7314150475018	90	140
92-166-1P	7314150474974	50	140
92-174-1P	7314150474936	90	140
92-205-1P	7314150474219	70	139
92-205-25	7314150486724	25	139
92-205-3P	7314150474356	46	139
92-221-1P	7314150474721	70	139
92-222-1P	7314150474592	70	139
92-222-25	7314150486748	25	139
92-222-3P	7314150474370	46	139
92-223-1P	7314150474684	70	139



92-223-3P	7314150474400	46	139
92-225-1P	7314150474707	70	139
92-225-25	7314150486779	25	139
92-226-1P	7314150475032	90	140
92-228-1P	7314150474745	70	139
92-228-25	7314150486793	25	139
92-229-1P	7314150474769	70	139
92-236-1P	7314150474806	70	139
92-245-1P	7314150475056	90	140
92-251-1P	7314150474868	70	140
92-WM-SET-8P	7314150486830	34	140
9210	7311518278182	1	654
9210-1	7311518278212	1	654
9210-10	7311518278229	1	654
9210-1060177	7311518295424	1	655
9210-1060238	7311518295394	20	655
9210-1230219	7311518295387	20	655
9210-1230235	7311518295325	1	654
9210-1320281	7311518295431	10	655
9210-1640142	7311518295356	1	654
9210-1690148	7311518295332	1	654
9210-1700118	7311518295363	1	655
9210-1710266	7311518295417	1	655
9210-1720100	7311518295295	1	654
9210-1730107	7311518295349	10	654
9210-1770106	7311518295370	10	655
9210-1830137	7311518295400	1	655
9210-20	7311518278236	1	654
92C	7314150182398	5	40
93C	7314150182404	5	40
94C	7314150182411	5	40
9500DZ-1.13/16	7314150227501	1	103
9500DZ-1.5/8	7314150227495	1	103
9500DZ-1.7/8	7314150227518	1	103
9500DZ-2	7314150227525	1	103
9500DZ-2.1/2	7314150227570	1	103
9500DZ-2.1/4	7314150227556	1	103
9500DZ-2.1/8	7314150227532	1	103
9500DZ-2.15/16	7314150227617	1	103
9500DZ-2.3/16	7314150227549	1	103
9500DZ-2.3/4	7314150227600	1	103
9500DZ-2.3/8	7314150227563	1	103
9500DZ-2.5/8	7314150227594	1	103
9500DZ-2.9/16	7314150227587	1	103
9500DZ-3	7314150227624	1	103
9500DZ-3.1/8	7314150227631	1	103
9500SM-41	7314153013699	1	102
9500SM-46	7314153013705	1	102
9500SM-50	7314153013712	1	102
9500SM-54	7314153013729	1	102
9500SM-55	7314153013736	1	102
9500SM-58	7314153013743	1	102
9500SM-60	7314153013750	1	103
9500SM-63	7314153013767	1	103
9500SM-65	7314153013774	1	103
9500SM-67	7314153013781	1	103
9500SM-70	7314153013798	1	103
9500SM-71	7314153013804	1	103
9500SM-75	7314153013811	1	103
9500SM-77	7314153013828	1	103
9500SM-80	7314153013835	1	103
9500SM-82	7314153013842	1	103
9505-3400	7314150125517	1	116
9505-TM	7314150125487	1	115
95155B-3000	7314150415410	1	116
9525-10	7311518031817	1	156
9525-3400	7314150125524	1	116
9525-7	7311518031800	1	156
9525CR-4000	7314150415465	1	116
9526B-4500	7314150415427	1	116
9527CR-2000	7314150415458	1	116
9528-MD-15-45	7311518007447	10	155
9528-MD-22-76	7311518041441	10	155
9540DZ	7314150414048	1	79
9540DZL	7314150414055	1	79
9540MB	7314153014108	1	79
9540MBL	7314153014115	1	79
9550N	7314150424160	1	103
9550N-SPARE	7314150424153	1	104
9550N/A	7314150424146	1	104
9550N/B	7314150424788	1	103
9555	7314153014047	1	103
9555AB	7314153014061	1	103
956	7314150025190	1	586
9560AB	7314153014078	1	103
9563AB	7314153014085	1	103
9564	7314151107543	1	102
9565AB	7314153014092	1	103
9566A	7314150220618	1	103
9572	7314150178599	5	40
9572-200	7311518004231	20	558
9572-250	7311518004248	20	558
9574-200	7314150138197	10	558
9574-250	7314150138203	10	558
9574-300	7314150180356	10	558
9575-250	7314150185894	6	558





95C	7314150182428	1	40
960100010	8413345031073	1	471
960100020	8413345031080	1	471
960100030	8413345031097	1	471
960100050	8413345031103	1	471
960100060	8413345031110	1	471
9625-6.35QC	7314150441716	1	156
9625-9500	7314150125555	1	116
96255CR-7000	7314150415489	1	116
9626-10	7314150388844	1	154
9626-11	7314150388851	1	154
9626-12	7314150388868	1	154
9626-13	7314150388875	1	154
9626-14	7314150388882	1	154
9626-15	7314150444526	1	154
9626-16	7314150388899	1	154
9626-18	7314150388905	1	154
9626-20	7314150388912	1	154
9626-22	7314150388929	1	154
9626-23	7314150388936	1	154
9626-24	7314150388943	1	154
9626-25	7314150388950	1	154
9626-26	7314153024237	1	154
9626-28	7314150388967	1	154
9626-30	7314150388974	1	154
9626-32	7314150388981	1	154
9626-35	7314150444533	1	154
9626-6	7314150388806	1	154
9626-7	7314150388813	1	154
9626-8	7314150388820	1	154
9626-9	7314150388837	1	154
9627-10-460	7314150389018	1	154
9627-12-460	7314150389025	1	154
9627-14-460	7314150389032	1	154
9627-16-460	7314150389049	1	154
9627-18-460	7314150389056	1	154
9627-20-460	7314150389063	1	154
9627-22-460	7314150389070	1	154
9627-24-460	7314150389087	1	154
9627-26-460	7314150389094	1	154
9627-28-460	7314150389100	1	154
9627-30-460	7314150389117	1	154
9627-32-460	7314150389124	1	154
9627-6-460	7314150388998	1	154
9627-8-460	7314150389001	1	154
9629-10	7314150388479	1	155
9629-12	7314150388486	1	155
9629-13	7314150440238	1	155
9629-14	7314150388493	1	155
9629-16	7314150388509	1	155
9629-17	7314150440245	1	155
9629-18	7314150388516	1	155
9629-19	7314150440252	1	155
9629-20	7314150388523	1	155
9629-22	7314150388530	1	155
9629-24	7314150388547	1	155
9629-25	7314150388554	1	155
9629-26	7314150388561	1	155
9629-28	7314150388578	1	155
9629-30	7314150388585	1	155
9629-32	7314150388592	1	155
9629-35	7314150440269	1	155
9629-36	7314150388608	1	155
9629-38	7314150388615	1	155
9629-40	7314150388622	1	155
9629-6	7314150388417	1	155
9629-8	7314150388462	1	155
9629-SET-8	7314150441648	10	155
9631-10-400	7314150388684	1	155
9631-12-400	7314150388691	1	155
9631-13-400	7314150447572	1	155
9631-14-400	7314150388707	1	155
9631-16-400	7314150388714	1	155
9631-18-400	7314150388721	1	155
9631-19-400	7314150447589	1	155
9631-20-400	7314150388738	1	155
9631-22-400	7314150388745	1	155
9631-24-400	7314150388752	1	155
9631-25-400	7314150432066	1	155
9631-28-400	7314150388776	1	155
9631-30-400	7314150388783	1	155
9631-32-400	7314150388790	1	155
9631-35-400	7314150447596	1	155
9631-38-400	7314150447602	1	155
9631-6-400	7314150388646	1	155
9631-8-400	7314150388677	1	155
9646-10	7314150388264	1	155
9646-10-250	7314150388387	1	155
9646-11	7314150388288	1	155
9646-12	7314150388295	1	155
9646-12-250	7314150388400	1	155
9646-13	7314150388301	1	155
9646-14	7314150388318	1	155
9646-15	7314150388325	1	155
9646-16	7314150388332	1	155
9646-18	7314150388349	1	155



9646-20	7314150388356	1	155
9646-3	7314150388189	1	155
9646-4	7314150388202	1	155
9646-5	7314150388219	1	155
9646-6	7314150388226	1	155
9646-6-250	7314150388363	1	155
9646-7	7314150388233	1	155
9646-8	7314150388240	1	155
9646-8-250	7314150388370	1	155
9646-9	7314150388257	1	155
9646-SET-5	7314150441686	1	155
9646-SET-8	7314150441693	1	155
9656-SET-6	7314150486953	1	155
96C	7314150134120	1	40
97-1	7314150366637	1	119
97-1/2	7314150366545	1	119
97-1/4	7314150366507	1	119
97-10	7314150366286	1	118
97-11	7314150366293	1	118
97-11/16	7314150366583	1	119
97-12	7314150366309	1	118
97-13	7314150366316	1	118
97-13/16	7314150366606	1	119
97-14	7314150366323	1	118
97-15	7314150366330	1	118
97-15/16	7314150366620	1	119
97-16	7314150366347	1	118
97-17	7314150366354	1	118
97-17/32	7314150366552	1	119
97-18	7314150366361	1	118
97-19	7314150366378	1	118
97-21	7314150366385	1	118
97-22	7314150349722	1	118
97-24	7314150357048	1	118
97-27	7314150366392	1	118
97-3/4	7314150366590	1	119
97-3/8	7314150366521	1	119
97-30	7314150366408	1	118
97-32	7314150366415	1	118
97-5/16	7314150366514	1	119
97-5/8	7314150366576	1	119
97-7	7314150366255	1	118
97-7/16	7314150366538	1	119
97-7/8	7314150366613	1	119
97-8	7314150366262	1	118
97-9	7314150366279	1	118
97-9/16	7314150366569	1	119
9710-10-175	7314151785789	5	216
9710-3.5-75	7314151785192	10	216
9710-5.5-100	7314151785352	10	216
9710-6.5-125	7314151785437	10	216
9710-8-150	7314151785512	5	216
9710/S6	7314151802301	1	217
9715-14-250	7314153010148	5	218
9733	7314150103256	1	257
9778-1	7314151793524	10	216
9778-2	7314151793531	10	216
9778-3	7314151793548	5	216
9778PZD-1	7314151823535	10	217
9778PZD-2	7314151823542	10	217
97C	7314150128211	1	40
98-1/2	7314150367481	1	120
98-1/4	7314150367443	1	120
98-10	7314150367320	1	119
98-11	7314150367337	1	119
98-11/16	7314150367511	1	120
98-12	7314150367344	1	119
98-13	7314150367351	1	119
98-13/16	7314150367535	1	120
98-14	7314150367368	1	119
98-15	7314150367375	1	119
98-16	7314150367382	1	119
98-17	7314150367399	1	119
98-18	7314150367405	1	119
98-19	7314150367412	1	119
98-21	7314150367429	1	119
98-22	7314150367436	1	119
98-3/4	7314150367528	1	120
98-3/8	7314150367467	1	120
98-5/16	7314150367450	1	120
98-5/8	7314150367504	1	120
98-7	7314150367290	1	119
98-7/16	7314150367474	1	120
98-7/8	7314150367542	1	120
98-8	7314150367306	1	119
98-9	7314150367313	1	119
98-9/16	7314150367498	1	120
981001100	7314150219902	1	447
982000170	7314150219926	1	478
982000320	7314150219919	1	438
982000350	7314150219933	1	439
983000320	7314150219940	1	438
983100320	7314150219964	1	438
984010320	7314150219971	1	439
9841	7314150107445	1	456
9848	7314150111015	1	439



98505	7314150216321	5	214
9852	7314150114092	1	456
9853	7314150103287	1	258
9873	7314150058082	1	258
9883	7314150043293	1	585
9897	7314150058068	1	258
9897G/3	7314150470020	1	258
9897S/3	7314150470044	1	514
99-1/2	7314150368150	1	120
99-10	7314150368013	1	120
99-11	7314150368020	1	120
99-11/16	7314150368181	1	120
99-12	7314150368037	1	120
99-13	7314150368044	1	120
99-14	7314150368051	1	120
99-16	7314150368068	1	120
99-17	7314150368075	1	120
99-18	7314150368082	1	120
99-19	7314150368099	1	120
99-21	7314150368105	1	120
99-22	7314150368112	1	120
99-24	7314150368129	1	120
99-3/4	7314150368198	1	120
99-3/8	7314150368136	1	120
99-5/8	7314150368174	1	120
99-7/16	7314150368143	1	120
99-9/16	7314150368167	1	120
9938	7314150056491	1	251
9A-14	7314150368204	1	120
9B-1/4	7314150366071	1	118
9B-5/16	7314150366088	1	118
9F-1/2	7314150366194	1	118
9F-1/4	7314150366170	1	118
9F-3/8	7314150366187	1	118
9P-1/2	7314150366057	1	118
9P-1/4	7314150366033	1	118
9P-3/8	7314150366040	1	118
9Q-1/2	7314150366019	1	118
9Q-1/4	7314150365999	1	118
9Q-3/8	7314150366002	1	118
9R-1/2	7314150365913	1	117
9R-1/4	7314150365890	1	117
9R-3/8	7314150365906	1	117
9T-1/2	7314150366118	1	117
9T-1/4	7314150366095	1	117
9T-3/8	7314150366101	1	117
9W	7314150354399	1	120
A0313M03	7311518023706	1	144
A0313M03E	7311518192150	1	144
A0313M03X	7311518182038	1	144
A0313M03XE	7311518181475	1	144
A0313M03XE-60	7311518184513	1	144
A0313M03XE-80	7311518201357	1	144
A0314I03	7314150501243	5	147
A0613M03X	7311518197872	1	144
A0616AL06E	7311518181802	1	145
A0616M06	7311518023737	1	144
A0616M06E	7311518023751	1	144
A0616M06X	7311518023768	1	144
A0616M06XE	7311518181468	1	144
A0618I06	7314150501267	5	147
A0618S06E	7314150501786	5	146
A0625M06X	7311518197780	1	146
A0820M06	7311518023805	1	144
A0820M06E	7311518023829	1	144
A0820M06X	7311518023836	1	144
A0820M06XE	7311518181994	1	144
A1020I06	7314150501304	5	147
A1020M06	7311518023874	1	144
A1020M06E	7311518023898	1	144
A1020M06X	7311518023904	1	144
A1020M06XE	7311518182007	1	144
A1020S06	7314150501335	5	146
A1020S06E	7314150501793	5	146
A1225AL06E	7311518187620	1	145
A1225AL08E	7311518181819	1	145
A1225I06	7314150506729	5	147
A1225M06	7311518023942	1	144
A1225M06E	7311518023966	1	144
A1225M06X	7311518023973	1	144
A1225M08	7311518100506	1	144
A1225M08E	7311518100520	1	144
A1225M08X	7311518187989	1	144
A1225M08XE	7311518192174	1	144
A1225S06	7314150501427	5	146
A1225S06E	7314150501809	5	146
A1625AL08XE	7311518244033	1	145
A1625M06	7311518192181	1	144
A1625M06X	7311518187361	1	144
A1625M06XE	7311518187354	1	144
A1625M08	7311518100568	1	144
A1625M08E	7311518100582	1	144
A1625M08X	7311518100599	1	144
A1625M08XE	7311518182021	1	144
A6700DM-10	7314151821722	5	80
A6700DM-11	7314151821739	5	80



A6700DM-12	7314151821746	5	80
A6700DM-13	7314151821753	5	80
A6700DM-14	7314151821760	5	80
A6700DM-5	7314150220632	5	80
A6700DM-5.5	7314151821678	5	80
A6700DM-6	7314151821685	5	80
A6700DM-7	7314151821692	5	80
A6700DM-8	7314151821708	5	80
A6700DM-9	7314151821715	5	80
A6700DZ-1/2	7314151751883	5	81
A6700DZ-1/4	7314151751371	5	81
A6700DZ-11/32	7314151819842	5	81
A6700DZ-3/16	7314151751029	5	81
A6700DZ-3/8	7314151751616	5	81
A6700DZ-5/16	7314151751531	5	81
A6700DZ-7/16	7314151819859	5	81
A6700DZ-7/32	7314151751296	5	81
A6700DZ-9/16	7314151751968	5	81
A6700DZ-9/32	7314151751456	5	81
A6709M-2.5	7314151753740	1	85
A6709M-3	7314151753825	1	85
A6709M-4	7314151754129	1	85
A6709M-5	7314151754471	1	85
A6709M-6	7314151754556	1	85
A6709Z-1/8	7314151755447	1	85
A6709Z-3/16	7314151755874	1	85
A6709Z-5/32	7314151755799	1	85
A6709Z-9/64	7314151755522	1	85
A6710DM-10	7314151756765	1	81
A6710DM-11	7314151756840	1	81
A6710DM-12	7314151756925	1	81
A6710DM-13	7314151757069	1	81
A6710DM-14	7314151757144	1	81
A6710DM-5.5	7314151756178	1	81
A6710DM-6	7314151756253	1	81
A6710DM-7	7314151756338	1	81
A6710DM-8	7314151756413	1	81
A6710DM-9	7314151756680	1	81
A6710DZ-1/2	7314151820466	1	82
A6710DZ-1/4	7314151757229	1	82
A6710DZ-11/32	7314151757571	1	82
A6710DZ-3/16	7314151820435	1	82
A6710DZ-3/8	7314151757656	1	82
A6710DZ-5/16	7314151757496	1	82
A6710DZ-7/16	7314151757731	1	82
A6710DZ-7/32	7314151820442	1	82
A6710DZ-9/16	7314151820473	1	82
A6710DZ-9/32	7314151820459	1	82
A6716DM	7314151820824	1	65
A6716DZ	7314151820831	1	67
A6718DZ	7314150312450	1	68
A6800DM-10	7314151821845	1	81
A6800DM-11	7314151821852	1	81
A6800DM-12	7314151821869	1	81
A6800DM-13	7314151821876	1	81
A6800DM-14	7314151821883	1	81
A6800DM-4	7314151821777	1	81
A6800DM-5	7314151821784	1	81
A6800DM-5.5	7314151821791	1	81
A6800DM-6	7314151821807	1	81
A6800DM-7	7314151821814	1	81
A6800DM-8	7314151821821	1	81
A6800DM-9	7314151821838	1	81
A6800DZ-1/2	7314151758899	1	81
A6800DZ-1/4	7314151758387	1	81
A6800DZ-11/32	7314151803872	1	81
A6800DZ-3/16	7314151758035	1	81
A6800DZ-3/8	7314151758622	1	81
A6800DZ-5/16	7314151758547	1	81
A6800DZ-7/16	7314151803889	1	81
A6800DZ-7/32	7314151758110	1	81
A6800DZ-9/16	7314151758974	1	81
A6800DZ-9/32	7314151758462	1	81
A6800SM-10	7314150360147	1	81
A6800SM-11	7314150360154	1	81
A6800SM-12	7314150360161	1	81
A6800SM-13	7314150360178	1	81
A6800SM-14	7314150360185	1	81
A6800SM-15	7314150360192	1	81
A6800SM-4	7314150360208	1	81
A6800SM-4.5	7314150360215	1	81
A6800SM-5	7314150360222	1	81
A6800SM-6	7314150360239	1	81
A6800SM-7	7314150360246	1	81
A6800SM-8	7314150360253	1	81
A6800SM-9	7314150360260	1	81
A6800SZ-1/8	7314150360277	1	81
A6800SZ-5/32	7314150360284	1	81
A7400DM-10	7314151819972	5	87
A7400DM-11	7314151819989	5	87
A7400DM-12	7314151819996	5	87
A7400DM-13	7314151820008	5	87
A7400DM-14	7314151820015	5	87
A7400DM-15	7314151820022	5	87
A7400DM-16	7314151820039	5	87
A7400DM-17	7314151820046	5	87



A7400DM-18



A7400DM-18	7314151820053	5	87
A7400DM-19	7314151820060	5	87
A7400DM-20	7314151820077	5	87
A7400DM-21	7314151820084	5	87
A7400DM-22	7314151820091	5	87
A7400DM-24	7314150386123	5	87
A7400DM-6	7314150118212	5	86
A7400DM-7	7314150118229	5	86
A7400DM-8	7314150118236	5	86
A7400DM-9	7314151819965	5	87
A7400DZ-1/2	7314151759780	5	87
A7400DZ-1/4	7314151759193	5	87
A7400DZ-11/16	7314151819897	5	87
A7400DZ-13/16	7314151819910	5	87
A7400DZ-17/32	7314151819866	5	87
A7400DZ-19/32	7314151819873	5	87
A7400DZ-3/4	7314151819903	5	87
A7400DZ-3/8	7314151759438	5	87
A7400DZ-5/16	7314151759278	5	87
A7400DZ-5/8	7314151819880	5	87
A7400DZ-7/16	7314151759513	5	87
A7400DZ-7/8	7314151819927	5	87
A7400DZ-9/16	7314151759865	5	87
A7402DM-10	7314151820138	1	87
A7402DM-11	7314151820145	1	87
A7402DM-12	7314151820152	1	87
A7402DM-13	7314151820169	1	87
A7402DM-14	7314151820176	1	87
A7402DM-15	7314151820183	1	87
A7402DM-16	7314151820190	1	87
A7402DM-17	7314151820206	1	87
A7402DM-18	7314151820213	1	87
A7402DM-19	7314151820220	1	87
A7402DM-21	7314150385881	1	87
A7402DM-7	7314150220243	1	87
A7402DM-8	7314150220250	1	87
A7402DM-9	7314150220267	1	87
A7402DZ-1/2	7314151760526	1	88
A7402DZ-1/4	7314151759940	1	88
A7402DZ-11/16	7314151820114	1	88
A7402DZ-13/16	7314153003027	1	88
A7402DZ-19/32	7314153003041	1	88
A7402DZ-3/4	7314151820121	1	88
A7402DZ-3/8	7314151760366	1	88
A7402DZ-5/16	7314151760014	1	88
A7402DZ-5/8	7314151820107	1	88
A7402DZ-7/16	7314151760441	1	88
A7402DZ-7/8	7314153003034	1	88
A7402DZ-9/16	7314151760793	1	88
A7410DZ-1/2	7314153006301	1	87
A7410DZ-11/16	7314153006332	1	87
A7410DZ-3/4	7314153006349	1	87
A7410DZ-3/8	7314153006288	1	87
A7410DZ-5/16	7314153006271	1	87
A7410DZ-5/8	7314153006325	1	87
A7410DZ-7/16	7314153006295	1	87
A7410DZ-9/16	7314153006318	1	87
A7435DME	7314153015006	1	71
A7440DME	7314153015419	1	71
A7440DZE	7314153014993	1	71
A7535DZE	7314153015013	1	71
ADJUST 3	7314150103515	1	39
ADJUST 3-90	7314150236336	1	38
ADJUST 9031/29	7314150302925	3	39
AP-234-F	7311518289027	2	642
AP-3M	7311518152062	1	641
AP-5M	7311518152079	1	641
APB260	7314150389162	10	626
APB360	7314150389186	10	626
AS-1200	7314150321520	3	559
AS-C33-JT-F	7314150341672	15	650
AS-C36-JT-M	7311518337490	15	650
AS-C39-JT-C	7314150341542	15	650
AS-C45-JT-C	7314150341559	15	650
ASP-1850	7311518337124	1	641
ASP-1850G	7311518337131	1	641
ASP-AS	7311518337377	6	641
ASP-AS-C33-JT-F	7314150341665	5	644
ASP-AS-C36-JT-M	7314150340590	5	644
ASP-AS-C39-JT-C	7314150341535	5	644
ASP-AS-C45-JT-C	7314150341566	2	644
ASP-AS-HOOK	7311518337582	4	642
ASP-ATP	7311518337384	6	641
ASP3740-C36JTM	7314150341818	1	644
ASP3740-C39JTC	7314150353347	1	644
ASP3740-C45JTC	7314150353354	1	644
ASP3740-P3437	7314150341801	1	642
ATP-110-210	7311518337575	1	641
ATP-200-350	7311518347062	1	641
ATP-200-500	7311518347055	1	641
ATP-230-410	7311518337599	2	642
AUTO	7314150438082	1	447
B141.007.075	7314150278404	5	202
B141.008.075	7314150278411	5	202
B141.009.075	7314150278428	5	202
B141.010.075	7314150278435	5	202



B141.015.100	7314150278442	5	202
B141.020.100	7314150278459	5	202
B141.025.125	7314150278466	5	202
B141.027.125	7314150278473	5	202
B141.030.150	7314150278480	5	202
B141.040.150	7314150278497	5	202
B142.000.075	7314150278718	10	506
B142.001.080	7314150278725	10	506
B142.001.150	7314150343188	10	506
B142.002.100	7314150278732	10	506
B142.002.175	7314150343195	10	506
B142.003.150	7314150278749	10	506
B143.020.100	7314150278510	5	202
B143.025.100	7314150278503	10	202
B143.030.100	7314150278527	10	202
B143.040.100	7314150278534	10	202
B143.050.100	7314150278541	10	202
B143.060.125	7314150278558	10	202
B143.080.150	7314150278565	5	202
B144.001.100	7314150278787	5	202
B144.002.125	7314150278794	5	202
B144.003.150	7314150278800	5	202
B145.006.100	7314150278756	5	203
B146.006.100	7314150278763	5	203
B147.001.400	7314150285594	1	373
B147.003.400	7314150285600	1	373
B148.001.080	7314150314522	10	506
B148.002.100	7314150314539	10	506
B149.001.080	7314150314546	10	506
B149.002.100	7314150314553	10	506
B150.010.100	7314150343126	10	506
B150.015.125	7314150343133	10	506
B150.020.125	7314150343140	10	506
B150.025.150	7314150343157	10	506
B190.040.075	7314150277810	10	200
B190.040.100	7314150277827	10	200
B190.055.100	7314150277834	10	200
B190.055.125	7314150277841	10	200
B190.065.125	7314150277858	10	200
B190.065.150	7314150277865	10	200
B190.080.150	7314150277872	10	200
B190.080.175	7314150277889	10	200
B190.100.200	7314150277896	10	200
B190.120.250	7314150277902	10	200
B190.140.250	7314150277919	10	200
B191.025.075	7314150277926	10	200
B191.030.075	7314150277933	10	200
B191.030.100	7314150277940	10	200
B191.030.200	7314150277957	10	200
B191.035.100	7314150277964	10	200
B191.040.100	7314150277971	10	200
B191.040.125	7314150277988	10	200
B191.040.250	7314150277995	10	200
B191.055.125	7314150278008	10	200
B191.055.150	7314150278015	10	200
B191.055.300	7314150278022	10	200
B191.065.150	7314150278039	10	200
B191.065.300	7314150278046	10	200
B192.000.075	7314150278084	10	201
B192.000.200	7314150278091	10	201
B192.001.100	7314150278107	10	201
B192.001.250	7314150278114	10	201
B192.002.125	7314150278121	10	201
B192.002.150	7314150442720	10	201
B192.002.300	7314150278138	10	201
B192.003.150	7314150278145	10	201
B192.004.200	7314150278169	10	201
B193.000.075	7314150278190	10	201
B193.001.100	7314150278206	10	201
B193.002.125	7314150278213	10	201
B193.003.150	7314150278220	10	201
B193.004.200	7314150278237	10	201
B194.004.075	7314150278268	10	202
B194.005.075	7314150278275	10	202
B194.006.075	7314150278282	10	202
B194.007.075	7314150278299	10	202
B194.008.075	7314150278305	10	202
B194.009.075	7314150278312	10	202
B194.010.075	7314150278329	10	202
B194.015.100	7314150278336	10	202
B194.020.100	7314150278343	10	202
B194.025.125	7314150278350	10	202
B194.027.125	7314150278367	10	202
B194.030.150	7314150278374	10	202
B194.040.150	7314150278381	10	202
B194.045.150	7314150278398	5	202
B195.001.025	7314150278176	10	201
B195.002.025	7314150278183	10	201
B195.006.050	7314150289493	5	203
B195.040.025	7314150278053	10	200
B195.050.025	7314150278060	10	200
B195.060.025	7314150278077	10	200
B195.901.025	7314150278244	10	201
B195.902.025	7314150278251	10	201
B196.025.075	7314150278589	10	505
B196.030.100	7314150278572	10	505



B196.035.100	7314150278596	10	505
B196.040.100	7314150278602	10	505
B196.055.125	7314150278619	10	505
B196.065.150	7314150278626	10	505
B196.080.175	7314150278633	10	505
B196.100.200	7314150278640	10	505
B196.120.200	7314150278657	10	505
B197.000.075	7314150278664	10	506
B197.001.080	7314150278671	10	506
B197.001.150	7314150343164	10	506
B197.002.100	7314150278688	10	506
B197.002.175	7314150343171	10	506
B197.003.150	7314150278695	10	506
B197.004.200	7314150278701	10	506
B198.040.125	7314150278817	5	203
B198.045.125	7314150278824	5	203
B198.050.150	7314150278831	5	203
B198.055.150	7314150281268	5	203
B198.060.150	7314150281763	5	203
B198.060.150F	7314150281770	5	203
B198.070.150	7314150281787	5	203
B198.070.150F	7314150281794	5	203
B198.080.150	7314150281800	5	203
B198.080.150F	7314150281817	5	203
B198.090.150	7314150281824	5	203
B198.100.150	7314150281831	5	203
B198.110.150	7314150281848	5	203
B198.120.150	7314150281855	5	203
B198.130.150	7314150281862	5	203
B198.140.150	7314150281879	5	203
B199.055.125	7314150281886	5	506
B199.060.125	7314150281893	5	506
B199.070.125	7314150281909	5	506
B199.080.125	7314150281916	5	506
B199.090.125	7314150281923	5	506
B199.100.125	7314150281930	5	506
B199.110.125	7314150281947	5	506
B199.120.125	7314150287741	5	506
B199.130.125	7314150287772	5	506
B219.002	7314150289301	1	203
B219.004	7314150283248	1	204
B219.005	7314150283255	1	204
B219.006	7314150283293	1	205
B219.007	7314150283323	1	205
B219.008	7314150283347	1	206
B219.010	7314150283354	1	207
B219.012	7314150327768	1	204
B219.015	7314150283262	1	204
B219.016	7314150283309	1	205
B219.017	7314150283330	1	206
B219.025	7314150283279	1	204
B219.026	7314150283316	1	205
B219.027	7314150399833	1	206
B219.035	7314150283286	1	205
B219.110	7314150392667	1	206
B219.210	7314150438969	1	207
B220.002	7314150289295	1	506
B220.005	7314150283361	1	507
B220.007	7314150283385	1	507
B220.012	7314150314614	1	506
B220.015	7314150283378	1	507
B220.017	7314150283392	1	507
B220.027	7314150283408	1	507
B400.002	8412814119441	1	622
B400.003	8412814119458	1	622
B400.004	8412814119465	1	622
B400.005	8412814119472	1	622
B400.006	8412814119489	1	622
B400.007	8412814119496	1	622
B400.008	8412814119502	1	623
B400.009	8412814119519	1	623
B400.010	8412814119526	1	623
B400.011	8412814119533	1	623
B400.012	8412814119540	1	623
B400.013	8412814119557	1	623
B400.014	8412814119564	1	623
B400.015	8412814119571	1	623
B400.016	8412814119588	1	623
B400.017	8412814119595	1	623
B400.018	8412814119601	1	623
B400.019	8412814119618	1	623
B400.020	8412814119625	1	623
B400.021	8412814119632	1	623
B400.022	8412814119649	1	623
B400.023	8412814119656	1	623
B400.024	8412814119663	1	623
B400.025	8412814119670	1	623
B400.026	8412814119687	1	623
B400.027	8412814119694	1	623
B400.028	8412814119700	1	623
B400.029	8412814119717	1	623
B400.030	8412814119724	1	623
B400.031	8412814119731	1	623
B400.032	8412814119748	1	623
B400.033	8412814119755	1	623
B400.034	8412814119762	1	623



B400.035	8412814119779	1	623
B400.036	8412814119786	1	623
B400.037	8412814119793	1	623
B400.038	8412814119809	1	623
B400.039	8412814119816	1	623
B400.040	8412814119823	1	623
B400.041	8412814119830	1	623
B400.042	8412814119847	1	623
B400.043	8412814119854	1	623
B400.044	8412814119861	1	623
B400.045	8412814119878	1	623
B400.046	8412814119885	1	623
B400.047	8412814119892	1	623
B400.048	8412814119908	1	623
B400.049	8412814119915	1	623
B400.050	8412814119922	1	623
B705.1/4.125	7314150281978	5	216
BAC007	7314150242337	1	313
BAHCO-1MW-1	7314150428045	1	436
BASIC	7314150437436	1	435
BB10	7314150240586	1	339
BB1200A	7314150170173	1	338
BBA12-1200	7314150254330	1	337
BBA1224-1700	7314150254347	1	337
BBA1224-3200	7314150341955	1	337
BBACCC12V	7314150430772	1	342
BBBC2A	7314150181520	1	341
BBBC4A	7314150181537	1	341
BBBCAB-AUZ	7314150183944	1	341
BBBCAB-EU	7314150186648	1	341
BBBCAB-UK	7314150183937	1	341
BBC420	7314150243235	1	339
BBC620	7314150243242	1	339
BBCE12-10	7314150330263	1	338
BBCE12-15S	7314150406722	2	338
BBCE12-3	7314150330249	2	338
BBCE12-6	7314150330256	2	338
BBCE12-F100	7314150344710	1	338
BBCE24-10	7314150330287	2	338
BBCE612-2	7314150330195	2	338
BBCEC1	7314150335459	1	341
BBCEC2	7314150337460	1	341
BB CER1	7314150335466	1	341
BB CER2	7314150337484	1	341
BBH12-1200	7314150360734	1	337
BBJL1630	7314150244898	5	338
BBJL2535	7314150209453	1	338
BBJL3545	7314150209460	1	338
BBR100	7314150345922	1	325
BBR110	7314150170562	1	325
BBR150I	7314150439119	24	328
BBR201P6	7314150205752	8	327
BBR201P64014	7314150237852	1	327
BBR201P64016	7314150237753	1	327
BBR201P64018	7314150237760	1	327
BBR201P67814	7314150237777	1	327
BBR201P67816	7314150237784	1	327
BBR201P67818	7314150237791	1	327
BBR202P4	7314150205769	1	328
BBR202P410	7314150207688	1	328
BBR202P414	7314150207695	1	328
BBR202P419	7314150207701	1	328
BBR202P455	7314150231393	1	328
BBR203P9	7314150208081	1	327
BBR203P920	7314150231102	1	327
BBR203P925	7314150231119	1	327
BBR203P927	7314150231126	1	327
BBR203P930	7314150231133	1	327
BBR203P940	7314150231140	1	327
BBR203P945	7314150231157	1	327
BBR203P950	7314150231164	1	327
BBR203P955	7314150231171	1	327
BBR203P960	7314150231188	1	327
BBR204	7314150430635	6	328
BBR210P3	7314150206056	1	328
BBR300P50	7314150269624	1	327
BBR320	7314150169887	1	327
BBR350	7314150169900	1	325
BBR400	7314150345939	1	326
BBR405	7314150435807	20	327
BBR410	7314150345946	24	326
BBR420	7314150403394	50	326
BBR501011	7314150438143	50	325
BBR50121314	7314150438150	50	325
BBR6131	7314150239443	1	328
BBR6135	7314150239450	1	328
BBRAS14	7314150416943	4	325
BBRAS14-01	7314150418060	1	326
BBRAS14-02	7314150418077	1	326
BBRAS14-03	7314150418084	1	326
BBRAS14-04	7314150418091	1	326
BBRAS14-05	7314150418107	1	326
BBRAS14-06	7314150418114	1	326
BBRAS14-07	7314150418121	1	326
BBRAS14-08	7314150418138	1	326
BBRAS14-09	7314150418145	1	326



BBRAS14-10



BBRAS14-10	7314150418152	1	326
BBRAS14-11	7314150418169	1	326
BBRAS14-12	7314150418176	1	326
BBRAS14-13	7314150418183	1	326
BBRAS14-14	7314150418190	1	326
BBRBB12	7314150371297	1	325
BBRFKM1	7314150384938	12	328
BBRPTG1	7314150412617	10	326
BBRS210P	7314150206070	1	328
BBRS210P2	7314150206063	1	328
BBS075	7314150249824	12	345
BBS100	7314150169870	1	349
BBS10001	7314150207183	1	349
BBS10002	7314150207190	1	349
BBS10003	7314150207206	1	349
BBS10004	7314150207213	1	349
BBS10005	7314150207220	1	349
BBS100057	7314150186655	1	349
BBS10006	7314150207237	1	349
BBS10007	7314150207244	1	349
BBS10008	7314150207251	1	349
BBS10009	7314150207268	1	349
BBS10010	7314150207275	1	349
BBS101	7314150243525	1	346
BBS102	7314150243518	1	346
BBS103	7314150243488	1	345
BBS10450	7314150243501	1	346
BBS105	7314150250868	1	346
BBS106	7314150243495	1	345
BBS107	7314150250875	1	346
BBS108	7314150250882	1	346
BBS12SH	7314150243563	1	347
BBS150	7314150169849	1	345
BBS150R	7314150244959	1	346
BBS150S	7314150244973	1	346
BBS150T	7314150244966	1	346
BBS165	7314150205615	10	346
BBS165SP4	7314150205622	50	346
BBS170P13	7314150205608	1	346
BBS170P131	7314150231843	1	346
BBS170P132	7314150231850	1	346
BBS170P133	7314150231867	1	346
BBS170P134	7314150231874	1	346
BBS170P135	7314150231881	1	346
BBS170P136	7314150231898	1	346
BBS170P137	7314150231904	1	346
BBS170P138	7314150231911	1	346
BBS170P139	7314150231928	1	346
BBS200	7314150239498	1	348
BBS20P12	7314150169856	1	349
BBS210	7314150215362	1	349
BBS210U06	7314150217656	1	349
BBS210U08	7314150217663	1	349
BBS210UA06	7314150217670	1	349
BBS210UA08	7314150217687	1	349
BBS210V06	7314150217632	1	349
BBS210V08	7314150217649	1	349
BBS210W06	7314150218738	1	349
BBS210W08	7314150218745	1	349
BBS3BH1	7314150356843	1	345
BBS3BH1-VP	7314150355501	40	345
BBS3UH	7314150242351	1	345
BBS50	7314150169863	1	344
BBS702026	7314150187416	15	341
BBS702028	7314150187423	1	341
BBSDA	7314150247127	1	348
BBSDC	7314150247158	6	348
BBSDD	7314150247165	1	348
BBSDH	7314150247141	1	348
BBSDHR	7314150249299	1	348
BBSDT	7314150247134	6	348
BBSDW	7314150247110	6	348
BBSH1F	7314150247189	1	347
BBSH1M	7314150247196	1	347
BBSH2C	7314150247202	1	347
BBSH2CA	7314150247219	12	347
BBSH2CP	7314150247226	6	347
BBSH2F	7314150247172	6	347
BBSH3CF	7314150247240	6	347
BBSH3CF30	7314150247264	6	347
BBSH3FS	7314150247257	6	347
BBSH3MF	7314150247233	1	347
BBSHWH1	7314150328932	1	347
BBSNL4FX001	7314150187492	1	342
BBSS1	7314150247288	1	348
BBSS2	7314150247271	8	348
BBSS2L	7314150247295	1	348
BBT20	7314150166961	1	339
BBT60A	7314150504169	36	339
BBT80	7314150327805	6	339
BCL31B1	7314150389704	1	293
BCL31C1	7314150389742	1	293
BCL31D1	7314150389582	1	291
BCL31D1K1	7314150400843	1	291
BCL31IS1	7314150389599	1	291
BCL31IS1K1	7314150400836	1	291



BCL31IW1	7314150389551	1	290
BCL31IW1K1	7314150400829	1	290
BCL31R1	7314150389568	1	290
BCL31R1K1	7314150400850	1	291
BCL31SD1	7314150389575	1	291
BCL31SD1K1	7314150402656	1	291
BCL32B1	7314150389711	1	293
BCL32DG1	7314150389605	1	292
BCL32DG1K1	7314150402670	1	292
BCL32G1	7314150389629	1	293
BCL32G1K1	7314150400911	1	292
BCL32IW1	7314150389643	1	290
BCL32IW1K1	7314150402663	1	290
BCL32RS1	7314150389636	1	292
BCL32RS1K1	7314150400904	1	292
BCL32SP1	7314150389612	1	292
BCL32SP1K1	7314150400898	1	292
BCL33AP1	7314150389650	1	292
BCL33AP1K1	7314150402687	1	292
BCL33B1	7314150389728	1	293
BCL33B3	7314150389735	1	293
BCL33C1	7314150389759	1	293
BCL33C2	7314150389766	1	293
BCL33D1	7314150389681	1	291
BCL33D1K1	7314150400881	1	291
BCL33IW1	7314150389667	1	290
BCL33IW1K1	7314150400867	1	290
BCL33IW2	7314150389674	1	290
BCL33IW2K1	7314150400874	1	290
BDACM1000	7314150500819	30	339
BE-3529	7314151847845	5	548
BE-6400M-4	7314153011145	5	192
BE-6400M-5	7314153011169	5	192
BE-6400M-5.5	7314153011176	5	192
BE-6400M-7	7314153011190	5	192
BE-6902	7314150242641	5	190
BE-6903	7314150242665	5	190
BE-6925	7314150242658	5	190
BE-6990-IP10	7314151846763	1	114
BE-6990-IP10-KL	7314151847531	10	115
BE-6990-IP15	7314151846770	1	114
BE-6990-IP15-KL	7314151847548	10	115
BE-6990-IP20-KL	7314151848668	10	115
BE-6990-IP6	7314151846725	1	114
BE-6990-IP6-KL	7314151847494	10	115
BE-6990-IP7	7314151846732	1	114
BE-6990-IP7-KL	7314151847500	10	115
BE-6990-IP8	7314151846749	1	114
BE-6990-IP8-KL	7314151847517	10	115
BE-6990-IP9	7314151846756	1	114
BE-6990-IP9-KL	7314151847524	10	115
BE-6990-IPSET	7314153019356	1	114
BE-6990TX-T10KL	7314151847760	10	115
BE-6990TX-T15KL	7314151847777	10	115
BE-6990TX-T20KL	7314151848682	10	115
BE-6990TX-T6-KL	7314151847722	10	115
BE-6990TX-T7-KL	7314151847739	10	115
BE-6990TX-T8-KL	7314151847746	10	115
BE-6990TX-T9-KL	7314151847753	10	115
BE-7515	7314150242528	5	190
BE-7520	7314150242535	5	190
BE-7525	7314150242542	5	190
BE-7527	7314150242559	5	190
BE-7530	7314150242566	5	190
BE-7540	7314150242573	5	190
BE-7606	7314151839017	5	192
BE-7607	7314151839024	5	192
BE-7608	7314151839031	5	192
BE-7675	7314150123896	1	228
BE-7715	7314150242580	5	190
BE-7720	7314150242597	5	190
BE-7725	7314150242603	5	190
BE-7727	7314150242610	5	190
BE-7730	7314150242627	5	190
BE-7740	7314150242634	5	190
BE-7803	7314151838867	5	192
BE-7804	7314151838881	5	192
BE-7805	7314151838904	5	192
BE-7806	7314151838928	5	192
BE-7806S	7314150242986	5	502
BE-7807	7314151838935	5	192
BE-7807S	7314150242993	5	502
BE-7808	7314151838942	5	192
BE-7808S	7314150243006	5	502
BE-7809	7314151838959	5	192
BE-7809S	7314150243013	5	502
BE-7810	7314151838966	5	192
BE-7810S	7314150243020	5	502
BE-7811	7314151838973	5	192
BE-7812	7314151838980	5	192
BE-7813	7314151838997	5	192
BE-7814	7314151839000	5	192
BE-7835	7314151838874	5	192
BE-7845	7314151838898	5	192
BE-7855	7314151838911	5	192
BE-7855S	7314150242979	5	502



BE-7907	7314153010964	5	190
BE-7908	7314153010971	5	190
BE-7909	7314153010988	5	190
BE-7910	7314151838799	5	190
BE-7915	7314151838805	5	190
BE-7920	7314151838812	5	190
BE-7925	7314151838829	5	190
BE-7927	7314151838836	5	190
BE-7930	7314151838843	5	190
BE-7940	7314151838850	5	190
BE-8002	7314150242825	5	188
BE-8010	7314150010615	5	188
BE-8010S	7314150033058	5	502
BE-8020	7314150010639	5	188
BE-8020I	7314150270316	5	540
BE-8020L	7314151838591	5	188
BE-8022	7314150242474	5	188
BE-8030	7314150010653	5	188
BE-8030I	7314150270330	5	540
BE-8040	7314150010677	5	188
BE-8040I	7314150270347	5	540
BE-8040S	7314150033089	5	502
BE-8040SL	7314150304578	10	504
BE-8050S	7314150033096	5	502
BE-8050SL	7314150304592	10	504
BE-8065S	7314150033119	5	502
BE-8080-1	7314153010995	5	191
BE-8080-10	7314153011060	5	191
BE-8080-2	7314153011008	5	191
BE-8080-3	7314153011015	5	191
BE-8080-4	7314153011022	5	191
BE-8080-5	7314153011039	5	191
BE-8080-6	7314153011046	5	191
BE-8080-8	7314153011053	5	191
BE-8135TB	7314150275052	10	198
BE-8145TB	7314150275076	10	198
BE-8150	7314150010707	5	188
BE-8150TB	7314150275113	10	198
BE-8155	7314150010721	5	188
BE-8155TB	7314150275090	5	198
BE-8158	7314153010858	5	188
BE-8159	7314153010865	5	188
BE-8160	7314150010745	5	188
BE-8210	7314151838584	5	188
BE-8220	7314150047741	5	188
BE-8220S	7314150048243	5	502
BE-8220SL	7314150304530	10	504
BE-8225	7314150242443	5	188
BE-8230	7314150047758	5	188
BE-8230S	7314150048250	5	502
BE-8230SL	7314150304554	10	504
BE-8235	7314150242450	5	188
BE-8240	7314150047765	5	188
BE-8241	7314150242467	5	188
BE-8241I	7314150270866	5	540
BE-8242	7314153010803	5	188
BE-8250	7314150047772	5	188
BE-8250L	7314151838607	5	188
BE-8251	7314150242481	5	188
BE-8252	7314153010810	5	188
BE-8252I	7314150270361	5	540
BE-8255	7314150047789	5	188
BE-8255S	7314150048281	5	502
BE-8255SL	7314150304615	10	504
BE-8256	7314153010827	5	188
BE-8256TB	7314150275137	10	198
BE-8257	7314153010834	5	188
BE-8258	7314153010841	5	188
BE-8258S	7314150242818	5	502
BE-8258TB	7314150275151	10	198
BE-8259S	7314150242832	5	502
BE-8260	7314150047796	5	188
BE-8262TB	7314150275526	10	198
BE-8330	7314151838614	5	188
BE-8340	7314151838621	5	188
BE-8350	7314151838638	5	188
BE-8355	7314151838652	5	188
BE-8360	7314151838676	5	188
BE-8450	7314151838645	5	188
BE-8455	7314151838669	5	188
BE-8510S	7314150126507	5	502
BE-8510SL	7314150304813	10	504
BE-8520S	7314150126514	5	502
BE-8520SL	7314150304837	10	504
BE-8571	7314150244652	1	197
BE-8572	7314150244669	1	197
BE-8573	7314150244676	1	198
BE-8574	7314150258666	1	198
BE-8575	7314150244638	1	195
BE-8576	7314150245741	1	198
BE-8577	7314151839048	5	195
BE-8600	7314150010769	5	188
BE-8600I	7314150270378	5	540
BE-8600S	7314150033126	5	502
BE-8601	7314151838706	5	189
BE-8602	7314151838713	5	189



BE-8605	7314150242498	5	188
BE-8608	7314150242504	5	188
BE-8610	7314150010776	5	188
BE-8610I	7314150270392	5	540
BE-8610L	7314151838683	5	188
BE-8610S	7314150033133	5	502
BE-8610SL	7314150304639	10	504
BE-8610TB	7314150275199	10	199
BE-8611	7311518292317	5	188
BE-8611S	7314150414703	5	502
BE-8612S	7314150242856	5	502
BE-8620	7314150010783	5	189
BE-8620I	7314150270408	5	540
BE-8620L	7314151838690	5	189
BE-8620S	7314150033140	5	502
BE-8620SL	7314150304653	10	504
BE-8620TB	7314150275212	10	199
BE-8621	7311518292324	5	189
BE-8621S	7314150242863	5	502
BE-8622	7314150242511	5	189
BE-8622S	7314150242870	5	502
BE-8623	7314153010872	5	189
BE-8623I	7314150270415	5	540
BE-8623TB	7314150275236	10	199
BE-8624	7314153010889	5	189
BE-8624TB	7314150275250	10	199
BE-8628	7314153010896	5	189
BE-8629	7314153010902	5	189
BE-8630	7314150010790	5	189
BE-8630S	7314150033157	5	502
BE-8640	7314150010806	5	189
BE-8640S	7314150033164	5	502
BE-8675	7314150123872	1	228
BE-8700-1/4	7314150242689	5	191
BE-8700-3/16	7314150242696	5	191
BE-8700-3/8	7314150242702	5	191
BE-8700-5/16	7314150242719	5	191
BE-8700-5/32	7314150242726	5	191
BE-8700-7/32	7314150242733	5	191
BE-8700-7/64	7314150275878	5	191
BE-8702	7314151838768	5	191
BE-8703	7314150027651	5	191
BE-8703S	7314151839130	5	502
BE-8704	7314150027668	5	191
BE-8704S	7314151839147	5	502
BE-8705	7314150027675	5	191
BE-8705S	7314151839154	5	502
BE-8706	7314150027682	5	191
BE-8706S	7314151839161	5	502
BE-8708	7314150027699	5	191
BE-8708S	7314151839178	5	502
BE-8710	7314150027705	5	191
BE-8710S	7314150126521	5	502
BE-8710SL	7314150304851	10	504
BE-8715	7314150242672	5	191
BE-8720S	7314150126538	5	502
BE-8720SL	7314150304875	10	504
BE-8725	7314151838775	5	191
BE-8725S	7314151839123	5	502
BE-8800	7314150042012	5	189
BE-8800I	7314150270422	5	540
BE-8800S	7314151839055	5	502
BE-8801	7314151838744	5	189
BE-8802	7314151838751	5	189
BE-8810	7314150010813	5	189
BE-8810I	7314150270439	5	540
BE-8810L	7314151838720	5	189
BE-8810S	7314150048298	5	502
BE-8810SL	7314150304677	10	504
BE-8810TB	7314150275274	10	199
BE-8811	7311518292331	5	189
BE-8811S	7314150414710	5	502
BE-8812S	7314150242894	5	502
BE-8820	7314150010820	5	189
BE-8820I	7314150270446	5	540
BE-8820L	7314151838737	5	189
BE-8820S	7314150048304	5	502
BE-8820SL	7314150304691	10	504
BE-8820TB	7314150275298	10	199
BE-8821	7311518292348	5	189
BE-8821S	7314150242900	5	502
BE-8822S	7314150242917	5	502
BE-8823	7314153010919	5	189
BE-8823I	7314150270453	5	540
BE-8823TB	7314150275311	10	199
BE-8824	7314153010926	5	189
BE-8824TB	7314150275335	10	199
BE-8828	7314153010933	5	189
BE-8829	7314153010940	5	189
BE-8830	7314150010837	5	189
BE-8830S	7314150048311	5	502
BE-8840	7314150010844	5	189
BE-8840S	7314151839062	5	502
BE-8865	7314150010851	5	188
BE-8870	7314150010875	5	188
BE-8880	7314150010899	5	188





BE-8890	7314150010905	5	188
BE-8904	7314153010957	5	190
BE-8905	7314153010049	5	190
BE-8905S	7314150242924	5	502
BE-8906	7314150027729	5	190
BE-8906S	7314150242931	5	502
BE-8907	7314150027736	5	190
BE-8907S	7314150242948	5	502
BE-8908	7314150027743	5	190
BE-8908S	7314150242955	5	502
BE-8909	7314150027750	5	190
BE-8909S	7314150242962	5	502
BE-8910	7314150027767	5	190
BE-8910I	7314150270460	5	540
BE-8910S	7314151839079	5	502
BE-8910SL	7314150304714	5	504
BE-8910TB	7314150275359	5	199
BE-8915	7314150027774	5	190
BE-8915I	7314150270477	5	540
BE-8915S	7314151839086	5	502
BE-8915SL	7314150304738	5	504
BE-8915TB	7314150275373	5	199
BE-8920	7314150027781	5	190
BE-8920I	7314150270484	5	540
BE-8920S	7314151839093	5	502
BE-8920SL	7314150304752	5	504
BE-8920TB	7314150275397	5	199
BE-8925	7314150027798	5	190
BE-8925I	7314150270491	5	540
BE-8925S	7314151839109	5	502
BE-8925SL	7314150304776	5	504
BE-8925TB	7314150275410	5	199
BE-8927	7314150027804	5	190
BE-8927TB	7314150275434	5	199
BE-8930	7314150027811	5	190
BE-8930S	7314151839116	5	502
BE-8930SL	7314150304790	5	504
BE-8930TB	7314150275458	5	199
BE-8940	7314150027828	5	190
BE-8940TB	7314150275472	5	199
BE-8945	7314151838782	5	190
BE-8975	7314150056576	6	227
BE-8975B	7314150188741	6	227
BE-8976B	7314150216369	6	228
BE-8980	7314153010681	5	192
BE-8985	7314153010698	5	191
BE-8986	7314150267026	5	192
BE-9001	7311518269005	5	191
BE-9002	7311518269012	5	191
BE-9003	7311518269029	5	191
BE-9100	7314150242757	5	191
BE-9101	7314150242764	5	191
BE-9102	7314150242771	5	191
BE-9103	7314150242788	5	191
BE-9104	7314150242795	5	191
BE-9105	7314150242801	5	191
BE-9575	7314150123841	1	227
BE-9578	7314150123803	1	224
BE-9585	7314150123858	1	227
BE-9586	7314150216000	1	224
BE-9588	7314150123810	1	225
BE-9675	7314150123889	1	227
BE-9676	7314150216017	1	225
BE-9678	7314150123827	1	225
BE-9688	7314150123834	1	225
BE-9765	7314150055128	3	225
BE-9770	7314150027712	3	225
BE-9770I	7314150276332	20	541
BE-9775	7314150056330	3	226
BE-9776	7314150056545	6	224
BE-9776B	7314150216352	6	225
BE-9777	7314150056552	6	224
BE-9777B	7314150188734	6	224
BE-9780	7314150033386	3	226
BE-9785	7314150056347	3	226
BE-9785I	7314150276349	1	540
BE-9786I	7314150314485	1	541
BE-9787	7314150056569	6	224
BE-9871	7314150234707	1	194
BE-9871SL	7314150470792	1	505
BE-9872	7314150440412	1	194
BE-9872SL	7314150470785	1	505
BE-9875	7314150314447	1	194
BE-9876S	7314150315000	1	504
BE-9877	7314150320745	1	195
BE-9878	7314150186259	1	222
BE-9878SL	7314150321018	1	505
BE-9879	7314150383474	1	194
BE-9880	7314150238569	3	223
BE-9880SL	7314150337651	1	505
BE-9881	7314150043279	1	193
BE-9881I	7314150270507	1	540
BE-9881S	7314151839307	1	503
BE-9881SL	7314150304899	1	505
BE-9881TB	7314150275502	1	199
BE-9882	7314151839284	1	193



BE-9882I	7314150270514	1	540
BE-9882S	7314151839314	1	503
BE-9882SL	7314150304912	1	505
BE-9882TB	7314150275496	1	199
BE-9884	7314150243068	1	193
BE-9884S	7314150236602	1	503
BE-9885	7314150048465	1	193
BE-9885S	7314150126491	1	503
BE-9885TB	7314150275519	1	200
BE-9886	7314150048472	1	193
BE-9887S	7314150244744	1	503
BE-9888S	7314153006158	1	503
BE-9889S	7314150244751	1	503
BE-9890S	7314150237715	1	503
BE-9890SL	7314150315086	1	504
BE-9891SL	7314150321506	1	504
BE-9894SL	7314150321490	1	505
BE100	7314150177912	1	306
BE1100	7314150205929	8	309
BE110001	7314150230228	1	309
BE110014	7314150230204	1	308
BE110015	7314150230211	1	308
BE1100AC1	7314150230266	1	308
BE1100AC2	7314150333394	1	308
BE1200P6	7314150205516	1	307
BE1200P6AC1	7314150205523	1	307
BE1205	7314150205554	1	306
BE1210P11	7314150209101	1	307
BE1210P1101	7314150269822	1	306
BE1210P1102	7314150269839	1	306
BE1210P1103	7314150269846	1	306
BE1210P9AC1	7314150205547	1	307
BE1300	7314150205578	1	305
BE1300SH	7314150205585	10	305
BE1305P450	7314150206032	1	305
BE1305P450WS01	7314150269228	1	305
BE1305P450WS02	7314150269235	1	305
BE1305P450WS03	7314150269242	1	305
BE1305P450WS04	7314150269327	1	305
BE1305P450WS05	7314150269334	1	305
BE1305P450WS06	7314150269341	1	305
BE1305P450WS07	7314150269358	1	305
BE1305P450WS08	7314150269365	1	305
BE1305P450WS09	7314150269372	1	305
BE1305P450WS10	7314150269310	1	305
BE1305P450WS11	7314150269389	1	305
BE1305P450WS12	7314150269396	1	305
BE1305P450WS13	7314150269402	1	305
BE1305P450WS14	7314150269419	1	305
BE1305P450WS15	7314150269426	1	305
BE1310DNS	7314150403240	12	305
BE1310P4	7314150205707	1	304
BE1310P425	7314150233649	1	304
BE1310P427	7314150233656	1	304
BE1310P429	7314150233663	1	304
BE1310P430	7314150233670	1	304
BE1311P13	7314150235414	1	304
BE1312DNS	7314150450596	12	305
BE1315P7	7314150205776	1	305
BE1315P71	7314150230273	1	305
BE1315P72	7314150230280	1	305
BE1315P73	7314150230297	1	305
BE1315P74	7314150230303	1	305
BE1315P75	7314150230310	1	305
BE1315P76	7314150230327	1	305
BE1315P77	7314150230334	1	305
BE1320S17	7314150415366	10	304
BE13ZL11	7314150239733	1	306
BE1FFWF	7314150403325	12	315
BE1FLD1	7314150250745	1	315
BE1FLD2	7314150250752	1	315
BE1FLD3	7314150250769	1	315
BE1FLDS	7314150250783	1	315
BE1FTW	7314150251209	1	315
BE1GP5	7314150170043	1	306
BE1GP5-T	7314150170050	10	307
BE1GP510	7314150207732	1	307
BE1GP512	7314150207749	1	307
BE1GP514	7314150207756	1	307
BE1GP58	7314150207718	1	307
BE1GP59	7314150207725	1	307
BE1P	7314150170067	1	307
BE1SP14L	7314150170074	1	308
BE1SP16F	7314150492756	10	308
BE1SP1F	7314150435777	12	307
BE1T14	7314150167630	1	308
BE1T16	7314150167647	1	308
BE1T21	7314150167654	1	308
BE1TH-10	7314150343980	5	316
BE1TH-12	7314150343997	5	316
BE1TH-14	7314150344000	5	316
BE1TH-2	7314150343874	10	316
BE1TH-2.5	7314150343881	10	316
BE1TH-3	7314150343898	10	316
BE1TH-3.5	7314150343904	10	316
BE1TH-4	7314150343911	10	316



BE1TH-4.5	7314150343928	10	316
BE1TH-5	7314150343935	10	316
BE1TH-6	7314150343942	10	316
BE1TH-7	7314150343959	10	316
BE1TH-8	7314150343966	10	316
BE1TH-9	7314150343973	10	316
BE1TH-S5	7314150457502	1	316
BE1TH-S6	7314150344017	30	316
BE1TS-10	7314150344062	10	316
BE1TS-11	7314150344079	10	316
BE1TS-12	7314150344086	10	316
BE1TS-13	7314150344093	10	316
BE1TS-14	7314150344109	10	316
BE1TS-15	7314150344116	10	316
BE1TS-16	7314150344123	10	316
BE1TS-17	7314150344130	10	316
BE1TS-18	7314150344147	10	316
BE1TS-19	7314150344154	10	316
BE1TS-20	7314150344161	8	316
BE1TS-21	7314150344178	8	316
BE1TS-22	7314150344185	8	316
BE1TS-24	7314150344192	8	316
BE1TS-6	7314150344024	10	316
BE1TS-7	7314150344031	10	316
BE1TS-8	7314150344048	10	316
BE1TS-9	7314150344055	10	316
BE1TS-S7	7314150344208	1	316
BE200CAB250SH10	7314150165452	1	362
BE200CAB250SH25	7314150165469	1	362
BE200CAB250SH3	7314150165445	1	362
BE200CAB40F1	7314150165391	1	362
BE200CAB55F1	7314150165407	1	362
BE200CAB55F3	7314150165414	1	362
BE200CAB58SR1	7314150165421	1	362
BE200CAB58SR3	7314150165438	1	362
BE200CAB80SR1	7314150165384	1	362
BE200CAB80SR3	7314150165476	1	362
BE200MAG4	7314150245192	1	362
BE200MAG55	7314150165513	1	362
BE200MAG80	7314150165551	1	362
BE200MIR4035	7314150245161	1	362
BE200MIR4045	7314150245178	1	362
BE200MIR4055	7314150245185	1	362
BE200MIR5535	7314150165483	1	362
BE200MIR5545	7314150165490	1	362
BE200MIR5555	7314150165506	1	362
BE200MIR8035	7314150165520	1	362
BE200MIR8045	7314150165537	1	362
BE200MIR8055	7314150165544	1	362
BE210	7314150165155	1	362
BE220	7314150170005	1	362
BE230	7314150182633	1	303
BE239	7314150243143	1	303
BE240	7314150239917	1	303
BE240-CAT	7314150289417	1	303
BE250	7314150169924	1	314
BE251	7314150239429	1	314
BE251200	7314150249343	1	334
BE2512005	7314150249350	1	334
BE2512008	7314150249367	1	334
BE253	7314150250806	1	314
BE2541	7314150251797	1	314
BE2542	7314150251803	1	314
BE254A	7314150446070	1	314
BE254A-01	7314150453405	1	314
BE256-155	7314150205875	1	315
BE256-178	7314150205882	1	315
BE256-250	7314150205899	1	315
BE256M	7314150205851	1	314
BE256P3	7314150205868	1	315
BE257	7314150205844	8	304
BE25710	7314150230549	1	304
BE25718	7314150230532	1	304
BE2572	7314150230556	1	304
BE2576	7314150230525	1	304
BE258	7314150251780	1	314
BE301	7314150430871	2	336
BE301CM	7314150430888	50	336
BE301CM-01	7314150430956	20	336
BE301CM-02	7314150430963	20	336
BE310	7314150205943	8	336
BE400P24	7314150205806	1	310
BE400P2401	7314150230600	1	310
BE400P2402	7314150230617	1	310
BE400P2403	7314150230624	1	310
BE400P2404	7314150230631	1	310
BE400P2405	7314150230648	1	311
BE400P2406	7314150230655	1	311
BE400P2407	7314150230662	1	311
BE400P2408	7314150230679	1	311
BE400P2409	7314150230686	1	311
BE400P241	7314150230563	1	310
BE400P2410	7314150230693	1	311
BE400P2411	7314150230709	1	311
BE400P2412	7314150230716	1	311
BE400P2413	7314150230723	1	311



BE400P2414	7314150230730	1	312
BE400P2415	7314150230747	1	312
BE400P2416	7314150230754	1	312
BE400P2417	7314150230761	1	312
BE400P2418	7314150230778	1	312
BE400P2419	7314150230785	1	312
BE400P242	7314150230570	1	310
BE400P2420	7314150237647	1	312
BE400P243	7314150230587	1	310
BE400P244	7314150230594	1	310
BE401	7314150240593	1	309
BE410	7314150205813	4	312
BE4101	7314150230792	1	312
BE5008	7314150239344	1	306
BE5008-10	7314150239269	1	306
BE5008-15	7314150239276	1	306
BE5008-20	7314150239283	1	306
BE5008-25	7314150239290	1	306
BE5008-27	7314150239306	1	306
BE5008-30	7314150239313	1	306
BE5008-40	7314150239320	1	306
BE5008-45	7314150239337	1	306
BE500P24	7314150169955	5	303
BE500P2401	7314150209569	1	303
BE500P2402	7314150209682	1	303
BE500P2403	7314150209736	1	303
BE500P2404	7314150209729	1	303
BE500P2405	7314150209613	1	303
BE500P2406	7314150209804	1	303
BE500P2407	7314150209781	1	303
BE500P2408	7314150209743	1	303
BE500P2409	7314150209750	1	303
BE500P2410	7314150209637	1	303
BE500P2411	7314150209644	1	303
BE500P2412	7314150209699	1	303
BE500P2413	7314150209705	1	303
BE500P2414	7314150209798	1	303
BE500P2415	7314150209675	1	303
BE500P2416	7314150209620	1	303
BE500P2417	7314150209583	1	303
BE500P2418	7314150209576	1	303
BE500P2419	7314150209590	1	303
BE500P2420	7314150209606	1	303
BE500P2421	7314150209774	1	303
BE500P2422	7314150209668	1	303
BE500P2423	7314150209712	1	303
BE500P2424	7314150209712	1	303
BE501101	7314150274499	1	296
BE501102	7314150274505	1	296
BE501203	7314150274529	1	296
BE501204	7314150274536	1	296
BE502101	7314150274543	1	296
BE502102	7314150274550	1	297
BE502103	7314150274567	1	297
BE502104	7314150384952	8	296
BE502106	7314150403370	10	296
BE502204	7314150274574	1	297
BE5032	7314150189885	1	313
BE503201	7314150274581	1	297
BE5032H10EL	7314150220953	1	318
BE5032H14	7314150220960	1	317
BE5032M14	7314150220977	1	317
BE5032SQ10	7314150220991	1	313
BE5032SQ8	7314150220984	1	313
BE5032T55EL	7314150220946	1	318
BE504102	7314150274666	1	297
BE504201	7314150274369	1	297
BE5049	7314150169931	5	317
BE504901	7314150184576	1	317
BE504902	7314150184583	1	318
BE5049H10	7314150184705	1	317
BE5049H10L	7314150184712	1	318
BE5049H12	7314150184729	1	317
BE5049H12L	7314150184736	1	318
BE5049H4	7314150184590	1	317
BE5049H4L	7314150184606	1	318
BE5049H5	7314150184613	1	317
BE5049H5L	7314150184620	1	318
BE5049H6	7314150184637	1	317
BE5049H6L	7314150184651	1	318
BE5049H7	7314150184668	1	317
BE5049H7L	7314150184675	1	318
BE5049H8	7314150184682	1	317
BE5049H8L	7314150184699	1	318
BE5049M10	7314150184804	1	317
BE5049M10L	7314150184811	1	318
BE5049M12	7314150184828	1	317
BE5049M12L	7314150184835	1	318
BE5049M5	7314150184743	1	317
BE5049M5L	7314150184750	1	318
BE5049M6	7314150184767	1	317
BE5049M6L	7314150184774	1	318
BE5049M8	7314150184781	1	317
BE5049M8L	7314150184798	1	318
BE5049T	7314150325474	1	318
BE5049T20	7314150216048	1	317



BE5049T20H



BE5049T20H	7314150184842	1	317
BE5049T20HL	7314150184859	1	318
BE5049T20L	7314150221011	1	318
BE5049T25	7314150216055	1	317
BE5049T25H	7314150184866	1	317
BE5049T25HL	7314150184873	1	318
BE5049T25L	7314150221028	1	318
BE5049T27	7314150216062	1	317
BE5049T27H	7314150184880	1	317
BE5049T27HL	7314150184897	1	318
BE5049T27L	7314150221035	1	318
BE5049T30	7314150216079	1	317
BE5049T30H	7314150184903	1	317
BE5049T30HL	7314150184910	1	318
BE5049T30HXL	7314150184927	1	318
BE5049T30L	7314150221042	1	318
BE5049T40	7314150216086	1	317
BE5049T40H	7314150184934	1	317
BE5049T40HL	7314150184941	1	318
BE5049T40HXL	7314150185092	1	318
BE5049T40L	7314150221059	1	318
BE5049T45	7314150216093	1	317
BE5049T45H	7314150184958	1	318
BE5049T45HL	7314150184965	1	318
BE5049T45HXL	7314150184972	1	318
BE5049T45L	7314150216123	1	318
BE5049T50	7314150216109	1	317
BE5049T50H	7314150184989	1	317
BE5049T50HL	7314150184996	1	318
BE5049T50L	7314150221066	1	318
BE5049T55	7314150216116	1	317
BE5049T55H	7314150185009	1	317
BE5049T55HL	7314150185016	1	318
BE5049T55L	7314150221073	1	318
BE5049T60	7314150221004	1	317
BE5049T60H	7314150185023	1	317
BE5049T60HL	7314150185030	1	318
BE5049T60L	7314150185047	1	318
BE5049T80HL	7314150186532	1	318
BE505101	7314150274598	1	298
BE505102	7314150274604	1	298
BE505203	7314150274611	1	298
BE505204	7314150274628	1	298
BE506101	7314150274376	1	298
BE506102	7314150274635	1	298
BE506103	7314150274642	1	299
BE506204	7314150274659	1	299
BE507101	7314150274673	1	299
BE507102	7314150274680	1	299
BE507203	7314150274697	1	299
BE508101	7314150274765	1	300
BE508202	7314150274772	1	300
BE508203	7314150274703	1	300
BE508204	7314150274710	1	300
BE509101	7314150274727	1	300
BE509102	7314150274734	1	300
BE509103	7314150274383	1	301
BE509104	7314150274741	1	301
BE509205	7314150274390	1	301
BE509206	7314150274406	1	301
BE509207	7314150274758	1	301
BE5100	7314150205646	1	303
BE5101	7314150205721	1	303
BE510101	7314150274420	1	301
BE510102	7314150274437	1	301
BE510125	7314150230877	1	313
BE510127	7314150230884	1	313
BE510130	7314150230891	1	313
BE510140	7314150230907	1	313
BE510145	7314150230914	1	313
BE510150	7314150230921	1	313
BE510155	7314150230938	1	313
BE510160	7314150230945	1	313
BE5102	7314150205738	1	308
BE510203	7314150274789	1	302
BE510210	7314150231003	1	308
BE510211	7314150231010	1	308
BE510212	7314150231027	1	308
BE510213	7314150231034	1	308
BE51025	7314150230952	1	308
BE51026	7314150230969	1	308
BE51027	7314150230976	1	308
BE51028	7314150230983	1	308
BE51029	7314150230990	1	308
BE5103	7314150205745	1	308
BE510304	7314150274444	1	302
BE510310	7314150231072	1	308
BE510312	7314150231089	1	308
BE510314	7314150231096	1	308
BE51035	7314150231041	1	308
BE51036	7314150231058	1	308
BE51038	7314150231065	1	308
BE511101	7314150274451	1	302
BE511102	7314150274468	1	302
BE511203	7314150274796	1	302
BE512201	7314150274475	1	304



BE513201	7314150274802	1	302
BE5150P27	7314150205790	1	313
BE5150P271	7314150230808	1	313
BE5150P272	7314150230815	1	313
BE5150P273	7314150230822	1	313
BE5200	7314150205905	1	317
BE52001	7314150230433	1	317
BE52002	7314150230440	1	317
BE52003	7314150230457	1	317
BE523106	7314150178391	1	302
BE530001	7314150205912	1	317
BE5350	7314150206049	5	306
BE5350C1	7314150230389	1	306
BE5350C2	7314150230396	1	306
BE5350C3	7314150230402	1	306
BE5350C4	7314150230419	1	306
BE5350C5	7314150230426	1	306
BE5400P	7314150245086	1	303
BE5401D	7314150245062	1	303
BE5500	7314150403233	25	315
BE550010	7314150432936	1	315
BE550011	7314150432943	1	315
BE550012	7314150432950	1	315
BE550014	7314150432967	1	315
BE550017	7314150432974	1	315
BE550019	7314150432981	1	315
BE61110	7314150167449	12	319
BE61110-1	7314150167463	100	319
BE61155	7314150167456	12	319
BE61155-1	7314150167470	1	319
BE62110	7314150403332	10	320
BE62155	7314150403349	10	320
BE6217	7314150169702	1	321
BE621701	7314150232642	1	321
BE621702	7314150232659	1	321
BE621703	7314150232666	1	321
BE621704	7314150232673	1	321
BE621705	7314150232680	1	321
BE621706	7314150232697	1	321
BE621707	7314150232703	1	321
BE621708	7314150232710	1	321
BE621709	7314150232727	1	321
BE621710	7314150232734	1	321
BE621711	7314150232741	1	321
BE621712	7314150232758	1	321
BE621713	7314150232765	1	321
BE621714	7314150232772	1	321
BE621715	7314150232789	1	321
BE621716	7314150232796	1	321
BE621717	7314150232802	1	321
BE630	7314150169580	3	320
BE63010015F	7314150232598	25	320
BE63010615F	7314150232604	1	320
BE63010815F	7314150232611	1	320
BE63010818F	7314150232628	1	321
BE630246F	7314150169597	50	320
BE6302712F	7314150412846	5	321
BE630276F	7314150169603	50	320
BE630326F	7314150169610	50	321
BE630366F	7314150169627	100	320
BE630386F	7314150169634	50	321
BE63064514F1	7314150340095	1	321
BE63064514F2	7314150340101	1	321
BE6306514F	7314150232123	12	320
BE630656714F	7314150232130	12	320
BE63066514F	7314150169641	25	321
BE630666F	7314150232116	1	320
BE6306814F	7314150232154	1	320
BE6307314F	7314150232161	1	320
BE6307414F	7314150370108	10	321
BE6307415F	7314150232178	1	320
BE630747615F	7314150232307	12	320
BE630757715F	7314150232321	1	320
BE6307612F	7314150232345	12	320
BE6307614F	7314150232369	12	320
BE6307630F	7314150232437	1	320
BE630768F	7314150232468	1	320
BE6307815F	7314150232475	12	320
BE6308015F	7314150232482	1	320
BE630808215F	7314150232499	1	320
BE6308616F	7314150232505	1	320
BE6308618F	7314150232512	1	320
BE6309015F	7314150232529	1	320
BE6309210F	7314150232536	1	320
BE6309315F	7314150232543	1	320
BE6309336F	7314150232550	1	320
BE6309345F	7314150232567	1	320
BE6309515F	7314150232574	1	320
BE6309618F	7314150232581	1	320
BE64350	7314150169672	1	320
BE64350CH	7314150169696	1	320
BE64520	7314150169665	1	320
BE64520CH	7314150169689	1	320
BE65F65120	7314150169658	12	320
BE65R106160	7314150170036	1	320
BE65R65120	7314150170012	1	320



BE65R80120	7314150170029	1	320
BE66152A	7314150492534	6	320
BE6701VAG	7314150333875	1	321
BE68	7314150237876	1	321
BE6810	7314150237869	1	321
BE6810Z	7314150430765	12	321
BE6FCP	7314150438907	30	315
BE6OF108	7314150434572	50	319
BE6OFW	7314150435784	5	319
BE700	7314150206087	1	312
BE700BP2	7314150206100	1	312
BE700SP15	7314150206094	1	312
BE74-55100	7314150169733	1	309
BE74-57125	7314150169511	1	309
BE74-57125L	7314150169535	1	309
BE74-80120	7314150169740	1	309
BE74-90175	7314150169528	1	309
BE76101	7314150240005	1	305
BE762	7314150384983	12	305
BE800P12	7314150205677	1	313
BELMS12OBDL	7314150340323	8	337
BELP1224	7314150177882	1	341
BELS12	7314150170579	1	340
BELT10	7314150170623	1	319
BELT1213A	7314150493104	20	340
BELT127	7314150177899	1	340
BELT2415A	7314150493098	20	340
BELT247N	7314150170586	1	340
BELT247S	7314150170593	1	340
BELTKEY	7314150177875	1	339
BELTRP16	7314150169917	1	340
BELTRP1601	7314150231935	1	340
BELTRP1602	7314150231942	1	340
BELTRP1603	7314150231959	1	340
BELTRP1604	7314150231966	1	340
BELTRP1605	7314150231973	1	340
BELTRP1606	7314150231980	1	340
BELTRP1607	7314150231997	1	340
BELTRP1608	7314150232000	1	340
BELTRP1609	7314150232017	1	340
BELTRP1610	7314150232024	1	340
BELTRP1611	7314150232031	1	340
BELTRP1612	7314150232048	1	340
BELTRP1613	7314150232062	1	340
BELTRP1614	7314150232079	1	340
BELTRP1615	7314150232086	1	340
BELTRP1616	7314150232093	1	340
BFRL11	7314150306534	1	360
BGIS125	7314150416431	20	340
BH110000A-02	7314150273669	1	352
BH110000A-04	7314150273683	1	352
BH110000A-EXT	7314150291946	1	352
BH110000B	7314150516414	1	352
BH11500	7314150178797	1	351
BH11500-01	7314150182220	1	357
BH11500-02	7314150182237	1	352
BH11500-04	7314150182275	1	352
BH12000	7314150178803	1	351
BH13000	7314150178810	1	351
BH13000-02	7314150182244	1	352
BH13000L	7314150301980	1	352
BH13000L-01	7314150301997	1	357
BH13000QA	7314150403295	1	352
BH15000A-01	7314150273515	1	357
BH15000A-02	7314150273522	1	352
BH15000A-04	7314150273546	1	352
BH15000A-EXT	7314150291939	1	352
BH15000B	7314150516407	1	352
BH1A1500-04	7314150265299	1	357
BH1A1500A	7314150460946	1	351
BH1A1500A-05	7314150477302	40	352
BH1A2500-03	7314150226856	1	352
BH1A2500-04	7314150226863	1	357
BH1A2500A	7314150460953	1	351
BH1CB1000	7314150243204	1	352
BH1CD680	7314150330379	1	355
BH1CD680ST	7314150330386	1	355
BH1EU3000	7314150245000	1	351
BH1EU3000-01	7314150250004	1	352
BH1EU3000-03	7314150249893	1	352
BH1EU3000-08	7314150249947	1	357
BH1M1000	7314150237845	1	351
BH1S45	7314150292295	1	352
BH1S45-01	7314150311194	1	357
BH1S45-03	7314150311217	1	352
BH230	7314150264070	1	353
BH23015	7314150178759	1	353
BH23015C	7314150178742	1	353
BH2402010	7314150178766	1	353
BH2604020	7314150178773	1	354
BH28050	7314150472222	1	354
BH2AC1	7314150213474	1	354
BH2AC2	7314150213481	1	354
BH2AC60-140	7314150168958	1	354
BH2AC60V110	7314150178933	1	354
BH33000	7314150178674	1	354



BH36000	7314150178681	1	354
BH3A10000	7314150234660	1	354
BH3A3000	7314150234646	1	354
BH3A5000	7314150234653	1	354
BH3AL2500	7314150302420	1	354
BH3HD12000	7314150170500	1	355
BH3HD16000	7314150170524	1	355
BH3HD20000A	7314150337668	1	355
BH3HD8000	7314150170494	2	354
BH3SQ15000	7314150234684	2	354
BH3SQ7000	7314150234677	2	354
BH410	7314150178711	1	351
BH415	7314150178728	2	351
BH42	7314150178698	1	350
BH420	7314150178735	1	351
BH430	7314150178780	2	351
BH45	7314150178704	1	350
BH4HP50	7314150477081	1	351
BH4S12	7314150237920	3	350
BH4S2	7314150237883	6	350
BH4S20	7314150237937	1	350
BH4S4	7314150237890	6	350
BH4S50	7314150476879	1	350
BH4S6	7314150237906	4	350
BH4S8	7314150237913	4	350
BH5DP1000QA	7314150270224	1	355
BH5SP500QA	7314150270217	1	355
BH5US1000	7314150243174	1	355
BH6AC1-680A	7314150433544	1	356
BH6FC1000	7314150178650	1	356
BH6FC2000	7314150234639	1	356
BH6PC600	7314150234622	1	356
BH7100A	7314150345908	1	342
BH7100SG	7314150299782	1	343
BH715	7314150237555	1	342
BH715-13	7314150239191	1	342
BH720	7314150235650	1	342
BH720-22	7314150236961	1	342
BH720SG	7314150238477	1	342
BH730	7314150235667	1	342
BH730SG	7314150238484	1	342
BH750	7314150235674	1	342
BH750SG	7314150238491	1	342
BH7PS30	7314150474882	2	342
BH8AC1-500	7314150170463	1	313
BH8AC2-500	7314150412532	1	313
BH8AC3-1500	7314150292264	1	356
BH8AC3-1500A	7314150516391	1	356
BH8AC3-600	7314150351893	1	355
BH8BC1	7314150242276	1	350
BH8BC2	7314150242283	1	350
BH8BC3	7314150242290	10	350
BH8BC4	7314150242306	6	350
BH8BC5	7314150242313	6	350
BH8PR10000	7314150178957	1	350
BH8PR4000	7314150178940	1	350
BH9BJ22SLH	7314150246946	1	353
BH9BJ22SSH	7314150247462	1	353
BH9BJ23SLH	7314150246953	1	353
BH9BJ23SSH	7314150246960	1	353
BH9BJ260	7314150247509	1	353
BH9BJ280	7314150247516	1	353
BHVIG15-250	7314150403745	12	357
BHVIS06100	7314150167753	1	332
BHVIS06105	7314150167760	1	332
BHVIS0670	7314150167692	1	332
BHVIS0677	7314150167708	1	332
BHVIS0680	7314150167715	1	332
BHVIS0685	7314150167722	1	332
BHVIS0690	7314150167739	1	332
BHVIS0695	7314150167746	1	332
BHVIS08100	7314150165711	1	332
BHVIS08115	7314150165728	1	332
BHVIS0895	7314150165704	1	332
BHVIS109BPW12	7314150165759	1	332
BHVIS111BPW12	7314150165735	1	333
BHVIS120BPW16	7314150165742	1	332
BHVIS1265	7314150167685	1	332
BHVIS80BPW12	7314150165766	1	333
BHVIS95BPW9	7314150243334	1	333
BKE850901N	7314150449705	10	229
BLBT100	7314150179015	1	344
BLBT100AC1	7314150179022	1	344
BLCR230FR	7314150247356	1	360
BLCR230SC	7314150247349	1	360
BLCR24VCL	7314150247370	1	360
BLCR24VLL	7314150247387	1	360
BLCR400E	7314150247363	1	360
BLCRSC1	7314150247530	1	360
BLCRSC2	7314150247547	1	360
BLE300	7314150227648	1	343
BLE301	7314150227662	1	344
BLE302	7314150227679	1	344
BLE304	7314150249572	1	344
BLE305	7314150339341	1	343
BLEMAT1	7314150477678	1	343



BLEMAT1BT



BLEMAT1BT	7314150477685	1	343
BLS128	7314150246847	20	360
BLT550	7314150243556	10	304
BLTFC1	7314150246434	20	360
BLTS10	7314150246427	20	360
BLTS7P	7314150246410	58	360
BLUVF	7314150247622	1	304
BMD150	7314150242238	1	343
BMMTRMS1	7314150274024	1	339
BMR240	7314150242245	1	343
BMVAT1000	7314150488360	50	339
BOD101	7314150205967	1	322
BOD1016	7314150169979	1	324
BOD101NWS	7314150269099	1	322
BOD101T	7314150269150	1	324
BOD102	7314150205974	1	322
BOD102NWS	7314150269105	1	322
BOD102T	7314150269167	1	324
BOD103	7314150205981	1	322
BOD103NWS	7314150269112	1	322
BOD103T	7314150269174	1	324
BOD104	7314150205998	1	322
BOD104NWS	7314150269129	1	322
BOD104T	7314150269181	1	324
BOD105	7314150206001	1	322
BOD105NWS	7314150269136	1	322
BOD105T	7314150269198	1	324
BOD106	7314150206018	1	322
BOD106NWS	7314150269143	1	322
BOD106T	7314150269204	1	324
BOD10P64	7314150205950	1	322
BOD2008	7314150169986	1	324
BOD2FS	7314150351879	20	324
BOD301200	7314150169993	1	324
BOD4200	7314150169436	1	323
BOD4500	7314150169443	1	323
BOD54-1	7314150239467	1	325
BOD54-2	7314150239474	1	325
BOD54-3	7314150239481	1	325
BOD5400	7314150169450	1	324
BOD5450	7314150169474	1	324
BOD5HD400	7314150169467	1	324
BOD60	7314150169481	1	324
BOD6080P12	7314150235407	1	322
BOD6080P12-01	7314150235438	1	323
BOD6080P12-02	7314150235445	1	323
BOD6080P12-03	7314150235452	1	323
BOD6080P12-04	7314150235469	1	323
BOD6080P12-05	7314150235476	1	323
BOD6080P12-06	7314150235490	1	323
BOD6080P12-07	7314150235506	1	323
BOD6080P12-08	7314150235513	1	323
BOD6080P12-09	7314150235520	1	323
BOD6080P12-10	7314150235537	1	323
BOD6080P12-11	7314150235544	1	323
BOD70	7314150169498	1	324
BOD8901	7314150169016	1	322
BOD8901AC1	7314150178490	1	322
BOD8902	7314150169023	1	322
BOD8903A	7314150265374	1	322
BP-40	7314150453085	1	587
BP-40-95	7314150487097	12	587
BP110	7314150135011	1	279
BP111E	7314150235872	12	279
BP115	7314150134991	1	277
BP117	7314150184309	1	277
BP117EH	7314150184316	1	279
BP118	7314150235834	1	277
BP125A	7314150427291	6	285
BP127	7314150137565	1	279
BP12718	8414909179002	1	280
BP127P	7314150427277	1	279
BP204	7314150184286	1	281
BP20410320	7314150185948	1	281
BP20410800	7314150185955	1	281
BP20425180	7314150185924	1	281
BP20425220	7314150185931	1	281
BP204K	7314150184293	1	281
BP204PAD	7314150185917	1	281
BP212	7314150134601	1	281
BP215A	7314150341849	10	285
BP218	7314150170272	1	286
BP219	7314150235889	1	286
BP219L	7314150235896	1	286
BP219V	7314150307197	1	286
BP219XL	7314150427192	10	286
BP222	7314150137572	1	281
BP233	7314150134748	1	283
BP254	7314150137633	1	286
BP255	7314150137640	1	287
BP255T	7314150427307	1	287
BP255T-1	7314150427314	1	287
BP277K	7314150427284	8	285
BP420M	7314150134618	1	278
BP421M	7314150134625	1	278
BP422M	7314150134632	1	278



BP423M	7314150134649	1	278
BP424M	7314150134656	1	278
BP430M	7314150134663	1	278
BP431M	7314150134670	1	278
BP432M	7314150134687	1	279
BP433M	7314150134694	1	279
BP434M	7314150135837	1	279
BP500	7314150137992	1	286
BP51137	7314150134724	1	281
BP601	7314150134526	1	281
BP60102	7314150426669	1	281
BP610	7314150134595	1	282
BP700	7314150134458	20	277
BP704	7314150427130	1	274
BP721	7314150427185	1	277
BP799	7314150134502	1	285
BP79912	7314150134717	1	285
BP809	7314150235841	1	282
BP80950	7314150275564	1	282
BP810	7314150235858	1	282
BP811	7314150235865	1	284
BP814	7314150184262	10	274
BP814A	7314150304349	10	274
BP815	7314150134311	1	274
BP815K1	7314150181957	1	274
BP815K2	7314150181964	1	274
BP817	7314150134106	1	275
BP820	7314150134465	1	277
BP821	7314150134472	1	277
BP822	7314150134984	1	278
BP822E	7314150184279	10	278
BP823	7314150135004	1	279
BP824	7314150134489	1	283
BP825	7314150134496	1	282
BP826	7314150137459	1	283
BP827	7314150137442	1	283
BP828	7314150427260	1	283
BP830CISB	7314150439799	1	280
BP830ESB	7314150439751	1	280
BP830EWB	7314150439768	1	280
BP830K	7314150427208	4	280
BP830MISB	7314150439782	1	280
BP830SBA	7314150439805	1	280
BP830SSB	7314150439775	1	280
BP830SW	7314150439744	1	280
BP901	7314150336012	1	276
BP901L	7314150336029	1	276
BP905L	7314150336234	2	276
BP905P	7314150336210	2	276
BP905S	7314150336227	2	276
BP909NE	7314150187980	1	285
BP909NF	7314150187973	1	285
BP909TE	7314150187942	1	284
BP909TF	7314150187911	1	284
BP909TH	7314150187959	1	284
BP909TSP	7314150187966	1	285
BP909TTP	7314150187935	1	284
BP909TWF	7314150187928	1	284
BP910	7314150427246	5	284
BP91BL	7314150192779	1	277
BP91BS	7314150192786	1	277
BPA823	7314150427161	1	282
BPBG3515	7314150134823	1	283
BPBG3525A	7314150134830	1	283
BPBG3525B	7314150134847	1	283
BPBG5725	7314150134861	1	284
BPBG9057	7314150134878	1	284
BPBK30	7314150134854	1	283
BPBL00900	7314150358335	5	345
BPBL30900	7314150360451	5	345
BPBL70600	7314150360468	5	345
BPBL90600	7314150358366	5	345
BPBLS4	7314150360475	2	345
BPBSC156	7314150134816	1	283
BPBU18	7314150134755	1	284
BPBU24	7314150134762	1	284
BPBU36	7314150134779	1	284
BPBU60	7314150134786	1	284
BPBU90	7314150134793	1	284
BPC813	7314150296408	10	274
BPC813K1	7314150331253	1	274
BPC814	7314150296392	10	275
BPC815	7314150296385	1	275
BPC815K1	7314150331208	1	275
BPC815K2	7314150331215	1	275
BPC815K3	7314150331222	1	275
BPC815K4	7314150331239	1	275
BPC815K6	7314150331284	1	275
BPC816	7314150296415	10	274
BPC817	7314150296422	4	275
BPC817K1	7314150331260	1	276
BPC817K2	7314150331277	1	276
BPC823	7314150427147	1	282
BPC825	7314150427154	1	282
BPVCB1	7314150384792	6	334
BPG824	7314150427253	10	283



BPH1010A	7314150330010	1	287
BPH1010B	7314150341757	1	287
BPH1310A	7314150330003	1	287
BPHRC1015	7314150247400	1	287
BPHRC1020	7314150247417	1	287
BPHRC1316	7314150247455	1	287
BPHRC815	7314150247394	1	287
BPHRO1315	7314150247431	1	288
BPHRSC	7314150247448	1	287
BPHVLP01	7314150138937	1	285
BPHVLP0112	7314150165872	1	286
BPHVLP0114	7314150165889	1	286
BPHVLP0117	7314150165896	1	286
BPHVLP0120	7314150165902	1	286
BPM917BOOT	7314150281664	1	276
BPM91MK1	7314150186938	1	276
BPM91MK2	7314150186945	1	276
BPN010	7314150219728	1	286
BPN21201	7314150134731	1	282
BPN22201	7314150138074	1	282
BPN251	7314150137589	1	287
BPOC15	7314150360673	12	315
BPQCF14	7314150138920	10	288
BPR821	7314150427178	1	277
BPSJ	7314150427239	1	288
BPSJL	7314150439812	1	288
BS1000	7314150170081	1	337
BS100001	7314150232819	1	337
BS100002	7314150232826	1	337
BS100003	7314150232833	1	337
BS100004	7314150232840	1	337
BS100005	7314150232857	1	337
BS100006	7314150232864	1	337
BS100007	7314150232871	1	337
BS100008	7314150232888	1	337
BS100009	7314150232895	1	337
BS100010	7314150232901	1	337
BS100011	7314150232918	1	337
BS100012	7314150232925	1	337
BS100013	7314150232932	1	337
BS100014	7314150232949	1	337
BS100015	7314150232956	1	337
BS100016	7314150232963	1	337
BS100017	7314150232970	1	337
BS100018	7314150232987	1	337
BS100019	7314150232994	1	337
BS100020	7314150233007	1	337
BS100021	7314150233014	1	337
BS100022	7314150233021	1	337
BS100023	7314150233038	1	337
BS100024	7314150233045	1	337
BS100025	7314150233052	1	337
BS100026	7314150233069	1	337
BS100027	7314150233076	1	337
BS100028	7314150233083	1	337
BS100029	7314150233090	1	337
BS100030	7314150233106	1	337
BS100031	7314150233113	1	337
BS100032	7314150233120	1	337
BS100033	7314150233137	1	337
BS100034	7314150233144	1	337
BS100035	7314150233151	1	337
BS100036	7314150233168	1	337
BS100037	7314150233175	1	337
BS100038	7314150233182	1	337
BS100039	7314150233199	1	337
BS100PSA1	7314150249282	1	335
BS10AC2	7314150182343	1	336
BS15	7314150206117	1	336
BS15125	7314150231775	1	336
BS15125C	7314150231812	1	336
BS15160	7314150231782	1	336
BS15160C	7314150231829	1	336
BS15212	7314150231799	1	336
BS15212C	7314150231836	1	336
BS1550	7314150231805	1	336
BS25	7314150416103	1	336
BS30AC1	7314150383504	1	337
BS30PG	7314150436644	1	336
BS40VAG	7314150430642	20	335
BS45BMW	7314150430659	20	335
BS52	7314150329212	1	334
BS5228341	7314150329229	1	334
BS5234401	7314150329236	1	334
BS5239451	7314150329243	1	334
BS54	7314150243341	1	334
BS56	7314150430826	6	334
BS618	7314150242368	1	335
BS623	7314150242375	1	335
BSSHE3	7314150251858	1	333
BT10P3	7314150205639	1	344
BT10P325	7314150231706	40	345
BT10P330	7314150231713	1	345
BT10P338	7314150231720	1	345
BT15P5	7314150205837	1	332
BT15P524	7314150231737	1	332



BT15P530	7314150231744	1	332
BT15P532	7314150231751	1	332
BT15P536	7314150342129	1	332
BT20P26	7314150205820	1	335
BT20P49	7314150385041	1	335
BTL-3-13	7314150333349	12	552
BTL-6-13	7314150333356	12	552
BTR-3-13	7314150333332	12	552
BTR-6-13	7314150333363	12	552
BUC100	7314150169962	1	319
BUC110	7314150206025	1	319
BUC50	7314150182329	1	319
BUCKET 1446	7314150436446	75	599
BUCPE	7314150243259	1	318
BUCPE3SDH	7314153024183	1	319
BUCPE3SH	7314150243471	1	318
BUCPEF	7314150244942	1	318
BUCPEF1	7314150245116	1	318
BWB14	7314150170166	2	335
BWB1418S4	7314150365593	6	343
BWB1922S4	7314150365609	6	343
BWBB	7314150407828	200	331
BWC1	7314150365586	25	331
BWHEHS	7314150251841	1	333
BWHEP	7314150251834	1	333
BWHEPS	7314150264087	1	333
BWHEPSH8	7314150264889	1	333
BWHEPSSH8	7314150264896	1	333
BWHPJ12	7314150403257	4	335
BWHTRS12	7314150384808	15	331
BWMSP15	7314150239740	1	371
BWMSP1501	7314150239757	1	371
BWMSP1502	7314150239764	1	371
BWMSP1503	7314150239771	1	371
BWMSP1504	7314150239788	1	371
BWMSP1505	7314150239795	1	371
BWMSP1506	7314150239801	1	371
BWMSP1507	7314153024176	1	371
BWMSP1508	7314150239818	1	371
BWMSP1509	7314150239825	1	371
BWMSP1510	7314150239832	1	371
BWMSP1511	7314150239849	1	371
BWMSP1512	7314150239856	1	371
BWMSP1513	7314150239863	1	371
BWMSP1514	7314150239870	1	371
BWMSP1515	7314150239887	1	371
BWP150	7314150170159	1	331
BWSH5	7314150251810	2	333
BWSH51	7314150251827	1	334
BWSH8	7314150255191	1	333
BWSHK21	7314150403271	25	329
BWSMB15	7314150365074	25	329
BWSMB17	7314150329656	1	329
BWSS12P3	7314150170128	20	328
BWSS12P317	7314150203451	1	329
BWSS12P317L	7314150330065	1	329
BWSS12P319	7314150203468	1	329
BWSS12P319L	7314150330072	1	329
BWSS12P321	7314150203475	1	329
BWSS12P321L	7314150330089	1	329
BWSS12P3L	7314150330096	1	329
BWSS12P5	7314150170135	1	329
BWSS12P522	7314150203482	1	329
BWSS12P524	7314150203499	1	329
BWTB12P100	7314150329830	1	330
BWTB12P110	7314150329847	1	330
BWTB12P120	7314150329854	1	330
BWTB12P135	7314150329861	1	330
BWTB12P150	7314150329878	1	330
BWTB12P160	7314150329885	1	330
BWTB12P175	7314150329892	1	330
BWTB12P190	7314150329908	1	330
BWTB12P200	7314150329915	1	330
BWTB12P5	7314150329991	1	330
BWTB12P90	7314150329823	1	330
BWTDG1	7314150403400	50	332
BWTPG1	7314150351886	10	332
BWTPMSS4C	7314150347100	25	332
BWTPMSS9	7314150347124	8	332
BWTSP16	7314150170296	1	330
BWTSP1608	7314150203284	1	330
BWTSP1610	7314150203291	1	330
BWTSP1611	7314150203307	1	330
BWTSP1612	7314150203314	1	330
BWTSP1613	7314150203321	1	330
BWTSP1614	7314150203338	1	330
BWTSP1616	7314150203345	1	330
BWTSP1617	7314150203352	1	330
BWTSP1618	7314150203369	1	330
BWTSP1619	7314150203376	1	330
BWTSP1621	7314150203383	1	330
BWTSP1622	7314150203390	1	330
BWTSP1624	7314150203406	1	330
BWTSP1627	7314150203413	1	330
BWTSP317L	7314150335480	1	329
BWTSP319L	7314150335497	1	329



BWTSP321L



BWTSP321L	7314150335503	1	329
BWTSP3L	7314150335473	1	329
BWTSP6	7314150240043	1	330
BWTSP617	7314150242399	1	330
BWTSP619	7314150242405	1	330
BWTSP621	7314150242412	1	330
BWTSP622	7314150242429	1	330
BWTSP624	7314150242436	1	330
BWTSP7	7314150170302	1	330
BWTSP732	7314150203420	1	330
BWTSP736	7314150203437	1	330
BWTSP741	7314150203444	1	330
BWTVCTT355	7314150347179	1	332
BWXW1	7314150167661	1	328
BWXW2	7314150167678	1	328
BWXW3	7314150214624	1	328
BWXW4	7314150214631	1	328
BZWTB0132450	7314150165674	1	331
BZWTB0132600	7314150165681	1	331
BZWTB0133600	7314150165698	1	331
C0312I03	7314150501298	5	147
C0313M03	7311518100636	1	144
C0313M03X	7311518182045	1	144
C0616AL06	7311518181826	1	145
C0616M03X	7311518204679	1	144
C0616M06	7311518100667	1	144
C0616M06X	7311518100681	1	144
C0618I06	7314150501311	5	147
C0618S06	7314150501342	5	146
C0820M06	7311518100711	1	144
C0820M06X	7311518100735	1	144
C1020I06	7314150501373	5	147
C1020M06	7311518100766	1	144
C1020M06X	7311518100780	1	144
C1020S06	7314150501403	5	146
C1225AL06	7311518187637	1	145
C1225I06	7314150506743	5	147
C1225M06	7311518100810	1	144
C1225M06X	7311518100834	1	144
C1225M08X	7311518187996	1	144
C1225S06	7314150501465	5	146
C1625M06	7311518192266	1	144
C1625M06X	7311518187378	1	144
C1625M08	7311518100902	1	144
C1625M08X	7311518100926	1	144
C1997LM/9P	7314150510375	1	225
C1997TORX/9P	7314150510382	1	226
C3140	7314150393312	10	234
C3140IP	7314150391158	10	234
C3230	7314150393329	10	237
C3230IP	7314150391189	10	237
C3330	7314150393336	10	234
C3330IP	7314150391196	10	234
C3330R	7314150393343	10	234
C3330R IP	7314150391202	10	234
C3340R	7314150393350	10	234
C3340R IP	7314150391219	10	234
C3430	7314150393367	10	245
C3430IP	7314150391226	10	245
C3530	7314150393374	10	246
C3530IP	7314150391233	10	246
C3630	7314150393381	10	242
C3630IP	7314150391240	10	242
C3640	7314150393398	10	242
C3640IP	7314150391257	10	242
C3745	7314150393404	10	243
C3745IP	7314150391264	10	243
C3790	7314150393411	10	243
C3790IP	7314150391271	10	243
C3830	7314150393428	10	242
C3830IP	7314150391288	10	242
C3840	7314150393435	10	242
C3840IP	7314150391295	10	242
C3901/3	7314150392797	1	257
C3902/3	7314150399604	1	257
C3903/2-6	7314150466481	1	258
CFP250	7314150400669	6	626
CFP250-DISP	7314150400690	12	626
CFW250	7314150400683	6	626
CFW250-DISP	7314150400706	12	626
CHALK-BLUE	7314150128686	6	556
CHALK-RED	7314150128709	6	556
CHALK-WHITE	7314150179671	6	556
CHALK-YELLOW	7314150128693	6	556
CL-1221	7314150127122	6	556
CL-1221-SET	7314150188574	4	556
CL-1331	7314150347728	48	556
CL-1441	7314150347735	36	556
CLIPS-1/2	7314153003201	25	96
CLIPS-1/4	7314153003188	25	84
CLIPS-3/8	7314153003195	25	90
CR B 01	7314150215409	10	254
CR B 02	7314150215416	10	254
CR B 03	7314150215423	5	254
CR B 05	7314150215454	2	254
CR B 06	7314150215461	2	254



CR L 01	7314150215911	1	256
CR L 02	7314150215928	1	256
CR L 03	7314150215935	1	257
CR OV 01	7314150489978	1	255
CR SA H01	7314150489992	1	256
CR SA H16	7314150508990	1	256
CR SA S01	7314150490011	1	256
CR SA T01	7314150490035	1	256
CR W 01	7314150215492	1	255
CR W 02	7314150215508	1	255
CR W 03	7314150215515	1	255
CR W 04	7314150215522	1	255
CR W 05	7314150215539	1	255
CR W 06	7314150215546	1	256
CS-SPARE	7314150453030	1	558
CS150	7314150125241	12	558
CS300	7314150125258	12	558
CS400	7314150125265	12	558
CUC-0.4-360	7314150342075	4	614
CUC-0.8-600	7314150342099	4	614
D-DD/S20	7311518280345	4	178
D/S10	7311518280307	6	179
D/S14	7311518280314	6	179
D0303I03	7314150501281	5	147
D0303M03	7311518100957	1	144
D0303M03X	7311518182052	1	144
D0605M03X	7311518197896	1	144
D0606I06	7314150501328	5	147
D0606M06	7311518100988	1	144
D0606M06X	7311518101008	1	144
D0606S06	7314150501359	5	146
D0807M06	7311518043896	1	144
D0807M06X	7311518043919	1	144
D1009M06	7311518035280	1	144
D1009M06X	7311518035297	1	144
D1010I06	7314150501380	5	147
D1010S06	7314150501410	5	146
D1211AL06	7311518187644	1	146
D1211AL08	7311518181840	1	146
D1211M06	7311518035334	1	144
D1211M06X	7311518035358	1	144
D1212I06	7314150501441	5	147
D1212S06	7314150501472	5	146
D1614M06	7311518192327	1	144
D1614M06X	7311518187385	1	144
D1614M08	7311518035389	1	144
D1614M08X	7311518035402	1	144
DD/S10	7311518280321	6	179
DD/S14	7311518280338	4	178
DOW 175-1	7314152202728	1	266
DOW 175-11/2	7314152202995	1	266
DOW 175-2	7314152203022	1	266
DOW 175-3	7314152203299	1	266
DOW 176-1	7314152206047	1	267
DOW 176-11/2	7314152206122	1	267
DOW 176-2	7314152206399	1	267
DOW 177-1/2-1	7314152816383	1	266
DOW 177-11/2	7314152816468	1	266
DOW 177-2	7314152816543	1	266
E0308M03	7311518035433	1	144
E0308M03X	7311518192372	1	144
E0614M06	7311518035464	1	144
E0816M06	7311518035518	1	144
E0816M06X	7311518035532	1	144
E1015I06	7314150501496	5	147
E1018M06	7311518035563	1	144
E1018M06X	7311518035587	1	144
E1220I06	7314150501526	5	147
E1222M06	7311518035617	1	144
E1222M06X	7311518035631	1	144
E1222M08	7311518172558	1	144
E1222M08X	7311518199302	1	144
E1625M06	7311518192440	1	144
E1625M06X	7311518187392	1	144
E1625M08	7311518035709	1	144
E1625M08X	7311518035723	1	144
EX-14-TEN-C	7311518298333	10	577
EX-14-VEN-C	7311518298340	10	577
EX-16-GNP-C	7311518298685	10	574
EX-19-XT9-C	7311518298302	10	576
EX-20-LAM-C	7311518298326	10	577
EX-20-XT11-C	7311518298319	10	577
EX-22-PLS-C	7311518298357	10	574
EX-22-U7	7311518300890	10	576
EX-22-XT7-C	7311518298289	10	578
EX-22-XT9-C	7311518298296	10	576
EX-24-XT7-C	7311518298272	10	578
EX-24P-22	7311518298456	10	578
EX-LL	7311518298494	4	580
EX-NPP-22	7311518324162	10	576
EX-RL	7311518298487	4	580
EX-RM	7311518298470	4	580
F0312I03	7314150501502	5	147
F0313M03	7311518035754	1	144
F0313M03X	7311518192495	1	144
F0613M03X	7311518196608	1	144



F0618AL06	7311518181857	1	146
F0618I06	7314150501533	5	147
F0618M06	7311518035792	1	144
F0618M06X	7311518035815	1	144
F0618S06	7314150501564	5	146
F0820M06	7311518035839	1	144
F0820M06X	7311518035860	1	144
F1020I06	7314150501595	5	147
F1020M06	7311518035891	1	144
F1020M06X	7311518035914	1	144
F1020S06	7314150501625	5	146
F1225AL06	7311518187651	1	146
F1225AL08	7311518181864	1	146
F1225I06	7314150501656	5	147
F1225M06	7311518035945	1	144
F1225M06X	7311518036003	1	144
F1225M08	7311518035983	1	144
F1225M08X	7311518192563	1	144
F1225S06	7314150501687	5	146
F1625M06	7311518192570	1	144
F1625M06X	7311518187408	1	144
F1625M08	7311518036034	1	144
FCP-1.8-810	7311518123970	614	614
FCP-2.3-860	7311518123994	2	614
FCS-1000	7314150321551	6	559
FCS-600	7314150321537	6	559
FCS-800	7314150321544	6	559
FF1A01	7314150228560	1	405
FF1A02	7314150228591	1	414
FF1A03	7314150228607	1	420
FF1A04	7314150227778	1	414
FF1A051	7314150478446	1	405
FF1A06	7314150227822	1	420
FF1A07	7314150227846	1	421
FF1A08	7314150227976	1	406
FF1A09	7314150227990	1	414
FF1A10	7314150228010	1	402
FF1A1001	7314150286478	1	402
FF1A1002	7314150286461	1	403
FF1A1003	7314150286485	1	403
FF1A1004	7314150286454	1	412
FF1A1005	7314150286591	1	403
FF1A1006	7314150286645	1	403
FF1A1007	7314150286621	1	403
FF1A1008	7314150309443	1	403
FF1A1010	7314150320660	1	412
FF1A1011	7314150339068	1	413
FF1A102	7314150334841	1	418
FF1A104	7314150334865	1	414
FF1A106	7314150335541	1	406
FF1A11	7314150228034	1	418
FF1A110	7314150335619	1	421
FF1A112	7314150335572	1	414
FF1A114	7314150335633	1	421
FF1A115	7314150335640	1	421
FF1A117	7314150335701	1	421
FF1A118	7314150335732	1	418
FF1A119	7314150335749	1	421
FF1A12	7314150228058	1	422
FF1A121	7314150335718	1	422
FF1A124	7314150335725	1	422
FF1A127	7314150336395	1	422
FF1A128	7314150336586	1	423
FF1A129	7314150336593	1	423
FF1A13	7314150228072	1	406
FF1A130	7314150336661	1	406
FF1A131	7314150336678	1	423
FF1A132	7314150336685	1	423
FF1A133	7314150336692	1	413
FF1A134	7314150336708	1	415
FF1A135	7314150336715	1	415
FF1A136	7314150336722	1	423
FF1A137	7314150336739	1	407
FF1A138	7314150336746	1	424
FF1A139	7314150336753	1	413
FF1A14	7314150228089	1	415
FF1A141	7314150336777	1	418
FF1A142	7314150338573	1	407
FF1A143	7314150338580	1	424
FF1A145	7314150338603	1	419
FF1A146	7314150338610	1	407
FF1A147	7314150338627	1	424
FF1A15	7314150228096	1	419
FF1A153	7314150350445	1	410
FF1A154	7314150350476	1	430
FF1A16	7314150228102	1	424
FF1A164	7314150350957	1	430
FF1A165	7314150350964	1	411
FF1A166	7314150350971	1	405
FF1A167	7314150350988	1	430
FF1A168	7314150350995	1	430
FF1A169	7314150351008	1	430
FF1A17	7314150228119	1	404
FF1A170	7314150351800	1	418
FF1A18	7314150228126	1	424
FF1A185	7314150358694	1	422



FF1A189	7314150405961	1	431
FF1A19	7314150254354	1	415
FF1A194	7314150431496	1	411
FF1A195LM	7314150455850	1	411
FF1A196LM	7314150455874	1	411
FF1A197LM	7314150455881	1	431
FF1A198LM	7314150455898	1	417
FF1A199LM	7314150455904	1	417
FF1A20	7314150254361	1	415
FF1A200LM	7314150455928	1	420
FF1A201LM	7314150455935	1	405
FF1A202LM	7314150455966	1	413
FF1A203LM	7314150455973	1	413
FF1A204LM	7314150455980	1	431
FF1A205LM	7314150455997	1	431
FF1A206LM	7314150456000	1	411
FF1A207LM	7314150456017	1	411
FF1A208LM	7314150456024	1	431
FF1A209LM	7314150456031	1	417
FF1A21	7314150254378	1	404
FF1A210LM	7314150456062	1	431
FF1A211LM	7314150456079	1	414
FF1A212LM	7314150456086	1	432
FF1A213	7314150437283	1	412
FF1A214LM	7314150456093	1	412
FF1A215LM	7314150456109	1	432
FF1A216LM	7314150456123	1	432
FF1A218LM	7314150456130	1	412
FF1A219LM	7314150456147	1	412
FF1A22	7314150254385	1	407
FF1A220LM	7314150456154	1	417
FF1A221LM	7314150456161	1	432
FF1A222LM	7314150456178	1	432
FF1A223LM	7314150456185	1	420
FF1A224LM	7314150456192	1	432
FF1A225LM	7314150456208	1	433
FF1A23	7314150254392	1	424
FF1A230	7314150461455	1	433
FF1A2301	7314150286508	1	408
FF1A235	7314150500666	1	418
FF1A236	7314150500680	1	422
FF1A24	7314150254408	1	425
FF1A25	7314150254415	1	408
FF1A2501	7314150286492	1	408
FF1A2503	7314150320677	1	408
FF1A26	7314150254422	1	425
FF1A27	7314150254439	1	404
FF1A28	7314150254446	1	425
FF1A29NB	7314150266340	1	433
FF1A3001	7314150286515	1	415
FF1A3002	7314150289264	1	416
FF1A3003	7314150286522	1	416
FF1A3004	7314150286676	1	416
FF1A3005	7314150286638	1	416
FF1A30NB	7314150266357	1	433
FF1A31NB	7314150266364	1	433
FF1A35	7314150264124	1	425
FF1A36	7314150265862	1	425
FF1A37	7314150265855	1	409
FF1A39	7314150266920	1	409
FF1A40	7314150266951	1	404
FF1A4001	7314150286713	1	419
FF1A4002	7314150286560	1	419
FF1A4003	7314150286706	1	419
FF1A41	7314150266982	1	426
FF1A48	7314150271801	1	417
FF1A49	7314150271818	1	404
FF1A50	7314150271825	1	419
FF1A5001	7314150286430	1	404
FF1A5002	7314150286447	1	416
FF1A5003	7314150286690	1	409
FF1A5004	7314150286539	1	409
FF1A5005	7314150286546	1	409
FF1A5006	7314150286683	1	416
FF1A5007	7314150286553	1	426
FF1A5008	7314150286607	1	426
FF1A5009	7314150286669	1	426
FF1A5010	7314150286584	1	426
FF1A5011	7314150286614	1	427
FF1A5012	7314150286652	1	427
FF1A5013	7314150286577	1	410
FF1A5015	7314150307401	1	427
FF1A5017	7314150307425	1	427
FF1A5019	7314150309436	1	427
FF1A5021	7314150309467	1	427
FF1A5022	7314150309474	1	428
FF1A5023	7314150309498	1	428
FF1A5024	7314150309504	1	428
FF1A5027	7314150320684	1	416
FF1A5028	7314150320691	1	428
FF1A5029	7314150320707	1	428
FF1A5030	7314150320714	1	428
FF1A5031	7314150320721	1	429
FF1A5032	7314150320738	1	410
FF1A5036	7314150339037	1	429
FF1A5038	7314150339051	1	429



FF1A51



FF1A51	7314150271832	1	420
FF1A53	7314150271856	1	429
FF1A54	7314150288786	1	410
FF1A55	7314150299720	1	410
FF1A56	7314150299737	1	417
FF1A65	7314150313389	1	417
FF1A66	7314150313396	1	429
FF1A67	7314150313402	1	429
FF1A68	7314150313419	1	420
FF1A70	7314150320189	1	410
FF1A71	7314150320196	1	413
FF1A72	7314150320202	1	430
FF1A82	7314150334070	1	433
FF1ASET-AUTO	7314150437993	1	451
FF1ASET-AUTO-M1	7314150438259	1	449
FF1ASET-AUTO-M2	7314150438327	1	449
FF1ASET-AUTO-M3	7314150438334	1	449
FF1ASET-AUTO-M4	7314150438341	1	450
FF1ASET-AUTO-M5	7314150438358	1	450
FF1ASET-AUTO-M6	7314150438365	1	450
FF1ASET-AUTO1	7314150254453	1	450
FF1ASET-AUTO2	7314150254460	1	450
FF1ASET-AUTO3	7314150254477	1	451
FF1ASET-AUTO6	7314150319909	1	451
FF1ASET-BASIC	7314150437368	1	441
FF1ASET-LARGE	7314150437108	1	441
FF1ASET-MRO2	7314150336623	1	454
FF1ASET-MRO3	7314150336630	1	455
FF1ASET-MRO4	7314150336647	1	455
FF1ASET-MRO5	7314150336654	1	455
FF1ASET-XLARGE	7314150436965	1	440
FF1B01LM	7314150455416	1	441
FF1B02LM	7314150455447	1	441
FF1B03LM	7314150455454	1	442
FF1B04LM	7314150455478	1	442
FF1B05LM	7314150455515	1	442
FF1B06LM	7314150455522	1	442
FF1B07LM	7314150455614	1	442
FF1B08LM	7314150455645	1	443
FF1B09LM	7314150455669	1	443
FF1B10LM	7314150455706	1	443
FF1B11LM	7314150455713	1	443
FF1BSET-MONSTER	7314150436835	1	440
FF1E1001	7314150285839	1	384
FF1E1002	7314150285761	1	384
FF1E1003	7314150285853	1	384
FF1E1004	7314150285754	1	384
FF1E1005	7314150285785	1	385
FF1E1006	7314150285778	1	385
FF1E1007	7314150285792	1	385
FF1E1008	7314150285822	1	385
FF1E1009	7314150285808	1	385
FF1E1009EH	7314150352579	1	393
FF1E1010	7314150285815	1	385
FF1E1011	7314150285846	1	385
FF1E1012EH	7314150352562	1	393
FF1E1013EH	7314150352586	1	393
FF1E2001	7314150285945	1	386
FF1E2002	7314150285921	1	386
FF1E2003	7314150286072	1	386
FF1E2004	7314150285952	1	386
FF1E2005	7314150285976	1	386
FF1E2006	7314150285914	1	387
FF1E2007	7314150285907	1	387
FF1E2008	7314150285860	1	387
FF1E2009EH	7314150352593	1	393
FF1E2010EH	7314150352654	1	393
FF1E2011EH	7314150373802	1	395
FF1E2101	7314150285877	1	387
FF1E2102	7314150286058	1	387
FF1E2103	7314150286089	1	387
FF1E2104	7314150285990	1	388
FF1E2105	7314150286041	1	388
FF1E2106EH	7314150352623	1	393
FF1E2107EH	7314150352661	1	393
FF1E2201	7314150286010	1	388
FF1E2202	7314150285891	1	388
FF1E2203	7314150285884	1	388
FF1E2204	7314150285983	1	388
FF1E2205	7314150285938	1	389
FF1E2206	7314150286034	1	389
FF1E2207	7314150285969	1	389
FF1E2208	7314150286027	1	389
FF1E2209	7314150286096	1	389
FF1E2210	7314150286065	1	389
FF1E2211	7314150339006	1	390
FF1E2212	7314150339013	1	390
FF1E2213	7314150339020	1	390
FF1E2214EH	7314150352647	1	393
FF1E2215EH	7314150352678	1	394
FF1E2216EH	7314150373833	1	395
FF1E2501	7314150286003	1	390
FF1E2502	7314150338993	1	390
FF1E2503EH	7314150352685	1	394
FF1E2504EH	7314150374106	1	395
FF1E2505EH	7314150373826	1	395



FF1E3001	7314150286119	1	391
FF1E3002	7314150286102	1	391
FF1E3003	7314150286157	1	391
FF1E3004	7314150286133	1	391
FF1E3005	7314150286126	1	391
FF1E3006	7314150286140	1	391
FF1E3007	7314150286164	1	391
FF1E3008	7314150286171	1	391
FF1E3009EH	7314150352722	1	394
FF1E3010EH	7314150352739	1	394
FF1E3011EH	7314150352753	1	394
FF1E4001	7314150285747	1	392
FF1E4002	7314150285730	1	392
FF1E4003EH	7314150352692	1	394
FF1E4004EH	7314150352708	1	394
FF1E4005EH	7314150352807	1	394
FF1E5001	7314150285716	1	392
FF1E5002	7314150285709	1	392
FF1E5003	7314150285723	1	392
FF1E5004	7314150338931	1	392
FF1E5005	7314150338948	1	390
FF1E5006	7314150338955	1	390
FF1E5007	7314150338962	1	392
FF1E5008	7314150338979	1	392
FF1E5009	7314150338986	1	391
FF1E5010EH	7314150352746	1	394
FF1E5011EH	7314150352777	1	395
FF1E5013EH	7314150352821	1	395
FF1E5014EH	7314150373864	1	395
FF1E5015EH	7314150373871	1	395
FF1E5016EH	7314150373888	1	395
FF1F1001	7314150286270	1	396
FF1F1002	7314150286287	1	396
FF1F1003	7314150286294	1	396
FF1F1004	7314150286263	1	396
FF1F1005	7314150286300	1	396
FF1F1006	7314150286249	1	396
FF1F1007	7314150286256	1	396
FF1F1008	7314150339129	1	397
FF1F1009	7314150339136	1	397
FF1F2001	7314150286317	1	397
FF1F2002	7314150339143	1	397
FF1F2101	7314150286331	1	397
FF1F2102	7314150339105	1	397
FF1F2103	7314150339112	1	398
FF1F2201	7314150286324	1	398
FF1F2202	7314150339150	1	398
FF1F2203	7314150339167	1	398
FF1F3001	7314150286348	1	398
FF1F3002	7314150286379	1	398
FF1F3003	7314150286409	1	399
FF1F3004	7314150286386	1	399
FF1F3005	7314150286362	1	399
FF1F3006	7314150286355	1	399
FF1F3007	7314150286393	1	399
FF1F3008	7314150286423	1	399
FF1F3009	7314150286416	1	399
FF1F3010	7314150339082	1	400
FF1F3011	7314150339099	1	400
FF1F4001	7314150286195	1	400
FF1F4002	7314150286201	1	400
FF1F4003	7314150286225	1	400
FF1F4004	7314150286232	1	400
FF1F4005	7314150286218	1	400
FF1F5001	7314150286188	1	401
FF1F5002	7314150339174	1	401
FF1F5003	7314150339181	1	401
FF1F5004	7314150339198	1	398
FF1F5005	7314150339204	1	401
FF1F5006	7314150339211	1	401
FF1F5007	7314150339228	1	401
FF1F5008	7314150339235	1	401
FF1F5009	7314150339242	1	402
FF1F5010	7314150339259	1	402
FF1F5011	7314150339266	1	402
FF1F5012	7314150339273	1	402
FF1F5013	7314150339280	1	398
FF2A07	7314150228201	1	459
FF2A08	7314150228225	1	459
FF2A09	7314150228249	1	459
FF2A10	7314150228263	1	463
FF2B01	7314150233441	1	460
FF2B02	7314150233465	1	460
FF2B03	7314150233489	1	460
FF2B04	7314150233502	1	460
FF2B05	7314150233526	1	461
FF2B06	7314150233540	1	461
FF2B07	7314150229420	1	461
FF2B08	7314150229451	1	461
FF2B09	7314150229482	1	461
FF2B10	7314150229505	1	462
FF2B11	7314150229529	1	462
FF2B12	7314150229543	1	462
FF2B13	7314150229567	1	462
FF2B14	7314150229581	1	462
FF2B15	7314150229604	1	463



FF2B16	7314150229628	1	463
FF2C01	7314150327287	1	463
FF3A01	7314150228300	1	443
FF3A02	7314150228324	1	444
FF3A03	7314150228348	1	444
FF3A04	7314150228362	1	444
FF3A05	7314150228386	1	444
FF3A06	7314150228416	1	444
FF3A07	7314150228430	1	445
FF3A08	7314150228454	1	445
FF3A09	7314150228478	1	445
FF3A10	7314150228492	1	445
FF3A11	7314150228515	1	445
FF3A12	7314150228539	1	446
FF3A13	7314150228614	1	446
FF3A14	7314150228638	1	446
FF3A15	7314150228652	1	446
FF3A16	7314150228676	1	446
FF3A17	7314150228690	1	447
FFSS-1.5-900FG	7311518275884	4	614
FGS-1.0-600	7311518123796	4	614
FGS-1.25-700	7311518123802	4	614
FGS-1.25-700-WB	7314150398720	4	614
FGS-1.6-810	7311518123819	4	614
FGS-1.6-810-WB	7314150399086	4	614
FGS-1.8-810	7311518123826	4	614
FM10	7311518010881	5	31
FM12	7314150273249	5	31
FP-3M	7311518168612	1	641
FS-5	7311518266455	10	647
FS-7.5	7311518266479	10	647
FS-8	7311518266462	10	647
G0313M03	7311518036089	1	144
G0313M03X	7311518182069	1	144
G0613M03X	7311518196592	1	144
G0618M06	7311518036119	1	144
G0618M06X	7311518036133	1	144
G0820M06	7311518036164	1	144
G0820M06X	7311518036188	1	144
G1020I06	7314150501519	5	147
G1020M06	7311518036218	1	144
G1020M06X	7311518036232	1	144
G1020S06	7314150501540	5	146
G1225I06	7314150501571	5	147
G1225M06	7311518036317	1	144
G1225M06X	7311518036331	1	144
G1225M08	7311518036362	1	144
G1225M08X	7311518188009	1	144
G1225S06	7314150501601	5	146
G1625M06	7311518192648	1	144
G1625M06X	7311518187415	1	144
G1625M08	7311518036409	1	144
G1625M08X	7311518036423	1	144
GL008-10	7314150167050	5	499
GL008-8	7314150167043	5	499
GL010-10	7314150167098	5	499
GL010-8	7314150167081	5	499
GS-180-F	7311518275488	6	646
GS-76	7311518010782	8	646
H0613M03X	7311518196615	1	145
H1020I06	7314150501717	5	147
H1025M06	7311518182304	1	145
H1025M06X	7311518182311	1	145
H1232I06	7314150501748	5	147
H1232M06	7311518182076	1	145
H1232M06X	7311518181758	1	145
H1635M06	7311518192730	1	145
H1635M06X	7311518187422	1	145
H1635M08	7311518182083	1	145
H1635M08X	7311518182090	1	145
HFGPS-0.7-400FG	7311518275877	4	614
HGPS-0.6-360	7311518123680	10	614
HGPS-0.8-380	7311518123697	4	614
HGPS-0.8-380-WB	7314150398812	4	614
HGPS-1.0-400	7311518123703	4	614
HGPS-1.0-400-WB	7314150398713	4	614
HRFM10	7311518010898	5	31
HUS-0.6-380	7311518123659	4	614
HUS-0.8-500	7311518123666	4	614
HUS-1.0-650	7311518123673	4	614
IZO-D-135	7314151845827	1	107
IZO-D-200	7314151846831	1	107
IZO-D-30	7314151846824	1	107
IZO-D-340	7314151846848	1	107
IZO-DR-810	7314151846817	1	107
J0604M06	7311518036508	1	145
J1010M06	7311518172473	1	145
J1212M06	7311518036577	1	145
J1616M06	7311518187439	1	145
J1616M08	7311518036614	1	145
K-AP-1	7311518030117	10	646
K-GP-1	7311518030131	10	647
K0602M06	7311518036652	1	145
K1008M06	7311518036683	1	145
K1210M06	7311518036720	1	145
K1612M06	7311518193959	1	145



K1612M08	7311518036768	1	145
K172	7314150384396	1	173
K18NF-2	7314151347161	5	170
K18PH-2M5	7314153019646	5	170
K18PH-2M6	7314150274871	5	170
K19PZD-2M5	7314151693237	1	170
K19PZD-2NF	7314151586157	1	170
K20TORX-T25	7314151825799	10	170
K560F-1	7314151825492	5	173
K560F-2	7314151825324	5	174
K560F-3	7314151825331	5	174
K560F-4	7314151825348	5	178
K560F-5	7314151825355	5	178
K560F-6	7314151825362	5	181
K560F-7	7314151825379	5	183
K560F-8	7314151825508	5	183
K560F-9	7314151846688	5	185
K66100-1/4	7314150204540	1	172
K66100-1/4-1P	7314150260201	25	172
K66100-3/8	7314150204564	1	172
K66100-3/8-1P	7314150260249	25	172
K6625-1/4	7314150204496	1	172
K6625-1/4-1P	7314150260140	1	172
K6638-3/8	7314150204557	1	172
K6638-3/8-1P	7314150260164	25	172
K6650-1/2	7314150204519	1	172
K6650-1/2-1P	7314150260188	1	172
K6650-1/4	7314150204526	1	172
K6650-1/4-1P	7314150204533	1	172
K6650-3/8	7314150204502	1	172
K6650-3/8-1P	7314150260225	1	172
K6660-QR-1P	7314150204571	1	172
K6701M-10	7314151778149	1	172
K6701M-11	7314151778224	1	172
K6701M-12	7314151811891	1	172
K6701M-13	7314151778491	1	172
K6701M-14	7314151844172	1	172
K6701M-6	7314151813260	1	172
K6701M-7	7314151777920	1	172
K6701M-8	7314151778064	1	172
K6701M-9	7314151815110	1	172
K6750-1/4	7314150204663	1	170
K6750-10	7314150204700	1	170
K6750-13	7314150204823	1	170
K6750-3/8	7314150204656	1	170
K6750-6	7314150204670	1	170
K6750-7	7314150204687	1	170
K6750-8	7314150204694	1	170
K6964C	7314151215170	1	174
K7401M-10	7314151780128	1	173
K7401M-11	7314151780395	1	173
K7401M-12	7314151811907	1	173
K7401M-13	7314151780470	1	173
K7401M-14	7314151780555	1	173
K7401M-15	7314151812140	1	173
K7401M-16	7314151780630	1	173
K7401M-17	7314151780715	1	173
K7401M-18	7314151812157	1	173
K7401M-19	7314151812164	1	173
K7401M-20	7314151844271	1	173
K7401M-21	7314151845216	1	173
K7401M-22	7314151845223	1	173
K7401M-24	7314151844295	1	173
K7401M-7	7314151812126	1	173
K7401M-8	7314151780043	1	173
K7401M-9	7314151812133	1	173
K7401M10	7314150389919	1	174
K7401TORX-E-S7	7314150343324	1	175
K7401TORX-E10	7314151844448	1	174
K7401TORX-E12	7314151844455	1	174
K7401TORX-E14	7314151844462	1	174
K7401TORX-E5	7314151844400	1	174
K7401TORX-E6	7314151844417	1	174
K7401TORX-E7	7314151844424	1	174
K7401TORX-E8	7314151844431	1	174
K7401Z-1/2	7314150384402	1	173
K7401Z-11/16	7314150384419	1	173
K7401Z-13/16	7314150384426	1	173
K7401Z-3/4	7314150384433	1	173
K7401Z-3/8	7314150384440	1	173
K7401Z-5/8	7314150384457	1	173
K7401Z-7/16	7314150384464	1	173
K7401Z-7/8	7314150384471	1	173
K7401Z-9/16	7314150384488	1	173
K7406M-10	7314151844479	1	173
K7406M-13	7314151844486	1	173
K7406M-17	7314151844493	1	173
K7760C-1	7314151222369	1	174
K7760C-2	7314151222376	1	174
K7764D	7314151222475	1	177
K7767S	7314151222512	1	174
K7800M-10	7314150326297	1	175
K7800M-11	7314150326303	1	175
K7800M-12	7314150326310	1	175
K7800M-13	7314150326327	1	175
K7800M-14	7314150326334	1	175



K7800M-15



K7800M-15	7314150326341	1	175
K7800M-16	7314150326358	1	175
K7800M-17	7314150326365	1	175
K7800M-18	7314150326372	1	175
K7800M-19	7314150326389	1	175
K7800M-21	7314150326396	1	175
K7800M-22	7314150326402	1	175
K7800M-24	7314150326419	1	175
K7800M/13	7314150437221	1	178
K7801M-10	7314151778576	1	175
K7801M-11	7314151778651	1	175
K7801M-12	7314151815790	1	175
K7801M-13	7314151778736	1	175
K7801M-14	7314151778811	1	175
K7801M-15	7314151815806	1	175
K7801M-16	7314151779030	1	175
K7801M-17	7314151779115	1	175
K7801M-18	7314151779382	1	175
K7801M-19	7314151779467	1	175
K7801M-20	7314151844509	1	175
K7801M-21	7314151779542	1	175
K7801M-22	7314151779627	1	175
K7801M-23	7314151844516	1	175
K7801M-24	7314151779894	1	175
K7801M-25	7314151844523	1	175
K7801M-26	7314151844530	1	175
K7801M-27	7314151779979	1	175
K7801M-28	7314150430154	1	175
K7801M-29	7314150430161	1	175
K7801M-30	7314151811914	1	175
K7801M-32	7314151825157	15	175
K7801M-34	7314151844547	1	175
K7801M-36	7314151844554	1	175
K7801M-8	7314151845230	1	175
K7801M-9	7314151845247	1	175
K7801TORX-E10	7314151811587	1	177
K7801TORX-E12	7314151811594	1	177
K7801TORX-E14	7314151811600	1	177
K7801TORX-E16	7314151811617	1	177
K7801TORX-E18	7314151811624	1	177
K7801TORX-E20	7314151811631	1	177
K7801TORX-E24	7314151811648	1	177
K7801VM-17	7314151781521	1	176
K7801VM-19	7314151781798	1	176
K7801VM-22	7314151781873	1	176
K7801VM-24	7314151781958	1	176
K7801VM/S4	7314151799090	1	178
K7801Z-1	7314151844639	1	176
K7801Z-1.1/16	7314151844646	1	176
K7801Z-1.1/2	7314150137701	5	176
K7801Z-1.1/4	7314151844660	1	176
K7801Z-1.1/8	7314151844653	1	176
K7801Z-1.3/8	7314150137688	5	176
K7801Z-1.5/16	7314150137671	5	176
K7801Z-1.7/16	7314150137695	5	176
K7801Z-1/2	7314151822620	1	176
K7801Z-11/16	7314151844592	1	176
K7801Z-13/16	7314151844608	1	176
K7801Z-15/16	7314151844622	1	176
K7801Z-3/4	7314151822668	1	176
K7801Z-3/8	7314151822606	1	176
K7801Z-5/8	7314151844585	1	176
K7801Z-7/16	7314151844561	1	176
K7801Z-7/8	7314151844615	1	176
K7801Z-9/16	7314151822637	1	176
K7801Z/10	7314150165018	1	178
K7806M-10	7314151844677	1	175
K7806M-11	7314151844684	1	175
K7806M-12	7314151844691	1	175
K7806M-13	7314151805944	1	175
K7806M-14	7314151844707	1	175
K7806M-15	7314150330683	1	175
K7806M-16	7314151844714	1	175
K7806M-17	7314151805951	1	175
K7806M-18	7314151844721	1	175
K7806M-19	7314151805968	1	175
K7806M-21	7314151823597	1	175
K7806M-22	7314151805975	1	175
K7806M-23	7314151844738	1	175
K7806M-24	7314151805982	1	175
K7806M-27	7314151805999	1	175
K7806M-30	7314151844578	1	175
K7806M-32	7314150220304	1	175
K7806M-36	7314150220311	1	175
K7806M/S4	7314151813222	1	178
K7806Z-1	7314150137817	5	176
K7806Z-1.1/16	7314150137824	5	176
K7806Z-1.1/2	7314150137886	5	176
K7806Z-1.1/4	7314150137848	5	176
K7806Z-1.1/8	7314150137831	5	176
K7806Z-1.3/8	7314150137862	5	176
K7806Z-1.5/16	7314150137855	5	176
K7806Z-1.7/16	7314150137879	5	176
K7806Z-1/2	7314150137749	10	176
K7806Z-11/16	7314150137770	5	176
K7806Z-13/16	7314150137794	5	176



K7806Z-15/16	7314150137718	5	176
K7806Z-3/4	7314150137787	5	176
K7806Z-3/8	7314150137725	10	176
K7806Z-5/8	7314150137763	5	176
K7806Z-7/16	7314150137732	5	176
K7806Z-7/8	7314150137800	5	176
K7806Z-9/16	7314150137756	10	176
K7806Z/10	7314150165025	1	178
K8160D-1	7314151237400	1	177
K8160D-2	7314151237417	1	177
K8160D-3	7314151237424	1	177
K8164C	7314151237523	1	174
K8164F	7314151237554	1	180
K8167S	7314151237592	1	177
K8901M-17	7314151803155	1	179
K8901M-18	7314151844189	1	179
K8901M-19	7314151803162	1	179
K8901M-21	7314151803179	1	179
K8901M-22	7314151803186	1	179
K8901M-23	7314151803193	1	179
K8901M-24	7314151803209	1	179
K8901M-27	7314151803216	1	179
K8901M-28	7314151803223	1	179
K8901M-29	7314151803230	1	179
K8901M-30	7314151803247	1	179
K8901M-32	7314151803254	1	179
K8901M-33	7314151803261	1	179
K8901M-34	7314151803278	1	179
K8901M-36	7314151803285	1	179
K8901M-38	7314151803292	1	179
K8901M-41	7314151803308	1	179
K8901M-46	7314151803315	1	179
K8901M-50	7314151846398	1	179
K8901M-55	7314151846404	1	179
K8901M-60	7314151846411	1	179
K8901M/8	7314150165032	1	177
K8901Z-1	7314151844752	1	180
K8901Z-1.1/16	7314151844769	1	180
K8901Z-1.1/2	7314151844820	1	180
K8901Z-1.1/4	7314151844783	1	180
K8901Z-1.1/8	7314151844776	1	180
K8901Z-1.11/16	7314150130269	1	180
K8901Z-1.13/16	7314150130276	1	180
K8901Z-1.15/16	7314150130290	1	180
K8901Z-1.3/16	7314150130245	1	180
K8901Z-1.3/4	7314151844844	1	180
K8901Z-1.3/8	7314151844806	1	180
K8901Z-1.5/16	7314151844790	1	180
K8901Z-1.5/8	7314151844837	1	180
K8901Z-1.7/16	7314151844813	1	180
K8901Z-1.7/8	7314150130283	1	180
K8901Z-1.9/16	7314150130252	1	180
K8901Z-11/16	7314150130238	1	180
K8901Z-13/16	7314151844226	1	180
K8901Z-15/16	7314151844745	1	180
K8901Z-2	7314150130306	1	180
K8901Z-2.1/16	7314150130313	1	180
K8901Z-2.1/4	7314150130344	1	180
K8901Z-2.3/16	7314150130337	1	180
K8901Z-2.3/8	7314150130351	1	180
K8901Z-3/4	7314151844202	1	180
K8901Z-7/8	7314151844301	1	180
K8901Z/8	7314150436514	1	181
K8901Z/8	7314150165049	1	181
K8906M-17	7314151803056	1	179
K8906M-19	7314151803063	1	179
K8906M-21	7314151844851	1	179
K8906M-22	7314151803070	1	179
K8906M-24	7314151803087	1	179
K8906M-27	7314151803094	1	179
K8906M-30	7314151803117	1	179
K8906M-32	7314151803124	1	179
K8906M-33	7314151844868	1	179
K8906M-34	7314151844875	1	179
K8906M-36	7314151803148	1	179
K8906M-41	7314151845254	1	179
K8906M-46	7314150220601	1	179
K8906M/8	7314150165056	1	181
K8906Z-1	7314150130436	1	180
K8906Z-1.1/16	7314150130443	1	180
K8906Z-1.1/2	7314150130511	1	180
K8906Z-1.1/4	7314150130474	1	180
K8906Z-1.1/8	7314150130450	1	180
K8906Z-1.3/4	7314150130559	1	180
K8906Z-1.3/8	7314150130498	1	180
K8906Z-1.5/16	7314150130481	1	180
K8906Z-1.5/8	7314150130535	1	180
K8906Z-1.7/16	7314150130504	1	180
K8906Z-13/16	7314150130405	1	180
K8906Z-15/16	7314150130429	1	180
K8906Z-2	7314150130580	1	180
K8906Z-3/4	7314150130399	1	180
K8906Z-7/8	7314150130412	1	180
K8906Z/8	7314150165063	1	181
K8909H-5	7314151619343	1	181
K8909ML-12	7314151232863	1	183



K8909ML-14	7314151232870	1	183
K8909ML-17	7314151232887	1	183
K8960F-2	7314151268138	1	181
K8960F-3	7314151268145	1	181
K8960F-4	7314150220625	1	181
K8964D	7314151268237	1	177
K8964G	7314151268268	1	182
K8967S	7314151268329	1	180
K9501M-22	7314151844882	1	182
K9501M-24	7314151802677	1	182
K9501M-27	7314151802684	1	182
K9501M-30	7314151802714	1	182
K9501M-32	7314151802721	1	182
K9501M-33	7314151802738	1	182
K9501M-34	7314151802745	1	182
K9501M-36	7314151802752	1	182
K9501M-38	7314151802769	1	182
K9501M-41	7314151802776	1	182
K9501M-42	7314151802783	1	182
K9501M-46	7314151802790	1	182
K9501M-50	7314151802806	1	182
K9501M-55	7314151802813	1	182
K9501M-60	7314151802820	1	182
K9501M-65	7314151802837	1	182
K9501M-70	7314151802844	1	182
K9501M-75	7314151802851	1	182
K9501M-80	7314151802868	1	182
K9501M-85	7314150352197	1	182
K9501Z-1	7314151844912	1	182
K9501Z-1.1/16	7314150130634	1	182
K9501Z-1.1/2	7314151844943	1	182
K9501Z-1.1/4	7314151844929	1	182
K9501Z-1.1/8	7314150130641	1	182
K9501Z-1.11/16	7314150130696	1	182
K9501Z-1.13/16	7314151844967	1	182
K9501Z-1.15/16	7314150130719	1	182
K9501Z-1.3/16	7314150130658	1	182
K9501Z-1.3/4	7314150130702	1	182
K9501Z-1.3/8	7314150130672	1	182
K9501Z-1.5/16	7314150130665	1	182
K9501Z-1.5/8	7314151844950	1	182
K9501Z-1.7/16	7314151844936	1	182
K9501Z-1.7/8	7314151844974	1	182
K9501Z-1.9/16	7314150130689	1	182
K9501Z-2	7314150130726	1	182
K9501Z-2.1/4	7314150130764	1	182
K9501Z-2.1/8	7314150130740	1	182
K9501Z-2.3/16	7314150130757	1	182
K9501Z-2.3/4	7314150130832	1	182
K9501Z-2.5/16	7314150130771	1	182
K9501Z-2.9/16	7314150130801	1	182
K9506M-22	7314151844998	1	182
K9506M-24	7314151802530	1	182
K9506M-27	7314151802547	1	182
K9506M-30	7314151802554	1	182
K9506M-32	7314151802561	1	182
K9506M-33	7314151802578	1	182
K9506M-34	7314151845018	1	182
K9506M-36	7314151802585	1	182
K9506M-38	7314151802592	1	182
K9506M-41	7314151802608	1	182
K9506M-46	7314151802615	1	182
K9506M-50	7314151802622	1	182
K9506M-55	7314151802639	1	182
K9506M-60	7314151802646	1	182
K9506Z-1	7314150131686	1	182
K9506Z-1.1/16	7314150131693	1	182
K9506Z-1.1/2	7314150131761	1	182
K9506Z-1.1/4	7314150131723	1	182
K9506Z-1.13/16	7314150131808	1	182
K9506Z-1.3/16	7314150131716	1	182
K9506Z-1.5/8	7314150131785	1	182
K9506Z-1.7/16	7314150131754	1	182
K9506Z-1.7/8	7314150131815	1	182
K9509H5	7314151619428	1	182
K9509ML-19	7314151618964	1	183
K9509ML-22	7314151619183	1	183
K9509ML-24	7314151619268	1	183
K9560G-0	7314150240012	1	183
K9560G-1	7314151285944	1	183
K9560G-2	7314151285951	1	183
K9560G-3	7314151285968	1	183
K9560G-4	7314150133970	1	183
K9560G-5	7314150133987	1	183
K9564F	7314151286026	1	180
K9567S	7314151286095	1	183
K9598H	7314150133956	1	184
K9801M-100	7314151845162	1	183
K9801M-105	7314151845179	1	183
K9801M-110	7314151845186	1	183
K9801M-115	7314151845193	1	183
K9801M-120	7314151845209	1	183
K9801M-125	7314150167159	1	183
K9801M-130	7314150167166	1	183
K9801M-135	7314150167173	1	183
K9801M-140	7314150167180	1	183



K9801M-145	7314150167197	1	183
K9801M-150	7314150167203	1	183
K9801M-155	7314150167210	1	183
K9801M-46	7314151845056	1	183
K9801M-50	7314151845063	1	183
K9801M-55	7314151845070	1	183
K9801M-60	7314151845087	1	183
K9801M-65	7314151845094	1	183
K9801M-70	7314151845100	1	183
K9801M-75	7314151845117	1	183
K9801M-80	7314151845124	1	183
K9801M-85	7314151845131	1	183
K9801M-90	7314151845148	1	183
K9801M-95	7314151845155	1	183
K9801Z-1.1/2	7314150131976	1	184
K9801Z-1.11/16	7314150132003	1	184
K9801Z-1.13/16	7314150132027	1	184
K9801Z-1.15/16	7314150132041	1	184
K9801Z-1.3/4	7314150132010	1	184
K9801Z-1.3/8	7314150131952	1	184
K9801Z-1.5/8	7314150131990	1	184
K9801Z-1.7/16	7314150131969	1	184
K9801Z-1.7/8	7314150132034	1	184
K9801Z-1.9/16	7314150131983	1	184
K9801Z-2	7314150132058	1	184
K9801Z-2.1/16	7314150132065	1	184
K9801Z-2.1/2	7314150132133	1	184
K9801Z-2.1/4	7314150132096	1	184
K9801Z-2.1/8	7314150132072	1	184
K9801Z-2.11/16	7314150132164	1	184
K9801Z-2.13/16	7314150132188	1	184
K9801Z-2.15/16	7314150132201	1	184
K9801Z-2.3/16	7314150132089	1	184
K9801Z-2.3/4	7314150132171	1	184
K9801Z-2.3/8	7314150132119	1	184
K9801Z-2.5/16	7314150132102	1	184
K9801Z-2.5/8	7314150132157	1	184
K9801Z-2.7/16	7314150132126	1	184
K9801Z-2.7/8	7314150132195	1	184
K9801Z-2.9/16	7314150132140	1	184
K9801Z-3	7314150132218	1	184
K9801Z-3.1/16	7314150132225	1	184
K9801Z-3.1/2	7314150132287	1	184
K9801Z-3.1/4	7314150132249	1	184
K9801Z-3.1/8	7314150132232	1	184
K9801Z-3.11/16	7314150132317	1	184
K9801Z-3.13/16	7314150132331	1	184
K9801Z-3.15/16	7314150132355	1	184
K9801Z-3.3/4	7314150132324	1	184
K9801Z-3.3/8	7314150132263	1	184
K9801Z-3.5/16	7314150132256	1	184
K9801Z-3.5/8	7314150132300	1	184
K9801Z-3.7/16	7314150132270	1	184
K9801Z-3.7/8	7314150132348	1	184
K9801Z-3.9/16	7314150132294	1	184
K9801Z-4	7314150132362	1	184
K9801Z-4.1/16	7314150132379	1	184
K9801Z-4.1/2	7314150132430	1	184
K9801Z-4.1/4	7314150132393	1	184
K9801Z-4.1/8	7314150132386	1	184
K9801Z-4.3/4	7314150132454	1	184
K9801Z-4.3/8	7314150132416	1	184
K9801Z-4.5/16	7314150132409	1	184
K9801Z-4.5/8	7314150132447	1	184
K9801Z-4.7/16	7314150132423	1	184
K9806M-100	7314150131105	1	183
K9806M-105	7314150131112	1	183
K9806M-110	7314150131129	1	183
K9806M-115	7314150131136	1	183
K9806M-120	7314150131143	1	183
K9806M-41	7314150130986	1	183
K9806M-46	7314150130993	1	183
K9806M-50	7314150131006	1	183
K9806M-55	7314150131013	1	183
K9806M-60	7314150131020	1	183
K9806M-65	7314150131037	1	183
K9806M-70	7314150131044	1	183
K9806M-75	7314150131051	1	183
K9806M-80	7314150131068	1	183
K9806M-85	7314150131075	1	183
K9806M-90	7314150131082	1	183
K9806M-95	7314150131099	1	183
K9806Z-1.1/2	7314150131174	1	184
K9806Z-1.11/16	7314150131198	1	184
K9806Z-1.3/8	7314150131150	1	184
K9806Z-1.5/8	7314150131181	1	184
K9806Z-1.7/16	7314150131167	1	184
K9806Z-2	7314150131204	1	184
K9806Z-2.1/16	7314150131211	1	184
K9806Z-2.1/2	7314150131273	1	184
K9806Z-2.1/4	7314150131235	1	184
K9806Z-2.11/16	7314150131303	1	184
K9806Z-2.13/16	7314150131327	1	184
K9806Z-2.15/16	7314150131341	1	184
K9806Z-2.3/16	7314150131228	1	184
K9806Z-2.3/4	7314150131310	1	184



K9806Z-2.3/8



K9806Z-2.3/8	7314150131259	1	184
K9806Z-2.5/16	7314150131242	1	184
K9806Z-2.5/8	7314150131297	1	184
K9806Z-2.7/16	7314150131266	1	184
K9806Z-2.7/8	7314150131334	1	184
K9806Z-2.9/16	7314150131280	1	184
K9806Z-3	7314150131358	1	184
K9806Z-3.1/16	7314150131365	1	184
K9806Z-3.1/2	7314150131433	1	184
K9806Z-3.1/4	7314150131396	1	184
K9806Z-3.1/8	7314150131372	1	184
K9806Z-3.11/16	7314150131464	1	184
K9806Z-3.13/16	7314150131488	1	184
K9806Z-3.15/16	7314150131501	1	184
K9806Z-3.3/16	7314150131389	1	184
K9806Z-3.3/4	7314150131471	1	184
K9806Z-3.3/8	7314150131419	1	184
K9806Z-3.5/16	7314150131402	1	184
K9806Z-3.5/8	7314150131457	1	184
K9806Z-3.7/16	7314150131426	1	184
K9806Z-3.7/8	7314150131495	1	184
K9806Z-3.9/16	7314150131440	1	184
K9806Z-4	7314150131518	1	184
K9806Z-4.1/16	7314150131525	1	184
K9806Z-4.1/2	7314150131570	1	184
K9806Z-4.1/4	7314150131549	1	184
K9806Z-4.1/8	7314150131532	1	184
K9806Z-4.3/4	7314150131594	1	184
K9806Z-4.3/8	7314150131563	1	184
K9806Z-4.5/16	7314150131556	1	184
K9806Z-4.5/8	7314150131587	1	184
K9860H-1	7314150133994	1	184
K9860H-2	7314150134007	1	184
K9860H-3	7314150134014	1	184
K9867S	7314150133932	1	184
K9895G	7314150133949	1	183
K9899H	7314150166763	1	185
K9998H	7314150133963	1	185
KB09-01	7314150196968	5	595
KB18-01	7314150196944	5	595
KBFU-01	7314150196913	5	594
KBGH-5P-DISPEN	7314150296729	20	595
KBGR-5P-DISPEN	7314150296774	20	595
KBGU-100P	7314150213405	1	595
KBGU-10P-DISPEN	7314150262984	20	595
KBGU-5P-DISPEN	7314150296705	20	595
KBRU-01	7314150196876	5	594
KBSK-01	7314150196999	5	597
KBSU-01	7314150197002	5	597
KBTU-01	7314150196982	5	597
KBWS-01	7314150225972	10	600
KCB753	7314150204915	1	171
KE18-01	7314150196937	5	594
KEFU-01	7314150196906	5	594
KERU-01	7314150196869	5	594
KEYRING	7314150500864	50	380
KG09-01	7314150196975	5	596
KG09-01-3P	7314150213962	10	596
KG18-01	7314150196951	5	596
KGAU-01	7314150223893	5	596
KGFU-01	7314150196920	5	594
KGRU-01	7314150196883	5	594
KGRU-02	7314150196890	5	594
KGSU-01	7314150197019	5	597
KHU-01	7314150268955	4	596
KM1/4-5/16-1P	7314150275953	50	172
KM100-SH	7314150215690	1	171
KM653	7314151786915	1	171
KM653-1P	7314151840709	25	171
KM653-QR	7314150115983	1	170
KM653-QR-1P	7314151848507	50	170
KM653-SF	7314150204984	1	171
KM6701M-10	7314151844264	1	173
KM6701M-7	7314151844240	1	173
KM6701M-8	7314151844257	1	173
KM6750-1/4	7314150204595	1	170
KM6750-10	7314150204649	20	170
KM6750-11	7314150302628	1	170
KM6750-13	7314150204632	1	170
KM6750-3/8	7314150204588	1	170
KM6750-6	7314150204601	1	170
KM6750-7	7314150204618	1	170
KM6750-8	7314150204625	1	170
KM753-QR-1P	7314150204830	1	171
KMR150	7314150204960	1	172
KMR150-1P	7314150204977	1	172
KMR653	7314150204922	1	171
KMR653-1P	7314150204939	1	171
KMR753	7314150204946	1	171
KMR753-1P	7314150204953	1	171
KMT753-QR-1P	7314150391523	50	171
KMU-01	7314150197026	5	594
KR653	7314150204885	1	171
KR653-1P	7314150206263	25	171
KRSS-01	7314150214938	10	600
KS7401M-10	7314150384495	1	174



KS7401M-11	7314150384501	1	174
KS7401M-12	7314150384518	1	174
KS7401M-13	7314150384525	1	174
KS7401M-14	7314150384532	1	174
KS7401M-15	7314150384549	1	174
KS7401M-16	7314150384556	1	174
KS7401M-17	7314150384563	1	174
KS7401M-18	7314150384570	1	174
KS7401M-19	7314150384587	1	174
KS7401M-22	7314150384594	1	174
KS7401M-9	7314150384600	1	174
KSBG09-10DISPEN	7314150262991	20	596
KSBG18-10DISPEN	7314150263004	20	596
KSR753	7314150204892	1	541
KSR753-1P	7314150204908	1	541
KUBG09-5P	7314150213450	20	596
KUBG18-5DISPEN	7314150296835	20	596
KUBG18-5P	7314150213443	20	596
L1020I06	7314150501649	5	147
L1020M06	7311518133665	1	145
L1020M06X	7311518136369	1	145
L1020S06	7314150501670	5	147
L1225M06	7311518132774	1	145
L1225M06X	7311518136857	1	145
L1228I06	7314150501700	5	147
L1228S06	7314150501731	5	147
L1230AL06	7311518187668	1	146
L1230AL08	7311518181871	1	146
L1230M06	7311518182168	1	145
L1230M06X	7311518182175	1	145
L1630M06	7311518192914	1	145
L1630M06X	7311518187446	1	145
L1630M08	7311518182205	1	145
L1630M08X	7311518136833	1	145
LAP-KNIFE	7311518216443	10	649
LARGE	7314150437429	1	435
LS-6160-23	7311518041304	1	651
LS-COIN 19 CM	7311518031077	1	616
LS-COIN 26 CM	7311518333041	2	616
LS-COMBINESS	7311518041366	1	651
LS-MASSE-4	7311518012014	2	615
LS-MASSE-4FG	7311518275891	2	615
LS-MASSE-TR-4FG	7311518281106	2	615
LS-MERLIN-2.5	7311518012069	2	615
LS-MERLIN-2.5FG	7311518281113	2	615
LS-PIERRE CORINDON	7311518009977	1	651
LS-PIERRE-FAUX	7311518009038	1	651
LST-30111	7314150337262	5	630
LST-51121	7314150337231	5	630
LST-52121	7314150337224	5	630
LST-63102	7314150337330	5	630
LST-70120	7314150337255	5	630
LST-72324	7314150337163	5	630
LST-99102	7314150337354	4	630
LT-STEEL-30	7314150138012	5	553
LT-STEEL-50	7314150138029	5	553
LTB-10	7314150120048	6	553
LTB-20	7314150120062	6	553
LTB-30	7314150120086	6	553
LTG-10	7314150119981	6	553
LTG-20	7314150120000	6	553
LTG-30	7314150120024	6	553
LTS-100	7314150120147	5	553
LTS-100-E	7314150120154	5	553
LTS-30	7314150120109	5	553
LTS-30-E	7314150120116	5	553
LTS-50	7314150120123	5	553
LTS-50-E	7314150120130	5	553
LUB-2015	7311518335427	6	651
M0310M03	7311518036805	1	145
M0310M03X	7311518197063	1	145
M0613M03X	7311518196622	1	145
M0618M06	7311518036836	1	145
M0618M06X	7311518036850	1	145
M1022M06	7311518036881	1	145
M1022M06X	7311518036904	1	145
M1227M06	7311518036928	1	145
M1227M06X	7311518036959	1	145
M1227M08	7311518036980	1	145
M1630M06	7311518193010	1	145
M1630M06X	7311518187453	1	145
M1630M08	7311518037062	1	145
M1630M08X	7311518037086	1	145
M227L	7311518160883	4	591
M227R	7311518160869	4	592
M330	7311518160906	4	592
M526	7311518160982	4	592
M6376	7311518196486	1	592
M6376-SH	7311518199296	1	592
M676	7311518161088	1	592
M676-SH	7311518211875	1	592
M780	7314151826215	1	219
M781	7314153016218	5	219
M926	7311518161071	1	593
M926-SH	7314150107537	1	593
MA225	7311518161057	4	590



MA225L	7311518161033	4	590
MA225R	7311518161040	4	590
MA311	7314150181568	1	590
MA321	7314150181551	10	590
MA325	7311518161064	4	591
MA351	7314150181582	10	591
MA361	7314150181575	10	591
MA401	7314150167593	10	590
MA411	7314150167609	10	590
MA421	7314150167616	10	590
MA431	7314150181544	1	590
MAM50M	7314150215300	1	117
MCP-2.5-810	7311518124052	2	615
MES-3.0-900	7311518123864	2	615
MES-3.5-900	7311518123871	2	615
MES-3.5-900FG	7311518281120	2	615
MK5	7314150224333	1	59
MK9	7314150224326	1	59
MONSTER	7314150437405	1	435
MR227L	7311518161002	4	592
MR227R	7311518160999	4	592
MR340	7311518197537	2	591
MT-TS-3	7314150194995	12	552
MTB-3-16	7314150119066	6	552
MTB-3-16-M	7314150119073	6	552
MTB-3-16-M-E	7314150119141	6	552
MTB-5-25	7314150119080	6	552
MTB-5-25-C1	7314150119127	6	552
MTB-5-25-M	7314150119097	6	552
MTB-5-25-M-E	7314150119158	6	552
MTB-8-25	7314150125418	6	552
MTB-8-25-M	7314150127078	6	552
MTB-8-25-M-E	7314150127085	6	552
MTC-3-13	7314150321322	6	552
MTC-3-13-C1	7314150330843	6	552
MTC-5-16	7314150321339	6	552
MTC-5-16-C1	7314150330850	6	552
MTG-3-16	7314150118984	12	552
MTG-3-16-E	7314150119028	12	552
MTG-5-19	7314150118991	12	552
MTG-5-19-E	7314150119035	12	552
MTG-8-25	7314150330348	4	552
MTG-8-25-E	7314150390809	4	552
MTS-5-25	7314150119233	6	552
MTS-5-25-E	7314150119271	6	552
MTS-8-25	7314150119257	6	552
MTS-8-25-E	7314150119295	6	552
MTT051	7314150270521	6	600
MTT121	7314150213290	8	600
MTT151	7314150120703	6	600
MW-150	7314150125685	2	553
MW-250	7314150125678	2	553
N0306M03	7311518182212	1	145
N0306M03E	7311518182229	1	145
N0607M06	7311518182236	1	145
N1213M06	7311518134570	1	145
N1213M06X	7311518237172	1	145
N1613M06	7311518136000	1	145
N1613M06X	7311518204525	1	145
N1613M08	7311518182267	1	145
NP-12-COM	7311518264277	4	574
NP-12-TEN	7311518263959	10	578
NP-12-VEN	7311518264260	10	578
NP-16-U7/8-HP	7311518241773	4	575
NP-19-U7/8-HP	7311518241452	10	575
NP-22-F7/8-HP	7311518035204	10	576
NP-22-U7/8-HP	7311518034399	10	575
NS001-150	7314150316069	5	518
NS001-200	7314150316076	5	518
NS001-250	7314150316083	5	518
NS001-300	7314150316090	5	518
NS001-375	7314150325108	5	518
NS001-450	7314150325115	3	518
NS001-600	7314150325122	1	518
NS001-900	7314150325139	1	518
NS002-10	7314150284719	10	518
NS002-11	7314150292592	5	518
NS002-12	7314150292608	5	518
NS002-13	7314150284726	10	518
NS002-14	7314150284733	5	518
NS002-15	7314150292615	5	518
NS002-16	7314150292622	5	518
NS002-17	7314150284740	10	518
NS002-18	7314150292639	5	518
NS002-19	7314150284757	10	518
NS002-20	7314150292646	5	518
NS002-21	7314150292653	5	518
NS002-22	7314150292660	10	518
NS002-23	7314150292677	5	518
NS002-24	7314150292684	10	518
NS002-25	7314150292691	5	518
NS002-26	7314150292707	5	518
NS002-27	7314150284764	5	518
NS002-28	7314150292714	5	518
NS002-29	7314150292721	10	518
NS002-30	7314150292738	10	518



NS002-31	7314150292745	5	518
NS002-32	7314150284771	5	518
NS002-33	7314150292752	5	518
NS002-34	7314150292769	5	518
NS002-35	7314150292776	5	518
NS002-36	7314150284788	5	518
NS002-38	7314150292783	5	518
NS002-40	7314150292790	5	518
NS002-41	7314150292806	5	518
NS002-42	7314150292813	5	518
NS002-46	7314150292820	5	518
NS002-50	7314150292837	5	518
NS002-52	7314150292844	5	518
NS002-55	7314150292851	5	518
NS002-6	7314150292554	5	518
NS002-60	7314150292868	1	518
NS002-65	7314150292875	1	518
NS002-7	7314150292561	5	518
NS002-70	7314150292882	1	518
NS002-75	7314150292899	1	518
NS002-8	7314150292578	5	518
NS002-80	7314150292905	1	518
NS002-9	7314150292585	5	518
NS003-11	7314150306602	1	518
NS003-12	7314150306619	1	518
NS003-14	7314150306626	1	518
NS003-16	7314150306633	1	518
NS003-18	7314150320356	1	518
NS003-20	7314150320363	1	518
NS003-24	7314150320370	1	518
NS003-28	7314150320387	1	518
NS003-30	7314150320394	1	518
NS003-8	7314150320349	1	518
NS006-0607	7314150292912	1	519
NS006-0608	7314150292929	1	519
NS006-0708	7314150292936	1	519
NS006-0709	7314150292943	1	519
NS006-0809	7314150292967	1	519
NS006-0810	7314150292950	1	519
NS006-0910	7314150292974	1	519
NS006-0911	7314150292981	1	519
NS006-1011	7314150292998	1	519
NS006-1012	7314150293001	1	519
NS006-1013	7314150293018	1	519
NS006-1014	7314150293025	1	519
NS006-1113	7314150293032	1	519
NS006-1114	7314150293049	1	519
NS006-1213	7314150293056	1	519
NS006-1214	7314150293063	1	519
NS006-1315	7314150293070	1	519
NS006-1415	7314150293087	1	519
NS006-1416	7314150293094	1	519
NS006-1417	7314150293100	1	519
NS006-1617	7314150293117	1	519
NS006-1618	7314150293124	1	519
NS006-1719	7314150293131	1	519
NS006-1722	7314150293148	1	519
NS006-1819	7314150293155	1	519
NS006-1820	7314150293162	1	519
NS006-1920	7314150293179	1	519
NS006-1922	7314150293186	1	519
NS006-1924	7314150293193	1	519
NS006-2022	7314150293209	1	519
NS006-2122	7314150293216	1	519
NS006-2123	7314150293223	1	519
NS006-2223	7314150293230	1	519
NS006-2224	7314150293247	1	519
NS006-2227	7314150293254	1	519
NS006-2326	7314150293261	1	519
NS006-2425	7314150293278	1	519
NS006-2426	7314150293285	1	519
NS006-2427	7314150293292	1	519
NS006-2430	7314150293308	1	519
NS006-2528	7314150293315	1	519
NS006-2629	7314150293322	1	519
NS006-2729	7314150293339	1	519
NS006-2730	7314150293346	1	519
NS006-2732	7314150293353	1	519
NS006-2830	7314150293360	1	519
NS006-3031	7314150293377	1	519
NS006-3032	7314150293384	1	519
NS006-3034	7314150293391	1	519
NS006-3036	7314150293407	1	519
NS006-3234	7314150293414	1	519
NS006-3235	7314150293421	1	519
NS006-3236	7314150293438	1	519
NS006-3335	7314150293445	1	519
NS006-3436	7314150293452	1	519
NS006-3536	7314150293469	1	519
NS006-3638	7314150293476	1	519
NS006-3641	7314150293483	1	519
NS006-3642	7314150293490	1	519
NS006-4146	7314150293506	1	519
NS006-4650	7314150293513	1	519
NS006-5052	7314150293520	1	519
NS006-5055	7314150293537	1	519





NS006-5060	7314150293544	1	519
NS006-5062	7314150293551	1	519
NS006-5560	7314150293568	1	519
NS006-6065	7314150293575	1	519
NS006-6570	7314150293582	1	519
NS010-0607	7314150293599	1	520
NS010-0709	7314150293605	1	520
NS010-0809	7314150293612	1	520
NS010-0911	7314150293629	1	520
NS010-1011	7314150293636	1	520
NS010-1012	7314150293643	1	520
NS010-1214	7314150293650	1	520
NS010-1315	7314150293667	1	520
NS010-1417	7314150293674	1	520
NS010-1618	7314150293681	1	520
NS010-1719	7314150293698	1	520
NS010-1722	7314150293704	1	520
NS010-1819	7314150293711	1	520
NS010-1921	7314150293728	1	520
NS010-1922	7314150293735	1	520
NS010-2022	7314150293742	1	520
NS010-2123	7314150293759	1	520
NS010-2224	7314150293766	1	520
NS010-2427	7314150293773	1	520
NS010-2528	7314150293780	1	520
NS010-2628	7314150293797	1	520
NS010-2730	7314150293803	1	520
NS010-2732	7314150293810	1	520
NS010-3032	7314150293827	1	520
NS010-3036	7314150293834	1	520
NS010-3236	7314150293841	1	520
NS010-3641	7314150293858	1	520
NS010-4146	7314150293865	1	520
NS010-4650	7314150293872	1	520
NS011-0607	7314150317271	1	520
NS011-0809	7314150317288	1	520
NS011-1011	7314150317295	1	520
NS011-1213	7314150317301	1	520
NS011-1415	7314150317318	1	520
NS011-1617	7314150317325	1	520
NS011-1819	7314150317332	1	520
NS011-2022	7314150317349	1	520
NS011-2123	7314150317356	1	520
NS011-2426	7314150317363	1	520
NS011-2528	7314150317370	1	520
NS011-2729	7314150317387	1	520
NS011-3032	7314150317394	1	520
NS041-12-50	7314150502547	1	536
NS041-16-100	7314150502561	1	536
NS041-16-200	7314150502332	1	536
NS041-16-260	7314150502585	1	536
NS041-24-670	7314150502608	1	536
NS041-32-900	7314150502622	1	536
NS041-8-25	7314150502646	1	536
NS100-100	7314150294305	1	521
NS100-105	7314150294312	1	521
NS100-110	7314150294329	1	521
NS100-115	7314150294336	1	521
NS100-120	7314150294343	1	521
NS100-17	7314150293889	1	520
NS100-19	7314150293896	1	520
NS100-22	7314150293902	1	520
NS100-24	7314150293919	1	520
NS100-25	7314150293926	1	520
NS100-27	7314150293933	1	520
NS100-28	7314150293940	1	520
NS100-29	7314150293957	1	520
NS100-30	7314150293964	1	520
NS100-32	7314150293971	1	520
NS100-33	7314150293988	1	520
NS100-34	7314150293995	1	520
NS100-35	7314150294008	1	520
NS100-36	7314150294015	1	520
NS100-37	7314150294022	1	520
NS100-38	7314150294039	1	520
NS100-41	7314150294046	1	520
NS100-42	7314150294053	1	520
NS100-45	7314150294060	1	520
NS100-46	7314150294077	1	521
NS100-47	7314150294084	1	521
NS100-50	7314150294091	1	521
NS100-52	7314150294107	1	521
NS100-54	7314150294114	1	521
NS100-55	7314150294121	1	521
NS100-56	7314150294138	1	521
NS100-58	7314150294145	1	521
NS100-60	7314150294152	1	521
NS100-63	7314150294169	1	521
NS100-65	7314150294176	1	521
NS100-67	7314150294183	1	521
NS100-70	7314150294190	1	521
NS100-71	7314150294206	1	521
NS100-75	7314150294213	1	521
NS100-77	7314150294220	1	521
NS100-80	7314150294237	1	521
NS100-82	7314150294244	1	521



NS100-85	7314150294251	1	521
NS100-88	7314150294268	1	521
NS100-90	7314150294275	1	521
NS100-94	7314150294282	1	521
NS100-95	7314150294299	1	521
NS104-100	7314150294947	1	521
NS104-105	7314150294954	1	521
NS104-110	7314150294961	1	521
NS104-115	7314150294978	1	521
NS104-120	7314150294985	1	521
NS104-17	7314150294350	1	521
NS104-19	7314150294367	1	521
NS104-20	7314150294374	1	521
NS104-22	7314150294381	1	521
NS104-24	7314150284795	1	521
NS104-25	7314150294398	1	521
NS104-26	7314150294404	1	521
NS104-27	7314150284801	1	521
NS104-28	7314150294411	1	521
NS104-29	7314150294428	1	521
NS104-30	7314150284818	1	521
NS104-31	7314150294435	1	521
NS104-32	7314150284825	1	521
NS104-33	7314150294442	1	521
NS104-34	7314150294459	1	521
NS104-35	7314150294466	1	521
NS104-36	7314150284832	1	521
NS104-37	7314150294473	1	521
NS104-38	7314150294480	1	521
NS104-39	7314150294497	1	521
NS104-40	7314150294503	1	521
NS104-41	7314150284849	1	521
NS104-42	7314150294510	1	521
NS104-43	7314150294527	1	521
NS104-44	7314150294534	1	521
NS104-45	7314150294541	1	521
NS104-46	7314150284856	1	521
NS104-47	7314150294558	1	521
NS104-48	7314150294565	1	521
NS104-49	7314150294572	1	521
NS104-50	7314150284863	1	521
NS104-51	7314150294589	1	521
NS104-52	7314150294596	1	521
NS104-53	7314150294602	1	521
NS104-54	7314150294619	1	521
NS104-55	7314150284870	1	521
NS104-56	7314150294626	1	521
NS104-57	7314150294633	1	521
NS104-58	7314150294640	1	521
NS104-59	7314150294657	1	521
NS104-60	7314150284887	1	521
NS104-61	7314150294664	1	521
NS104-62	7314150294671	1	521
NS104-63	7314150294688	1	521
NS104-64	7314150294695	1	521
NS104-65	7314150294701	1	521
NS104-66	7314150294718	1	521
NS104-67	7314150294725	1	521
NS104-68	7314150294732	1	521
NS104-69	7314150294749	1	521
NS104-70	7314150284894	1	521
NS104-71	7314150294756	1	521
NS104-72	7314150294763	1	521
NS104-73	7314150294770	1	521
NS104-74	7314150294787	1	521
NS104-75	7314150284900	1	521
NS104-76	7314150294794	1	521
NS104-77	7314150294800	1	521
NS104-78	7314150294817	1	521
NS104-79	7314150294824	1	521
NS104-80	7314150284917	1	521
NS104-81	7314150294831	1	521
NS104-82	7314150294848	1	521
NS104-83	7314150294855	1	521
NS104-84	7314150294862	1	521
NS104-85	7314150284924	1	521
NS104-86	7314150294879	1	521
NS104-87	7314150294886	1	521
NS104-88	7314150294893	1	521
NS104-89	7314150294909	1	521
NS104-90	7314150284931	1	521
NS104-92	7314150294916	1	521
NS104-94	7314150294923	1	521
NS104-95	7314150284948	1	521
NS104-98	7314150294930	1	521
NS106-100	7314150295418	1	522
NS106-104	7314150295425	1	522
NS106-108	7314150295432	1	522
NS106-112	7314150295449	1	522
NS106-114	7314150295456	1	522
NS106-116	7314150295463	1	522
NS106-120	7314150295470	1	522
NS106-124	7314150295487	1	522
NS106-126	7314150295494	1	522
NS106-128	7314150295500	1	522
NS106-132	7314150295517	1	522



NS106-136	7314150295524	1	522
NS106-138	7314150295531	1	522
NS106-144	7314150295548	1	522
NS106-146	7314150295555	1	522
NS106-150	7314150295562	1	522
NS106-156	7314150295579	1	522
NS106-158	7314150295586	1	522
NS106-20	7314150294992	1	522
NS106-22	7314150295005	1	522
NS106-24	7314150295012	1	522
NS106-25	7314150295029	1	522
NS106-26	7314150295036	1	522
NS106-28	7314150295043	1	522
NS106-30	7314150295050	1	522
NS106-32	7314150295067	1	522
NS106-34	7314150295074	1	522
NS106-36	7314150295081	1	522
NS106-38	7314150295098	1	522
NS106-40	7314150295104	1	522
NS106-42	7314150295111	1	522
NS106-44	7314150295128	1	522
NS106-45	7314150295135	1	522
NS106-46	7314150295142	1	522
NS106-48	7314150295159	1	522
NS106-50	7314150295166	1	522
NS106-52	7314150295173	1	522
NS106-54	7314150295180	1	522
NS106-56	7314150295197	1	522
NS106-58	7314150295203	1	522
NS106-60	7314150295210	1	522
NS106-62	7314150295227	1	522
NS106-64	7314150295234	1	522
NS106-66	7314150295241	1	522
NS106-68	7314150295258	1	522
NS106-70	7314150295265	1	522
NS106-71	7314150295272	1	522
NS106-72	7314150295289	1	522
NS106-74	7314150295296	1	522
NS106-76	7314150295302	1	522
NS106-78	7314150295319	1	522
NS106-80	7314150295326	1	522
NS106-82	7314150295333	1	522
NS106-84	7314150295340	1	522
NS106-88	7314150295357	1	522
NS106-90	7314150295364	1	522
NS106-92	7314150295371	1	522
NS106-94	7314150295388	1	522
NS106-96	7314150295395	1	522
NS106-98	7314150295401	1	522
NS200-1200	7314150295661	1	523
NS200-200	7314150295593	1	523
NS200-250	7314150295609	1	523
NS200-300	7314150295616	1	523
NS200-350	7314150295623	1	523
NS200-450	7314150295630	1	523
NS200-600	7314150295647	1	523
NS200-900	7314150295654	1	523
NS202-350	7314150299690	1	523
NS203-200	7314150359509	1	523
NS203-215	7314150359516	1	523
NS203-290	7314150359523	1	523
NS203-400	7314150359530	1	523
NS203-490	7314150359547	1	523
NS203-800	7314150359554	1	523
NS204-30	7314150295685	1	523
NS204-32	7314150295692	1	523
NS204-35	7314150295708	1	523
NS204-40	7314150295715	1	523
NS204-45	7314150295722	1	523
NS204-48	7314150295739	1	523
NS204-50	7314150295746	1	523
NS204-55	7314150295753	1	523
NS204-60	7314150295760	1	523
NS204-65	7314150295777	1	523
NS204-70	7314150295784	1	523
NS204-75	7314150295791	1	523
NS204-80	7314150295807	1	523
NS204-85	7314150295814	1	523
NS204-90	7314150295821	1	523
NS220-06	7314150347216	1	524
NS220-07	7314150347223	1	524
NS220-08	7314150347230	1	524
NS220-09	7314150347247	1	524
NS220-10	7314150347254	1	524
NS220-11	7314150347261	1	524
NS220-12	7314150347278	1	524
NS220-13	7314150347285	1	524
NS220-14	7314150347292	1	524
NS220-15	7314150347308	1	524
NS220-16	7314150347315	1	524
NS220-17	7314150347322	1	524
NS220-18	7314150347339	1	524
NS220-19	7314150347346	1	524
NS220-20	7314150347353	1	524
NS220-21	7314150347360	1	524
NS220-22	7314150347377	1	524



NS220-23	7314150347384	1	524
NS220-24	7314150347391	1	524
NS220-25	7314150347407	1	524
NS220-26	7314150347414	1	524
NS220-27	7314150347421	1	524
NS220-28	7314150347438	1	524
NS220-29	7314150347445	1	524
NS220-30	7314150347452	1	524
NS220-32	7314150347469	1	524
NS220-34	7314150347476	1	524
NS220-36	7314150347483	1	524
NS220-41	7314150347490	1	524
NS224-17	7314150355525	1	524
NS224-18	7314150355532	1	524
NS224-19	7314150355549	1	524
NS224-21	7314150355556	1	524
NS224-22	7314150355563	1	524
NS224-23	7314150355570	1	524
NS224-24	7314150355587	1	524
NS224-26	7314150355594	1	524
NS224-27	7314150355617	1	524
NS224-28	7314150355624	1	524
NS224-29	7314150355631	1	524
NS224-30	7314150355648	1	524
NS224-32	7314150355655	1	524
NS224-34	7314150355662	1	524
NS224-36	7314150355679	1	524
NS224-38	7314150355686	1	524
NS224-41	7314150355693	1	524
NS224-46	7314150355709	1	524
NS224-50	7314150355716	1	524
NS228-22	7314150355914	1	525
NS228-24	7314150355921	1	525
NS228-26	7314150355938	1	525
NS228-27	7314150355945	1	525
NS228-28	7314150355952	1	525
NS228-29	7314150355969	1	525
NS228-30	7314150355976	1	525
NS228-31	7314150355983	1	525
NS228-32	7314150355990	1	525
NS228-34	7314150356003	1	525
NS228-36	7314150356010	1	525
NS228-38	7314150356027	1	525
NS228-41	7314150356034	1	525
NS228-46	7314150356041	1	525
NS228-50	7314150356058	1	525
NS228-55	7314150356065	1	525
NS228-60	7314150356072	1	525
NS228-65	7314150356089	1	525
NS228-70	7314150356096	1	525
NS228-75	7314150356102	1	525
NS228-80	7314150356119	1	525
NS232-16-24	7314150356331	1	525
NS232-24-16	7314150356355	1	525
NS232-24-32	7314150356348	1	525
NS232-32-24	7314150356362	1	525
NS234-16-100	7314150356416	1	525
NS234-16-200	7314150356423	1	525
NS234-16-250	7314150356430	1	525
NS234-24-200	7314150356447	1	525
NS234-32-250	7314150356454	1	525
NS236-16	7314150356522	1	525
NS236-24	7314150356539	1	525
NS236-32	7314150356515	1	525
NS238-16-250	7314150356577	1	526
NS238-24-250	7314150356584	1	526
NS238-32-300	7314150356591	1	526
NS240-16-230	7314150356737	1	526
NS242-16	7314150356638	1	526
NS242-24	7314150356645	1	526
NS242-32	7314150356652	1	526
NS243-16-400	7314150356690	1	526
NS247-26	7314150356751	1	527
NS248-16-52	7314150356713	1	527
NS300-10-200	7314150317783	1	527
NS300-10-300	7314150316205	1	527
NS300-11-250	7314150317790	1	527
NS300-11-300	7314150317806	1	527
NS300-11-350	7314150316212	1	527
NS300-12-400	7314150325153	1	527
NS300-13-450	7314150325160	1	527
NS300-3-50	7314150317677	1	527
NS300-3-75	7314150317684	1	527
NS300-4-75	7314150317691	1	527
NS300-4.5-100	7314150316175	1	527
NS300-4.5-50	7314150317707	1	527
NS300-5-100	7314150317721	1	527
NS300-5-75	7314150317714	1	527
NS300-6-100	7314150316182	1	527
NS300-6-125	7314150317738	1	527
NS300-6-150	7314150317745	1	527
NS300-7-150	7314150317752	1	527
NS300-8-150	7314150316199	1	527
NS300-8-200	7314150317769	1	527
NS300-9-250	7314150317776	1	527
NS301-10-200	7314150317882	1	527



NS301-10-300



NS301-10-300	7314150317899	1	527
NS301-3-50	7314150317813	1	527
NS301-4-100	7314150317820	1	527
NS301-4-150	7314150317837	1	527
NS301-5-100	7314150317844	1	527
NS301-5-200	7314150317851	1	527
NS301-6-100	7314150317868	1	527
NS301-8-150	7314150317875	1	527
NS302-0-50	7314150316229	1	528
NS302-1-100	7314150316236	1	528
NS302-2-125	7314150316243	1	528
NS302-3-150	7314150316250	1	528
NS302-4-300	7314150316267	1	528
NS304-0-50	7314150316274	1	528
NS304-1-100	7314150316281	1	528
NS304-2-125	7314150316298	1	528
NS304-3-150	7314150316304	1	528
NS304-4-300	7314150316311	1	528
NS320-10	7314150318162	1	528
NS320-2	7314150318087	1	528
NS320-3	7314150318094	1	528
NS320-4	7314150318100	1	528
NS320-5	7314150318117	1	528
NS320-6	7314150318124	1	528
NS320-7	7314150318131	1	528
NS320-8	7314150318148	1	528
NS320-9	7314150318155	1	528
NS400-160	7314150316106	1	528
NS400-180	7314150316113	1	528
NS400-200	7314150316120	1	528
NS402-160	7314150316137	1	529
NS402-200	7314150325177	1	529
NS403-160	7314150318209	1	529
NS403-180	7314150318193	1	529
NS404-160	7314150318216	1	529
NS405-160	7314150318247	1	529
NS406-160	7314150316144	1	529
NS406-180	7314150318261	1	529
NS406-200	7314150316151	1	529
NS407-160	7314150318278	1	529
NS408-250	7314150316168	1	530
NS408-300	7314150318292	1	530
NS411-200	7314150318322	1	530
NS412-200	7314150318339	1	530
NS413-180	7314150318384	1	530
NS413-200	7314150318377	1	530
NS500-1000-FB	7314150296019	1	531
NS500-1500-FB	7314150296026	1	531
NS500-2000	7314150291847	1	530
NS500-2000-FB	7314150284955	1	531
NS500-2500	7314150291854	1	530
NS500-2500-FB	7314150284962	1	531
NS500-3000	7314150291861	1	530
NS500-3000-FB	7314150284979	1	531
NS500-3500-FB	7314150284986	1	531
NS500-4000	7314150291878	1	530
NS502-1000-FB	7314150284993	1	531
NS502-10000-FB	7314150285068	1	531
NS502-12000-FB	7314150318407	1	531
NS502-1500-FB	7314150318438	1	531
NS502-2000-FB	7314150285006	1	531
NS502-2500-FB	7314150285013	1	531
NS502-3000-FB	7314150285020	1	531
NS502-450-FB	7314150296033	1	531
NS502-4500-FB	7314150285037	1	531
NS502-5000-FB	7314150285044	1	531
NS502-6800-FB	7314150318445	1	531
NS502-8000-FB	7314150285051	1	531
NS504-100-FB	7314150296040	1	531
NS504-1000-FB	7314150285099	1	531
NS504-1500-FB	7314150285105	1	531
NS504-200-FB	7314150296057	1	531
NS504-2000-FB	7314150285112	1	531
NS504-300-FB	7314150296064	1	531
NS504-500-FB	7314150285075	1	531
NS504-800-FB	7314150285082	1	531
NS506-300	7314150285129	1	531
NS506-300-FB	7314150318469	1	532
NS506-450	7314150285136	1	531
NS506-450-FB	7314150318476	1	532
NS506-700	7314150296071	1	531
NS506-700-FB	7314150285143	1	532
NS506-900	7314150296088	1	531
NS506-900-FB	7314150285150	1	532
NS508-500-FB	7314150318544	1	532
NS508-700-FB	7314150318537	1	532
NS512-200-FB	7314150318568	1	532
NS512-400-FB	7314150318575	1	532
NS512-600-FB	7314150318582	1	532
NS512-900-FB	7314150318599	1	532
NS600-100-50	7314150296101	1	532
NS600-135-50	7314150296118	1	532
NS600-150-25	7314150296125	1	532
NS600-150-30	7314150301676	1	532
NS600-150-40	7314150296132	1	532
NS600-150-50	7314150296149	1	532



NS600-180-13	7314150296156	1	532
NS600-180-32	7314150285167	1	532
NS600-180-50	7314150285174	1	532
NS600-200-20	7314150296163	1	532
NS600-200-30	7314150296170	1	532
NS600-200-40	7314150296187	1	532
NS600-200-50	7314150301782	1	532
NS600-230-40	7314150296194	1	532
NS600-250-40	7314150296200	1	532
NS600-300-50	7314150296217	1	532
NS600-80-13	7314150296095	1	532
NS602-460	7314150285181	1	533
NS602-600	7314150285198	1	533
NS602-760	7314150296224	1	533
NS602-900	7314150296231	1	533
NS604-150	7314150296248	1	533
NS604-200	7314150285204	1	533
NS604-300	7314150285211	1	533
NS606-150	7314150285228	1	533
NS606-200	7314150285235	1	533
NS606-250	7314150285242	1	533
NS606-300	7314150285259	1	533
NS606-400	7314150285266	1	533
NS608-100	7314150285273	1	533
NS700-300	7314150325184	1	533
NS702-200	7314150325191	1	534
NS704-225	7314150325207	1	534
NS706-50	7314150325214	1	534
NS706-80	7314150325221	1	534
NS708-360	7314150325238	1	534
NS710-450	7314150325245	1	535
NS800-1100	7314150296323	1	535
NS800-1700	7314150285280	1	535
NS800-2000	7314150296330	1	535
NS802-290	7314150285297	1	535
NS804-200	7314150296347	1	535
NS810-100	7314150318728	1	535
NS810-150	7314150318711	1	535
NS810-200	7314150318704	1	535
NS810-350	7314150318698	1	535
NSB001-150	7314150292509	5	518
NSB001-200	7314150284689	5	518
NSB001-250	7314150284696	5	518
NSB001-300	7314150284702	5	518
NSB001-375	7314150292516	5	518
NSB001-450	7314150292523	3	518
NSB001-600	7314150292530	3	518
NSB001-900	7314150292547	1	518
NSB002-10	7314150316366	5	518
NSB002-11	7314150316373	5	518
NSB002-12	7314150316380	5	518
NSB002-13	7314150316397	5	518
NSB002-14	7314150316403	5	518
NSB002-15	7314150316410	5	518
NSB002-16	7314150316427	5	518
NSB002-17	7314150316434	5	518
NSB002-18	7314150316441	5	518
NSB002-19	7314150316458	5	518
NSB002-20	7314150316465	5	518
NSB002-21	7314150316472	5	518
NSB002-22	7314150316489	5	518
NSB002-23	7314150316496	5	518
NSB002-24	7314150316502	5	518
NSB002-25	7314150316519	5	518
NSB002-26	7314150316526	5	518
NSB002-27	7314150316533	5	518
NSB002-28	7314150316540	5	518
NSB002-29	7314150316557	5	518
NSB002-30	7314150316564	5	518
NSB002-31	7314150321728	1	518
NSB002-32	7314150316571	10	518
NSB002-33	7314150321735	1	518
NSB002-34	7314150321742	1	518
NSB002-35	7314150321759	1	518
NSB002-36	7314150321766	5	518
NSB002-38	7314150321773	1	518
NSB002-40	7314150321780	1	518
NSB002-41	7314150321797	5	518
NSB002-42	7314150321803	1	518
NSB002-46	7314150321810	1	518
NSB002-50	7314150321827	1	518
NSB002-52	7314150321834	1	518
NSB002-55	7314150321841	1	518
NSB002-6	7314150316328	5	518
NSB002-60	7314150321858	1	518
NSB002-65	7314150321865	1	518
NSB002-7	7314150316335	5	518
NSB002-70	7314150321872	1	518
NSB002-75	7314150321889	1	518
NSB002-8	7314150316342	5	518
NSB002-80	7314150321896	1	518
NSB002-9	7314150316359	5	518
NSB003-10	7314150342709	1	518
NSB003-11	7314150342716	1	518
NSB003-12	7314150342723	5	518
NSB003-13	7314150342730	1	519



NSB003-14	7314150342747	1	519
NSB003-16	7314150342754	5	519
NSB003-18	7314150342761	1	519
NSB003-19	7314150342778	1	519
NSB003-20	7314150342785	1	519
NSB003-22	7314150342792	5	519
NSB003-24	7314150342808	5	519
NSB003-25	7314150342815	1	519
NSB003-26	7314150342822	1	519
NSB003-28	7314150342839	5	519
NSB003-30	7314150342846	1	519
NSB003-31	7314150342853	1	519
NSB003-32	7314150342860	1	519
NSB003-34	7314150342877	1	519
NSB003-36	7314150342884	1	519
NSB003-38	7314150342891	1	519
NSB003-40	7314150342907	1	519
NSB003-42	7314150342914	1	519
NSB003-44	7314150342921	5	519
NSB003-46	7314150342938	1	519
NSB003-48	7314150342945	1	519
NSB003-50	7314150342952	1	519
NSB003-52	7314150342969	1	519
NSB003-54	7314150342976	1	519
NSB003-56	7314150342983	1	519
NSB003-58	7314150342990	1	519
NSB003-60	7314150343010	1	519
NSB003-62	7314150343027	1	519
NSB003-64	7314150343034	5	519
NSB003-68	7314150343041	1	519
NSB003-72	7314150343058	1	519
NSB003-8	7314150342693	1	518
NSB003-80	7314150343065	1	519
NSB003-84	7314150343072	1	519
NSB003-88	7314150343089	1	519
NSB006-0607	7314150316588	1	519
NSB006-0608	7314150321926	1	519
NSB006-0708	7314150321933	1	519
NSB006-0709	7314150321940	1	519
NSB006-0809	7314150316595	1	519
NSB006-0810	7314150321957	1	519
NSB006-0910	7314150321964	1	519
NSB006-0911	7314150321971	1	519
NSB006-1011	7314150316601	1	519
NSB006-1012	7314150322015	1	519
NSB006-1013	7314150322022	1	519
NSB006-1014	7314150322039	1	519
NSB006-1113	7314150322046	1	519
NSB006-1114	7314150322053	1	519
NSB006-1213	7314150316618	1	519
NSB006-1214	7314150322060	1	519
NSB006-1315	7314150322077	1	519
NSB006-1415	7314150316625	1	519
NSB006-1416	7314150322084	1	519
NSB006-1417	7314150322091	1	519
NSB006-1617	7314150316632	1	519
NSB006-1618	7314150322107	1	519
NSB006-1719	7314150322114	1	519
NSB006-1722	7314150322121	1	519
NSB006-1819	7314150316649	1	519
NSB006-1820	7314150322138	1	519
NSB006-1920	7314150322145	1	519
NSB006-1922	7314150322152	1	519
NSB006-1924	7314150322169	1	519
NSB006-2022	7314150316656	1	519
NSB006-2122	7314150322176	1	519
NSB006-2123	7314150316663	1	519
NSB006-2223	7314150322183	1	519
NSB006-2224	7314150322190	1	519
NSB006-2227	7314150322206	1	519
NSB006-2326	7314150322213	1	519
NSB006-2425	7314150322220	1	519
NSB006-2426	7314150316670	1	519
NSB006-2427	7314150322237	1	519
NSB006-2430	7314150322244	1	519
NSB006-2528	7314150316687	1	519
NSB006-2629	7314150322251	1	519
NSB006-2729	7314150316694	1	519
NSB006-2730	7314150322336	1	519
NSB006-2732	7314150322343	1	519
NSB006-2830	7314150322350	1	519
NSB006-3031	7314150322367	1	519
NSB006-3032	7314150316700	1	519
NSB006-3034	7314150322374	1	519
NSB006-3036	7314150322381	1	519
NSB006-3234	7314150322398	1	519
NSB006-3235	7314150322404	1	519
NSB006-3236	7314150322411	1	519
NSB006-3335	7314150322428	1	519
NSB006-3436	7314150322435	1	519
NSB006-3536	7314150322442	1	519
NSB006-3638	7314150322459	1	519
NSB006-3641	7314150322466	1	519
NSB006-3642	7314150322473	1	519
NSB006-4146	7314150322480	1	519
NSB006-4650	7314150322497	1	519



NSB006-5052	7314150322503	1	519
NSB006-5055	7314150322510	1	519
NSB006-5060	7314150322527	1	519
NSB006-5062	7314150322534	1	519
NSB006-5560	7314150322558	1	519
NSB006-6065	7314150322565	1	519
NSB006-6570	7314150322572	1	519
NSB010-0607	7314150322589	1	520
NSB010-0709	7314150322596	1	520
NSB010-0809	7314150322602	1	520
NSB010-0911	7314150322619	1	520
NSB010-1011	7314150322626	1	520
NSB010-1012	7314150322633	1	520
NSB010-1214	7314150322640	1	520
NSB010-1315	7314150322657	1	520
NSB010-1417	7314150322664	1	520
NSB010-1618	7314150322671	1	520
NSB010-1719	7314150322688	1	520
NSB010-1722	7314150322695	1	520
NSB010-1819	7314150322718	1	520
NSB010-1921	7314150322725	1	520
NSB010-1922	7314150322732	1	520
NSB010-2022	7314150322749	1	520
NSB010-2123	7314150322756	1	520
NSB010-2224	7314150322763	1	520
NSB010-2427	7314150322770	1	520
NSB010-2528	7314150322787	1	520
NSB010-2628	7314150322794	1	520
NSB010-2730	7314150322800	1	520
NSB010-2732	7314150322817	1	520
NSB010-3032	7314150322824	1	520
NSB010-3036	7314150322831	1	520
NSB010-3236	7314150322848	1	520
NSB010-3641	7314150322855	1	520
NSB010-4146	7314150322862	1	520
NSB010-4650	7314150322879	1	520
NSB011-0607	7314150317400	1	520
NSB011-0809	7314150317417	1	520
NSB011-1011	7314150317424	1	520
NSB011-1213	7314150317431	1	520
NSB011-1415	7314150317448	1	520
NSB011-1617	7314150317455	1	520
NSB011-1819	7314150317462	1	520
NSB011-2022	7314150317479	1	520
NSB011-2123	7314150317486	1	520
NSB011-2426	7314150317493	1	520
NSB011-2528	7314150317509	1	520
NSB011-2729	7314150317516	1	520
NSB011-3032	7314150317523	1	520
NSB041-12-50	7314150502660	1	536
NSB041-16-100	7314150502684	1	536
NSB041-16-200	7314150502318	1	536
NSB041-16-260	7314150502707	1	536
NSB041-24-670	7314150502721	1	536
NSB041-32-900	7314150502745	1	536
NSB041-8-25	7314150502769	1	536
NSB100-100	7314150323302	1	521
NSB100-105	7314150323319	1	521
NSB100-110	7314150323326	1	521
NSB100-115	7314150323333	1	521
NSB100-120	7314150323340	1	521
NSB100-17	7314150322886	1	521
NSB100-19	7314150322893	1	521
NSB100-22	7314150322909	1	521
NSB100-24	7314150322916	1	521
NSB100-25	7314150322923	1	521
NSB100-27	7314150322930	1	521
NSB100-28	7314150322947	1	521
NSB100-29	7314150322954	1	521
NSB100-30	7314150322961	1	521
NSB100-32	7314150322978	1	521
NSB100-33	7314150322985	1	521
NSB100-34	7314150322992	1	521
NSB100-35	7314150323005	1	521
NSB100-36	7314150323012	1	521
NSB100-37	7314150323029	1	521
NSB100-38	7314150323036	1	521
NSB100-41	7314150323043	1	521
NSB100-42	7314150323050	1	521
NSB100-45	7314150323067	1	521
NSB100-46	7314150323074	1	521
NSB100-47	7314150323081	1	521
NSB100-50	7314150323098	1	521
NSB100-52	7314150323104	1	521
NSB100-54	7314150323111	1	521
NSB100-55	7314150323128	1	521
NSB100-56	7314150323135	1	521
NSB100-58	7314150323142	1	521
NSB100-60	7314150323159	1	521
NSB100-63	7314150323166	1	521
NSB100-65	7314150323173	1	521
NSB100-67	7314150323180	1	521
NSB100-70	7314150323197	1	521
NSB100-71	7314150323203	1	521
NSB100-75	7314150323210	1	521
NSB100-77	7314150323227	1	521



NSB100-80



NSB100-80	7314150323234	1	521
NSB100-82	7314150323241	1	521
NSB100-85	7314150323258	1	521
NSB100-88	7314150323265	1	521
NSB100-90	7314150323272	1	521
NSB100-94	7314150323289	1	521
NSB100-95	7314150323296	1	521
NSB104-100	7314150316885	1	522
NSB104-105	7314150316892	1	522
NSB104-110	7314150316908	1	522
NSB104-115	7314150323937	1	522
NSB104-120	7314150316915	1	522
NSB104-17	7314150323357	1	522
NSB104-19	7314150323364	1	522
NSB104-20	7314150323371	1	522
NSB104-22	7314150323388	1	522
NSB104-24	7314150316717	1	522
NSB104-25	7314150323395	1	522
NSB104-26	7314150323401	1	522
NSB104-27	7314150316724	1	522
NSB104-28	7314150323418	1	522
NSB104-29	7314150323425	1	522
NSB104-30	7314150316731	1	522
NSB104-31	7314150323432	1	522
NSB104-32	7314150316748	1	522
NSB104-33	7314150323449	1	522
NSB104-34	7314150323456	1	522
NSB104-35	7314150323463	1	522
NSB104-36	7314150316755	1	522
NSB104-37	7314150323470	1	522
NSB104-38	7314150323487	1	522
NSB104-39	7314150323494	1	522
NSB104-40	7314150323500	1	522
NSB104-41	7314150316762	1	522
NSB104-42	7314150323517	1	522
NSB104-43	7314150323524	1	522
NSB104-44	7314150323531	1	522
NSB104-45	7314150323548	1	522
NSB104-46	7314150316779	1	522
NSB104-47	7314150323555	1	522
NSB104-48	7314150323562	1	522
NSB104-49	7314150323579	1	522
NSB104-50	7314150316786	1	522
NSB104-51	7314150323586	1	522
NSB104-52	7314150323593	1	522
NSB104-53	7314150323609	1	522
NSB104-54	7314150323616	1	522
NSB104-55	7314150316793	1	522
NSB104-56	7314150323623	1	522
NSB104-57	7314150323630	1	522
NSB104-58	7314150323647	1	522
NSB104-59	7314150323654	1	522
NSB104-60	7314150316809	1	522
NSB104-61	7314150323661	1	522
NSB104-62	7314150323678	1	522
NSB104-63	7314150323685	1	522
NSB104-64	7314150323692	1	522
NSB104-65	7314150316816	1	522
NSB104-66	7314150323708	1	522
NSB104-67	7314150323715	1	522
NSB104-68	7314150323722	1	522
NSB104-69	7314150323739	1	522
NSB104-70	7314150316823	1	522
NSB104-71	7314150323746	1	522
NSB104-72	7314150323753	1	522
NSB104-73	7314150323760	1	522
NSB104-74	7314150323777	1	522
NSB104-75	7314150316830	1	522
NSB104-76	7314150323784	1	522
NSB104-77	7314150323791	1	522
NSB104-78	7314150323807	1	522
NSB104-79	7314150323814	1	522
NSB104-80	7314150316847	1	522
NSB104-81	7314150323821	1	522
NSB104-82	7314150323838	1	522
NSB104-83	7314150323845	1	522
NSB104-84	7314150323852	1	522
NSB104-85	7314150316854	1	522
NSB104-86	7314150323869	1	522
NSB104-87	7314150323876	1	522
NSB104-88	7314150323883	1	522
NSB104-89	7314150323890	1	522
NSB104-90	7314150316861	1	522
NSB104-92	7314150323906	1	522
NSB104-94	7314150323913	1	522
NSB104-95	7314150316878	1	522
NSB104-98	7314150323920	1	522
NSB106-100	7314150324361	1	523
NSB106-104	7314150324378	1	523
NSB106-108	7314150324385	1	523
NSB106-112	7314150324392	1	523
NSB106-114	7314150324408	1	523
NSB106-116	7314150324415	1	523
NSB106-120	7314150324422	1	523
NSB106-124	7314150324439	1	523
NSB106-126	7314150324446	1	523



NSB106-128	7314150324453	1	523
NSB106-132	7314150324460	1	523
NSB106-136	7314150324477	1	523
NSB106-138	7314150324484	1	523
NSB106-144	7314150324491	1	523
NSB106-146	7314150324507	1	523
NSB106-150	7314150324514	1	523
NSB106-156	7314150324521	1	523
NSB106-158	7314150324538	1	523
NSB106-20	7314150323944	1	522
NSB106-22	7314150323951	1	522
NSB106-24	7314150323968	1	522
NSB106-25	7314150323975	1	522
NSB106-26	7314150323982	1	522
NSB106-28	7314150323999	1	522
NSB106-30	7314150324002	1	522
NSB106-32	7314150324019	1	522
NSB106-34	7314150324026	1	522
NSB106-36	7314150324033	1	522
NSB106-38	7314150324040	1	522
NSB106-40	7314150324057	1	522
NSB106-42	7314150324064	1	522
NSB106-44	7314150324071	1	522
NSB106-45	7314150324088	1	522
NSB106-46	7314150324095	1	522
NSB106-48	7314150324101	1	522
NSB106-50	7314150324118	1	522
NSB106-52	7314150324125	1	522
NSB106-54	7314150324132	1	522
NSB106-56	7314150324149	1	522
NSB106-58	7314150324156	1	522
NSB106-60	7314150324163	1	522
NSB106-62	7314150324170	1	522
NSB106-64	7314150324187	1	523
NSB106-66	7314150324194	1	523
NSB106-68	7314150324200	1	523
NSB106-70	7314150324217	1	523
NSB106-71	7314150324224	1	523
NSB106-72	7314150324231	1	523
NSB106-74	7314150324248	1	523
NSB106-76	7314150324255	1	523
NSB106-78	7314150324262	1	523
NSB106-80	7314150324279	1	523
NSB106-82	7314150324286	1	523
NSB106-84	7314150324293	1	523
NSB106-88	7314150324309	1	523
NSB106-90	7314150324316	1	523
NSB106-92	7314150324323	1	523
NSB106-94	7314150324330	1	523
NSB106-96	7314150324347	1	523
NSB106-98	7314150324354	1	523
NSB200-1200	7314150324613	1	523
NSB200-200	7314150324545	1	523
NSB200-250	7314150324552	1	523
NSB200-300	7314150324569	1	523
NSB200-350	7314150324576	1	523
NSB200-450	7314150324583	1	523
NSB200-600	7314150324590	1	523
NSB200-900	7314150324606	1	523
NSB202-350	7314150324620	1	523
NSB203-200	7314150359561	1	523
NSB203-215	7314150359578	1	523
NSB203-290	7314150359585	1	523
NSB203-400	7314150359592	1	523
NSB203-490	7314150359608	1	523
NSB203-800	7314150359615	1	523
NSB204-30	7314150324637	1	524
NSB204-32	7314150324644	1	524
NSB204-35	7314150324651	1	524
NSB204-40	7314150324668	1	524
NSB204-45	7314150324675	1	524
NSB204-48	7314150324682	1	524
NSB204-50	7314150324699	1	524
NSB204-55	7314150324705	1	524
NSB204-60	7314150324712	1	524
NSB204-65	7314150324729	1	524
NSB204-70	7314150324736	1	524
NSB204-75	7314150324743	1	524
NSB204-80	7314150324750	1	524
NSB204-85	7314150324767	1	524
NSB204-90	7314150324774	1	524
NSB220-06	7314150354023	1	524
NSB220-07	7314150354030	1	524
NSB220-08	7314150354047	1	524
NSB220-09	7314150354054	1	524
NSB220-10	7314150354061	1	524
NSB220-11	7314150354078	1	524
NSB220-12	7314150354085	1	524
NSB220-13	7314150354092	1	524
NSB220-14	7314150354108	1	524
NSB220-15	7314150354115	1	524
NSB220-16	7314150354122	1	524
NSB220-17	7314150354139	1	524
NSB220-18	7314150354146	1	524
NSB220-19	7314150354153	1	524
NSB220-20	7314150354160	1	524



NSB220-21	7314150354177	1	524
NSB220-22	7314150354184	1	524
NSB220-23	7314150354191	1	524
NSB220-24	7314150354207	1	524
NSB220-25	7314150354214	1	524
NSB220-26	7314150354221	1	524
NSB220-27	7314150354238	1	524
NSB220-28	7314150354245	1	524
NSB220-29	7314150354252	1	524
NSB220-30	7314150354269	1	524
NSB220-32	7314150354276	1	524
NSB224-17	7314150355723	1	524
NSB224-18	7314150355730	1	524
NSB224-19	7314150355747	1	524
NSB224-21	7314150355754	1	524
NSB224-22	7314150355761	1	524
NSB224-23	7314150355778	1	524
NSB224-24	7314150355785	1	524
NSB224-26	7314150355792	1	524
NSB224-27	7314150355808	1	524
NSB224-28	7314150355815	1	524
NSB224-29	7314150355822	1	524
NSB224-30	7314150355839	1	524
NSB224-32	7314150355846	1	524
NSB224-34	7314150355853	1	524
NSB224-36	7314150355860	1	525
NSB224-38	7314150355877	1	525
NSB224-41	7314150355884	1	525
NSB224-46	7314150355891	1	525
NSB224-50	7314150355907	1	525
NSB228-22	7314150356126	1	525
NSB228-24	7314150356133	1	525
NSB228-26	7314150356140	1	525
NSB228-27	7314150356157	1	525
NSB228-28	7314150356164	1	525
NSB228-29	7314150356171	1	525
NSB228-30	7314150356188	1	525
NSB228-31	7314150356195	1	525
NSB228-32	7314150356201	1	525
NSB228-34	7314150356218	1	525
NSB228-36	7314150356225	1	525
NSB228-38	7314150356232	1	525
NSB228-41	7314150356249	1	525
NSB228-46	7314150356256	1	525
NSB228-50	7314150356263	1	525
NSB228-55	7314150356270	1	525
NSB228-60	7314150356287	1	525
NSB228-65	7314150356294	1	525
NSB228-70	7314150356300	1	525
NSB228-75	7314150356317	1	525
NSB228-80	7314150356324	1	525
NSB232-16-24	7314150356379	1	525
NSB232-24-16	7314150356393	1	525
NSB232-24-32	7314150356386	1	525
NSB232-32-24	7314150356409	1	525
NSB234-16-100	7314150356461	1	525
NSB234-16-200	7314150356478	1	525
NSB234-16-250	7314150356485	1	525
NSB234-24-200	7314150356492	1	525
NSB234-32-250	7314150356508	1	525
NSB236-16	7314150356553	1	526
NSB236-24	7314150356546	1	526
NSB236-32	7314150356560	1	526
NSB238-16-250	7314150356621	1	526
NSB238-24-250	7314150356614	1	526
NSB238-32-300	7314150356607	1	526
NSB240-16-230	7314150356744	1	526
NSB242-16	7314150356669	1	526
NSB242-24	7314150356676	1	526
NSB242-32	7314150356683	1	526
NSB243-16-400	7314150356706	1	526
NSB247-26	7314150356768	1	527
NSB248-16-52	7314150356720	1	527
NSB300-10-200	7314150317646	1	527
NSB300-10-300	7314150295845	1	527
NSB300-11-250	7314150317653	1	527
NSB300-11-300	7314150317660	1	527
NSB300-11-350	7314150295852	1	527
NSB300-12-400	7314150295869	1	527
NSB300-13-450	7314150295876	1	527
NSB300-3-50	7314150317530	1	527
NSB300-3-75	7314150317547	1	527
NSB300-4-75	7314150317554	1	527
NSB300-4.5-100	7314150295838	1	527
NSB300-4.5-50	7314150317561	1	527
NSB300-5-100	7314150317585	1	527
NSB300-5-75	7314150317578	1	527
NSB300-6-100	7314150285327	1	527
NSB300-6-125	7314150317592	1	527
NSB300-6-150	7314150317608	1	527
NSB300-7-150	7314150317615	1	527
NSB300-8-150	7314150285334	1	527
NSB300-8-200	7314150317622	1	527
NSB300-9-250	7314150317639	1	527
NSB301-10-200	7314150317974	1	528
NSB301-10-300	7314150317981	1	528



NSB301-3-50	7314150317905	1	528
NSB301-4-100	7314150317912	1	528
NSB301-4-150	7314150317929	1	528
NSB301-5-100	7314150317936	1	528
NSB301-5-200	7314150317943	1	528
NSB301-6-100	7314150317950	1	528
NSB301-8-150	7314150317967	1	528
NSB302-0-50	7314150295883	1	528
NSB302-1-100	7314150285341	1	528
NSB302-2-125	7314150285358	1	528
NSB302-3-150	7314150295890	1	528
NSB302-4-300	7314150295906	1	528
NSB304-0-50	7314150295913	1	528
NSB304-1-100	7314150295920	1	528
NSB304-2-125	7314150295937	1	528
NSB304-3-150	7314150295944	1	528
NSB304-4-300	7314150295951	1	528
NSB320-10	7314150318070	1	528
NSB320-2	7314150317998	1	528
NSB320-3	7314150318001	1	528
NSB320-4	7314150318018	1	528
NSB320-5	7314150318025	1	528
NSB320-6	7314150318032	1	528
NSB320-7	7314150318049	1	528
NSB320-8	7314150318056	1	528
NSB320-9	7314150318063	1	528
NSB400-160	7314150295968	1	528
NSB400-180	7314150285365	1	528
NSB400-200	7314150295975	1	528
NSB402-160	7314150295982	1	529
NSB402-200	7314150285372	1	529
NSB403-160	7314150318179	1	529
NSB403-180	7314150318186	1	529
NSB404-160	7314150318223	1	529
NSB405-160	7314150318230	1	529
NSB406-160	7314150295999	1	529
NSB406-180	7314150318254	1	529
NSB406-200	7314150296002	1	529
NSB407-160	7314150318285	1	530
NSB408-250	7314150285389	1	530
NSB408-300	7314150318308	1	530
NSB411-200	7314150318315	1	530
NSB412-200	7314150318346	1	530
NSB413-180	7314150318353	1	530
NSB413-200	7314150318360	1	530
NSB500-1000-FB	7314150324828	1	531
NSB500-1500-FB	7314150324835	1	531
NSB500-2000	7314150324781	1	530
NSB500-2000-FB	7314150324842	1	531
NSB500-2500	7314150324798	1	530
NSB500-2500-FB	7314150324859	1	531
NSB500-3000	7314150324804	1	530
NSB500-3000-FB	7314150324866	1	531
NSB500-3500-FB	7314150324873	1	531
NSB500-4000	7314150324811	1	530
NSB502-1000-FB	7314150316922	1	531
NSB502-1000-FB	7314150316991	1	531
NSB502-12000-FB	7314150318414	1	531
NSB502-1500-FB	7314150318421	1	531
NSB502-2000-FB	7314150316939	1	531
NSB502-2500-FB	7314150316946	1	531
NSB502-3000-FB	7314150316953	1	531
NSB502-450-FB	7314150324880	1	531
NSB502-4500-FB	7314150316960	1	531
NSB502-5000-FB	7314150316977	1	531
NSB502-6800-FB	7314150318452	1	531
NSB502-8000-FB	7314150316984	1	531
NSB504-100-FB	7314150317004	1	531
NSB504-1000-FB	7314150317059	1	531
NSB504-1500-FB	7314150317066	1	531
NSB504-200-FB	7314150317011	1	531
NSB504-2000-FB	7314150317073	1	531
NSB504-300-FB	7314150317028	1	531
NSB504-500-FB	7314150317035	1	531
NSB504-800-FB	7314150317042	1	531
NSB506-300	7314150324897	1	531
NSB506-300-FB	7314150318490	1	532
NSB506-450	7314150324903	1	531
NSB506-450-FB	7314150318483	1	532
NSB506-700	7314150324910	1	531
NSB506-700-FB	7314150317080	1	532
NSB506-900	7314150324927	1	531
NSB506-900-FB	7314150317097	1	532
NSB508-500-FB	7314150318513	1	532
NSB508-700-FB	7314150318520	1	532
NSB512-200-FB	7314150318643	1	532
NSB512-400-FB	7314150318636	1	532
NSB512-600-FB	7314150318629	1	532
NSB512-900-FB	7314150318605	1	532
NSB600-100-50	7314150317110	1	532
NSB600-135-50	7314150317127	1	532
NSB600-150-25	7314150317134	1	532
NSB600-150-30	7314150317141	1	532
NSB600-150-40	7314150317158	1	532
NSB600-150-50	7314150317165	1	532
NSB600-180-13	7314150317172	1	532



NSB600-180-32



NSB600-180-32	7314150317189	1	532
NSB600-180-50	7314150317196	1	532
NSB600-200-20	7314150317202	1	532
NSB600-200-30	7314150317219	1	532
NSB600-200-40	7314150317226	1	532
NSB600-200-50	7314150317233	1	532
NSB600-230-40	7314150317240	1	532
NSB600-250-40	7314150317257	1	532
NSB600-300-50	7314150317264	1	532
NSB600-80-13	7314150317103	1	532
NSB602-460	7314150324934	1	533
NSB602-600	7314150324941	1	533
NSB602-760	7314150324958	1	533
NSB602-900	7314150324965	1	533
NSB604-150	7314150324972	1	533
NSB604-200	7314150324989	1	533
NSB604-300	7314150324996	1	533
NSB606-150	7314150325009	1	533
NSB606-200	7314150325016	1	533
NSB606-250	7314150325023	1	533
NSB606-300	7314150325030	1	533
NSB606-400	7314150325047	1	533
NSB608-100	7314150325054	1	533
NSB700-300	7314150296255	1	534
NSB702-200	7314150296262	1	534
NSB704-225	7314150296279	1	534
NSB706-50	7314150296286	1	534
NSB706-80	7314150296293	1	534
NSB708-360	7314150296309	1	534
NSB710-450	7314150296316	1	535
NSB800-1100	7314150325061	1	535
NSB800-1700	7314150325078	1	535
NSB800-2000	7314150325085	1	535
NSB802-290	7314150325092	1	535
NSB810-100	7314150318650	1	535
NSB810-150	7314150318667	1	535
NSB810-200	7314150318674	1	535
NSB810-350	7314150318681	1	535
P-HB	7314150125272	25	556
P-MEC	7314150374342	24	557
P-MEC-LEAD	7314150374359	12	557
P1-20	7311518044572	5	635
P1-23	7311518332501	5	635
P108-20-F	7311518275518	2	635
P108-23-F	7311518275525	2	635
P111	7311518009076	6	646
P110-20-F	7311518275532	2	635
P110-23-F	7311518275549	2	635
P114-SL-40	7311518301149	2	639
P114-SL-50	7311518301156	2	639
P114-SL-60	7311518301163	2	639
P116-SL-40	7311518301101	2	639
P116-SL-50	7311518301118	2	639
P116-SL-60	7311518301125	2	639
P116-SL-70	7311518301132	2	639
P121-18-F	7311518275662	6	636
P121-20-F	7311518275631	6	636
P121-23-F	7311518275648	6	636
P123-19-BULK30	7311518218218	30	638
P126-19-F	7311518275297	6	636
P126-22-F	7311518275303	6	636
P127-19-BULK30	7311518199333	30	638
P128-19	7311518160814	6	638
P128-19-BULK30	7311518172329	30	638
P129-19-BULK30	7311518172336	30	638
P130-F	7311518333980	6	640
P138-22-F	7311518301279	6	636
P140-F	7311518275372	6	640
P16-40	7311518013479	2	639
P16-40W	7311518043049	2	639
P16-50-F	7311518301286	2	639
P16-60-F	7311518276461	2	639
P160-SL-60	7311518301170	2	639
P160-SL-75	7311518301187	1	639
P160-SL-90	7311518301194	1	639
P173-SL-85	7311518334703	1	639
P19-80-F	7311518275365	1	639
P20	7311518009281	6	646
P241	7311518008956	5	632
P262	7311518299286	10	630
P263	7311518299262	10	631
P264	7311518299279	10	631
P266	7311518299293	10	631
P267	7311518299309	10	631
P268	7311518299316	10	631
P269	7311518299323	10	632
P270	7311518299330	10	632
P272	7311518299354	5	630
P274	7311518299347	5	631



P276	7311518299361	5	631
P277	7311518299378	5	631
P278	7311518299385	5	631
P280-SL-60	7311518346508	2	639
P280-SL-80	7311518301330	2	639
P3-20-F	7311518275259	2	635
P3-23-F	7311518275266	2	635
P34-27A-F	7311518275464	2	642
P34-37	7311518002787	2	642
P5-23-F	7311518275280	2	635
P51-F	7311518275426	2	644
P51-SL	7311518301217	2	645
P51H-SL	7311518301224	2	645
P52-SL-20	7311518347307	2	645
P54-SL-20	7311518301248	2	645
P54-SL-25	7311518301231	2	645
P54H-SL-20	7311518301262	2	645
P54H-SL-25	7311518301255	2	645
P57-25-F	7311518301293	4	645
P57-25-W-F	7311518301309	4	645
P59-25-F	7311518275655	6	645
P64-20	7311518288174	6	636
P64-20-BULK12	7311518288204	12	636
P74	7311518124076	1	646
P75	7311518124083	1	646
PAGS-2.0	7311518327835	1	615
PAGS-2.0-900FG	7311518292355	1	615
PBB-8	7314150399376	8	556
PBS-700	7314150341689	6	556
PC-10-DTF	7311518263560	10	580
PC-10-DTL	7311518263553	10	580
PC-10-DTR	7311518263546	10	580
PC-11-19-PS	7311518285548	4	579
PC-11-19-PS-B	7311518285555	10	579
PC-12-14-PS	7311518285562	4	579
PC-12-14-PS-B	7311518285579	10	579
PC-12-COM	7311518263454	4	574
PC-12-TEN	7311518263447	4	578
PC-12-VEN	7311518263430	4	578
PC-15-GBP	73115182634307	4	574
PC-15-TBX	7311518263423	4	578
PC-16-DECO	7311518264987	4	575
PC-16-FILE-U7	7311518263461	4	576
PC-19-FILE-U7	7311518263478	4	576
PC-19-GT7	7311518263362	4	576
PC-19-GT9	7311518263379	4	578
PC-20-LAM	7311518258290	4	577
PC-20-PRC	7311518264291	4	578
PC-22-FILE-U7	7311518263485	4	576
PC-22-GT7	7311518263393	4	576
PC-22-GT9	7311518263409	4	578
PC-22-INS	7314150154500	4	575
PC-22-PLC	7314150276318	4	574
PC-24-FILE-U7	7311518263492	4	576
PC-24-PLS	7311518263508	4	574
PC-24-TIM	7311518263515	4	579
PC-6-DRY	7311518282004	6	574
PC-9-9/17-PS	7311518285586	4	579
PC-9-9/17-PS-B	7311518285593	10	579
PENCIL-200-DISP	7314150125227	1	557
PG-01-F	7311518329334	6	636
PG-03-L	7311518242855	2	636
PG-12-BULK15	7311518334628	15	636
PG-12-F	7311518328122	10	636
PG-18-45-F	7311518299033	2	640
PG-18-60-F	7311518288853	2	640
PG-19-F	7311518295936	2	640
PG-56-F	7311518288938	2	645
PG-57-F	7311518295943	2	645
PG-72	7311518242534	4	649
PH-6604-1P	7311518152819	15	35
PH-6604-25	7311518141134	25	35
PROF-H	7311518158439	2	651
PROF-LOPP	7311518288549	1	651
PROF-SEC	7311518288532	1	651
PROF-TL	7311518335991	4	477
PU-14	7314150016266	5	44
PU-20	7314150016389	3	44
PU-22	7314150016426	3	44
PU-24	7314150016464	3	44
PU-6	7314150016105	5	44
PU-9	7314150016167	5	44
PX-L2	7311518233853	2	634
PX-L3	7311518233860	2	634
PX-M1	7311518233815	2	634
PX-M2	7311518233822	2	634
PX-M2-L	7311518240714	2	634
PX-M3	7311518233839	2	634
PX-S1	7311518233785	2	634



PX-S2	7311518233792	2	634
PXR-L2	7311518233914	2	634
PXR-M1	7311518233877	2	634
PXR-M2	7311518233884	2	634
PXR-M2-L	7311518240738	2	634
PXR-M3	7311518233891	2	634
PXR-S1	7311518240677	2	634
PXR-S2	7311518240684	2	634
PXR-S2-L	7311518346799	2	634
QC-115A	7314150460007	12	602
QC-115A-2P	7314150460021	6	602
QC-150A	7314150460045	6	602
QC-150A-2P	7314150460069	6	602
QC-300A	7314150401925	6	602
QC-300A-2P	7314150460090	4	602
QCB-1250	7314150135981	8	602
QCB-150	7314150135912	6	602
QCB-300	7314150135936	6	602
QCB-450	7314150135950	6	602
QCB-600	7314150135967	4	602
QCB-900	7314150135974	4	602
QCG-150	7314150135899	6	602
QCG-300	7314150135905	6	602
R1068	7311518044398	1	638
R1069P	7311518219574	12	638
R1071	7311518222918	14	639
R1075-BULK50	7311518220495	50	639
R1080P	7311518282479	1	638
R112PG	7311518010058	1	637
R113PG	7311518044374	30	637
R114PG	7311518010065	1	637
R114V	7311518042660	25	640
R114V-BULK28	7311518177539	28	640
R115V	7311518243210	8	640
R115V-BULK14	7311518288341	14	640
R116V	7311518010164	1	640
R116V-BULK36	7311518159924	36	640
R116VP	7311518042721	25	640
R119V	7311518029487	1	640
R122PG	7311518010072	30	637
R123PG	7311518044381	30	637
R124PG	7311518010089	30	637
R1269P-BULK50	7311518240820	50	635
R133PG	7311518328252	1	643
R137E	7311518011574	30	642
R142P	7311518010126	24	637
R143PV	7311518010133	1	640
R143PVCB	7311518255633	1	640
R144PV	7311518291075	24	640
R146VC	7311518046545	22	646
R146VS	7311518046538	24	640
R146VS-BULK50	7311518159955	50	640
R147V	7311518044909	24	646
R1601	7311518044640	1	638
R160A	7311518201821	1	640
R160A-BULK28	7311518337216	28	640
R166V	7311518328085	22	640
R16V	7311518254513	1	640
R16V-BULK14	7311518288334	14	640
R172A	7311518235413	1	640
R181P	7311518296087	1	640
R185V	7311518331795	25	640
R201P	7311518219536	1	636
R201P-BULK80	7311518225209	80	636
R202P	7311518219550	1	637
R211P	7311518234027	1	634
R211P-BULK80	7311518252212	80	634
R214SL	7311518301392	1	640
R214V	7311518042745	1	640
R214V-BULK28	7311518177553	28	640
R215V	7311518243227	1	640
R216SL	7311518301408	8	640
R221P	7311518229412	1	636
R221P-BULK50	7311518240653	50	636
R223P	7311518237554	1	637
R223P-BULK80	7311518240646	80	637
R230P	7311518341503	10	642
R239P	7311518219567	1	637
R260A	7311518201814	16	640
R272H	7311518258016	1	641
R300P	7311518234034	1	634
R301P	7311518349189	30	636
R303P	7311518234157	1	634
R304P	7311518349219	1	637
R310-0	7314151829797	1	56
R310-1	7314151829803	1	56
R310-2	7314151829810	1	56
R310-3	7314151829827	1	56
R312V	7311518235420	1	640



R315V	7311518243234	1	640
R318V	7311518029500	1	640
R328V	7311518296056	22	640
R335V	7311518331801	12	640
R337E	7311518011598	1	643
R341P	7311518011529	12	637
R372H	7311518235406	1	640
R373A	7311518334710	25	640
R403P	7311518234164	1	634
R415V	7311518243241	1	641
R4230	7311518341510	10	642
R427AE	7311518176068	18	643
R437E	7311518011611	18	643
R438P	7311518229429	1	637
R438P-BULK50	7311518240660	50	637
R440V	7311518254544	22	640
R444V	7311518243340	22	646
R463P	7311518223908	1	637
R472H	7311518334840	30	641
R474P	7311518011536	1	637
R478P	7311518275600	1	638
R480P	7311518282486	1	638
R500P	7311518234041	40	634
R503P	7311518234171	1	634
R515VS	7311518046514	22	646
R516V	7311518200824	22	646
R519V	7311518029517	1	641
R600P	7311518240783	1	634
R603P	7311518240790	1	634
R615V	7311518010119	1	641
R619V	7311518029494	1	640
R660V	7311518210281	24	641
R6725MK	7314151088354	1	69
R6725ZK	7314151784898	1	69
R680V	7311518042752	1	640
R6810M-10	7314150195152	5	80
R6810M-3,4	7314150195077	5	80
R6810M-4	7314150195084	5	80
R6810M-4,5	7314150195091	5	80
R6810M-5	7314150195107	5	80
R6810M-6	7314150195114	5	80
R6810M-7	7314150195121	1	80
R6810M-8	7314150195138	5	80
R6810M-9	7314150195145	5	80
R6810Z-1/4	7314150429448	1	80
R6810Z-3/16	7314150429387	1	80
R6810Z-3/8	7314150429394	1	80
R6810Z-5/16	7314150429400	1	80
R6810Z-7/32	7314150429417	1	80
R6822Z	7314150429424	5	80
R6950	7314151089658	1	85
R6964A	7314150195176	1	80
R6967	7314150195169	5	80
R716VCB	7311518255497	40	640
R772V	7311518301385	14	641
R773V	7311518324414	1	641
R775V	7311518331818	1	641
R776V	7311518334734	1	641
R801P	7311518234126	1	634
R802P	7311518234133	1	634
R803P	7311518234140	1	634
R804P	7311518240806	1	634
R811P	7311518234058	1	634
R812P	7311518234065	1	634
R813P	7311518234072	1	634
R815P	7311518240752	1	634
R900P	7311518234188	1	634
R900P-Z	7311518349233	24	637
R901P	7311518234195	30	634
R902P	7311518234201	24	635
R903P	7311518234218	1	635
R904P	7311518234225	1	635
R905P	7311518234232	1	635
R905P-BULK50	7311518252250	50	635
R906P	7311518234249	1	635
R906P-BULK50	7311518252267	50	635
R906P-Z	7311518349264	12	637
R907P	7311518234256	1	635
RAIL-187	7314153003621	3	84
RAIL-264	7314153003638	3	84
RAIL-340	7314153003645	3	84
RAUNI	7311518339289	6	641
RB-SET-AL06-5P	7314150501489	1	148
RB-SET-M06X-10P	7314150501557	1	148
RB-SET-1-M06X-5P	7314150501588	1	148
RB-SET-2-M06X-5P	7314150501618	1	148
RBCP	7311518339272	10	643
RBCP230	7311518341558	12	643
RCAM30	7311518346959	20	643





RCAM36	7311518346973	20	643
RD1M	7311518341534	15	643
RD7M	7311518341541	20	643
RPL230G	7311518341527	8	643
RS1000	7314150467235	1	356
RS1000PS0	7314150508938	1	357
RS1000PS1	7314150487370	1	357
RS1000TOP1	7314150470662	1	357
RS1000TOP2	7314150487387	1	357
RT821P	7311518242237	1	634
RT822P	7311518234102	1	634
RT823P	7311518234119	6	634
RT824P	7311518240776	1	634
RT825P	7311518347147	6	634
S0810L	7314150256594	20	63
S103	7314150257119	2	62
S103-CASE	7314150321261	1	104
S106	7314150103997	2	62
S108	7314150122257	2	62
S108-CASE	7314150349319	1	104
S1214L	7314150256600	10	69
S137	7314150450503	2	63
S138	7314150195022	2	63
S140T	7314150125203	1	70
S140T-R	7314150136353	10	70
S160	7314150104031	6	64
S160-CASE	7314150136209	1	104
S160AF	7314150137510	6	65
S1612L	7314150256617	4	72
S18HEX	7314150412457	4	73
S18TORX	7314150412464	4	73
S240	7314150104017	4	73
S240AF	7314150111077	4	73
S240AF-CASE	7314150187317	1	104
S290	7314153000859	6	64
S290-CASE	7314150126385	1	104
S330	7314150104024	6	69
S330-CASE	7314150136223	1	104
S330AF	7314150137503	6	70
S330L	7314150256587	4	69
S330L-CASE	7311518337674	1	104
S350AF	7314150137527	2	73
S380	7314150168934	4	69
S400	7314150111053	2	73
S400-CASE	7314150187300	1	104
S410	7314153019370	2	62
S410-CASE	7314150321223	1	104
S460	7314150111060	6	64
S460-CASE	7314150321209	1	104
S4RM-12-15	7314150179954	1	47
S4RM-16-19	7314150179961	1	47
S4RM-21-27	7314150179978	1	47
S4RM-30-36	7314150179985	1	47
S4RM-4-7	7314150179930	1	47
S4RM-8-11	7314150179947	1	47
S4RM/3T	7314150117406	20	47
S4RM/4T	7314150179916	1	47
S4RM/5T	7314150179923	1	48
S530T	7314150169122	4	70
S560	7314150122264	4	63
S560-CASE	7314150321216	1	104
S800	7314150165599	2	62
S81MIX	7314150180127	2	62
S81MIX-CASE	7314150321247	1	104
S87+7	7314150103980	2	62
S910	7314150104000	2	62
S910AF	7314150137541	2	63
S93	7314150129805	1	101
S95	7314150409167	2	62
S9HEX	7314150412433	10	72
S9TORX	7314150412440	10	72
SB-2058/S26	7314151849498	1	168
SB-2444	7314150189250	1	597
SB-2448	7314150136056	12	586
SB-2449	7314150194049	10	586
SB-3732-2-125	7314151847869	60	622
SB-3732-2.5-125	7314151847876	60	622
SB-3732-3.2-125	7314151847883	60	622
SB-3732-4-125	7314151847890	1	622
SB-3734N-10-150	7314151848101	1	621
SB-3734N-2-150	7314151847968	1	621
SB-3734N-3-150	7314151847975	1	621
SB-3734N-4-150	7314151847982	60	621
SB-3734N-5-150	7314151847999	1	621
SB-3734N-6-150	7314151848071	60	621
SB-3734N-7-150	7314151848088	1	621
SB-3734N-8-150	7314151848095	1	621
SB-3735N-2-100	7314151847906	1	620
SB-3735N-4-120	7314151847913	60	620



SB-3735N-5-120	7314151847920	1	620
SB-3735N-6-150	7314151847937	1	620
SB-3735N-8-150	7314151847944	1	620
SB-3740-125	7314150115990	87	618
SB-3740-150	7314150116003	25	618
SB-3740-175	7314150116010	25	618
SB-3740-200	7314150116027	25	618
SB-3740-250	7314150116034	25	618
SB-3740-300	7314150116041	25	618
SB-9526/S6	7314150154234	20	154
SB111M-10	7314151839864	1	40
SB111M-11	7314151839871	1	40
SB111M-12	7314151839888	1	40
SB111M-13	7314151839895	1	40
SB111M-14	7314151839901	1	40
SB111M-15	7314151839918	1	40
SB111M-16	7314151839925	1	41
SB111M-17	7314151839932	1	41
SB111M-18	7314151839949	1	41
SB111M-19	7314151839956	1	41
SB111M-20	7314151839963	1	41
SB111M-21	7314151839970	1	41
SB111M-22	7314151839987	1	41
SB111M-23	7314151839994	1	41
SB111M-24	7314151840006	1	41
SB111M-25	7314151840013	1	41
SB111M-26	7314151840020	1	41
SB111M-27	7314151840037	1	41
SB111M-28	7314150432103	1	41
SB111M-29	7314151840051	1	41
SB111M-30	7314151840068	1	41
SB111M-32	7314151840075	1	41
SB111M-5.5	7314151839819	1	40
SB111M-6	7314151839826	1	40
SB111M-7	7314151839833	1	40
SB111M-8	7314151839840	1	40
SB111M-9	7314151839857	1	40
SB141.007.075	7314150282753	1	202
SB141.008.075	7314150282760	1	202
SB141.009.075	7314150282777	1	202
SB141.010.075	7314150282784	1	202
SB141.015.100	7314150282791	1	202
SB141.020.100	7314150282807	1	202
SB141.025.125	7314150282814	1	202
SB141.027.125	7314150282821	1	202
SB141.030.150	7314150282838	1	202
SB141.040.150	7314150282845	1	202
SB142.000.075	7314150282579	1	506
SB142.001.080	7314150282586	1	506
SB142.002.100	7314150282593	1	506
SB142.003.150	7314150282609	1	506
SB143.020.100	7314150282852	1	202
SB143.025.100	7314150282869	1	202
SB143.030.100	7314150282876	1	202
SB143.040.100	7314150282883	1	202
SB143.050.100	7314150282890	1	202
SB143.060.125	7314150282906	1	202
SB143.080.150	7314150282913	1	202
SB144.001.100	7314150282951	1	202
SB144.002.125	7314150282968	1	202
SB144.003.150	7314150282975	1	202
SB145.006.100	7314150282920	1	203
SB146.006.100	7314150282937	1	203
SB148.001.080	7314150314577	1	506
SB148.002.100	7314150314584	1	506
SB149.001.080	7314150314591	1	506
SB149.002.100	7314150314607	1	506
SB150.010.100	7314150343492	1	506
SB150.015.125	7314150343515	1	506
SB150.020.125	7314150343577	1	506
SB150.025.150	7314150343584	1	506
SB190.040.075	7314150281985	1	200
SB190.040.100	7314150282098	1	200
SB190.055.100	7314150281992	1	200
SB190.055.125	7314150282005	1	200
SB190.065.125	7314150282012	1	200
SB190.065.150	7314150282029	1	200
SB190.080.150	7314150282036	1	200
SB190.080.175	7314150282043	1	200
SB190.100.200	7314150282050	1	200
SB190.120.250	7314150282067	1	200
SB190.140.250	7314150282074	1	200
SB191.025.075	7314150282081	1	200
SB191.030.075	7314150282104	1	200
SB191.030.100	7314150282111	1	200
SB191.030.200	7314150282128	1	200
SB191.035.100	7314150282135	1	200
SB191.040.100	7314150282142	1	200
SB191.040.125	7314150282159	1	200



SB191.040.250	7314150282166	1	200
SB191.055.125	7314150282173	1	200
SB191.055.150	7314150282180	1	200
SB191.055.300	7314150282197	1	200
SB191.065.150	7314150282203	1	200
SB191.065.300	7314150282210	1	200
SB192.000.075	7314150282357	1	201
SB192.000.200	7314150282364	1	201
SB192.001.100	7314150282371	1	201
SB192.001.250	7314150282388	1	201
SB192.002.125	7314150282395	1	201
SB192.002.300	7314150282401	1	201
SB192.003.150	7314150282418	1	201
SB192.004.200	7314150282425	1	201
SB193.000.075	7314150282456	1	201
SB193.001.100	7314150282463	1	201
SB193.002.125	7314150282470	1	201
SB193.003.150	7314150282487	1	201
SB193.004.200	7314150282494	1	201
SB194.004.075	7314150282616	1	202
SB194.005.075	7314150282623	1	202
SB194.006.075	7314150282630	1	202
SB194.007.075	7314150282647	1	202
SB194.008.075	7314150282654	1	202
SB194.009.075	7314150282661	1	202
SB194.010.075	7314150282678	1	202
SB194.015.100	7314150282685	1	202
SB194.020.100	7314150282692	1	202
SB194.025.125	7314150282708	1	202
SB194.027.125	7314150282715	1	202
SB194.030.150	7314150282722	1	202
SB194.040.150	7314150282739	1	202
SB194.045.150	7314150282746	1	202
SB195.001.025	7314150282432	1	201
SB195.002.025	7314150282449	1	201
SB195.006.050	7314150289516	1	203
SB195.040.025	7314150282227	1	200
SB195.050.025	7314150282234	1	200
SB195.060.025	7314150282241	1	200
SB195.901.025	7314150282500	1	201
SB195.902.025	7314150282517	1	201
SB1952M-10	7314150105205	1	43
SB1952M-12	7314150105229	1	43
SB1952M-13	7314150105236	1	43
SB1952M-14	7314150105243	1	43
SB1952M-17	7314150105274	1	43
SB1952M-19	7314150105298	1	43
SB1952M-24	7314150105342	1	43
SB1952M-7	7314150105441	1	43
SB1952M-8	7314150105458	1	43
SB196.025.075	7314150282258	1	505
SB196.030.100	7314150282265	1	505
SB196.035.100	7314150282272	1	505
SB196.040.100	7314150282289	1	505
SB196.055.125	7314150282296	1	505
SB196.065.150	7314150282302	1	505
SB196.080.175	7314150282326	1	505
SB196.100.200	7314150282333	1	505
SB196.120.200	7314150282340	1	505
SB197.000.075	7314150282524	1	506
SB197.001.080	7314150282531	1	506
SB197.002.100	7314150282548	1	506
SB197.003.150	7314150282555	1	506
SB197.004.200	7314150282562	1	506
SB198.040.125	7314150282982	1	203
SB198.045.125	7314150282999	1	203
SB198.050.150	7314150283002	1	203
SB198.055.150	7314150283019	1	203
SB198.060.150	7314150283026	1	203
SB198.060.150F	7314150283033	1	203
SB198.070.150	7314150283040	1	203
SB198.070.150F	7314150283057	1	203
SB198.080.150	7314150283064	1	203
SB198.080.150F	7314150283071	1	203
SB198.090.150	7314150283088	1	203
SB198.100.150	7314150283095	1	203
SB198.110.150	7314150283101	1	203
SB198.120.150	7314150283118	1	203
SB198.130.150	7314150283125	1	203
SB198.140.150	7314150283132	1	203
SB199.055.125	7314150283149	1	506
SB199.060.125	7314150283156	1	506
SB199.070.125	7314150283163	1	506
SB199.080.125	7314150283170	1	506
SB199.090.125	7314150283187	1	506
SB199.100.125	7314150283194	1	506
SB199.110.125	7314150283200	1	506
SB199.120.125	7314150287765	1	506
SB199.130.125	7314150287796	1	506



SB2446-EL	7314150312207	10	598
SB27M-10-11	7314150180851	10	58
SB27M-12-13	7314150180868	10	58
SB27M-14-15	7314150180875	10	58
SB27M-16-17	7314150180882	10	58
SB27M-18-19	7314150180899	10	58
SB27M-20-22	7314150180905	10	58
SB27M-21-23	7314150180912	5	58
SB27M-24-26	7314150180929	5	58
SB27M-6-7	7314150180837	10	58
SB27M-8-9	7314150180844	10	58
SB28M-10	7314150485987	10	56
SB28M-11	7314150486007	10	56
SB28M-12	7314150486021	10	56
SB28M-13	7314150486045	10	56
SB28M-14	7314150486052	10	56
SB28M-15	7314150486076	10	56
SB28M-16	7314150486090	5	56
SB28M-17	7314150486113	5	56
SB28M-18	7314150486137	5	56
SB28M-19	7314150486151	5	56
SB28M-20	7314150486854	4	56
SB28M-21	7314150486878	4	56
SB28M-22	7314150486892	4	56
SB28M-23	7314150486915	4	56
SB28M-24	7314150486939	4	56
SB28M-6	7314150486175	10	56
SB28M-7	7314150486199	10	56
SB28M-8	7314150486212	10	56
SB28M-9	7314150486236	10	56
SB3654BM-15	7314150270897	5	624
SB3654BM-20	7314150270903	5	624
SB3734BM-10	7314150271092	5	624
SB3734BM-3	7314150270996	5	624
SB3734BM-4	7314150271016	5	624
SB3734BM-5	7314150271030	5	624
SB3734BM-6	7314150271054	5	624
SB3734BM-8	7314150271078	5	624
SB3755BM-4	7314150270934	1	624
SB3755BM-6	7314150270958	5	624
SB6700SM-10	7314150104383	1	79
SB6700SM-11	7314150104390	1	79
SB6700SM-12	7314150104406	1	79
SB6700SM-13	7314150104413	1	79
SB6700SM-14	7314150104420	1	79
SB6700SM-4	7314150104307	1	79
SB6700SM-4.5	7314150104314	1	79
SB6700SM-5	7314150104321	1	79
SB6700SM-5.5	7314150104338	1	79
SB6700SM-6	7314150104345	1	79
SB6700SM-7	7314150104352	1	79
SB6700SM-8	7314150104369	1	79
SB6700SM-9	7314150104376	1	79
SB6700SZ-1/2	7314150240609	1	80
SB6700SZ-1/4	7314150240616	1	80
SB6700SZ-1/8	7314150412495	5	80
SB6700SZ-11/32	7314150240623	1	80
SB6700SZ-3/16	7314150240630	1	80
SB6700SZ-3/8	7314150240647	1	80
SB6700SZ-5/16	7314150240654	1	80
SB6700SZ-5/32	7314150240661	1	80
SB6700SZ-7/16	7314150240678	1	80
SB6700SZ-7/32	7314150240685	1	80
SB6700SZ-9/16	7314150240692	1	80
SB6700SZ-9/32	7314150240708	1	80
SB6700TORX-E10	7314150240715	1	80
SB6700TORX-E4	7314150240722	1	80
SB6700TORX-E5	7314150240739	1	80
SB6700TORX-E6	7314150240746	1	80
SB6700TORX-E7	7314150240753	1	80
SB6700TORX-E8	7314150240760	1	80
SB6709F-4.5	7314150240777	1	84
SB6709F-5.5	7314150240784	1	84
SB6709F-6.5	7314150240791	1	84
SB6709F-8	7314150240807	1	84
SB6709M-3	7314150240814	1	85
SB6709M-4	7314150240821	1	85
SB6709M-5	7314150240838	1	85
SB6709M-6	7314150240845	1	85
SB6709M-8	7314150240852	1	85
SB6709PH-1	7314150240869	1	84
SB6709PH-2	7314150240876	1	84
SB6709PH-3	7314150240883	1	84
SB6709PZ-1	7314150240890	1	84
SB6709PZ-2	7314150240906	1	84
SB6709PZ-3	7314150240913	1	84
SB6709TORX-R-T10	7314150240975	1	84
SB6709TORX-R-T15	7314150240937	1	84
SB6709TORX-R-T20	7314150240944	1	84



SB6709TORX-R-T25



SB6709TORX-R-T25	7314150240951	1	84
SB6709TORX-R-T8	7314150240968	1	84
SB6709TORX-T10	7314150240982	1	84
SB6709TORX-T15	7314150240999	1	84
SB6709TORX-T20	7314150241002	1	84
SB6709TORX-T25	7314150241019	1	84
SB6709TORX-T27	7314150241026	1	84
SB6709TORX-T30	7314150241033	1	84
SB6709TORX-T40	7314150241040	1	84
SB6709TORX-T8	7314150241057	1	84
SB6709TORX-T9	7314150241064	1	84
SB6950	7314150104987	1	85
SB6950RN	7314150104994	1	85
SB6954	7314150250158	10	82
SB6956	7314150241071	1	82
SB6958-6	7314150500833	1	82
SB6960	7314150104925	1	82
SB6961	7314150104932	1	82
SB6962	7314150104949	1	82
SB6962L	7314150254743	1	82
SB6963	7314150241088	1	82
SB6966	7314150241095	1	82
SB6973A	7314150507214	1	83
SB6M-10-11	7314150105731	1	48
SB6M-12-13	7314150105762	1	48
SB6M-14-15	7314150105823	1	48
SB6M-16-17	7314150105847	1	48
SB6M-17-19	7314150189830	1	48
SB6M-18-19	7314150105878	1	48
SB6M-20-22	7314150105915	1	48
SB6M-21-23	7314150105922	1	48
SB6M-22-24	7314150105946	1	48
SB6M-24-26	7314150105953	1	48
SB6M-24-27	7314150105960	1	48
SB6M-25-28	7314150189847	1	48
SB6M-27-29	7314150189854	1	48
SB6M-30-32	7314150106011	1	48
SB6M-4-5	7314150106042	1	48
SB6M-6-7	7314150106073	1	48
SB6M-8-9	7314150106103	1	48
SB705.1/4.125	7314150283231	1	216
SB7400SM-10	7314150241101	1	86
SB7400SM-11	7314150241118	1	86
SB7400SM-12	7314150241125	1	86
SB7400SM-13	7314150241132	1	86
SB7400SM-14	7314150241149	1	86
SB7400SM-15	7314150241156	1	86
SB7400SM-16	7314150241170	1	86
SB7400SM-17	7314150241187	1	86
SB7400SM-18	7314150241194	1	86
SB7400SM-19	7314150241200	1	86
SB7400SM-20	7314150241217	1	86
SB7400SM-21	7314150241224	1	86
SB7400SM-22	7314150241231	1	86
SB7400SM-6	7314150241248	1	86
SB7400SM-7	7314150241255	1	86
SB7400SM-8	7314150241262	1	86
SB7400SM-9	7314150241279	1	86
SB7400TORX-E10	7314150241286	1	88
SB7400TORX-E11	7314150241293	1	88
SB7400TORX-E12	7314150241309	1	88
SB7400TORX-E14	7314150241316	1	88
SB7400TORX-E16	7314150241323	1	88
SB7400TORX-E18	7314150241330	1	88
SB7400TORX-E8	7314150241347	1	88
SB7409BH-10	7314150241354	1	91
SB7409BH-4	7314150241361	1	91
SB7409BH-5	7314150241378	1	91
SB7409BH-6	7314150241385	1	91
SB7409BH-8	7314150241392	1	91
SB7409F-10	7314150241408	1	90
SB7409F-6.5	7314150241415	1	90
SB7409F-8	7314150241422	1	90
SB7409M-10	7314150241439	1	91
SB7409M-3	7314150241446	1	91
SB7409M-4	7314150241453	1	91
SB7409M-5	7314150241460	1	91
SB7409M-6	7314150241477	1	91
SB7409M-7	7314150241484	1	91
SB7409M-8	7314150241491	1	91
SB7409PH-1	7314150241507	1	91
SB7409PH-2	7314150241514	1	91
SB7409PH-3	7314150241521	1	91
SB7409TORX-R-T27	7314150241538	1	91
SB7409TORX-R-T30	7314150241545	1	91
SB7409TORX-R-T40	7314150241552	1	91
SB7409TORX-R-T45	7314150241569	1	91
SB7409TORX-R-T50	7314150241576	1	91
SB7409TORX-T20	7314150241583	1	91



SB7409TORX-T25	7314150241590	1	91
SB7409TORX-T25-L	7314150241606	1	91
SB7409TORX-T27	7314150241613	1	91
SB7409TORX-T30	7314150241620	1	91
SB7409TORX-T30-L	7314150241637	1	91
SB7409TORX-T40	7314150241644	1	91
SB7409TORX-T40-L	7314150241651	1	91
SB7409TORX-T45	7314150241668	1	91
SB7409TORX-T45-L	7314150241675	1	91
SB7409TORX-T50	7314150241682	1	91
SB7409TORX-T50-L	7314150241699	1	91
SB7750	7314150187850	1	90
SB7750RN	7314153003966	1	90
SB7754	7314150250165	1	88
SB7755-3/8	7314153010100	1	90
SB7756	7314150489176	1	88
SB7759	7314150254859	1	89
SB7760	7314153003980	1	88
SB7761	7314150241705	1	88
SB7762	7314153004000	1	88
SB7764	7314150241729	1	89
SB7765	7314150241736	1	89
SB7766	7314150241743	1	83
SB7767	7314150254897	1	83
SB7800DM-10	7314150104451	1	93
SB7800DM-11	7314150104468	1	93
SB7800DM-12	7314150104475	1	93
SB7800DM-13	7314150104482	1	93
SB7800DM-14	7314150104499	1	93
SB7800DM-15	7314150104505	1	93
SB7800DM-16	7314150104512	1	93
SB7800DM-17	7314150104529	1	93
SB7800DM-18	7314150104536	1	93
SB7800DM-19	7314150104543	1	93
SB7800DM-20	7314150104550	1	93
SB7800DM-21	7314150104567	1	93
SB7800DM-22	7314150104574	1	93
SB7800DM-23	7314150104581	1	93
SB7800DM-24	7314150104598	1	93
SB7800DM-25	7314150104604	1	93
SB7800DM-26	7314150104611	1	93
SB7800DM-27	7314150104628	1	93
SB7800DM-28	7314150104635	1	93
SB7800DM-29	7314150104642	1	93
SB7800DM-30	7314150104659	1	93
SB7800DM-31	7314150471171	1	93
SB7800DM-32	7314150104666	1	93
SB7800DM-33	7314150240319	1	93
SB7800DM-34	7314150327607	1	93
SB7800DM-36	7314150104673	1	93
SB7800DM-8	7314150104437	1	93
SB7800DM-9	7314150104444	1	93
SB7800DZ-1	7314150234912	1	94
SB7800DZ-1.1/16	7314150240326	1	94
SB7800DZ-1.1/4	7314150240333	1	94
SB7800DZ-1.1/8	7314150240340	1	94
SB7800DZ-1.3/16	7314150240357	1	94
SB7800DZ-1.5/16	7314150240364	1	94
SB7800DZ-1/2	7314150234899	1	94
SB7800DZ-11/16	7314150234929	1	94
SB7800DZ-13/16	7314150234936	1	94
SB7800DZ-15/16	7314150234943	1	94
SB7800DZ-19/32	7314150240371	1	94
SB7800DZ-25/32	7314150240388	1	94
SB7800DZ-3/4	7314150234950	1	94
SB7800DZ-3/8	7314150234967	1	94
SB7800DZ-5/8	7314150234974	1	94
SB7800DZ-7/16	7314150234981	1	94
SB7800DZ-7/8	7314150234998	1	94
SB7800DZ-9/16	7314150235001	1	94
SB7800SM-10	7314150104703	1	93
SB7800SM-11	7314150104710	1	93
SB7800SM-12	7314150104727	1	93
SB7800SM-13	7314150104734	1	93
SB7800SM-14	7314150104741	1	93
SB7800SM-15	7314150104758	1	93
SB7800SM-16	7314150104765	1	93
SB7800SM-17	7314150104772	1	93
SB7800SM-18	7314150104789	1	93
SB7800SM-19	7314150104796	1	93
SB7800SM-20	7314150240395	1	93
SB7800SM-21	7314150104819	1	93
SB7800SM-22	7314150104826	1	93
SB7800SM-23	7314150104833	1	93
SB7800SM-24	7314150104840	1	93
SB7800SM-25	7314150104857	1	93
SB7800SM-26	7314150104864	1	93
SB7800SM-27	7314150104871	1	93
SB7800SM-28	7314150104888	1	93



SB7800SM-29	7314150240401	1	93
SB7800SM-30	7314150104895	1	93
SB7800SM-32	7314150104901	1	93
SB7800SM-33	7314150240418	1	93
SB7800SM-34	7314150235018	1	93
SB7800SM-36	7314150235025	1	93
SB7800SM-8	7314150104680	1	93
SB7800SM-9	7314150104697	1	93
SB7800TORX-E10	7314150240104	1	94
SB7800TORX-E11	7314150240111	1	94
SB7800TORX-E12	7314150240128	1	94
SB7800TORX-E14	7314150240135	1	94
SB7800TORX-E16	7314150240142	1	94
SB7800TORX-E18	7314150240159	1	94
SB7800TORX-E20	7314150240166	1	94
SB7800TORX-E24	7314150240173	1	94
SB7800TORX-E8	7314150240180	1	94
SB7805DM-10	7314150234851	1	94
SB7805DM-12	7314150234868	1	94
SB7805DM-13	7314150235032	1	94
SB7805DM-14	7314150235049	1	94
SB7805DM-15	7314150235056	1	94
SB7805DM-16	7314150235063	1	94
SB7805DM-17	7314150235070	1	94
SB7805DM-18	7314150235087	1	94
SB7805DM-19	7314150235094	1	94
SB7805DM-21	7314150235100	1	94
SB7805DM-22	7314150235117	1	94
SB7805DM-23	7314150327614	1	94
SB7805DM-24	7314150235124	1	94
SB7805DM-26	7314150240197	1	94
SB7805DM-27	7314150235131	1	94
SB7805DM-30	7314150235148	1	94
SB7805DM-32	7314150240203	1	94
SB7805SM-10	7314150235155	1	93
SB7805SM-12	7314150235162	1	93
SB7805SM-13	7314150235179	1	93
SB7805SM-14	7314150235193	1	93
SB7805SM-15	7314150235216	1	93
SB7805SM-16	7314150240210	1	93
SB7805SM-17	7314150235223	1	93
SB7805SM-18	7314150235230	1	93
SB7805SM-19	7314150235247	1	93
SB7805SM-20	7314150240227	1	93
SB7805SM-21	7314150235254	1	93
SB7805SM-22	7314150235261	1	93
SB7805SM-23	7314150240234	1	93
SB7805SM-24	7314150235278	1	93
SB7805SM-25	7314150240241	1	93
SB7805SM-26	7314150240258	1	93
SB7805SM-27	7314150235285	1	93
SB7805SM-28	7314150240265	1	93
SB7805SM-29	7314150240272	1	93
SB7805SM-30	7314150235292	1	93
SB7805SM-32	7314150235308	1	93
SB7805SM-34	7314150498284	1	93
SB7807H	7314150467297	1	177
SB7808H	7314150467303	1	177
SB7809H	7314150467341	1	177
SB7809M-10	7314153004185	1	97
SB7809M-10-140	7314153004192	1	98
SB7809M-12	7314153004208	1	97
SB7809M-14	7314153004215	1	97
SB7809M-17	7314153004222	1	97
SB7809M-19	7314153004239	1	97
SB7809M-4	7314150313952	1	97
SB7809M-5	7314153004109	1	97
SB7809M-5-100	7314150313969	1	98
SB7809M-5-180	7314153004116	1	98
SB7809M-6	7314153004123	1	97
SB7809M-6-100	7314150313976	1	98
SB7809M-6-140	7314153013231	1	98
SB7809M-7	7314153004130	1	97
SB7809M-7-100	7314153004147	1	98
SB7809M-8	7314153004154	1	97
SB7809M-8-120	7314153004161	1	98
SB7809M-9	7314153004178	1	97
SB7809TORX-T20	7314153004017	1	97
SB7809TORX-T25	7314153004024	1	97
SB7809TORX-T27	7314153004031	1	97
SB7809TORX-T30	7314153004048	1	97
SB7809TORX-T40	7314153004055	1	97
SB7809TORX-T45	7314153004062	1	97
SB7809TORX-T50	7314153004079	1	97
SB7809TORX-T55	7314153004086	1	97
SB7809TORX-T60	7314153004093	1	97
SB8150-1/2	7314150105014	1	98
SB8150RN-1/2	7314150105007	1	98
SB8154-11	7314150472178	1	95



SB8157-10	7314150474073	1	95
SB8157-15	7314150472468	1	95
SB8157-24	7314150474080	1	95
SB8157-36	7314150474097	1	95
SB8158-10	7314150488780	1	95
SB8158-15	7314150488797	1	95
SB8160-10	7314150472185	1	95
SB8160-3	7314150472192	1	95
SB8160-5	7314150472208	1	95
SB8166	7314150472154	1	95
SB8171	7314150479016	1	96
SB8172	7314150479023	1	96
SBA6700DM-10	7314150235575	1	81
SBA6700DM-11	7314150241750	1	81
SBA6700DM-12	7314150241767	1	81
SBA6700DM-13	7314150241774	1	81
SBA6700DM-14	7314150241781	1	81
SBA6700DM-5	7314150255054	1	80
SBA6700DM-5.5	7314150241798	1	80
SBA6700DM-6	7314150241804	1	80
SBA6700DM-7	7314150241811	1	80
SBA6700DM-8	7314150241828	1	80
SBA6700DM-9	7314150241835	1	81
SBA6700DZ-1/2	7314150241842	1	81
SBA6700DZ-1/4	7314150241859	1	81
SBA6700DZ-11/32	7314150241866	1	81
SBA6700DZ-3/16	7314150241873	1	81
SBA6700DZ-3/8	7314150241880	1	81
SBA6700DZ-5/16	7314150241897	1	81
SBA6700DZ-7/16	7314150241903	1	81
SBA6700DZ-7/32	7314150241910	1	81
SBA6700DZ-9/16	7314150241927	1	81
SBA6700DZ-9/32	7314150241934	1	81
SBA6709M-2.5	7314150254835	1	85
SBA6709M-3	7314150254828	1	85
SBA6709M-4	7314150254811	1	85
SBA6709M-5	7314150254804	1	85
SBA6709M-6	7314150254798	1	85
SBA6709Z-1/8	7314150254781	1	85
SBA6709Z-3/16	7314150254774	1	85
SBA6709Z-5/32	7314150254767	1	85
SBA6709Z-9/64	7314150254750	1	85
SBA6800DM-10	7314150250172	1	81
SBA6800DM-11	7314150250189	1	81
SBA6800DM-12	7314150250196	1	81
SBA6800DM-13	7314150250202	1	81
SBA6800DM-14	7314150250219	1	81
SBA6800DM-4	7314150250226	1	81
SBA6800DM-5	7314150250233	1	81
SBA6800DM-5.5	7314150250240	1	81
SBA6800DM-6	7314150250257	1	81
SBA6800DM-7	7314150250264	1	81
SBA6800DM-8	7314150250271	1	81
SBA6800DM-9	7314150250288	1	81
SBA6800DZ-1/2	7314150250295	1	81
SBA6800DZ-1/4	7314150250301	1	81
SBA6800DZ-11/32	7314150250318	1	81
SBA6800DZ-3/16	7314150250325	1	81
SBA6800DZ-3/8	7314150250332	1	81
SBA6800DZ-5/16	7314150250349	1	81
SBA6800DZ-7/16	7314150250356	1	81
SBA6800DZ-7/32	7314150250363	1	81
SBA6800DZ-9/16	7314150250370	1	81
SBA6800DZ-9/32	7314150250387	1	81
SBA7400DM-10	7314150241941	1	87
SBA7400DM-11	7314150241958	1	87
SBA7400DM-12	7314150241965	1	87
SBA7400DM-13	7314150241972	1	87
SBA7400DM-14	7314150241989	1	87
SBA7400DM-15	7314150241996	1	87
SBA7400DM-16	7314150242009	1	87
SBA7400DM-17	7314150242016	1	87
SBA7400DM-18	7314150242023	1	87
SBA7400DM-19	7314150242030	1	87
SBA7400DM-20	7314150242047	1	87
SBA7400DM-21	7314150242054	1	87
SBA7400DM-22	7314150242061	1	87
SBA7400DM-6	7314150242078	1	87
SBA7400DM-7	7314150242085	1	87
SBA7400DM-8	7314150242092	1	87
SBA7400DM-9	7314150242108	1	87
SBA7400DZ-1/2	7314150254705	1	87
SBA7400DZ-1/4	7314150242115	1	87
SBA7400DZ-11/16	7314150242122	1	87
SBA7400DZ-13/16	7314150242139	1	87
SBA7400DZ-17/32	7314150242146	1	87
SBA7400DZ-19/32	7314150242153	1	87
SBA7400DZ-3/4	7314150242160	1	87
SBA7400DZ-3/8	7314150242177	1	87



SBA7400DZ-5/16



SBA7400DZ-5/16	7314150242184	1	87
SBA7400DZ-5/8	7314150242191	1	87
SBA7400DZ-7/16	7314150242207	1	87
SBA7400DZ-7/8	7314150242214	1	87
SBA7400DZ-9/16	7314150242221	1	87
SBA7402DM-10	7314150250394	1	87
SBA7402DM-11	7314150250400	1	87
SBA7402DM-12	7314150250417	1	87
SBA7402DM-13	7314150250424	1	87
SBA7402DM-14	7314150250431	1	87
SBA7402DM-15	7314150250448	1	87
SBA7402DM-16	7314150250455	1	87
SBA7402DM-17	7314150250462	1	87
SBA7402DM-18	7314150250479	1	87
SBA7402DM-19	7314150250486	1	87
SBA7402DM-7	7314150250493	1	87
SBA7402DM-8	7314150250509	1	87
SBA7402DM-9	7314150250516	1	87
SBA7402DZ-1/2	7314150250523	1	88
SBA7402DZ-1/4	7314150250530	1	88
SBA7402DZ-11/16	7314150250547	1	88
SBA7402DZ-13/16	7314150250554	1	88
SBA7402DZ-19/32	7314150250561	1	88
SBA7402DZ-3/4	7314150250578	1	88
SBA7402DZ-3/8	7314150250585	1	88
SBA7402DZ-5/16	7314150250592	1	88
SBA7402DZ-5/8	7314150250608	1	88
SBA7402DZ-7/16	7314150250615	1	88
SBA7402DZ-7/8	7314150250622	1	88
SBA7402DZ-9/16	7314150250639	1	88
SBC110-65	7314150456246	1	587
SBE-8135TB	7314150320424	1	198
SBE-8145TB	7314150320431	1	198
SBE-8150TB	7314150320448	1	198
SBE-8155TB	7314150320455	1	198
SBE-8610TB	7314150320493	1	199
SBE-8620TB	7314150320509	1	199
SBE-8810TB	7314150320530	1	199
SBE-8820TB	7314150320547	1	199
SBE-8915TB	7314150320585	1	199
SBE-8920TB	7314150320592	1	199
SBE-8925TB	7314150320608	1	199
SBE-8930TB	7314150320622	1	199
SBE-8940TB	7314150320639	1	199
SBK6701M-10	7314150445233	1	173
SBK6701M-11	7314150445240	1	173
SBK6701M-12	7314150445264	1	173
SBK6701M-13	7314150445271	1	173
SBK6701M-14	7314150445288	1	173
SBK6701M-6	7314150445196	1	172
SBK6701M-7	7314150445202	1	172
SBK6701M-8	7314150445219	1	172
SBK6701M-9	7314150445226	1	173
SBK7401M-10	7314150445325	1	173
SBK7401M-11	7314150445332	1	173
SBK7401M-12	7314150445349	1	173
SBK7401M-13	7314150445356	1	173
SBK7401M-14	7314150445363	1	173
SBK7401M-15	7314150445370	1	173
SBK7401M-16	7314150445387	1	173
SBK7401M-17	7314150445394	1	173
SBK7401M-18	7314150445400	1	173
SBK7401M-19	7314150445417	1	173
SBK7401M-20	7314150445424	1	173
SBK7401M-21	7314150445431	1	173
SBK7401M-22	7314150445448	1	173
SBK7401M-24	7314150445455	1	173
SBK7401M-7	7314150445295	1	173
SBK7401M-8	7314150445301	1	173
SBK7401M-9	7314150445318	1	173
SBK7764D	7314150447800	1	177
SBK7801M-10	7314150445486	1	175
SBK7801M-11	7314150445493	1	175
SBK7801M-12	7314150445509	1	175
SBK7801M-13	7314150445516	1	175
SBK7801M-14	7314150445523	1	175
SBK7801M-15	7314150445530	1	175
SBK7801M-16	7314150445547	1	175
SBK7801M-17	7314150445554	1	175
SBK7801M-18	7314150445561	1	175
SBK7801M-19	7314150445578	1	175
SBK7801M-20	7314150445585	1	175
SBK7801M-21	7314150445592	1	175
SBK7801M-22	7314150445608	1	175
SBK7801M-23	7314150445615	1	175
SBK7801M-24	7314150445622	1	175
SBK7801M-25	7314150445639	1	175
SBK7801M-26	7314150445646	1	175
SBK7801M-27	7314150445653	1	175



SBK7801M-28	7314150450763	1	175
SBK7801M-29	7314150450770	1	175
SBK7801M-30	7314150445660	1	175
SBK7801M-32	7314150445677	1	175
SBK7801M-34	7314150445684	1	175
SBK7801M-36	7314150445691	1	175
SBK7801M-8	7314150445462	1	175
SBK7801M-9	7314150445479	1	175
SBK7801Z-1	7314150448036	1	176
SBK7801Z-1.1/16	7314150448142	1	176
SBK7801Z-1.1/2	7314150448203	1	176
SBK7801Z-1.1/4	7314150448166	1	176
SBK7801Z-1.1/8	7314150448159	1	176
SBK7801Z-1.3/8	7314150448180	1	176
SBK7801Z-1.5/16	7314150448173	1	176
SBK7801Z-1.7/16	7314150448197	1	176
SBK7801Z-1/2	7314150448067	1	176
SBK7801Z-11/16	7314150448098	1	176
SBK7801Z-13/16	7314150448111	1	176
SBK7801Z-15/16	7314150448135	1	176
SBK7801Z-3/4	7314150448104	1	176
SBK7801Z-3/8	7314150448043	1	176
SBK7801Z-5/8	7314150448081	1	176
SBK7801Z-7/16	7314150448050	1	176
SBK7801Z-7/8	7314150448128	1	176
SBK7801Z-9/16	7314150448074	1	176
SBK7806M-10	7314150447831	1	176
SBK7806M-11	7314150447862	1	176
SBK7806M-12	7314150447879	1	176
SBK7806M-13	7314150447886	1	176
SBK7806M-14	7314150447893	1	176
SBK7806M-15	7314150447909	1	176
SBK7806M-16	7314150447916	1	176
SBK7806M-17	7314150447923	1	176
SBK7806M-18	7314150447930	1	176
SBK7806M-19	7314150447947	1	176
SBK7806M-21	7314150447954	1	176
SBK7806M-22	7314150447961	1	176
SBK7806M-23	7314150447978	1	176
SBK7806M-24	7314150447985	1	176
SBK7806M-27	7314150447992	1	176
SBK7806M-30	7314150448005	1	176
SBK7806M-32	7314150448012	1	176
SBK7806M-36	7314150448029	1	176
SBK7806Z-1	7314150448401	1	176
SBK7806Z-1.1/16	7314150448418	1	176
SBK7806Z-1.1/2	7314150448470	1	176
SBK7806Z-1.1/4	7314150448432	1	176
SBK7806Z-1.1/8	7314150448425	5	176
SBK7806Z-1.3/8	7314150448456	5	176
SBK7806Z-1.5/16	7314150448449	1	176
SBK7806Z-1.7/16	7314150448463	5	176
SBK7806Z-1/2	7314150448326	10	176
SBK7806Z-11/16	7314150448357	1	176
SBK7806Z-13/16	7314150448371	1	176
SBK7806Z-15/16	7314150448395	1	176
SBK7806Z-3/4	7314150448364	1	176
SBK7806Z-3/8	7314150448302	10	176
SBK7806Z-5/8	7314150448340	5	176
SBK7806Z-7/16	7314150448319	10	176
SBK7806Z-7/8	7314150448388	1	176
SBK7806Z-9/16	7314150448333	10	176
SBK8160D-1	7314150447770	1	177
SBK8160D-2	7314150447787	1	177
SBK8160D-3	7314150447794	1	177
SBK8901M-17	7314150448487	1	179
SBK8901M-18	7314150448494	1	179
SBK8901M-19	7314150448500	1	179
SBK8901M-21	7314150448517	1	179
SBK8901M-22	7314150448524	1	179
SBK8901M-23	7314150448531	1	179
SBK8901M-24	7314150448548	1	179
SBK8901M-27	7314150448555	1	179
SBK8901M-28	7314150448562	1	179
SBK8901M-29	7314150448579	1	179
SBK8901M-30	7314150448586	1	179
SBK8901M-32	7314150448593	1	179
SBK8901M-33	7314150448609	1	179
SBK8901M-34	7314150448616	1	179
SBK8901M-36	7314150448623	1	179
SBK8901M-38	7314150448630	1	179
SBK8901M-41	7314150448647	1	179
SBK8901M-46	7314150448654	1	179
SBK8901M-50	7314150448661	1	179
SBK8901M-55	7314150448678	1	179
SBK8901M-60	7314150448685	1	179
SBK8964D	7314150447817	1	179
SBS19-TH10	7314150190072	1	92
SBS19-TH11	7314150190089	1	92

Item	Code	QTY	Unit
SBS19-TH12	7314150190096	1	92
SBS19-TH13	7314150190102	1	92
SBS19-TH14	7314150190119	1	92
SBS19-TH15	7314150190126	1	92
SBS19-TH16	7314150190133	1	92
SBS19-TH17	7314150190140	1	92
SBS19-TH18	7314150190157	1	92
SBS19-TH19	7314150190164	1	92
SBS19-TH21	7314150190256	1	92
SBS19-TH22	7314150190188	1	92
SBS19-TH24	7314150190195	1	92
SBS20-11	7314153009159	1	41
SBS20-12	7314153009166	1	41
SBS20-13	7314153009173	1	41
SBS20-14	7314153009180	1	41
SBS20-15	7314153009197	1	41
SBS20-16	7314153009203	1	41
SBS20-20	7314153009241	1	41
SBS20-22	7314153009265	1	41
SBS20-24	7314153009272	1	41
SBS20-7	7314153009111	1	41
SBS20-8	7314153009128	1	41
SBS20-9	7314153009135	1	41
SBS61	7314153009661	1	85
SBS61S	7314150179886	1	85
SBS705	7314153012968	1	88
SBS750	7314153012883	10	90
SBS780	7314150125197	1	89
SBS81	7314153009937	5	99
SBSL25	7314153015853	5	64
SC127	7314150121984	10	593
SC127S	7314150121991	10	593
SC127V	7314150121847	5	513
SC140	7314150122004	10	593
SC140C	7314150122011	10	593
SC150NG	7314150122028	10	593
SC150NGV	7314150121854	5	513
SC2RM-13-17	7314150265350	10	104
SC2RM-15-17	7314150265367	10	104
SC2RM-19-22	7314150181384	10	104
SC2RM-27-30	7314150265343	1	104
SC335M-17	7314150344314	1	51
SC335M-19	7314150344321	1	51
SC335M-22	7314150344338	1	51
SC335M-24	7314150344345	1	51
SC335M-27	7314150344352	1	51
SC335M-30	7314150344369	1	51
SC335M-32	7314150344376	1	51
SC335M-36	7314150344383	1	51
SC335M-41	7314150344390	1	51
SC335M-46	7314150344406	1	51
SCB140	7314150297351	10	593
SCB140G	7314150297368	10	593
SCRAPER-SET2	7311518228613	1	562
SE-15-24	7311518029838	5	647
SE-15-30	7311518029821	5	647
SE-15-30-23	7311518029845	5	647
SE-15-32	7311518249168	5	647
SE-15-36	7311518141202	5	647
SE-15-36-23	7311518258276	5	647
SE-16-21	7311518029807	5	647
SE-16-21-23	7311518273934	5	647
SH-407	7314150389827	1	610
SH-427-700	7314150349074	10	610
SH-428-700	7314150349081	10	610
SH-485W	7314150358021	1	608
SH-485W-PLATES	7314150358038	1	608
SH-486-493-495	7314150349098	10	610
SH-486F493F495F	7314150349104	10	610
SH-486W	7314150358014	1	609
SH-488-2000	7314150346912	10	610
SH-488-34	7314150349036	10	610
SH-488-56	7314150349043	10	610
SH-488F-2000	7314150346950	10	610
SH-488F-34	7314150349050	1	610
SH-488F-56	7314150349067	1	610
SH-491-34	7314150374298	12	610
SH-491-56	7314150374304	12	610
SH-FCP-860	7311518324421	1	615
SH-FCS-810	7311518140540	1	615
SH-FCS-860	7311518140557	1	615
SH-FGS-1.8-810	7311518327828	1	615
SH-FGS-600	7311518140649	1	615
SH-FGS-700	7311518140656	12	615
SH-FGS-800	7311518140663	1	615
SH-HFGPS-400FG	7311518282301	1	615
SH-HGPS-360	7311518140618	12	615
SH-HGPS-380	7311518140625	1	615
SH-HGPS-400	7311518207618	1	615

Item	Code	QTY	Unit
SH-HUS-380	7311518140502	1	615
SH-HUS-500	7311518140519	1	615
SH-HUS-650	7311518140526	1	615
SH-MCS-800	7311518140595	1	615
SH-MES-900	7311518140601	12	615
SH-MES-900FG	7311518282318	12	615
SH-MES-F-900	7311518141554	12	615
SH-PAGS-900	7311518327866	1	615
SH-PAGS-900FG	7311518326944	1	615
SH-SUS-800	7311518140809	12	615
SHARP-INS	7314150197897	100	580
SHARP-X	7311518264895	10	651
SHARP-X-DISP	7311518264901	1	651
SL24	7314150128389	1	64
SL25	7314153013422	24	64
SL25AF	7314150180141	1	64
SL25L	7314150256570	10	64
SL34	7314150409181	6	70
SL65	7314150444137	6	64
SL79	7314150444144	4	63
SL91	7314150444151	4	63
SLX 17	7314153015785	1	78
SLX 17AF	7314150137558	1	78
SLX17-CASE	7314150321254	1	104
SP120	7314150312474	1	96
SP120XL	7314150313594	1	96
SPAR-CASE-A4	7314150263523	1	104
SPAR-CASE-A6	7314150263547	1	104
SPAR-CASE-A7	7314150263554	1	104
SQZ-MINI	7314150186280	24	596
SQZ-MINI-BLADE	7314150190348	1	597
SQZ150003	7314153013477	6	594
SQZ150003-HSBL	7314153015389	6	595
SQZ150003-SBL	7314153015372	1	595
SR1000-E	7314150302918	20	558
SR1000-MM	7314150302857	20	557
SR150-E	7314150302864	12	558
SR150-MM	7314150302819	12	557
SR200-E	7314150302871	12	558
SR200-MM	7314150302826	12	557
SR300-E	7314150302888	12	558
SR300-MM	7314150302833	12	557
SR600-E	7314150302901	20	558
SR600-MM	7314150302840	20	557
SS001-100	7314150404384	1	538
SS001-150	7314150404377	1	538
SS001-200	7314150404391	1	538
SS001-250	7314150404407	1	538
SS001-300	7314150404414	1	538
SS001-375	7314150404421	1	538
SS001-450	7314150404438	1	538
SS001-600	7314150404445	1	538
SS002-10	7314150404483	1	538
SS002-11	7314150404490	1	538
SS002-12	7314150404506	1	538
SS002-13	7314150404513	1	538
SS002-14	7314150404520	1	538
SS002-15	7314150404537	1	538
SS002-16	7314150404551	1	538
SS002-17	7314150404568	1	538
SS002-19	7314150404575	1	538
SS002-21	7314150404582	1	538
SS002-22	7314150404599	1	538
SS002-24	7314150404605	1	538
SS002-27	7314150404612	1	538
SS002-32	7314150404629	1	538
SS002-6	7314150404469	1	538
SS002-6-2	7314150407903	1	538
SS002-8	7314150404476	1	538
SS002-9-2	7314150407910	1	538
SS003-10	7314150404643	1	538
SS003-11	7314150404650	1	538
SS003-12	7314150404667	1	538
SS003-14	7314150404681	1	538
SS003-16	7314150404704	1	538
SS003-18	7314150404711	1	538
SS003-20	7314150404728	1	538
SS003-22	7314150404735	1	538
SS003-24	7314150404742	1	538
SS003-25	7314150404759	1	538
SS003-26	7314150404766	1	538
SS003-28	7314150404773	1	538
SS003-30	7314150404780	1	538
SS003-8	7314150404636	1	538
SS011-0507	7314150404797	1	538
SS011-0607	7314150404803	1	538
SS011-0809	7314150404810	1	538
SS011-0810	7314150404827	1	538
SS011-0911	7314150404834	1	538





SS011-1012	7314150404858	1	538
SS011-11-3	7314150419142	1	539
SS011-1214	7314150404865	1	538
SS011-1417	7314150404872	1	538
SS011-1618	7314150404889	1	538
SS011-1719	7314150404896	1	538
SS011-1722	7314150404902	1	538
SS011-2224	7314150404919	1	538
SS011-2427	7314150404926	1	538
SS011-2430	7314150404940	1	538
SS011-3032	7314150404957	1	538
SS011-9-3	7314150419135	1	539
SS210-10	7314150405343	1	539
SS210-11	7314150405350	1	539
SS210-12	7314150405367	1	539
SS210-13	7314150405374	1	539
SS210-14	7314150405381	1	539
SS210-4	7314150405268	1	539
SS210-4.5	7314150405275	1	539
SS210-5	7314150405282	1	539
SS210-5.5	7314150405299	1	539
SS210-6	7314150405305	1	539
SS210-7	7314150405312	1	539
SS210-8	7314150405329	1	539
SS210-9	7314150405336	1	539
SS220-10	7314150404995	1	539
SS220-11	7314150405008	1	539
SS220-12	7314150405022	1	539
SS220-13	7314150405039	1	539
SS220-14	7314150405053	1	539
SS220-15	7314150405060	1	539
SS220-16	7314150405077	1	539
SS220-17	7314150405084	1	539
SS220-18	7314150405091	1	539
SS220-19	7314150405114	1	539
SS220-20	7314150405121	1	539
SS220-21	7314150405138	1	539
SS220-22	7314150405145	1	539
SS220-23	7314150405152	1	539
SS220-24	7314150405176	1	539
SS220-25	7314150405183	1	539
SS220-26	7314150405190	1	539
SS220-27	7314150405206	1	539
SS220-28	7314150405213	1	539
SS220-29	7314150405220	1	539
SS220-30	7314150405237	1	539
SS220-31	7314150405244	1	539
SS220-32	7314150405251	1	539
SS220-8	7314150404964	1	539
SS220-9	7314150404988	1	539
SS224-17	7314150405398	1	539
SS224-19	7314150405404	1	539
SS224-22	7314150405411	1	539
SS224-24	7314150405428	1	539
SS224-27	7314150405435	1	539
SS224-30	7314150405442	1	539
SS224-32	7314150405459	1	539
SS224-34	7314150405466	1	539
SS224-36	7314150405473	1	539
SS224-41	7314150405480	1	539
SS224-46	7314150405497	1	539
SS224-50	7314150405503	1	539
SS224-55	7314150405510	1	539
SS224-60	7314150405527	1	539
SS224-65	7314150405534	1	539
SS234-16-100	7314150405572	1	539
SS234-16-200	7314150405589	1	539
SS234-16-250	7314150405602	1	539
SS234-24-100	7314150405619	1	539
SS234-24-200	7314150405626	1	539
SS234-24-250	7314150405633	1	539
SS236-08-80	7314150405718	1	539
SS236-16-80	7314150405701	1	539
SS236-24-110	7314150405725	1	539
SS238-08-250	7314150405657	1	540
SS238-16-250	7314150405640	1	540
SS238-24-350	7314150405664	1	540
SS242-08-200	7314150405558	1	540
SS242-16-245	7314150405541	1	540
SS242-24-320	7314150405565	1	540
SS243-08	7314150405688	1	540
SS243-16	7314150405671	1	540
SS243-24	7314150405695	1	540
SS324-1.5	7314150405732	2	541
SS324-10	7314150405824	1	541
SS324-2	7314150405749	2	541
SS324-2.5	7314150405756	2	541
SS324-3	7314150405763	1	541
SS324-4	7314150405770	1	541



SS324-5	7314150405787	1	541
SS324-6	7314150405794	1	541
SS324-8	7314150405817	1	541
SS325-10	7314150405886	1	541
SS325-12	7314150405879	1	541
SS325-2.5	7314150405909	2	541
SS325-3	7314150405862	2	541
SS325-3.5	7314150405923	2	541
SS325-4	7314150405848	1	541
SS325-4.5	7314150405930	1	541
SS325-5	7314150405893	1	541
SS325-6	7314150405855	1	541
SS325-7	7314150405916	1	541
SS325-8	7314150405831	1	541
SS400-160	7314150405978	1	542
SS400-180	7314150405985	1	542
SS400-200	7314150405992	1	542
SS402-160	7314150406005	1	542
SS402-200	7314150406012	1	542
SS406-160	7314150406029	1	542
SS406-200	7314150406036	1	542
SS410-250	7314150406043	1	542
SS410-300	7314150406050	1	542
SS412-200	7314150406067	1	542
SS415-225	7314150406074	1	542
SS502-1000-FB	7314150406081	1	542
SS502-1500-FB	7314150406098	1	542
SS502-2000-FB	7314150406104	1	542
SS502-2500-FB	7314150406111	1	542
SS502-3000-FB	7314150406128	1	542
SS502-3600-FB	7314150406135	1	542
SS506-1100-FB	7314150406197	1	542
SS506-200-FB	7314150406142	1	542
SS506-300-FB	7314150406159	1	542
SS506-500-FB	7314150406166	1	542
SS506-700-FB	7314150406173	1	542
SS506-900-FB	7314150406180	1	542
SS603-15-500	7314150406203	1	542
SS603-19-500	7314150406210	1	542
SS603-20-500	7314150406227	1	542
SS603-23-500	7314150406234	1	542
SS603-23-800	7314150406258	1	542
SS603-25-600	7314150406241	1	542
SS603-30-1000	7314150406265	1	542
SS610-16-160	7314150406272	1	542
SS610-18-200	7314150406289	1	542
SS610-24-300	7314150406296	1	542
SS610-25-400	7314150406302	1	542
SS610-30-500	7314150406319	1	542
SUC-0.7-450	7314150342082	4	615
SUC-0.9-600	7314150342105	4	615
SUC-1.0-710	7314150342068	4	615
SUC-1.7-800	7314150342051	4	615
SUP-20-LAM	7311518258351	4	577
SUS-2.0-800	7311518123451	4	614
SW65	7314150442898	6	64
SW79	7314150442904	4	63
SW91	7314150442942	4	63
TAH08-10	7314150305087	1	485
TAH08-11	7314150305094	1	485
TAH08-12	7314150305100	1	485
TAH08-13	7314150305117	1	485
TAH08-5.5	7314150305032	1	485
TAH08-6	7314150305049	1	485
TAH08-7	7314150305056	1	485
TAH08-8	7314150305063	1	485
TAH08-9	7314150305070	1	485
TAH08-H3	7314150305124	1	486
TAH08-H4	7314150305131	1	486
TAH08-H5	7314150305148	1	486
TAH08-H6	7314150305155	1	486
TAH08-H8	7314150305162	1	486
TAH08-PH1	7314150305179	1	486
TAH08-PH2	7314150305186	1	486
TAH08-PH3	7314150305193	1	486
TAH08-T10	7314150305223	1	486
TAH08-T15	7314150305230	1	486
TAH08-T20	7314150305247	1	486
TAH08-T25	7314150305254	1	486
TAH08-T27	7314150305261	1	486
TAH08-T37	7314150305278	1	486
TAH08-T40	7314150305285	1	486
TAH08-T8	7314150305209	1	486
TAH08-T9	7314150305216	1	486
TAH1-100-06-2-4	7314150307531	1	493
TAH1-110-08-1-2	7314150437825	1	493
TAH1-143-12-1-2	7314150307548	1	493
TAH1-160-08-1-2	7314150437818	1	494
TAH1-170-08-1-2	7314150437801	1	494



TAH1-210-06-2-2	7314150307555	1	494
TAH1-210-08-1-2	7314150437795	1	494
TAH1-230-06-2-2	7314150307562	1	494
TAH1-230-08-1-2	7314150437788	1	494
TAH111M-10	7314150308538	1	483
TAH111M-11	7314150308545	1	483
TAH111M-12	7314150308552	1	483
TAH111M-13	7314150308569	1	483
TAH111M-14	7314150308576	1	483
TAH111M-15	7314150308583	1	483
TAH111M-16	7314150308590	1	483
TAH111M-17	7314150308606	1	483
TAH111M-18	7314150308613	1	483
TAH111M-19	7314150308620	1	483
TAH111M-20	7314150308637	1	483
TAH111M-21	7314150308644	1	483
TAH111M-22	7314150308651	1	483
TAH111M-23	7314150308668	1	483
TAH111M-24	7314150308675	1	483
TAH111M-25	7314150308682	1	483
TAH111M-27	7314150308689	1	483
TAH111M-30	7314150308696	1	483
TAH111M-32	7314150308703	1	483
TAH111M-34	7314150308710	1	483
TAH111M-36	7314150308717	1	483
TAH111M-41	7314150308724	1	483
TAH111M-46	7314150308731	1	483
TAH111M-50	7314150308738	1	483
TAH111M-55	7314150411573	1	483
TAH111M-6	7314150308491	1	483
TAH111M-7	7314150308507	1	483
TAH111M-8	7314150308514	1	483
TAH111M-85	7314150362356	1	483
TAH111M-9	7314150308521	1	483
TAH111Z-1	7314150343362	1	484
TAH111Z-1.1/16	7314150343379	1	484
TAH111Z-1.1/2	7314150431830	1	484
TAH111Z-1.1/4	7314150343386	1	484
TAH111Z-1.1/8	7314150343393	1	484
TAH111Z-1.11/16	7314150431854	1	484
TAH111Z-1.13/16	7314150431878	1	484
TAH111Z-1.3/4	7314150431861	1	484
TAH111Z-1.3/8	7314150431816	1	484
TAH111Z-1.5/16	7314150343409	1	484
TAH111Z-1.5/8	7314150431847	1	484
TAH111Z-1.7/16	7314150431823	1	484
TAH111Z-1.7/8	7314150431885	1	484
TAH111Z-1/2	7314150343461	1	484
TAH111Z-1/4	7314150343508	1	484
TAH111Z-11/16	7314150343522	1	484
TAH111Z-13/16	7314150343539	1	484
TAH111Z-15/16	7314150343546	1	484
TAH111Z-2	7314150431892	1	484
TAH111Z-2.1/2	7314150431922	1	484
TAH111Z-2.1/4	7314150431915	1	484
TAH111Z-2.1/8	7314150431908	1	484
TAH111Z-2.3/4	7314150431946	1	484
TAH111Z-2.3/8	7314150413959	1	484
TAH111Z-2.5/8	7314150431939	1	484
TAH111Z-2.7/8	7314150431953	1	484
TAH111Z-3	7314150431960	1	484
TAH111Z-3/4	7314150343553	1	484
TAH111Z-3/8	7314150343560	1	484
TAH111Z-5/16	7314150343591	1	484
TAH111Z-5/8	7314150343607	1	484
TAH111Z-7/16	7314150343614	1	484
TAH111Z-7/8	7314150343621	1	484
TAH111Z-9/16	7314150343638	1	484
TAH1150-1/2H/P	7314150307760	1	497
TAH1177-SCRIBER	7314150307777	1	497
TAH140	7314150344475	1	485
TAH141	7314150339433	1	485
TAH1410	7314150344543	1	485
TAH142	7314150339440	1	485
TAH1420	7314150344550	1	485
TAH143	7314150344482	1	485
TAH1544	7314150307746	1	497
TAH16-H10	7314150306176	1	487
TAH16-H12	7314150306183	1	487
TAH16-H14	7314150306190	1	487
TAH16-H17	7314150306206	1	487
TAH16-H19	7314150306213	1	487
TAH16-H4	7314150306121	1	487
TAH16-H5	7314150306138	1	487
TAH16-H6	7314150306145	1	487
TAH16-H7	7314150306152	1	487
TAH16-H8	7314150306169	1	487
TAH16-T30	7314150306220	1	487
TAH16-T40	7314150306237	1	487



TAH16-T45	7314150306244	1	487
TAH16-T50	7314150306251	1	487
TAH16-T55	7314150306268	1	487
TAH16-T60	7314150306275	1	487
TAH16B-1	7314150306077	1	487
TAH16B-1.1/16	7314150306084	1	487
TAH16B-1.1/4	7314150306107	1	487
TAH16B-1.1/8	7314150306114	1	487
TAH16B-1/2	7314150305995	1	486
TAH16B-10	7314150305629	1	486
TAH16B-11	7314150305636	1	486
TAH16B-11/16	7314150306022	1	487
TAH16B-12	7314150305643	1	486
TAH16B-13	7314150305650	1	486
TAH16B-13/16	7314150306046	1	487
TAH16B-14	7314150305667	1	486
TAH16B-15	7314150305674	1	486
TAH16B-15/16	7314150306060	1	487
TAH16B-16	7314150305698	1	486
TAH16B-17	7314150305704	1	486
TAH16B-18	7314150305711	1	486
TAH16B-19	7314150305728	1	486
TAH16B-21	7314150305735	1	486
TAH16B-22	7314150305742	1	486
TAH16B-24	7314150305759	1	486
TAH16B-25	7314150305766	1	486
TAH16B-27	7314150305773	1	486
TAH16B-3/4	7314150306039	1	487
TAH16B-30	7314150305780	1	486
TAH16B-32	7314150305797	1	486
TAH16B-5/8	7314150306015	1	487
TAH16B-7/8	7314150306053	1	487
TAH16B-8	7314150305612	1	486
TAH16B-9/16	7314150306008	1	486
TAH16BM/22	7314150422357	1	488
TAH16BZ/17	7314150422340	1	488
TAH16H-1/2	7314150306329	1	487
TAH16H-1/4	7314150306282	1	487
TAH16H-3/8	7314150306305	1	487
TAH16H-5/16	7314150306299	1	487
TAH16H-5/8	7314150306343	1	487
TAH16H-7/16	7314150306312	1	487
TAH16H-9/16	7314150306336	1	487
TAH1949M-10-11	7314150308866	1	484
TAH1949M-12-14	7314150308873	1	484
TAH1949M-14-17	7314150308880	1	484
TAH1949M-19-22	7314150308897	1	484
TAH1949M-24-27	7314150308903	1	484
TAH1949M-8-9	7314150308859	1	484
TAH1995M-10	7314150432219	1	490
TAH1995M-12	7314150432226	1	490
TAH1995M-8	7314150432202	1	490
TAH1995Z-1/2	7314150415007	1	490
TAH1RM-10	7314150414338	1	484
TAH1RM-11	7314150424306	1	484
TAH1RM-12	7314150424313	1	484
TAH1RM-13	7314150414345	1	484
TAH1RM-14	7314150424320	1	484
TAH1RM-15	7314150424337	1	484
TAH1RM-16	7314150414352	1	484
TAH1RM-17	7314150352210	1	484
TAH1RM-18	7314150414369	1	484
TAH1RM-19	7314150352227	1	484
TAH1RM-21	7314150424344	1	484
TAH1RM-22	7314150424351	1	484
TAH1RM-24	7314150352234	1	484
TAH1RM-27	7314150424368	1	484
TAH1RM-30	7314150352241	1	484
TAH1RM-32	7314150424375	1	484
TAH1RM-6	7314150424269	1	484
TAH1RM-7	7314150424276	1	484
TAH1RM-8	7314150424283	1	484
TAH1RM-9	7314150424290	1	484
TAH2047-0.8-4	7314150308088	1	491
TAH2047PR-1-2	7314150308095	1	491
TAH2101G-125	7314150344581	1	491
TAH2101G-125C	7314150344598	1	491
TAH2101G-140	7314150307869	1	491
TAH2101G-140C	7314150344611	1	491
TAH2101G-160	7314150307876	1	491
TAH2101G-160C	7314150344635	1	491
TAH2101G-180	7314150345106	1	491
TAH2101G-180C	7314150344666	1	491
TAH21HDG-200	7314150345649	1	491
TAH21HDG-200C	7314150345656	1	491
TAH2223G-150	7314150411597	1	492
TAH225-PLUS	7314150319978	1	493
TAH2427G-200	7314150307883	1	492
TAH2430G-160	7314150413942	1	491



TAH2430G-200



TAH2430G-200	7314150307906	1	491
TAH2484-30	7314150307968	1	496
TAH2487	7314150320028	1	498
TAH24B-27	7314150309306	1	488
TAH24B-30	7314150309313	1	488
TAH24B-32	7314150309320	1	488
TAH24B-36	7314150309337	1	488
TAH24B-38	7314150309344	1	488
TAH24B-41	7314150309351	1	488
TAH24B-46	7314150309368	1	488
TAH24B-50	7314150309375	1	488
TAH2509	7314150307753	1	498
TAH2535F2	7314150307784	1	498
TAH2628G-160	7314150307913	1	491
TAH2628G-180	7314150307920	1	491
TAH2628G-200	7314150432363	1	491
TAH2633/S4	7314150415014	1	498
TAH2800-150	7314150519330	1	492
TAH2800-180	7314150424559	1	492
TAH2820EF2	7314150307708	1	494
TAH2855	7314150307937	1	493
TAH2900-180	7314150424566	1	492
TAH2951-250	7314150432400	1	492
TAH2953-140	7314150415731	1	492
TAH2953-300	7314150415748	1	492
TAH2958-200	7314150320219	1	492
TAH2958-250	7314150307944	1	492
TAH2970G-200	7314150343331	1	491
TAH29M-10	7314150414413	1	485
TAH29M-11	7314150414420	1	485
TAH29M-12	7314150424382	1	485
TAH29M-13	7314150414437	1	485
TAH29M-14	7314150424399	1	485
TAH29M-15	7314150424405	1	485
TAH29M-16	7314150424412	1	485
TAH29M-17	7314150414444	1	485
TAH29M-18	7314150424429	1	485
TAH29M-19	7314150424436	1	485
TAH29M-20	7314150424443	1	485
TAH29M-21	7314150414451	1	485
TAH29M-22	7314150424450	1	485
TAH29M-23	7314150424467	1	485
TAH29M-24	7314150424474	1	485
TAH29M-25	7314150424481	1	485
TAH29M-26	7314150424498	1	485
TAH29M-27	7314150424504	1	485
TAH29M-28	7314150424511	1	485
TAH29M-29	7314150424528	1	485
TAH29M-30	7314150424535	1	485
TAH29M-32	7314150424542	1	485
TAH29M-6	7314150414376	1	485
TAH29M-7	7314150414383	1	485
TAH29M-8	7314150414390	1	485
TAH29M-9	7314150414406	1	485
TAH2M-10-11	7314150427772	1	484
TAH2M-12-13	7314150427789	1	484
TAH2M-14-15	7314150427796	1	484
TAH2M-16-17	7314150427802	1	484
TAH2M-18-19	7314150427819	1	484
TAH2M-6-7	7314150427758	1	484
TAH2M-8-9	7314150427765	1	484
TAH317	7314150319985	1	493
TAH320	7314150319992	1	493
TAH325	7314150320004	1	493
TAH3625PU-50	7314150307579	1	494
TAH3625W-35	7314150307609	1	495
TAH3640-250-C	7314150307975	1	496
TAH3681-11	7314150415038	1	496
TAH3681-16	7314150415045	1	496
TAH3681-20	7314150415052	1	496
TAH3683	7314150352258	1	496
TAH3734BM-10	7314150308057	1	496
TAH3734BM-2	7314150343348	1	496
TAH3734BM-3	7314150307982	1	496
TAH3734BM-4	7314150308019	1	496
TAH3734BM-5	7314150308026	1	496
TAH3734BM-6	7314150308033	1	496
TAH3734BM-8	7314150308040	1	496
TAH3739-300	7314150373925	1	496
TAH3755BM-4	7314150308064	1	496
TAH380-10	7314150307845	1	485
TAH380-14	7314150320172	1	485
TAH380-18	7314150307852	1	485
TAH380-24	7314150343317	1	485
TAH396-JT	7314150373932	1	493
TAH420SH-80-160	7314150411610	1	498
TAH466-250	7314150307791	1	497
TAH479-16	7314150307586	1	495
TAH479-32	7314150307593	1	495



TAH481-300	7314150307616	1	495
TAH484-1000	7314150373918	1	495
TAH484-1500	7314150307623	1	495
TAH484-2000	7314150319916	1	495
TAH485	7314150459902	1	495
TAH486F-700	7314150370658	1	495
TAH487-5200	7314150307630	1	495
TAH489-1100	7314150307647	1	495
TAH489-1800	7314150343294	1	495
TAH489-2700	7314150319923	1	495
TAH489-3600	7314150307654	1	495
TAH489-4500	7314150427567	1	495
TAH489-5400	7314150319930	1	495
TAH489-6300	7314150427581	1	495
TAH490-1100	7314150427475	1	495
TAH490-700	7314150427529	1	495
TAH490-900	7314150427536	1	495
TAH52	7314150339730	1	494
TAH6950	7314150309054	1	486
TAH6956-1	7314150309061	1	486
TAH6958B-1	7314150309078	1	485
TAH6960	7314150305315	1	486
TAH6961	7314150305322	1	486
TAH6962	7314150305339	1	486
TAH6962L	7314150305346	1	486
TAH6966	7314150305353	1	486
TAH6M-10-11	7314150370665	1	484
TAH6M-12-13	7314150370672	1	484
TAH6M-14-15	7314150400393	1	484
TAH6M-16-17	7314150400409	1	484
TAH6M-17-19	7314150370689	1	484
TAH6M-18-19	7314150400416	1	484
TAH6M-20-22	7314150400423	1	484
TAH6M-24-27	7314150400430	1	484
TAH6M-30-32	7314150400447	1	484
TAH6M-6-7	7314150427741	1	484
TAH6M-8-9	7314150400386	1	484
TAH700-1.5-50	7314150432301	1	490
TAH700-1.8-50	7314150432318	1	490
TAH700-2.5-50	7314150432325	1	490
TAH700-3-100	7314150432332	1	490
TAH701-0-50	7314150432349	1	490
TAH701-00-50	7314150432356	1	490
TAH703-10-50	7314150432288	1	490
TAH703-15-75	7314150432295	1	490
TAH703-6-50	7314150432240	1	490
TAH703-7-50	7314150432257	1	490
TAH703-8-50	7314150432264	1	490
TAH703-9-50	7314150432271	1	490
TAH73R-100	7314150503810	1	497
TAH73R-200	7314150503834	1	497
TAH73R-300	7314150503858	1	497
TAH7444SG-M-36	7314150308934	1	484
TAH7444SG-M-41	7314150308941	1	484
TAH7444SG-M-46	7314150308958	1	484
TAH7444SG-M-50	7314150308965	1	484
TAH7444SG-M-55	7314150308972	1	484
TAH7445-100A-1	7314150327546	1	497
TAH7452-2	7314150302543	1	498
TAH7455-300-1	7314150309412	1	498
TAH74W9-100	7314150519354	1	498
TAH782-U	7314150339747	1	494
TAH7852-1	7314150302550	1	498
TAH8069	7314150383603	1	483
TAH8069C	7314150383610	1	483
TAH8070	7314150347025	1	483
TAH8070C	7314150383627	1	483
TAH8071	7314150347032	1	483
TAH8071C	7314150383634	1	483
TAH8072	7314150307487	1	483
TAH8072C	7314150383641	1	483
TAH8073	7314150319831	1	483
TAH8073C	7314150383658	1	483
TAH8074	7314150319848	1	483
TAH8074C	7314150383665	1	483
TAH8075	7314150307500	1	483
TAH8075C	7314150383672	1	483
TAH8150-1/2	7314150309283	1	487
TAH8158B-1	7314150309290	1	487
TAH8160	7314150306367	1	487
TAH8162	7314150306374	1	487
TAH8166	7314150306381	1	487
TAH8224	7314150307951	1	492
TAH84-PODGER	7314150312221	1	483
TAH868700000	7314150374571	1	494
TAH8950N/A	7314150309382	1	488
TAH8953	7314150309399	1	488
TAH8961	7314150309405	1	488
TAH9045-B-250	7314150411634	1	497



TAH9048-250	7314150411627	1	497
TAH9070	7314150307517	1	483
TAH9072	7314150307524	1	483
TAHBE-8020L	7314150308101	1	488
TAHBE-8030	7314150308118	1	488
TAHBE-8040	7314150308125	1	488
TAHBE-8040S	7314150308132	1	489
TAHBE-8050S	7314150308149	1	489
TAHBE-8155	7314150308156	1	488
TAHBE-8220S	7314150308163	1	489
TAHBE-8241	7314150308217	1	488
TAHBE-8252	7314150308224	1	488
TAHBE-8255S	7314150320226	1	489
TAHBE-8257	7314150308231	1	488
TAHBE-8258	7314150308248	1	488
TAHBE-8260	7314150308255	1	489
TAHBE-8350	7314150308262	1	489
TAHBE-8602	7314150308279	1	489
TAHBE-8610	7314150308286	1	489
TAHBE-8610S	7314150308293	1	490
TAHBE-8611	7314150308309	1	489
TAHBE-8620	7314150308316	1	489
TAHBE-8620L	7314150308323	1	489
TAHBE-8620S	7314150308330	1	490
TAHBE-8623	7314150308347	1	489
TAHBE-8624	7314150308354	1	489
TAHBE-8630	7314150308361	1	489
TAHBE-8630S	7314150320233	1	490
TAHBE-8640S	7314150320240	1	490
TAHBE-8810	7314150308378	1	489
TAHBE-8820	7314150308385	1	489
TAHBE-8820SL	7314150347827	1	490
TAHBE-8830	7314150308392	1	489
TAHBE-8880	7314150432196	1	489
TAHBE-8910	7314150343713	1	489
TAHBE-8910S	7314150343799	1	490
TAHBE-8915	7314150343744	1	489
TAHBE-8915S	7314150343805	1	490
TAHBE-8920	7314150343751	1	489
TAHBE-8920S	7314150343812	1	490
TAHBE-8925	7314150343768	1	489
TAHBE-8925S	7314150343829	1	490
TAHBE-8930	7314150343775	1	489
TAHBE-8930S	7314150343836	1	490
TAHBE-9776	7314150432233	1	490
TAHBE-9777B	7314150307685	1	491
TAHBE-9787	7314150307692	1	491
TAHBE64520	7314150307821	1	499
TAHBFRL11	7314150307739	1	499
TAHBOD5400	7314150339457	1	499
TAHBOD5450	7314150339464	1	499
TAHCRW01	7314150432370	1	492
TAHCS300	7314150411603	1	497
TAHLTS-30	7314150432387	1	496
TAHMK5	7314150411580	1	485
TAHPINRELEASER	7314150307838	1	488
TAHSC2RM-13-17	7314150339792	1	485
TAHSC2RM-15-17	7314150339785	1	485
TAHSC2RM-19-22	7314150339761	1	485
TAHSC2RM-27-30	7314150339778	1	485
TAHSCB140G	7314150308071	1	494
TAHSR300-MM	7314150415021	1	497
TAHWBB600	7314150440429	1	496
TAHWBB700	7314150440436	1	496
TAM12135	7314150215331	1	117
TAM12200	7314150215348	1	117
TAM12340	7314150215355	1	117
TAM1430	7314150215317	1	117
TAM38135	7314150215324	1	117
TAS14H007	7314150423187	1	113
TAS14H09	7314150423200	1	113
TAS14S007	7314150423194	1	113
TAS14S09	7314150423217	1	113
TASMB14H007	7314150489664	1	113
TASMB14H09	7314150489671	1	113
TAW12340	7314150274963	1	107
TAW1412M	7314150423156	1	107
TAW1430M	7314150422289	1	107
TAW14340	7314150340842	1	107
TAW24800	7314150368297	1	107
TAW34800	7314150285471	1	107
TAW38135	7314150274956	1	107
TAW38135M	7314150502295	1	107
TAW912M	7314150423163	1	107
TAW9135	7314150340859	1	107
TAW9135M	7314150502288	1	107
TAW930M	7314150422319	1	107
TAWM12340	7314150274925	1	106
TAWM1412M	7314150423149	1	106



TAWM1430M	7314150422265	1	106
TAWM14340	7314150340835	1	106
TAWM24800	7314150368280	1	106
TAWM34800	7314150274932	1	106
TAWM38135	7314150274918	1	106
TAWM38135M	7314150502264	1	106
TAWM912M	7314150423132	1	106
TAWM9135	7314150340828	1	106
TAWM9135M	7314150502271	1	106
TAWM930M	7314150422241	1	106
TAWMB14340	7314150489626	1	106
TAWMB24650	7314150490103	1	106
TAWMB24800	7314150489633	1	106
TAWMB9135M	7314150490110	1	106
TAWMB930M	7314150489640	1	106
TEA003	7314150422180	1	116
TEA010	7314150422197	1	116
TEA030	7314150465781	1	116
TEA065	7314150472246	1	116
TEA1100	7314150423170	1	116
TEA2100	7314150465972	1	116
TEA350	7314150422210	1	116
TJS003	7314150522477	1	116
TJS010	7314150522484	1	116
TJS030	7314150522491	1	116
TR0325M03X-50	7314150501632	5	148
TR0636M06X-65	7314150501663	5	148
TR0650M06X-80	7314150501694	5	148
TR0860M08X-110	7314150507269	5	148
TR4.530M06X-90	7314150501755	5	148
TSS120	7314150347063	1	114
TSS600	7314150346414	1	114
W-S-1.5	7311518140816	4	616
W-S-2.0	7311518140823	4	616
W-S-2.5	7311518140830	4	616
W-T-2.0	7311518140847	4	616
WBB1000	7314150431502	4	626
WBB1200	7314150431519	4	626
WBB1500	7314150431526	1	626
WBB400	7314150315215	10	626
WBB500	7314150315222	10	626
WBB600	7314150315239	10	626
WBB700	7314150315246	6	626
WBB800	7314150340972	6	626
WBF380	7314150315253	12	626
WBMF190	7314150315260	24	627
WBMF190IP	7314150457960	15	627
WBP-3P-30MF	7314150444335	1	627
WBP-3P-963	7314150444328	1	627
WBP300	7314150315161	20	626
WBP500	7314150315178	12	626
WBP625	7314150315185	12	626
WBP710	7314150315192	10	626
WBP900	7314150315208	6	626
WC-HOL	7314150333158	1	587
WPH 2-50	7314150520428	1	623
WPH 3-20	8412814125435	1	623
WPH 3-30	8412814125442	1	623
WR1	7314150167425	50	557
WR1-MM	7314150220069	50	557
WR2	7314150167432	25	557
WR2-12	7314150185627	25	557
WR2-MM	7314150220038	25	557
XLARGE	7314150437412	1	435
XXL	7314150504152	1	434
ZHVIDEOBAT	8414909180244	1	362
ZHVIDEOCHA	8414909180237	1	362



Contact Us

Argentina

A.M. de Justo 1750 3° A
C1107AFJ - Capital Federal
Buenos Aires
Tel: +54 (11) 4313-1004
Fax: +54 (11) 4893-3553

Australia

3 Cooper Street, Smithfield,
NSW 2164
Tel: +61 (0) 2 8787 5700
Fax: +61 (0) 2 9756 6130

Беларусь

ЗАО "Эс-Эн-Эй Европа Индастриз Бисов"
220075 СЭЗ "Минск"
ул. Селицкого, д. 8А
Телефон +375 (17) 389 79 50
info.by@snaeurope.com

Belgium

Branch of SNA Europe (Benelux) BV
De Kleetlaan 12A Pegasus Park
1831 DIEGEM
Tel: +32 (0)2 726 03 03
info.be@bahco.com

Chile

Av. Americo Vesputio 2760-D
Conchali - Santiago - Chile
Tel: + 56 2 623 0203
Fax: + 56 2 623 5395

Česká republika

SNA Europe s.r.o.
Holadnská 2/4
639 00 Brno
Tel: +420 537 022 520
Fax: +420 537 022 200

Danmark

Vallensbækvej 40,
2605 Brøndby
Tel: +45 4363 0330
Fax: +45 4396 2456

Deutschland

Willetstraße 10
40822 Mettmann
Tel: +49 (0) 2104 833 83 0
Fax: +49 (0) 2104 833 83 7999

España

c/ Hilanderas, 1
(P.O. Box / Ardo de Correos nº 5)
C.P. 20303 Irún
Tel: +34 902 235 100 / +34 943 649 111
Fax: +34 943 649 120

Ελλάδα

Λ. Βουλιαγμένης 604Γ
167 77 Ελληνικό, Αθήνα
Τηλ: +30 210 9914263
Fax: +30 210 9914587

Export

Antigua Carretera de Altube Km 5,5
P.O.Box 307
01080 VITORIA (Spain)
Tel: +34 945269711
Fax: +34 945165040

France

ZAC de l'Hoirie
20 rue Charles Lacretelle
CS 60101
49072 Beaucouzé cedex
Tél: +33 (0) 2 41 22 98 40
Fax: +33 (0) 2 41 22 98 50

Italia

SNA EUROPE Italia S.p.A.
Via Georges Bizet, 13/15
20092 Cinisello Balsamo MI - Italia
Tel. +39 02 3024161
info.it@snaeurope.com

Казахстан

050000, Алматы,
ул.Шевченко 1656/72г, оф.217
Тел/факс +7 727323 63 39

Nederland

Vossenbeemd 113
5705 CL Helmond
Tel: +31 (0) 492 58 23 82
info.nl@bahco.com

New Zealand

Unit 3/25 Highbrook Drive
East Tamaki
Auckland
Tel: +64 9-273 46 50
Fax: +64-9-273-2453

Norge

Box 800
1306 Sandvika
Tel: +47 40 49 66 00
Fax: +47 67 17 56 51

Österreich

Vienna, Nineteen, Mooslackengasse 17
A - 1190 Wien
Tel: +49 (0) 2104 8 33 83 0
Fax +49 (0) 2104 833 83 79 99

Polska

ul. Marynarska 15
02-674 Warszawa
Tel.: +48 (0) 22 6070510
Fax: +48 (0) 22 6070521

Россия

000 "Эс-Эн-Эй Юроп (РУС)"
141407 г. Химки
ул. Панфилова вл.21, стр.1
Телефон +7 (495) 221 58 51
info.ru@snaeurope.com

Portugal

SNA Europe [Industries] LDA
R. Maria Julia M. Ramos - Junqueira
4480-254 Vila Do Conde
Tel. +351 252 650 131
Fax. +351 252 650 160

Slovenská republika

SNA Europe s.r.o.
Karadžičova 8/A
821 08 Bratislava
Tel: +421 (0)2 5939 6124
Fax: +421 (0)2 5939 6217

SRBIJA

Vermax-alati doo
Ul. Drage Spasić 35
11000 Beograd
Tel: +381 11 2360 500
Tel: +381 11 2360 900
Fax: +381 11 2361 147
e-mail: office@vermax.rs

Suomi

SNA Europe Oy
PL 6580
00002 Helsinki
Finland
Tel: +358 207 433 510
Fax: +358 207 433 525

Sverige

SNA Europe Industries AB
Box 83
SE-745 22 Enköping
Tel: +46 (0) 171-47 82 00
Fax: +46 (0) 171-47 82 38

Schweiz / Suisse

Willetstraße 10
40822 Mettmann
Tel: +49 (0) 2104 833 83 0
Fax: +49 (0) 2104 833 83 7999

Türkiye

Girne Mah. Maltepe Küçük San. Sitesi
F Blok No:19 Maltepe
Istanbul
Tel: +90 (0) 216 367 10 21
Fax: +90 (0) 216 367 11 71

Украина

«Бахко Бисов Свенска Акциеболаг»
SNA Europe [Ukraine & Moldova]
Телефон +38 067 441 16 09
офис 555, улица Армянская, 6А
Киев, Украина

United Kingdom

Moorhead Way, Bramley,
Rotherham, South Yorkshire S66 1YY
Tel: +44 (0) 1709 731731
Fax: +44 (0) 1709 731741



Warranty

For warranty info please check your local website www.bahco.com



This catalogue comprises our current product assortment. Changes in the assortment as well as change of net shapes, forms, designs and designations are made continuously. No specific information will necessarily be issued to this effect.

Illustrations and drawings have been reproduced to be as accurate as possible. For the purposes of a catalogue they may, however, differ from the products themselves, as may the technical specifications.

Indications of weight are to be understood as approximate net weights, and serve primarily to facilitate calculations of freight and postage charges.

This catalogue supersedes all previous specifications and assortment lists.

The intellectual property in this catalogue is the property of SNA Europe. Excerpts, reprints or copies of the contents may be made with our permission

2023



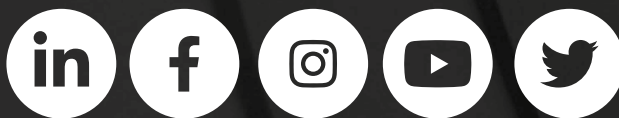
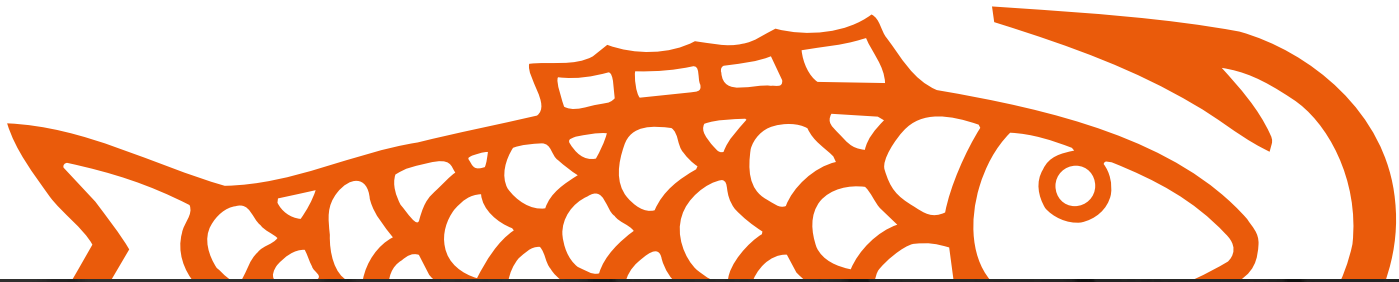

www.bahco.com

M-ENG-CAT-23



7 314150 534876 >