

**K**

K100	748
K101	748
K102	749
K103	749
K104	750
K200	751
K201	751
K202	751
K203	751
K204	751
K300	745
K301	745
K302	745
K303	745
K304	745
K305	745
K310	746
K311	746
K312	746
K313	746
K314	746
K330	747
K331	747
K332	747
K333	747
K334	747
K520	752
K521	753
K522	754
K540	755
K541	756
K542	756

**M**

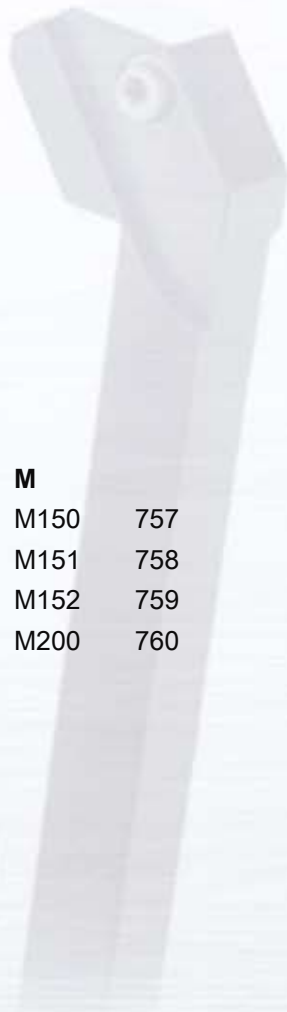









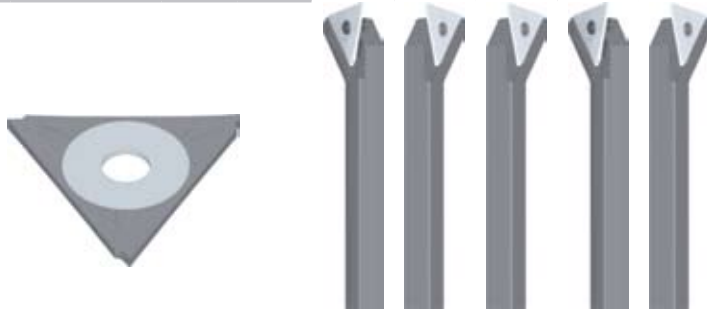

M150	757
M151	758
M152	759
M200	760



























741 - 760





	K330	K331	K332	K333	K334	K100	K101	K102	K103	K104	K200	K201	K202	K203	K204
	HSCo	HSCo	HSCo	HSCo	HSCo										
															
	TIAN	TIAN	TIAN	TIAN	TIAN										
	D	D	D	D	D	D	D	D	D	D					
	0°	8°R	8°L	15°R	15°L										
															
															
	23.00 - 40.00	23.00 - 40.00	23.00 - 40.00	23.00 - 40.00	23.00 - 40.00	10.00 - 20.00	12.00 - 20.00	10.00 - 14.00	16.00 - 32.00	16.00 - 32.00	1.50	1.50	1.50	2.50	2.50
	747	747	747	747	747	748	748	749	749	750	751	751	751	751	751
1.1	■120A	■120A	■120A	■120A	■120A										
1.2	■100B	■100B	■100B	■100B	■100B										
1.3	■60C	■60C	■60C	■60C	■60C										
1.4	●50D	●50D	●50D	●50D	●50D										
1.5	●20E	●20E	●20E	●20E	●20E										
1.6															
1.7															
1.8															
2.1	■20C	■20C	■20C	■20C	■20C										
2.2	■20C	■20C	■20C	■20C	■20C										
2.3	●10B	●10B	●10B	●10B	●10B										
2.4															
3.1															
3.2															
3.3															
3.4	A	0,20	0,25												
4.1	B	0,15	0,20												
4.2	C	0,10	0,15												
4.3	D	0,05	0,10												
5.1	E	0,03	0,05												
5.2															
5.3															
6.1	■250B	■250B	■250B	■250B	■250B										
6.2	■160C	■160C	■160C	■160C	■160C										
6.3	■250B	■250B	■250B	■250B	■250B										
6.4															
7.1	■370A	■370A	■370A	■370A	■370A										
7.2	■370B	■370B	■370B	■370B	■370B										
7.3	■110C	■110C	■110C	■110C	■110C										
7.4	●45D	●45D	●45D	●45D	●45D										
8.1															
8.2															
8.3															
9.1															
10.1															



	K520	K521	K522	K540	K541	K542	M150	M151	M152	M200
	HSCo	HSCo	HSCo	HSCo	HSCo	HSCo				
										
										
	DIN 4964B	DIN 4964A	DIN 4964D	DIN 4964E	DIN 4964E	DIN 4964E				
										
	h13	h9	h13							
	4.00 - 1"	3 - 20 3/16 - 1/2	8 - 25 1/2 - 3/4	12.00 - 25.00	12.00 - 25.00	16.00 - 20.00	10 - 65	10 - 65	No.0 - No.6	0.25Ltr - 0.50Ltr
	752	753	754	755	756	756	757	758	759	760
1.1	■80A	■80A	■80A	■80A	■80A	■80A				
1.2	■80A	■80A	■80A	■80A	■80A	■80A				
1.3	■65A	■65A	■65A	■65A	■65A	■65A				
1.4	■55A	■55A	■55A	■55A	■55A	■55A				
1.5	●35A	●35A	●35A	●35A	●35A	●35A				
1.6										
1.7										
1.8										
2.1	●37A	●37A	●37A	●37A	●37A	●37A				
2.2	●30A	●30A	●30A	●30A	●30A	●30A				
2.3										
2.4										
3.1	■60A	■60A	■60A	■60A	■60A	■60A				
3.2	■50A	■50A	■50A	■50A	■50A	■50A				
3.3	■40A	■40A	■40A	■40A	■40A	■40A				
3.4	■25A	■25A	■25A	■25A	■25A	■25A				
4.1										
4.2										
4.3										
5.1										
5.2										
5.3										
6.1	■100A	■100A	■100A	■100A	■100A	■100A				
6.2	■65A	■65A	■65A	■65A	■65A	■65A				
6.3	■100A	■100A	■100A	■100A	■100A	■100A				
6.4	●50A	●50A	●50A	●50A	●50A	●50A				
7.1	●120A	●120A	●120A	●120A	●120A	●120A				
7.2	●150A	●150A	●150A	●150A	●150A	●150A				
7.3										
7.4										
8.1										
8.2										
8.3										
9.1										
10.1										

# K300 - K305



- Destička upichovací
- Leszúró váltólapka
- Plytki odcinajace
- Placute debitare
- Отрезные пластины
- ploščica

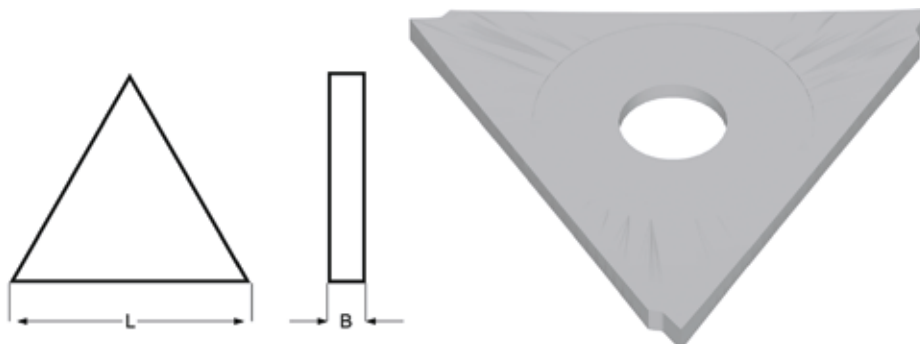

## K300



- 1.1 1.2 6.2 6.3
- 1.3 1.4 2.1 6.1 7.1 7.2

L	A	e-Code
23	1.50	K30023.0X1.5
40	2.50	K30040.0X2.5

## K301



- 1.1 1.2 6.2 6.3
- 1.3 1.4 2.1 6.1 7.1 7.2

L	A	e-Code
23	1.50	K30123.0X1.5
40	2.50	K30140.0X2.5

## K302



- 1.1 1.2 6.2 6.3
- 1.3 1.4 2.1 6.1 7.1 7.2

L	A	e-Code
23	1.50	K30223.0X1.5
40	2.50	K30240.0X2.5

## K303



- 1.1 1.2 6.2 6.3
- 1.3 1.4 2.1 6.1 7.1 7.2

L	A	e-Code
23	1.50	K30323.0X1.5
40	2.50	K30340.0X2.5

## K304



- 1.1 1.2 6.2 6.3
- 1.3 1.4 2.1 6.1 7.1 7.2

L	A	e-Code
23	1.50	K30423.0X1.5
40	2.50	K30440.0X2.5

## K305



- 1.1 1.2 6.2 6.3
- 1.3 1.4 2.1 6.1 7.1 7.2

L	A	d min-max mm	e-Code
23	1.10	9 - 17	K30523.0X1.1
23	1.30	18 - 26	K30523.0X1.3
23	1.60	28 - 35	K30523.0X1.6
40	1.85	36 - 48	K30540.0X1.85
40	2.15	50 - 63	K30540.0X2.15

- Destička upichovací
- Leszúró váltólapka
- Plytki odcinajace
- Placute debitare
- Отрезные пластины
- ploščica

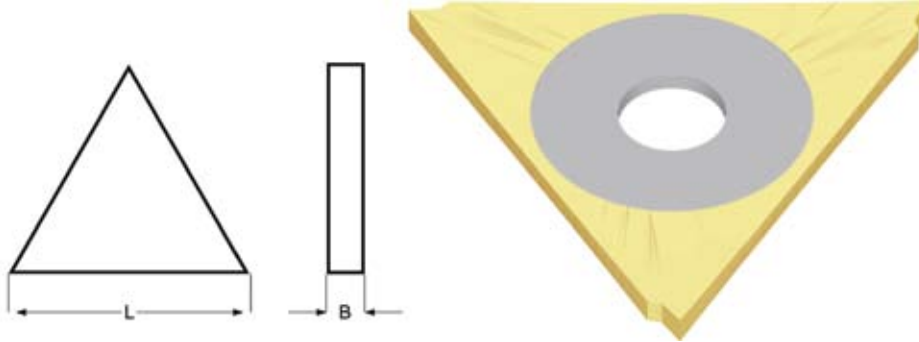

## K310



- 1.1 1.2 1.3 2.1 2.2 6.1 6.2 6.3 7.1  
7.2 7.3
- 1.4 1.5 2.3 7.4

L	A	e-Code
23	1.50	K31023.0X1.5
40	2.50	K31040.0X2.5

## K311



- 1.1 1.2 1.3 2.1 2.2 6.1 6.2 6.3 7.1  
7.2 7.3
- 1.4 1.5 2.3 7.4

L	A	e-Code
23	1.50	K31123.0X1.5
40	2.50	K31140.0X2.5

## K312



- 1.1 1.2 1.3 2.1 2.2 6.1 6.2 6.3 7.1  
7.2 7.3
- 1.4 1.5 2.3 7.4

L	A	e-Code
23	1.50	K31223.0X1.5
40	2.50	K31240.0X2.5

## K313



- 1.1 1.2 1.3 2.1 2.2 6.1 6.2 6.3 7.1  
7.2 7.3
- 1.4 1.5 2.3 7.4

L	A	e-Code
23	1.50	K31323.0X1.5
40	2.50	K31340.0X2.5

## K314



- 1.1 1.2 1.3 2.1 2.2 6.1 6.2 6.3 7.1  
7.2 7.3
- 1.4 1.5 2.3 7.4

L	A	e-Code
23	1.50	K31423.0X1.5
40	2.50	K31440.0X2.5

# K330 - K334



- Destička upichovací
- Leszúró váltólapka
- Plytki odcinajace
- Placute debitare
- Отрезные пластины
- ploščica

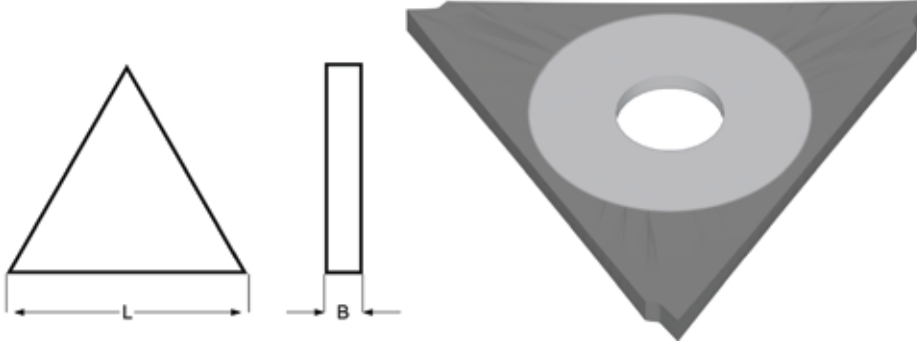

## K330



- 1.1 1.2 1.3 2.1 2.2 6.1 6.2 6.3 7.1  
7.2 7.3
- 1.4 1.5 2.3 7.4

L	A	e-Code
23	1.50	K33023.0X1.5
40	2.50	K33040.0X2.5

## K331



- 1.1 1.2 1.3 2.1 2.2 6.1 6.2 6.3 7.1  
7.2 7.3
- 1.4 1.5 2.3 7.4

L	A	e-Code
23	1.50	K33123.0X1.5
40	2.50	K33140.0X2.5

## K332



- 1.1 1.2 1.3 2.1 2.2 6.1 6.2 6.3 7.1  
7.2 7.3
- 1.4 1.5 2.3 7.4

L	A	e-Code
23	1.50	K33223.0X1.5
40	2.50	K33240.0X2.5

## K333



- 1.1 1.2 1.3 2.1 2.2 6.1 6.2 6.3 7.1  
7.2 7.3
- 1.4 1.5 2.3 7.4

L	A	e-Code
23	1.50	K33323.0X1.5
40	2.50	K33340.0X2.5

## K334



- 1.1 1.2 1.3 2.1 2.2 6.1 6.2 6.3 7.1  
7.2 7.3
- 1.4 1.5 2.3 7.4

L	A	e-Code
23	1.50	K33423.0X1.5
40	2.50	K33440.0X2.5



- Držák na upichovací destičku
- Leszúrókés
- Uchwyty do płytek odcinających
- Cutite debitare (portplacute)
- Отрезные державки
- drżalo płościc

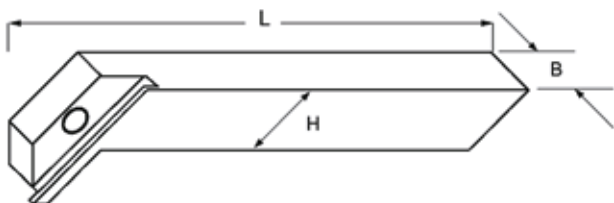

## K100



H	A	L	e-Code
10	10	125	K10010.0
12	12	125	K10012.0

H	A	L	e-Code
16	12	125	K10016.0
20	12	125	K10020.0

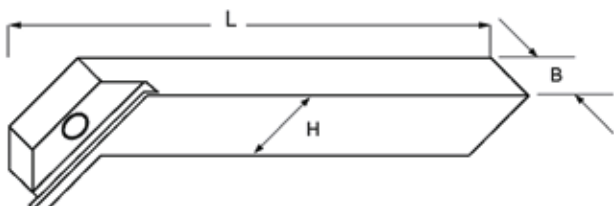

## K101



H	A	L	e-Code
12	12	125	K10112.0
16	12	125	K10116.0

H	A	L	e-Code
20	12	125	K10120.0

# K102 / K103



- Držák na upichovací destičku
- Leszúrókés
- Uchwyty do płytek odcinających
- Cutite debitare (portplacute)
- Отрезные державки
- drżalo ploščic

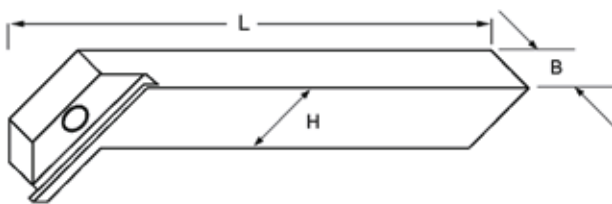

## K102



H	A	L	e-Code
10	10	125	K10210.0
14	12	125	K10214.0

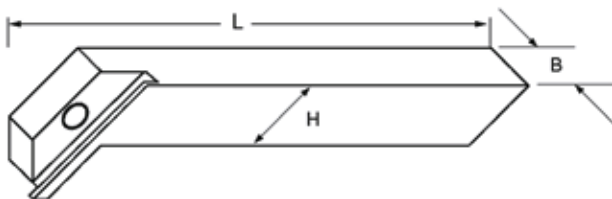

## K103



H	A	L	e-Code
16	16	140	K10316.0
25	16	140	K10325.0

H	A	L	e-Code
32	16	140	K10332.0



- Držák na upichovací destičku
- Leszúrókés
- Uchwyty do plytek odcinających
- Cutite debitare (portplacute)
- Отрезные державки
- drżalo płościc

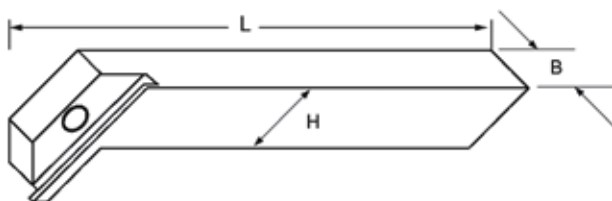

## K104



H	A	L	e-Code
16	16	140	K10416.0
25	16	140	K10425.0

H	A	L	e-Code
32	16	140	K10432.0

# K200 - K204



- Náhradní díly pro upichovací nástroje
- Alkatrészek a leszűrő szerszámokhoz
- Części zamienne dla uchwytów do płytek odcinających
- Piese de schimb pentru scule debitare/retezare
- Оправка для Отрезные державки
- držalo ploščic- rezervni del

## K200

size	tool code	e-Code
1.5	Excentric	K200ECC1.5

## K201

size	tool code	e-Code
1.5	Spanner	K201SPAN1.5

## K202

size	tool code	e-Code
2.5	12.0	K2022.5X12.0

## K203

size	tool code	e-Code
2.5	Excentric	K203ECC2.5

## K204

size	tool code	e-Code
2.5	Spanner	K204SPAN2.5



- Polotovary
- Betétkés
- Pólprodukt
- Cutite strung HSCo
- Заготовки для резцов из быстрорежущей стали
- nož stružni

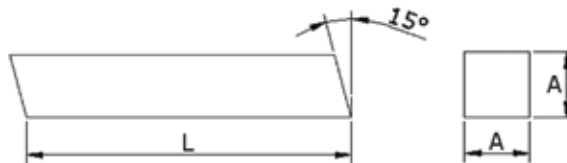

## K520



- 1.1
- 1.2
- 1.3
- 1.4
- 3.1
- 3.2
- 3.3
- 3.4
- 6.1
- 6.2
- 6.3
- 1.5
- 2.1
- 2.2
- 6.4
- 7.1
- 7.2

A	L	e-Code	A	L	e-Code
4	63	K5204.0X63.0	16	100	K52016.0X100.0
4	100	K5204.0X100.0	16	160	K52016.0X160.0
5	63	K5205.0X63.0	16	200	K52016.0X200.0
5	160	K5205.0X160.0	18	200	K52018.0X200.0
6	63	K5206.0X63.0	20	160	K52020.0X160.0
6	100	K5206.0X100.0	20	200	K52020.0X200.0
6	160	K5206.0X160.0	25	200	K52025.0X200.0
6	200	K5206.0X200.0	3/16	2.1/2	K5203/16X2.1/2
7	200	K5207.0X200.0	3/16	4"	K5203/16X4
8	63	K5208.0X63.0	1/4	2.1/2	K5201/4X2.1/2
8	100	K5208.0X100.0	1/4	4"	K5201/4X4
8	160	K5208.0X160.0	5/16	2.1/2	K5205/16X2.1/2
8	200	K5208.0X200.0	5/16	3"	K5205/16X3
10	63	K52010.0X63.0	5/16	4"	K5205/16X4
10	100	K52010.0X100.0	3/8	3"	K5203/8X3
10	125	K52010.0X125.0	3/8	4"	K5203/8X4
10	160	K52010.0X160.0	3/8	6"	K5203/8X6
10	200	K52010.0X200.0	7/16	3.1/2	K5207/16X3.1/2
12	100	K52012.0X100.0	1/2	4"	K5201/2X4
12	160	K52012.0X160.0	1/2	6"	K5201/2X6
12	200	K52012.0X200.0	5/8	4.1/2	K5205/8X4.1/2
14	100	K52014.0X100.0	5/8	6"	K5205/8X6
14	160	K52014.0X160.0	3/4	5"	K5203/4X5
14	200	K52014.0X200.0	1"	8"	K5201X8

# K521

**DORMER**

- Polotovary
- Betétkés
- Póiprodukt
- Cutite strung HSCo
- Заготовки для резцов из быстрорежущей стали
- nož stružni

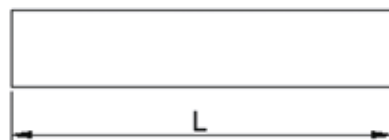

## K521

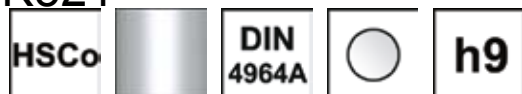

- 1.1 1.2 1.3 1.4 3.1 3.2 3.3 3.4 6.1 6.2 6.3
- 1.5 2.1 2.2 6.4 7.1 7.2

A	L	e-Code	A	L	e-Code
3	100	K5213.0X100.0	12	200	K52112.0X200.0
4	80	K5214.0X80.0	14	100	K52114.0X100.0
4	100	K5214.0X100.0	14	200	K52114.0X200.0
5	100	K5215.0X100.0	15	100	K52115.0X100.0
5	160	K5215.0X160.0	16	100	K52116.0X100.0
6	100	K5216.0X100.0	16	160	K52116.0X160.0
6	160	K5216.0X160.0	16	200	K52116.0X200.0
6	200	K5216.0X200.0	18	160	K52118.0X160.0
8	100	K5218.0X100.0	18	200	K52118.0X200.0
8	160	K5218.0X160.0	20	200	K52120.0X200.0
8	200	K5218.0X200.0	3/16	4"	K5213/16X4
10	100	K52110.0X100.0	1/4	4"	K5211/4X4
10	160	K52110.0X160.0	5/16	4"	K5215/16X4
10	200	K52110.0X200.0	3/8	4"	K5213/8X4
12	100	K52112.0X100.0	1/2	4"	K5211/2X4
12	160	K52112.0X160.0	1/2	6"	K5211/2X6

- Polotovary
- Betétkés
- Pólprodukt
- Cutite strung HSCo
- Заготовки для резцов из быстрорежущей стали
- nož stružni

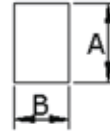
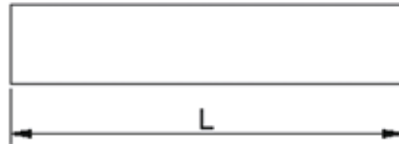

## K522



- 1.1
- 1.2
- 1.3
- 1.4
- 3.1
- 3.2
- 3.3
- 3.4
- 6.1
- 6.2
- 6.3
- 1.5
- 2.1
- 2.2
- 6.4
- 7.1
- 7.2

A	B	L	e-Code
10	3	200	K52210.0X3.0X200.0
12	3	90	K52212.0X3.0X90.0
12	3	200	K52212.0X3.0X200.0
20	3	200	K52220.0X3.0X200.0
10	4	100	K52210.0X4.0X100.0
10	4	120 (a)	K52210.0X4.0X120.0
10	4	200	K52210.0X4.0X200.0
12	4	200	K52212.0X4.0X200.0
16	4	160	K52216.0X4.0X160.0
16	4	200	K52216.0X4.0X200.0
20	4	200	K52220.0X4.0X200.0
12	5	90	K52212.0X5.0X90.0
12	5	200	K52212.0X5.0X200.0
18	5	200	K52218.0X5.0X200.0
20	5	200	K52220.0X5.0X200.0
8	6	70	K5228.0X6.0X70.0
10	6	200	K52210.0X6.0X200.0
12	6	200	K52212.0X6.0X200.0
14	6	140 (b+d)	K52214.0X6.0X140.0
16	6	200	K52216.0X6.0X200.0
18	6	140 (c)	K52218.0X6.0X140.0
20	6	200	K52220.0X6.0X200.0

A	B	L	e-Code
25	6	200	K52225.0X6.0X200.0
12	8	160	K52212.0X8.0X160.0
12	8	200	K52212.0X8.0X200.0
16	8	140 (d)	K52216.0X8.0X140.0
16	8	200	K52216.0X8.0X200.0
20	8	200	K52220.0X8.0X200.0
12	10	200	K52212.0X10.0X200.0
16	10	160	K52216.0X10.0X160.0
16	10	200	K52216.0X10.0X200.0
20	10	200	K52220.0X10.0X200.0
25	10	200	K52225.0X10.0X200.0
16	12	200	K52216.0X12.0X200.0
20	12	200	K52220.0X12.0X200.0
25	12	200	K52225.0X12.0X200.0
20	16	200	K52220.0X16.0X200.0
25	16	200	K52225.0X16.0X200.0
1/2	1/4	4	K5221/2X1/4X4
1/2	3/8	4	K5221/2X3/8X4
3/4	1/2	5	K5223/4X1/2X5
3/4	1/2	6	K5223/4X1/2X6
5/8	3/8	6	K5225/8X3/8X6

# K540

**DORMER**

- Polotovary
- Betétkés, oldalban és hosszban köszörült
- Nóz oprawkowy
- Blăncuri de scule, Unghi de asezare lateral si frontal
- Заготовки для резцов из быстрорежущей стали, с задними углами
- noř stružni

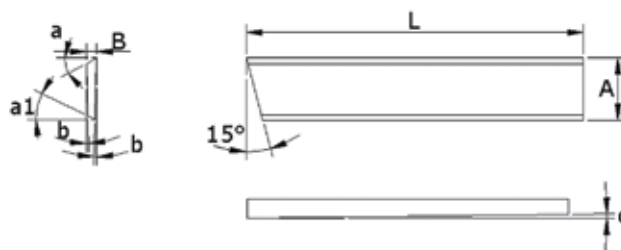

## K540

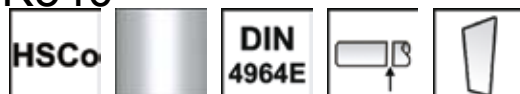

- 1.1 1.2 1.3 1.4 3.1 3.2 3.3 3.4 6.1 6.2 6.3
- 1.5 2.1 2.2 6.4 7.1 7.2

A	B	L	a	a1	b	c	e-Code
12.0	3.0	90	15.00°	15.00°	2.00°	0.5°	K54012.0X3.0X90.0
16.0	3.0	110	10.00°	10.00°	1.17°	0.5°	K54016.0X3.0X110.0
20.0	3.5	125	10.57°	13.43°	1.43°	0.5°	K54020.0X3.5X125.0
25.0	4.5	150	10.83°	13.17°	1.17°	0.44°	K54025.0X4.5X150.0

- Polotovary
- Betétkés, oldalban köszörült
- Nóż oprawkowy boczny
- Blancuri de scule, Unghi de asezare lateral
- Заготовки для резцов из быстрорежущей стали, с задним углом
- nož stružni

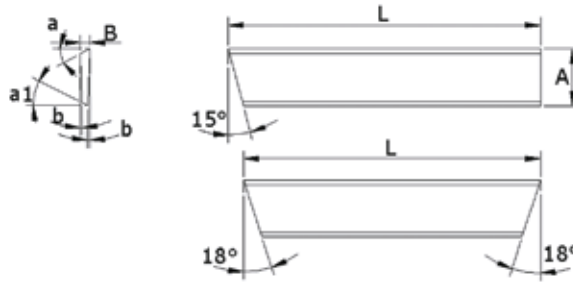

## K541



- 1.1 1.2 1.3 1.4 3.1 3.2 3.3 3.4 6.1 6.2 6.3
- 1.5 2.1 2.2 6.4 7.1 7.2

A	B	L	a	a1	b	e-Code
12.0	3.0	90	15.00°	15.00°	2.00°	K54112.0X3.0X90.0
12.0	3.0	120	15.00°	15.00°	2.00°	K54112.0X3.0X120.0
16.0	4.0	140	15.00°	15.00°	2.00°	K54116.0X4.0X140.0
18.0	4.0	140	15.00°	15.00°	2.00°	K54118.0X4.0X140.0
20.0	3.0	125	10.57°	13.43°	1.43°	K54120.0X3.0X125.0
25.0	4.0	150	10.83°	13.17°	1.17°	K54125.0X4.0X150.0

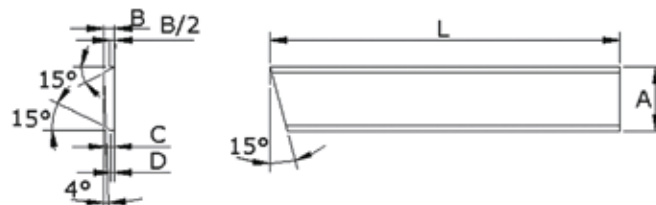

## K542



- 1.1 1.2 1.3 1.4 3.1 3.2 3.3 3.4 6.1 6.2 6.3
- 1.5 2.1 2.2 6.4 7.1 7.2

A	A	L	C	D	e-Code
16	3	140	1.9	0.6	K54216.0X3.0X140.0
20	4	140	2.6	0.6	K54220.0X4.0X140.0

# M150

**DORMER**

- Redukce tvrzená
- Kúpátalakító, Olajos használatra
- Tulejka mocujaca
- Reductii Morse imbunatatite in ulei
- Переходные втулки с конусом Морзе
- puša reducirna



## M150

K=Ext. (externí) K1=Int. (interní) / K=Külső Morse-kúp K1=Belső Morse-kúp / K=Zew.(Zewnetrzny stożek Morse'a)  
K1=Wew.(Wewnetrzny stożek Morse'a) / K=Ext. (extern) K1=Int. (intern) / K=Внеш. K1=Внутр. / K=zunanji K1=notranji.



Nr.	K = Nr.	K1 = Nr.	e-Code
10	1	0	M1501-0
21	2	1	M1502-1
31	3	1	M1503-1
41	4	1	M1504-1
32	3	2	M1503-2
42	4	2	M1504-2

Nr.	K = Nr.	K1 = Nr.	e-Code
52	5	2	M1505-2
43	4	3	M1504-3
53	5	3	M1505-3
54	5	4	M1505-4
65	6	5	M1506-5

- Redukce kalená a broušená
- Kúpátalakító, Edzett és Köszörült
- Tulejka mocujaca hartowana i odpuszczana
- Reductii Morse Calite si rectificata
- Шлифованные переходные втулки с конусом Морзе
- puša reducirana, kaljena in brušena



## M151

K=Ext. (externí) K1=Int. (interní) / K=Külső Morse-kúp K1=Belső Morse-kúp / K=Zew.(Zewnetrzny stożek Morse'a)  
 K1=Wew.(Wewnetrzny stożek Morse'a) / K=Ext. (extern) K1=Int. (intern) / K=Внеш. K1=Внутр. / K=zunanji K1=notranji.



Nr.	K = Nr.	K1 = Nr.	e-Code
10	1	0	M1511-0
21	2	1	M1512-1
31	3	1	M1513-1
41	4	1	M1514-1
32	3	2	M1513-2
42	4	2	M1514-2

Nr.	K = Nr.	K1 = Nr.	e-Code
52	5	2	M1515-2
43	4	3	M1514-3
53	5	3	M1515-3
54	5	4	M1515-4
65	6	5	M1516-5

# M152

**DORMER**

- Vyrážecí klín
- Morse Kiütőlap
- Klíny do wybijania wiertel
- Pana extractoare
- Клин для раскрепления сверл с конусом Морзе
- izbijalo



## M152



Nr.	e-Code
0	M1520
1 + 2	M15212
3 + 4	M15234
4 + 5	M15245

Nr.	e-Code
6	M1526

- Řezný olej
- Ulei de aschiere
- Vágóolaj
- Смазочно-охлаждающая жидкость
- Olej chłodząco-smarujący
- olje rezilno



## M200

A	e-Code
1/4 Ltr. 12x	M2000.25NR.1BLUE
1/4 Ltr. 12x	M2000.25NR.2RED
1/4 Ltr. 12x	M2000.25NR.3GREEN
5 Ltr.	M2005.0NR.1BLUE

A	e-Code
5 Ltr.	M2005.0NR.2RED
5 Ltr.	M2005.0NR.3GREEN